PeopleSoft Campus Solutions 9.2: Student Records

September 2024

This software and related documentation are provided under a license agreement containing restrictions on use and disclosure and are protected by intellectual property laws. Except as expressly permitted in your license agreement or allowed by law, you may not use, copy, reproduce, translate, broadcast, modify, license, transmit, distribute, exhibit, perform, publish, or display any part, in any form, or by any means. Reverse engineering, disassembly, or decompilation of this software, unless required by law for interoperability, is prohibited.

The information contained herein is subject to change without notice and is not warranted to be error-free. If you find any errors, please report them to us in writing.

If this is software, software documentation, data (as defined in the Federal Acquisition Regulation), or related documentation that is delivered to the U.S. Government or anyone licensing it on behalf of the U.S. Government, then the following notice is applicable:

U.S. GOVERNMENT END USERS: Oracle programs (including any operating system, integrated software, any programs embedded, installed, or activated on delivered hardware, and modifications of such programs) and Oracle computer documentation or other Oracle data delivered to or accessed by U.S. Government end users are "commercial computer software," "commercial computer software documentation," or "limited rights data" pursuant to the applicable Federal Acquisition Regulation and agency-specific supplemental regulations. As such, the use, reproduction, duplication, release, display, disclosure, modification, preparation of derivative works, and/or adaptation of i) Oracle programs (including any operating system, integrated software, any programs embedded, installed, or activated on delivered hardware, and modifications of such programs), ii) Oracle computer documentation and/or iii) other Oracle data, is subject to the rights and limitations specified in the license contained in the applicable contract. The terms governing the U.S. Government's use of Oracle cloud services are defined by the applicable contract for such services. No other rights are granted to the U.S. Government.

This software or hardware is developed for general use in a variety of information management applications. It is not developed or intended for use in any inherently dangerous applications, including applications that may create a risk of personal injury. If you use this software or hardware in dangerous applications, then you shall be responsible to take all appropriate fail-safe, backup, redundancy, and other measures to ensure its safe use. Oracle Corporation and its affiliates disclaim any liability for any damages caused by use of this software or hardware in dangerous applications.

Oracle®, Java, MySQL, and NetSuite are registered trademarks of Oracle and/or its affiliates. Other names may be trademarks of their respective owners.

Intel and Intel Inside are trademarks or registered trademarks of Intel Corporation. All SPARC trademarks are used under license and are trademarks or registered trademarks of SPARC International, Inc. AMD, Epyc, and the AMD logo are trademarks or registered trademarks of Advanced Micro Devices. UNIX is a registered trademark of The Open Group.

This software or hardware and documentation may provide access to or information about content, products, and services from third parties. Oracle Corporation and its affiliates are not responsible for and expressly disclaim all warranties of any kind with respect to third-party content, products, and services unless otherwise set forth in an applicable agreement between you and Oracle. Oracle Corporation and its affiliates will not be responsible for any loss, costs, or damages incurred due to your access to or use of third-party content, products, or services, except as set forth in an applicable agreement between you and Oracle.

Documentation Accessibility

For information about Oracle's commitment to accessibility, visit the Oracle Accessibility Program website at <https://docs.oracle.com/pls/topic/lookup?ctx=acc&id=docacc>.

Access to Oracle Support

Oracle customers that have purchased support have access to electronic support through My Oracle Support. For information, visit <https://docs.oracle.com/pls/topic/lookup?ctx=acc&id=info> or visit <https://docs.oracle.com/pls/topic/lookup?ctx=acc&id=trs> if you are hearing impaired.

Contents

- Preface: Preface..... liii**
 - Understanding the PeopleSoft Online Help and PeopleBooks..... liii
 - Hosted PeopleSoft Online Help..... liii
 - Locally Installed PeopleSoft Online Help..... liii
 - Downloadable PeopleBook PDF Files..... liii
 - Common Help Documentation..... liii
 - Field and Control Definitions..... liv
 - Typographical Conventions..... liv
 - ISO Country and Currency Codes..... lv
 - Region and Industry Identifiers..... lv
 - Translations and Embedded Help..... lvi
 - Using and Managing the PeopleSoft Online Help..... lvi
 - PeopleSoft CS Related Links..... lvi
 - Contact Us..... lvi
 - Follow Us..... lvi
- Chapter 1: Getting Started with Student Records.....59**
 - Student Records Overview..... 59
 - Student Records Business Processes..... 59
 - Student Records Integrations..... 61
 - Student Records Implementation..... 61
 - Additional Information for Getting Started with Student Records..... 62
- Chapter 2: Defining Student Records Installation Settings..... 63**
 - Reviewing or Defining Student Records Installation Settings..... 63
 - Pages Used to Review or Define Student Records Installation Settings..... 63
 - Reviewing or Defining Default Installation Settings..... 63
 - Reviewing or Defining Enrollment Requirement Roster Default Installation Settings..... 69
 - Reviewing or Defining Enrollment Requirement Processing Default Installation Settings..... 74
- Chapter 3: Preparing for the Course Catalog and Schedule of Classes..... 81**
 - Setting Up Catalog and Schedule Options..... 81
 - Pages Used to Set Up Catalog and Schedule Options..... 81
 - Defining Class Notes..... 82
 - Defining Global Notes..... 83
 - Defining Course Attributes..... 83
 - Defining When a Course is Typically Offered..... 85
 - Defining Exam Codes..... 86
 - Defining Course Material Types..... 87
 - Defining Course Material Type Order..... 87
 - Defining Buildings, Rooms, and Classroom Facilities..... 88
 - Pages Used to Define Buildings, Rooms, and Classroom Facilities..... 89
 - Defining Buildings..... 89
 - Defining Room Characteristics..... 90
 - Defining Facilities and Rooms..... 90
 - Defining Facility Components..... 93
 - Defining Facility Characteristics..... 93
 - Designating Approved Instructors and Advisors..... 95
 - Pages Used to Designate Approved Instructors and Advisors..... 95

Assigning Faculty Rank and Advisor Status.....	95
Designating Approved Course Instructors.....	97
Defining Requirement Designations.....	98
Understanding Requirement Designations.....	99
Page Used to Define Requirement Designations.....	100
Defining Requirement Designations.....	100
Setting Up Unit Conversions.....	102
Understanding Unit Conversions.....	103
Prerequisites.....	103
Page Used to Set Up Unit Conversions.....	103
Setting Up Unit Conversion Rules within Your Institution.....	103
Defining Standard Meeting Patterns.....	104
Defining Modes of Instruction.....	104
Page Used to Define Modes of Instruction.....	104
Defining Instruction Modes.....	104
Setting Up Class Search Profiles.....	105
Pages Used to Set Up Class Search Profiles.....	106
Defining Class Search Criteria.....	106
Defining Class Search Result Options.....	109
Defining Class Detail Options.....	112
Chapter 4: Setting Up Repeat Checking.....	115
Understanding Repeat Checking Functionality.....	115
Defining Repeat Schemes and Repeat Codes.....	118
Page Used to Define Repeat Schemes and Repeat Codes.....	118
Creating Repeat Schemes and Codes.....	118
Defining Repeat Rules.....	121
Pages Used to Define Repeat Rules.....	122
Describing Repeat Rules.....	123
Defining Conditions for Repeat Rules.....	124
Defining the Criteria and Order That are Used to Determine a Match When Three or More Repeat Candidates are Processed.....	126
Defining Repeat Rule Sequences.....	128
Defining Conditions for Repeat Rule Sequences.....	130
Designating Process Actions for Repeat Rule Sequences.....	131
Example of a Repeat Rule.....	136
Setting Up Repeat Checking for Academic Institutions.....	142
Page Used to Set Up Repeat Checking for Academic Institutions.....	142
Setting Repeat Checking Controls for Academic Institutions.....	142
Setting Up Repeat Checking for Academic Careers.....	147
Page Used to Set Up Repeat Checking for Academic Careers.....	147
Setting Repeat Checking Controls for Academic Careers.....	147
Setting Up Repeat Checking for Academic Programs.....	152
Page Used to Set Up Repeat Checking for Academic Programs.....	152
Setting Repeat Checking Controls for Academic Programs.....	153
Chapter 5: Setting Up the Course Catalog.....	155
Understanding the Course Catalog.....	155
Prerequisites for Setting Up the Course Catalog.....	155
Creating Course Offerings.....	156
Understanding Course Offerings.....	156
Prerequisites.....	156
Pages Used to Create Course Offerings.....	157

Defining Course Catalog Data.....	158
Defining Course Offerings.....	169
Defining Course Components.....	180
(NZL) Setting Up Government Reporting Data.....	189
Linking Milestones to Course Data.....	191
Interfacing Course Offerings with the General Ledger.....	192
Creating Course Equivalency Groups.....	192
Page Used to Create Course Equivalency Groups.....	193
Creating a Course Equivalency.....	193
Viewing Course Catalog Summary Information.....	194
Page Used to View Course Catalog Summary Information.....	195
Reviewing Course Catalog Summaries.....	195
Printing the Course Catalog.....	195
Page Used to Print the Course Catalog Report.....	195
Entering Course Catalog Report Parameters.....	196
Searching for Courses.....	197
Pages Used to Search for Courses.....	197
Browsing the Course Catalog.....	198
Selecting a Course Offering.....	199
Viewing Course Catalog Details.....	199
Chapter 6: Setting Up Enrollment Requisites.....	203
Understanding Enrollment Requisite Setup and Maintenance.....	203
Prerequisites.....	203
Defining Requisite Program Statuses.....	204
Page Used to Define Requisite Program Statuses.....	204
Defining Requisite Program Statuses.....	204
Defining Tests for Use in Requisites.....	204
Page Used to Define Tests for Use in Requisites.....	205
Defining Tests for Requisites.....	205
Defining Student Groups for Use in Requisites.....	207
Page Used to Define Requisite Student Groups.....	208
Defining Requisite Student Groups.....	208
Defining Requisite Conditions (Optional).....	209
Understanding Requisite Conditions.....	209
Page Used to Define Requisite Conditions.....	209
Defining Requisite Conditions.....	210
Defining Entity Groups for Use in Requisites (Optional).....	218
Page Used to Define Enrollment Requisite Entity Groups.....	219
Defining Requisite Entity Groups.....	219
Defining Enrollment Requirement Groups.....	220
Understanding Enrollment Requirement Group Setup.....	220
Pages Used to Define Enrollment Requirement Groups.....	221
Defining Enrollment Requirement Groups.....	222
Defining Overall Requisite Parameters.....	223
Defining Requisite Details.....	225
Defining Requisite Detail Level Parameters.....	232
Examples of Enrollment Requirement Groups.....	235
Defining Enrollment Requirements.....	243
Understanding Enrollment Requirements.....	244
Pages Used to Define Enrollment Requirements.....	244
Defining Enrollment Requirements.....	245

Defining Overall Enrollment Requirement Parameters.....	247
Defining Enrollment Requirement Line Types.....	248
Defining Line Item Parameters.....	249
Defining Line Item Course Detail.....	251
Defining Enrollment Course Lists.....	252
Understanding Enrollment Course Lists.....	253
Pages Used to Create Enrollment Course Lists.....	253
Creating Course List Descriptions.....	254
Linking Courses to the Course List.....	255
Defining Details of Courses in the Course List.....	257
Viewing Enrollment Requisite Summary Information.....	259
Pages Used to View Enrollment Requisite Summary Information.....	259
Generating a Reverse Engineering Report.....	260
Understanding the Reverse Engineering Report.....	260
Page Used to Generate a Reverse Engineering Report.....	261
Generating the Enrollment Requirement Group Report.....	261
Understanding the Requirement Group Report.....	261
Page Used to Generate the Requirement Group Report.....	262
Generating the Requirement Group Report.....	262
Generating the Requirement Report.....	264
Understanding the Requirement Report.....	264
Page Used to Generate the Requirement Report.....	265
Generating the Requirement Report.....	265
Generating the Entity Group Table and Condition Table Reports.....	265
Page Used to Generate the Entity Group Table and Condition Table Reports.....	266
Processing the Entity Group Table and Condition Table Reports.....	266
Chapter 7: Setting Up Program Enrollment.....	267
Understanding Program Enrollment.....	267
Setting Up Academic Item Types.....	270
Pages Used to Set Up Academic Item Types.....	270
Defining Academic Item Types.....	271
Defining Academic Item Type Attributes.....	273
Using Delivered Academic Item Types.....	280
Identifying Child Item Types and Syncing Entities.....	288
Page Used to Identify Child Items and Sync Entities.....	288
Using the Item Type Matrix.....	288
Setting Up Rules for Program Enrollment.....	293
Page Used to Set Up Rules for Program Enrollment.....	293
Setting Up Rule Types for Program Enrollment.....	293
Associating Rule Types with Execution Events.....	297
Setting Up Program Formats.....	302
Understanding Program Formats.....	302
Page Used to Set Up Program Formats.....	302
Defining Program Formats.....	303
Setting Up AIR Administrator Security.....	307
Page Used to Set Up AIR Administrator Security.....	308
Setting Up AIR Administrator Security.....	308
Setting Up Enrollment Cohorts.....	309
Understanding Enrollment Cohorts.....	309
Page Used to Set Up Enrollment Cohorts.....	309
Defining Enrollment Cohorts.....	309

Setting Up Enrollment Categories for Program Requirements.....	312
Understanding Enrollment Categories.....	312
Page Used to Set Up Enrollment Categories for Program Requirements.....	313
Defining Enrollment Categories.....	313
Setting Up Result Types.....	314
Page Used to Set Up Result Types.....	314
Defining Result Types.....	314
Setting Up Academic Item Registry Entries, Item Details, and Item Security.....	319
Understanding AIR Entries.....	319
Pages Used to Set Up Academic Item Registry Entries, Item Details, and Item Security.....	320
Accessing the Academic Item Registry Component - AIR Search.....	321
Defining AIR Entries.....	326
Using Item Attributes to Extend AIR Data Elements.....	331
Using Item Attributes in AIR.....	333
Assigning Item Attributes to Child Academic Items.....	335
Defining Academic Item Details.....	338
Assigning Rules and Result Types to Academic Items.....	345
Maintaining AIR Rich Text Fields.....	347
Defining Academic Item Security.....	349
Managing Special Edits in AIR for COURSE, COURSEGROUP, and COURSELIST Academic Items.....	350
Using the Academic Item Registry Copy Function.....	350
Creating Academic Items for Courses.....	351
Pages Used to Create Academic Items for Courses.....	351
Creating Academic Items for an Individual Course.....	352
Viewing Academic Item Details for Courses.....	353
Creating Academic Items for Multiple Courses.....	354
Building Programs by Format.....	357
Understanding How to Build Programs by Format.....	358
Page Used to Build Programs by Format.....	358
Using the Build Program by Format Component in Add Mode.....	359
Using the Build Program by Format Component in Update/Display Mode.....	365
Generating and Viewing Program Templates.....	366
Understanding Program Templates.....	367
Pages Used to Generate and View Program Templates.....	367
Generating and Viewing an AIR Based Program Template.....	367
Viewing the Template – Long Page.....	369
Setting Up Course Groups.....	370
Understanding Course Groups.....	371
Pages Used to Set Up Course Groups.....	371
Defining Course Groups.....	371
Defining Course Group Details.....	373
Viewing Test Output.....	375
Defining Filters.....	376
Copying Course Groups.....	378
Setting Up for the Academic Progress Tracker.....	380
Pages Used to Set Up for the Academic Progress Tracker.....	380
Enabling Program Enrollment.....	380
Mapping Campus Solutions Academic Programs, Plans and SubPlans to AIR Based Programs of Study.....	380
Setting Up APT Action Security.....	382

Page Used to Set Up APT Action Security.....	383
Defining Security for APT Actions.....	383
Setting Up APT Reason Codes.....	384
Page Used to Set Up APT Reason Codes.....	384
Defining APT Reason Codes.....	384
Using the Common Attribute Framework to Extend Class Associations for Program Enrollment.....	385
Setting Up Common Attribute Framework to Extend Class Associations for Program Enrollment.....	386
Chapter 8: Setting Up Instructor Workload.....	393
Understanding Instructor Workload.....	393
Course Component Workload Hours Formula.....	393
Instructor Assignment Percentage Formulas.....	395
Prerequisite for Setting Up Instructor Workload.....	398
Implementing Instructor Workload Setup Tables.....	399
Pages Used to Implement Instructor Workload Setup Tables.....	399
Creating Assignment Types.....	400
Creating Instructor Assignment Classes.....	403
Defining Instructor Workload Preferences for Your Institution.....	405
Defining Subject and Component Multipliers.....	409
Linking Workload Hours to Courses.....	410
Linking Workload Hours to Class Components.....	411
Chapter 9: Setting Up Transfer Credit Processing.....	413
Understanding the Transfer Credit Business Process.....	413
Prerequisites.....	413
Transfer Credit Business Process.....	413
Defining External Organizations.....	414
Setting Up External Subjects.....	414
Setting Up External School Subjects.....	414
Page Used to Set Up External School Subjects.....	415
Linking External Subjects to External Organizations.....	415
Entering External Courses.....	415
Page Used to Enter External Courses.....	416
Recording External Courses.....	416
Setting Up External Terms.....	417
Setting Up Test and Component Information.....	417
Setting Transcript and Statistics Defaults.....	418
Making Overall Statistics Adjustments.....	418
Defining Study Agreements.....	419
Page Used to Define Study Agreements.....	419
Creating Course Transfer Equivalency Rules.....	419
Understanding Course Transfer Equivalency Rules.....	419
Pages Used to Create Course Transfer Equivalency Rules.....	422
Defining Component Subject Areas.....	422
Defining Subject Area Elements.....	425
Reviewing and Adjusting Incoming Course Information.....	434
Defining Course Transfer Rules.....	436
Reviewing Examples of Course Equivalencies.....	437
Example of a Many-to-One Course Equivalency.....	437
Example of a Many-to-Many Course Equivalency.....	438
Example of a Course Rejection Equivalency.....	438

Example of Multiple Equivalencies for the Same Course.....	439
Example of an Excess Credit Course Equivalency.....	441
Converting Existing Transfer Components into Component Subject Areas.....	442
Copying Transfer Components Between Component Subject Areas.....	443
Page Used to Copy Transfer Components Between Component Subject Areas.....	443
Copying Transfer Components Between Component Subject Areas.....	443
Defining Course Equivalencies for Academic Programs and Plans.....	447
Understanding Course Equivalencies for Academic Programs and Plans.....	448
Pages Used to Define Course Equivalencies for Academic Programs and Plans.....	448
Setting Up Basic Academic Program/Plan Data.....	449
Setting Equivalency Rules.....	450
Creating Test Transfer Equivalency Rules.....	453
Page Used to Create Test Transfer Equivalency Rules.....	453
Defining Test Transfer Equivalency Rules.....	453
Defining Test Equivalencies for Academic Programs and Plans.....	455
Page Used to Define Test Equivalencies for Academic Programs and Plans.....	456
Setting Test Equivalencies for Academic Programs and Plans.....	456
Chapter 10: Setting Up Attendance Tracking.....	459
Prerequisites for Setting Up Attendance Tracking.....	459
Setting Up Attendance Tracking Data.....	459
Pages Used to Set Up Attendance Tracking.....	459
Defining Attendance Type Translate Values.....	460
Selecting a Default Class Meeting Attendance Type.....	460
Defining Attendance Tracking Options for Course Components.....	460
Indicating Attendance Roster Generation for a Class.....	460
Chapter 11: Preparing to Track Student Data.....	463
Common Elements Used in Preparing to Track Student Data.....	463
Setting Up Academic Standing.....	463
Pages Used to Set Up Academic Standing.....	464
Defining Academic Standing Action Codes.....	464
Creating Academic Standing Rules.....	466
Linking Academic Standing, Honors, and Awards Rules to Academic Programs.....	472
Setting Up Honors and Awards.....	475
Pages Used to Set Up Honors and Awards.....	476
Defining Honor/Award Codes.....	476
Creating Honor Award Rules.....	477
Setting Up Special Grade Point Averages.....	479
Page Used to Set Up Special Grade Point Averages.....	480
Reviewing Committees and Committee Members.....	480
Setting Up Milestones.....	480
Pages Used to Set Up Milestones.....	481
Defining Milestone Codes.....	481
Creating Milestone Templates.....	484
Setting Up Extracurricular Activities.....	486
Page Used to Set Up Extracurricular Activities.....	486
Setting up Extracurricular Activity Codes.....	486
Managing Student Groups.....	487
Page Used to Manage Student Groups.....	487
Setting Up Student Attributes.....	487
Understanding Student Attributes.....	488
Pages Used to Set Up Student Attributes.....	488

Defining Student Attribute Codes.....	489
Defining Student Attribute Values.....	489
Chapter 12: Setting Up Grading.....	491
Understanding Grade Preparation.....	491
Setting Up Your System for Grading.....	491
Understanding Grading Setup.....	492
Pages Used to Set Up Your System for Grading.....	492
Defining Grading Schemes.....	493
Defining Grading Basis Exception Rules.....	500
Running the Grade Basis Exception Report.....	505
Creating Grade Rosters for a Single Class.....	505
Creating Grade Rosters for Multiple Classes.....	506
Chapter 13: Setting Up Degrees and Honors.....	509
Setting Up Degrees and Degree Honors.....	509
Pages Used to Set Up Degrees and Honors.....	509
Defining Degrees.....	510
Attaching Degrees to Academic Plans.....	512
Defining Degree Honors.....	512
Chapter 14: Setting Up Transcripts.....	515
Understanding Transcript Levels.....	515
Defining Transcript Type Security.....	516
Creating Transcript Notes.....	516
Page Used to Create Transcript Notes.....	517
Defining Transcript Notes.....	517
Creating Transcript Text.....	518
Page Used to Create Transcript Text.....	518
Defining Transcript Text.....	518
Reviewing Transcript Print Areas.....	522
Page Used to Review Transcript Print Areas.....	522
Reviewing the Transcript Print Area Table.....	522
Defining Transcript Types.....	523
Prerequisites.....	524
Pages Used to Define Transcript Types.....	524
Defining Transcript Type Basic Data.....	525
Linking Academic Careers to Transcript Types.....	529
Designating Student and Institutional Information.....	531
Designating Degree and Program Data.....	534
Designating Enrollment and Statistics Data.....	538
Designating Transfer/Test/Other Data.....	542
Designating Transcript Type Test Scores.....	547
Designating Special GPA Information.....	548
Defining Data Sorting Order.....	549
Setting up Transcript Fees.....	550
Setting Up Delivery Methods.....	553
Pages Used to Set Up Delivery Methods.....	554
Defining Delivery Methods and Fees.....	554
Setting Up Electronic Transcript Processing.....	555
Pages Used to Set Up Electronic Transcript Processing.....	555
Defining TS130 and TS131 Controls.....	556
Defining Reporting Codes and Email Information.....	558
Defining TS130 Contacts.....	560

Setting Up Data Maps for TS130 Outbound Processing.....	560
Chapter 15: Setting Up Activity Management.....	563
Prerequisites for Setting Up Activity Management.....	563
Setting Up an Activity Management Framework.....	563
Pages Used to Set Up an Activity Management Framework.....	564
Defining Content Categories.....	566
Defining Content Devices.....	566
Defining Exam Types.....	566
Defining Forms of Identification.....	566
Defining a Result Scale.....	567
Defining Content Messages.....	573
Defining Academic Periods.....	574
Defining Extenuating Circumstances.....	577
Defining Inclusion Types.....	579
Reviewing Date Sources.....	580
Defining Date Settings.....	581
Defining Action Dates.....	583
Defining Result Dates.....	585
Setting Up an Activity Definition.....	590
Understanding Activity Definition Setup.....	590
Pages Used to Set Up an Activity Definition.....	590
Defining Activity Definitions.....	591
Reviewing Content Inclusions.....	599
Setting Up the Activity Registry.....	600
Understanding the Activity Registry.....	600
Pages Used to Set Up the Activity Registry.....	600
Defining a Registry Header.....	602
Reviewing Self-Service Message Controls.....	607
Defining Copy Content.....	607
Defining Registry Details.....	608
Defining Content Notes.....	627
Establishing Common Attributes.....	628
Reviewing Coursework Item Dates.....	629
Defining Staff Instructions.....	630
Reviewing the Content Tree.....	630
Setting Up Anonymous Grading.....	631
Pages Used to Set Up Anonymous Grading.....	632
Configuring Access to Anonymous IDs.....	633
Validating Anonymous IDs.....	634
Setting Up Activity Management Throughout Campus Solutions.....	634
Define Various Activity Management Installation Options.....	635
Enabling Activity Management and Setting Up Activity Management Defaults.....	635
Setting Up EOCs.....	635
Chapter 16: Setting Up Research Tracking.....	637
Setting Up Research Tracking.....	637
Pages Used to Set Up Research Tracking.....	637
Setting Up Student Administration Options.....	638
Setting Up Research Tracking Options for Academic Programs.....	638
Setting Up Research Tracking Options for Academic Plans.....	642
Setting Up Research Status Codes.....	643
Setting Up Demographic Data Usage.....	646

Setting Up Consumption Load.....	647
Setting Up Consumption Actions for Program Actions.....	647
Using Common Attribute Framework for Research Tracking.....	649
Setting Up Research Topics.....	650
Pages Used to Define Research Topics.....	650
Defining Research Topic Categories.....	652
Defining Research Topics.....	652
Reviewing Available Research Supervisors.....	655
Associating Organizations and Contacts with Research Topics.....	655
Entering Additional Information.....	658
Entering Attachments.....	659
Setting Up Self-Service Research Topic Search.....	659
Setting Up Research Administrators.....	661
Pages Used to Set Up Research Administrators.....	662
Defining Administrators.....	663
Defining and Managing Administrator Profiles.....	663
Defining Supervisor Roles.....	666
Defining Additional Business Assignments.....	667
Setting Up Research Service Requests.....	669
Understanding Research Service Requests.....	670
Pages Used to Set Up Research Service Requests.....	671
Using the Notifications Framework for Service Request Notifications.....	671
Using the Notifications Framework for Service Item Notifications.....	675
Setting Up Research Service Request Categories.....	676
Setting Up Research Service Request Types.....	677
Setting Up Self-Service Research Service Requests.....	680
Setting Up Service Request Assignments.....	681
Setting Up Candidate Center.....	683
Pages Used to Set Up Candidate Center.....	683
Setting Up the My Research Projects Region.....	684
Configuring a Status Detail Page.....	685
Setting Up the My Service Items Region.....	690
Configuring a Service Item.....	691
Setting Up the Service Item Fields.....	696
Setting Up Rules for Online Edits.....	701
Pages Used to Set Up Rules for Research Tracking.....	702
Setting Up Rule Types.....	702
Associating Rule Types with Execution Events.....	705
Setting Up Online Notifications.....	707
Setting Up Integration Broker For Research Administrator Profile Affiliations.....	714
Integration Broker Setup for Research Administrator Profile Affiliations.....	715
Chapter 17: Setting Up Student Academic Projects.....	725
Understanding Student Academic Projects.....	725
Setting Up Academic Project Types.....	725
Page Used to Set Up Academic Project Types.....	725
Defining Academic Project Types.....	725
Setting Up Process Status Codes.....	726
Using Common Attribute Framework for Student Academic Projects.....	726
Setting Up Demographic Data Usage.....	728
Defining Student Academic Project Topic Categories.....	728
Setting Up Academic Project Topics.....	728

Page Used to Set Up Academic Project Topics.....	728
Defining Academic Project Topics.....	729
Reviewing Available Academic Project Supervisors.....	729
Associating Organizations and Contacts with Academic Project Topics.....	730
Entering Additional Information.....	730
Entering Attachments.....	730
Setting Up Project Supervisors.....	730
Defining Administrators.....	730
Setting Up Integration Broker For Profile Affiliations.....	731
Defining and Managing Administrator Profiles.....	731
Defining Supervisor Roles.....	731
Defining Additional Business Assignments.....	731
Defining Online Edits Using the Rules Engine.....	731
Setting Up Online Notifications for Student Projects.....	732
Setting Up Evaluation Management for Student Projects.....	732
Chapter 18: Preparing to Consolidate and Report Academic Statistics.....	733
Prerequisites for Preparing to Consolidate and Report Academic Statistics.....	733
Setting Up Academic Institutions for Reporting.....	733
Setting Up Academic Careers and Academic Programs for Reporting.....	734
Setting Up Academic Level and Load Rules for Reporting.....	734
Setting Up Student Attributes for Reporting.....	735
Setting Up Extracurricular Activities for Reporting.....	735
Setting Up Branch Codes for NSC Reporting.....	735
Page Used to Set Up NSC Branch Codes.....	735
Defining NSC Branch Codes for Reporting.....	735
Setting Up Statistic Period Types.....	737
Page Used to Set Up Statistic Period Types.....	737
Defining Statistics Period Types.....	737
Setting Up Academic Statistics Periods.....	739
Understanding Academic Statistics Periods.....	740
Page Used to Set Up Academic Statistics Periods.....	741
Defining Academic Statistics Periods.....	741
Setting Up For NSC Program Level Reporting.....	747
Chapter 19: (AUS) Setting Up Government Reporting.....	749
Understanding Australian Government TCSI Reporting.....	749
Prerequisites.....	749
The Government Departments That Require Higher Education Reporting.....	749
Connecting to the TCSI System.....	750
Pages Used to Connect to the TCSI System.....	750
Configuring Campus Solutions to Connect to TCSI.....	751
Providing Device Registration Details.....	751
Testing Your Connection.....	753
Testing Your Connection to the Errors API.....	753
Configuring the Integration Broker for TCSI/PRODA Endpoints.....	753
Setting Up TCSI Reporting Codes.....	757
Understanding TCSI Reporting Codes.....	758
Pages Used to Set Up TCSI Reporting Codes.....	758
Setting Up Institution Codes.....	761
Setting Up TCSI Country Codes.....	762
Mapping Country Codes to TCSI Country Codes.....	762
Setting Up TCSI Language Codes.....	763

Mapping Language Codes to TCSI Language Codes.....	764
Setting Up TCSI Citizenship and Residency Codes.....	764
Setting Up TCSI Citizenship and Residency Mapping.....	765
Setting Up TCSI Processing.....	765
Setting Up Level of Education Codes.....	767
Setting Up Program on Campus.....	767
Identifying CS Locations for TCSI.....	769
Map Types of Impairment With Disability Codes.....	769
Map Program Actions and Reasons to Program Completion Codes.....	770
Setting Up for Collecting Applications and Offers Data.....	770
Understanding Applications and Offers Data Collection.....	771
Pages Used to Set Up Applications and Offers Profile Parameters.....	771
Setting Up an Applications and Offers Profile.....	773
Setting Up Applications and Offers Element Mapping.....	774
Setting Up Applications and Offers Element Defaults.....	778
Setting Up Funding Source Codes.....	779
Setting up Element 702 Mapping.....	780
Setting Up HECS Liability in Student Records.....	781
Understanding HECS Liability in Student Records.....	781
Pages Used to Set Up HECS Liability.....	782
Defining Cohort Years.....	782
Setting Up HECS Band IDs.....	783
Mapping Liability Status Codes.....	784
Mapping Work Experience to HECS Liability Codes.....	784
Setting Up Aggregated EFTSL Values.....	786
Chapter 20: (CAN) Setting Up Government Reporting.....	789
Understanding the Canadian Government Reporting Process.....	789
Defining Canadian Reporting Business Units.....	791
Pages Used to Define Canadian Business Units.....	791
Defining Canadian Reporting Business Unit Descriptions.....	791
Defining Canadian Reporting Business Unit Defaults.....	792
Defining Canadian Reporting Business Unit Career Usage Values.....	793
Reviewing Delivered Report Types and Element Numbers.....	794
Pages Used to Review Delivered Codes.....	794
Reviewing Delivered Government Report Types.....	794
Reviewing Delivered Government Elements.....	795
Defining Element Classifications.....	795
Page Used to Define Element Classification Types.....	795
Defining Element Classification Types.....	795
Defining Report Periods.....	796
Page Used to Define Report Periods.....	797
Defining Report Periods.....	797
Reviewing Delivered Government Element Codes.....	799
Pages Used to Review Delivered Government Element Codes.....	799
Reviewing Delivered County and Country Codes.....	800
Pages Used to Review Delivered County and Country Codes.....	800
Reviewing Delivered Language, School, and CIS Language Codes.....	800
Pages Used to Review Delivered Language, School, and CIS Language Codes.....	801
Defining Provincial Codes.....	801
Pages Used to Define Provincial Codes.....	802
Defining Program Funding Approval Codes.....	803

Defining Provincial Course Funding Codes..... 803

Defining Provincial Citizen Funding Codes..... 803

Defining Provincial Major Field of Study Codes..... 803

Defining Provincial Program Codes..... 804

Defining Provincial Program Funding Codes..... 804

Defining Provincial Special Initiative Codes..... 804

Defining General Mapping Tables..... 805

Pages Used to Define General Mapping Tables..... 805

Defining Mapping Language Codes..... 806

Reviewing Delivered Province Codes..... 807

Mapping Canadian Reporting Sequence..... 807

Mapping Terms and Sessions to Reporting Periods..... 808

Reviewing Delivered OUAC Application Numbers..... 809

Defining the Classification Mapping Table..... 809

Defining the Direct Mapping Table..... 810

Defining the Master Mapping Table..... 811

Defining the Separate Mapping Table..... 811

Defining School Reporting Classifications..... 812

Prerequisites..... 812

Page Used to Define School Reporting Classifications..... 812

Defining Address and Phone Usage Values for Canadian Government Reporting..... 813

Pages Used to Define Address and Phone Usage Table Entries for Canadian Government Reporting..... 813

Defining Address Usage Values..... 813

Defining Email Address Usage Values..... 814

Defining Phone Usage Values..... 814

Mapping Program Values for PSIS, USISE, MET, and OUAC..... 814

Pages Used to Define PSIS, USISE, MET, and OUAC Program Mapping Values..... 815

Defining PSIS Program Mapping 1 Values..... 815

Defining PSIS Program Mapping 2 Values..... 817

Defining PSIS Program Mapping 3 Values..... 818

Defining PSIS Program Mapping 4 Values..... 820

Defining USISE Program Mapping Values..... 821

Defining MET and OUAC Program Mapping Values..... 822

Mapping Plan Values for PSIS, USISE, MET, and OUAC..... 823

Pages Used to Map PSIS, USISE, MET, and OUAC Plan Values..... 824

Defining PSIS Plan Mapping 1 Values..... 824

Defining PSIS Plan Mapping 2 Values..... 826

Defining PSIS Plan Mapping 3 Values..... 827

Defining PSIS Plan Mapping 4 Values..... 829

Defining USISE Plan Mapping Values..... 830

Defining MET/OUAC Plan Mapping Values..... 831

Defining CIS Program, Plan, and Subplan Tables..... 832

Pages Used to Define CIS Program, Plan and Subplan Values..... 833

Defining the CIS Program Table..... 833

Defining the CIS Plan Table..... 833

Defining the CIS Subplan Table..... 834

Defining PSIS Course Data..... 834

Page Used to Define PSIS Course Data..... 834

Defining PSIS Course Data..... 834

Mapping Canadian School Codes to External Organizations..... 835

Page Used to Map Canadian School Codes to External Organizations.....	835
Mapping Canadian School Codes to External Organizations.....	835
Defining PSIS Student Data.....	836
Pages Used to Define PSIS Data for Students.....	836
Defining PSIS Student Program Data.....	837
Defining PSIS Student Enrollment Data.....	838
Loading the Student ID Table.....	840
Page Used to Load the Student ID Table.....	841
Loading Student Data.....	841
Chapter 21: (NZL) Setting Up Government Reporting.....	845
Understanding New Zealand Government Reporting.....	845
Prerequisites.....	846
Preparing for SDR Reporting.....	847
Pages Used to Prepare for SDR Reporting.....	847
Defining Funding Categories.....	848
Defining Course Classifications.....	849
Defining MoE Subject Codes.....	850
Setting Up Field of Study Codes.....	851
Preparing for NZQA Reporting.....	852
Pages Used to Prepare for NZQA Reporting.....	852
Defining NQF Fields, Subfields, and Domains.....	852
Defining Unit Standards.....	853
Linking NQF Codes to Milestones.....	854
Preparing for NZVCC Reporting.....	854
Pages Used to Prepare for NZVCC Reporting.....	855
Entering NZVCC Subject Codes.....	855
Entering NZVCC Qualification Codes.....	855
Chapter 22: (NLD) Managing the BRON-HO Interface.....	857
Understanding BRON-HO.....	857
Chapter 23: (NLD) Setting Up Test Administration.....	859
Understanding Test Administration Setup.....	859
Common Elements Used to Set Up Test Administration.....	859
Activating Test Administration.....	860
Page Used to Activate Test Administration.....	860
Activating Test Administration.....	860
Defining Tests and Calculated Results in the Catalog.....	860
Pages Used to Define Tests and Calculated Results in the Catalog.....	861
Defining Tests.....	861
Defining Test Offerings.....	863
Defining a Test Set for Calculated Results.....	864
Linking a Course to the Test.....	866
Creating Test Trees in Tree Manager.....	867
Pages Used to Create Test Trees.....	867
Creating a Test Tree.....	868
Validating Test Trees.....	868
Linking Test Trees to Programs.....	869
Page Used to Link Test Trees to Programs.....	869
Linking the Test Tree to a Program.....	869
Setting up Default VAVO Combination Grade Courses.....	870
Pages Used to Set Up Default VAVO Combination Grade Courses.....	870
Adding Combination Grade Course Defaults.....	871

Running the Combination Grade Process.....	872
Creating Test Lists.....	872
Pages Used to Create Test Lists.....	872
Creating a Test List.....	872
Adding Tests to a Test List.....	873
Defining Evaluation Rules.....	874
Pages Used to Define Evaluation Rules.....	874
Defining Evaluation Requisites.....	875
Defining Evaluation Rule Details.....	876
Chapter 24: (NLD) Managing Student Higher Education Information.....	883
Tracking Student Higher Education Information.....	883
Pages Used to Manage Student Higher Education Information.....	883
Entering Academic Program Higher Education Information for a Student.....	883
Managing Student Higher Information.....	884
Viewing Higher Education Information for a Student.....	886
Chapter 25: (NLD) Managing Test Administration.....	887
Common Elements Used to Manage Test Administration.....	887
Creating Test Sessions.....	887
Pages Used to Create Test Sessions.....	888
Selecting Test Session Criteria.....	888
Inserting Test Sessions and Students.....	890
Maintaining Test Sessions.....	892
Pages Used to Maintain Test Sessions.....	893
Maintaining Test Session Details.....	893
Enrolling Additional Students.....	894
Entering Grades.....	895
Entering Grade Comments.....	896
Maintaining Test Sessions by Session.....	897
Pages Used to Maintain Test Sessions by Session.....	897
Enrolling Students by Test Session.....	898
Entering Grades.....	898
Entering Comments.....	898
Maintaining Test Sessions by Student.....	898
Pages Used to Maintain Test Sessions by Student.....	898
Maintaining Test Sessions by Student.....	899
Maintaining Session Grades per Student.....	900
Linking Test Trees to Students.....	900
Page Used to Link Test Trees to Students.....	901
Linking Test Trees to Students.....	901
Maintaining VAVO Course Options.....	901
Page Used to Maintain VAVO Course Options.....	901
Maintaining VAVO Course Options.....	902
Calculating Grades and Evaluating Students.....	903
Understanding the Calculation Process.....	903
Pages Used to Calculate Cumulative Grades and Evaluate Students.....	904
Calculating Grades per Student.....	904
Calculating Grades per Program.....	905
Evaluating Results per Student.....	906
Evaluating Results per Program.....	906
Viewing and Adjusting Evaluation Results.....	906
Pages Used to View and Adjust Evaluation Results.....	907

Viewing Additional Details of Student Evaluation Results.....	907
Approving Adjustments.....	907
Adjusting Evaluation Results.....	908
Reporting Evaluation Data.....	908
Page Used to Report Evaluation Data.....	909
Running the Appraisal Report Process.....	909
Loading and Viewing Grade Data in Test Trees.....	909
Pages Used to Load and View Grade Data in Trees.....	910
Loading Grade Data into Test Trees by Student.....	910
Loading Grade Data into Test Trees by Program.....	910
Chapter 26: Performing Repeat Checking.....	911
Understanding the Three Repeat Checking Methods.....	911
Running the Repeat Rule Checking Process in Batch.....	913
Page Used to Run the Repeat Rule Checking Process in Batch.....	913
Running the Repeat Rule Checking Process in Batch.....	913
Chapter 27: Managing the Schedule of Classes.....	917
Understanding the Schedule of Classes.....	917
Scheduling New Classes.....	918
Understanding New Class Scheduling.....	918
Prerequisites.....	919
Pages Used to Schedule a Class.....	919
Defining Basic Data for Class Sections.....	922
Adding Class Association Attributes Using the Schedule of Classes Component.....	930
Entering Class Fee Information.....	931
Defining Class Meeting Patterns.....	932
Defining Auto Enroll Options and Capacity.....	940
Defining Class Reserve Capacity.....	943
Managing Enrollment Capacity.....	946
Linking Class Notes to Sections.....	946
Linking Exam Times to Classes.....	947
Defining LMS Data for Classes.....	949
Defining Textbooks for Classes.....	950
Interfacing Class Sections with the General Ledger.....	953
Modifying Scheduled Classes.....	955
Modifying Scheduled Class Meetings.....	955
Understanding Modifications to Scheduled Class Meetings.....	955
Pages Used to Modify Class Meeting Information.....	956
Updating Meetings Information.....	956
Updating Enrollment Control Information.....	957
Updating Exam Information.....	957
Viewing and Updating Class Sections.....	957
Prerequisite.....	957
Page Used to View and Update Class Sections.....	957
Reviewing Class Sections.....	958
Rolling Data from the Course Catalog to the Schedule of Classes.....	960
Prerequisite.....	961
Page Used to Roll Data from the Course Catalog to the Schedule of Classes.....	961
Running the Course Roll Process.....	961
Defining Class Associations.....	962
Understanding Class Associations.....	962
Using the Common Attribute Framework to Extend Class Associations.....	964

Prerequisite.....	965
Pages Used to Define Class Associations.....	965
Adjusting Units.....	965
Modifying Class Components.....	970
Modifying Requisites.....	974
Defining Class Permissions.....	975
Understanding Class Permissions.....	975
Prerequisites.....	975
Common Elements Used in This Section.....	976
Pages Used to Create Class Permissions.....	976
Creating Add Permissions for Classes.....	977
Creating Drop Permissions for Classes.....	980
Generating Add Permissions for a Subject Area.....	983
Creating Combined Sections.....	984
Understanding Combined Sections.....	985
Pages Used to Create Combined Sections.....	985
Defining a Combined Section ID.....	986
Linking Classes to a Combined Section ID.....	987
Scheduling Examinations.....	989
Understanding Exam Scheduling.....	989
Prerequisites.....	989
Pages Used to Schedule Exams.....	990
Scheduling Exams for Individual Classes.....	990
Running the Exam Scheduling Process.....	990
Troubleshooting the Exam Scheduling Process.....	991
Modifying Course Events.....	991
Prerequisite.....	991
Page Used to Modify Course Events.....	991
Defining Class Events.....	991
Viewing Instructor Schedules.....	992
Page Used to View Instructor Schedules.....	993
Viewing Instructor Schedules.....	993
Viewing Instructor Schedules Through Self-Service Pages.....	993
Viewing Class Facility Usage.....	993
Prerequisites.....	993
Page Used to View Class Facility Usage.....	994
Reviewing Class Facility Usage.....	994
Searching for an Available Facility.....	994
Pages Used to Search for a Facility.....	995
Creating Facility Search Criteria.....	995
Viewing Facility Search Results.....	995
Searching for Classes.....	996
Understanding Class Search.....	996
Pages Used to Search for Classes.....	997
Printing the Schedule of Classes Report.....	997
Pages Used to Print the Schedule of Classes Report.....	997
Setting Schedule of Classes Report Parameters.....	997
Setting Schedule of Classes Report Options.....	999
Copying Classes from One Term to Another.....	999
Prerequisites.....	1000
Pages Used to Copy Classes from Term to Term.....	1000

Defining Criteria for the Prior Term Copy Process.....	1000
Selecting Options for the Prior Term Copy Process.....	1002
Clearing the Resource Queue Table.....	1003
Understanding the Resource Queue Table.....	1003
Page Used to Clear the Resource Queue Table.....	1004
Clearing the Resource Queue Table.....	1004
Chapter 28: Tracking Instructor Workload.....	1005
Viewing and Updating Term Workload Data.....	1005
Prerequisites.....	1005
Pages Used to View and Update Term Workload Data.....	1005
Viewing and Updating Individual Term Workload Data.....	1006
Viewing and Updating Workload Values on the Meetings Page.....	1011
Using the Workload Copy/Update Process.....	1011
Prerequisites.....	1012
Page Used to Report and Update Workload Values.....	1012
Reporting and Updating Workload Values.....	1012
Walking Through Instructor Workload.....	1014
Chapter 29: Managing Student Programs, Plans, and Subplans.....	1027
Understanding Academic Program and Plan Activation.....	1027
Understanding Program Actions and Statuses.....	1027
Understanding Program Actions Where Future Enrollments Exist.....	1030
Understanding Program Actions Where Future Active Terms with No Enrollment Exist.....	1031
Maintaining Student Program Stacks.....	1031
Pages Used to Manage Student Program Stacks.....	1032
Maintaining Student Academic Programs.....	1033
Selecting a Student's Career Requirements Terms.....	1037
Maintaining Student Academic Plans.....	1037
Maintaining Student Academic Subplans.....	1039
Maintaining Student Additional Information.....	1040
(AUS) Entering Australia-Specific Student Program Information.....	1041
(CAN) Entering ESIS Student Program Data.....	1044
Chapter 30: Managing Activities.....	1045
Understanding Activity Management.....	1045
Understanding Results in Activity Management.....	1046
Understanding the Delivered Rules in Activity Management.....	1048
Understanding Resit Eligibility and Calculation.....	1059
Prerequisites for Managing Activities.....	1065
Adding Courses to an Existing Activity Registry.....	1065
Understanding How to Add Courses to an Existing Activity Registry.....	1065
Pages Used to Add Courses to an Existing Activity Registry.....	1066
Associating a Single Course with an Activity Registry.....	1067
Reviewing Associated Courses and Topics.....	1067
Associating Multiple Courses with an Activity Registry.....	1067
Generating Activity IDs for a Course.....	1071
Understanding the Activity Generation Process.....	1071
Pages Used to Generate Activity IDs for a Course.....	1073
Using the Activity Generator.....	1073
Using the Advanced Activity Generator.....	1083
Reviewing Class Sections for a Term.....	1085
Generating Activity IDs for Multiple Courses.....	1094
Page Used to Generate Activity IDs for Multiple Courses.....	1094

Generating Activity IDs Using Batch Activity Generator.....	1094
Generating Anonymous IDs.....	1100
Pages Used to Generate Anonymous IDs.....	1101
Generating Anonymous IDs.....	1101
Generating Anonymous IDs for Exam-Only Courses.....	1102
Managing Course Root Activities.....	1103
Understanding the Activity Manager.....	1104
Pages Used to Manage Course Root Activities.....	1104
Managing Content Tree Activities.....	1105
Redirecting Class or Exam References to Activity IDs.....	1111
Adding Sibling or Child Activities.....	1112
Adding System References.....	1113
Managing Activity Details.....	1114
Establishing Activity Manager Common Attributes.....	1116
Managing Section Activities.....	1116
Understanding the Section Manager.....	1116
Pages Used to Manage Section Activities.....	1117
Managing Activity Sections.....	1117
Managing Section Details.....	1119
Managing Staff Instructions.....	1125
Securing Scheduled Activities.....	1126
Managing Student Activities.....	1126
Understanding IAM Creation in Batch.....	1127
Understanding IAM Block Generation.....	1127
Pages Used to Manage Student Activities.....	1128
Adding an IAM for an Individual Student.....	1129
Reviewing Activity Status.....	1136
Reviewing Activity Detail.....	1137
Establishing IAM Common Attributes for Activity Details.....	1138
Entering Activity Results for an Individual Student.....	1139
Establishing IAM Common Attributes for Activity Results.....	1142
Understanding Reassessment.....	1142
Evaluating Reassessment Eligibility.....	1143
Creating IAMs Automatically.....	1147
Creating IAMs in Batch Using Student Enrollment.....	1147
Creating IAMs in Batch Using APT.....	1149
Generating an IAM Student Block.....	1151
Generating an IAM Activity Block.....	1152
Using the IAM Batch Generator.....	1154
Reviewing IAM Requests.....	1155
Reviewing the IAM Activity Request Log.....	1156
Managing Course Rosters.....	1156
Pages Used to Manage Course Rosters.....	1157
Managing the Roster Summary.....	1158
Managing the Activity Roster.....	1162
Reviewing Activity Roster Student Details.....	1164
Managing the Result Roster.....	1165
Viewing Overall Activity Results.....	1171
Viewing Activity Root Roster Student Details.....	1172
Posting Student Results.....	1174
Calculating the Primary Result in Batch.....	1175

Calculating the Primary Result by Student.....	1177
Chapter 31: Performing Batch Term Activation.....	1179
Understanding Term Activation.....	1179
Prerequisites.....	1179
Term Activation.....	1179
Running Batch Term Activation.....	1180
Understanding Batch Term Activation.....	1180
Pages Used to Run Batch Term Activation.....	1182
Defining Global Exclusions.....	1183
Defining Degree Status Rules.....	1186
Entering Required and High-Level Criteria for Processing.....	1188
Entering Detailed Criteria for Processing.....	1193
Entering Enrollment Lapse Rules for Processing.....	1195
Entering Process Control Options.....	1198
Creating Custom Populations for Processing.....	1204
Chapter 32: Performing Quick Activation.....	1207
Processing a Quick Activation.....	1207
Chapter 33: Creating Student Blocks.....	1209
Understanding Student Blocks.....	1209
Updating Mass Change Operator Security.....	1209
Page Used to Update User Security.....	1210
Updating Operator Security.....	1210
Creating a Student Block Mass Change Definition.....	1211
Understanding Mass Change Definitions.....	1212
Pages Used to Create a Student Block Mass Change Definition.....	1212
Creating Mass Change Definitions.....	1213
Specifying Student Administration Parameters.....	1213
Specifying Student Block Criteria and Defaults.....	1213
Generating Mass Change SQL Text for Student Blocks.....	1216
Viewing Mass Change Execution History.....	1218
Chapter 34: Maintaining Student Career Term Records.....	1219
Prerequisites for Maintaining Student Career Term Records.....	1219
Using the Term Activation Component.....	1219
Pages Used to Maintain Student Career Term Records.....	1219
Maintaining a Student's Career Term Record.....	1221
(AUS) Setting Student Term Default Values.....	1224
(NZL) Maintaining SDR Reporting Data for a Student.....	1226
Maintaining a Student's Term Enrollment Limits.....	1226
Maintaining a Student's Session Data.....	1228
Maintaining a Student's Terms in Residence.....	1229
Maintaining a Student's Term Control Dates.....	1231
Tracking and Maintaining a Student's External Study Agreements.....	1232
Querying for Academic Level Differentials.....	1232
Chapter 35: Managing Enrollment and Validation Appointments.....	1235
Understanding Enrollment and Validation Appointments.....	1235
Setting Up Enrollment and Validation Appointments.....	1236
Understanding Enrollment and Validation Appointment Setup.....	1236
Page Used to Set Up Enrollment and Validation Appointments.....	1237
Defining Enrollment Appointment Limits.....	1237
Creating Student Appointment Blocks.....	1239
Understanding Student Appointment Blocks.....	1239

Pages Used to Create Student Appointment Blocks.....	1239
Defining Student Appointment Blocks.....	1240
Defining Processing Priorities for Student Appointment Blocks.....	1242
Creating Enrollment and Validation Appointments.....	1244
Understanding Enrollment and Validation Appointments.....	1244
Pages Used to Create Enrollment and Validation Appointments.....	1244
Selecting an Appointment Control Session.....	1245
Creating Enrollment Appointment Blocks.....	1246
Creating Validation Appointments.....	1250
Assigning Enrollment and Validation Appointments in Batch.....	1250
Understanding Assigning Appointments in Batch.....	1250
Prerequisites.....	1251
Pages Used to Assign Enrollment and Validation Appointments in Batch.....	1252
Assigning Appointments in Batch.....	1252
Assigning and Maintaining Appointments for Individual Students.....	1255
Pages Used to Assign and Maintain Appointments for Individual Students.....	1256
Assigning and Maintaining Appointments for Individual Students.....	1256
Creating Appointment Communications in Batch.....	1261
Prerequisites.....	1261
Page Used to Create Appointment Communications in Batch.....	1262
Creating Appointment Communications in Batch.....	1262
Viewing Appointments Through Self Service.....	1262
Chapter 36: Processing Class Enrollment Transactions.....	1263
Understanding Class Enrollment Processing.....	1263
Class Enrollment Processing.....	1263
Enrollment Request Processing for Drops.....	1267
Date and Time Stamps on Student Enrollment Records.....	1269
Processing Enrollment Transactions Through the Quick Enrollment Component.....	1270
Understanding Quick Enroll.....	1270
Pages Used to Process Enrollment Transactions Through the Quick Enroll Component.....	1271
Adding or Updating Quick Enrollment Requests.....	1272
Inquiring About Enrollment Request Messages.....	1285
Processing Enrollment Transactions Through the Enrollment Component.....	1286
Pages Used to Process Enrollment Transactions Through the Enrollment Component.....	1287
Entering Class Enrollment Information.....	1289
Viewing Enrollment Transaction Information.....	1292
Adding Transcript Notes and Text.....	1294
Indicating Requirement Designation Options and Independent Study Instructors.....	1296
Viewing Last Enrollment Action Information.....	1296
(AUS) Entering HECS Data.....	1297
(CAN) Entering ESIS Student Data.....	1299
(NZL) Entering Funding Information.....	1299
(NLD) Indicating Student Paper Information.....	1300
Processing Enrollment Transactions Through the Block Enrollment Feature.....	1301
Understanding the Block Enrollment Feature.....	1301
Pages Used to Process Enrollment Transactions Through the Block Enrollment Feature.....	1303
Predefining Student Enrollment Blocks.....	1305
Predefining Class Enrollment Blocks.....	1306
Setting Class Enrollment Block Defaults.....	1308
Merging, Retrieving, and Posting Data for Block Enrollment Requests.....	1308
Creating Custom Student Enrollment Blocks.....	1315

Creating Custom Class Enrollment Blocks.....	1315
Viewing Block Enrollment Request Details.....	1317
Maintaining Detail for a Student's Block Enrollment Request.....	1318
Processing Enrollment Transactions Through the Enrollment Request Component.....	1319
Pages Used to Process Enrollment Transactions Through the Enrollment Request Component.....	1320
Adding or Updating Student Enrollment Request Transactions.....	1320
Adding Transcript Notes to Enrollment Requests.....	1323
Processing Enrollment Transactions Through Self Service.....	1324
Posting Mass Enrollment Requests.....	1324
Page Used to Post Mass Enrollment Requests.....	1324
Posting Enrollment Requests in Mass.....	1324
Chapter 37: Working with Enrollment Request Messages.....	1327
Acting on Enrollment Request Messages.....	1327
Chapter 38: Using Enrollment-Related Processes.....	1345
Creating Historical Enrollment Records.....	1345
Pages Used to Create Historical Enrollment Records.....	1345
Recording Historical Enrollment Records.....	1345
Managing Wait Lists.....	1347
Understanding Wait List Management.....	1347
Pages Used to Manage Wait Lists.....	1349
Viewing a Student's Wait List Position.....	1350
Moving Students from Wait Lists to Enrollment.....	1350
Purging Students From Wait Lists.....	1352
Processing Withdrawals and Cancellations.....	1353
Understanding Withdrawal and Cancellation Processing.....	1353
Common Elements Used to Process Withdrawals and Cancellations.....	1355
Pages Used to Process Withdrawals and Cancellations.....	1357
Posting Withdrawals and Cancellations for Terms.....	1358
Posting Withdrawals and Cancellations for Sessions.....	1360
Resubmitting Failed Withdrawal and Cancellation Requests.....	1360
Viewing Withdrawal and Cancellation Request Status.....	1361
Purging Drop Enrollment Records.....	1361
Page Used to Delete Drop Enrollment Records.....	1362
Deleting Drop Enrollment Records.....	1362
Purging Shopping Cart Records.....	1363
Page Used to Purge Shopping Cart Records.....	1363
Purging Shopping Cart Records.....	1363
Chapter 39: Managing Post Enrollment Requirement Checking.....	1365
Understanding Post Enrollment Requirement Checking Setup.....	1365
Managing the Enrollment Requirement Roster.....	1365
Pages Used to Manage Enrollment Requirement Rosters.....	1366
Using the Enrollment Requirement Roster (Summary) Page.....	1366
Tracking Post Enrollment Requirement Checking Transaction History.....	1377
Running Batch Post Enrollment Requirement Checking.....	1377
Page Used to Run Batch Post Enrollment Requirement Checking for Multiple Classes.....	1378
Running Batch Post Enrollment Requirement Checking for Multiple Classes.....	1378
Printing Batch Enrollment Requirement Rosters.....	1381
Page Used to Print Enrollment Requirement Rosters in Batch.....	1382
Printing Enrollment Requirement Rosters in Batch.....	1382
Processing Batch Drop Requests for Post Enrollment Requirements.....	1384

Page Used to Drop Non-Compliant Students in Batch.....	1385
Dropping Non-Compliant Students in Batch.....	1385
Defining Enrollment Requirement Note Types.....	1388
Page Used to Define Enrollment Requirement Note Types.....	1388
Purging Post Enrollment Requirement Data.....	1388
Page Used to Purge Post Enrollment Requirement Data.....	1388
Purging Post Enrollment Requirement Data.....	1388
Chapter 40: Using Enrollment Web Services.....	1391
Understanding Enrollment Web Services.....	1391
Chapter 41: Managing Program Planning and Enrollment.....	1393
Understanding the Academic Progress Tracker.....	1393
Linking an APT Instance to the Student Program.....	1393
Pages Used to Link an APT Instance to the Student Program.....	1394
Creating an APT Instance from Admissions.....	1394
Creating an APT Instance from Student Records Program/Plan Component.....	1397
Creating and Managing APT Instances Using the APT Request Process.....	1399
Page Used to Run the APT Request Process.....	1399
Running the APT Request Process.....	1400
Searching APT Requests.....	1406
Creating and Managing APT Instances Using the Academic Progress Tracker Component.....	1407
Pages Used to Create and Manage APT Instances.....	1408
Adding an APT Instance.....	1408
Managing APT Instance Statuses.....	1411
Using the AIR Tree.....	1412
Using the APT Tree.....	1418
Managing APT Items.....	1419
Using the APT Timeline.....	1449
Using Item Attributes to Extend APT Instance Header Data Elements.....	1451
Managing APT Enrollment.....	1454
Understanding APT Enrollment Processing.....	1454
Page Used to Process APT Enrollment Transactions.....	1455
Processing APT Enrollment Transactions.....	1455
Deleting Planning Nodes.....	1462
Page Used to Delete Planning Nodes.....	1463
Running the Delete Planning Nodes Process.....	1463
Managing the APT Administrative Roster.....	1465
Pages Used to Manage the APT Administrative Roster.....	1465
Processing APT Administrative Roster Transactions.....	1466
Monitoring APT Action Processes.....	1480
APT API Detail.....	1482
SSR_APT:API.....	1482
Managing APT Program Transfer.....	1523
Pages Used to Manage APT Program Transfer.....	1523
Defining Course Mappings for Programs.....	1523
Transferring Academic Items to a New Program.....	1524
Synchronizing the Academic Progress Tracker.....	1527
Pages Used to Synchronize the Academic Progress Tracker.....	1527
APT Sync Result Type/Scale Page.....	1527
APT Sync Process Page.....	1529
APT Sync Request Page.....	1532
Student's APT Sync Tracker Page.....	1532

APT Sync Maintenance Page.....	1533
Chapter 42: Managing Research Tracking.....	1535
Managing Research Candidates.....	1535
Pages Used to Manage Research Candidates.....	1535
Reviewing Candidate Information.....	1537
Tracking Research Topics.....	1538
Searching for Research Topics.....	1541
Assigning Candidate Supervisors.....	1541
Searching for Supervisors.....	1544
Tracking Consumption and Submission.....	1545
Tracking Additional Candidate Assignments.....	1551
Creating Assignments for Multiple Students.....	1555
Updating Candidate Management Data Using Admissions Components.....	1556
Managing a Candidate’s Thesis.....	1564
Understanding Thesis Management.....	1564
Pages Used to Manage a Candidate’s Thesis.....	1565
Entering Thesis Details.....	1565
Entering Thesis Evaluation.....	1569
Entering Thesis Comments.....	1573
Entering Additional Information.....	1574
Storing Thesis Attachments.....	1575
Managing Service Requests.....	1575
Page Used to Manage Service Requests.....	1576
Managing Service Requests.....	1576
Managing Candidate Eligibility Edit Messages.....	1579
Understanding Candidate Eligibility Edits.....	1579
Page Used to Review A Candidate’s Edit Messages.....	1580
Reviewing and Overriding Candidate Information.....	1580
Using Administrative Functions for Research Tracking.....	1583
Using Online Notifications.....	1583
Page Used to Create Online Notifications.....	1583
Creating Online Notifications.....	1583
Chapter 43: Managing Student Academic Projects.....	1587
Creating and Managing a Student Academic Project.....	1587
Pages Used to Create and Manage a Student Academic Project.....	1587
Creating and Managing a Student Academic Project.....	1587
Entering Additional Details for a Student Academic Project.....	1591
Creating Student Academic Projects in Batch.....	1593
Pages Used To Create Student Academic Projects in Batch.....	1593
Creating Student Academic Projects in Batch.....	1593
Creating Assignments for Multiple Student Academic Projects.....	1596
Chapter 44: Viewing Class Enrollment Data.....	1597
Viewing Enrollment Request History.....	1597
Page Used to View Enrollment Request History.....	1597
Searching for and Viewing Enrollment Requests.....	1597
Viewing Student Statistics.....	1599
Pages Used to View Student Statistics.....	1599
Viewing Student Enrollment Summaries.....	1600
Viewing Term Statistics.....	1600
Calculating Term Statistic Values.....	1606
Viewing Cumulative Statistics for Multiple Terms.....	1620

Calculating Cumulative Statistic Values.....	1622
Viewing Student Terms.....	1625
Viewing Student Class and Exam Schedules Using Self-Service Pages.....	1625
Viewing Class Rosters.....	1625
Page Used to View Class Rosters.....	1625
Viewing Class Rosters.....	1626
Viewing Class Rosters Using Self-Service Pages.....	1628
Printing Class Rosters.....	1628
Page Used to Print Class Rosters.....	1629
Printing Class Rosters.....	1629
Producing Student Study Lists.....	1631
Page Used to Produce Student Study Lists.....	1631
Generating Student Study Lists.....	1631
Chapter 45: Managing Enrollment Verifications.....	1633
Producing Enrollment Verification Reports.....	1633
Pages Used to Produce Enrollment Verification Reports.....	1633
Restricting Service Indicators from Enrollment Verification.....	1634
Entering Enrollment Verification Requests.....	1634
Entering Recipient Addresses for Enrollment Verifications.....	1636
Adding Notes to Enrollment Verifications.....	1638
Processing Enrollment Verifications in Batch.....	1638
Requesting Enrollment Verifications Through Self Service.....	1639
Chapter 46: Processing Transfer Credit.....	1641
Understanding Transfer Credit Processing.....	1641
Common Elements Used to Process Transfer Credit.....	1641
Transfer Credit Processing.....	1646
Converting Transfer Credit Units.....	1647
Recording External Course and Test Information.....	1649
Creating Student-Specific Agreements.....	1650
Pages Used to Create Student-Specific Agreements.....	1650
Describing Student Agreements.....	1650
Entering Student Agreement Details.....	1652
Processing Course Transfer Credit.....	1654
Understanding Course Transfer Credit Processing.....	1654
Pages Used to Process Course Transfer Credit.....	1656
Processing Course Transfer Credit Models with Predefined Rules.....	1658
Calculating and Posting Course Transfer Credit with Predefined Rules.....	1661
Processing Course Transfer Credit Models Manually.....	1663
Calculating and Posting Course Transfer Credit Manually.....	1667
Viewing Student Study Agreements.....	1669
Viewing Incoming and Editing Equivalent Course Information.....	1669
Processing Test Transfer Credit.....	1670
Understanding Test Transfer Credit Processing.....	1670
Pages Used to Process Test Transfer Credit.....	1671
Processing Test Transfer Credit Models with Predefined Rules.....	1673
Calculating and Posting Test Transfer Credit with Predefined Rules.....	1674
Processing Test Transfer Credit Models Manually.....	1675
Calculating and Posting Test Transfer Credit Manually.....	1676
Entering Incoming Test and Equivalent Course Information.....	1677
Processing Other Transfer Credit.....	1678
Understanding Other Transfer Credit Processing.....	1678

Pages Used to Process Other Transfer Credit.....	1679
Processing Other Transfer Credit Models.....	1679
Calculating and Posting Other Transfer Credit.....	1680
Adding Incoming Other Credit and Equivalent Course Information.....	1681
Processing Transfer Credit in Batch.....	1683
Understanding Batch Transfer Credit Processing.....	1683
Pages Used to Process Transfer Credit in Batch.....	1683
Posting Transfer Credit in Batch.....	1684
Viewing Process Results for Batch Posting of Transfer Credit.....	1687
Viewing and Printing Transfer Credit Information.....	1688
Pages Used to View and Print Transfer Credit Information.....	1688
Viewing Academic Test Summaries.....	1689
Viewing Schools by Group.....	1689
Retrieving Transfer Credit Summaries.....	1689
Viewing and Printing Transfer Credit Summaries.....	1691
Printing Transfer Credit Summaries in Batch.....	1692
Viewing Transfer Credit Reports Through Self Service.....	1693
Evaluating Transfer Credit Through Self Service.....	1693
Chapter 47: Tracking Attendance.....	1695
Understanding Attendance Tracking.....	1695
Generating Individual Class Attendance Rosters.....	1696
Prerequisites.....	1696
Pages Used to Generate Individual Class Attendance Rosters.....	1697
Generating Attendance Rosters for Individual Classes.....	1697
Entering Class Attendance Detail.....	1702
Generating Batch Attendance Rosters.....	1704
Understanding Batch Attendance Roster Generation.....	1705
Prerequisites.....	1705
Pages Used to Generate a Batch of Attendance Rosters.....	1705
Running the Attendance Roster Generator Process.....	1705
Entering Roster Generator Options.....	1708
Printing Attendance Rosters.....	1709
Using Attendance Rosters.....	1709
Prerequisites.....	1710
Pages Used to Record Attendance.....	1710
Tracking Attendance by Class.....	1711
Tracking Attendance by Class Meeting.....	1711
Selecting a Roster for a Student.....	1713
Tracking Attendance by Student.....	1713
Chapter 48: Tracking Student Data.....	1717
Common Element Used in Tracking Student Data.....	1717
Tracking Academic Standing.....	1717
Pages Used to Track Academic Standing.....	1717
Assigning Academic Standing in Batch.....	1718
Tracking Academic Standing for Individual Students.....	1719
Tracking Honors and Awards.....	1719
Pages Used to Track Honors and Awards.....	1720
Assigning Honors and Awards in Batch.....	1720
Tracking Honors and Awards for Individual Students.....	1720
Tracking Special Grade Point Averages.....	1721
Understanding How to Assign Special Grade Point Averages.....	1722

Page Used to Track Special Grade Point Averages.....	1722
Maintaining a Student's Special Grade Point Averages.....	1722
Tracking Milestones.....	1723
Pages Used to Track Milestones.....	1723
Assigning and Updating Milestones for a Student.....	1724
Creating Milestones from Templates.....	1726
Assigning and Updating Milestones for Multiple Students.....	1727
Tracking Extracurricular Activities.....	1729
Page Used to Track Extracurricular Activities.....	1730
Tracking an Individual's Extracurricular Activities.....	1730
Tracking Student Groups.....	1731
Page Used to Track Student Groups.....	1731
Tracking Student Attributes.....	1731
Page Used to Track Student Attributes.....	1731
Tracking Student Attributes.....	1732
Using Student Records Service Impacts.....	1732
Assigning Academic Advisors to Students.....	1733
Page Used to Assign Academic Advisors to Students.....	1735
Assigning Advisors to Students Individually.....	1735
Defining the Parameters for Selecting and Matching Advisors and Students.....	1737
Viewing the Advisor Population.....	1744
Assigning Advisors to a Student Population.....	1744
Viewing Advisors Through Self Service.....	1746
Viewing Advisee Information Through Self Service.....	1746
Viewing Student Careers.....	1747
Page Used to View Student Careers.....	1747
Viewing Comments, Checklists, and Communications.....	1747
Viewing Student Photos.....	1747
Page Used to View Student Photos.....	1747
Chapter 49: Managing Interoperability for Learning Management Systems (LMS).....	1749
Understanding the LMS Interoperability Batch Extract.....	1749
Understanding Integration with LMS Self-Service User Authentication.....	1751
Understanding LMS Setup.....	1751
Setting Up LMS Values and Default Options.....	1755
Pages Used to Set Up LMS Values and Default Options.....	1756
Setting Up LMS Datasource Values.....	1757
Setting Up LMS Target Values.....	1758
Setting Up LMS Type Values.....	1759
Setting Up LMS Authentication Profiles.....	1760
Defining LMS Providers.....	1760
Defining LMS Default and Extract Options for Your Institution.....	1762
Defining LMS Default Options for Course Components.....	1762
Defining LMS Options for Classes.....	1762
Running the LMS Batch Extract Process.....	1763
Prerequisites.....	1763
Pages Used to Extract LMS Data.....	1763
Defining LMS Run Control Parameters.....	1764
Defining LMS Run Control Criteria.....	1766
Defining LMS Output Parameters.....	1768
Using Self-Service Pages and LMS Authentication.....	1770
Chapter 50: Grading Students.....	1771

Understanding Grading.....	1771
Prerequisites.....	1771
Printing Grade Rosters.....	1771
Understanding Printing a Grade Roster.....	1771
Page Used to Print Grade Rosters.....	1772
Running the Grade Roster Report.....	1772
Entering Grades Online.....	1774
Understanding Entering Grades Online.....	1774
Pages Used to Enter Grades Online.....	1774
Using the Grade Roster Page to Enter Grades.....	1775
Reviewing Student Enrollment Detail.....	1777
Reviewing Transcript Notes.....	1778
Reviewing Student Incomplete Information.....	1778
Entering Grades Through Self Service.....	1779
Entering Grades Through the Self-Service Gradebook.....	1779
Posting the Grade Roster.....	1779
Understanding How to Post Grades.....	1779
Prerequisites.....	1780
Pages Used to Post Grade Rosters.....	1781
Posting Grades for a Single Class.....	1781
Posting Grades for Multiple Classes.....	1781
Generating Midterm Deficiency Reports and Communications.....	1782
Understanding Midterm Deficiency Reporting.....	1783
Page Used to Monitor Midterm Deficiencies.....	1783
Generating the Midterm Deficiency Report.....	1783
Generating Midterm Deficiency Letters.....	1784
Running the Grade Lapse Process.....	1784
Understanding the Grade Lapse Process.....	1785
Pages Used to Run the Grade Lapse Process.....	1785
Defining Grade Lapse Rules.....	1786
Running the Grade Lapse Process.....	1788
Viewing the Lapse Report Results Online.....	1789
Viewing Student Grades and Statistics.....	1789
Prerequisite.....	1789
Pages Used to View Student Grades and Statistics.....	1790
Auditing Grade Changes.....	1790
Understanding Grade Change Audits.....	1790
Prerequisites.....	1791
Page Used to Audit Grade Changes.....	1791
Entering Grade Change Audit Search Parameters.....	1791
Chapter 51: Graduating Students.....	1793
Tracking Graduation Progress.....	1793
Pages Used to Track Graduation Progress.....	1793
Track Individual Candidate Progress.....	1793
Reviewing Graduation Status History.....	1795
Updating Academic Program for a Group of Students.....	1795
Tracking Candidate Group Progress.....	1797
Posting Degrees.....	1798
Understanding the Degree Posting Process.....	1798
Prerequisites.....	1798
Pages Used to Post Degrees.....	1799

Completing the Student's Program.....	1799
Verifying and Updating Student Degree Data.....	1800
Viewing and Modifying Degree Data.....	1801
Viewing and Modifying Degree Honors Data.....	1801
Viewing and Modifying Degree Plan Data.....	1802
Viewing and Modifying Degree Subplan Data.....	1803
Automating Graduation Processing and Reporting.....	1804
Understanding the Graduation Reporting Process.....	1805
Prerequisites.....	1805
Pages Used to Automate Graduation Processing and Reporting.....	1806
Entering Graduation Report Parameters.....	1806
Retrieving the Student Population.....	1810
Auditing Degree Changes.....	1811
Understanding Degree Change Audits.....	1812
Prerequisites.....	1812
Pages Used to Audit Degree Changes.....	1812
Entering Degree Change Audit Search Parameters.....	1813
Viewing Degree Change Audit Results.....	1814
Viewing Degree Honors Change Audit Results.....	1815
Viewing Degree Plan Change Audit Results.....	1817
Viewing Degree Subplan Change Audit Results.....	1819
Applying for Graduation Through Self Service.....	1821
Managing Fluid Applications for Graduation.....	1821
Pages Used to Manage Fluid Applications for Graduation.....	1821
Managing Student Applications.....	1822
Chapter 52: Producing Transcripts.....	1827
Understanding Transcript-Related Processes.....	1827
Processing Transcripts for Individuals or Small Groups of Students.....	1828
Understanding the Request Transcript Report Component.....	1829
Prerequisite.....	1829
Pages Used to Create an Online Transcript Request.....	1829
Creating Transcript Request Headers.....	1830
Specifying Students for Evaluation.....	1835
Entering Transcript Recipient Information.....	1836
Viewing Process Messages for Transcript Requests.....	1836
Processing Batch Transcripts (Application Engine).....	1837
Page Used to Process Batch Transcripts.....	1838
Defining Transcript Processing Options.....	1838
Using the XML Transcript Template.....	1841
Understanding the XML Transcript Template.....	1841
Personalizing XML Transcript Dates.....	1842
Creating Batch Transcript Requests (COBOL).....	1843
Prerequisites.....	1844
Page Used to Create Batch Transcript Requests.....	1844
Running the Batch Transcript Request Process.....	1844
Using the Grade Review Transcript Release Process.....	1847
Pages Used to Run the Grade Review Process.....	1848
Setting Up Grade Review Values.....	1849
Specifying Required Grade Bases.....	1850
Defining Grade Review Parameters.....	1850
Producing Electronic Transcripts.....	1855

Pages Used to Produce Electronic Transcripts.....	1855
Entering Electronic Transcript Request Information.....	1856
Entering the Recipient's Address Information.....	1859
Entering Send Options.....	1860
Viewing Electronic Transcript Request History for a Student.....	1861
Producing Electronic Transcripts in Batch.....	1862
Understanding Producing Electronic Transcripts in Batch.....	1862
Pages Used to Produce Electronic Transcripts in Batch.....	1862
Generating Electronic Transcripts in Batch.....	1863
Sending Electronic Transcripts in Batch by Email.....	1863
Entering a Text Message on the Request.....	1864
Reviewing TS130 Outbound Transactions.....	1864
Page Used to Review TS130 Outbound Transactions.....	1864
Reviewing Transcript Request Data.....	1865
Processing TS131 Inbound Files.....	1865
Understanding TS131 Inbound Files.....	1865
Page Used to Process TS131 Inbound Files.....	1866
Downloading TS131 Files.....	1866
Reviewing Student Transcript Request History.....	1866
Prerequisite.....	1866
Page Used to Review Student Transcript Request History.....	1867
Running a Transcript Request Query.....	1867
Purging Transcripts.....	1867
Prerequisite.....	1868
Page Used to Purge Transcripts.....	1868
Purging Transcript Reports.....	1868
Using Self-Service Transcripts.....	1869
Chapter 53: Consolidating and Reporting Academic Statistics.....	1871
Understanding Consolidating and Reporting Academic Statistics.....	1871
Understanding Consolidated Statistics Processes.....	1872
Understanding Consolidate Academic Statistics Process Calculations.....	1878
Consolidating Academic Plans Using NSC Matching Criteria.....	1902
NSC Program Level Reporting: Academic Plan Usage.....	1903
Reporting NSC Program Changes.....	1903
Academic Load Calculation at the NSC Program Level.....	1905
Performing Academic Statistics Consolidation.....	1906
Page Used to Perform Academic Statistics Consolidation.....	1906
Consolidating Academic Statistics.....	1906
Viewing Consolidated Academic Statistics for Individual Students.....	1911
Pages Used to View Consolidated Academic Statistics for Individual Students.....	1911
Viewing Basic Data.....	1912
Viewing Statistics.....	1914
Viewing Withdrawal and External Study Information.....	1915
Viewing and Editing NSC Data Elements.....	1915
Viewing Consolidated Academic Statistics for Groups of Students.....	1920
Page Used to View Consolidated Academic Statistics for Groups of Students.....	1920
Viewing Mass Consolidated Academic Statistics.....	1920
Producing NSC Extracts.....	1921
Page Used to Produce an NSC Extract.....	1922
Running the NSC Report Process.....	1922
Chapter 54: Setting Up and Managing Veterans Benefit Reporting.....	1925

Setting Up Veterans Benefit Reporting.....	1925
Pages Used to Set Up Veterans Benefit Reporting.....	1925
Setting Up Instruction Mode Mapping.....	1925
Setting Up Payment Mapping.....	1926
Setting up Net Tuition and Fees.....	1927
Managing a Student's Veterans Benefit Information.....	1928
Pages Used to Manage a Student's Veterans Benefit Information.....	1928
Defining and Maintaining Veterans Benefit Information for a Student.....	1929
Creating and Updating Terms.....	1930
Page Used to Create or Update Terms.....	1930
Creating and Updating Terms.....	1931
Certifying Student Enrollment.....	1932
Page Used to Certify Student Enrollment.....	1933
Certifying Student Enrollment For a Reporting Period.....	1933
Calculating Net Tuition and Fees.....	1934
Pages Used to Calculate Net Tuition and Fees.....	1934
Calculating Federal Net Tuition and Fees.....	1935
Calculating State Net Tuition and Fees.....	1936
Viewing Veterans Payment History.....	1936
Pages Used to View Veterans Payment History.....	1936
Viewing a Student's Veterans Payments.....	1936
Rolling Over a Student's Benefit Summary Information.....	1937
Page Used to Roll Over a Student's Benefit Summary.....	1937
Rolling Over a Benefit Summary.....	1937
Chapter 55: Viewing Student Records Process Messages.....	1939
Viewing System Messages for Student Records COBOL Processes.....	1939
Page Used to View System Messages for Student Records COBOL Processes.....	1939
Viewing System Messages.....	1939
Chapter 56: (AUS) Managing Enrollment Feedback.....	1941
Understanding Enrollment Feedback.....	1941
Common Elements Used to Manage Enrollment Feedback.....	1941
Processing Enrollment Feedback for QTAC.....	1942
Understanding QTAC Enrollment Feedback Processing.....	1942
Page Used to Create a QTAC Enrollment Feedback Report.....	1943
Processing Enrollment Feedback for SATAC.....	1944
Understanding SATAC Enrollment Feedback Processing.....	1944
Page Used to Produce a SATAC Enrollment Feedback Report.....	1945
Processing Enrollment Feedback for UAC.....	1945
Understanding UAC Enrollment Feedback Processing.....	1946
Page Used to Create a UAC Enrollment Feedback Report.....	1946
Processing Enrollment Feedback for VTAC.....	1947
Understanding VTAC Enrollment Feedback Processing.....	1947
Page Used to Create a VTAC Enrollment Feedback Report.....	1948
Chapter 57: (AUS) Managing the Automated Results Transfer System.....	1949
Understanding ARTS.....	1949
Understanding ARTS File Naming Conventions.....	1950
Preparing for ARTS Processing.....	1951
Understanding ARTS Processing.....	1952
Pages Used to Prepare for ARTS Processing.....	1952
Entering Field of Study Values.....	1953
Entering Data Mapping Specifications.....	1955

Assigning Service Indicators.....	1955
Entering Student Program Notes.....	1956
Entering Honors and Awards.....	1956
Entering Comments.....	1956
Entering Communications.....	1957
Performing ARTS Processing.....	1957
Pages Used to Run the ARTS Process.....	1957
Entering ARTS Processing Parameters.....	1958
Entering ARTS Honors and Awards Parameters.....	1958
Entering Comment and Communication Parameters.....	1959
Chapter 58: (AUS) Generating Government Reports.....	1961
Understanding TCSI Reporting.....	1961
TCSI Reporting.....	1961
Pages Used to Report to TCSI.....	1962
Importing Existing Data From TCSI.....	1963
Reporting Campus and Program Data.....	1965
Reporting Student Data.....	1966
Reporting Scholarships.....	1970
Identifying New or Updated Application Records.....	1970
Deleting Old TCSI Transaction Data.....	1971
Reviewing Transaction Data From TCSI.....	1972
Pages Used to Review Transaction Data From TCSI.....	1974
Viewing Campus Transaction Records.....	1976
Viewing Program of Study Transaction Records.....	1976
Viewing Program Transaction Records.....	1976
Viewing Program on Campus Transaction Records.....	1977
Viewing Student Transaction Records.....	1978
Viewing Course Admission Transaction Records.....	1978
Viewing Unit Enrolment Transaction Records.....	1979
Viewing Application Transaction Records.....	1979
Chapter 59: (CAN) Generating Canadian Government Reports.....	1981
Understanding Canadian Government Report Generation.....	1981
Prerequisites for Generating Canadian Government Reports.....	1981
(Optional) Generating a Report of Selected Students.....	1982
Page Used to Generate the Student Selection Report.....	1982
Generating a Student List Report.....	1982
(Optional) Freezing a Student List.....	1982
Page Used to Freeze a Student List.....	1983
Running the Student List Freeze Process.....	1983
Running the PSIS Extract Process.....	1983
Pages Used to Run the PSIS Extract Process.....	1984
Running the PSIS Institution Process.....	1984
Running the PSIS Student Process.....	1985
Running the USISE Extract Process.....	1985
Page Used to Run the USISE Extract Process.....	1986
Entering USISE Extract Process Parameters.....	1986
Running the CIS Extract Process.....	1987
Page Used to Run the CIS Extract Process.....	1987
Entering CIS Extract Process Parameters.....	1988
Running the MET Extract Process.....	1988
Page Used to Run the MET Extract Process.....	1988

Entering MET Extract Process Parameters.....	1989
Running the OUAC Extract Process.....	1989
Page Used to Run the OUAC Extract Process.....	1990
Entering OUAC Extract Process Parameters.....	1990
Verifying Report Results and Viewing the Audit Reports.....	1991
Pages Used to Verify Report Results.....	1991
Running the Student Description Audit.....	1992
Running the Student Program Audit.....	1993
Running the Student Course Audit.....	1993
Reviewing Report Data.....	1993
Pages Used to Review Report Data.....	1994
(Optional) Correcting Report Data.....	1997
Archiving Extract Table Data.....	1998
Page Used to Archive Extract Data.....	1999
Running the Archive Process.....	1999
Chapter 60: (GBR) Managing HESA Returns.....	2001
Understanding HESA Returns.....	2001
Importing and Mapping HESA Codes.....	2002
Pages Used to Import and Map HESA Codes.....	2003
Importing HESA Codes.....	2005
Searching for the Imported HESA Codes.....	2007
Mapping Ethnic Codes.....	2009
Mapping Campus Codes.....	2009
Mapping Marital Status Codes.....	2009
Mapping Religion Codes.....	2010
Mapping Qualification Codes.....	2010
Mapping Nationality Codes.....	2011
Mapping Fee Eligibility Codes.....	2012
Mapping Mode of Study Codes.....	2012
Mapping Classification Codes.....	2012
Mapping Disability Codes.....	2013
Mapping Module Outcome Codes.....	2013
Mapping Gender Codes.....	2014
Mapping Orientation Codes.....	2014
Mapping Entry Qualification.....	2015
Setting Up a HESA Return.....	2015
Pages Used to Set Up a HESA Return.....	2016
Setting Up a HESA Return.....	2017
Setting Up HESA Fields.....	2024
Setting Up HESA Types.....	2025
Setting Up HESA Action Reasons.....	2027
Configuring HESA.....	2029
Generating Student Identifiers During Registration or Enrollment.....	2032
Define Session Year.....	2033
Setting Up and Entering Data for HESA Reporting.....	2034
Understanding Setting Up and Entering Data for HESA Reporting.....	2035
Pages Used to Set Up and Enter Data for HESA Reporting.....	2038
Setting Up Data Capture Rules.....	2042
Entering HESA Data for an Institution.....	2044
Entering HESA Data for Qualifications.....	2046
Entering HESA Data for an Academic Program.....	2047

Entering HESA Data for a Program Offering and Program Year.....	2052
Entering HESA Data for an Academic Plan.....	2053
Entering HESA Data for a Plan Offering and Plan Year.....	2055
Entering HESA Data for a Subplan.....	2055
Entering HESA Data for a Subplan Offering and Subplan Year.....	2056
Creating HESA Modules.....	2057
Creating Qualification Records.....	2058
Entering HESA Data for a Module.....	2061
Entering HESA Data for a Dummy Module.....	2061
Creating HESA Instance and Person HESA Data Records for Students.....	2062
Restricting Access to Person HESA Data Fields.....	2063
Entering HESA Data for a Person.....	2065
Entering Restricted HESA Data for a Person.....	2066
Entering HESA Instance Data for a Student.....	2066
Entering Mobility Data for a Student.....	2070
Entering HESA Entry Profile Data for a Student.....	2073
Entering Further Education Data for a Student.....	2074
Calculating Year of Student Values for Students.....	2075
Calculating Full-Time Equivalence for Students.....	2078
Entering HESA Advisor Data for a Student.....	2091
Entering HESA Data for an External Organization.....	2091
Entering DEGTYPE Value.....	2092
Preparing for Generating Graduate Outcomes Return.....	2092
Pages Used to Prepare for Generating Graduate Outcomes Return.....	2092
Importing the Survey Target Population.....	2093
Adding, Viewing, and Updating Surveys.....	2096
Adding a Survey.....	2097
Viewing or Updating Survey Details.....	2097
Generating a HESA Return and Creating a Return File.....	2098
Understanding Generating a HESA Return and Creating a Return File.....	2099
Pages Used to Generate a HESA Return and Create a Return File.....	2099
Importing the Target Population.....	2102
Generating a HESA Extract.....	2103
Reviewing the Extract Data.....	2118
Creating an XML Return File.....	2120
Validating an XML Return File.....	2122
Reviewing Submitted Data.....	2123
Purge Submitted Data.....	2124
Understanding Compare Processing for Data Futures.....	2125
Course.....	2125
Course Initiative.....	2126
Course Reference.....	2127
Course Role.....	2128
Curriculum Accreditation.....	2129
Module.....	2130
Module Cost Centre.....	2130
Module Delivery Role.....	2131
Module Subject.....	2132
Qualification.....	2133
Awarding Body Role.....	2134
Qualification Subject.....	2135

Session Year.....	2136
Venue.....	2137
Student Course Session.....	2137
Funding and Monitoring.....	2138
Funding Body.....	2139
Module Instance.....	2140
Off Venue Activity.....	2141
Reference Period Student Load.....	2141
Session Status.....	2142
Student Financial Support.....	2143
Study Location.....	2144
Supervisor Allocation.....	2145
Engagement.....	2145
Collaborative Provision.....	2146
Entry Qualification Award.....	2147
Entry Qualification Subject.....	2148
Entry Profile.....	2149
Leaver.....	2149
Qualification Awarded.....	2150
Qualification Award Accreditation.....	2151
Student Accreditation Aim.....	2152
Student Initiatives.....	2153
Student.....	2154
Disability.....	2154
Language Proficiency.....	2155
Understanding Extract Synch for Data Futures.....	2156
Chapter 61: (GBR) HESA Field Derivation.....	2159
Understanding HESA Derivation Steps.....	2159
Student Record Return: Institution Entity.....	2162
Indicator for HEFCE Funding Approximations (INSTAPP).....	2162
Record Type Indicator (RECID).....	2162
UK Provider Reference Number (UKPRN).....	2163
Student Record Return: Course Entity.....	2164
Awarding Body 1 (AWARDBOD).....	2164
Awarding Body 2 to 8 (AWARDBOD2 to 8).....	2165
Bilingual ITT Marker (BITTM).....	2166
Closed Course (CLSDCRS).....	2166
Collaborating Organization (COLLORG).....	2167
General Qualification Aim of Course (COURSEAIM).....	2168
Course Identifier (COURSEID).....	2169
Course Title (CTITLE).....	2169
FE General Qualification Aim (FEQAIMC).....	2170
Major Source of Funding (MSFUND).....	2170
NHS Bursaries (NHSBURSARY).....	2171
Own Course Identifier (OWNCOURSEID).....	2171
Reduced Course Return Indicator (REDUCEDC).....	2172
Regulatory Body for Health and Social Care Students (REGBODY).....	2173
Regulatory Body for Health and Social Care Students 2 (REGBODY2).....	2173
Subject Knowledge Enhancement Units (SKEUNITS).....	2174
Subject Knowledge Enhancement Placement (SKEOS).....	2175
Teaching Qualification Sought Sector (TQSSEC).....	2176

Teaching Qualification Sought Subject (TQSSUB).....	2176
Teacher Training Course (TTCID).....	2177
Student Record Return: Delivery and Organisation Location.....	2178
Delivery Organisation (DELORG).....	2179
Delivery Organisation Proportion (DELORGPROP).....	2179
Postcode (PCODELOC).....	2180
Student Record Return: Course Subject Entity.....	2180
Subject of ITT Specialism Indicator (ITTSUBJECT).....	2180
Subject of Course (SBJCA).....	2181
Subject Percentage (SBJPCNT).....	2182
Student Record Return: Module Entity.....	2182
Credit Value of Module (CRDTPTS).....	2183
Credit Transfer Scheme (CRDTSCM).....	2183
Module Franchise Indicator (FRANIND).....	2184
Module FTE (FTE).....	2184
Level of Credit Points (LEVLPTS).....	2185
Module Identifier (MODID).....	2185
Module Taught in a Celtic Language (MODLANG).....	2186
Module Title (MTITLE).....	2186
Percentage Not Taught By This Institution (PCOLAB).....	2187
Other Institution Providing Teaching (TINST).....	2187
Student Record Return: Module Subject Entity.....	2188
Cost Centre (COSTCN).....	2188
Subject of Module (MODSBJ).....	2189
Subject/Cost Centre Percentage (MODSBJP).....	2189
Student Record Return: Student Entity.....	2190
Date of Birth (BIRTHDTE).....	2190
British Sign Language User (BSLUSER).....	2191
Carer (CARER).....	2191
Disability (DISABLE).....	2192
Ethnicity (ETHNIC).....	2193
Forenames (FNAMES).....	2195
Gender (GENDER).....	2195
Gender Identity (GENDERID).....	2196
HESA Unique Student Identifier (HUSID).....	2196
Nationality (NATION).....	2197
National Identity (NATIOND).....	2198
National Identity (NATIOND2).....	2199
ORCID Identifier (ORCID).....	2199
Institution's Own Identifier for Student (OWNSTU).....	2200
Religion or Belief (RELBLF).....	2200
Service Leaver (SERLEAVE).....	2201
Service Student (SERSTU).....	2202
Sex Identifier (SEXID).....	2202
Sexual Orientation (SEXORT).....	2203
Scottish Candidate Number (SCN).....	2204
Dependants in Reporting Year (SDEPEND).....	2205
Family Name on 16th Birthday (SNAME16).....	2205
Student Support Number (SSN).....	2206
Family Name (SURNAME).....	2207
Term-time Accommodation (TTACCOM).....	2208

Term-time Postcode (TTPCODE).....	2208
UCAS Personal Identifier (UCASPERID).....	2209
Unique Learner Number (ULN).....	2210
Welsh Speaker Indicator (WELSSP).....	2210
Student Record Return: Instance Entity.....	2211
Actual Progression Route (ACTPROGROUTE).....	2213
Learning Support Cost (ADDSUPCT).....	2214
The Type of Aim Recorded (AIMTYPE).....	2214
Foundation Degree to Degree Bridging Course (BRIDGE).....	2215
Campus Identifier (CAMPID).....	2216
Completion Status (CSTAT).....	2217
Provider Transfer From Date (COLFROMDATE).....	2217
Provider Transferred From (COLFROMPROV).....	2218
Provider Transfer to Date (COLTODATE).....	2218
Provider Transferred To (COLTOPROV).....	2219
Start Date of Instance (COMDATE).....	2219
Course Identifier (COURSEID).....	2220
Destination (DESTIN).....	2221
Destination of Outward Credit Mobile Students (DESTOCM).....	2221
Department of Health Funding Body (DHFUND).....	2222
Regulatory Body Reference Number (DHREGREF).....	2223
Disabled Student Allowance (DISALL).....	2224
Disadvantage Uplift Factor (DISUPFAC).....	2225
Distance Learning SLN (DISTLEARNSLN).....	2225
Eligibility for Disadvantaged Uplift (ELIDISUP).....	2226
Eligibility for Enhanced Funding (ELIGENFD).....	2227
Aiming for an Equivalent or Lower Qualification (ELQ).....	2228
Employer Role (EMPROLE).....	2228
End Date of Instance (ENDDATE).....	2229
Highest Grade GCSE English (ENGGRADE).....	2230
ITT Entry Route (ENTRYRTE).....	2230
Exchange Programmes (EXCHANGE).....	2231
Fee Eligibility (FEEELIG).....	2232
Fee Regime Indicator (FEEREGIME).....	2234
Outcome (FEOUTCOME).....	2235
FE Student Marker (FESTUMK).....	2236
Other Funding Adjustment (FUNDADJOTH).....	2237
Funding Adjustment for Prior Learning (FUNDADJPRIOR).....	2237
Franchise Partner (FRANPART).....	2238
Franchised Out Arrangements (FROUTARR).....	2239
FTE Method (FTEMETHOD).....	2240
Fundability Code (FUNDCODE).....	2241
Completion of Year of Instance (FUNDCOMP).....	2242
Level Applicable to Funding Council HESES (FUNDLEV).....	2242
Funding Model (FUNDMODEL).....	2244
Framework Code (FWORKCODE).....	2244
Guided Learning Hours (GLHRS).....	2245
Government Initiatives (GOVINIT).....	2246
Gross Fee (GROSSFEE).....	2247
Implied Rate of Council Partial Funding (IMPRATE).....	2249
Institution's Own Campus Identifier (INSTCAMP).....	2251

Initiatives (INITIATIVES, INITIATIVES2, INITIATIVES3).....	2251
Intended Level of MPhil/PhD Studies (INTENTLEV).....	2252
Intercalation (INTERCALATE).....	2253
ITT Qualification Aim (ITTAIM).....	2254
ITT Phase/Scope (ITTPHSC).....	2255
ITT Schemes (ITTSCHMS).....	2255
Learning Difficulty (LEARNDIF).....	2256
Learning Planned End Date (LEARNPLANENDDATE).....	2257
FTE in Year A (LOADYRA).....	2258
FTE in Year B (LOADYRB).....	2258
Location of Study (LOCSDY).....	2258
Math Grade for GCSE (MATHGRADE).....	2260
Change of Mode Date (MCDATE).....	2260
Mode of Study (MODE).....	2261
Major Source of Tuition Fees (MSTUFEE).....	2263
Net Fee (NETFEE).....	2264
NHS Employer (NHSEMP).....	2267
Reason for Partial and Full Non-payment of Tuition (NONPAY).....	2268
Suspension of Active Studies (NOTACT).....	2268
Number of Units to Achieve Full Qualification (NOUNTACH).....	2269
Student Instance Identifier (NUMHUS).....	2270
Previous Student Instance Identifier (NUMHUSPREV).....	2270
Number of Units Completed (NUMUNITS).....	2271
Institution's Own Instance Identifier (OWNINST).....	2271
Subcontracted or Partnership UKPRN (PARTNERUKPRN).....	2272
PhD Submission Date (PHDSUB).....	2272
Planned Employability, Enrichment and Pastoral Hours (PLANEAPHOURS).....	2273
Planned Learning Hours (PLANLEARNHOURS).....	2274
Good Standing Marker (PROGRESS).....	2275
Programme Type (PROGTYPE).....	2275
Proportion of Funding Remaining (PROPFUNDREMAIN).....	2276
Apprenticeship Pathway (PWAYCODE).....	2277
Qualified Teacher Status (QTS).....	2278
Research Council Student Identifier (RCSTDID).....	2279
Research Council Student (RCSTDNT).....	2280
Amount of Tuition Fees Received/Expected for the Student (RECFEE).....	2280
Reduced Instance Return Indicator (REDUCEDI).....	2281
Reason for Engagement Ending (RSNENGEND).....	2282
Number of Student Associates Scheme Days Completed (SASDAYS).....	2282
Student Associates Scheme Placement (SASSCHL).....	2283
School Direct Employing School (SDEMPLOY).....	2283
School Direct Lead School (SDLEAD).....	2284
Subject Knowledge Enhancement Institution (SKEITT).....	2285
Special Fee Indicator (SPECFEE).....	2286
Expected Length of Study (SLENGTH).....	2286
SLDD-Discrete Provision (ST13).....	2287
Student Instance FTE (STULOAD).....	2288
Teacher Reference Number (TREFNO).....	2289
Type of Instance Year (TYPEYR).....	2289
Units of Length (UNITLGTH).....	2292
Withdrawal Reason (WITHDRAWREASON).....	2294

Length of Current Year of Instance (YEARLGTH).....	2294
Year of Program (YEARPRG).....	2295
Year of Student on This Instance (YEARSTU).....	2296
Student Record Return: Entry Profile Entity.....	2297
Access Programmes (ACCESS).....	2297
APEL Credits (APELCRD).....	2297
Articulation (ARTICLN).....	2298
Care Leaver / Looked After Status (CARELEAVER).....	2299
Credit Points Counted Towards Study (CRDPTSTU).....	2300
Credit Scheme (CRDSCM).....	2300
Domicile (DOMICILE).....	2301
Estranged Student (ESTRANGED).....	2302
Marital Status (MARSTAT).....	2302
New Entrant to Higher Education (NEWENT).....	2303
Dependents on Entry (NIDEPEND).....	2304
Parental Education (PARED).....	2304
PGCE Class of Undergraduate Degree (PGCECLSS).....	2306
PGCE Subject of Undergraduate Degree (PGCESBJ, PGCESBJ2, PGCESBJ3, PGCESBJ4, PGCESBJ5).....	2306
Postcode (POSTCODE).....	2307
Last School Attended (PREVINST).....	2308
Highest Qualification On Entry (QUALENT3).....	2309
Religion (RELIGION).....	2309
Socio-Economic Classification (SEC).....	2310
Occupation Code (SOC2010).....	2311
UCAS Application Number (UCASAPPID).....	2311
Welsh Baccalaureate Advanced Diploma (WELBACC).....	2312
Year Left Last Institution (YRLINST).....	2313
Student Record Return: Qualifications On Entry Entity.....	2313
Qualification Grade (QUALGRADE).....	2313
Qualification Subject (QUALSBJ).....	2314
Qualification Sitting (QUALSIT).....	2314
Qualification Type (QUALTYPE).....	2315
Qualification Year (QUALYEAR).....	2315
Student Record Return: Qualifications Awarded Entity.....	2315
Classification (CLASS).....	2316
Outcome of ITT Instance (OUTCOME).....	2317
Qualification Awarded (QUAL).....	2317
Teaching Qualifications Gained Sector (TQGSEC).....	2318
Teacher Qualification Gained Subject (TQGSUB).....	2319
Student Record Return: Student On Module Entity.....	2320
APEL Indicator (APEL).....	2321
Percentage of Module Taught in Celtic Language (LANGPCNT).....	2321
Module Identifier (MODID).....	2322
Module Countable (MODCOUNT).....	2322
Module Outcome (MODOUT).....	2323
Module Status (MODSTAT).....	2323
Module Year (MODYR).....	2324
Student Record Return: REF Data Entity.....	2325
Collaborating Provider (COLPROV).....	2327
RAE Unit of Assessment (OUA2008).....	2327

REF Unit of Assessment (UOA2021).....	2328
Unit of Assessment Percentage (UOAPCNT).....	2328
REF Unit of Assessment (UOA2014).....	2329
Student Record Return: Learner Employment Status Entity.....	2330
Date Employment Status Applies To (DATEEMPSTATAPP).....	2330
Employer Identifier (EMPID).....	2330
Employment Status (EMPSTAT).....	2331
ILR Agreement Identifier (ILRAGREEID).....	2331
Workplace Location Postcode (WORKLOCPOSTCODE).....	2332
Student Record Return: Employment Status Monitoring Entity.....	2332
Employment Status Monitoring Code (ESMCODE).....	2332
Employment Status Monitoring Type (ESMTYPE).....	2333
Student Record Return: Learner FAM Entity.....	2333
Learner Funding and Monitoring Code (LEARNFAMCODE).....	2334
Learner Funding and Monitoring Type (LEARNFAMTYPE).....	2334
Student Record Return: Learning Delivery FAM Entity.....	2334
Student Record Return: Learning Delivery Funding and Monitoring Code (LEARNDELFAMCODE).....	2335
Learning Delivery Funding and Monitoring Date Applies From (LEARNDELFAMFROM).....	2335
Learning Delivery Funding and Monitoring Date Applies To (LEARNDELFAMTO).....	2336
Learning Delivery Funding and Monitoring Type (LEARNDELFAMTYPE).....	2336
Student Record Return: Learning Delivery Work Placement Entity.....	2336
Work Placement Employer Identifier (LEARNWORKEMPID).....	2337
Work Placement End Date (LEARNWORKEND).....	2337
Work Placement End Date (LEARNWORKEND).....	2338
Work Placement Hours (LEARNWORKHOURS).....	2338
Work Placement Start Date (LEARNWORKSTART).....	2339
Student Record Return: Financial Support Entity.....	2339
Access and Participation Spending Commitment (APPSPEND).....	2340
Financial Support Amount (FINAMOUNT).....	2340
Financial Support Type (FINTYPE).....	2341
Student Record Return: ITT Placement.....	2341
Number of days Spent in Placement School (PLMNTDYS).....	2342
Placement School (PLMNTSCH).....	2342
Student Record Return: Placement.....	2342
Student Record Return: Mobility Entity.....	2344
Mobility Duration (MOBDURA).....	2345
Mobility Location (MOBLOCA).....	2345
Mobility Scheme (MOBScheme).....	2346
Mobility Type (MOBTYPE).....	2346
Mobility Type (MOBTYPE2, MOBTYPE3).....	2346
Aggregate Offshore Return: Institution Entity.....	2347
Record Type Indicator (RECID).....	2347
UK Provider Reference Number (UKPRN).....	2347
Aggregate Offshore Return: Provision Entity.....	2348
Country of Activity (COUNTRY).....	2348
Institutions Own Campus Identifier (INSTCAMP).....	2349
Level of Provision (LEVEL).....	2349
Number of Students (HEADCOUNT).....	2350
Type of Activity (TYPE).....	2350
ITT Return: Institution Entity.....	2351

Record Type Indicator (RECID).....	2351
UK Provider Reference Number (UKPRN).....	2352
ITT Return: Student Entity.....	2352
Allocated Place (ALLPLACE).....	2353
Apply Application ID (APPLYAPPLICATIONID).....	2354
Date of Birth (BIRTHDTE).....	2354
Bursary Level Award (BURSLEV).....	2355
Start Date of Instance (COMDATE).....	2355
Course Identifier (COURSEID).....	2356
Course Title (CTITLE).....	2357
Course Mode (CRMODE).....	2357
Disability (DISABILITY TO DISABILITY8).....	2358
Disabled Student Allowance (DISALL).....	2359
Discretionary Funding (DISCFUND).....	2359
Domicile (DOMICILE).....	2360
Expected End Date (ENGEXPECTEDENDDATE).....	2360
ITT Entry Route (ENTRYRTEE).....	2361
Ethnicity (ETHNICS).....	2362
Forenames (FNAMES).....	2363
Fundability Code (FUNDCODE).....	2363
HESA Unique Student Identifier (HUSID/SID).....	2364
Positive Indication that self-certification complete (INDSLFCRT).....	2365
ITT Initiatives (INITIATIVES-ITT, INITIATIVES-ITT2).....	2365
Independent Safeguarding Authority Registration Number (ISANUM).....	2366
ITT Qualification Aim (ITTAIM).....	2366
Start Date of ITT Course (ITTCOMDATE).....	2367
ITT Phase/Scope (ITTPHSC).....	2368
ITT Schemes (ITTSCHMS).....	2368
Mode of Study (MODE).....	2369
Major Source of Tuition Fees (MSTUFEE).....	2370
Nationality (NATION).....	2371
National Identity (NATIOND).....	2372
National Identity (NATIOND2).....	2373
National Insurance Number (NIN).....	2373
Email Addresses (NQTEMAIL).....	2374
Student Instance Identifier (NUMHUS).....	2374
Institution's Own Identifier for Student (OWNSTU).....	2375
Apprenticeship Start Date (PGAPPSTDT).....	2375
PGCE Class of Undergraduate Degree (PGCECLSS).....	2376
PGCE Subject of Undergraduate Degree (PGCESBJ).....	2376
Immediately Prior Surname (PSURNAME).....	2377
Qualification Aim (QLAIM).....	2377
School Direct Employing School (SDEMPLOY).....	2378
School Direct Lead School (SDLEAD).....	2379
Service Leavers (SERLEAVE).....	2380
Sex Identifier (SEXIDS).....	2380
Family Name on 16th Birthday (SNAME16).....	2381
Expected Length of Study (SLENGTH).....	2382
Student Accreditation Aim Accreditation Identifier (STUACCID).....	2383
Family Name (SURNAME).....	2383
Title (TITLE).....	2384

Teacher Reference Number (TREFNO).....	2384
Teacher Training Course (TTCIDC).....	2385
Unique Learner Number (ULN).....	2385
Units of Length (UNITLGTH).....	2386
Year of Program (YEARPRG).....	2387
Year of Student on This Instance (YEARSTU).....	2387
ITT Return: Placement.....	2388
Placement School (PLMNTSCH).....	2388
Number of days Spent in Placement School (PLMNTDYS).....	2388
ITT Return: Course Subject Entity.....	2389
Subject of ITT Course (SBJCA).....	2389
ITT Return: Previous Qualification.....	2390
Bursary Flag (BURSFLAG).....	2390
Previous Degree Country (DEGCTRY).....	2391
Previous Degree End Date (DEGENDDT).....	2392
Previous Degree Establishment (DEGEST).....	2392
Previous Degree Length in Years (DEGLENGTH).....	2393
Previous Degree Subject (DEGSBJ, DEGSBJ2, DEGSBJ3).....	2394
Previous Degree Start Date (DEGSTDT).....	2395
Previous Degree Type (DEGTYPE).....	2395
First Degree Flag (FIRSTDEG).....	2396
PGCE Class of Undergraduate Degree (PGCECLSS).....	2396
Data Futures Return: Course Entity.....	2397
Bilingual ITT Marker (BITTMC).....	2397
Closed Course (CLSDCRSC).....	2398
Course Title (COURSETITLE).....	2399
Fully Flexible Indicator (FULLYFLEX).....	2399
Funding Level (FUNLEVEL).....	2400
Pre-Requisite (PREREQUISITE).....	2401
Qualification Identifier (QUALID).....	2401
Sandwich (SANDWICHCD).....	2402
Teacher Training Course (TTCIDC).....	2403
Data Futures Return: Course Initiative Entity.....	2403
Course Initiative Identifier (COURSEINITID).....	2404
Initiative Valid From Date (COURSEINITVALIDFROM).....	2404
Initiative Valid To Date (COURSEINITVALIDTO).....	2405
Data Futures Return: Curriculum Accreditation Entity.....	2406
Curriculum Accreditation Identifier (CURACCID).....	2406
Accreditation Valid From Date (CURACCVALIDFROM).....	2407
Accreditation Valid To Date (CURACCVALIDTO).....	2407
Data Futures Return: Course Reference Entity.....	2408
Course Reference Identifier Type (COURSEREFRNCIDTYPE).....	2409
Course Reference Identifier (COURSEREFRNCID).....	2410
Data Futures Return: Course Role Entity.....	2411
Course Role HESA Identifier (COURSEROLEHESAID).....	2412
Role Type (ROLETYPEPCR).....	2412
Course Delivery Role Proportion (CRPROPORTION).....	2413
Data Futures Return: Module Entity.....	2413
Credit Value of Module (CRDTPTS).....	2414
Credit Transfer Scheme (CRDTSCMM).....	2415
Module FTE (FTE).....	2415

Module Language Identifier (MODLANGID).....	2416
Level of Credit Points (LEVLPTSM).....	2416
Module Identifier (MODID).....	2417
Data Futures Return: Module Subject Entity.....	2417
Subject Identifier (MODSBJ).....	2417
Module Proportion (MODPROPORTION).....	2418
Data Futures Return: Module Delivery Role Entity.....	2418
Module Delivery Role HESA Identifier (MDRHESAID).....	2418
Module Delivery Role Proportion (MDRPROPORTION).....	2419
Data Futures Return: Module Cost Centre Entity.....	2419
HESA Cost Centre (COSTCN).....	2420
HESA Cost Centre Proportion (COSTCNPROPORTION).....	2420
Data Futures Return: Module Instance Entity.....	2421
Continuing Module (CONTINUING).....	2422
Inactive Module Flag (INACTIVEMOD).....	2423
Language Percentage (LANGPCNT).....	2424
Module Instance Fee Amount (MIFEEAMOUNT).....	2424
Module Identifier (MODID).....	2424
Module Instance End Date (MODINSTENDDATE).....	2425
Module Instance Start Date (MODINSTSTARTDATE).....	2425
Module Outcome (MODULEOUTCOME).....	2426
Module Result (MODULERESULT).....	2427
Data Futures Return: Leaver Entity.....	2428
Engagement End Date (ENGENDDATE).....	2428
Intended Destination (INTENDEDDESTINATION).....	2429
Reason for Engagement Ending (RSNENGEND).....	2430
Data Futures Return: Reference Period Student Load.....	2430
RP Student Load (RPSTULOAD).....	2430
Reference Period (REFPERIOD).....	2431
Year (YEAR).....	2431
Data Futures Return: Funding and Monitoring Entity.....	2432
Equivalent or Lower Qualification (ELQ).....	2432
Funding Completion (FUNDCOMPFM).....	2433
Funding Length (FUNDLLENGTH).....	2433
Non-Regulated Fee Flag (NONREGFEE).....	2434
Data Futures Return: Session Status Entity.....	2435
Status Changed To (STATUSCHANGEDTO).....	2436
Status Valid From (STATUSVALIDFROM).....	2437
Data Futures Return: Study Location Entity.....	2438
Distance Learning (DISTANCESL).....	2438
Study Proportion (STUDYPROPORTION).....	2439
Venue Identifier (VENUEID).....	2440
Data Futures Return: Supervisor Allocation Entity.....	2441
Supervisor Allocation HESA Identifier (SUPALLHESAID).....	2442
REF 2021 Unit of Assessment (REF2021UNIT).....	2443
Supervisor Allocation Proportion (SUPALLPROP).....	2444
Data Futures Return: Entry Qualification Award Entity.....	2444
Entry Qualification Award Result (ENTRYQUALAWARDRESULT).....	2445
Own Qualification ID (OWNQUALID).....	2446
Qualification Result (QUALRESULTEQA).....	2446
Qualification Type Identifier (QUALTYPEID).....	2446

Qualification Year (QUALYEAR).....	2447
Data Futures Return: Entry Qualification Subject Entity.....	2448
Subject Identifier (SUBJECTID).....	2448
Data Futures Return: Disability Entity.....	2449
Disability Type (DISABILITY).....	2449
Data Futures Return: Qualification Entity.....	2450
Qualification Category (QUALCAT).....	2450
Qualification Title (QUALTITLE).....	2450
Data Futures Return: Qualification Subject Entity.....	2451
Qualification Proportion (QUALPROPORTION).....	2451
Qualification ITT Specialism (QUALITT).....	2452
Qualification Subject (QUALSUBJECT).....	2452
Data Futures Return: Session Year Entity.....	2452
Session Year Identifier (SESSIONYEARID).....	2453
Own Session Year Identifier (OWNSESSIONYEARID).....	2453
Session Year End Date (SYENDDATE).....	2453
Session Year Start Date (SYSTARTDATE).....	2454
Data Futures Return: Engagement Entity.....	2454
School Direct Employing School (EMPLOYING SCHOOL).....	2455
Engagement Start Date (ENGSTARTDATE).....	2456
ITT Entry Route (ENTRYRTEE).....	2457
Engagement Expected End Date (ENGEXPECTEDENDDATE).....	2458
Primarily Outside the UK (ENGPRINONUK).....	2459
Fee Eligibility (FEEELIGE).....	2459
Fee Status (FEESTATUS).....	2461
Incoming Exchange (INCOMINGEXCHANGE).....	2462
Lead School (LEADSCHOOL).....	2463
NHS Employer (NHSEMP).....	2464
Own Engagement Identifier (OWNENGID).....	2465
Qualified Teacher Status (QTSE).....	2465
Research Council Student Identifier (RCSTDID).....	2466
Research Council Student (RCSTDNTE).....	2467
Study Intention (STUDYINTENTION).....	2469
Teacher Reference Number (TRN).....	2469
Data Futures Return: Student Initiatives Entity.....	2470
Student Initiative (STUINITID).....	2470
Data Futures Return: Entry Profile Entity.....	2471
Access Programme (ACCESSPRG).....	2471
APEL Credits (APELCRD).....	2471
Care Leaver Type (CARELEAVERE).....	2472
Credit Points Counted Towards Study (CRDPTSTU).....	2473
Credit Scheme (CRDSCM).....	2474
Dependant Type (DEPENDANT).....	2474
Entry Profile Dependant (ENTPRODEP).....	2475
Estranged Student (ESTRANGED).....	2476
Highest Qualification on Entry (HIGHESTQOE).....	2476
Marital Status (MARSTATE).....	2477
Parental Education (PAREDE).....	2478
Country of Permanent Address (PERMADDCOUNTRY).....	2479
Postcode of Permanent Home Address (PERMADDPOSTCODE).....	2480
Previous Provider (PREVIOUSPROVIDER).....	2481

Religious Background (RELIGIOUSBGROUND).....	2482
Socio Economic Classification (SECE).....	2482
Standard Occupational Classification 2010 (SOC2010).....	2483
Standard Occupational Classification 2020 (SOC2020).....	2484
UCAS Scheme Code (UCASSCHEMECODE).....	2484
Year Left Last Provider (YRLPPROV).....	2485
Data Futures Return: Qualification Awarded Entity.....	2486
Qualification Awarded Result (QUALAWARDRESULT).....	2487
Thesis Title (THESISTITLE).....	2487
Data Futures Return: Qualification Award Accreditation Entity.....	2489
Qualification Awarded Accreditation Identifier (QUALAWARDACCID).....	2489
Data Futures Return: Student Course Session Entity.....	2489
Course Identifier (COURSEID).....	2490
Fee Method (FEEMETHOD).....	2491
Intended Thesis Title (INTENDEDTHESISTITLE).....	2491
Intercalation (INTERCALATION).....	2492
Invoice Fee Amount (INVOICEFEEAMOUNT).....	2493
Invoice HESA Identifier (INVOICEHESAID).....	2495
PGR Language Identifier (PGRLANGID).....	2496
PGR Language Percentage (PGRLANGPCT).....	2497
PhD Submission Date (PHDSUB).....	2498
Placement (PLACEMENT).....	2499
Predicted Full-Time Equivalence (PREDICTEDSTULOAD).....	2500
Preparatory Student Course Session (PREPFLAG).....	2501
Reason for Student Course Session Ending (RSNSCSEND).....	2502
Student Course Session End Date (SCSENDDATE).....	2502
Student Course Session Expected End Date (SCSEXPECTEDENDDATE).....	2503
Student Course Session Fee Amount (SCSFEEAMOUNT).....	2504
Student Course Session Mode (SCSMODE).....	2507
Student Course Session Start Date (SCSSTARTDATE).....	2508
Session Year Identifier (SESSIONYEARID).....	2509
Study Abroad(STUDYABROAD).....	2509
Student Load (STULOAD).....	2511
Programme Year (YEARPRG).....	2511
Data Futures Return: Awarding Body Role Entity.....	2512
Awarding Body Identifier (AWARDINGBODYID).....	2512
Data Futures Return: Funding Body Entity.....	2512
Funding Body (FUNDINGBODY).....	2513
Data Futures Return: Student Entity.....	2514
Birthdate (BIRTHDTE).....	2514
Carer Type (CARER).....	2514
Ethnicity (ETHNICS).....	2515
First Names (FNAMES).....	2516
Gender Identity (GENDERID).....	2517
Nationality (NATION).....	2517
Own Student Identifier (OWNSTU).....	2518
Religion (RELIGIONS).....	2519
Scottish Candidate Number (SCN).....	2519
Service Leaver Type (SERLEAVE).....	2520
Service Student (SERSTU).....	2521
Sex Identifier (SEXIDS).....	2522

Sexual Orientation (SEXORTS).....	2522
Surname at 16 (SNAME16).....	2523
Student Support Number (SSN).....	2524
Student Dependant (STUDEP).....	2525
Surname (SURNAME).....	2526
Transgender (TRANS).....	2526
Term-time Accommodation (TTACCOMS).....	2527
Term-time Postcode (TTPCODE).....	2527
UCAS Personal Identifier (UCASPERID).....	2529
Unique Learner Number (ULN).....	2529
Data Futures Return: Venue Entity.....	2530
Own Venue Identifier (OWNVENUEID).....	2530
Postcode (POSTCODE).....	2531
Venue Name (VENUENAME).....	2531
Venue UKPRN (VENUEUKPRN).....	2531
Data Futures Return: Off Venue Activity Entity.....	2532
Activity Duration Amount (ACTDURATION).....	2532
Activity Duration Type (ACTDURATIONTYPE).....	2533
Activity End Date (ACTENDDATE).....	2533
Activity Start Date (ACTSTARTDATE).....	2533
Activity Type Identifier (ACTTYPEID).....	2534
Country (COUNTRY).....	2534
Host Identifier (HOSTID).....	2535
Host Identifier Type (HOSTIDTYPE).....	2536
Mobility Scheme (MOBScheme).....	2537
Module Instance Identifier (MODINSTID).....	2537
Data Futures Return: Collaborative Provision Entity.....	2538
Collaborative Provision Type (COLPROVTYPEID).....	2538
Partner NUMHUS (PARTNERNUMHUS).....	2539
Partner SID (PARTNERSID).....	2539
Partner UKPRN (PARTNERUKPRN).....	2539
Data Futures Return: Student Accreditation Aim Entity.....	2540
Student Accreditation Aim Accreditation Identifier (STUACCID).....	2540
Data Futures Return: Student Financial Support Entity.....	2541
Financial Support Type (FINSUPTYPE).....	2541
Access and Participation Flag (APPSPEND).....	2542
Financial Support Amount (FINSUPAMOUNT).....	2542
Data Futures Return: Language Proficiency Entity.....	2543
Language Proficiency Identifier (LANGPROFICIENCYID).....	2543
Proficiency Type (PROFICIENCYTYPE).....	2543
Graduate Outcomes Return: Provider Entity.....	2544
Census (CENSUS).....	2544
Record Type Indicator (RECID).....	2545
UK Provider Reference Number (UKPRN).....	2545
Graduate Outcomes Return: Graduate Entity.....	2545
Country (COUNTRY).....	2546
Email Address (EMAIL, EMAIL2, EMAIL3).....	2547
Forenames (FNAMES).....	2547
Forename Change (FNMECHNGE).....	2548
Status of Graduate (GRADSTATUS).....	2548
HESA Unique Graduate Identifier (HUSID).....	2549

International Telephone (INTTEL, INTTEL2, INTTEL3).....	2549
Own Graduate Identifier (OWNSTU).....	2550
Surname Change (SNAMECHNGE).....	2550
Surname (SURNAME).....	2551
UK Mobile (UKMOB, UKMOB2, UKMOB3).....	2551
UK Telephone (UKTEL, UKTEL2, UKTEL3).....	2552
Graduate Outcomes Return: Postal Address Entity.....	2553
Address Line 1 (ADDRESSLN1).....	2553
Address Line 2 (ADDRESSLN2).....	2554
Address Line 3 (ADDRESSLN3).....	2554
Address Line 4 (ADDRESSLN4).....	2555
Address Line 5 (ADDRESSLN5).....	2555
Address Line 6 (ADDRESSLN6).....	2555
Postcode (POSTCODE).....	2556
DLHE Return: Institution Entity.....	2556
Record Type Indicator (RECID).....	2556
UK Provider Reference Number (UKPRN).....	2557
DLHE Return: Student Entity.....	2557
All Activities – Q1 (ALLACT1).....	2558
All Activities – Q1 (ALLACT2-8).....	2558
April or January Survey (APRJAN).....	2559
Higher Education experience for business – Q33 (HEBUSNEXP).....	2559
Higher Education experience for study – Q32 (HESTUDYEXP).....	2560
Higher Education experience for work – Q31 (HEWORKEXP).....	2560
HESA unique student identifier (HUSID).....	2561
Most important activity – Q1 (MIMPACT).....	2561
Status of data collection (STATUS).....	2562
Opt Out from Communications (OPTOUT).....	2562
DLHE Return: Employment Entity.....	2563
Employment basis (EMPBASIS).....	2563
Country of employment (EMPCOUNTRY).....	2563
Currency of Pay (EMPCURRENCY).....	2564
Hours Worked per Week (EMPHOURS).....	2564
Importance to employer (EMPIMP).....	2564
Employer name (EMPNAME).....	2565
PAY (EMPPAY).....	2565
Payment Period (EMPPAYPERIOD).....	2566
UK Postcode for place of employment (EMPPCODE).....	2566
Place of employment (EMPPLACE).....	2567
Unpaid work (EMPUNPAID).....	2567
Total estimated earnings for a year (ESTEARN).....	2567
Job duties (JOBdutIES).....	2568
How found job (JOBFOUND).....	2568
All reasons for taking the job (JOBRSNALL1).....	2569
All reasons for taking the job (JOBRSNALL2 to 9).....	2569
Main reason for taking the job (JOBRSNMAIN).....	2570
Number of jobs (JOBSNO).....	2570
Job title (JOBTITLE).....	2571
Nature of employer's business (MAKEDO).....	2571
NHS Organisation – Q14 (NHSORG).....	2572
Postdoctoral research contract – derived from Q3 and Q4 (POSTDOC).....	2572

Previously employed (PREVEMP).....	2572
Category of previous employment (PREVWORK1).....	2573
Category of previous employment (PREVWORK2 to 7).....	2573
Qualification required for job (QUALREQ).....	2574
Standard Occupational Classification 2010 - derived from Q3 and Q4 (SOCDLHE2010).....	2574
DLHE Return: Teaching Entity.....	2575
Employed as teacher (EMPLDTEACH).....	2575
GTC Scotland Teacher Induction scheme (GTCSTIS).....	2575
Seeking a teaching post (SEEKTEACH).....	2576
Teaching funded (TEACHFUND).....	2576
Teaching phase (TEACHPHS).....	2577
DLHE Return: Study Entity.....	2577
Course name (COURSENAME).....	2578
JACS 3.0 – derived from Q27 and Q28 (JACS).....	2578
JACS 3.0 – derived from Q27 and Q28 (JACS-S2, JACS-S3).....	2578
How funding further study (STUDYFUND).....	2579
Subject of study, training or research (SUBJECT).....	2579
Type of qualification – Q26 (TYPEQUAL).....	2580
Name of university or college (UCNAME).....	2580
University or college providing study – Derived from Q29 (UCPROV).....	2581
Unistats/KIS Return: Institution Entity.....	2581
National Scholarship Programme Participation (NSP).....	2581
Franchise UK Provider Reference Number (OTHERINST).....	2582
Franchise UK Provider Reference Number (OTHERINST2 to 9).....	2582
Record Type Indicator (RECID).....	2583
Student Union URL (SUURL).....	2583
UK Provider Reference Number (UKPRN).....	2583
Unistats/KIS Return: Location Entity.....	2584
Accommodation Cost URL (ACCOMURL).....	2584
Location Latitude (LATITUDE).....	2584
Location Identifier (LOCID).....	2585
Location Identifier Name (LOCNAME).....	2585
Location UKPRN (LOCUKPRN).....	2586
Location Longitude (LONGITUDE).....	2586
Student Union URL (SUURL).....	2586
Unistats/KIS Return: KISCourse Entity.....	2587
Assessment Methods URL (ASSURL).....	2587
Course Costs URL (CRSECSTURL).....	2588
Course Page URL (CRSEURL).....	2589
Distance Learning Only (DISTANCE).....	2589
Employment Details URL (EMPLOYURL).....	2590
Foundation Year Availability (FOUNDATION).....	2590
Subject of Course – HECOS.....	2591
Subject of Course – HECOS (HECOS2, HECOS3, HECOS4, HECOS5).....	2592
Honours Award Provision (HONOURS).....	2593
Subject of Course – Full JACS (JACSA).....	2593
Subject of course – Full JACS (JACSB and JACSC).....	2594
KIS Course Mode (KISAIM).....	2595
KIS Course Identifier (KISCOURSEID).....	2596
KIS Course Mode (KISMODE).....	2596
Change of Course Location (LOCCHNGE).....	2597

Learning and Teaching Methods URL (LTURL).....	2597
NHS Funded Students (NHS).....	2598
Length of Courses (NUMSTAGE).....	2599
Related KIS 2, 3 (RELATEDKIS2, RELATEDKIS3).....	2599
Sandwich Year Availability (SANDWICH).....	2600
Support Details URL (SUPPORTURL).....	2601
Teaching Institution UK Provider Reference Number (TEACHUKPRN).....	2601
Teaching Institution UK Provider Reference Number (TEACHUKPRN2, TEACHUKPRN3).....	2602
Course Title (TITLEK).....	2603
Teacher Training Course (TTCIDC).....	2604
UCAS Programme Code for the Course (UCASPROGID).....	2604
Application UKPRN (UKPRNAPPLY).....	2605
Year Abroad Availability (YEARABROAD).....	2605
Unistats/KIS Return: Accreditation Entity.....	2606
Accreditation Type (ACCTYPE).....	2606
Accreditation Dependency (ACCDEPEND).....	2607
Accreditation Dependency URL (ACCDEPENDURL).....	2608
Unistats/KIS Return: CourseLocation Entity.....	2608
Location Identifier (LOCID).....	2608
UCAS Course Code for the Course (UCASCOURSEID).....	2609
Unistats/KIS Return: HESACourse Entity.....	2610
HESA Course Identifier (HESACOURSEID).....	2611
Reporting Year of HESA Course (HESAYEAR).....	2611
Registering Institution UK Provider Reference Number (REGUKPRN).....	2611
Teaching Institution UK Provider Reference Number (TEACHUKPRN).....	2612
Unistats/KIS Return: ILRAims Entity.....	2613
LAD/LARA Qualification Aim Course Code (ILRAIMID).....	2613
Year of ILR Course (ILRYEAR).....	2613
Registering Institution UK Provider Reference Number (REGUKPRN).....	2614
Teaching Institution UK Provider Reference Number (TEACHUKPRN).....	2614
Chapter 62: (NZL) Generating Government Reports.....	2617
Understanding New Zealand Government Reports.....	2617
Processing SDR Extracts.....	2619
Understanding SDR Processing.....	2619
Page Used to Process Single Data Return Extracts.....	2619
Processing SDR Extracts.....	2620
Suppressing Course Offerings in the Course Enrollment and Course Completion Files.....	2621
Running NZQA Reports.....	2621
Page Used to Run the NZQA Reports.....	2621
Running the NZQA Reports.....	2622
Generating the Graduation Destination Survey Data File.....	2622
Page Used to Generate the Graduation Destination Survey Data File.....	2622
Running the NZVCC SQR.....	2623
Chapter 63: Student Records Reports.....	2625
Student Records Reports: A-Z.....	2625

Preface

Understanding the PeopleSoft Online Help and PeopleBooks

The PeopleSoft Online Help is a website that enables you to view all help content for PeopleSoft applications and PeopleTools. The help provides standard navigation and full-text searching, as well as context-sensitive online help for PeopleSoft users.

Hosted PeopleSoft Online Help

You can access the hosted PeopleSoft Online Help on the [Oracle Help Center](#). The hosted PeopleSoft Online Help is updated on a regular schedule, ensuring that you have access to the most current documentation. This reduces the need to view separate documentation posts for application maintenance on My Oracle Support. The hosted PeopleSoft Online Help is available in English only.

To configure the context-sensitive help for your PeopleSoft applications to use the Oracle Help Center, see [Configuring Context-Sensitive Help Using the Hosted Online Help Website](#).

Locally Installed PeopleSoft Online Help

If you're setting up an on-premises PeopleSoft environment, and your organization has firewall restrictions that prevent you from using the hosted PeopleSoft Online Help, you can install the online help locally. Installable PeopleSoft Online Help is made available with selected PeopleSoft Update Images and with PeopleTools releases for on-premises installations, through the [Oracle Software Delivery Cloud](#).

Your installation documentation includes a chapter with instructions for how to install the online help for your business environment, and the documentation zip file may contain a README.txt file with additional installation instructions. See *PeopleSoft 9.2 Application Installation* for your database platform, "Installing PeopleSoft Online Help."

To configure the context-sensitive help for your PeopleSoft applications to use a locally installed online help website, see [Configuring Context-Sensitive Help Using a Locally Installed Online Help Website](#).

Downloadable PeopleBook PDF Files

You can access downloadable PDF versions of the help content in the traditional PeopleBook format on the [Oracle Help Center](#). The content in the PeopleBook PDFs is the same as the content in the PeopleSoft Online Help, but it has a different structure and it does not include the interactive navigation features that are available in the online help.

Common Help Documentation

Common help documentation contains information that applies to multiple applications. The two main types of common help are:

- Application Fundamentals

- Using PeopleSoft Applications

Most product families provide a set of application fundamentals help topics that discuss essential information about the setup and design of your system. This information applies to many or all applications in the PeopleSoft product family. Whether you are implementing a single application, some combination of applications within the product family, or the entire product family, you should be familiar with the contents of the appropriate application fundamentals help. They provide the starting points for fundamental implementation tasks.

In addition, the *PeopleTools: Applications User's Guide* introduces you to the various elements of the PeopleSoft Pure Internet Architecture. It also explains how to use the navigational hierarchy, components, and pages to perform basic functions as you navigate through the system. While your application or implementation may differ, the topics in this user's guide provide general information about using PeopleSoft applications.

Field and Control Definitions

PeopleSoft documentation includes definitions for most fields and controls that appear on application pages. These definitions describe how to use a field or control, where populated values come from, the effects of selecting certain values, and so on. If a field or control is not defined, then it either requires no additional explanation or is documented in a common elements section earlier in the documentation. For example, the Date field rarely requires additional explanation and may not be defined in the documentation for some pages.

Typographical Conventions

The following table describes the typographical conventions that are used in the online help.

<i>Typographical Convention</i>	<i>Description</i>
Key+Key	Indicates a key combination action. For example, a plus sign (+) between keys means that you must hold down the first key while you press the second key. For Alt+W , hold down the Alt key while you press the W key.
... (ellipses)	Indicate that the preceding item or series can be repeated any number of times in PeopleCode syntax.
{ } (curly braces)	Indicate a choice between two options in PeopleCode syntax. Options are separated by a pipe ().
[] (square brackets)	Indicate optional items in PeopleCode syntax.
& (ampersand)	When placed before a parameter in PeopleCode syntax, an ampersand indicates that the parameter is an already instantiated object. Ampersands also precede all PeopleCode variables.

Typographical Convention	Description
⇒	This continuation character has been inserted at the end of a line of code that has been wrapped at the page margin. The code should be viewed or entered as a single, continuous line of code without the continuation character.

ISO Country and Currency Codes

PeopleSoft Online Help topics use International Organization for Standardization (ISO) country and currency codes to identify country-specific information and monetary amounts.

ISO country codes may appear as country identifiers, and ISO currency codes may appear as currency identifiers in your PeopleSoft documentation. Reference to an ISO country code in your documentation does not imply that your application includes every ISO country code. The following example is a country-specific heading: "(FRA) Hiring an Employee."

The PeopleSoft Currency Code table (CURRENCY_CD_TBL) contains sample currency code data. The Currency Code table is based on ISO Standard 4217, "Codes for the representation of currencies," and also relies on ISO country codes in the Country table (COUNTRY_TBL). The navigation to the pages where you maintain currency code and country information depends on which PeopleSoft applications you are using. To access the pages for maintaining the Currency Code and Country tables, consult the online help for your applications for more information.

Region and Industry Identifiers

Information that applies only to a specific region or industry is preceded by a standard identifier in parentheses. This identifier typically appears at the beginning of a section heading, but it may also appear at the beginning of a note or other text.

Example of a region-specific heading: "(Latin America) Setting Up Depreciation"

Region Identifiers

Regions are identified by the region name. The following region identifiers may appear in the PeopleSoft Online Help:

- Asia Pacific
- Europe
- Latin America
- North America

Industry Identifiers

Industries are identified by the industry name or by an abbreviation for that industry. The following industry identifiers may appear in the PeopleSoft Online Help:

- USF (U.S. Federal)

- E&G (Education and Government)

Translations and Embedded Help

PeopleSoft 9.2 software applications include translated embedded help. With the 9.2 release, PeopleSoft aligns with the other Oracle applications by focusing our translation efforts on embedded help. We are not planning to translate our traditional online help and PeopleBooks documentation. Instead we offer very direct translated help at crucial spots within our application through our embedded help widgets. Additionally, we have a one-to-one mapping of application and help translations, meaning that the software and embedded help translation footprint is identical—something we were never able to accomplish in the past.

Using and Managing the PeopleSoft Online Help

Select About This Help in the left navigation panel on any page in the PeopleSoft Online Help to see information on the following topics:

- Using the PeopleSoft Online Help.
- Managing hosted Online Help.
- Managing locally installed PeopleSoft Online Help.

PeopleSoft CS Related Links

[Hosted Online Help Home](#)

[PeopleSoft Information Portal](#)

[My Oracle Support](#)

Contact Us

Send your suggestions to pssoft-infodev_us@oracle.com.

Please include the applications update image or PeopleTools release that you're using.

Follow Us

<i>Icon</i>	<i>Link</i>
	Watch PeopleSoft on YouTube

Icon	Link
	Follow @PeopleSoft_Info on X.
	Read PeopleSoft Blogs
	Connect with PeopleSoft on LinkedIn

Chapter 1

Getting Started with Student Records

Student Records Overview

Student Records enables you to enter, track, and process all of your academic information. Campus Solutions minimizes repetitive data entry while enabling you to gain maximum control over the records—from the course catalog and schedule of classes to student programs, plans, and subplans.

After applicants are admitted and matriculate, Student Records moves forward to activate, enroll, grade, evaluate, and graduate students. In concert with PeopleSoft Academic Advisement processes, the Student Records application tracks students through graduation.

Student Records Business Processes

We discuss these business processes in the Student Records business process documentation:

- *Repeat Checking*: Enables you to manage students' repeat coursework.
- *Course Catalog*: Enables you to set up courses.
- *Enrollment Requisites*: Enables you to set up requisite groups, equivalencies, and course lists.
- *Schedule of Classes*: Enables you to schedule classes, search for facilities, and roll the schedule from term to term.
- *Instructor Workload*: Enables you to update, track, and report workload hours for individuals.
- *Program Activation and Management*: Enables you to activate students into academic programs and maintain their academic program, plan, and subplan data.
- *Batch Term Activation*: Enables you to activate groups of students into terms.
- *Quick Activation*: Enables you to activate students into academic programs, bypassing the Activate Applications matriculation process (ABPCPPRC) in PeopleSoft Recruiting and Admissions.
- *Student Career Term Record Management*: Enables you to monitor and track student career term related records.
- *Enrollment Appointments*: Enables you to create and manage enrollment appointments.
- *Class Enrollment Transactions*: Enables you to enroll students into classes through various processes.
- *Enrollment Related Processes*: Enables you to enroll perform withdrawals and cancellations, manage wait lists, view summary statistics, and more.

- *Enrollment Verification*: Enables you to process enrollment verification reports for students, and if you have licensed PeopleSoft Learner Services, students can request the enrollment verification through self service.
- *Transfer Credit*: Enables you to evaluate, process, and post course, test, and other transfer credit using defined rules or manual rules.
- *Attendance Tracking*: Enables you to generate attendance rosters and track student attendance.
- *Student Data Tracking*: Enables you to link milestones to student records, manage honors and awards, manage academic standing, track student groups, maintain service indicators, and maintain extracurricular activities.
- *Interoperability for Learning Management Systems*: Give you the ability to provide a third-party learning management system (such as Blackboard CourseInfo) with personal profile data for learners and instructors, including enrollment data and maintenance, and limited course scheduling data maintenance.
- *Grading*: Enables you to generate grade rosters, enter grades and reviews, the midterm deficiency report, and the grade lapse process.
- *Graduation*: Gives you the ability to define degrees and honors, run the graduation reporting process, and graduate students.
- *Transcripts*: Gives you the ability to set up transcript data, define a transcript request, and produce transcripts.
- *Academic Statistics Consolidation and Reporting*: Enables you to prepare the system to consolidate academic statistics for students, to run processes that consolidate academic statistics, to make use of the consolidated statistics after processing them.
- (CAN) *Canadian Government Reporting*: Enables users with an installation country of Canada to generate reports for federal and provincial agencies.

Student Records Integrations

The following diagram illustrates the Campus Solutions applications that work with Student Records:

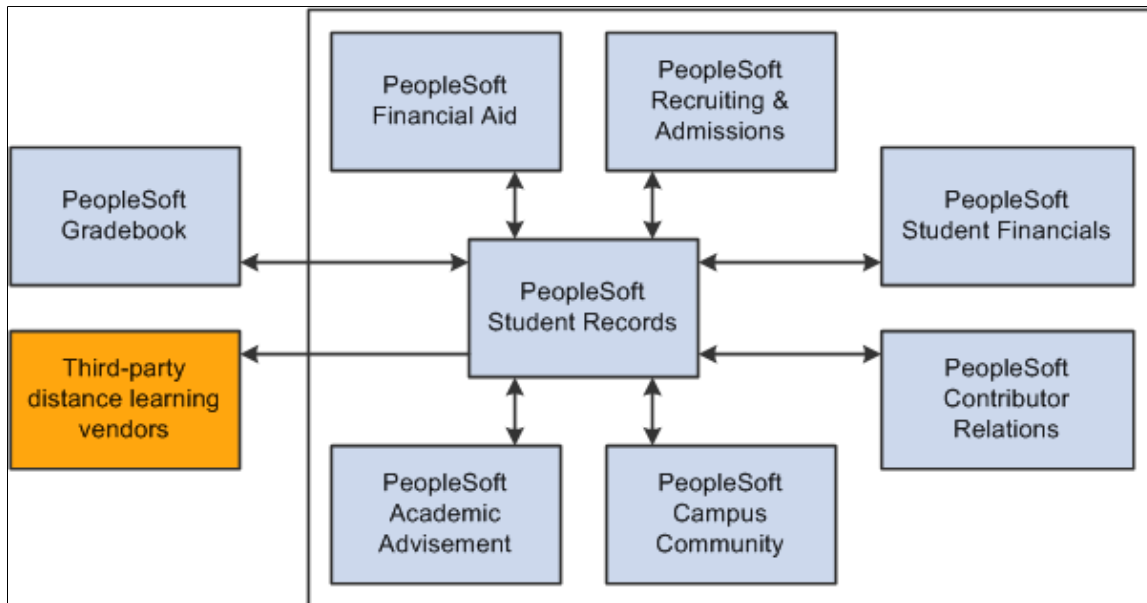

We discuss integration considerations in the Student Records implementation topics.

Supplemental information about third-party application integrations is located on the My Oracle Support website.

Student Records Implementation

Student Records also provides component interfaces to help you load data from your existing system into Student Records tables. Use the Excel to Component Interface utility with the component interfaces to populate the tables.

This table lists all of the components that have setup component interfaces:

Component	Component Interfaces	References
ACAD_CALENDER_TBL	SSR_ACAD_CALENDAR_TBL	See “Defining Traditional Academic Calendars” (Campus Solutions Application Fundamentals).
CIP_CODE_TABLE	SSR_CIP_CODE_TABLE	See “Modifying CIP and HEGIS Codes” (Campus Solutions Application Fundamentals).
HEGIS_CODE_TABLE	SSR_HEGIS_CODE_TABLE	As above.

Other Sources of Information

In the planning phase of your implementation, take advantage of all Oracle PeopleSoft sources of information, including the installation guides, data models, business process maps, and troubleshooting guidelines.

See *PeopleTools: Component Interfaces*

See *PeopleTools: Setup Manager*

Additional Information for Getting Started with Student Records

Additional, essential information describing the setup and design of your system appears in two companion volumes of documentation: Campus Solutions Application Fundamentals documentation and Campus Community Fundamentals documentation.

See Campus Solutions Application Fundamentals

See Campus Community Fundamentals

For information about deferred processing, see “Additional Information for Getting Started with Campus Solutions” (Campus Solutions Application Fundamentals).

Chapter 2

Defining Student Records Installation Settings

Reviewing or Defining Student Records Installation Settings

To review or define Student Records installation settings, use the Student Records Installation component (SSR_INSTALLATION). The following topics discuss:

- How to review or define Student Records default installation settings.
- How to review or define Enrollment Requirement Roster default installation settings.
- How to review or define Enrollment Requirement Processing default installation settings.

Pages Used to Review or Define Student Records Installation Settings

<i>Page Name</i>	<i>Definition Name</i>	<i>Navigation</i>	<i>Usage</i>
Student Records Installation	SSR_INSTALLATION	Set Up SACR > Install > Student Records Installation > Student Records Installation	Review or define Student Records default installation settings for general options, class searches, and enrollment requirement / requisite checking.
Enrollment Requirement Roster	SSR_INSTALLATION2	Set Up SACR > Install > Student Records Installation > Enrollment Requirement Roster	Review or define default installation settings for the enrollment requirement roster.
Enrollment Requirement Processing	SSR_INSTALLATION3	Set Up SACR > Install > Student Records Installation > Enrollment Requirement Processing	Review or define default installation settings for enrollment requirement processing.

Reviewing or Defining Default Installation Settings

Access the Student Records Installation page (**Set Up SACR > Install > Student Records Installation**).

This example illustrates the fields and controls on the Student Records Installation page. You can find definitions for the fields and controls later on this page.

Student Records Installation	Enrl Requirement Roster	Enrl Requirement Processing
-------------------------------------	-------------------------	-----------------------------

Student Records Installation

Defaults & Options

Use SR Class Schedule Facility Conflict Checking

Default Section Size

Transcript Date Print

GPA Rounding/Truncating Option

Class Search

Class Search Results Limits

Warning Limit rows

Error Limit rows

Class Search Subject Option

Drop-Down List Box Prompt Search

Enrollment Requisite Checking

Validate Conditions Using:

Max Program Effdt for Term

Action Date

When Enrollment Requirement Status is Conditionally Satisfied

Return a warning message

Success

New Features

Fluid Self Service

Defaults & Options

Field or Control	Description
Use SR Class Schedule Facility Conflict Checking	<p>Select to enable facility conflict checking when scheduling classes. The check box value migrates from the Installation page to the Academic Institution 2 page to the Campus Table page. The system uses the value on the Campus Table page during processing. Clear this check box on the Campus Table page to use an external facility conflict checking process.</p> <hr/> <p>Note: This check box has no relation to the Check for Facility Conflict check box on the Facility Table page, which controls whether you can schedule multiple events in the same facility.</p>
Default Section Size	<p>Enter a number to use as a default for class size. This value is used in the creation of new class sections. The value is originally rolled into the Catalog record when it is created, and then it is used to enter the number by default into the ENRL_CAP field in the CLASS_TBL.</p>
Transcript Date Print	<p>Select the date on which you want the system to print when printing student transcripts. Select a value to be the default value when a row is entered. Select one value per term. Values are:</p> <p><i>Print Class Dates:</i> Prints the valid start and end dates for each class on a transcript.</p> <p><i>Print Session Dates:</i> Prints the valid start and end dates for a session within a term on a transcript.</p> <p><i>Print Term Dates:</i> Prints the valid start and end dates for the term on a transcript.</p> <p><i>Do Not Print Any Dates:</i> No dates print on the transcript.</p>
GPA Rounding/Truncating Option (grade point average rounding/truncating option)	<p>Enter a value to indicate the number of decimal places to which you want to round or truncate the grade point average displayed for a student throughout the system. The maximum allowed is three decimal places.</p>

Class Search

Field or Control	Description
Class Search Results Limits	<p>Enter a value in the Warning Limit and Error Limit fields to indicate the number of classes for the system to display when a student searches for a class.</p> <ul style="list-style-type: none"> • Warning Limit: When the limit is reached, the student receives a Warning message. The student can continue to the search results or cancel and add additional criteria to narrow the search. • Error Limit: When the limit is reached, the student receives an Error message requesting that the student specify additional search criteria.
Class Search Subject Option	<p>Select to indicate whether the Course Subject field on the Search for Classes page appears as a drop-down list box or as a select subject button.</p> <hr/> <p>Note: Regardless of the option setting, the Course Subject field dynamically changes to a select subject button if the selected institution has more than 300 course subjects.</p> <hr/>

Enrollment Requisite Checking

Use this group box to select how the requisite checking process validates programs, plans, and subplans for requisites that specify program, plan, or subplan conditions—for example, if a student enrolls in a class for a term and the class has a requisite condition of Plan = BIOCHEM, what is the maximum effective date that a plan of BIOCHEM can have to meet the requisite for that term.

Validate Conditions Using:

Field or Control	Description
<p>Max Prog Effdt for Term (maximum program effective date for term)</p>	<p>This option is selected by default.</p> <p>The requisite checking process uses the following logic to establish if a student meets program, plan, or subplan conditions:</p> <ul style="list-style-type: none"> • If the enrollment action date is before or equal to the term begin date, use the term begin date to determine the program, plan, or subplan: Find the maximum effective-dated row, where the effective date is before or equal to the term begin date. <p>For example, on 05/30/07 a student tries to enroll in a Fall 2007 class that has a requisite condition of the LAU program. Fall 2007 commences on 08/30/07. The student's current program is FAU (with an effective date of 01/01/06), but the student has a future-dated program change of 07/01/07 for the LAU program. The student meets the requisite condition because the maximum effective-dated program row (which is before or equal to the term begin date) is for the LAU program.</p> <ul style="list-style-type: none"> • If the enrollment action date is after the term begin date and before or equal to the maximum program effective date for Term, use the action date to determine the program, plan, and subplan: Find the maximum effective-dated row where the effective date is before or equal to the enrollment action date. <p>For example, on 09/05/07, a student tries to enroll in a Fall 2007 class that has a requisite condition of the LAU program. The student transferred to the LAU program effective 09/02/07. Fall 2007 commences on 08/30/2007 but has a maximum effective for term of 09/14/07. The student therefore meets the requisite condition.</p> <ul style="list-style-type: none"> • If the enrollment action date is after the maximum program effective date for term, use the maximum program effective date for term to determine the program, plan, or subplan: Find the maximum effective-dated row where the effective date is before or equal to the maximum program effective date for term. <p>For example, on 09/17/07, a student tries to enroll in a Fall 2007 class that has a requisite condition of the LAU program. Fall 2007 commences on 08/30/07 but has a maximum program effective date for term of 09/14/07. The student transferred to the LAU program effective 09/15/07. The student does not meet the requisite condition, because FAU, not LAU is the program for</p>

Field or Control	Description
	which the maximum effective date is before or equal to the maximum effective date for term.
Action Date	<p>The requisite checking process uses the enrollment action date instead of the maximum program effective date for term when the term begin date is reached:</p> <ul style="list-style-type: none"> • If the enrollment action date is before or equal to the term begin date, the process uses the same logic as when the Max Program Effdt for Term option is selected. • If the enrollment action date is after the term begin date, use the enrollment action date to determine program, plan, or subplan: Find the maximum effective-date row where the effective date is before or equal to the enrollment action date. <p>For example, on 09/17/07, a student tries to enroll in a Fall 2007 class that has a requisite condition of the LAU program. Fall 2007 commences on 08/30/07 but has a maximum program effective date for term of 09/14/07. The student transferred to the LAU program effective 09/15/07. The student meets the requisite condition because LAU is the program for which the maximum effective date row is before or equal to the enrollment action date.</p>

When Enrollment Requirement Status is Conditionally Satisfied:

Field or Control	Description
Return a warning message	When requisite checking uses in-progress courses to satisfy an enrollment requirement, the user receives a warning message indicating that the prerequisite has been met conditionally and that the prerequisite must be satisfied prior to the start of the class.
Success	This option is selected by default. When requisite checking uses in-progress courses to satisfy an enrollment requirement, a message of success is returned.

See [Understanding Enrollment Requisite Setup and Maintenance](#)

New Features

<i>Field or Control</i>	<i>Description</i>
Fluid Self Service	<p>Select this check box together with the check boxes Track Admin Changes to Classes (on the Class Search Setup page) and Track Admin Changes to Courses (on the Browse Course Catalog Options page) to automatically track changes to courses and classes. These are used to determine what appears in class search and the course catalog in Fluid user interface.</p> <p>See:</p> <ul style="list-style-type: none"> • “Setting Up Class Search and Enrollment for Fluid User Interface” (Campus Self Service) • “Configuring Display Settings for the Course Catalog in PeopleSoft Fluid User Interface” (Campus Self Service)

Related Links

“Understanding PeopleSoft Fluid User Interface Homepages” (Campus Solutions Application Fundamentals)

“Setting Up Self-Service Features for Student Records” (Campus Self Service)

“Configuring Search Options in PeopleSoft Fluid User Interface” (Campus Self Service)

Reviewing or Defining Enrollment Requirement Roster Default Installation Settings

The Post Enrollment Requirement Checking feature:

- Provides the ability to capture the status of the enrollment requirement check at the time of enrollment (satisfied, conditionally satisfied, overridden, permitted, enrollment component). Enrollments that do not satisfy the requirement are rejected. The feature captures the status for both enrolled and wait listed students.
- Provides the ability for users to re-run the Enrollment Requirement Checking process (where the Enrollment Engine calls Academic Advisement for enrollment requirement evaluation) on enrolled and wait listed classes after in-progress grades have been posted. The capability is delivered in on-line/remote call mode as well as a batch process.
- Includes an administrative component that allows decision makers to identify and view students who are in non-compliance of class enrollment requirements.
- Includes functionality to identify and process students that need to be dropped from classes for non-compliance as a result of post-enrollment requirement checking.
- Through the use of communications, includes functionality to notify students when they have been administratively dropped from a class for non-compliance.

If you plan to use communications for post enrollment requirement checking, use the instructions in the following document to set up communications and then use the 3Cs process to create and generate the communication, see *PERC Communications Setup and Processing* in My Oracle Support (ID 1982691.1).

- Includes a batch process to generate reports of students in non-compliance of enrollment requirements.

Access the Enrollment Requirement Roster page (**Set Up SACR > Install > Student Records Installation > Enrollment Requirement Roster**).

This example illustrates the fields and controls on the Enrollment Requirement Roster page. You can find definitions for the fields and controls later on this page.

Student Records Installation	Enrl Requirement Roster	Enrl Requirement Processing
Enrollment Requirement Roster		
Collapsible Area Defaults		
<input type="checkbox"/> Collapse Course Information group box <input type="checkbox"/> Collapse Enrollment Requirement group box <input type="checkbox"/> Collapse Filter group box		
Roster and Batch Processing Filter Default Settings		
Enrollment Status		
Display <input checked="" type="checkbox"/> Enrolled <input checked="" type="checkbox"/> Waitlisted <input type="checkbox"/> Dropped		
Most Recent Requirement Status		
Display students in non-compliance		
<input checked="" type="checkbox"/> Not Satisfied <input checked="" type="checkbox"/> Conditionally Satisfied		
Display other students		
<input type="checkbox"/> Enrollment Component <input type="checkbox"/> Overridden <input type="checkbox"/> Permitted <input type="checkbox"/> Satisfied <input type="checkbox"/> Unknown		
Drop Review for Batch Processing		
<input checked="" type="checkbox"/> Enrollment Requirement Rosters must be reviewed prior to batch processing of drops		
Enrollment Action Reason		
When a student is dropped for non-compliance of enrollment requirements, set Drop Action Reason to:		
<input type="text" value="PERC"/>		
Additional Student Information for Decision Makers		
<input checked="" type="checkbox"/> Provide link to student Course History		
<input checked="" type="checkbox"/> Provide link to Student Statistics		
<input checked="" type="radio"/> Academics page from Student Services Center <input type="radio"/> Administrative Term History page		
Security		
<input type="checkbox"/> Enforce Academic Organization Security		
Notes		
<input type="checkbox"/> Enable notes to be deleted		

Find documentation about the pages that are used to run Post Enrollment Requirement Checking—the Enrollment Requirement Roster page and the Run Post Enrollment Requirement Checking page—in the Post Enrollment Requirement Checking topics.

Collapsible Area Defaults

<i>Field or Control</i>	<i>Description</i>
Collapse Course Information group box, Collapse Enrollment Requirement group box, and Collapse Filter group box	<p>Clear these check boxes if you want course information, enrollment requirement description, and enrollment requirement roster filter to appear expanded by default on the Enrollment Requirement Roster. Select if you want the fields to appear collapsed.</p> <p>Regardless of this setup, you can expand and collapse the fields on the Enrollment Requirement Roster.</p>

Roster and Batch Processing Filter Default Settings

<i>Field or Control</i>	<i>Description</i>
Enrollment Status	Select the enrollment statuses that you want to appear by default in the Set Filter Options group box on the Enrollment Requirement Roster. You can override the values on that page.
Most Recent Requirement Status: Display Students in non-compliance	Select the enrollment requirement non-compliance statuses that you want to appear by default on the Enrollment Requirement Roster. You can override the values on that page.
Most Recent Requirement Status: Display other students	Select any additional enrollment requirement statuses you want to appear by default on the Enrollment Requirement Roster. You can override the values on that page.

Drop Review for Batch Processing

<i>Field or Control</i>	<i>Description</i>
Enrollment Requirement Rosters must be reviewed prior to batch processing of drops	<p>Select this check box to ensure that an enrollment requirement roster is set to <i>Review Complete</i> before batch drop processing occurs. The Review Complete for Batch Drop Processing check box appears on the Enrollment Requirement Roster and the following message appears on the Process Drop Requests for Post Enrollment Requirements batch processing page: <i>Drops are only processed for classes where Drop Review is set to Complete.</i></p> <p>Clear this check box if you do not use batch processing of drops or if you do not want to ensure that the enrollment requirement roster is reviewed before batch dropping students for non-compliance. The Review Complete for Batch Drop Processing check box is not available on the Enrollment Requirement Roster and the message does not appear on the batch drop processing page.</p>

Enrollment Action Reason

<i>Field or Control</i>	<i>Description</i>
When a student is dropped for non-compliance of enrollment requirements, set Drop Action Reason to	<p>Define a default drop action reason code value to be used when a student is dropped for non-compliance of enrollment requirements. The value action reason code of <i>PERC</i> is delivered but can be changed. The value should be unique.</p> <p>When a class is dropped using the action reason code of <i>PERC</i>, the enrollment record is retained regardless of the Academic Calendar date for the drop delete deadline.</p>

Additional Student Information for Decision Makers

<i>Field or Control</i>	<i>Description</i>
Provide link to student Course History	<p>Select this check box to allow decision makers and other users to access student course history from a link on the Enrollment Requirement Roster (the Course History link on the Audit / Information Links tab). Clear the check box to hide the Course History link.</p>

<i>Field or Control</i>	<i>Description</i>
Provide link to Student Statistics	Select this check box to allow decision makers and other users to access student academic statistics from a link on the Enrollment Requirement Roster (the Statistics link on the Audit / Information Links tab). Select an option to identify whether the user links to the Academics page (recommended) as used in the Student Services Center or the Administrative Term History page. Clear the check box to hide the Statistics link.

Security

<i>Field or Control</i>	<i>Description</i>
Enforce Academic Organization Security	Select this check box to enforce academic organization security within the Enrollment Requirement Roster and related processing.

Notes

<i>Field or Control</i>	<i>Description</i>
Enable notes to be deleted	Select this check box to enable notes to be deleted from the Enrollment Requirement Roster: Tracking of Key Transactions & User Notes page. Clear to prevent notes from being deleted.

Reviewing or Defining Enrollment Requirement Processing Default Installation Settings

Find documentation about the pages that are used to run Post Enrollment Requirement Checking—the Enrollment Requirement Roster page and the Run Post Enrollment Requirement Checking page—in the Post Enrollment Requirement Checking topics.

Access the Enrollment Requirement Processing page ((**Set Up SACR > Install > Student Records Installation > Enrollment Requirement Processing**)).

This example illustrates the fields and controls on the Enrollment Requirement Processing page (1 of 2). You can find definitions for the fields and controls later on this page.

Student Records Installation	Enrl Requirement Roster	Enrl Requirement Processing
Enrollment Requirement Processing		
Page Processing		
Run Post Enrollment Requirement Checking		
<input checked="" type="checkbox"/> Allow Post Enrollment Requirement Checking to be run from Enrollment Requirement Roster		
<input checked="" type="checkbox"/> Allow Drop Request Indicator to be set for Students in Non-Compliance		
Default to:		
<input type="checkbox"/> If process results in a status of Conditionally Satisfied		
<input type="checkbox"/> If process results in a status of Not Satisfied		
Process Drops for Non-Compliance		
<input checked="" type="checkbox"/> Allow Drop Processing to be run from Enrollment Requirement Roster		
Default drop process to:		
For students listed above, process drops for:		
<input checked="" type="radio"/> selected students		
<input type="radio"/> students where Drop Request Indicator is selected		
<input type="radio"/> students with a post enrollment requirement status of:		
<input type="checkbox"/> Conditionally Satisfied		
<input type="checkbox"/> Not Satisfied		
<input checked="" type="checkbox"/> Allow Override of Action Date		
Processing Limit		
Return Warning Message when processing more than <input type="text" value="15"/> students at a time		
Error Message - Limit page processing to a maximum of <input type="text" value="20"/> students at a time		

This example illustrates the fields and controls on the Enrollment Requirement Processing page (2 of 2). You can find definitions for the fields and controls later on this page.

Batch Processing

Run Post Enrollment Requirement Checking

Allow Drop Request Indicator to be set for Students in Non-Compliance
 Default to:

- If process results in a status of Conditionally Satisfied
- If process results in a status of Not Satisfied

Process Drops for Non-Compliance

Default Non-Compliance Selection To:
 Process Drops for:

- students where Drop Request Indicator is selected
- students with a post enrollment requirement status of:
 - Conditionally Satisfied
 - Not Satisfied

 Allow Override of Action Date

Communication Category Default

PERC Processing

Use the Page Processing group box to select the information and values that you want to appear by default on the Enrollment Requirement Roster.

Page Processing: Run Post Enrollment Requirement Checking

<i>Field or Control</i>	<i>Description</i>
Allow Post Enrollment Requirement Checking to be run from Enrollment Requirement Roster	Select this check box to allow users to run post enrollment requirement checking from the Enrollment Requirement Roster. If selected, the Run Post Enrollment Requirement Checking group box appears on the roster. If cleared, the group box is not available—users would instead run batch post enrollment requirement checking.

Field or Control	Description
Allow Drop Request Indicator to be set for Students in Non-Compliance	If post enrollment requirement checking is enabled, select this check box to allow the Drop Request Indicator to be set from the Enrollment Requirement Roster processing page. If the check box is selected, the Set Drop Request for Students in Non-Compliance options appear in the Run Post Enrollment Requirement Checking group box on the roster. If the check box is cleared, the options are hidden.
Default to: If process results in a status of Conditionally Satisfied and Default to: If process results in a status of Not Satisfied	<p>If you have selected the Allow Drop Request Indicator to be set for Students in Non-Compliance check box, use these check boxes to set the status default settings—Conditionally Satisfied and Not Satisfied—on the Enrollment Requirement Roster.</p> <p>You can override the values on the Enrollment Requirement Roster.</p>

Page Processing: Process Drops for Non-Compliance

The check boxes and values that are selected here appear by default on the Enrollment Requirement Roster but can be overridden on that page.

Field or Control	Description
Allow Drop Processing to be run from Enrollment Requirement Roster	Select this check box to allow users to run drop processing from the Enrollment Requirement Roster. If selected, the Process Drops for Non-Compliance group box appears on the roster page. If cleared, the group box is not available—users would instead run batch drop processing.
Default drop process to:	<p>If drop processing is enabled from the Enrollment Requirement Roster, define the default selection to:</p> <ul style="list-style-type: none"> • selected students: The drop process is run only for selected students. • students where Drop Request Indicator is selected: The drop process is run only for students for whom the Drop Request Indicator value is selected. • students with a post enrollment requirement status of: The drop process is run only for students with a post enrollment requirement status of either <i>Conditionally Satisfied</i> or <i>Not Satisfied</i>. When this option is selected, the Conditionally Satisfied and Not Satisfied check boxes become available for selection.

<i>Field or Control</i>	<i>Description</i>
Allow Override of Action Date	If drop processing is enabled from the Enrollment Requirement Roster, select this check box to allow a user to override the action date: the Override Action Date check box is available on the Enrollment Requirement Roster. The user must have enrollment security to override the action date.

Page Processing: Processing Limit

<i>Field or Control</i>	<i>Description</i>
Return Warning Message when processing more than	Set the maximum number of students that can be selected for page processing before receiving a warning message. Our recommendation for a warning message is for 15 students—you therefore receive a warning message when 16 students or more are selected.
Error Message - Limit page processing to a maximum of	Set the maximum number of students that can be selected for page processing before receiving an error message. To assist with response time, use batch Post Enrollment Requirement Checking processing for large numbers of students. Our recommendation for an error message is for 20 students—you therefore receive an error message if 21 or more students are selected.

Batch Processing: Run Post Enrollment Requirement Checking

<i>Field or Control</i>	<i>Description</i>
Allow Drop Request Indicator to be set for Students in Non-Compliance	Select this check box to allow the Post Enrollment Requirement Checking batch process to set the Drop Request Indicator for a student when the process results in a non-compliant status. If you select this check box, the Action group box which contains the Set Drop Request Indicator for Students in Non-Compliance options is available on the Run Post Enrollment Requirement Checking page.
Default to: If process results in a status of Conditionally Satisfied and Default to: If process results in a status of Not Satisfied	Use these check boxes to set the status default settings on the Run Post Enrollment Requirement Checking page: Conditionally Satisfied status and/or Not Satisfied. You can override the values on the batch processing page.

Batch Processing: Process Drops for Non-Compliance

<i>Field or Control</i>	<i>Description</i>
Default Non-Compliance Selection To	Process administrative student drops for students who are non-compliant with class enrollment requirements.
Process Drops for	<p>Set the default options that you want to appear in the Non-Compliance Selection group box on the Process Drop Requests for Post Enrollment Requirement page:</p> <ul style="list-style-type: none"> • students where Drop Request Indicator is selected: the process drops only students for whom the drop request indicator is selected. • students with a post enrollment requirement status of: When this option is selected, the Conditionally Satisfied and Not Satisfied check boxes become available for selection. The process drops only students that have a non-compliant post enrollment requirement status that matches the check box selection.
Allow Override of Action Date	Select this check box to allow a user to override the action date for Process Drop requests: the Override Action Date check box is available on the Process Drop Requests for Post Enrollment Requirement page. The user must have enrollment security to override the action date.

See [Managing the Enrollment Requirement Roster](#)

Communication Category Default

This value default is used when creating communications for PERC. A value of *PERC* is delivered but can be changed. The value should be unique.

See “Defining a Communication Category” (Campus Community Fundamentals).

If you plan to use communications for post enrollment requirement checking, use the instructions in the following document to set up communications and then use the 3Cs process to create and generate the communication:

See: PERC Communications Setup and Processing.pdf in My Oracle Support (ID 1982691).

Chapter 3

Preparing for the Course Catalog and Schedule of Classes

Setting Up Catalog and Schedule Options

When you first create or update the course catalog and schedule of classes, the system prompts you for various types of optional course and class data. This section discusses how to:

- Define class notes.
- Define global notes.
- Define course attributes.
- Define when a course is typically offered.
- Define exam codes.
- Define course material types.
- Define course material type order.

Pages Used to Set Up Catalog and Schedule Options

<i>Page Name</i>	<i>Definition Name</i>	<i>Navigation</i>	<i>Usage</i>
Class Notes Table	CLASS_NOTES_TBL	Curriculum Management > Schedule of Classes > Class Notes Table > Class Notes Table	Define class notes.
Global Notes Table	GLOBAL_NOTES_TBL	Curriculum Management > Schedule of Classes > Global Notes Table > Global Notes Table	Define global notes.
Course Attributes	CRSE_ATTR_TBL	Set Up SACR > Product Related > Student Records > Curriculum Management > Course Attributes > Course Attributes	Define course attributes and attribute values.

Page Name	Definition Name	Navigation	Usage
Course Typically Offered	SSR_CRSE_TYP_OFFER	Set Up SACR > Product Related > Student Records > Curriculum Management > Course Typically Offered	Define when a course is typically offered.
Exam Code Table	EXAM_CODE	Curriculum Management > Schedule of Classes > Exam Code Table > Exam Code Table	Define exam time codes for different types of examinations.
Course Material Type	SSR_CRSE_MAT_TBL	Set Up SACR > Product Related > Student Records > Curriculum Management > Course Material Type > Course Material Type	Define course material types.
Course Material Type Order	SSR_CRSE_MAT_ORD	Set Up SACR > Product Related > Student Records > Curriculum Management > Course Material Type Order > Course Material Type Order	Organize course material to be displayed in a specific order.

Defining Class Notes

Access the Class Notes Table page (**Curriculum Management > Schedule of Classes > Class Notes Table > Class Notes Table**).

Note: Class notes differ from global notes in that class notes are attached to classes on the Notes page, whereas global notes are attached to entire academic subject areas or academic groups.

Field or Control	Description
Effective Date	Enter an effective date for the class note. The effective date determines when the status that you select is valid.
Status	Select a status for the class note. Select <i>Active</i> when adding a new class note. Select <i>Inactive</i> if your institution no longer uses this class note.
Description	In the Description field, enter a short, informative description for the note. This is used for internal processes only.

Field or Control	Description
Long Description	<p>In the Long Description field, enter a detailed description for the note.</p> <p>This text appears in the schedule of classes if you assign this note to a class on the Notes page.</p>

Defining Global Notes

Access the Global Notes Table page (**Curriculum Management > Schedule of Classes > Global Notes Table > Global Notes Table**).

Note: You always associate global notes with an academic institution, academic group, and term. You can further associate global notes with a subject area. If you do not specify a subject area, the global note appears on the top of every corresponding schedule of classes page, before or after the academic group or subject area.

Field or Control	Description
Print Location	Indicates whether the note text appears on the schedule of classes report before or after the subject area (if you specify a subject area), or whether the note text appears before or after the academic group for the term (if you do not specify a subject area). Available values are <i>Print After</i> and <i>Print Before</i> . You should not change these values because doing so requires a substantial programming effort.
Description	Enter a short description for the global note.
Long Description	<p>Enter a detailed description for the global note.</p> <p>This text appears on the schedule of classes report in the location that you specify.</p>

Defining Course Attributes

Access the Course Attributes page (**Set Up SACR > Product Related > Student Records > Curriculum Management > Course Attributes > Course Attributes**).

This example illustrates the fields and controls on the Course Attributes page. You can find definitions for the fields and controls later on this page.

Course Attributes

Course Attribute: HON

Find | View All First 1 of 1 Last

*Effective Date: *Status:

*Description:

Short Description: Show In Class Search

Find | View All First 1-2 of 2 Last

*Course Attribute Value: Catalog Print Schedule Print

*Description: Show In Class Search

*Formal Description:

*Course Attribute Value: Catalog Print Schedule Print

*Description: Show In Class Search

*Formal Description:

Note: Use course attributes for institutional research purposes and to print repetitive text in the schedule of classes or course catalog, such as *Offered in Fall Only*. Course attributes are attached to courses on the Catalog Data page and to classes on the Basic Data page. Unlike requirement designations, course attributes do not transfer to PeopleSoft Academic Advisement.

Field or Control	Description
Status	Select a status for this course attribute. Select <i>Active</i> when adding a new course attribute. Select <i>Inactive</i> if your institution no longer uses this attribute and any of the corresponding attribute values.
Description	The description that you enter here appears on the schedule of classes report or the course catalog report if you select the Schedule Print check box or the Catalog Print check box.
Course Attribute Value	When you attach attributes to courses and classes, you can also specify attribute values. Therefore, you can define parent course attributes that have one or more attribute values. Insert rows to create multiple attribute values.

Field or Control	Description
Catalog Print	<p>Select to display the course attribute formal description in the course catalog report.</p> <hr/> <p>Note: The SSR_COURSE (Course Catalog) web service is one of a number of delivered Enrollment Web Services. The service operation SSR_GET_COURSES: Browse Course Catalog Summary obeys the Catalog Print setup that you select on the Course Attributes page and on the Requirement Designation Table page.</p> <hr/> <p>For detailed information about Enrollment Web Services, see <i>Enrollment Web Services Developers Guide</i> and <i>Enrollment Web Services Users Guide</i> in My Oracle Support (ID 1371391.1).</p>
Schedule Print	Select to display the course attribute formal description in the schedule of classes report.
Show in Class Search	<p>If this check box is selected for a Course Attribute and the Class Search Profile (for example, STDNT) includes a search criteria of Course Attribute, then a student can search by the Course Attribute in Self Service.</p> <p>If this check box is selected for a Course Attribute Value, the Class Search Profile (for example, STDNT) includes a search criteria of Course Attribute, <i>and</i> the Include Course Attribute Value check box is selected for the profile, then a student can search by the Course Attribute Value in Self Service.</p> <p>See Setting Up Class Search Profiles</p> <p>See “Searching for Classes Using Classic Self-Service Pages” (Campus Self Service)</p> <p>See Searching for Classes</p>
Description	Enter a description of the attribute values.
Formal Description	Enter the text that you want to appear on the schedule of classes report or the course catalog report if you select the Schedule Print check box or the Catalog Print check box.

Defining When a Course is Typically Offered

The values that you define here are available in the Course Typically Offered field on the Offerings page of the Course Catalog component.

Related Links

[Creating Course Offerings](#)

Defining Exam Codes

Access the Exam Code Table page (**Curriculum Management > Schedule of Classes > Exam Code Table > Exam Code Table**).

This example illustrates the fields and controls on the Exam Code Table page. You can find definitions for the fields and controls later on this page.

Exam Code Table

Academic Institution: PSUNV PeopleSoft University
Term: 0310 1998 Spring
Session: 1 Regular Academic Session

*Exam Time Code	*Exam Date	*Exam Starting Time	*Exam Ending Time	Exam Type	Class Start Time From	Class Start Time To	M	T	W	T	F	S	S		
MWVFAM	05/20/1998	8:00AM	11:00AM	Final	8:00AM	12:10PM	<input checked="" type="checkbox"/>	<input type="checkbox"/>	<input checked="" type="checkbox"/>	<input type="checkbox"/>	<input checked="" type="checkbox"/>	<input type="checkbox"/>	<input type="checkbox"/>	<input type="checkbox"/>	<input type="checkbox"/>
MWVFPM	05/20/1998	12:30PM	4:30PM	Final	12:15PM	2:05PM	<input checked="" type="checkbox"/>	<input type="checkbox"/>	<input checked="" type="checkbox"/>	<input type="checkbox"/>	<input checked="" type="checkbox"/>	<input type="checkbox"/>	<input type="checkbox"/>	<input type="checkbox"/>	<input type="checkbox"/>
TRAM	05/19/1998	8:00AM	11:00AM	Final	8:00AM	12:10PM	<input type="checkbox"/>	<input checked="" type="checkbox"/>	<input type="checkbox"/>	<input checked="" type="checkbox"/>	<input type="checkbox"/>	<input type="checkbox"/>	<input type="checkbox"/>	<input type="checkbox"/>	<input type="checkbox"/>
TRPM	05/19/1998	12:30PM	4:30PM	Final	11:01AM	4:00PM	<input type="checkbox"/>	<input checked="" type="checkbox"/>	<input type="checkbox"/>	<input checked="" type="checkbox"/>	<input type="checkbox"/>	<input type="checkbox"/>	<input type="checkbox"/>	<input type="checkbox"/>	<input type="checkbox"/>

Note: Define exam time codes for each term and session. The system uses these codes when you run the exam scheduling process on the Exam Scheduling page. You can also manually post these codes to individual classes.

<i>Field or Control</i>	<i>Description</i>
Exam Time Code	Enter an exam time code to define (in an abbreviated manner) the exam code.
Exam Date	Enter the date for the exam.
Exam Starting Time	Enter the start time of the exam.
Exam Ending Time	Enter the end time of the exam.
Exam Type	Select the exam type. Values for this field are delivered with your system as translate values. You can modify these translate values.
Class Start Time From	Enter the minimum start time for classes with which you want to associate the exam time code. The system uses the value during the exam scheduling process. The system schedules exams for classes that fall within the two start times (and days) that you designate.

Field or Control	Description
Class Start Time To	Enter the maximum start time for classes with which you want to associate the exam code. The system uses the value during the exam scheduling process. The system schedules exams for classes that fall within the two start times (and days) that you designate.
M (Monday), T (Tuesday), W (Wednesday), T (Thursday), F (Friday), S (Saturday), and S (Sunday)	Select the days of classes that you want to associate with the exam code.

Related Links

[Scheduling Examinations](#)

Defining Course Material Types

Access the Course Material Type page (**Set Up SACR > Product Related > Student Records > Curriculum Management > Course Material Type > Course Material Type**).

Field or Control	Description
Status	Select a status for this course material type. Select <i>Active</i> when you add a new course material type. Insert a new effective date and select <i>Inactive</i> if your institution no longer uses this course material type.
Description	The description that you enter here appears in the Textbook Assignment group box on the (Schedule of Classes) Textbook page and is used on the Class Detail page and the Faculty and Student Center Textbook Summary page.

See [Defining Textbooks for Classes](#)

See “Searching for Classes Using Classic Self-Service Pages” (Campus Self Service)

See “Viewing a Class Schedule” (Campus Self Service)

See “Using the Self-Service Faculty Center” (Campus Self Service)

Defining Course Material Type Order

Access the Course Material Type Order page (**Set Up SACR > Product Related > Student Records > Curriculum Management > Course Material Type Order > Course Material Type Order**).

This example illustrates the fields and controls on the Course Material Type Order page. You can find definitions for the fields and controls later on this page.

Course Material Type Order					
	*Display Order	*Course Material Type	Description		
1	10	TEXTBOOK	Textbook		
2	20	ARTICLE	Article		
3	30	OTHER	Other Course Material		

Note: The system uses the display order that you define here to determine the order in which course materials appear on the Class Detail page and on the self-service Faculty and Student Textbook Summary pages. If you do not define a course material display order, the course material appears at the end of the list.

Field or Control	Description
Display Order	Define the order in which you want the course material type to appear on Class Detail page and on the faculty and student Textbook Summary pages.
Course Material Type	Select a value based on the course material type values that you defined on the Course Material Type page.
Description	The description appears by default from the Course Material Type page.

Defining Buildings, Rooms, and Classroom Facilities

To set up facilities, use the Building Table (BLDG_TBL), Room Characteristics Table (ROOM_CHRSTC_TBL), and Facility Table (FACILITY_TBL) components.

During the class scheduling process, you probably need to assign classes to classrooms, and you should set up your classroom facilities in advance. This section discusses how to:

- Define buildings.
- Define room characteristics.
- Define facilities and rooms.
- Define facility components.
- Define facility characteristics.

Pages Used to Define Buildings, Rooms, and Classroom Facilities

<i>Page Name</i>	<i>Definition Name</i>	<i>Navigation</i>	<i>Usage</i>
Building Table	BLDG_TBL	Set Up SACR > Foundation Tables > Facilities > Building Table > Building Table	Define all campus buildings that you might use in class and event scheduling. Building codes that you create here are prompt values on the Facility Table page.
Room Characteristics Table	ROOM_CHRSTC_TBL	Set Up SACR > Foundation Tables > Facilities > Room Characteristics Table > Room Characteristics Table	Define room characteristics, such as types of seating and resources that are available. You attach room characteristics to facilities on the Facility Characteristic page and you can use them when you: <ul style="list-style-type: none"> • Define courses. • Schedule classes. • Plan events. <p>You must enter a numeric room characteristic code from 01 to 96.</p>
Facility Table	FACILITY_TBL	Set Up SACR > Foundation Tables > Facilities > Facility Table > Facility Table	Define facilities and facility components.
Facility Component	FACILITY_COMPONENT	Set Up SACR > Foundation Tables > Facilities > Facility Table > Facility Component	Link components of facilities to parent facilities.
Facility Characteristic	FACILITY_CHRSTC	Set Up SACR > Foundation Tables > Facilities > Facility Table > Facility Characteristic	Define room characteristics and facility blackout times.

Defining Buildings

Access the Building Table page (**Set Up SACR > Foundation Tables > Facilities > Building Table > Building Table**).

Field or Control	Description
Status	Select the status of the building. Select <i>Active</i> when the building is being used on the Facility Table page. Select <i>Inactive</i> when you no longer use the building.
Description	Enter a description of the building.
Short Description	Enter a short description of the building.

Defining Room Characteristics

Access the Room Characteristics Table page (**Set Up SACR > Foundation Tables > Facilities > Room Characteristics Table > Room Characteristics Table**).

Field or Control	Description
Status	Select a status for this room characteristic. Select <i>Active</i> when adding a new room characteristic. Select <i>Inactive</i> only if your institution no longer uses this room characteristic.
Description	Enter a description.
Short Description	Enter a short description.

Defining Facilities and Rooms

Access the Facility Table page (**Set Up SACR > Foundation Tables > Facilities > Facility Table > Facility Table**).

This example illustrates the fields and controls on the Facility Table page. You can find definitions for the fields and controls later on this page.

The screenshot shows a web interface for the 'Facility Table' page. It has three tabs: 'Facility Table', 'Facility Component', and 'Facility Characteristic'. The 'Facility Table' tab is active. At the top right, there are navigation controls: 'Find | View All', 'First', '1 of 1', and 'Last'. The main area contains the following fields and controls:

- SetID:** PSUNV
- Facility ID:** ANGE101
- *Effective Date:** 01/01/1900
- *Status:** Active (dropdown menu)
- *Description:** Angel101
- *Short Description:** Angel101
- *Building:** ANGE (with search icon)
- Room:** 101
- *Location Code:** HACIENDA (with search icon)
- *Facility Type:** Lecture Rm (dropdown menu)
- Academic Organization:** (empty text box)
- Minimum Utilization Percent:** 0
- Facility Group:** (checkbox)
- Capacity:** 50
- Partition:** (empty dropdown menu)
- General Assignment:** (checkbox)
- Check for Facility Conflict:** (checkbox)

As an example, you might want to define Angel Hall Room 125 and its components, Angel 125A, 125B, and 125C. You cannot link components to parent facilities on the Facility Component page unless you first define both the parent facility and the facility components on the Facility Table page.

Field or Control	Description
Status	Select a status for this facility. Select <i>Active</i> when adding a new facility. Select <i>Inactive</i> only if your institution no longer uses this facility.
Facility Group	If this check box is selected and unavailable for entry, the facility is a parent facility with facility components.
Building	Enter the building in which the facility is located. Define buildings on the Building Table page.
Room	Enter the room number.
Capacity	Enter the maximum number of people that a facility accommodates.

Field or Control	Description
Location Code	<p>You can specify locations such as a building cluster on campus or satellite campuses. Define location codes on the Location Address page (Set Up Common Objects > Foundation Tables > Organization > Location Address)</p> <p>See:</p> <ul style="list-style-type: none"> • “Setting Up Locations” (Campus Solutions Application Fundamentals) • <i>PeopleSoft HCM: Application Fundamentals</i> “Setting Up Organization Foundation Tables”
Facility Type	<p>Select a facility type to further define the space. Values for this field are delivered with your system as translate values. You can modify these values.</p>
Partition	<p>Select a partition field value to indicate the section of the campus where the facility is located, such as <i>First</i>, <i>Second</i>, <i>Third</i>, or <i>Fourth</i> quadrant. Use the Partition field to interact with Universal Algorithm Schedule25, which can look at where an instructor's office is located and attempt to schedule the instructor's classes in facilities within the same partition. The maximum number of partitions for Universal Algorithm Schedule25 is 96. Therefore, be sure that you select a value between 01 and 96. Values for this field are delivered with your system as translate values. You can modify these values. For more information about the interface with Universal Algorithm Schedule25, refer to the Universal Algorithm Schedule25 documentation.</p>
Academic Organization	<p>Enter an academic organization to indicate that this facility is reserved for the sole use of that academic organization. Locations might be reserved by an academic organization so that only classes for that academic organization are assigned to that location when you are using the Universal Algorithm product, Universal Algorithm Schedule25. When using the PeopleSoft internal facility search and assignment feature, the system does not use academic organization.</p>
General Assignment	<p>Select to open the location for general assignment. When you select this check box, the Academic Organization field becomes unavailable.</p>
Minimum Utilization Percent	<p>Enter the minimum usage that a facility should experience. This field is for internal record keeping only, and has no programming associated with it.</p>
Check for Facility Conflict	<p>Select to have the system allow only one class to be scheduled for this facility at any given period of time. If you want to schedule more than one class at the same time in this particular facility, such as a field or gymnasium, do not select this check box.</p>

Defining Facility Components

Access the Facility Component page (Set Up SACR > Foundation Tables > Facilities > Facility Table > Facility Component).

This example illustrates the fields and controls on the Facility Component page. You can find definitions for the fields and controls later on this page.

Facility Table		Facility Component		Facility Characteristic	
SetID:	PSUNV				
Facility ID:	ANGE101	Angel101			
Effective Date:	01/01/1900	Status:	Active		
Building:	Angel	Room:	101	Capacity:	110
*Component Facility ID	Building	Room	Capacity		
ANGE0125A	Angel 125A	Angel 125A	20		
ANGE0125B	Angel 125B	Angel 125B	20		
ANGE0125C	Angel 125C	Angel 125C	20		

As an example, Angel 125A, B, and C might be linked as components of Angel 125. To link facility components to a parent facility, you must first define all facilities on the Facility Table page. As soon as components are linked to a parent facility, the system calculates the capacity of that facility by adding up the capacities of all components. If a class is scheduled in a component of a facility and someone attempts to schedule a class in the parent facility, the system prevents the new scheduling.

<i>Field or Control</i>	<i>Description</i>
Component Facility ID	Select the component facility ID for a component that you want to link to this facility. All facilities on the Facility Table page are available for selection. To link more than one component to a parent facility, add rows.

Defining Facility Characteristics

Access the Facility Characteristic page (Set Up SACR > Foundation Tables > Facilities > Facility Table > Facility Characteristic).

This example illustrates the fields and controls on the Facility Characteristic page. You can find definitions for the fields and controls later on this page.

Facility Table		Facility Component		Facility Characteristic						
Find View All First 1 of 1 Last										
SetID:	PSUNV									
Facility ID:	ANGE101	Angel101								
Effective Date:	01/01/1900	Status:	Active							
Building:	Angel	Room:	101	Capacity:	110					
Room Characteristics										
Find View All First 1-2 of 2 Last										
*Room Characteristic:	04	White Board	*Quantity:	2	+ -					
*Room Characteristic:	15	Biology Laboratory	*Quantity:	3	+ -					
Facility Black-out Times										
Find View 1 First 1-2 of 2 Last										
*Facility Black-Out Nbr	*Start Time	*End Time	M	T	W	T	F	S	S	+ -
1	6:00AM	7:50AM	<input checked="" type="checkbox"/>	<input checked="" type="checkbox"/>	<input checked="" type="checkbox"/>	<input checked="" type="checkbox"/>	<input checked="" type="checkbox"/>	<input type="checkbox"/>	<input type="checkbox"/>	
*Facility Black-Out Nbr	*Start Time	*End Time	M	T	W	T	F	S	S	+ -
2	1:00PM	3:00PM	<input type="checkbox"/>	<input type="checkbox"/>	<input checked="" type="checkbox"/>	<input type="checkbox"/>	<input type="checkbox"/>	<input type="checkbox"/>	<input type="checkbox"/>	

Field or Control	Description
Room Characteristic	Select characteristics for this room. Room characteristics are defined on the Room Characteristic Table page. Insert rows to add characteristics. The system uses the Room Characteristic field to interact with Universal Algorithm Schedule25. The maximum number of room characteristics for Universal Algorithm Schedule25 is 96. Therefore, be sure that you select values between 01 and 96.
Quantity	Enter the quantity of the room characteristic. For example, enter 2 to indicate that the room has two white boards.
Facility Black-Out Nbr (facility black-out number)	You can define periods when a facility is unavailable. The facility blackout number is system-generated. This number indicates the number of blackout periods that exist for a facility. You can override the system-assigned facility blackout number.
Start Time and End Time	Enter a start and end time for the blackout period.
M (Monday), T (Tuesday), W (Wednesday), T (Thursday), F (Friday), S (Saturday), and S (Sunday)	Select the days of the week for which the blackout period applies.

Note: Student Records provides the facility blackout structure for compatibility with Resource 25. When using Resource 25, the system prevents class and event scheduling during blackout periods. When using Campus Solutions internal conflict checking logic, the system does not use this structure.

Designating Approved Instructors and Advisors

This section discusses how to:

- Assign faculty rank and advisor status.
- Designate approved course instructors.

Pages Used to Designate Approved Instructors and Advisors

<i>Page Name</i>	<i>Definition Name</i>	<i>Navigation</i>	<i>Usage</i>
Instructor/Advisor Table	INSTR_ADVISOR	Curriculum Management > Instructor/Advisor Information > Instructor/Advisor Table > Instructor/Advisor Table	Indicate faculty rank, advisor status, instructor availability, and the courses that an instructor can teach. Note: You are not adding new people to the database on this page, but updating information for individuals who are already in the database. The IDs that are available depend upon the way that you set up your instructor edit.
Approved Courses	INSTR_ADVISOR2	Curriculum Management > Instructor/Advisor Information > Instructor/Advisor Table > Approved Courses	Indicate courses that an instructor can teach. The system uses the values that you enter as part of the Instructor Edit feature, which is an option that enables you to link instructors to specific campuses, subjects, or courses within an academic organization. This way, when you schedule classes, only the relevant instructors appear as choices.

Assigning Faculty Rank and Advisor Status

Access the Instructor/Advisor Table page (**Curriculum Management > Instructor/Advisor Information > Instructor/Advisor Table > Instructor/Advisor Table**).

This example illustrates the fields and controls on the Instructor/Advisor Table page. You can find definitions for the fields and controls later on this page.

Instructor/Advisor Table
Approved Courses

Raymond Reynolds
SR0499

Instructor Details
Find | View All
First 1 of 1 Last

***Effective Date:**

***Instructor Type:**

***Academic Institution:** PeopleSoft University

***Primary Acad Org:** English

***Instructor Available:**

***Status:**

Advisor

Instructor/Advisor Role
Find | View All
First 1 of 1 Last

Advisor Number:

***Academic Career:** Undergraduate

Academic Program: Liberal Arts Undergraduate

Academic Plan: English (BA)

Academic Sub-Plan:

Percent of Appointment:

<i>Field or Control</i>	<i>Description</i>
Instructor Type	Select an instructor type. Values for this field are delivered with your system as translate values. Do not modify these values in any way. Any modifications to these values require a substantial programming effort. If you select a value of <i>Advisor Only</i> , the system selects the Advisor check box by default and you cannot change it.
Advisor	Select to indicate that the individual is also an advisor and to place the individual into the system's Advisor view. You can later select the Advisor view as a search tool on various pages.
Academic Institution	Select the academic institution with which you want to associate this record.
Primary Acad Org (primary academic organization)	Select a primary academic organization for this instructor. Academic organization values are defined on the Academic Organization Table page.
Instructor Available	Select the instructor's availability to teach within the effective dates. Select <i>Available</i> , <i>Sabbatical</i> , or <i>Unavailable</i> . If the instructor has an advisor type of <i>Advisor Only</i> , the system populates the Instructor Available field with <i>Unavailable</i> by default. You can override this value.

Instructor/Advisor Role

Use the **Instructor/Advisor Role** scroll area to indicate the academic career, program, plan, and subplan to which the instructor or advisor is linked.

Field or Control	Description
Advisor Number	The system populates this field with / by default. If an instructor advises students in more than one academic career, program, plan, or subplan, you can have multiple advisor numbers by adding rows.
Percent of Appointment	Enter a percent of appointment value that this instructor has for the indicated academic career, program, plan, and subplan. Instructors with dual appointments can have different percentages reflecting their responsibility. The total percentage must equal 100.
Academic Career	Select the academic career to which the instructor or advisor is linked. Academic career values are defined on the Academic Career Table page.
Academic Program	Select the academic program to which the instructor or advisor is linked. Academic program values are defined on the Academic Program Table component.
Academic Plan	Select the academic plan to which the instructor or advisor is linked. Academic plan values are defined on the academic plan pages.
Academic Sub-Plan	Select the academic subplan to which the instructor or advisor is linked. Academic subplan values are defined on the academic subplan pages.

Designating Approved Course Instructors

Access the Approved Courses page (**Curriculum Management > Instructor/Advisor Information > Instructor/Advisor Table > Approved Courses**).

To make use of the values on this page, enable the Instructor Edit feature. To do so, on the Academic Organization Table page, choose to edit instructors against the Instructor/Advisor table rather than the Personal Data table for the related academic organization. You must also select this option on the Course Catalog Description page for the courses involved.

Having done this, when you schedule classes on the Class Meeting Pattern/Instructor page and have to assign an instructor to a class that falls within the academic organization and courses that you have set up in this manner, the system displays only the relevant instructors in the **ID** field.

In the lower portion of the page, select the subjects, courses, or campuses at which the instructor is approved to teach based on effective date. The availability of these fields depends on the options that your institution selects by which to edit instructors on the Academic Organization Table page.

Field or Control	Description
Seq Nbr (sequence number)	The system populates the Seq Nbr field by default. Sequence numbers are sequential numbers that the system assigns to identify rows in the table.
Acad Org (academic organization)	Select the academic organization to indicate that the instructor is approved to teach all courses within the academic organization that you specify. If your institution has set up the academic organization to edit instructors by campus, subject, and course, you can further narrow the courses. This field is required.
Subject Area	If available, select the subject area that the instructor is approved to teach. Subject area values are defined for each academic institution on the Academic Subject Table page.
Course ID	If available, select the course ID of the course that the instructor is approved to teach. You are prompted from the course catalog. If your course catalog has only one offering number, the system supplies the offering number by default.
Offer Nbr (offering number)	If available, select the offering number of the class that the instructor is approved to teach.
Catalog Nbr (catalog number)	The system displays the catalog number, based on the course catalog definition.
Campus	Select the campus for which the instructor can teach. Campus values are defined for each academic institution on the Campus Table page. Add rows to further specify courses that the instructor is approved to teach.

Defining Requirement Designations

To set up requirement designations, use the Requirement Designation Table component (RQ_DESIGNATION_TBL).

This section provides an overview of requirement designations and discusses how to define requirement designations.

Understanding Requirement Designations

Requirement designations, unlike course attributes, transfer to PeopleSoft Academic Advisement. A requirement designation can be extra credit that a student has done for a course, such as design credit. For example, you can attach a requirement designation of *Design* to all first-, second-, third-, and fourth-year architecture studio courses that carry the optional add-on enrollment of *Design Credit*. When students enroll in any of these studios, they can elect to take the course to fulfill their design credit certification. Requirement designations are intended as optional add-on credit for a course in which some students are taking the class alone, and others in the same class are taking both the class and attempting to pass the requirement designation portion. In this way, the requirement designation reflects extra credit. Some students in the class attempt it, while others do not.

Requirement designations should be used sparingly, and are *not* intended to track general advisement requirements. They are meant as additional qualifiers that alone may be a requirement. With relation to the previous example, you may require a total of six hours of design credit across four years of architecture study, in addition to the minimum unit and grade-point-average requirements for the courses. By using a requirement designation, you enable students to complete their design credit at any stage and pace across four years. Student A might attempt design credit during second and fourth years, in the spring term. Student B might complete all six design hours while enrolled in the fourth-year studio, during the fall and spring terms. Although these two students are in the same studio classes across the four years, they pace themselves and complete assignments differently. Student A begins to explore design practices as a sophomore (by doing some type of additional design work in consultation with a professor), while student B decides to wait and load up on design work the last year of his or her career as an architecture student. Typical requirement designations may include Counts Toward Design Certification, Preparation for Licensing Exam, Electing course to be the basis of Liberal Arts Thesis Credit, and so on. Requirement designations can be graded as Satisfied or Not Satisfied.

In the previous example, the design credit requirement designation was set up as an enrollment option. Students can elect to take the design credit requirement designation at the time of enrollment in certain architecture studio classes. You can also create a requirement designation that is not optional at enrollment. This type of requirement designation is strictly attached to a class. Taking the class, along with the requirement designation, is required of all students who enroll. The distinction between a requirement designation that is elective at enrollment and one that is automatically added to a student's enrollment request is the way that you set the **At Student's Option** check box on the Requirement Designation Table page. This option and others like it are discussed in the following section.

Related Links

[“Setting Up Academic Course Lists” \(Academic Advisement\)](#)

[Understanding Grading](#)

Page Used to Define Requirement Designations

<i>Page Name</i>	<i>Definition Name</i>	<i>Navigation</i>	<i>Usage</i>
Requirement Designation Table	RQ_DESIGNATION_TBL	Set Up SACR > Product Related > Student Records > Curriculum Management > Requirement Designation Table > Requirement Designation Table	Define requirement designations.

Defining Requirement Designations

Access the Requirement Designation Table page (Set Up SACR > Product Related > Student Records > Curriculum Management > Requirement Designation Table > Requirement Designation Table).

This example illustrates the fields and controls on the Requirement Designation Table page. You can find definitions for the fields and controls later on this page.

Requirement Designation Table

Requirement Designation: COLB

Find | View All
First 1 of 1 Last

*Effective Date:	<input type="text" value="01/01/1995"/>	*Status:	<input type="text" value="Active"/>
*Description:	<input type="text" value="College Breadth Requirement"/>		
*Short Description:	<input type="text" value="CollBredth"/>		
*Formal Description:	<input type="text" value="Satisfies A&SCI College Breadth Requirement"/>		
Academic Institution:	<input type="text" value="PSUNV"/> PeopleSoft University		
Academic Plan:	<input type="text"/>		

At Student's Option
 Separate Course Grade
 Show In Class Search
 Catalog Print
 Schedule Print
 Print in Transcript
 Display in AA Reports

<i>Field or Control</i>	<i>Description</i>
Status	Select a status for this requirement designation. Select <i>Active</i> when adding a new requirement designation. Select <i>Inactive</i> only if your institution no longer uses this requirement designation.
Description, Short Description, and Formal Description	Enter a description, short description, and formal description. The formal description appears on the course catalog report, schedule of classes report, and transcript if specified.

Field or Control	Description
Academic Institution	Select an academic institution with which to associate the requirement designation. This affects the availability of this requirement designation on the course catalog and schedule of classes prompts.
Academic Plan	Select an academic plan if you want to link the requirement designation to a specific plan. At enrollment, a student must be active in the specified plan to enroll in any class with the related requirement designation. The Enrollment Request 1 page includes overrides that enable you to override this general rule if you have the appropriate security permissions. On the Enrollment page, the system does not validate this.
At Student's Option	<p>Select to indicate that the student can select the requirement designation at enrollment. You can indicate a student's choice of requirement designation on the Enrollment Request Page, the Student Enrollment 4 page, or the Block Enrl Detail 2 page.</p> <p>If you do not select this check box, students who enroll in classes that have this requirement designation are required to take the course and attempt the additional requirement designation credit.</p> <p>See:</p> <ul style="list-style-type: none"> • Processing Enrollment Transactions Through the Enrollment Request Component • Processing Enrollment Transactions Through the Block Enrollment Feature
Catalog Print	<p>Select to enable the display of the formal description of the requirement designation and the course in the course catalog report.</p> <hr/> <p>Note: The SSR_COURSE (Course Catalog) web service is one of a number of delivered Enrollment Web Services. The service operation SSR_GET_COURSES: Browse Course Catalog Summary obeys the Catalog Print setup that you select on the Requirement Designation Table page and on the Course Attributes page.</p> <hr/> <p>For detailed information about Enrollment Web Services, see <i>Enrollment Web Services Developers Guide</i> and <i>Enrollment Web Services Users Guide</i> in My Oracle Support (ID 1371391.1).</p> <p>See</p>
Schedule Print	Select to enable the display of the formal description of the requirement designation and the course in the schedule of classes report.

Field or Control	Description
Print in Transcript	Select to print the requirement designation and requirement designation grade on the student's transcript.
Separate Course Grade	<p>Select to indicate that the requirement designation involves work that someone must grade separate from the course. If this check box is cleared, students who earn credit for the course will, by default, earn a grade of Satisfied for the requirement designation. The professor does not need to assign two grades for every student (for example, a letter grade of B for the course, and a grade of Satisfied for the requirement designation).</p> <p>Alternatively, should the professor want to evaluate a student on each of these two areas independently, select the check box. This setting is optimal in the event that a student receives a passing grade for the class, but fails to successfully complete the requirement designation. In this instance, the professor could assign a letter grade of B to the class, and assign a grade of Not Satisfied for the requirement designation. The class would not fulfill an advising requirement that requires both a class and a requirement designation for the class. It would fulfill only an advising requirement that requires the class alone.</p> <p>See Using the Grade Roster Page to Enter Grades.</p>
Display in AA Reports	Select to enable the system to display the requirement designation code and description in the advisement report.
Show in Class Search	<p>If this check box is selected for a Requirement Designation and the Class Search Profile (for example, STDNT) includes a search criteria of Requirement Designation, then a student can search by the Requirement Designation in Self Service.</p> <p>See Setting Up Class Search Profiles</p> <p>See “Searching for Classes Using Classic Self-Service Pages” (Campus Self Service)</p> <p>See Searching for Classes</p>

Setting Up Unit Conversions

To set up unit conversions, use the Unit Conversion Table component (UNIT_CONVR_TBL).

This section provides an overview of unit conversions, lists prerequisites, and discusses how to set up unit conversion rules within your institution.

Understanding Unit Conversions

If students at your institution take classes outside of their current career, you should define unit conversions. You should especially do this if some careers are on a quarter system and other careers are on a semester system (for example, if an MBA student takes a law course, but the MBA program is on a quarter system and the law program is on a semester system). The system also uses the unit conversion rules when you process internal transfer credit for students, which can include students with internal coursework that transfers from one career to another career, or students with internal coursework that transfers from one program to another program.

Prerequisites

If you want to use term types other than the translate values that are delivered by Campus Solutions, you must first create them in the TERM_TYPE_CONVR_TO translate table.

Page Used to Set Up Unit Conversions

<i>Page Name</i>	<i>Definition Name</i>	<i>Navigation</i>	<i>Usage</i>
Unit Conversion Table	UNIT_CONVR_TBL	Set Up SACR > Product Related > Student Records > Enrollment > Unit Conversion Table > Unit Conversion Table	Set up unit conversions within your institution.

Setting Up Unit Conversion Rules within Your Institution

Access the Unit Conversion Table page (**Set Up SACR > Product Related > Student Records > Enrollment > Unit Conversion Table > Unit Conversion Table**).

This example illustrates the fields and controls on the Unit Conversion Table page. You can find definitions for the fields and controls later on this page.

Unit Conversion Table

SetID: PSUNW

Term Unit Type: S Semester Hours

Find | View All First 1 of 1 Last

***Effective Date:** 01/01/1900 + -

Find First 1 of 1 Last

***Term Type Convert To** **Unit Multiplier**

Quarter Hours 1.5000 + -

<i>Field or Control</i>	<i>Description</i>
Term Type Convert To	Select the value to which you want to convert the value in the Term Unit Type field.
Unit Multiplier	Enter the number for the system to use to multiply the term unit type units by to convert them to the term type convert to value, for example, (term unit type units) × (unit multiplier) = (term type convert to units).

Defining Standard Meeting Patterns

Define class meeting patterns for your classes on the Standard Meeting patterns page on the Academic Group Table.

Related Links

“Defining Standard Class Meeting Patterns” (Campus Solutions Application Fundamentals)

Defining Modes of Instruction

To set up instruction modes, use the Instruction Mode component (INSTRUCT_MODE).

You need to set up instruction mode values that you use when you define courses and schedule classes. This section discusses how to define instruction modes.

Page Used to Define Modes of Instruction

<i>Page Name</i>	<i>Definition Name</i>	<i>Navigation</i>	<i>Usage</i>
Instruction Mode	INSTRUCT_MODE	Set Up SACR > Product Related > Student Records > Curriculum Management > Instruction Mode > Instruction Mode	Define instruction modes.

Defining Instruction Modes

Access the Instruction Mode page (**Set Up SACR > Product Related > Student Records > Curriculum Management > Instruction Mode > Instruction Mode**).

Important! Set up an instruction mode value of *P* for every institution in your system. You can enter any description and short description; however, you should use *In Person* for both fields. The system uses this value as a default for the **Instruction Mode** field on the Schedule of Classes - Basic Data page (when you enter the page in *Add* mode). In addition, you can generate rosters only for those classes with an instruction mode value of *P* on the Basic Data page.

Field or Control	Description
Effective Date and Status	The effective date determines when the status that you select is valid. The active effective date must be equal to or before the effective date of the course component to which you assign the instruction mode.
Description	Enter the description of the instruction mode. The system displays this value on the Course Catalog report and the Schedule of Classes report, as well as on the Course Catalog component and Schedule of Classes online pages.
Short Description	Enter a short description for the instruction mode.
Print On Course Catalog	Select to display the instruction mode on the course catalog report.
Print On Schedule of Classes	Select to display the instruction mode description on the schedule of classes report, as well as on the online schedule of classes.
Print On Transcript	No programming is attached to this field.

Setting Up Class Search Profiles

This section discusses class search configuration only for the classic user interface and describes how to:

- Define class search criteria.
- Define class search result options.
- Define class detail options.

For information about other Class Search setup such as search results limits,

See [Reviewing or Defining Student Records Installation Settings](#)

The delivered Class Search Profiles are:

- STDNT (Student/Visitor Self Service)
- INSTR (Instructor/Advisor Self Service accessed through Faculty and Advisor Centers)

- ADMIN (Administrative class search)
- SSAPT (for use with Program Enrollment)

Pages Used to Set Up Class Search Profiles

<i>Page Name</i>	<i>Definition Name</i>	<i>Navigation</i>	<i>Usage</i>
Search Configuration	SSR_CLSRCH_CONFIG	Set Up SACR > Product Related > Student Records > Curriculum Management > Class Search Configuration > Search Configuration	Define class search criteria.
Class Result Options	SSR_CLSRSLT_CONFIG	Set Up SACR > Product Related > Student Records > Curriculum Management > Class Search Configuration > Class Result Options	Define class search result options.
Class Detail Options	SSR_CLSDTL_CONFIG	Set Up SACR > Product Related > Student Records > Curriculum Management > Class Search Configuration > Class Detail Options	Define class detail options.

Defining Class Search Criteria

Access the Search Configuration page (**Set Up SACR > Product Related > Student Records > Curriculum Management > Class Search Configuration > Search Configuration**).

Note: This page is not used for class search in Fluid.

This example illustrates the fields and controls on the Search Configuration page. You can find definitions for the fields and controls later on this page.

The screenshot shows the 'Search Configuration' page with three tabs: 'Search Configuration', 'Class Result Options', and 'Class Detail Options'. The 'Search Configuration' tab is active, showing a 'Class Search Profile' named 'SSAPT'. Below this, there are search options: 'Incl Topic on Course Keyword', 'Incl Long Desc on Crse Keyword', and 'Include Course Attribute Value'. There are 'Add Search Group' and 'Reset Values' buttons. The 'Configure Search' section shows 'Group Sequence' 1, 'Message Set Number' 14690, and 'Message Number' 3146. A table lists search criteria with columns for 'Seg Nbr', 'Use Common Attribute', 'Search Criteria', and 'Common Attribute'. The table has 5 rows with criteria: Session Code, Meeting Times, Class Days, Instructor Name, and Open Only.

Use this page to define, for each profile, the search criteria that are available on the Search for Classes page. For example, if you select *Session Code* for the INSTR profile, then instructors who use class search in Self Service can select *session* as a search criterion.

Search Options

Field or Control	Description
<p>Incl Topic on Course Keyword (Include Topic on Course Keyword)</p>	<p>If this check box is selected and a Class Search Profile includes <i>Course Keyword</i>, then if a user searches by <i>cognitive</i>, the search returns all classes for which <i>cognitive</i> is found in the Course Description or Long Course Title. The search also returns all classes for which <i>cognitive</i> is found in the course topic Description or Formal Description if a Course Topic ID exists for the class.</p>

Field or Control	Description
Incl Long Desc on Crse Keyword (Include Long Description on Course Keyword)	If this check box is selected and a Class Search Profile includes <i>Course Keyword</i> , then if a user searches by <i>cognitive</i> , the search returns all classes for which <i>cognitive</i> is found in the Course Description, Long Course Title, or Long Description.
Include Course Attribute Value	<p>If a Class Search Profile includes <i>Course Attribute</i>, then:</p> <ul style="list-style-type: none"> • If this check box is selected, a user can search by Course Attribute and Course Attribute Value—for example, search by Course Attribute: Honors, and Course Attribute Value: Math Department Honors. • If this check box is cleared, a user can search by Course Attribute only.

Configure Search

Field or Control	Description
Add Search Group, Group Sequence, and Seq Nbr (sequence number)	<p>Configure groups of search criteria for a profile and define the sequence order in which fields are displayed on the Search for Classes page.</p> <p>Criteria can used in only one group box within a profile.</p>
Message Set and Message Number	Define the labels for class search groupings through the Message Catalog (Message Set 14690).
Reset Values	Click this button to access a default setting where all values are displayed and configured into two groups: Class Search, which is expanded by default and Additional Search Criteria, which is collapsed by default. You can then modify the search criteria and groupings.

Field or Control	Description
Use Common Attribute	<p>Select this check box to use class association attributes in class search.</p> <p>When you select the check box, the Search Criteria field is not available and the Common Attribute field displays the available class association attributes as defined on the CLASS_ASSOC Record Context. An attribute can be used only once within a profile.</p> <p>When students search for classes from Program Enrollment Self Service, a controlled class search is used. Therefore unlike other class search profiles, you do not need to include Subject and Course Number as search criteria for the SSAPT profile.</p> <p>See Using the Common Attribute Framework to Extend Class Associations for Program Enrollment</p>

Related Links

[Searching for Classes](#)

“Searching for Classes Using Classic Self-Service Pages” (Campus Self Service)

“Using Program Enrollment Self-Service Features” (Campus Self Service)

Defining Class Search Result Options

Access the Class Result Options page (**Set Up SACR > Product Related > Student Records > Curriculum Management > Class Search Configuration > Class Result Options**).

This example illustrates the fields and controls on the Class Result Options page. You can find definitions for the fields and controls later on this page.

The screenshot shows a web interface with three tabs: 'Search Configuration', 'Class Result Options' (selected), and 'Class Detail Options'. Below the tabs, it says 'Class Search Profile SSAPT'. There are two main sections: 'Instructions' and 'Filters'.

Instructions Section:

- Show Class Result Instructions
- Message Set Number: Message Number:
- Message Text:

Filters Section:

- Use Search Result Filters
- Filter Items table:

Sequence Number	Use Common Attribute	Criteria	Common Attribute	Match		
1	<input type="checkbox"/>	Academic Shift		Filter Default	+	-
2	<input type="checkbox"/>	Instruction Mode		Filter Default	+	-
3	<input type="checkbox"/>	Location		Filter Default	+	-
4	<input checked="" type="checkbox"/>		Student Language	Filter Default	+	-

Instructions

You can define user-specific (student, faculty, admin) introductory text which appears on the class Search Results page if the Show Class Result Instructions check box is selected.

See “Searching for Classes Using Classic Self-Service Pages” (Campus Self Service).

Filters

This group box is currently available for SSAPT (Program Enrollment - My Schedule Builder) only.

See “Using Program Enrollment Self-Service Features” (Campus Self Service)

See [Managing APT Enrollment](#)

For information about defining academic shifts (Academic Shift page), see “Defining Academic Shifts” (Campus Solutions Application Fundamentals)

For information about how to indicate that you want to use Academic Shift and the setup required to assign a shift to a student (Academic Institution 3 page), see “Setting Additional Institution Defaults and Options” (Campus Solutions Application Fundamentals)

For information about attaching an academic shift to a student’s academic program (Student Program page), see [Maintaining Student Academic Programs](#)

For information about additional setup required for Common Attribute values, see:

“Understanding Common Attribute Framework” (Campus Community Fundamentals)

“Associating a Common Attribute to a Record” (Campus Community Fundamentals)

Maintaining Student Additional Information

Field or Control	Description
Use Search Result Filters	If you select this check box, filters appear on the class Search Results page, as explained below.
Sequence Number	Determines the order in which filters appear on the class Search Results page.
Use Common Attribute	<p>If you select this check box and then select a Common Attribute value (and the attribute is associated with the relevant associate class in the Schedule of Classes component), then the attribute is available as a filter on the Search Results page when a user searches for classes.</p> <p>When viewing the class search results, the filter check box is selected by default if the attribute is attached to the student's program as well as the relevant associated class and section. The user can change the filter. However, if the Match selection option on the Class Result Options page is <i>Required Match</i> and there is a match on the student's attribute and associated class attribute, then the Search Results page shows matching class sections only. The student cannot change the filter.</p> <p>See Adding Class Association Attributes Using the Schedule of Classes Component</p>
Criteria	<p>Select a value to indicate that the criteria should be available as a filter on the Search Results page when a user searches for classes.</p> <p>If you select the <i>Academic Shift</i> criteria, an Academic Shift value must be selected for the class in the Schedule of Classes component.</p> <p>See Defining Class Meeting Patterns</p>

Field or Control	Description
Match	<p><i>Filter Default:</i> A filter option appears with a check box selected on the class Search Results page when the class search returns a class with sections that match the filter criteria. A student can clear or re-select the check box to expand or narrow the search results. If no match occurs, the filter does not appear on the Search Results page</p> <p><i>Required Match:</i> The class Search Results page displays only sections that match the required criteria. A filter option appears with a check box selected but the student cannot clear or change the filter criteria. For example, if an institution wants to display to the student only class sections that match the student's campus (see Student Program/Plan component), the institution can define campus as a required match.</p> <p>See Maintaining Student Program Stacks</p> <hr/> <p>Note: If no matches are found for a given default filter criteria, the respective filter does not display on the Search Results page. For example, if there is a filter default defined for the attribute of student language but there are no sections with the associated class attribute for a student language value, the filter does not display on the Search Results page.</p> <hr/> <p>Note: If a student accesses My Schedule Builder and only one class section matches the <i>Required Match</i> filter criteria, that section displays on My Schedule Builder. The student does not see the Search Results page.</p> <hr/>

Defining Class Detail Options

Access the Class Detail Options page (**Set Up SACR > Product Related > Student Records > Curriculum Management > Class Search Configuration > Class Detail Options**).

Use this page to define, by profile, the fields that appear on the Class Detail page. For example, if you select the Enroll Rqmt: Requisite check box for the STDNT profile, then in Self Service, when a student clicks the link for the class and is taken to the Class Detail page, the student can see the enrollment requisite information for that class.

All check boxes are selected by default.

<i>Field or Control</i>	<i>Description</i>
Textbook Information	The information that appears on the Class Detail page depends on the data that you enter on the Schedule of Classes–Textbook page (Curriculum Management, Schedule of Classes, Schedule New Course, Textbook). See Defining Textbooks for Classes

Chapter 4

Setting Up Repeat Checking

Understanding Repeat Checking Functionality

The Student Records repeat checking functionality is a flexible, fully integrated feature that updates students' academic statistics based on an academic institution's course repeat policies. Through the repeat schemes, repeat codes, and repeat rules that your institution defines, the functionality regulates academic statistics that are usually governed by the grading scheme.

The repeat checking functionality enables you to manage repeats at the beginning, middle, and end of students' coursework. The functionality enables you to:

- Identify automatically that students are repeating courses when students enroll in classes (front-end processing).
- Identify automatically that students are repeating courses when you grade students through the Enrollment Request page (back-end processing).
- Identify automatically that students are repeating courses when you post transfer credit (back-end processing).
- Identify in batch that students are repeating courses by running the Repeat Checking process once per term through the Repeat Checking page.
- Identify repeats manually by assigning repeat codes to students' records on the Student Enrollment page, Enrollment Request page, or Quick Enrollment page.

The repeat checking functionality consists of the following two processes, both of which are fully integrated with each other:

- The Allowable Repeats process, which enables you to define rules on the Catalog Data page of the Course Catalog (CRSE_CATALOG) component that regulate whether a student can repeat a course or course topic for credit and, if so, how many total units and total completions the student can attempt.

In conjunction with this setting at the course catalog level, you can define by grade (Repeat Checking Option) or by existing repeat code (Count and Process Option) if a class is defined as an allowable repeat.

- The Repeat Checking process, which takes effect only after a student exceeds either repeat maximum in the course catalog.

You can also define by grade (Repeat Grade Option) or by existing repeat code (Count and Process Option) if a class should be processed by the repeat check engine.

To use the repeat checking functionality, your institution must first define repeat schemes, repeat codes, and repeat rules.

- *Repeat schemes* are the set of valid repeat codes that an academic institution can use to define the repeat rules for an academic career.
- *Repeat codes* are the settings that adjust academic statistics.

Repeat codes can adjust academic statistics in the following ways: they prevent the system from including repeated coursework in a student's grade point average (GPA) and they prevent the system from including repeated coursework in a student's academic level. You can also decide to not adjust statistics for previously assigned repeat codes.

- *Repeat rules* are defined by academic careers and assigned to academic programs. The rules are analyzed during the repeat checking process and appropriate repeat codes are then assigned to the student enrollment record.

Repeat rules inform the Repeat Checking process when a student's repeated coursework matches the repeat policy of an academic career or an academic program. The Repeat Checking process then assigns the appropriate repeat codes to the student's enrollment record.

After you define these elements, you must link the repeat rules to academic careers. These rules carry to the academic program unless you make a different repeat rule assignment at that level. You can assign to academic careers and academic programs only the repeat rules that are valid for the repeat scheme of the academic career. Finally, you must specify when you want the Repeat Checking process to run at the academic institution, academic career, and academic program levels. These controls enable you to turn on and off automatic repeat checking during enrollment and grade input. They also enable you to temporarily suspend automatic repeat checking during peak enrollment and grade input periods.

After your institution defines these elements, the repeat checking functionality is ready to use. When the Repeat Checking process runs, it looks for a matching pair of course IDs or courses deemed equivalent (on the Course Equivalencies page). When the process finds a matching pair, it associates the appropriate repeat rule and assigns the designated repeat code to the student's enrollment record for the repeated class. You can view the assigned repeat code on the Enrollment Request page or the Quick Enrollment page. Depending on your setup, the repeat code can prevent a repeated course from counting towards a student's academic level or GPA.

The Allowable Repeats process and Repeat Checking process set the repeat candidate flag (REPEAT_CANDIDATE) on the student's enrollment record (STDNT_ENRL) to *Y* or *N* for all components of a class. The COBOL process sets the flag to *Y* for all classes identified as repeat candidates as long as the following conditions are met:

- You must set up front-end repeat checking to issue warning messages whenever the COBOL process encounters a repeat candidate.
- You must process the enrollment transaction through the enrollment engine.

The COBOL process does not validate enrollment transactions that are processed through the Enrollment (STDNT_ENRL) component and, therefore, does not issue a warning repeat message. For enrollment transactions that are processed through the Enrollment component, the system sets the repeat candidate flag on the student's enrollment record to *N*, even for repeated classes.

On the Repeat/Incomplete page of the Academic Program Table (ACADEMIC_PROG_TBL) component, if you set the **Process on Enrollment** field to *No* and the **Course Catalog Repeat Messages** field to *Warning*, the Allowable Repeats process is activated. When students submit enrollment requests and the student exceeds the total completions allowed for the class, as determined by the Course Catalog Detail page, they receive a warning message.

If you set the **Process on Enrollment** field to *Yes*, the **Course Catalog Repeat Messages** field is automatically set to *Warning* and becomes unavailable for edit. On enrollment requests, the Repeat Checking process looks to the repeat rule setup for messaging rules.

For the process to correctly and consistently set the repeat candidate flag to *Y*, you must set the **Enrollment Message** field to *Warning* for the repeat rule on the Repeat Rule2 page and for every detail rule on the Repeat Rule Detail 1 page. If you set the **Enrollment Message** field to *Ignore*, the process does not send a message for that rule and, even if the course is a repeat candidate, the process sets the repeat candidate flag to *N*, provided that it does not violate other repeat rules.

This diagram explains the Repeat Engine logic:

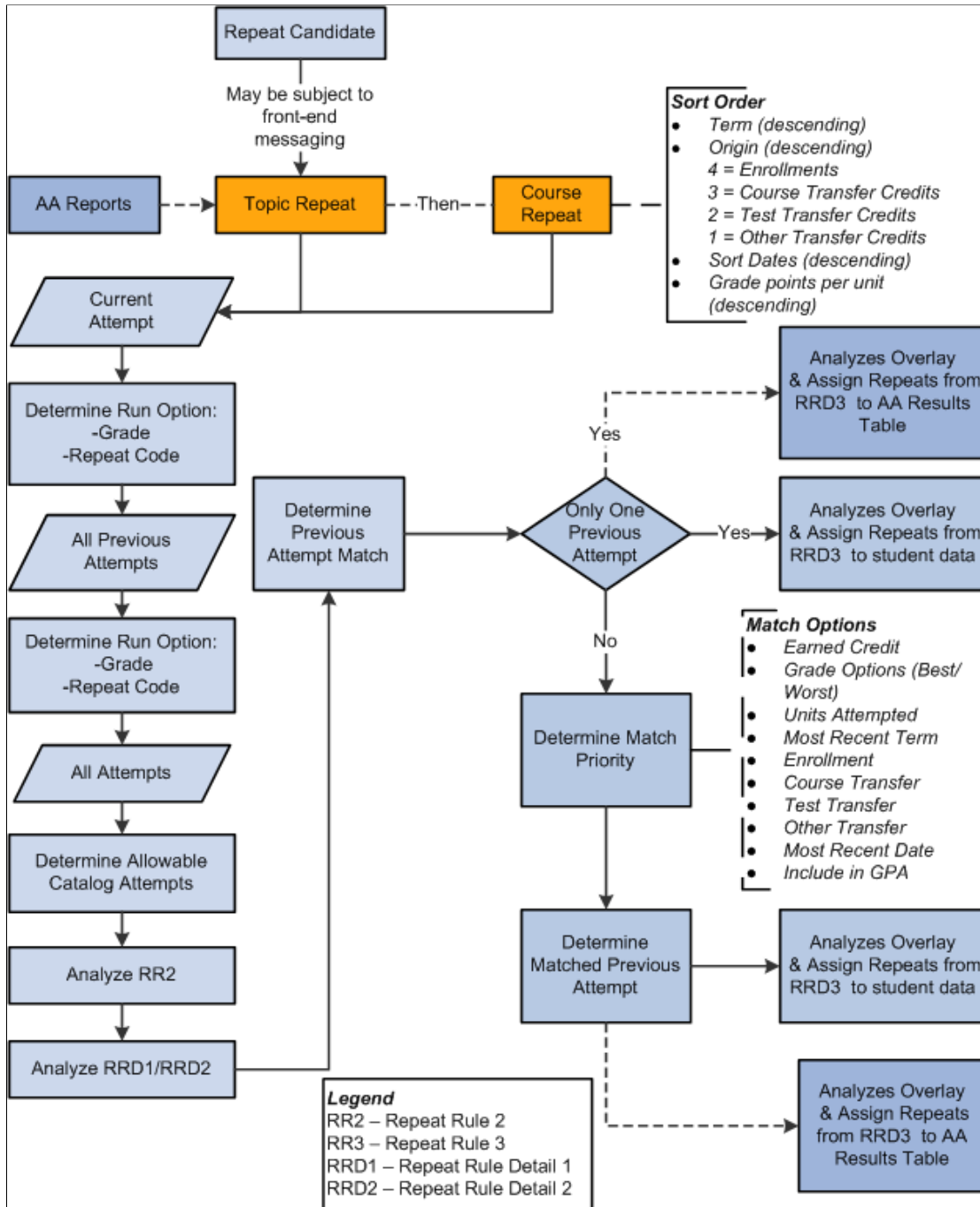

Related Links

[Understanding the Three Repeat Checking Methods](#)

Defining Repeat Schemes and Repeat Codes

To set up repeat schemes and codes, use the Repeat Scheme Table (REPEAT_SCHEME_TBL) component.

This section discusses how to create repeat schemes and codes.

Page Used to Define Repeat Schemes and Repeat Codes

<i>Page Name</i>	<i>Definition Name</i>	<i>Navigation</i>	<i>Usage</i>
Repeat Scheme Table	REPEAT_SCHEME_TBL	Records and Enrollment > Term Processing > End of Term Processing > Repeat Scheme Table > Repeat Scheme Table	Create repeat schemes and the repeat codes within each scheme.

Creating Repeat Schemes and Codes

Access the Repeat Scheme Table page (**Records and Enrollment > Term Processing > End of Term Processing > Repeat Scheme Table > Repeat Scheme Table**).

This example illustrates the fields and controls on the Repeat Scheme Table page. You can find definitions for the fields and controls later on this page.

Repeat Scheme Table

SetID: PSUNV **Repeat Scheme:** UGRD

Find | View All 1 of 1

***Effective Date:** 01/01/1900 + -

***Status:** Active v

***Description:** Undergraduate ***Short Desc:** PSU

Find | View All 1 of 22

***Repeat Code:** EXCM + -

***Description:** Repeated - Excluded ***Short Desc:** Repeated

Formal Description: Repeated - Excluded

Earn Credit

Include in GPA

Print Repeat Description

Print Repeat Date

***Units Attempted:** Yes v

Display in AA Reports

When this code exists in student data

***Count and Process Option:** 1) Count = Y Process = Y v

Allow to be overlaid

Bypass processing if it is on Current Attempt

The purpose of repeat codes is to adjust students' academic statistics appropriately when students repeat courses, rather than having the system calculate statistics by using the grading scheme.

<i>Field or Control</i>	<i>Description</i>
Repeat Code	Enter a repeat code for this repeat scheme. If assigned, this code appears on a student's enrollment record. You can view codes that are assigned to a student's enrollment records on the Enrollment Request page or the Quick Enrollment page.
Earn Credit	Select to indicate that a student with this repeat code on a class enrollment record can earn credit for the class. To prevent a repeated course from counting toward a student's academic level, clear this check box.
Include in GPA (include in grade point average)	Select to indicate that a student with this repeat code on a class enrollment record can have the class included in the GPA calculation. To prevent a repeated course from being calculated in the student's GPA, clear this check box.

Field or Control	Description
Print Repeat Description	Select to have the system print the formal description of this repeat code on the student's transcript when applicable.
Print Repeat Date	Select to print the date that the student completed the repeated course on the student's transcript.
Units Attempted	<p>From the following choices, enter a value to indicate how the units attempted from a repeated course count towards a student's academic statistics when this repeat code is assigned to the student's class enrollment record. Values for this field are delivered with your system as translate values. Do not modify these values in any way. Any modifications to these values require substantial programming.</p> <p><i>Yes:</i> Indicates that a student with this repeat code on a class enrollment record can have the class included in units attempted.</p> <p><i>No:</i> Prevents the units from a repeated course from counting toward a student's academic statistics.</p> <p><i>In Progress:</i> Units in progress is used for courses coded with this repeat code.</p>
Display in AA Reports (display in Academic Advisement reports)	Select to allow the system to display the repeat code and its description in the advisement report.

When this code exists in student data

Field or Control	Description
Count and Process Option	<p>Select an option to indicate whether a class with this repeat code should be counted as a repeat candidate and whether the class should be processed by the Repeat Checking process.</p> <p>Values are:</p> <p>1) <i>Count = Y Process = Y</i>: If you select this option, any class with this repeat code is counted in the pool of repeat attempts and is selected and processed when the Repeat Checking process is run.</p> <p>2) <i>Count = Y Process = N</i>: If you select this option, any class with this repeat code is counted in the pool of repeat attempts, but is not selected and processed when the Repeat Checking process is run.</p> <p>3) <i>Count = N Process = Y</i>: If you select this option, any class with this repeat code is not counted in the pool of repeat attempts, but is selected and processed when the Repeat Checking process is run.</p> <p>4) <i>Count = N Process = N</i>: If you select this option, any class with this repeat code is not counted in the pool of repeat attempts, nor is it selected and processed when the Repeat Checking process is run.</p> <hr/> <p>Note: The Repeat Checking process analyzes the value in the Repeat Checking Option field on the Grading Scheme Table page before it analyzes the value in the Count and Process Option field on this page.</p> <hr/> <p>See Understanding Repeat Checking Functionality.</p>
Allow to be overlaid	<p>Select this check box to allow the Repeat Checking process to overlay this repeat code in subsequent process runs. Clear the check box if this repeat code should never be replaced.</p>
Bypass processing if it is on Current Attempt	<p>Select this check box if the current attempt already has this code assigned and the class should not be picked up by the Repeat Checking process.</p>

Defining Repeat Rules

To set up repeat rules, use the Repeat Rule (REPEAT_RULE) component.

This section discusses how to do the following tasks and concludes with an example of a repeat rule:

- Describe repeat rules.
- Define conditions for repeat rules.
- Define the criteria and order that are used to determine a match when three or more repeat candidates are processed.
- Define repeat rule sequences.
- Define conditions for repeat rule sequences.
- Designate process actions for repeat rule sequences.

If you want to run repeat checking at the academic career level but want to exclude an academic program without having to select each academic program for which you do want to run repeat checking, you can set up a repeat rule called NONE. After naming the repeat rule, complete the required fields in the component and attach it to the academic program that you want to exclude. When the Repeat Checking process sees the NONE repeat rule, it does not run for that academic program.

Pages Used to Define Repeat Rules

<i>Page Name</i>	<i>Definition Name</i>	<i>Navigation</i>	<i>Usage</i>
Repeat Rule	REPEAT_RULE	Records and Enrollment > Term Processing > End of Term Processing > Repeat Rule > Repeat Rule	Describe the repeat rules that you later link to academic careers and academic programs.
Repeat Rule2	REPEAT_RULE2	Records and Enrollment > Term Processing > End of Term Processing > Repeat Rule > Repeat Rule2	Define the total attempts and units that are allowed for a course to which the repeat rule applies. You define the repeat code that is assigned to the student enrollment if the defined attempts or units are exceeded. You establish how the enrollment engine notifies a student when this violation occurs. Lastly you can define if there are any repeat codes that are exempted from the attempts and units allowed totals.
Repeat Rule3	REPEAT_RULE3	Records and Enrollment > Term Processing > End of Term Processing > Repeat Rule > Repeat Rule3	Select the criteria and the order that are used by the Repeat Checking process to determine a match between the current attempt and multiple previous attempts.

Page Name	Definition Name	Navigation	Usage
Repeat Rule Detail 1	REPEAT_RULE_DTL	Records and Enrollment > Term Processing > End of Term Processing > Repeat Rule > Repeat Rule Detail 1	Further define a rule when your institution restricts the number of times that a student can repeat a course within a certain grade range. This page describes the <i>previous</i> course in the matched pair of repeat courses. For example, a student can repeat courses with F or D grades (grade points between 0.00 and 1.999) only twice.
Repeat Rule Detail 2	REPEAT_RULE_DTL2	Records and Enrollment > Term Processing > End of Term Processing > Repeat Rule > Repeat Rule Detail 2	Define what the repeat checking rule should do, based on the value of a preexisting repeat code on the current course attempt.
Repeat Rule Detail 3	REPEAT_RULE_DTL3	Records and Enrollment > Term Processing > End of Term Processing > Repeat Rule > Repeat Rule Detail 3	Designate the codes that the Repeat Checking process should assign to the enrollment records of both the current and previous course attempts.

Describing Repeat Rules

Access the Repeat Rule page (**Records and Enrollment > Term Processing > End of Term Processing > Repeat Rule > Repeat Rule**).

This example illustrates the fields and controls on the Repeat Rule page. You can find definitions for the fields and controls later on this page.

Your repeat rules are keyed by the academic careers, so your description might be *Undergraduate Repeat Rules*, *Fine Arts Repeat Rules*, *Graduate Repeat Rules*, and so on.

Field or Control	Description
Repeat Rule	Enter the code for this repeat rule. You can attach this code to academic careers on the Repeat Checking page (Academic Career Table (ACAD_CAREER_TBL) component) and to academic programs on the Repeat/Incomplete page (Academic Program Table component).
Effective Term	Enter the term that this repeat rule becomes effective. Only terms associated with the academic career are available. The system validates the repeat rule by effective term.

Defining Conditions for Repeat Rules

Access the Repeat Rule2 page (**Records and Enrollment > Term Processing > End of Term Processing > Repeat Rule > Repeat Rule2**).

This example illustrates the fields and controls on the Repeat Rule2 page. You can find definitions for the fields and controls later on this page.

Repeat Rule
Repeat Rule2
Repeat Rule3
Repeat Rule Detail 1
Repeat Rule Detail 2
Repeat Rule Detail 3

Academic Institution: PSUNV PeopleSoft University
Academic Career: UGRD Undergraduate

Find | View All
First 2 of 6 Last

Repeat Rule: UNDERGRD **Effective Term:** 0650 2010 Fall

Total Attempts Allowed:

Total Units Allowed:

'Repeat Code Violated: Illegal Repeat

Enrollment Message:

Current Repeat Codes Exempted from Attempts/Units Allowed

1) <input type="text" value="GRFR"/> Exception/Grandfather Clause	5) <input type="text"/>
2) <input type="text" value="PETM"/> Repeat Allowed via Petition	6) <input type="text"/>
3) <input type="text"/>	7) <input type="text"/>
4) <input type="text"/>	8) <input type="text"/>

Field or Control	Description
Total Attempts Allowed	Enter the total number of attempts that a student can make for a course to which this repeat rule applies. The value that you enter should include all attempts of the course, including the first attempt.

Field or Control	Description
Total Units Allowed	<p>Enter the total number of units that a student can take for a course to which this repeat rule applies. The value that you enter should include all units taken for the course, including the units of the first attempt.</p> <p>You can set both total attempts and total units maximums, or you can set just one. If you set both maximums, the Repeat Checking process uses the first maximum that it reaches. If you set neither maximum, the process uses the system defaults, 99 for total attempts and 999 for total units.</p> <hr/> <p>Note: If your institution restricts only the number of times or units that a student can repeat a course <i>within a certain grade point range</i>, use the Repeat Rule Detail 1 page to set these restrictions.</p>
Repeat Code Violated	<p>Enter the repeat code that the Repeat Checking process assigns to a student's enrollment record if the student exceeds the defined attempts or units.</p> <p>For example, if your organization allows students to repeat a course only twice, regardless of any grades that the student receives, you would enter 3 in the Total Attempts Allowed field—one for the initial enrollment plus two additional repeated attempts. Then, if the student attempts to enroll in the course a fourth time which exceeds the total attempts allowed for the rule, the process assigns the Repeat Code Violated value to the course.</p> <p>If your organization chooses to have no restriction on the number of times a student can repeat a course, use the total attempts allowed default value of 99.</p> <p>You must enter a Repeat Code Violated value.</p>
Enrollment Message	<p>You can define how the Repeat Checking process alerts a student during enrollment if the student exceeds the total attempts or units allowed:</p> <ul style="list-style-type: none"> • Select <i>Error</i> to stop the enrollment process and alert the student by displaying an error message. • Select <i>Warning</i> to alert the student by displaying a warning message about the possible consequences of continuing with the enrollment. • Select <i>Ignore</i> if you do not want the Repeat Checking process to issue a message. <p>The enrollment message applies only to repeat checking on enrollment (front end).</p>

Field or Control	Description
<p>Current Repeat Codes Exempted from Attempts/Units Allowed</p>	<p>Use this field to ensure that a repeat code on the current attempt is not counted in the total attempts or units if it is manually assigned during the enrollment process.</p> <p>In the above example, if you set PETM as the repeat code on the current attempt, the class is exempt from exceeding the defined total attempts or units.</p> <p>You can assign repeat codes to a student's enrollment record on the Enrollment Request, Quick Enrollment, or Student Enrollment 1 page.</p>

Defining the Criteria and Order That are Used to Determine a Match When Three or More Repeat Candidates are Processed

Access the Repeat Rule3 page (**Records and Enrollment > Term Processing > End of Term Processing > Repeat Rule > Repeat Rule 3**).

This example illustrates the fields and controls on the Repeat Rule 3 page. You can find definitions for the fields and controls later on this page.

Use the Repeat Rule 3 page to define the criteria and the order that are used by the Repeat Checking process to determine which previous attempt should be matched with the current attempt. This criteria is processed only when multiple previous attempts exist.

Field or Control	Description
<p>Prior Attempt Match Priority</p>	<p>Select the process order in which you want the Repeat Checking process to identify the class to be matched with the current attempt. The selected class is assigned the Set Prior Attempt value that is defined on the Repeat Rule Detail 3 page.</p> <p>Select up to ten processing options to indicate the order in which you want the Repeat Checking process to find a prior attempt match. This logic is invoked only when the student has two or more previous repeat candidates for the class. The process stops when it finds a class that meets the criteria or it finds a blank value in the Prior Attempt Match Priority field.</p> <p>The processing options are:</p> <ul style="list-style-type: none"> • <i>Earn Credit Flag = Y</i> • <i>Best Grade Points Per Unit or Worst Grade Points Per Unit</i> • <i>Units Attempted = Y</i> • <i>Most Recent Term</i> • <i>From Enrollment</i> • <i>From Course Transfer Credit</i> • <i>From Test Transfer Credit</i> • <i>From Other Transfer Credit</i> • <i>Most Recent Date</i> • <i>Include in GPA = Y</i> <p>You can change the order of the criteria to meet the requirements of your institution.</p> <hr/> <p>Note: Regardless of the order that you select for the Prior Attempt Match Priority field, when the Repeat Checking process utilizes either the <i>Best Grade Points Per Unit</i> or <i>Worst Grade Points Per Unit</i> options, it matches only on classes for which the Earn Credit flag = Y.</p> <hr/> <p>Note: When multiple previous attempts exist, the Repeat Checking process invokes the default criteria order to find a match if only minimal criteria are defined—for example, if only From Course Transfer Credit is listed and no match exists, the remaining criteria are processed in default order until a match is found.</p>

Defining Repeat Rule Sequences

Access the Repeat Rule Detail 1 page (**Records and Enrollment > Term Processing > End of Term Processing > Repeat Rule > Repeat Rule Detail 1**).

This example illustrates the fields and controls on the Repeat Rule Detail 1 page. You can find definitions for the fields and controls later on this page.

Field or Control	Description
<p>Seq No (sequence number)</p>	<p>Enter the sequence number for this detail line of the repeat rule. You can have as many rule detail lines as necessary. The sequence number tells the system the order in which to evaluate the detail lines of the repeat rule.</p> <p>For example, you might have four detail lines: one for special permission of all grades; one for the repeats of F grades (those grade points between 0.000 and 0.999), which are permitted twice; one for repeats of D grades (those with grade points between 1.000 and 1.999), which are permitted once; and one for repeats of all other grades (those with grade points between 2.000 and 4.000).</p> <hr/> <p>Important! The sequence number of the detail lines is crucial because as soon as the Repeat Checking process (SRPCERPT) finds a rule detail line that applies, it ignores subsequent detail lines.</p>
<p>Grade Points</p>	<p>Enter the lowest value in a range of grade points per unit for which the detail line of the repeat rule applies.</p>

Field or Control	Description
Through	<p>Enter the highest value in a range of grade points per unit for which the detail line of the repeat rule applies.</p> <p>For example, at PSUNV we use a 4 point grade scale. To apply a detail line to the grade of F, we would enter Grade Points 0.000 and Through 0.999. To apply the detail line to all grades we would enter Grade Points 0.000 and Through 4.000.</p>
Total Attempts Allowed	<p>Enter the number of attempts that a student is allowed within this grade point range. This number includes the original attempt and repeat attempts. The value that you enter should include all attempts of the course, including the first attempt.</p>
Total Units Allowed	<p>Enter the total units for which a student is allowed to receive a grade within this grade point range. The value that you enter should include all units taken for the course, including the units of the first attempt.</p> <p>You can set both total attempts and total units maximums, or you can set just one. If you set both maximums, the Repeat Checking process uses the first maximum that it reaches. If you set neither maximum, the process uses the system defaults, 99 for total attempts and 999 for total units.</p>
Repeat Code Violated	<p>Enter the repeat code that the Repeat Checking process assigns to a student's enrollment record if the student exceeds the defined attempts or units of this detail line of the repeat rule.</p> <p>For example, if your organization allows students to repeat a course only twice, within a certain grade point range, you would enter 3 in the Total Attempts Allowed field—one for the initial enrollment plus two additional repeated attempts. Then, if the student attempts to enroll in the course a fourth time and violates the total attempts allowed for the rule, the process assigns the Repeat Code Violated field value to the course. If your organization has no restriction on the number of times that a student can repeat a course within a certain grade point range, use the Total Attempts Allowed default value of 99.</p> <p>You must enter a Repeat Code Violated field value.</p>
Enrollment Message	<p>You can define how the Repeat Checking process alerts a student during enrollment if the student exceeds the total attempts or units allowed of this detail line of the repeat rule:</p> <ul style="list-style-type: none"> • Select <i>Warning</i> to alert the student by displaying a warning message about the possible consequences of continuing with the enrollment. • Select <i>Ignore</i> if you do not want the Repeat Checking process to issue a message. <p>The enrollment message applies only to repeat checking on enrollment (front end).</p>

Defining Conditions for Repeat Rule Sequences

Access the Repeat Rule Detail 2 page (**Records and Enrollment > Term Processing > End of Term Processing > Repeat Rule > Repeat Rule Detail 2**).

This example illustrates the fields and controls on the Repeat Rule Detail 2 page. You can find definitions for the fields and controls later on this page.

Sometimes a course that the student repeats already has a repeat code assigned. For a student's current course attempt, a repeat code might have been assigned manually during the enrollment process on either the Student Enrollment 1 page, the Quick Enrollment page, or the Enrollment Request page. Use this page in conjunction with the rules that you define on the Repeat Rule Detail 1 page.

Field or Control	Description
Ignore	Select to have the Repeat Checking process (SRPCERPT) ignore this detail line of the repeat rule when evaluating the current course attempt <i>if</i> the repeat code already present for the current course matches any of the repeat code values that you select in the Current Repeat Codes For Ignore/Must Equal Condition group box fields.
Must Equal	Select to have the Repeat Checking process consider this detail line of the repeat rule when evaluating the current course attempt <i>only if</i> the repeat code already present for the current course matches any of the repeat code values that you select in the Current Repeat Codes For Ignore/Must Equal Condition group box fields. In this example, for Seq. No 1 of the Repeat Rule Detail 1 page to be applied, the current attempt of the course must already have repeat code GRFR assigned.

Designating Process Actions for Repeat Rule Sequences

Access the Repeat Rule Detail 3 page (**Records and Enrollment > Term Processing > End of Term Processing > Repeat Rule > Repeat Rule Detail 3**).

This example illustrates the fields and controls on the Repeat Rule Detail 3 page. You can find definitions for the fields and controls later on this page.

Enter codes for each repeat rule detail line that you create for the repeat rule. The Repeat Checking process assigns these repeat codes only if the student's grade point on the prior course attempt falls within the range that you specify on the Repeat Rule Detail 1 page.

Field or Control	Description
Set Current Attempt	Enter a repeat code for the current attempt. The Repeat Checking process assigns the repeat code that you select here to the student's current attempt of the course.
Set Prior Attempt	Enter the repeat code for the prior attempt. The Repeat Checking process assigns the repeat code that you select here to the student's previous attempt of the course.

If Current Attempt is Best Grade

In the **If Current Attempt is Best Grade** group box, select the appropriate repeat codes for the Repeat Checking process to post to a student's enrollment record if the current attempt of the course has the best grade.

If Prior Attempt is Best Grade

In the **If Prior Attempt is Best Grade** group box, select the appropriate repeat codes for the system to post to a student's enrollment record if the prior attempt of the course has the best grade.

If Current and Prior Attempt Grades are the same

In the **If Current and Prior Attempt Grades are the same** group box, select the appropriate repeat codes for the system to post to a student enrollment record when the current and prior attempt grades are the same.

Examples of Multiple Repeat Matching

If multiple repeated courses are counted, the prior attempt that is selected to match with the current attempt is determined by the setup on the Repeat Rule 3 page.

The following options are available:

- Earn Credit Flag = Y
- Best Grade Points Per Unit *or*
- Worst Grade Points Per Unit
- Units Attempted = Y
- Include in GPA = Y
- Most Recent Term
- From Enrollment
- From Course Transfer Credit
- From Test Transfer Credit
- From Other Transfer Credit
- Most Recent Date

Note: In certain scenarios, certain options are inserted into the logic: best/worst grade matches are based on the earn credit flag = Y and the most recent date is analyzed if more than one of the same Most Recent Term exist.

Here are some scenarios in which the following repeat codes are assigned:

- EXCM (Earned Credit and Include in GPA = N)
- GPAI (Earned Credit and Include in GPA = Y)
- PETM (Earned Credit and Include in GPA = Y). Setup to not be overlaid.

Example 1

The course is set up in the course catalog to allow credit for two repeats:

- Fall 2006, grade C
- Fall 2007, grade D
- Fall 2008, grade B

Scenario 1 - *Best Grade*

According to school policy, the student can retake the course an unlimited number of times. No limits exist on the Repeat Rule 1 or Repeat Rule Detail 1 setup.

The course that is selected as the previous course attempt is the course with the best grade points per unit where the **Earn Credit** check box is selected on STDNT_ENRL. In this example, the Fall 2008 attempt is the current attempt, while Fall 2006 is selected as the previous attempt.

Based upon the Repeat Rule Detail 3 setup (If Current Attempt is Best Grade - Current = GPAI, Prior = EXCM), the repeat codes are assigned:

- Fall 2006, grade C EXCM
- Fall 2007, grade D
- Fall 2008, grade B GPAI

Scenario 2 - *Worst Grade*

The course that is selected as the previous course attempt is the course with the worst grade points per unit where the **Earn Credit** check box is selected on STDNT_ENRL. In this example, the Fall 2008 attempt is the current attempt, while Fall 2007 is selected as the previous attempt.

Based upon the Repeat Rule Detail 3 setup (If Current Attempt is Best Grade - Current = GPAI, Prior = EXCM), the repeat codes are assigned:

- Fall 2006, grade C
- Fall 2007, grade D EXCM
- Fall 2008, grade B GPAI

The student takes the class again with an A grade. Again the course that is selected as the previous course attempt is the course with the worst grade points per unit where the **Earn Credit** check box is selected on STDNT_ENRL. In this example, the Fall 2009 attempt is the current attempt, while Fall 2006 is selected as the previous attempt (because Fall 2007 has the Earn Credit flag = N due to the existing EXCM code).

Here is how the enrollment records for this example would look:

- Fall 2006, grade C EXCM
- Fall 2007, grade D EXCM
- Fall 2008, grade B GPAI
- Fall 2009, grade A GPAI

Example 2

The course is set up in the course catalog for no allowable repeats:

- Fall 2006, grade C
- Fall 2007, grade D

Scenario 1 – *Most Recent Term*

According to school policy, the student can retake a course an unlimited number of times, but only the latest attempt counts.

Because the Most Recent Attempt option disregards the **Earn Credit** flag on STNDT_ENRL, this setting always compares with the most recent attempt.

Based on the Repeat Rule Detail 3 setup (If Prior Attempt is Best Grade - Current = GPAI, Prior = EXCM), the repeat codes are assigned:

- Fall 2006, grade C EXCM
- Fall 2007, grade D GPAI

The student takes class Fall 2008, grade A. Fall 2008 is considered the current attempt and Fall 2007 is the Most Recent Attempt. Based upon the Repeat Rule Detail 3 setup (If Current Attempt is Best Grade - Current = GPAI, Prior = EXCM), the repeat codes are assigned as follows because the school policy always counts the latest attempt:

- Fall 2006, ENGL 101, grade C EXCM
- Fall 2007, ENGL 101, grade D EXCM
- Fall 2008, ENGL 101, grade A GPAI

The student takes class Fall 2009, grade B. Fall 2009 is considered the current attempt and Fall 2008 is the Most Recent Attempt. Based upon the Repeat Rule Detail 3 setup (If Prior Attempt is Best Grade - Current = GPAI, Prior = EXCM), the repeat codes are assigned as follows because the school policy always counts the latest attempt:

- Fall 2006, ENGL 101, grade C EXCM
- Fall 2007, ENGL 101, grade D EXCM
- Fall 2008, ENGL 101, grade A EXCM
- Fall 2009, ENGL 101, grade B GPAI

Scenario 2 – *Most Recent Term with repeat code to not be overlaid*

School policy (as defined on Repeat Rule Detail 1) does not allow a repeat on grade points < 2.000, but the student petitions and receives permission. The following repeat codes are manually assigned after the student completes Fall 2007:

- Fall 2006, grade D EXCM
- Fall 2007, grade C PETM

The student takes class Fall 2008, grade A. Fall 2008 is considered the current attempt and Fall 2007 is the prior attempt. The Repeat Rule Detail 3 is setup as If Current Attempt is Best Grade - Current = GPAI, Prior = EXCM. While it still matches on Fall 2007, because the PETM is not to be overridden, the repeat codes are assigned as follows:

- Fall 2006, ENGL 101, grade C EXCM
- Fall 2007, ENGL 101, grade D PETM
- Fall 2008, ENGL 101, grade A GPAI

Scenario 3 – Most Recent Term – Multiple Same Terms exist – Most Recent Date

When multiples of the same Most Recent Term exist, the repeat engine analyzes the session start dates to determine the Most Recent Date.

- Summer 2006, grade D (session 1 – June 1 start date)
- Summer 2006, grade D (session 2 – July 5 start date)

Because the start date of session 2 is the most recent date, it is determined to be the current attempt while session 1 which has an earlier start date is considered the prior attempt. Based on the Repeat Rule Detail 3 setup (If Current and Prior Attempt are Same Grade - Current = GPAI, Prior = EXCM), the repeat codes are assigned:

- Summer 2006, grade C (session 1 – June 1 start date) EXCM
- Summer 2006, grade D (session 2 – July 5 start date) GPAI

Student takes class Fall 2008, grade A. Fall 2008 is considered the current attempt and Summer 2006 session 2 is the prior attempt (based on the Most Recent Date). Based on the Repeat Rule Detail 3 setup (If Current Attempt is Best Grade - Current = GPAI, Prior = EXCM), the repeat codes are assigned as follows because the school policy always counts the latest attempt:

- Summer 2006, grade C (session 1 – June 1 start date) EXCM
- Summer 2006, grade D (session 2 – July 5 start date) EXCM
- Fall 2008, ENGL 101, grade A GPAI

Note: When Most Recent Date is used as a criteria, the session start date is the first determiner. If the start dates are the same, then the session end dates are used as the determiner.

Scenario 4 – Most Recent Term – Enrollment before Transfer

According to school policy, the most recent attempt is always counted, but internal enrollments are counted before transfer credit. To accommodate such a policy the repeat checking matching option might be setup as follows:

- Most Recent Term
- From Enrollment

When multiples of the same Most Recent Term exist, the repeat engine analyzes the session start dates to determine the Most Recent Date.

- Fall 2006, grade C (session 1) Enrollment
- Fall 2006, grade C (session 1) Transfer Credit

Based on the Repeat Rule Detail 3 setup (If Current and Prior Attempt are Same Grade - Current = GPAI, Prior = EXCM), the repeat codes are assigned:

- Fall 2006, grade C (session 1) Enrollment GPAI
- Fall 2006, grade C (session 1) Transfer Credit EXCM

Student takes class Fall 2008, grade A. Fall 2008 is considered the current attempt and Fall 2006 session 1 Enrollment is the prior attempt. Based on the Repeat Rule Detail 3 setup (If Current Attempt is Best Grade - Current = GPAI, Prior = EXCM), the repeat codes are assigned as follows because the school policy always counts the latest attempt:

- Fall 2006, grade C (session 1) Enrollment EXCM
- Fall 2006, grade C (session 1) Transfer Credit EXCM
- Fall 2008, grade A GPAI

Related Links

[Running the Repeat Rule Checking Process in Batch](#)

Example of a Repeat Rule

The following example shows how your institution might set up a repeat rule with two detail lines. This example defines a repeat rule that allows students to repeat a course twice only or earn up to 12 units in a repeated course. In addition, students must seek special permission to repeat classes. If students receive a D or F in the course, they can repeat the course only once rather than twice. The Repeat Rule2 page might look like this:

Repeat Rule	Repeat Rule2	Repeat Rule3	Repeat Rule Detail 1	Repeat Rule Detail 2	Repeat Rule Detail 3
Academic Institution: PSUNV PeopleSoft University					
Academic Career: UGRD Undergraduate					
Find View All First 2 of 6 Last					
Repeat Rule:	UNDERGRD	Effective Term:	0650	2010 Fall	+ -
Total Attempts Allowed:	<input type="text" value="3"/>				
Total Units Allowed:	<input type="text" value="12.00"/>				
Repeat Code Violated:	<input type="text" value="ILGL"/> ILGL	Illegal Repeat			
Enrollment Message:	<input type="text" value="Warning"/>				
Current Repeat Codes Exempted from Attempts/Units Allowed					
1) <input type="text" value="PETM"/>	Repeat Allowed via Petition	5) <input type="text"/>			
2) <input type="text"/>		6) <input type="text"/>			
3) <input type="text"/>		7) <input type="text"/>			
4) <input type="text"/>		8) <input type="text"/>			

- The **Total Attempts Allowed** field is set to 3.

Undergraduate students can repeat courses twice only (first attempt plus two repeats equals three total attempts).

- Undergraduate students can repeat courses for a total of 12 units, as specified in the **Total Units Allowed** field.
- We enter *ILGL* (illegal repeat) in the **Repeat Code Violated** field.

If the process finds a student in violation of the total attempts allowed or total units allowed, the process assigns the *ILGL* repeat code to the student's enrollment record for the repeated course.

- The **Enrollment Message** field is set to *Warning*.

If the Repeat Checking process identifies the repeat on enrollment as exceeding the total attempts allowed or total units allowed, it issues a warning message to alert the student about the possible consequences of continuing with the enrollment.

- We enter a repeat code exemption.

If a student's current term enrollment contains the *PETM* (repeat allowed via petition) repeat code, the repeat rule does not prevent the enrollment—this exemption would also override the total attempts allowed or total units allowed maximums on the Repeat Rule2 page during back-end processing. For the student's enrollment to contain this repeat code, manually assign it to the enrollment record on the Student Enrollment 1 page, the Quick Enrollment page, or the Enrollment Request page. In addition, the assumption is that the exemption codes are included in special permission rules where these codes are established as Must Equal conditions on the Repeat Rule Detail 2 page, though this is not required.

To require that students seek special permission to repeat classes, the Rule Detail 1 page might look like this:

The screenshot displays the 'Repeat Rule Detail 1' configuration page. At the top, there are navigation tabs for 'Repeat Rule', 'Repeat Rule2', 'Repeat Rule3', 'Repeat Rule Detail 1' (selected), 'Repeat Rule Detail 2', and 'Repeat Rule Detail 3'. Below the tabs, the 'Academic Institution' is set to 'PSUNV' (PeopleSoft University) and the 'Academic Career' is 'UGRD' (Undergraduate). The 'Repeat Rule' is 'UNDERGRD' and the 'Effective Term' is '0650' (2010 Fall). A 'Repeat Rule Sequence' table is shown with one entry: 'Seq. No.' 1, 'Grade Points' 0.000 through 4.000, 'Total Attempts Allowed' 99, 'Total Units Allowed' (empty), 'Repeat Code Violated' 'ILGL' (Illegal Repeat), 'Enrollment Message' 'Ignore', and 'Description' 'Special Permission'. The 'Long Description' field contains 'Special permission to repeat course'.

- The sequence number is 1.

The Repeat Checking process considers this detail line first.

- The process includes any repeated courses that have a grade-points-per-unit range from 0.000 through 4.000.

This range ensures that the Repeat Checking process evaluates every attempt, regardless of the student's grade. Because this is our most restrictive rule, we want the Repeat Checking process to consider this rule first.

- Because the student must have special permission to repeat a course, we enter the value of 99 in the **Total Attempts Allowed** field.

A student can repeat a class as many times as special permission is given.

- No total units allowed restriction exists for this detail line of the repeat rule.

The Repeat Rule Detail 2 page might look like this for the special permission detail line:

Repeat Rule Repeat Rule2 Repeat Rule3 Repeat Rule Detail 1 **Repeat Rule Detail 2** Repeat Rule Detail 3

Academic Institution: PSUNV PeopleSoft University
Academic Career: UGRD Undergraduate

Find | View All First 2 of 6 Last

Repeat Rule: UNDERGRD **Effective Term:** 0650 2010 Fall

Find | View All First 1 of 1 Last

Seq. No: 1

Ignore **Must Equal**

Current Repeat Codes For Ignore/Must Equal Condition

1) PETM 🔍	Repeat Allowed via Petition	5) <input type="text"/> 🔍
2) <input type="text"/> 🔍		6) <input type="text"/> 🔍
3) <input type="text"/> 🔍		7) <input type="text"/> 🔍
4) <input type="text"/> 🔍		8) <input type="text"/> 🔍

The Repeat Checking process applies the codes on the Repeat Rule Detail 3 page if the current course attempt has been coded with *PETM*. The Rule Detail 3 page might look like this for the special permission detail line:

Repeat Rule	Repeat Rule 2	Repeat Rule 3	Repeat Rule Detail 1	Repeat Rule Detail 2	Repeat Rule Detail 3
Academic Institution:	PSUNV	PeopleSoft University			
Academic Career:	UGRD	Undergraduate			
Find View All 2 of 6					
Repeat Rule:	UNDERGRD	Effective Term:	0650 2010 Fall		
Find View All 1 of 1					
Seq. No:	1				
If Current Attempt is Best Grade					
Set Current Attempt:	REXC	Repeated - Excluded from Stats			
Set Prior Attempt:	REIG	Repeated - Included in GPA			
If Prior Attempt is Best Grade					
Set Current Attempt:	REIG	Repeated - Included in GPA			
Set Prior Attempt:	REXC	Repeated - Excluded from Stats			
If Current and Prior Attempt Grades are the same					
Set Current Attempt:	REXC	Repeated - Excluded from Stats			
Set Prior Attempt:	REIG	Repeated - Included in GPA			

- If the current attempt of the class has the best grade, the system codes that class with *REXC* and sets the prior attempt to *REIG*.
- If the prior attempt of the class has the best grade, the system codes that class with *REXC* and sets the current attempt to *REIG*.
- If the current and prior attempt have the same grade, the system codes the current attempt as *REXC* and the prior attempt as *REIG*.

If the current course attempt does not meet the criteria (current attempt has PETM) then the program moves to the next sequence detail line.

For the next detail line of the repeat rule, we want to specify that students can repeat D and F grades only once. The Repeat Rule Detail 1 page looks like this:

- The sequence number is 2.

The system considers this detail line of the repeat rule second in the Repeat Checking process.

- Repeated courses that have a grade-points-per-unit range from 0.000 through 1.999 are included.

Note that the grade range is concerned with only the grade of the *prior* course in the matched pair.

- A student is permitted to repeat a D or F grade once, and this is reflected in the **Total Attempts Allowed** field value of 2.

Course attempts include all attempts of the course, not just the repeats. In addition, the allowable course catalog repeats constitute the first attempt in this total attempts allowed. Therefore, if the catalog allows four attempts, all four of those attempts would constitute the first attempt in this number.

- No total units allowed restriction exists for this rule.
- If students violate the number of attempts, the Repeat Checking process assigns the repeat code *ILGL* to the student's enrollment record for the current attempt, as defined in the **Repeat Code Violated** field.

The Repeat Rule Detail 2 page might look like this for this detail line of the repeat rule:

Current Repeat Codes For Ignore/Must Equal Condition			
1)	EXCM	Repeated - Excluded	5) <input type="text"/>
2)	RATT	Repeat Forgiveness Attempt	6) <input type="text"/>
3)	RFCP	Repeat Forgiven - Included	7) <input type="text"/>
4)	RFAT	Repeat Forgiven - Excluded	8) <input type="text"/>

On this page, the system does not apply this rule detail sequence if the current attempt has any one of the selected repeat codes attached to it.

The Repeat Rule Detail 3 page might look like this for this detail line of the repeat rule:

If Current Attempt is Best Grade

Set Current Attempt: Repeat for GPA Improvement

Set Prior Attempt: Replaces Previous Attempt

If Prior Attempt is Best Grade

Set Current Attempt: Repeat for GPA Improvement

Set Prior Attempt: Replaces Previous Attempt

If Current and Prior Attempt Grades are the same

Set Current Attempt: Repeat for GPA Improvement

Set Prior Attempt: Replaces Previous Attempt

Note: When the Repeat Checking process finds a matched pair of courses that violates a detail line of the repeat rule, it moves on to the next pair of matching courses.

Setting Up Repeat Checking for Academic Institutions

This section discusses how to set up repeat checking for academic institutions.

Page Used to Set Up Repeat Checking for Academic Institutions

Page Name	Definition Name	Navigation	Usage
Academic Institution 5	INSTITUTION_TABLE5	Set Up SACR > Foundation Tables > Academic Structure > Academic Institution Table > Academic Institution 5	Set repeat checking controls for academic institutions. Academic institution level is the highest level of control for the automatic Repeat Checking process.

Setting Repeat Checking Controls for Academic Institutions

Access the Academic Institution 5 page (Set Up SACR > Foundation Tables > Academic Structure > Academic Institution Table > Academic Institution 5).

This example illustrates the fields and controls on the Academic Institution 5 page. You can find definitions for the fields and controls later on this page.

The screenshot displays the configuration page for 'Academic Institution 5' in the PeopleSoft University system. The page includes several sections with various controls:

- Page Navigation:** Tabs for Academic Institution 1 through 6, with 'Academic Institution 5' selected.
- Page Header:** 'Academic Institution PSUNV PeopleSoft University' and navigation links like 'Find | View All', 'First', '1 of 1', and 'Last'.
- Effective Date:** 01/01/1900, **Status:** Active.
- Repeat Check Section:**
 - *Process on Enrollment: No (dropdown), with a checkbox for 'Temporarily Suspend Repeat Check on Enrollment'.
 - *Repeat Grade Check: Never (dropdown), with a checkbox for 'Temporarily Suspend Repeat Check on Grade Input'.
 - Process on Transfer Credit:
 - Repeat Check at Topic Level:
 - Capture Repeat Assignment Date:
 - On Enrollment Process
 - On Repeat Process
 - Grade Match Option: Best grade
- Academic Program Options Section:**
 - Select Acad Prog During Enroll
 - Set Form Of Study to Enrollment on Program Change
- Waitlist Options Section:**
 - Check Service Indicator
- Class Enrollment Total - Facility Capacity Edit Section:**
 - Edit facility capacity against enrollment total on class limit override
 - Edit facility capacity against enrollment total on class limit permission

Field or Control	Description
Process on Enrollment	<p>Use this field to activate or deactivate the automatic Repeat Checking process at enrollment time (front-end processing) for this entire academic institution. Enter one of the following values.</p> <p><i>Yes</i>: Enter if you want the Repeat Checking process to automatically run during enrollment for this academic institution. This is a front-end process that checks repeats, based on repeat rules that you set up in the Repeat Rule component. The process is front-end because it checks for repeats at enrollment, rather than when you post grades. You can run the Repeat Checking process for this entire academic institution, for students in specific academic careers within the academic institution, or for students in specific academic programs within the academic careers. When you enter <i>Yes</i> at the academic institution level, this value cascades down to the academic career and academic program levels. Thus, when you enter <i>Yes</i> for an academic institution, every academic career and academic program within that institution is also set to <i>Yes</i>. However, you can still manually enter <i>No</i> at the academic career and academic program levels.</p> <p><i>No</i>: Enter if you <i>do not</i> want the Repeat Checking process to run for this entire academic institution during enrollment. If you enter <i>No</i> here, the system sets the Process on Enrollment field at the academic career and academic program levels to <i>No</i> and renders them unavailable.</p> <hr/> <p>Warning! When you enter <i>Yes</i> at the academic institution level, every academic career and program within this institution is set to <i>Yes</i>. The same is true if you enter <i>No</i>. If you change the setting from <i>Yes</i> to <i>No</i>, you also change the settings for every academic career and program within this institution. To reset the fields, you must go into each academic career and academic program and change them manually.</p> <hr/>

Field or Control	Description
Repeat Grade Check	<p>Use this field to activate or deactivate repeat checking on grade input for this entire academic institution. The available values are:</p> <p><i>All Crse</i> (all courses): Enter if you want the Repeat Checking process to run during grade input (on the Enrollment Request page) for every course in this academic institution. This is a back-end process that checks for repeats based on repeat rules that you set up in the Repeat Rule component. The process is back-end because it checks for repeats when you post grades, after the student has already completed the class. You can run the Repeat Checking process for this entire academic institution, for specific academic careers within the academic institution, or for specific academic programs within academic careers. When you enter <i>All Crse</i> at the academic institution level, the system runs the Repeat Checking process for every academic career within this academic institution that has a value of <i>All Crse</i> in the Repeat Grade Check field in the Academic Career Table component. Similarly, if you select <i>All Crse</i> at the academic career level, the system looks at the repeat grade check setting at the academic program level to determine whether to run the Repeat Checking process for each academic program within the academic career.</p> <p><i>Never</i>: Enter if you do not want the Repeat Checking process to run during grade input on the Enrollment Request page. If you enter <i>Never</i> here, the system sets the Repeat Grade Check field at the academic career and academic program levels to <i>Never</i>; and renders the field unavailable.</p> <p><i>Only Rep</i> (only repeats): Enter if you want to run the process against all class enrollments on a student's enrollment record (STDNT_ENRL table) where the repeat candidate field is set to <i>Y</i>. The only time that the system does not set the repeat candidate field to <i>Y</i> is for class enrollments that are entered through the Enrollment component or for classes for which the course is defined as an allowable repeat through the Course Catalog component.</p> <hr/> <p>Warning! When you enter <i>All Crse</i> at the academic institution level, every academic career and academic program within this academic institution is also set to <i>All Crse</i>. The same is true if you enter <i>Never</i>. If you change the setting from <i>All Crse</i> to <i>Never</i>, you also change the settings for every academic career and program within this academic institution. To reset the fields, you must access each academic career and program and change them manually.</p> <hr/> <p>Note: The automatic Repeat Checking process runs only when you post grades using the Enrollment Request page. The process <i>does not</i> run when you post grades using the grade roster, Quick Enrollment page, or Student Enrollment 1 page.</p>

Field or Control	Description
<p>Temporarily Suspend Repeat Check on Enrollment</p>	<p>Select to temporarily suspend the Repeat Checking process at enrollment for this academic institution. This check box enables you to temporarily suspend repeat rule checking during peak enrollment periods, when the Repeat Checking process would seriously impair performance. After the peak period has passed, return to this page and clear this check box to re-enable the Repeat Checking process on enrollment. Use this functionality sparingly, because students attempting to repeat a class are not warned about a possible illegal repeat.</p> <p>Selecting this check box renders the Process on Enrollment and Temporarily Suspend Repeat Check on Enrollment fields at the academic career and program levels unavailable.</p> <p>However, selecting this check box does not change the settings in the Process on Enrollment fields at the academic career or program levels. Note that this is the main difference between the cascading functionality through the Process on Enrollment and Repeat Grade Check fields and the suspension functionality—suspension does not alter the previous settings of lower levels.</p>
<p>Temporarily Suspend Repeat Check on Grade Input</p>	<p>Select to temporarily suspend the Repeat Checking process during grade input for this academic institution. This check box enables you to temporarily suspend repeat checking during peak grading periods, when the Repeat Checking process would seriously impair performance. After the peak period has passed, come back to this page and clear this check box to re-enable the Repeat Checking process on grade input. Use this functionality sparingly because the system does not check for repeats, so you will not know whether any repeat rules apply to students until you run the Repeat Checking process manually. Selecting this check box renders the Repeat Grade Check and Temporarily Suspend Repeat Check on Grade Input fields at the academic career and program levels unavailable. However, selecting this check box does not change the settings in the Repeat Grade Check fields at the academic career or program levels. Note that this is the main difference between the cascading functionality through the Process on Enrollment and Repeat Grade Check fields and the suspension functionality—suspension does not alter the previous settings of lower levels.</p>
<p>Process on Transfer Credit</p>	<p>When you post on line or batch transfer credit, use this check box to include or exclude the Repeat Checking process. The check box is selected by default.</p> <hr/> <p>Note: If the value in the Scope field on the Repeat Checking page is <i>All Work for Term</i> or <i>Transfer/Test Credit</i>, the Repeat Checking process assigns repeat codes to transfer credit even though the Process on Transfer Credit check box is <i>not</i> selected.</p> <p>If you do not want to run repeat checking on transfer credit, clear the Process on Transfer Credit check box and enter a value of <i>Student Enrollments Only</i> in the Scope field on the Repeat Checking page.</p> <hr/>

<i>Field or Control</i>	<i>Description</i>
Repeat Check at Topic Level	Select if you want to enable repeat checking at the course topic level for this institution. Define repeat rules in the Repeat Rules component. You can disable repeat checking at the course topic level for a specific course on the Course Catalog - Catalog Data page.
Capture Repeat Assignment Date	Select the On Enrollment Process check box if you want the Repeat Date (REPEAT_DT) populated on STDNT_ENRL when repeats are processed during the Enrollment process. Select the On Repeat Process check box if you want the Repeat Date (REPEAT_DT) populated on STDNT_ENRL when repeats are processed during the Repeat Checking process.
Grade Match Option	Use the Repeat Rule3 page to establish grade match options.

Academic Program Options

<i>Field or Control</i>	<i>Description</i>
Select Acad Prog During Enroll (select academic program during enrollment)	Select to enable the Academic Program field on all enrollment pages that allow users to select an academic program to associate with each class. The field is available within enrollment only when a student is matriculated in more than one program. Clearing this check box hides the Academic Program field on all enrollment pages and associates the student's primary academic program with each class. See "Setting Up Self-Service Options" (Campus Solutions Application Fundamentals).

Waitlist Options

<i>Field or Control</i>	<i>Description</i>
Check Service Indicator	Select if you want to check service indicators when you run the Waitlist Process.

Class Enrollment Total - Facility Capacity Edit

Use this region to set whether to show a warning or rejection message when you don't want:

- Administrators to override class limits if it exceeds facility capacity.

- Administrators or students to use class permission if the enrollment will exceed facility capacity.

Field or Control	Description
Edit facility capacity against enrollment total on class limit override	<p>Select this option to decide whether you want to display a warning or rejection message to inform administrators that the institution doesn't allow the total class enrollment to exceed facility capacity.</p> <p>The message appears when administrators attempt to override the class limit during an enrollment transaction, and that override would exceed the facility capacity for that class section.</p>
Edit facility capacity against enrollment total on class limit permission	<p>Select this option to display a warning or rejection message that informs administrators or students that the institution doesn't allow the total class enrollment to exceed the facility capacity.</p> <p>The message appears when either administrators or students attempt to use a Class Permission number during an enrollment transaction to override class limits, and that override would exceed the facility capacity for that class section.</p>

See [Managing Enrollment Capacity](#).

Setting Up Repeat Checking for Academic Careers

This section discusses how to set repeat checking controls for academic careers.

Page Used to Set Up Repeat Checking for Academic Careers

Page Name	Definition Name	Navigation	Usage
Repeat Checking	ACAD_CAR_RPT_CHK	Set Up SACR > Foundation Tables > Academic Structure > Academic Career Table > Repeat Checking	Set repeat checking controls at the academic career level. Also, link a repeat rule to an academic career.

Setting Repeat Checking Controls for Academic Careers

Access the Repeat Checking page (**Set Up SACR > Foundation Tables > Academic Structure > Academic Career Table > Repeat Checking**).

This example illustrates the fields and controls on the Repeat Checking page. You can find definitions for the fields and controls later on this page.

Repeat Checking
Self Service Options

Academic Institution: PSUNV PeopleSoft University

Academic Career: UGRD Undergraduate

[Find](#) | [View All](#) | First ◀ 1 of 1 ▶ Last

Effective Date: 01/01/1900 **Status:** Active

Repeat Check

Scheme: 🔍 Undergraduate

Repeat Rule: 🔍 Undergraduate Grading Rule

*Process on Enrollment: ▼ Temporarily Suspend Repeat Check on Enrollment

*Repeat Grade Check: ▼ Temporarily Suspend Repeat Check on Grade Input

Course Catalog Repeats

*Course Catalog Repeat Message: ▼

<i>Field or Control</i>	<i>Description</i>
Scheme	Enter a repeat scheme for this academic career. Repeat schemes contain the set of all valid repeat codes for this academic career.
Repeat Rule	Enter a repeat rule to assign to this academic career. Repeat rules contain the conditions that define your repeat checking policies. For example, the repeat rule can specify how many times a student can take courses given certain conditions, such as the grades earned. Settings at the academic career level serve as defaults for all of the academic programs within this academic career wherein a repeat rule is not attached to the academic program. Repeat rules must be assigned to an academic career for the Repeat Checking process to function at enrollment or grade input. Define repeat rules on the Repeat Rule page.

Field or Control	Description
Process on Enrollment	<p>Use this field to activate the Repeat Checking process for the academic career at enrollment. Values are <i>Yes</i> and <i>No</i>.</p> <p>Enter <i>Yes</i> if you want the Repeat Checking process to run during enrollment for this academic career. This front-end process checks repeats based on repeat rules that you set up in the Repeat Rule component. The process is front-end because it checks for repeats at enrollment rather than when you post grades. You can run the Repeat Checking process for the entire academic institution, for students in particular academic careers within the academic institution, and for students in primary academic programs within academic careers. When you enter <i>Yes</i> at the academic career level, the system runs the Repeat Checking process for all students in every primary academic program within this academic career that has a value of <i>Yes</i> in the Process on Enrollment field in the Academic Program Table component. This field is unavailable if <i>No</i> is entered at the academic institution level.</p> <hr/> <p>Warning! When you enter <i>Yes</i> at the academic career level, every academic program within this academic career is also set to <i>Yes</i>. The same is true if you enter <i>No</i>. If you change the setting from <i>Yes</i> to <i>No</i>, you also change the settings for every academic program within this academic career. To reset the fields, you must go into each academic program and change them manually.</p> <hr/>

Field or Control	Description
Repeat Grade Check	<p>Use this field to activate the Repeat Checking process on grade input for this academic career.</p> <p><i>All Crse</i> (all courses): Enter this value if you want the Repeat Checking process to run during grade input for this academic career. This back-end process checks repeats based on repeat rules that you set up in the Repeat Rule component. The process is back-end because it checks for repeats when you post grades on the Enrollment Request page, after the student has completed the class. You can run the Repeat Checking process for the entire academic institution, for academic careers within the academic institution, and for academic programs within academic careers. When you enter <i>All Crse</i> at the academic career level, the system runs the Repeat Checking process for every academic program within this academic career that has a value of <i>All Crse</i> in the repeat grade check field in the Academic Program Table component. This field is unavailable if <i>Never</i> is entered at the academic institution level.</p> <p><i>Never</i>: Enter this value if you do not want the Repeat Checking process to run during grade input on the Enrollment Request page. If you enter <i>Never</i> here, the system sets the Repeat Grade Check field at the academic program level to <i>Never</i> and renders the field unavailable. Likewise, the Repeat Grade Check field on this page is unavailable when you enter <i>Never</i> at the academic institution level.</p> <p><i>Only Rep</i> (only repeats): Enter if you want to run the process against all class enrollments on a student's enrollment record (STDNT_ENRL table) for which the repeat candidate field is set to <i>Y</i>. The only time that the system does not set the repeat candidate field to <i>Y</i> is for class enrollments that are entered through the Enrollment component or for classes for which the course is defined as an allowable repeat through the Course Catalog component.</p> <hr/> <p>Warning! When you enter <i>Never</i>, the system changes the setting in the Repeat Grade Check field for every academic program to <i>Never</i>. To reset the fields, you must go into each academic program and change them manually.</p> <hr/> <p>Note: The automatic Repeat Checking process runs only when you post grades using the Enrollment Request page. The process <i>does not</i> run when you post grades using the grade roster, Quick Enrollment page, or Student Enrollment 1 page.</p>

Field or Control	Description
Temporarily Suspend Repeat Check on Enrollment	<p>Select to temporarily suspend the Repeat Checking process during enrollment for this academic career. This option temporarily suspends repeat checking during peak enrollment periods, when the Repeat Checking process would seriously impair performance. After the peak period, return to this page and clear this check box to re-enable the Repeat Checking process on enrollment. Use this functionality sparingly, because students attempting to repeat a class are not warned about a possible illegal repeat. Selecting this check box renders the Process on Enrollment and Temporarily Suspend Repeat Check on Enrollment fields at the academic program level unavailable. However, selecting this check box does not change the settings in the Process on Enrollment fields at the academic program level.</p>
Temporarily Suspend Repeat Check on Grade Input	<p>Select to temporarily suspend the Repeat Checking process during grade input for this academic career. This check box enables you to temporarily suspend repeat checking during peak grading periods, when the Repeat Checking process would seriously impair performance. After the peak period has passed, return to this page and clear this check box to re-enable the Repeat Checking process on grade input. Use this functionality sparingly because the system does not check for repeats while grading through the Enrollment Request page, so you will not know whether any repeat rules apply to students until you run the Repeat Checking process in batch. Selecting this check box renders the Repeat Grade Check and Temporarily Suspend Repeat Check on Grade Input fields at the academic program level unavailable. However, selecting this check box does not change the settings in the Repeat Grade Check fields at the academic program level.</p>

Field or Control	Description
Course Catalog Repeat Message	<p>Enter the message type that the system displays during enrollment when the course catalog Allowable Repeats process detects that the student has previously taken the course. The choices are:</p> <p><i>Error:</i> Issues an error and prevents the student from enrolling in the repeated class.</p> <p><i>Warning:</i> Issues a warning that the repeatable limit, as established on the course catalog, has been exceeded. The system allows the student to enroll in the class.</p> <p><i>None:</i> Issues no warning or error and allows the student to enroll in the class.</p> <p>The course catalog Allowable Repeats process runs at class enrollment and looks at settings at the course catalog level to see whether a course can be repeated. This process does not affect student statistics; it is used to determine whether a student can repeat a course. When the completions maximum or units maximum is exceeded, the system issues enrollment messages, depending on the message type selected (assuming that the course catalog repeats functionality is in effect).</p> <p>The system renders the Course Catalog Repeat Message field unavailable when you enter <i>Yes</i> in the Process on Enrollment field. The system renders the field unavailable because when you run the Repeat Checking process on enrollment, the course catalog Allowable Repeats process does not issue a message when a repeated course is in violation of the course catalog repeat maximums. The Repeat Checking process analyzes the student's enrollment records for repeated courses and issues warnings only after the course catalog Allowable Repeats process identifies an enrollment that exceeds the completions maximum or units maximum set on the Catalog Data page of the Course Catalog component.</p>

Setting Up Repeat Checking for Academic Programs

This section discusses how to set repeat checking controls for academic programs.

Page Used to Set Up Repeat Checking for Academic Programs

Page Name	Definition Name	Navigation	Usage
Repeat/Incomplete	INCOMPLETE_GRADE	Set Up SACR > Foundation Tables > Academic Structure > Academic Program Table > Repeat/ Incomplete	Set repeat checking controls at the academic program level and link repeat rules to academic programs.

Setting Repeat Checking Controls for Academic Programs

Access the Repeat/Incomplete page ((Set Up SACR > Foundation Tables > Academic Structure > Academic Program Table > Repeat/Incomplete).

Linking a repeat rule to an academic program is the last step in setting up repeat checking. However, this is not a required step. If you *do not* attach a repeat rule at the academic program level, the Repeat Checking process uses the repeat rule set for the academic career to which the academic program belongs. Thus, link a repeat rule to an academic program *only if you do not* want the Repeat Checking process to use the repeat rule that is specified for the academic career.

See “Defining Repeating Rules and Grade Lapse Rules for Academic Programs” (Campus Solutions Application Fundamentals).

Chapter 5

Setting Up the Course Catalog

Understanding the Course Catalog

When you first set up your course catalog, make sure to do some preliminary work to research how your institution structures course prerequisites and corequisites, and how new requisites are created and approved. Our course requisite design lets you structure requirements that can be shared among many courses. Requirements can encompass prerequisite courses, grade point average (GPA) and unit requirements, and course lists, among other factors. To minimize duplicate data entry, plan your requisite requirements carefully. In addition, note that the data you enter in the course catalog is provided by default to the schedule of classes. This feature is key because it saves you data entry time when you schedule classes. The Course Catalog (CRSE_CATALOG) component uses effective dating, which enables you to track historical course changes and to prepare for curriculum changes in the future.

Prerequisites for Setting Up the Course Catalog

Before you can define courses in the course catalog, you must set up the following data for your institution:

- Institution codes
- Academic groups
- Subject area
- Campuses
- Academic organizations
- Academic careers
- (Optional) Room characteristics
- (Optional) Requirement designations
- (Optional) Course attributes

Related Links

[“Defining Academic Institutions” \(Campus Solutions Application Fundamentals\)](#)

[“Defining Academic Groups” \(Campus Solutions Application Fundamentals\)](#)

[“Defining Subject Areas” \(Campus Solutions Application Fundamentals\)](#)

[“Setting Up Campuses” \(Campus Solutions Application Fundamentals\)](#)

[“Defining Academic Organizations” \(Campus Solutions Application Fundamentals\)](#)

[“Defining Academic Careers” \(Campus Solutions Application Fundamentals\)](#)

[Defining Buildings, Rooms, and Classroom Facilities](#)

[Defining Requirement Designations](#)

[Setting Up Catalog and Schedule Options](#)

Creating Course Offerings

This section provides an overview of course offerings, lists prerequisites, and discusses how to:

- Define course catalog data.
- Define course offerings.
- Define course components.
- (NZL) Set up government reporting data.
- Link milestones to course data.
- Interface course offerings with the general ledger.

Understanding Course Offerings

The Course Catalog component contains several pages that enable you to enter all information for a course offering: the course title, units, workload hours, components, description, topics, requisites, and so on. We review each of the pages in the order in which you use them to set up a new course offering. In our design, a course offering includes all components of a course, such as lecture, laboratory, and discussion.

You complete these steps to create a course:

1. Define the course title, description, units, grade bases, repeat rules, equivalent course groups, topics, and course attributes on the Catalog Data page.
2. Define the course offering number, catalog number, subject area, academic organization, Classification of Instructional Programs (CIP) and Higher Education General Information Survey (HEGIS) codes, and attach requirement designations on the Offerings page.
3. Define the course components and the final exam and room characteristics on the Components page.
4. Map courses as course item types to specific general ledger accounts on the GL Interface page.

Prerequisites

After you set up your institution codes, academic groups, subject areas, campuses, academic organizations, and academic careers, you can set up the basics of your course catalog. At this point, you should have set up room characteristics, requirement designations, enrollment requisites, and course attributes also.

Pages Used to Create Course Offerings

<i>Page Name</i>	<i>Definition Name</i>	<i>Navigation</i>	<i>Usage</i>
Catalog Data	CRSE_CATALOG	Curriculum Management > Course Catalog > Course Catalog > Catalog Data	Define course titles, course units, grade bases, topics, and repeat rules.
Offerings	CRSE_CATALOG_OFFER	Curriculum Management > Course Catalog > Course Catalog > Offerings	Define course numbers, link academic organizations to course offerings, and so on.
Components	CRSE_CATALOG_CMPNT	Curriculum Management > Course Catalog > Course Catalog > Components	Define components, such as lecture, laboratory, and discussion, as well as instructor workload hours, room characteristics, additional fees, and final exams.
Crse Catalog NZL (course catalog New Zealand)	SSR_CRS_CAT_NZL	Curriculum Management > Course Catalog > Course Catalog > Crs Catalog NZL	<p>Set up SDR and EFTS data for a course.</p> <hr/> <p>Note: The fields on this page are available only if you select the New Zealand Catalog, SDR, EFTS, StudyLink check box on the Academic Institution 6 page. You should also select the New Zealand NSI and SDR Personal Data, SDR Degree check box on the SA Features page in the Student Administration Installation component.</p> <hr/>
Course/Milestone Link	SSR_CRS_MILESTN	Curriculum Management > Course Catalog > Course Catalog > Course/ Milestone Link	Link milestones to courses and (NZL) establish links between a course and unit standard milestones.

Page Name	Definition Name	Navigation	Usage
GL Interface (general ledger interface)	CRSE_OFFER_GL	Curriculum Management > Course Catalog > Course Catalog > GL Interface	Map course fees as item types to their proper general ledger accounts. The system generates charges to the student's account based on the course code you define on this page and offsets these charges based on the general ledger you define on this page. Your office should coordinate the information on this page with your controller's office.

Defining Course Catalog Data

Access the Catalog Data page (**Curriculum Management > Course Catalog > Course Catalog > Catalog Data**).

This example illustrates the fields and controls on the Catalog Data page (1 of 2). You can find definitions for the fields and controls later on this page.

Catalog Data
Offerings
Components
GL Interface

Course ID: 001001

Find | View All
First 1 of 1 Last

***Effective Date:** 01/01/1900

***Description:** College Algebra

Long Course Title: College Algebra

Long Description: Review of fundamental concepts of algebra. Development of matrices, determinants, Cramer's rule, logarithms, sequences and series, combinatorics, and probability.

***Status:** Active

Course Offering 1 of 1
MATH 101

Course Units/Hours/Count

Minimum Units:	3.00	Last Course of Mult Term Seq:	<input type="checkbox"/>
Maximum Units:	3.00	*Enrollment Unit Load Calc Type:	Actual Units
Academic Progress Units:	3.00	Course Count:	1.00
Financial Aid Progress Units:	3.00	Course Contact Hours:	3.00

Course Grading

***Grading Basis:** Stdnt Opt

***Grade Roster Print:** Component

Graded Component: Lecture

This example illustrates the fields and controls on the Catalog Data page (2 of 2). You can find definitions for the fields and controls later on this page.

Repeat for Credit Rules

Repeat for Credit Total Units Allowed:
 Allow Multiple Enroll in Term Total Completions Allowed:

Additional Course Information

*Instructor Edit:
 *Add Consent: *Drop Consent:
 Requirement Designation:
 Equivalent Course Group:

Course Attributes

Customize | Find | First 1 of 1 Last

*Course Attribute	*Course Attribute Value			
NMAJ	Open to Non-majors Only.	NON-MAJORS	Open to non-majors only.	+ -

Override Topic Link ID

Course Topics

Customize | Find | First 1 of 1 Last

*Course Topic ID	*Description	*Short Description	*Formal Description	Topic Link ID
1	Introduction to College Algebr	Intro Agbr	Introduction to College Algebr	100 + -

The system generates a unique course ID when you add a new course, as long as you do not enter a course ID yourself. You should let the system generate the course ID.

Field or Control	Description
Effective Date	Enter an effective date for this course. The effective date defines when the status you enter is valid. Use a new effective date each time you make a change to a course offering. Insert new rows as needed, and modify the record. Effective dates enable you to track historical course changes.
Status	<p>Enter a status for this course. Enter <i>Active</i> when the course is valid for your institution. You can keep all courses in the database for historical research purposes by inserting a new effective-dated row and setting the status to <i>Inactive</i> for courses that you no longer offer.</p> <hr/> <p>Note: When you schedule a class for a term, the system prompts against the Catalog Data page using the start date of the term as the effective date to find the appropriate row in the catalog. Therefore, you do not need to create a new catalog entry for every term. Instead, insert a new effective-dated row for your revisions.</p>
Short Course Title and Long Course Title	The short title appears on items such as transcripts, advisement reports, study lists, and the schedule of classes. The long course title appears on the Browse Course Catalog page and the course catalog report.

Field or Control	Description
Long Description	The long description can appear in the course catalog report if specified.

Course Units/Hours/Count

You can attach four unit types to a course in the course catalog:

- Minimum units
- Maximum units
- Academic progress units
- Financial aid progress units

These values appear by default on the Schedule of Classes - Class Associations page, where you can override course unit values for a class. When a student enrolls in a class, corresponding fields on the enrollment page populate with the values on the Class Associations page. After a student enrolls, the system uses each unit type to determine the student's academic and financial aid load, academic level, and grade point average. In general, the minimum, maximum, academic progress, and financial aid progress units are always the same. The exception is multi-term courses, remedial courses, and variable unit courses.

Note: For courses that use the same minimum and maximum units, the **Minimum Units** field populates the **Units Taken** field on administrative enrollment pages and the **Units** field on self-service enrollment pages.

Field or Control	Description
Minimum Units and Maximum Units	Enter the minimum units and maximum units that the course is worth. The minimum and maximum units are the same, except for a variable unit class. For a variable unit class, the minimum and maximum units would constitute a range, and the student or administrator would be able to select from within that range how many units the class is worth. For example, the minimum units could be set at 2, and the maximum units could be set at 3. After you schedule the class, you can enroll the student and enter the number of units the student chooses to take for the class in the Units Taken field on the enrollment page.

Field or Control	Description
Academic Progress Units	<p>The system uses academic progress units in conjunction with the billing factor to calculate billing units and, subsequently, per unit fees. The system also uses academic progress units to calculate academic load. Academic progress units are usually equal to the minimum/maximum units, except for a multi-term class. A multi-term class is when all credit for a sequence of classes (HIST 101a + 101b) is granted after a student completes the last course in the sequence.</p> <p>To prevent the student from earning units taken, which are used to calculate GPA, or units earned, which are used by the Academic Advisement application, you could enter 0 in the Minimum Units field and the Maximum Units field. Then, you could enter 3 (or another unit value) in the Academic Progress Units field.</p> <p>The system would calculate the billing units and academic load using 3 (or another unit value) academic progress units, but the student would earn no credit.</p>
Financial Aid Progress Units	<p>Enter the number of units for the course that the system counts towards tracking a student's financial aid load for a term.</p>

Note: When minimum units and maximum units are not equal, the **Academic Progress Units** field and the **Financial Aid Progress Units** field on the Catalog Data page become unavailable, and Progress Units and FA Progress Units on the enrollment page appear by default from the student's **Units Taken** field value.

Field or Control	Description
Last Course of Multi-Term Sequence	<p>Select this check box so that academic progress units can be less than the minimum units for this course. The academic progress units for the last course in a multi-term course is less than the minimum units because the minimum units have been accumulating over the entire sequence, and they are only granted after the student completes the last course. The academic progress units, however, are still granted for each course in the sequence, so they are less than the minimum units at the end of the sequence. See the Multi-Term Course example in the next section.</p>

Field or Control	Description
<p>Enrollment Unit Load Calc Type (enrollment unit load calculation type)</p>	<p>The value you enter determines how the enrollment engine calculates the student's academic load. Values for this field are delivered with your system as translate values. Do not modify these values in any way. Any modifications to these values requires a substantial programming effort. Values are:</p> <p><i>Actual Units:</i> The system populates the Enrollment Unit Load Calc Type field with <i>Actual Units</i> by default. Enter this option for any course that has identical values for the Minimum Units, Maximum Units, and Academic Progress Units fields. The exception to this rule is when you are creating a variable unit course; even though the minimum and maximum units are different, use <i>Actual Units</i>. The enrollment engine calculates the number of units the student can take in the term by looking at the Units Taken field on the Enrollment Request 1 or Student Enrollment 1 page (see the Variable Unit Course example that follows). You can also enter this option for a remedial course, as an example, if you do not want the course to count toward the student's academic load.</p> <p><i>Academic Units:</i> Enter this option for any course that does not have identical minimum units, maximum units, and academic progress units, such as remedial courses and multi-term sequence courses. Entering this option requires the system to look at the academic progress units when it calculates academic load. For example, the minimum units and maximum units might be 0 because you do not want academic level and GPA to be affected by this course. The academic progress units might be 3 so that the course would be used to calculate academic load and billing units (see the Multi-Term Course example that follows). Furthermore, you could use this option for a remedial course, as an example, if you wanted the course to be used in calculating load but not in calculating GPA.</p>
<p>Course Count</p>	<p>If you count courses (in addition to units) toward academic advising requirements or limits, enter a course count value in this field. The system populates this field by default from the course catalog. The course count indicates the worth, or count, of the course towards an advising requirement. Some institutions count courses, as well as units, towards degree requirements.</p>

Field or Control	Description
Course Contact Hours	The system populates this field by default from the Schedule of Classes - Instructor Contact Hours page, where the value is used to calculate total contact hours. Each component of the course can have different contact hours on the Components page.
Grading Basis	Enter a grading basis for the course. Grading basis values are defined on the Grading Scheme Table page. You can override the grading basis for individual class offerings when you create the schedule of classes.
Graded Component	The system displays the graded component based on the Grade Roster Print field value on this page and the Graded Component field value on the Components page.
Grade Roster Print	<p>Enter the type of grade roster that you want to print for this course offering, as processed through the Grade Roster Print page. Values for this field are delivered with your system as translate values. Do not modify these values in any way. Any modifications to these values requires a substantial programming effort. Values are:</p> <p><i>By Student:</i> Enter to print grade rosters for each student. Each student has a distinct grade roster, separated by a page break.</p> <p><i>Component:</i> Enter to print grade rosters for the graded component of the course. The graded component is specified on the Components page.</p> <p><i>Instructor:</i> Enter to print grade rosters for the graded component of the course. The graded component is specified on the Components page. A copy of the grade roster prints for each instructor, primary or otherwise. The number of copies that prints is equal to the number of instructors for the course, primary or otherwise.</p> <p><i>None:</i> Enter to not print a grade roster for the course.</p>
Repeat for Credit	Select this check box to indicate that the class can be repeated for additional credit, as opposed to repeating for grade improvement only. If you do not select the check box, the class is subject to the repeat rules set up in the Repeat Rule Table component.

Field or Control	Description
Allow Multiple Enroll in Term (allow multiple enrollments in term)	Select this check box to permit a student to enroll in this course multiple times within the same term. An example would be an independent study course.
Total Units Allowed	The system populates this field by default with the maximum units for the course (by default, one full course completion is always permissible). However, if you select the Repeat for Credit check box, you may edit and increase this value. This value must be equal to or greater than the maximum units for the course. The system enforces the lower of the two limits, units or completions, that you define.
Total Completions Allowed	The system populates this field with 1 by default (by default, one full course completion is always allowed). However, if you select the Repeat for Credit check box, you may edit and increase this value. This value must be equal to or greater than 1. The system enforces the lower of the two limits, units or completions, that you define.

Field or Control	Description
Instructor Edit	<p>Enter a value to indicate how you want the system to prompt for instructor IDs during class enrollment. This option determines the availability of and the prompt values for the instructor ID field on the Enrollment Request, Quick Enroll, Enrollment, and self-service enrollment pages. The system populates the value for the Instructor Edit field by default to the Class Associations page, where you can override the value. Values for this field are delivered with your system as translate values. Do not modify these values in any way. Any modifications to these values requires a substantial programming effort. Values are:</p> <p><i>No Choice:</i> Enter if you want the system to make the Instructor ID field on the Enrollment Request page unavailable and to automatically assign the instructor who is scheduled to teach the class, as indicated on the Assignment tab of the Schedule of Classes - Meetings page: Thus, the student has <i>no choice</i> of instructor.</p> <p><i>Class Instructor Edit:</i> Enter this option if you want the system to make the Instructor ID field on the Enrollment Request, Quick Enroll, Enrollment, and Self Service Enrollment pages available and to prompt the user with only the Primary Instructors for the class, as defined on the Meetings page. Select this option for independent study courses or the like, for which the student can select one of several <i>Primary</i> instructors.</p> <p><i>Instructor/Advisor Edit:</i> If you enter this option, the Instructor ID field appears on the Enrollment Request, Quick Enroll, Enrollment and Self Service Enrollment pages. The system prompts the user with only the instructors available to teach this course, as defined on the Instructor/Advisor Table page.</p> <p>See Designating Approved Instructors and Advisors.</p>

Field or Control	Description
Add Consent and Drop Consent	<p>The <i>No Consent</i> value appears by default. Values for these fields are delivered with your system as translate values. Do not modify these values in any way. Any modifications to these values requires a substantial programming effort. Values are:</p> <p><i>No Consent</i>: Enter if no special consent is required for a student to add or drop a class.</p> <p><i>Instructor or Department</i>: Enter if consent is required.</p> <p>Consent can be granted by using class permission numbers or student specific permissions. The consent requirement can be overridden in the enrollment process by setting an override permission option.</p>
Requirement Designation	<p>Enter a requirement designation for the course. A requirement designation can be additional work that is needed for a course, such as Design Credit, or a requirement designation can specify a special variety of a course to use in a course list for the Academic Advisement application.</p> <p>Requirement designation values are defined on the Requirement Designation Table page. Example requirement designation values are <i>Design Credit</i>, <i>Thesis Choice</i>, and so on.</p> <p>Requirement designations are provided to the Academic Advisement application.</p>
Equivalent Course Group	<p>You can enter an equivalent course group for the course. Equivalent course groups are defined on the Course Equivalencies page. Here, you are adding the course to a group of equivalent courses for requisite checking and degree progress requirement purposes. If two courses have the same Equivalent Course Group number, then they are equivalent to each other and can fulfill the same requirement.</p>
Course Attribute and Course Attribute Value	<p>Enter the general characteristics that describe the course offering in the Course Attribute and Course Attribute Value fields. Course attributes are defined on the Course Attribute Table page. Course attributes are not provided to the Academic Advisement application. They are primarily used for institutional research purposes, and for printing repetitive text in the catalog and schedule of classes. Example course attribute and course attribute values are <i>Degree Seeking Only - Open to Students in Any Plan</i> and <i>Fall - Offered in Fall Only</i>.</p>

<i>Field or Control</i>	<i>Description</i>
Override Topic Link ID	Select to manually update topic link IDs. When you select this check box, the Topic Link ID field becomes available for edit. Use this functionality to link course topics across effective-dated rows by giving them the same topic link ID.

Description Tab

See the previous exhibit for a view of this tab.

Use the Description tab to define course topics associated with a course. You attach topics to specific classes on the Schedule of Classes - Basic Data page.

<i>Field or Control</i>	<i>Description</i>
Course Topic ID	The system assigns a unique course topic ID number to identify the topic record. Insert rows to add topics.
Course Topic Title, Short Description, and Formal Description	Enter the course topic title, short description, and formal description.
Topic Link ID	The system assigns a unique topic link ID number for each topic. The repeat checking process uses this number when determining if the topic was already taken. If you create a new effective-dated row for this course, the system carries over the topic link ID to the new effective-dated row. If the Override Topic Link ID check box was selected, the Topic Link ID field becomes available for edit. This selection enables you to link course topics within a course across effective-dated rows by giving them the same topic link ID. Because the repeat checking process uses the topic link ID, the process views similar topics that have the same topic link ID as being identical.

Repeat For Credit Tab

Select the Repeat For Credit tab.

<i>Field or Control</i>	<i>Description</i>
Repeat for Credit	Select to allow students to repeat the topic for credit. If you do not select this check box, additional enrollment in the same topic is subject to the repeat rules set up in the Repeat Rule Table component.

Field or Control	Description
Total Units Allowed and Total Completions Allowed	If you select the Repeat for Credit check box, the Total Units Allowed and Total Completions Allowed fields become available for entry. Enter the maximum number of units and course completions allowed for credit within the topic. If you enter a value in both fields, the system enforces the lower of the two limits.

Example of Multi-Term Course

At PSUNV, when a student takes History 101a for the fall term and History 101b for the spring term, the student's credit for both courses is contingent upon the successful completion of the entire course sequence. To define this multi-term course in the course catalog, we purposefully place the minimum units, maximum units, and academic progress units out of synchronization so that the enrollment engine correctly calculates the student's academic load and GPA. The course catalog might look similar to this:

Course	Term of Student Enrollment	Minimum Units	Maximum Units	Academic Progress Units	Last Course of Multi-Term Sequence	Enrollment Unit Load Calculation Type
History 101a	Fall 1999	0	0	3	No	Academic Units
History 101b	Spring 2000	6	6	3	Yes	Academic Units

Because the minimum and maximum units are set to 0, History 101a is not calculated in the student's GPA or Academic Level (that is, if academic level increments by units). But, when the student completes History 101b, he or she will receive credit for both classes because the minimum and maximum units are set to 6. Academic load and billing units are counted for both classes because academic progress units are set to 3, and the Enrollment Unit Load Calculation type is set to *Academic Units*.

Example of Variable Unit Course

At PSUNV, students can select how many units they earn for ENGL 1a. They can select from the range of 2 and 3 units. Because ENGL 1a is an elective course, they can take it for only 2 units, in which case they are not required to complete a final project. Students who complete the project earn 3 units. In this case, the course catalog might look similar to this:

Course	Minimum Units	Maximum Units	Academic Progress Units	Financial Aid Units	Enrollment Unit Load Type
ENGL 1a	2	3	Unavailable	Unavailable	Actual

When students enroll in ENGL 1a, they have to select how many units to take. If they enroll online or through an interactive voice response system, they can select the number of units they want to take

when they add the class. If they enroll in person, the Registrar's Office most likely creates an enrollment request. If the minimum and maximum unit fields on the Course Catalog Data page vary, the **Units Taken** field on the Enrollment Request page becomes available, and the Registrar's Office can enter the number of units the student chooses to take. The possible enrollments would look like this:

<i>Student</i>	<i>Units Taken</i>	<i>Units Earned</i>	<i>Academic Progress Units</i>	<i>Financial Aid Units</i>	<i>Billing Units</i>
Student 1	2	2	2	2	2
Student 2	3	3	3	3	3

As shown, the student chooses the number of units to take and the system determines the units earned, academic progress units, and financial aid units based on the units you enter in the **Units Taken** field when the student enrolls in the class.

Defining Course Offerings

Access the Offerings page (**Curriculum Management > Course Catalog > Course Catalog > Offerings**).

This example illustrates the fields and controls on the Offerings page. You can find definitions for the fields and controls later on this page.

Field or Control	Description
Course Offering Number	The system generates the course offering number and uses it for sequencing. The system also uses the course offering number to distinguish cross-offered courses for which the course ID is the same, as are the requisites, but the course itself is listed in different subject areas, academic groups, and so on.
Catalog Number	Within an academic group, catalog number ranges are linked to academic careers on the Academic Group Table page. If you have already specified an academic group for this course offering, the system automatically displays the appropriate academic career when you enter a catalog number. This field is 10 digits. The system reserves the four left digits exclusively for numeric characters, and the right six digits for both alpha and numeric characters. A field edit enforces this programming.

Field or Control	Description
Course Typically Offered	Values available here are defined in the Course Typically Offered component. See Defining When a Course is Typically Offered .

The system automatically reformats the catalog number you enter to fit the defined system format, as this table illustrates:

Catalog Number	N	N	N	N	A/N	A/N	A/N	A/N	A/N	A/N
12			1	2						
120		1	2	0						
1A				1	A					
12B			1	2	B					
120AB		1	2	0	A	B				
B12					B	1	2			
AB1200					A	B	1	2	0	0
10001A	1	0	0	0	1	A				
1B12				1	B	1	2			

N = numeric character

A/N = alpha or numeric character

Field or Control	Description
Academic Institution	The system displays the academic institution by default. Multiple institutions can offer the same course by way of multiple course offerings.

Field or Control	Description
Academic Group	Enter the academic group to which this course offering belongs. You can define global notes by academic group, which can appear on the Schedule of Classes report. In addition, academic group controls the valid meeting pattern values and their corresponding normal class duration values. Academic group values are defined on the Academic Group Table page.
Subject Area	Enter the subject area of the course offering. Subject area values are defined on the Academic Subject Table page.
Campus	Enter the campus at which your institution offers the course. If the course is offered at one campus, you should place a value in this field. If the course can be offered at multiple campuses, leave this field blank.
Academic Organization	The system populates this field by default from the academic organization linked to the subject on the Academic Subject Table page. You can override the value.
Academic Career	Enter the academic career to which this course offering belongs. The system automatically displays the default values of the Dynamic Class Data Rule, Allow OEE Enrollment , and OEE Dynamic Date Rule fields according to your settings for these fields in the Academic Career Table component. The default values of these fields vary depending on the academic career that you enter and the effective date of the course. Academic career is important because it specifies which students can enroll in the class (in accordance with the Academic Career Pointers page specifications), as well as which grading bases are available.
Tuition Group	The system charges tuition based on the student's enrollment records. If the tuition group that you set on this page matches the student's assigned tuition group, the additional fee defined on the course component is assessed.

Field or Control	Description
Dynamic Class Date Rule	<p>If you have specified a dynamic class data rule for the academic career to which you assign this course offering, the system displays that rule by default in this field. You can override the default value. Select a dynamic class date rule to have the system assign that rule by default to all dynamic class sections of this course offering that you schedule (excluding open entry and open exit sections). Attaching your rule to the course offering rather than to the class section ensures consistency and eases maintenance because you only have to attach the rule to a course one time (to apply to all class sections), rather than having to attach a rule to each course offering that you schedule. The system requires dynamic date calculation for each class section that you schedule for this course offering. After you schedule the class sections, you can run the Dynamic Class Dates process to calculate landmark dates for each class section. The process automatically uses the rule that you specify here for all dynamic date class sections. You can override this default rule on a section-by-section basis through the Dynamic Class Date page. This field prompts you with only the dynamic class data rules that have not been designated for OEE enrollment on the Dynamic Class Dates page. If you leave this field blank and schedule the course within a dynamic date session, you receive a warning message indicating that a rule has not been defined. You need to define a rule on the Dynamic Class Dates page.</p>
Allow OEE Enrollment (allow open entry/exit enrollment)	<p>The system assigns the value of this check box by default based on the Allow OEE Enrollment check box on the Academic Career Table page for the academic career with which you have associated this course offering. You can override this default on an offering-by-offering basis. Select this check box to attach a dynamic date rule to the offering, thus enabling students to enroll in OEE class sections of this course offering. The OEE Dynamic Date Rule field becomes available for edit. If you do not select the check box, you can always define the rule on the Dynamic Class Dates page.</p>

Field or Control	Description
OEE Dynamic Date Rule (open entry/exit dynamic date rule)	<p>The system assigns the value of this field by default based on the OEE Dynamic Date Rule field on the Academic Career Table 2 page for the academic career with which you associate this course offering. An open entry/exit (OEE) dynamic date rule is a dynamic class date rule that has been designated for OEE enrollment. The enrollment engine uses the OEE dynamic date rule to calculate significant class dates for a student whenever a student enrolls in an open entry/exit class. This field is available for edit only if you select the Allow OEE Enrollment check box for this course offering.</p> <p>Select an OEE dynamic date rule to have the system assign that rule by default to all OEE class sections of this course offering that you schedule. Attaching your rule to the course offering rather than the class section ensures consistency and eases maintenance because you only have to attach the rule to a course one time (to apply to all class sections), rather than having to attach a rule to each course offering that you schedule. The system thus automatically requires dynamic date calculation for each OEE class section that you schedule for this course offering. After you schedule the class sections, you can run the Dynamic Class Dates process to calculate landmark dates for each class section. The process automatically uses the rule that you specify here for all OEE class sections. You can override this default rule on a section-by-section basis through the Dynamic Class Data page. The system prompts you with only the dynamic class data rules that have been designated for OEE enrollment on the Dynamic Class Dates page.</p> <p>If this field is blank and you schedule the course within an OEE session, you receive a warning message that indicates a rule has not been defined. You can then save the page and define the rule on the Dynamic Class Dates page.</p>
Course Approved	<p>Enter the course approved status. Values for this field are delivered with your system as translate values. Do not modify these values in any way. Any modifications to these values requires a substantial programming effort. Enter <i>Pending</i> or <i>Denied</i> to prevent anyone from scheduling the class—the system does not list the course in the class scheduling function. Enter <i>Approved</i> and select the Allow Course to be Scheduled check box to enable scheduling of the course offering.</p>
Allow Course to be Scheduled	<p>Select this check box so that the course can be scheduled for a term. A course can only be scheduled for a term if you select this check box and set the Course Approved field to <i>Approved</i>.</p>
Exam Only Course	<p>Select this check box when a course will have no class sections scheduled and the only requirement for the course is that students must complete an examination. When the check box is selected, the Allow Course to be Scheduled field is disabled and the field defaults to the Activity Registry when this course is entered as the Course Control Record.</p>

Note: For courses that are set up solely as transfer articulation courses, set the **Course Approved** field to *Approved* but clear the **Allow Course to be Scheduled** check box. This setting ensures that you never accidentally schedule the course.

Field or Control	Description
Catalog Print	Select to display the course offering in the course catalog report.
Print Instructor in Schedule	Select to display the names of all the assigned instructors in the schedule of classes report.
Schedule Print	Select to display the course offering in the schedule of classes. The system selects this check box by default.
Schedule Term Roll	Select to enable the prior term copy function for this course offering. See Copying Classes from One Term to Another .
Use Blind Grading	Select to enable grade rosters for blind grading. The system populates this field by default from the Academic Subject Table page. When you generate grade rosters for a course that invokes blind grading, instead of student names on the roster, the system generates random numbers. See Printing Grade Rosters See Entering Grades Online
GL Interface Required	Select to include this class in the GL Interface process. If you select this check box, the system requires you to enter the necessary data into the GL Interface page of this component.
Split Ownership	Select if multiple academic organizations own the course. If you select this check box, the Owner group box becomes available for entry.
Course Academic Item	Click to access the Course Academic Item page. See Creating Academic Items for Courses

Enrollment Requirement Group

<i>Field or Control</i>	<i>Description</i>
Requirement Group	<p>Enter the requirement group that links the appropriate requisites to this course.</p> <p>Enrollment requirement group values are defined on the Course Requisite page and can consist of a variety of elements: courses, units, GPA, and so on.</p>
Long Description	<p>The system enters the long description of the enrollment requirement group from the Course Requisites page.</p>

Taxonomy

<i>Field or Control</i>	<i>Description</i>
CIP Code (Classification of Instructional Programs code)	<p>Enter the CIP code for the course. CIP codes provide a taxonomic scheme that support the accurate tracking, assessment, and reporting of fields of study and program completions activity. The system prompts you from the CIP Code Table page.</p>
HEGIS Code (Higher Education General Information Survey code)	<p>Enter the HEGIS code for the course. HEGIS codes provide a taxonomic scheme that support the accurate tracking, assessment, and reporting of fields of study and program completions activity. The system prompts you from the HEGIS Code Table page.</p>
(AUS) Field of Education Code	<p>The system enters the Australia Department of Education, Science and Training (DEST) field of education code that you entered on the Subject Taxonomy page for this course.</p> <hr/> <p>Note: This field is available only when you select the DEST, HECS, Centrelink, TAC check box on the Academic Institution 6 page.</p> <hr/>
(AUS) HECS Band ID (higher education contribution scheme band ID)	<p>The system enters the Australia DEST HECS band ID for the field of education code.</p> <hr/> <p>Note: This field is available only when you select the DEST, HECS, Centrelink, TAC check box on the Academic Institution 6 page.</p> <hr/>

Field or Control	Description
(AUS) Work Experience Indicator	<p>Select the work experience indicator for this course.</p> <p>This value is used to confirm whether the course is considered wholly or partially work experience in industry for Australian DEST reporting purposes.</p> <hr/> <p>Note: This field is available only when you select the DEST, HECS, Centrelink, TAC check box on the Academic Institution 6 page.</p> <hr/>
(AUS) Summer School Full Fee Ind. E551	Select to indicate whether the unit is a full-fee summer or winter school unit of study.
(AUS) Year Long Indicator E622	Select to indicate that the unit of study is a full year unit.
(AUS) Exclude from HEIMS Reporting	Select to indicate you don't want to report this course to HEIMS.
(AUS) Use Discipline Group From Plan	<p>Select to disable the discipline group field. The system uses the discipline group from a student's plan when a student enrolls in this course.</p> <hr/> <p>Note: This field is available only when you select the DEST, HECS, Centrelink, TAC check box on the Academic Institution 6 page.</p> <hr/>
(AUS) Discipline Group Code	<p>The system enters the discipline group from the Subject Taxonomy page.</p> <hr/> <p>Note: This field is available only when you select the DEST, HECS, Centrelink, TAC check box on the Academic Institution 6 page.</p> <hr/>

Ownership

Use this group box to link course offerings to multiple academic organizations.

The system assumes a course offering has a single academic organization owner, unless you indicate split ownership on this page. Course ownership data is tracked for reporting and analysis purposes at the course offering level.

Important! The **Ownership** group box is only available if you select the **Split Ownership** check box.

<i>Field or Control</i>	<i>Description</i>
Academic Organization	Enter the academic organization owners of the course offering. The system prompts you from the Academic Organization Table page.
Percent Owned	Enter the percentage of ownership. The total percentage must equal 100.

Examples of Equivalent and Cross-Offered Courses

Equivalent courses, unlike cross-listed courses, can have different requisites, requirements, and so on. Each equivalent course has a unique course ID number. Use the Course Equivalency component to create Equivalent Course Groups.

Define cross-offered courses on the Course Catalog - Offerings page. Cross-offered courses have the same course ID number; therefore, they possess the same Catalog Data page information. When classes are scheduled, each class is associated with a single offering.

Note: Repeat checking and multiple enrollment rules apply across all offerings of the course because the same course is offered in every case.

The following examples show the defined course ID number 003302, Literature and Philosophy. It is a cross-offered course in both the English and Philosophy departments. In all ways, the two course offerings are exactly the same. They possess the same description, equivalencies, and so on. On the Offerings page, the course offering number distinguishes the two offerings.

In course offering number 1, we indicate that Literature and Philosophy is listed under the English Literature subject area, catalog number 270.

Catalog Data	Offerings	Components	Crse Catalog NZL	Course/Milestone Link	GL Interface
Course ID: 003302					
Find View All First 1 of 1 Last					
Effective Date:	01/01/1900	Status:	Active		
Description:	Lit and Phils				
Course Offering Find View All First 1 of 2 Last					
*Course Offering Nbr:	1	*Catalog Nbr:	270	ENGLLIT	+ -
*Academic Institution:	PSUNV	PeopleSoft University			
*Academic Group:	LBART	College of Liberal Arts			
*Subject Area:	ENGLLIT	English Literature			
Campus:					
*Academic Organization:	ENGLISH	English			
*Academic Career:	UGRD	Undergraduate			
Course Typically Offered	Spring				
Tuition Group:					
Dynamic Class Date Rule:	RULE10	Rule 10 for Dynamic Date Cntl			
	<input checked="" type="checkbox"/>	Allow OEE Enrollment			
OEE Dynamic Date Rule:	OEE15WK-1	OEE 15 Week Schedule			
		Course Academic Item			
Enrollment Requirement Group					
Requirement Group:					
Long Description:					
Taxonomy					
CIP Code:					
HEGIS Code:					

Add another row for course offering number 2. The second offering of Literature and Philosophy is listed under the Philosophy subject area, catalog number 170.

The screenshot displays the Oracle Course Catalog interface. At the top, there are navigation tabs: Catalog Data, Offerings (selected), Components, Crse Catalog NZL, Course/Milestone Link, and GL Interface. Below the tabs, the Course ID is 003302. The main content area is divided into several sections:

- Course Information:** Effective Date: 01/01/1900, Status: Active, Description: Lit and Phils.
- Course Offering:** This section is highlighted. It includes:
 - *Course Offering Nbr: 2
 - *Catalog Nbr: 170 PHILO
 - *Academic Institution: PSUNV (PeopleSoft University)
 - *Academic Group: LBART (College of Liberal Arts)
 - *Subject Area: PHILO (Philosophy)
 - *Academic Organization: PHILOSOPHY (Philosophy)
 - *Academic Career: UGRD (Undergraduate)
 - Dynamic Class Date Rule: RULE10 (Rule 10 for Dynamic Date Cntl)
 - OEE Dynamic Date Rule: OEE15WK-1 (OEE 15 Week Schedule)
- Enrollment Requirement Group:** A section for defining requirements, currently empty.
- Taxonomy:** A section for defining codes, currently empty.
- Options:** A list of checkboxes on the right side:
 - *Course Approved: Pending (dropdown)
 - Allow Course to be Scheduled:
 - Exam Only Course:
 - Catalog Print:
 - Print Instructor in Schedule:
 - Schedule Print:
 - Schedule Term Roll:
 - Use Blind Grading:
 - GL Interface Required:
 - Split Ownership:

Select the **Catalog Print** and **Schedule Print** check boxes to enable printing of both course offerings in the catalog and schedule.

Related Links

“Setting Up Course Fees and Class Fees” (Student Financials)

Defining Course Components

Access the Components page (**Curriculum Management > Course Catalog > Course Catalog > Components**).

This example illustrates the fields and controls on the Course Catalog - Components page (1 of 2). You can find definitions for the fields and controls later on this page.

This example illustrates the fields and controls on the Course Catalog - Components page (2 of 2). You can find definitions for the fields and controls later on this page.

Course Component

<i>Field or Control</i>	<i>Description</i>
Course Component	Enter a course component for the offering. Values for this field are delivered with your system as translate values. You can modify these values. The course component indicates the parts of the course offering, for example, lecture, laboratory, seminar, and so on. One course offering can have multiple components.

Field or Control	Description
Instructor Contact Hours	<p>Enter the contact hours you want to record for the instructors teaching this component of the course. You can also assign specific instructors and corresponding contact hours when scheduling classes on the Schedule of Classes - Meetings page. Use this field only if you want to report contact hours manually.</p> <p>The Instructor Workload feature does <i>not</i> reference this free-form field.</p>
Default Section Size	<p>Enter the default section size. You can override section sizes in the schedule of classes. The system uses the value in this field to populate the Requested Room Capacity field and the Enrollment Capacity field.</p>
Workload Hours	<p>If you want to track instructor workload based on course component workload hours, enter a workload hours value for the course component. The system uses the value that you specify here to populate the same fields on the Class Associations - Class Components page when you schedule a new course. Therefore, if you set the lecture workload hours to 3 on the Course Catalog - Components page, then whenever someone schedules a lecture for this course, the lecture component, 3 workload hours, appears by default on the Class Components page. Similarly, if you set the laboratory component to 1 workload hour on the Components page, then whenever someone schedules a laboratory for this course, the laboratory component, 1 workload hour, appears by default on the Class Components page. The user can modify the component values on the Class Components page if necessary. This field is optional.</p>

Field or Control	Description
OEE Workload Hours (open entry/open exit workload hours)	<p>If you want to track instructor workload based on course component OEE workload hours, enter an OEE workload hours value for the course component. The value you specify here represents the number of workload hours for the entire course, unlike regular workload hours, which represent weekly hours for the course. The system populates the value in this field by default to the same components on the Class Associations - Class Components page when you schedule a new course. In other words, if you set the lecture OEE workload hours to 45 on the Components page, then whenever someone schedules a lecture for this course, the lecture component, 45 OEE workload hours, appears by default on the Class Components page. Similarly, if you set the laboratory component to 15 OEE workload hours on the Components page, then whenever someone schedules a laboratory for this course, the laboratory component, 15 OEE workload hours, appears by default on the Class Components page. You can modify the component values on the Class Components page if necessary. This field is optional.</p>
Final Exam	<p>Enter a value to indicate whether a final exam is given in the course. The value you enter here defaults to the Schedule of Classes. Final exam values are delivered with your system as translate values. Add as many values to the translate table for the final exam as needed. The only value that you must not remove from the translate table is <i>Yes</i>, which has coding attached to it. Values are:</p> <p><i>Yes</i>: The <i>Yes</i> value enables block final exam scheduling. This value cannot be modified without programming effort.</p> <p><i>No</i>: Indicates that this component has no final exam. Entering <i>No</i> eliminates this component from the block exam scheduling process.</p> <p><i>Last Class</i>: Indicates that a final exam is taken in the last regularly scheduled class (as opposed to during final examination week). Entering <i>Last Class</i> eliminates this component from the block exam scheduling process.</p>
Exam Seat Spacing	<p>If you enter <i>Yes</i> in the Final Exam field, the Exam Seat Spacing field becomes available for entry. Enter the number of spaces between student's seats during the exam. For example, enter 2 to have two empty seats between each student taking the exam. This value has no programming tied to it. Use this field for your information or for third-party interface.</p>

Field or Control	Description
Provider for Authentication	<p>If this course is a learning management system (LMS) course requiring self-service user authentication, and the Provider for Authentication is not set on the Academic Institution 3 page, then enter the provider here. The value entered here appears by default on the schedule of classes when you schedule a class, but you can override it. If this field is left blank, any time you schedule a class for this course the system uses the LMS file type from the Academic Institution 3 page.</p>
LMS File Type	<p>If your institution uses the LMS interoperability feature, enter the LMS file type for the interface. The value entered here appears by default in the schedule of classes when you schedule a class, but you can override it. If this field is blank, any time you schedule a class for this course, the LMS file type is provided by default from the setting on the Academic Institution 3 page.</p> <p>Values are <i>XML V1.01</i>, <i>Blackboard CourseInfo 4</i>, and <i>API Input. WebCT Campus Edition</i> and <i>WebCT Vista</i> both support XML V1.1 and user authentication.</p>
Auto Create	<p>Select for each component to have the system automatically create that component of the course in the schedule of classes. This saves you data entry and ensures that the system schedules at least one section for each required component.</p> <p>See Scheduling New Classes.</p>
Graded Component	<p>Select to enable grading of this component. Only one component can have a final grade. The value you select for this course offering appears by default on the (Schedule New Course, Schedule of Classes) Basic Data page when you schedule a class section for this course offering.</p>
Primary Component	<p>Select whether this is the primary component of the course. If you are using the Dynamic Class Dates feature, it is mandatory that you select a primary component for the course, even if you only have one component. The Dynamic Class Dates process always uses the scheduled class section of the primary component to calculate the landmark dates on a dynamic academic calendar. The process uses the primary component value on the Class Associations - Class Components page.</p>
Optional Component	<p>If available for entry, select so that the system does not require that students enroll in this component. If you clear the check box, the system requires students to enroll in the component.</p>

Field or Control	Description
Include in Dynamic Date Calc (include in dynamic date calculation)	<p>Select to include this component of the course offering, in addition to the primary component, in the Dynamic Class Dates process. The system automatically selects and makes unavailable for edit this check box for the primary component of a course because the Dynamic Class Dates process always uses the scheduled class section of the primary component to calculate the landmark dates on a dynamic academic calendar. This check box is optional for other components. The value here appears by default on the corresponding field for all class sections of the component that you schedule on the Basic Data page. For non-primary components, you can override the default value on a section-by-section basis.</p>
Generate Class Mtg Attendance (generate class meeting attendance)	<p>Select to indicate that you want the system to always generate attendance rosters for all classes your institution schedules for this course component. This value defaults to the Schedule of Classes where you can override this setting. Selecting this check box marks the class so that when you generate attendance rosters through the Attendance Roster Generator page you have the option to limit processing to only the classes that have this check box selected and that meet your processing criteria. If you clear this check box on the Attendance Roster Generator page, the generator creates attendance rosters for all classes that meet your processing criteria, regardless of the check box setting. When you generate attendance rosters through the Class Attendance page and this check box is selected for a scheduled class, the setting has no effect on processing.</p>
Add Fee	<p>Click to add an additional fee for the course component and to access the Course Fees Modal page. The additional fee is attached to the course component that you specify.</p> <p>See “Setting Up Course Fees and Class Fees” (Student Financials).</p>

Course Attendance

Field or Control	Description
Instruction Mode	<p>The instruction mode indicates whether the course component is taught <i>In Person</i> or using <i>Interactive TV</i>, <i>World Wide Web</i>, <i>Correspondence</i>, and so on. The instruction mode relates to the attendance type. You can indicate an instruction mode, then select attendance type values for the course component that relate only to this instruction mode. For example, by selecting the <i>In Person</i> instructor mode, you can select an attendance type that applies only to the <i>In Person</i> instruction mode. If you leave the Instruction Mode field blank, the attendance types that you define for the course component applies to all instruction modes. When you create and update attendance rosters, only the attendance type values that relate to the instruction mode for the class are available for you to use. Instruction modes for classes are set on the Schedule of Classes - Basic Data page. Instruction mode values are defined on the Instruction Mode page.</p>

Field or Control	Description
Attendance Type	<p>Select each attendance type that your institution might use for the course component. The attendance type indicates the type of class meeting attendance roster you want to generate, such as <i>Class Meeting</i>, <i>Conference</i>, <i>Field Trip</i>, <i>Instructor Consultation</i>, or <i>Study Group</i>. Add rows for additional attendance types. When you track attendance, the system prompts you only with the attendance type values that your institution defines for the course component. Values for this field are delivered with your system as translate values. You can modify these values.</p> <hr/> <p>Note: At the least, you should specify the attendance type value that your institution has selected on the Academic Institution Table 3 page to use whenever you generate attendance rosters, as well as the fields you want the system to use for this component's attendance type. Although you can generate attendance rosters for a course component without defining attendance type values and their associated fields, the system only creates a default attendance roster that includes the Template Number for the class meeting attendance roster; the Attendance Type and its description; the Attendance Date; and each student's ID, name, and career. You must return to the Components page and define these values for your institution to be able to track student attendance.</p> <hr/> <p>For each attendance type of the course component, select the fields you want the system to use when generating class attendance rosters. You can set up the system to generate attendance rosters with as few or as many fields as you want to appear for each class section. When you generate attendance rosters, the available fields that appear on the attendance rosters for each attendance type depend on the options you select for each attendance type of the course component. Values for any given course component's attendance type are:</p>
Use Present	Select in order for the attendance rosters to have a Present check box on them.
Use Reason	Select in order for the attendance rosters to have a Reason field on them. You can use the reason field to describe a reason for why a student is present, tardy, leaves early, or any other reason your institution wants to track.
Use Tardy	Select in order for the attendance rosters to have a Tardy check box on them.

Field or Control	Description
Use Left Early	Select in order for the Attendance rosters to have a Left Early check box on them.
Use Contact Minutes	Select in order for the attendance rosters to have a Contact Minutes field on them. The system populates the contact minutes time with the total minutes of the class meeting. The system determines this value based on the Class Meeting pattern that your institution has set up for the class in the Schedule of Classes.
Use To and From Time	Select in order for the attendance rosters to have a to and from time field to designate the start and end time of a class meeting. The system determines this value based on the class meeting pattern that your institution has set up for the class in the Schedule of Classes.
Override Template Date/Time	Select for the attendance rosters to have an attendance date field on them. Also, you can override the attendance date, from time, and to time values that appear on the attendance rosters. Otherwise, the corresponding fields that appear on an attendance roster template control the attendance date, from time and to time values that appear for each student on the attendance rosters. A template only identifies an attendance roster as unique.

Room Characteristics Required

Field or Control	Description
Room Characteristic	Enter the room characteristics that you require for the course component. Room characteristic values are defined on the Room Characteristic Table page. Characteristics you enter here default to the schedule of classes. Insert rows to add additional characteristics. This field is used for interfacing to the Universal Algorithm's product, Schedule 25. The maximum number of room characteristics for Schedule 25 is 96. Therefore, be sure you select values between 01 and 96 if you use Schedule 25.
Room Characteristic Quantity	Enter the quantity of each room characteristic that you require.

(NZL) Setting Up Government Reporting Data

Access the Crse Catalog NZL (course catalog New Zealand) page (**Curriculum Management > Course Catalog > Course Catalog > Crs Catalog NZL**).

This example illustrates the fields and controls on the Crse Catalog NZL page. You can find definitions for the fields and controls later on this page.

The screenshot shows the 'Crse Catalog NZL' form for course 000381. The form includes the following fields and controls:

- Course ID:** 000381
- Effective Date:** 01/01/1900
- Status:** Active
- Description:** Intro to Management Accounting
- ACCT:** 101
- Silver Fern University**
- *Main Program:** BCOM (Bachelor of Commerce)
- *NZSCED Detail Code:** 080101 (Accounting)
- *Course Type:** Type A - Program EFTS
- EFTS Factor:** 0.0000
- NQF Level:** Level 1
- NQF Credit:** 5
- *Course Classification:** 03 (Arts; Humanities; Social Sciences)
- *Funding Category:** A2 (Arts & Soc Sci - Degree)
- Pre-Service Stage:** First stage of programme
- eLearn Status:** (empty)
- Average Course Fee:** (empty)
- Foreign Fee:** (empty)
- *Eligible for PBRF:** Not PBRF Eligible
- Compulsory Course Costs:** (empty)
- *Exempt Indicator:** Not Exempt
- VRF:** (empty)

Field or Control	Description
Main Program	Enter the main program for this course. When you generate the SDR course register file, the prospectus code from the program you select here is reported as a qualification code.
NZSCED Detail Code	Enter the NZSCED field of study code for this course. Set up NZSCED field of study codes on the NZSCED Field of Study NZL page.

Field or Control	Description
Course Type	<p>Enter the course type for this course.</p> <p>Values are:</p> <ul style="list-style-type: none"> • Type A - Program EFTS • Type B - Hourly EFTS <p>If you enter Type B, the system displays the Hours field, in which you can enter the total hours for the course. The system calculates the EFTS factor based on the new value.</p> <p>If you enter Type A, the system recalculates the EFTS factor whenever the values change for the UNITS_ACAD_PROG, UNITS_MINIMUM, and UNIT_MAXIMUM fields in the CRSE_CATALOG record. The system calculates the EFTS factor for type A courses by multiplying the academic progress units for the course by the EFTS Translation A value defined for the institution.</p>
EFTS Factor	<p>The system automatically calculates the EFTS factor for the course whenever you add a new course or whenever you change the course type or hours for the course. The system calculates the EFTS factor by multiplying the course hours by the EFTS Transaction B value defined for the institution.</p>
NQF Level	<p>Enter the New Zealand Register of Quality Assured Qualifications level for the credits in this course.</p>
NQF Credit	<p>Specify the number of New Zealand Register of Quality Assured Qualifications credits contained in this course.</p>
Course Classification	<p>Enter the course classification code for this course.</p> <p>Define course classifications on the Course Classification NZL (SSR_CRS_CLSF_FNDC) page.</p> <p>Only Course Classifications that have an effective date less than or equal to the current date and a status of <i>Active</i> are available for selection in the Course Classification field.</p>
Funding Category	<p>Enter the funding category for this course.</p> <p>Define funding categories on the Funding Category NZL (SSR_FUND_CAT_NZL) page.</p>
Pre-Service Stage	<p>For courses that are part of a teacher training program, enter the pre-service stage code for the course.</p>
eLearn Status	<p>Enter the eLearn status to indicate whether or not this course is offered through the internet.</p>

Field or Control	Description
Average Course Fee	Enter the average fee for the students enrolled in this course for the reporting period.
Foreign Fee	Enter the tuition fee paid by foreign, fee paying students.
Eligible for PBRF (eligible for Performance Based Research Fund)	Use this field to indicate if a course is eligible for the Performance Based Research Fund.
Compulsory Course Costs	Enter a dollar amount for the total compulsory fees for this course.
Exempt Indicator	Indicate if a course was granted an exemption from FCCM (Fees/Course Costs Maxima).
VRF (Volume of Research Factor)	Use this field to capture Volume of Research Factor data. This field is for informational purposes only.
Embedded Literacy/Numeracy	Select this check box to indicate that the course has an embedded literacy or numeracy component. The check box is cleared by default.

Related Links

[Understanding New Zealand Government Reporting](#)

Linking Milestones to Course Data

Access the Course/Milestone Link page (**Curriculum Management > Course Catalog > Course Catalog > Course/Milestone Link**).

Field or Control	Description
Milestone	<p>Link a milestone to a course. If the Writing milestone for example is selected for a course, when a student enrolls in a section of that course, the Writing milestone is assigned to the student. A row is inserted in the Student Milestones page.</p> <p>The Enroll into Course Milestones check box must be selected on the Academic Institution 2 page and the Academic Career Table 2 page.</p> <p>(NZL) Enter the unit standards to link to this course. Link unit standards to milestones in the NQF Detail group box on the Milestone Table page.</p>

Related Links

“Defining Academic Institutions” (Campus Solutions Application Fundamentals)

“Defining Academic Careers” (Campus Solutions Application Fundamentals)

[Setting Up Milestones](#)

[Tracking Milestones](#)

[Preparing for NZQA Reporting](#)

Interfacing Course Offerings with the General Ledger

Access the GL Interface page ([Curriculum Management](#) > [Course Catalog](#) > [Course Catalog](#) > [GL Interface](#)).

Copy and paste icons appear on this page, next to the **Jrnl Set** field. Use the copy icon to copy the setup for the row, which can then be pasted to the new, or any proceeding, row.

<i>Field or Control</i>	<i>Description</i>
Receivables From Item Type	<p>Select if you do not want to track revenue by course. The system allocates revenue based on the credit entry defined for the tuition item type. In this case, do not enter ChartField information.</p> <p>The system automatically tracks receivables for a course based on the debit entry defined for the tuition item type (on the Item Types - GL Interface page). If you want to track revenue by course, you must select the GL Interface Required check box on the Catalog Data page and then enter a credit entry for the class by completing the ChartFields on this page.</p>

Related Links

“Mapping Item Types to General Ledger Accounts” (Student Financials)

Creating Course Equivalency Groups

Course equivalency groups link different course ID numbers as equivalent for requisite checking purposes. The courses themselves can possess different components, requisites, topics, and so on. Equivalent course groups are for different course IDs and are, therefore, different from multiple-offering courses.

Complete these steps to create a course equivalency group:

1. Define an equivalent course group on the Course Equivalencies page.
2. Add courses to the equivalency group on the Catalog Data page.
3. Return to the Course Equivalencies page and click the **Fetch Equivalencies** button to review the group of equivalent courses.

Related Links

[Defining Course Catalog Data](#)

Page Used to Create Course Equivalency Groups

<i>Page Name</i>	<i>Definition Name</i>	<i>Navigation</i>	<i>Usage</i>
Course Equivalencies	CRSE_EQUIV	Curriculum Management > Course Catalog > Course Equivalencies > Course Equivalencies	Define the course equivalency group.

Creating a Course Equivalency

Access the Course Equivalencies page (**Curriculum Management > Course Catalog > Course Equivalencies > Course Equivalencies**).

This example illustrates the fields and controls on the Course Equivalencies page. You can find definitions for the fields and controls later on this page.

Course Equivalencies

Find | View All First ◀ 1 of 1 ▶ Last

Equivalent Course Group: 05001 + -

***Effective Date:** 01/01/1980 BT ***Status:** Active ▼

***Description:** Elementary Statistics Fetch Course Equivalencies

Short Description: Statistics

Find First ◀ 1-2 of 2 ▶ Last

Course ID:	Applied Statistics	Course Offering
Effective Date:	01/07/1980 Status: Active	Find ◀ 1 of 1 ▶
Equivalent Course Group:	05001 Elementary Statistics	STATS 115

Course ID:	Economic Statistics	Course Offering
Effective Date:	01/07/1980 Status: Active	Find ◀ 1 of 1 ▶
Equivalent Course Group:	05001 Elementary Statistics	ECON 115

<i>Field or Control</i>	<i>Description</i>
Effective Date	Enter an effective date for this equivalent course group. The effective date defines when the status you select is valid. Use a new effective date each time you make a change to an equivalent course group. Insert new rows as needed, and modify the record to track historical equivalent course changes.
Status	Enter a status for this equivalent course group. Select <i>Active</i> when adding a new equivalent course group. The <i>Inactive</i> option should only be used if your institution no longer wants to use this equivalent course group.

Note: If you want to inactivate an equivalent course group, you need to delete that equivalent course group number from each course to which it is attached on the Catalog Data page, and change the status to *Inactive* on the Course Equivalencies page.

Field or Control	Description
Description and Short Description	Enter the descriptions of the equivalent course group.
Fetch Course Equivalencies	After you attach courses to this equivalent course group on the Catalog Data page, click this button to view all courses linked to the equivalent course group.

This example illustrates how to assign courses to a new equivalent course group.

Course Equivalencies

Find | View All First 1 of 1 Last

Equivalent Course Group: 05001 + -

***Effective Date:** 01/01/1980 BY ***Status:** Active ▼

***Description:** Elementary Statistics Fetch Course Equivalencies

Short Description: Statistics

Find First 1-3 of 3 Last

Course ID	Course	Course Offering
001011	Applied Statistics	1 of 1
Effective Date: 09/16/2004	Status: Active	1
Equivalent Course Group: 05002	Calculus 1	STATS 115
Equivalent Course Group		
001011	Applied Statistics	1 of 1
Effective Date: 01/07/1980	Status: Active	1
Equivalent Course Group: 05001	Elementary Statistics	STATS 115
001012	Economic Statistics	1 of 1
Effective Date: 01/07/1980	Status: Active	1
Equivalent Course Group: 05001	Elementary Statistics	ECON 115

The system displays an effective date and equivalent course group for every course. To determine when data for an effective-dated row is superseded, look at the next row. In the example, the system shows that course ID *001011* was part of Equivalent Course Group *05001* until *09/16/2004*. As of *09/16/2004*, course ID *001011* became associated with Equivalent Course Group *05102*.

Click the **Equivalent Course Group** link to view other equivalent course groups for a specific course.

Viewing Course Catalog Summary Information



This section discusses how to review course catalog summaries.

Page Used to View Course Catalog Summary Information

<i>Page Name</i>	<i>Definition Name</i>	<i>Navigation</i>	<i>Usage</i>
Course Catalog Summary	CRSE_CATALOG_SUM	Curriculum Management > Course Catalog > Catalog Summary > Course Catalog Summary	View a summary of course offerings.

Reviewing Course Catalog Summaries

Access the Course Catalog Summary page (**Curriculum Management > Course Catalog > Catalog Summary > Course Catalog Summary**).

<i>Field or Control</i>	<i>Description</i>
	If the course is a part of an equivalent course group, the equivalent course group appears. Click the Open button to toggle between the equivalent courses.
	Click the Detail button to go the Course Catalog - Catalog Data page for the course. You can use this button to view further details or to modify data for the course.

Related Links

[Creating Course Equivalency Groups](#)

[Creating Course Offerings](#)

Printing the Course Catalog

This section discusses how to enter course catalog report parameters.

Page Used to Print the Course Catalog Report

<i>Page Name</i>	<i>Definition Name</i>	<i>Navigation</i>	<i>Usage</i>
Print Course Catalog	RUNCTL_SRYCATLG	Curriculum Management > Course Catalog > Print Course Catalog > Print Course Catalog	Use the Print Course Catalog page to print the course catalog (SR301 Report).

Entering Course Catalog Report Parameters

Access the Print Course Catalog page (**Curriculum Management > Course Catalog > Print Course Catalog > Print Course Catalog**).

<i>Field or Control</i>	<i>Description</i>
From Date and End Date	Enter a from date and an end date. These dates are the effective dates of the course offerings. They are required fields. The system prints all active courses that are greater than or equal to the from date, and less than or equal to the end date.
Academic Institution	The system populates this field with the value on the User Defaults 1 page.
Academic Organization	Enter the academic organization. You are prompted by the Academic Organization Table page.
Academic Group and Academic Career	Enter the academic group and academic career if you want to limit the scope of the report. Academic group values are defined on the Academic Group Table page. Academic Career values are defined on the Academic Career Table page.
Course Approved	Select whether you want to display <i>Approved</i> , <i>Denied</i> , or <i>Pending</i> courses. To report courses of all three types, run three reports, each with a different Course Approved field value.
Catalog Print	Select whether you want to view text designated as catalog print text. If you select <i>Yes</i> , all courses with the Catalog Print check box selected on the Course Catalog Offerings page appear in the report. If you select <i>No</i> , the courses that do not have the Catalog Print check box selected appear in the report. If you select <i>All</i> , all courses appear, regardless of the setting of the check box.
Report Only	Clear this check box to specify that you want to create a Course Catalog report and send the Course Catalog report to your file path location in .csv format. Select this check box to create a Course Catalog report without creating a .csv file. If you select this check box, the File Path field becomes unavailable.

Field or Control	Description
File Path	<p>If you clear the Report Only check box, this field is available. In addition to sending report output for this process to a file (through setting preferences in the PeopleSoft Process Monitor), you can also send any additional output files created by this process to a file directory. To send the extract output to a file directory, enter a valid directory path that maps to a folder with appropriate read/write permission. If you cannot locate such a folder, consult your system administrator.</p> <p>Select the print options to display the described detail on the report. If you clear them, the detail does not appear on the report.</p>
Run	Click to run the report using PeopleSoft Process Scheduler. You should set the type to <i>Web</i> and the format to <i>PDF</i> .

Searching for Courses

This section discusses how to:

- Browse the course catalog.
- Select a course offering.
- View course catalog details.

Pages Used to Search for Courses

Page Name	Definition Name	Navigation	Usage
Browse Course Catalog	SSS_BROWSE_CATLG	Curriculum Management > Course Catalog > Browse Catalog > Browse Course Catalog	Browse the course catalog to see a list of courses offered at the institution.
Browse Course Catalog - Select Course Offering	SSS_BCC_SEL_CRSE	On the Browse Course Catalog page, click a course title that includes this message: *** view multiple offerings.	Select the appropriate offering when a course ID has multiple offerings with the same subject, course number, and title, or when multiple course IDs have the same subject, course number, and title.
Browse Course Catalog - Course Detail	SSS_CRSE_OFFER_DTL	Click a course number or course title on the Browse Course Catalog page.	View course details and access class sections.

Browsing the Course Catalog

Access the Browse Course Catalog page ((Curriculum Management > Course Catalog > Browse Catalog > Browse Course Catalog).

This example illustrates the fields and controls on the Browse Course Catalog page. You can find definitions for the fields and controls later on this page.

Browse Course Catalog

Select Institution PeopleSoft University ▼ change

A B C D E F G H I J K L M N O P Q R S T U V W X Y Z
 0 1 2 3 4 5 6 7 8 9

COLLAPSE ALL
EXPAND ALL

Select subject code to display or hide course information.

- ▶ **ACCT - Accounting**
- ▶ **ANATOMY - Anatomy**
- ▶ **ANTHRO - Anthropology**
- ▼ **ART - Art**

Course Nbr	Course Title	Typically Offered
100	Basic Studio in Art	Fall, Spring
101	Art Survey	Fall
111	Introductory Art Seminar	Fall, Spring
112	History of World Art	Spring
113	History of World Art	Fall
121	Introductory Painting	Fall, Spring, Summer
130	Survey of Printmaking *** view multiple offerings	Winter

<i>Field or Control</i>	<i>Description</i>
Select Institution	Enter the institution for which you want to search for courses.

Field or Control	Description
Course Nbr (course number) and Course Title	<p>Click a course number or a course title to view course details and section information.</p> <p>You are taken to the Select Course Offering page when a course ID has multiple offerings with the same subject, course number, and title, or when multiple course IDs have the same subject, course number, and title—see ART 130 in the previous example page. Notice that the course title includes this message: *** view multiple offerings.</p>
Typically Offered	The terms in which a course is typically offered, as defined on the Offerings page.

Selecting a Course Offering

Access the Browse Course Catalog - Select Course Offering page (on the Browse Course Catalog page, click a course title that includes this message: ***** view multiple offerings.**)

This example illustrates the fields and controls on the Browse Course Catalog - Select Course Offering page. You can find definitions for the fields and controls later on this page.

Browse Course Catalog

Select Course Offering

[Return to Browse Course Catalog](#)

ART 130 - Survey of Printmaking

Career	Campus	Typically Offered	Academic Group	Academic Organization
Undergraduate	Main Hacienda Campus	Winter	College of Fine Arts	Art
Undergraduate	Main Hacienda Campus	Winter	College of Fine Arts	College of Fine Arts

[Return to Browse Course Catalog](#)

Use this page to select the appropriate offering when a course ID has multiple offerings with the same subject, course number, and title, or when multiple course IDs have the same subject, course number, and title.

Viewing Course Catalog Details

Access the Browse Course Catalog - Course Detail page (click a course number or course title on the Browse Course Catalog page or a course offering link on the Browse Course Catalog - Select Course Offering page).

This example illustrates the fields and controls on the Browse Course Catalog - Course Detail page. You can find definitions for the fields and controls later on this page.

Browse Course Catalog

Course Detail

[Return to Browse Course Catalog](#)

PSYCH 495 - Psychology Special Topics

Course Detail

Career	Undergraduate	view class sections	
Units	2.00 - 3.00		
Grading Basis	Graded		
Course Components	Lecture		Required
	Laboratory		Required

Enrollment Information

Typically Offered	Fall
Add Consent	Instructor Consent Required
Drop Consent	Department Consent Required
Enrollment Requirement	Must be an Honors student
Requirement Designation	Honors Option
Course Attribute	Open to seniors only. Open to majors only.

Description

An intensive study of a psychological topic which commands the current focus of interest of both the faculty member and the students.

Course Schedule

Click the **view class sections** button to view the course schedule details.

This example illustrates the fields and controls on the Course Schedule page. You can find definitions for the fields and controls later on this page.

Course Schedule

Terms Offered 2006 Fall show sections

● Open
 ■ Closed
 ▲ Wait List

PSYCH 495 sections for 2006 Fall

Section			Session	Topic	Status
01-LEC (1539)	Combined		1	Research Methods in Psych	●
Days	Start	End	Room	Instructor	Dates
MWF	1:00PM	1:50PM	Bush 1100	Aurelia Edmundson, Edward Litman	08/30/2006 - 12/12/2006
F	2:00PM	4:30PM	King 100	Mara Baylor	08/30/2006 - 12/12/2006

Section	Session	Topic	Status		
01A-LAB (1540)	1	Research Methods in Psych	●		
Days	Start	End	Room	Instructor	Dates
F	8:00AM	10:30AM	Angel 102	Aurelia Edmundson	08/30/2006 - 12/12/2006

Section	Session	Topic	Status		
02-LEC (1541)	1	Historical Perspective of Psy	●		
Days	Start	End	Room	Instructor	Dates
M	9:00AM	11:30AM	TBA	Staff	08/30/2006 - 12/12/2006

Enter a term and click the **show sections** button to view class sections for the course.

Chapter 6

Setting Up Enrollment Requisites

Understanding Enrollment Requisite Setup and Maintenance

In Student Records, two levels are available at which you can create enrollment requisites and requirements:

1. Enrollment Requirement Groups, which handle requirements for specific courses or class reserve capacities.
2. (Optional) Enrollment Requirements (with or without course lists), which handle complicated requisite rules.

Most likely, you can meet 90 percent of your requisite needs with the Enrollment Requirement Group component alone.

Related Links

[“Understanding Academic Requirement Groups” \(Academic Advisement\)](#)

[“Setting Up Academic Course Lists” \(Academic Advisement\)](#)

Prerequisites

Depending on the structure and complexity of your enrollment requirement groups, you must first define the following data:

- Academic institutions.
- Requisite program statuses.
- (Optional) Tests for requisites.
- Student Groups for requisites.
- (Optional) Requisite conditions.
- (Optional) Enrollment requirements.
- (Optional) Enrollment course lists.
- (Optional) Entity groups.
- (Optional) Requirement designations.
- (Optional) Courses.

Defining Requisite Program Statuses

This section discusses how to define valid academic program statuses for use in requisite checking.

Page Used to Define Requisite Program Statuses

<i>Page Name</i>	<i>Definition Name</i>	<i>Navigation</i>	<i>Usage</i>
Define Requisite Prog Status	SSR_ENR_RPT_TYPE	Curriculum Management > Enrollment Requirements > Define Requisite Prog Status > Define Requisite Prog Status	Enter valid academic program statuses for use in Enrollment Requisites conditions.

Defining Requisite Program Statuses

Access the Define Requisite Prog Status page (**Curriculum Management** > **Enrollment Requirements** > **Define Requisite Prog Status** > **Define Requisite Prog Status**).

Use this page to identify valid program statuses for an institution. The statuses that are defined on this component are considered valid for enrollment requisites using conditions that specify academic programs, plans, or sub-plans. The requisite checking process evaluates only programs, plans, or subplans for which the student's current (for the enrollment term) academic program status matches one of the statuses defined here.

<i>Field or Control</i>	<i>Description</i>
Effective Date	Enter the date for which the program status is effective for requisites.
Program Status	Enter the valid program statuses for the assigned effective date.

Note: In most cases, you need to define only one status here (ACTV). Adding any other non-active program statuses allows requisite conditions based on academic program, plan and sub plans to be satisfied by non-active students.

Defining Tests for Use in Requisites

This section discusses how to define tests for use in enrollment requisites.

Page Used to Define Tests for Use in Requisites

Page Name	Definition Name	Navigation	Usage
Define Tests for Requisites	SSR_REQ_COND_TEST	Curriculum Management > Enrollment Requirements > Define Tests for Requisites > Define Tests for Requisites	Set up test information for use in conditions in enrollment requirement groups and requirements.

Defining Tests for Requisites

Access the Define Tests for Requisites page (**Curriculum Management > Enrollment Requirements > Define Tests for Requisites > Define Tests for Requisites**).

This example illustrates the fields and controls on the Define Tests for Requisites page. You can find definitions for the fields and controls later on this page.

The screenshot shows the 'Define Tests for Requisites' page with the following details:

- Academic Institution:** PSUNV (PeopleSoft University)
- Test ID:** ACT (ACT Assessment)
- Effective Date:** 01/01/1900
- Status:** Active
- Processing Controls:**
 - Months Valid:** 30
 - Test Score Method:** Highest Score
 - Enable User to Override Months (checked)
 - Enable User to Override Method (checked)
- Valid Data Sources:**
 - 'Data Source': American College Testing
 - 'Data Source': School

Use this page to identify the tests and related data that you want to use in conditions in enrollment requirement groups and requirements. The Test IDs are already defined in the Test Tables component. Here, you are identifying which Test IDs and related data that you want to use in enrollment requisites.

Important! If you want to use test scores in academic requirements, you must define your Test IDs and related data in the Define Tests for Advisement component.

See “Setting Up Tests for Use in Academic Advisement” (Academic Advisement)

Note: Tests defined in this component are saved with a requirement usage code of *ENR*. Users can retrieve such rows using this component only.

Field or Control	Description
Test ID	<p>Select the Test ID (such as ACT, GMAT, or GRE) that you want to use in enrollment requirement groups or enrollment requirements. The system displays values defined on the Test Tables page. This field is unavailable for entry unless you are in Add mode.</p>
Status	<p>Select the status of the report identifier. Values are:</p> <p><i>Active:</i> Select when adding a new report identifier.</p> <p><i>Inactive:</i> Select only if your institution no longer uses this report identifier.</p> <p>Values for this field are delivered with your system as translate values. Do not modify these values in any way. Any modification to these values will require a substantial programming effort.</p>
Months Valid	<p>Enter the number of months for which a test score can be considered valid. An empty (blank) field is interpreted to mean that the test is always valid.</p>
Test Score Method	<p>Select the test score method. Values are:</p> <p><i>Average of All Scores Taken:</i> Select to have the enrollment engine average scores for a given test when it processes the test for a condition in an enrollment requirement or requirement group.</p> <p><i>First Test Taken:</i> Select to have the enrollment engine use the test score with the earliest date when it processes the test for a condition in an enrollment requirement or requirement group.</p> <p><i>Highest Score:</i> Select to have the enrollment engine use the highest score for a given test when it processes the test for a condition in an enrollment requirement or requirement group.</p> <p><i>Last Test Taken:</i> Select to have the enrollment engine use the score from the last test date taken when it processes the test for a condition in an enrollment requirement or requirement group.</p> <p><i>Lowest Score:</i> Select to have the enrollment engine use the lowest score for a given test when it processes the test for a condition in an enrollment requirement or requirement group.</p>

Field or Control	Description
Enable User to Override Method	<p>By default, this check box is cleared, which means that the user is unable to change this value for this test ID in the Enrollment Requirement, Enrolment Requirement Group, or Define Requisite Conditions component pages.</p> <p>Select this check box if you want to enable a user to change the Test Score Method field value on the enrollment requirement or enrollment requirement group components. This check box label is defined in the Message Catalog. You can change this label as needed.</p>
Enable User to Override Months	<p>By default, this check box is cleared, which means that the user is unable to change the Months Valid field value in the academic requirement or academic requirement group component pages. Select this check box if you want to enable a user to change the Test Score Method field value on the Enrollment Requirement, Enrolment Requirement Group, or Define Requisite Conditions components. This check box label is defined in the Message Catalog. You can change this label as needed.</p>
Data Source	<p>Select one or more valid data sources (American College Testing, for example) for the test ID you are defining. Values for this field are delivered with your system as translate values. You can modify these translate values. The delivered testing agency values that appear here are <i>American College Testing</i>, <i>College Board</i>, <i>Educational Testing Services</i>, and <i>Law School Admission Services</i>. These are the data sources that are considered valid when processing a test score in an enrollment requirement or requirement group.</p>

Related Links

“Defining External Tests” (Recruiting and Admissions)

“Setting Up Academic Requirements” (Academic Advisement)

Defining Student Groups for Use in Requisites

This section discusses how to define student groups for use in enrollment requisites.

Page Used to Define Requisite Student Groups

<i>Page Name</i>	<i>Definition Name</i>	<i>Navigation</i>	<i>Usage</i>
Define Requisite Student Group	SSR_VALID_STDNT_GR	Curriculum Management > Enrollment Requirements > Define Requisite Student Group > Define Requisite Student Group	Enter student groups for use in enrollment requisites.

Defining Requisite Student Groups

Access the Define Requisite Student Group page (**Curriculum Management** > **Enrollment Requirements** > **Define Requisite Student Group** > **Define Requisite Student Group**).

This example illustrates the fields and controls on the Define Requisite Student Group page. You can find definitions for the fields and controls later on this page.

Define Requisite Student Group

Find | View All
First 1 of 1 Last

Academic Institution: PSUNV PeopleSoft University + -

Effective Date: 01/01/2004 + -

Find
First 1-7 of 7 Last

*Student Group:	ATHL <input type="text" value="ATHL"/>	Athlete	+ -
*Student Group:	CSU <input type="text" value="CSU"/>	CSU Breadth	+ -
*Student Group:	ESL <input type="text" value="ESL"/>	English as a Second Language	+ -
*Student Group:	HONR <input type="text" value="HONR"/>	Honors Society	+ -
*Student Group:	IGTC <input type="text" value="IGTC"/>	IGETC	+ -
*Student Group:	ITNL <input type="text" value="ITNL"/>	International Student	+ -

Use this page to identify the student group codes that you want to use in conditions in enrollment requirement groups and requirements.

Note: Student groups that are defined in this component are saved with a requirement usage code of ENR.

<i>Field or Control</i>	<i>Description</i>
Effective Date	Enter the date for which the student group is effective.
Student Group	Enter the valid student group or groups for the assigned effective date.

Defining Requisite Conditions (Optional)

This section provides an overview of conditions for use in enrollment requisites and discusses how to define them.

Understanding Requisite Conditions

When you want to create an enrollment requisite that contains a condition, you select a value from the list of delivered "standard" condition codes (Cumulative Grade Point Average, for example). For example, you might set up a course prerequisite whose condition is that the student's cumulative GPA is greater than 3.0.

Requisite conditions enable you to create conditions that are more complex and then use those as conditions in an enrollment requirement or requirement group. They enable you to use multiple standard conditions (student group equals athlete and academic standing is good, for example), user programmable conditions (a milestone, for example), or a combination thereof. For example, you might set up a requisite condition whereby academic level must be less than sophomore and that the SAT math score must be greater than or equal to 650.

A condition specification (requisite condition) is a condition that includes connector types, lines, process types, parameters, and controls. It can also be referenced by another requisite condition. Using Boolean logic, requisite conditions can be combined within a condition specification to create more complex requisite conditions. For example, you could create two requisite conditions, and then point to these from a third requisite condition. Requisite condition #1 equals academic level = freshman and cum GPA >= 2.0. Requisite condition #2 equals sophomore and cum GPA >= 2.5. Requisite condition #3 equals requisite condition #1 OR requisite condition #2.

Page Used to Define Requisite Conditions

<i>Page Name</i>	<i>Definition Name</i>	<i>Navigation</i>	<i>Usage</i>
Define Requisite Conditions	RQ_CONDITION	Curriculum Management > Enrollment Requirements > Define Requisite Conditions > Define Requisite Conditions	Define the conditions for use in enrollment requirements or enrollment requirement groups.

Defining Requisite Conditions

Access the Define Requisite Conditions page (**Curriculum Management > Enrollment Requirements > Define Requisite Conditions > Define Requisite Conditions**).

This example illustrates the fields and controls on the Define Requisite Conditions page (in Add mode). You can find definitions for the fields and controls later on this page.

Field or Control	Description
Condition Specification	This is an arbitrary number that is unique for each condition specification. You can use this condition specification as a condition in an enrollment requirement or enrollment requirement group.
Description	Enter a description for the condition specification that you want to establish. The description appears on the enrollment requisite (requirement group) summary, enrollment requirement summary, the enrollment advisement report, the requisite requirement report, and the reverse engineering report.

Field or Control	Description
Short Description and Long Description	Enter descriptions for the condition specification that you want to establish. These descriptions are used for documentation purposes only.
Academic Institution	Select the academic institution. Each condition specification is associated with only one academic institution.
Connector Type	Select the main connector type for this condition specification. Values are: <i>None</i> , <i>AND</i> , and <i>OR</i> . (<i>None</i> converts to <i>AND</i> .) The connector type indicates the Boolean operator to be used in the equation that contains the condition lines.
Condition Line Sequence	This number indicates the order in which the condition lines are evaluated. The condition line sequence number is automatically assigned, but can be overridden by the user.
Condition Process Type	<p>Select a condition process type. Values are:</p> <p><i>Standard Condition</i>: Indicates that the condition is one of the delivered, standard conditions. This is the default field value. If you use this type, then the condition code field is available.</p> <p><i>User Programmable Condition</i>: Indicates that the condition is a user programmable condition. If you select <i>User Programmable Condition</i>, the Condition Process Identifier field becomes available.</p> <p>If you select the condition process type <i>User Programmable Condition</i>, and the condition process identifier of Milestone Check, then you are presented with additional fields. Use these to specify the details about the milestone for use in this dynamic condition.</p>

Field or Control	Description
Condition Code	<p>If you select the Condition Process Type field value of <i>Standard Condition</i>, then select one of the following delivered translate values:</p> <p><i>None</i>: Indicates no field value.</p> <p><i>Academic Level</i>: Indicates the year of study. For example, valid values include freshman and sophomore. This value is evaluated against the student based on whatever As of Date field value is specified at run time.</p> <p><i>Academic Plan</i>: Indicates the area of study, for example, a major or minor within the academic program. Some plans are subdivided into sub-plans. Academic Plan and Primary Academic Plan reference the exact same plan when the student has one plan only.</p> <p><i>Academic Plans</i>: Indicates that all of a student's plans are part of the equation.</p> <p><i>Academic Program</i>: Indicates the program of study to which a student applies and is admitted. <i>Academic Program</i> and <i>Primary Academic Program</i> reference the exact same program when the student has one program only.</p> <p><i>Academic Programs</i>: Indicates that all of a student's academic programs are part of the equation.</p> <p><i>Academic Standing</i>: Indicates a student's standing at the institution. For example, values might include good standing, probation, and dismissal. You define values in the Academic Standing table. This value is evaluated against the student based on the as of date that you specify at run time.</p> <p><i>Academic Sub-Plan</i>: Indicates a further specialization within the academic plan.</p> <p><i>Academic Sub-Plans</i>: Indicates that all of a student's sub-plans are part of the equation.</p> <p><i>Cumulative Grade Point Average</i>: A student's cumulative grade point average (derived from the students term history cumulative statistics, in conjunction with the processing as of date).</p> <p><i>Dynamic Condition</i>: Indicates a dynamic condition that has been previously created in the Define Dynamic Condition component.</p> <p><i>Primary Academic Plan</i>: Indicates a student's primary academic plan. The primary academic plan is designated by the lowest plan sequence number on the Student Plan page. For example, under a program of LAU, a student might have two plans, Psychology and Classics Minor. If Psychology has a plan sequence number of 10 and Classics Minor has a plan sequence number of 20, then Psychology is the primary academic plan. On the Student Plan page, student career number 0 is the primary career.</p>

Field or Control	Description
	<p>Important! The primary academic plan is designated by the lowest plan sequence number on the Student Plan page, and the primary academic program is designated by the lowest career sequence number on the Student Program page. However, when a student has multiple programs (containing multiple plans), the primary academic plan is not necessarily the lowest plan sequence number under a given program, but it is that plan with the lowest plan sequence number under the program with the lowest student career number. For example, under a program of Liberal Arts Undergraduate (attached to a student career number of 0), a student has a plan of Psychology with a plan sequence number of 10. The same student has a plan of Art with a plan sequence number of 10 under a program of Fine Arts Undergraduate (attached to a student career number of 1). Both plans have a plan sequence number of 10, but the plan under the program with the lowest career number is the primary plan. In this example, the primary plan is Psychology, which is tied to a student career number of 0 through the Liberal Arts Undergraduate program. Primary Academic Program: Indicates a student's primary academic program. The primary academic program is the program designated by the lowest career sequence number. On the Student Program page, student career number 0 is the primary career.</p> <hr/> <p><i>Student Group:</i> Indicates a grouping of students. For example, values might include athlete and veteran. You define values in the Student Group table.</p> <p><i>Student Groups:</i> Indicates that all of the student groups containing a student are part of the equation.</p> <p><i>Test Score:</i> Select to use a test score as a condition. If you select this field value, the following additional fields appear: Test ID, Test Component, Condition Operator, Test Score, Months Valid, and Test Score Method.</p> <p>Months Valid and Test Score Method are editable according to the setup on the Define Tests for Advisement page.</p> <p>If you select <i>User Programmable Condition</i>, the Condition Process Identifier field becomes available. Select the appropriate value for the condition process. The delivered values are: <i>0001</i> (Milestone Check), <i>0002</i> (Internal Degree Check), and <i>0003</i> (External Degree Check). Milestone Check verifies whether a milestone is completed, in progress, or not completed. Internal Degree Check verifies whether a student has received a degree from the home institution. External Degree Check verifies whether a student has received a degree from another institution.</p> <hr/> <p>Note: You can create additional condition process identifier field values in the Condition Processes table. Delivered field values are numbered from 1 through 500. Client-added values should be numbered above 500.</p>

Field or Control	Description
Condition Operator	<p>Values are: <i>Equal, Greater Than, Greater or Equal, In, Less Than, Less or Equal, Not Equal, and Not In</i>. <i>None</i> is the same as <i>Equal</i>.</p> <p>The operators of <i>In</i> and <i>Not In</i> are for use with requisite entity groups and so are available only when you select the following condition codes: <i>Academic Plan, Academic Plans, Primary Academic Plan, Academic Program, Academic Programs, Primary Academic Program, Academic Sub Plan, Academic Sub Plans, Student Group, and Student Groups</i>.</p> <p>If you select the operator <i>In</i> or <i>Not In</i>, the Condition Data field prompts on requisite entity groups that you set up using the Requisite Entity Groups component.</p> <hr/> <p>Note: A student with a null set of entities is always considered true for all plurals of that entity for both <i>In</i> and <i>Not In</i> because the null set is included in all entity groups and all entity group complements.</p> <hr/> <p>Operators are not used if the precondition is <i>Dynamic Condition</i>. If the precondition is <i>Dynamic Condition</i>, then select one of the dynamic conditions that you previously created in the Define Dynamic Condition component.</p>
Condition Data	The system prompts you with values based on your selections in the Condition Code and Condition Operator fields.

Field or Control	Description
Academic Institution	If applicable, enter the academic institution. Each condition line detail is associated with only one academic institution.
Academic Career	If applicable, enter the academic career that contains the academic program that is associated with this condition line detail.
Academic Program	If applicable, enter the academic program that is associated with this condition line detail.
Academic Plan	If applicable, enter the academic plan that is associated with this condition line detail.
Milestone	Enter the milestone that must be achieved to satisfy this condition line detail. For example, a milestone could be an audition, qualifying exam, or thesis. You define milestones in the Milestone table.

Field or Control	Description
Milestone Complete	Select the appropriate milestone. Values are: <i>None:</i> Indicates that the field is not applicable. <i>Completed:</i> Indicates that the student must complete this milestone to satisfy the condition line detail. <i>In Progress:</i> Indicates that the student must be working towards completing the milestone to satisfy the condition line detail. <i>Not Completed:</i> Indicates that the student must not have completed this milestone to satisfy the condition line detail.
Milestone Level	Enter the minimum level for this milestone. Some examples of milestone levels are honors, undergraduate, or graduate.
Minimum Grade Points	Enter the minimum grade points that are acceptable to complete this condition line detail.
Milestone Title	Enter a descriptive phrase as the milestone title. Use this field for documentation purposes only.

If the condition process type is *User Programmable Condition* and the condition process identifier selected is *External Degree Check* or *Internal Degree Check*, the user then must select a degree.

Field or Control	Description
Degree	Enter the degree that must be obtained to satisfy the condition line.

If you select the condition process type of *standard condition* and the condition code of *Test Score*, the appearance of the page changes.

Field or Control	Description
Test ID	Select a Test ID from those defined on the Define Advisement Tests page.
Test Component	The selection options are based on the Test ID selected.

Field or Control	Description
Condition Operator	Identifies what type of comparison is to be applied to the condition data. Possible condition operators include: <i>None, Less or Equal, Greater or Equal, Equal, Greater Than, Less Than, and Not Equal</i> . Make sure that you use an operator that makes sense in the equation. Values for this field are delivered with your system as translate values. Do not modify these values. Any modifications to these values require a substantial programming effort.
Test Score	Enter a score required for the test component and condition operator selected.
Months Valid	The value indicates the number of months for which a test score is valid. This field is available for editing based on the setup on the Define Tests for Advisement page.
Test Score Method	<p>Values are:</p> <p><i>Average of All Scores Taken:</i> Select to have the advisement engine average scores when it processes the tests for a condition in an enrollment requirement or requirement group.</p> <p><i>First Test Taken:</i> Select to have the advisement engine use the test score with the earliest date when it processes the tests for a condition in an enrollment requirement or requirement group.</p> <p><i>Highest Score:</i> Select to have the advisement engine use the highest score for a given test when it processes the tests for a condition in an enrollment requirement or requirement group.</p> <p><i>Last Test Taken:</i> Select to have the advisement engine use the score from the date of the last test taken when it processes the tests for a condition in an enrollment requirement or requirement group.</p> <p><i>Lowest Score:</i> Select to have the advisement engine use the lowest score for a given test when it processes the tests for a condition in an enrollment requirement or requirement group.</p>

When you select the **Calculate Test Score** check box, other fields become available so that you can define the details of the calculation to be performed when the dynamic condition is used in an enrollment requirement or enrollment requirement group.

Field or Control	Description
Test Component Taken Option	This field appears in the Condition Details group box only when the Calculate Test Score check box is selected. Valid values are: <i>Tests Taken on Different Dates</i> and <i>Tests Taken on Same Date</i> .

Field or Control	Description
Test ID	This field appears in the Condition Details group box only when the Calculate Test Score check box is selected. These prompt from the Test IDs defined on the Define Advisement Tests page.
Condition Operator	This field appears in the Condition Details group box only when the Calculate Test Score check box is selected. Identifies what type of comparison is to be applied to the condition data. Possible condition operators include: <i>None, Less or Equal, Greater or Equal, Equal, Greater Than, Less Than, and Not Equal</i> . Make sure that you use an operator that makes sense in the equation. Values for this field are delivered with your system as translate values. Do not modify these values. Any modifications to these values require a substantial programming effort.
Calculation Method	This field appears in the Condition Details group box only when the Calculate Test Score check box is selected. Valid values are: <i>Average of the Components</i> and <i>Sum of the Components</i> .
Score Required	This field appears in the Condition Details group box only when the Calculate Test Score check box is selected. Enter a valid score required as it relates to the values selected in the preceding fields.
Months Valid	This field appears in the Condition Details group box only when the Calculate Test Score check box is selected. This field is available for editing based on the setup on the Define Tests for Advisement page. The value indicates the number of months for which a test score is valid.

Field or Control	Description
Test Score Method	<p>This field appears in the Condition Details group box only when the Calculate Test Score check box is selected. Values are:</p> <p><i>Average of All Scores Taken:</i> Select to have the advisement engine average scores when it processes the tests for a condition in an enrollment requirement or requirement group.</p> <p><i>First Test Taken:</i> Select to have the advisement engine use the test score with the earliest date when it processes the tests for a condition in an enrollment requirement or requirement group.</p> <p><i>Highest Score:</i> Select to have the advisement engine use the highest score for a given test when it processes the tests for a condition in an enrollment requirement or requirement group.</p> <p><i>Last Test Taken:</i> Select to have the advisement engine use the score from the date of the last test taken when it processes the tests for a condition in an enrollment requirement or requirement group.</p> <p><i>Lowest Score:</i> Select to use the lowest score for a given test when tests for a condition in an enrollment requirement or requirement group are processed.</p>
Condition Line Sequence	Appears by default, starting with the number 1. Each condition line must have a unique condition line sequence value.
Test Component	This field appears in the Condition Lines group box only when the Calculate Test Score check box is selected. The selection options are based on the Test ID selected.
Minimum Score	This field appears in the Condition Lines group box only when the Calculate Test Score check box is selected. Enter the minimum acceptable score for the test component identified for the condition line sequence.

Related Links

“Defining Custom Conditions” (Academic Advisement)

Defining Entity Groups for Use in Requisites (Optional)

This section discusses how to define entity groups for use in enrollment requisites.

Entity groups are similar items (programs, plans, subplans, or student groups) that are grouped together to be used in a condition. An example is that you have a requisite for a course that states a student must be enrolled in one of five plans to enroll in the course. To make this a simple condition, the five plans are placed into an entity group. When the condition is defined, it states that academic plans must be in the entity group. This allows for many similar objects to be grouped together for comparison.

Page Used to Define Enrollment Requisite Entity Groups

<i>Page Name</i>	<i>Definition Name</i>	<i>Navigation</i>	<i>Usage</i>
Define an Entity Group	SSR_RQ_ENTITY_GRP	Curriculum Management > Enrollment Requirements > Define Requisite Entity Groups > Define Requisite Entity Groups	Define the academic entity group to be used as a precondition or condition requirement.

Defining Requisite Entity Groups

Access the Define Requisite Entity Groups page (**Curriculum Management** > **Enrollment Requirements** > **Define Requisite Entity Groups** > **Define Requisite Entity Groups**).

This example illustrates the fields and controls on the Define Requisite Entity Groups page. You can find definitions for the fields and controls later on this page.

Define Requisite Entity Groups

[Find](#) | [View All](#) First ◀ 1 of 1 ▶ Last

Entity Group: 000015 + -

***Effective Date:** 01/01/1900 31 ***Status:** Active ▼

***Description:** Fine Arts Majors **Short Description:** Fine Arts

Long Description: Fine Arts Majors ⬆ ⬇ ⬇ ⬆

***Academic Institution:** PSUNV ▼ PeopleSoft University

***Entity Group Type:** Plan ▼

Entity Group Item Detail

[Customize](#) | [Find](#) | 1-4 of 4 First ◀ 1-4 of 4 ▶ Last

	Academic Plan	Description		
1	ART 🔍	Art (BFA)	+	-
2	ARTHIST 🔍	Art History (BFA)	+	-
3	DANCE 🔍	Dance (BFA)	+	-
4	MUS-BA 🔍	Music-BA	+	-

Note: Entity groups that are defined in this component are saved with a requirement usage code of ENR.

<i>Field or Control</i>	<i>Description</i>
Entity Group	This system generated number is unique for each entity group. It can be used to build a condition at the enrollment requirement group or enrollment requirement level.

Field or Control	Description
Effective Date	The latest effective date that you enter for the entity group is used during processing.
Academic Institution	Select the academic institution. Each entity group is associated with only one academic institution.
Description	Enter a description for the entity group. The description appears in the enrollment requirement group and enrollment requirement summaries.
Entity Group Type	Select the entity group type that indicates the type of items that are contained in the group. This field value determines what information appears in the Entity Group Item Detail group box. <i>Program</i> is the default value.

Entity Group Item Detail

This group box lists the details (entities) in this requisite entity group. An entity group item number is a sequential line number that the system automatically assigns to each item in the entity group. You can override the number. The system automatically supplies the description.

Defining Enrollment Requirement Groups

This section provides an overview of enrollment requirement group setup and discusses how to:

- Define enrollment requirement groups.
- Define overall requisite parameters.
- Define requisite details.
- Define requisite detail level parameters.

Understanding Enrollment Requirement Group Setup

Enrollment requirement groups encompass requisites based on a variety of factors including grade point average and units, courses, and much more. Virtually every prerequisite or corequisite that your institution has for courses can be satisfied with the Enrollment Requirement Group component alone.

Enrollment requirement groups are also used for reserve capacity portions of classes. You can create enrollment requirement groups which are later attached to classes designating a reserve capacity for students who meet a certain criteria (for example, you can set aside 10 seats in a class for students with a certain academic level, cumulative GPA, number of units earned, and so on).

You attach enrollment requirement groups to courses in the course catalog, and you can override these requisite rules or append them on a class-by-class basis when you create the schedule of classes. One course catalog offering can refer to one enrollment requirement group rule, but that rule can contain

multiple course requisites and noncourse enrollment restrictions (such as condition requirements). Multiple course offerings can use the same enrollment requirement group or different ones. Reusability, and thus a reduction in data entry and maintenance, is a valuable aspect of this feature.

Of course, a number of ways are available for you to structure your course requisites. Many times more than one "correct" way exists to structure requisites using a combination of enrollment requirement groups and enrollment requirements (which we review later in this section). We review examples of course requisite setup in this section as well.

Here is a high-level overview of how to create a simple enrollment requirement group or reserve capacity:

1. Create a description of the enrollment requirement group on the Course Requisite page.
2. Determine whether parameters such as minimum GPA, units, or number of courses are an attribute of the requirement on the Requisite Parameters page.
3. Enter any other parameters of the requisite such as a course, a range of courses, a student attribute (such as program or plan), and so on, on the Requisite Detail page.
4. Determine whether any course validation parameters exist for the requisite courses on the Requisite Detail Parameters page.
5. Attach the enrollment requirement group to a course offering on the Course Catalog - Offerings page (as a requisite); or attach the enrollment requirement group to a course on the Schedule of Classes - Reserve Cap (Schedule of Classes - Reserve Capacity) page (as a reserve capacity).

Pages Used to Define Enrollment Requirement Groups

<i>Page Name</i>	<i>Definition Name</i>	<i>Navigation</i>	<i>Usage</i>
Course Requisite	CRSE_REQUIS_RESTR	Curriculum Management > Enrollment Requirements > Enrollment Requirement Groups > Course Requisite	Describe the enrollment requirement group. The system generates a unique numeric identifier for the group, although you can enter your own number for the group.
Requisite Parameters	CRSE_RQS_RSTR_PARM	Curriculum Management > Enrollment Requirements > Enrollment Requirement Groups > Requisite Parameters	Specify overall GPA and unit requirements for all of the requisite detail lines in the group. The GPA, course and unit minimums that are entered apply to the overall course restrictions for the classes that are specified in the subsequent requirement pages.

Page Name	Definition Name	Navigation	Usage
Requisite Detail	CRSE_RQS_RSTR_DET	Curriculum Management > Enrollment Requirements > Enrollment Requirement Groups > Requisite Detail	Link the actual courses or noncourse requirements to the enrollment requirement group. The page is similar to the Academic Requirement Group - Detail page in PeopleSoft Academic Advisement.
Requisite Detail Parameters	CRSE_RQS_DET_PRM	Curriculum Management > Enrollment Requirements > Enrollment Requirement Groups > Requisite Detail Parameters	Further define the details of Course or Wild Card Course group line types.

Defining Enrollment Requirement Groups

Access the Course Requisite page (**Curriculum Management** > **Enrollment Requirements** > **Enrollment Requirement Groups** > **Course Requisite**).

This example illustrates the fields and controls on the Course Requisite page. You can find definitions for the fields and controls later on this page.

The screenshot displays the 'Course Requisite' page with the following fields and values:

- Requirement Group:** 008047
- *Effective Date:** 01/01/1900
- *Status:** Active
- *Description:** Soc 100 Pre-Reqs
- *Short Description:** ERG 2
- *Long Description:** Requires PHILO 100 (3 units minimum grade of C) and HISTORY 100 (3 units minimum grade of C)
- *Report Description:** Soc 100 Pre-Reqs
- *Report Long Description:** Course A (SOC 100) requires Course B (PHILO 100) and Course C (HISTORY 100) 3 units min Grade C in each
- *Academic Institution:** PSUNV (PeopleSoft University)
- Academic Group:** (Empty)
- Subject Area:** SOC (Sociology)
- Catalog Nbr:** 100 (Introduction to Sociology)
- Enable Catalog Print**

Field or Control	Description
Effective Date	<p>Enter an effective date for this enrollment requirement group. The effective date must be equal to or less than the effective date of the course to which this course requisite is attached.</p> <hr/> <p>Note: The system accesses the enrollment requirement group rules based on the start date of the term for which the requisite checking occurs. As long as your effective date is less than or equal to the term start date and the status is <i>Active</i>, the enrollment posting process checks this rule.</p>
Status	<p>Select a status for this enrollment requirement group. Select <i>Active</i> when adding a new enrollment requirement group. Select <i>Inactive</i> only if your institution no longer wants to use this enrollment requirement group.</p> <hr/> <p>Note: If you want to inactivate an enrollment requirement group, you need to delete the number for that enrollment requirement group from each course to which it is attached on the Catalog Data page.</p>
Description, Short Description, and Long Description	Enter a description, short description, and long description for the enrollment requirement group.
Report Description and Report Long Description	Enter a report description and long description for the enrollment requirement group to be used by the enrollment requirement checking processes.
Academic Institution	The system populates the academic institution field by default. You can change the value.
Academic Group, Subject Area, and Catalog Nbr (catalog number)	The system does not include these values in the analysis of the requirement group. These values are helpful tools for searching the database for the appropriate requirement group to attach to a course. You may want to use these fields to signify the course to which the requisite is attached, or to specify department ownership of the requisite.
Enable Catalog Print	Select this check box to display the long description of the enrollment requirement group in the course catalog.

Defining Overall Requisite Parameters

Access the Requisite Parameters page (**Curriculum Management > Enrollment Requirements > Enrollment Requirement Groups > Requisite Parameters**).

This example illustrates the fields and controls on the Requisite Parameters page. You can find definitions for the fields and controls later on this page.

Course Credit Parameters

Course credit parameters are overall criteria that the system uses in the evaluation of all combined requisite detail lines.

<i>Field or Control</i>	<i>Description</i>
Minimum GPA (minimum grade point average)	Enter the overall minimum GPA for classes that are selected to meet this requirement.
Minimum Units	Enter the total minimum units for the classes that are selected to meet this requirement.
Minimum Courses	Enter the total minimum courses for the requirement.

Default for Detail Level

<i>Field or Control</i>	<i>Description</i>
Min Grade Points/Units (minimum grade points/units)	The system uses the minimum grade points per unit value as a filter in the requisite checking process. This technique is used to simplify and generalize the comparison logic. The minimum grade point/unit value is the minimum grade points that are required for any individual class that is selected to meet the requirement. The system includes a student's in-progress work as counting toward the minimum.

Detail Selection Parameters

<i>Field or Control</i>	<i>Description</i>
<p>Connector Type</p>	<p>For enrollment requirement groups with more than one requisite detail line, select the appropriate connector type. The connector type indicates whether the student must meet <i>all</i> of the requirement line detail conditions (<i>AND</i>) or whether the student only needs to meet one of the requirement line details (<i>OR</i>). This value is used as the connector default on the Requisite Detail page when rows are inserted.</p>

Defining Requisite Details

Access the Requisite Detail page (**Curriculum Management > Enrollment Requirements > Enrollment Requirement Groups > Requisite Detail**).

This example illustrates the fields and controls on the Requisite Detail page. You can find definitions for the fields and controls later on this page.

The screenshot displays the 'Requisite Detail' page with the following information:

- Requirement Group:** 008047, **Description:** Soc 100 Pre-Reqs
- Effective Date:** 01/01/1900, **Status:** Active
- Group Line Type:** 1 of 2
- *Line:** 0010
- *Group Line Type:** Course
- Report Description:** Philo 100
- Report Long Description:** Requires Philo 100 with a minimum grade of C.
- Requisite Type:** Pre-Requisite
- Course ID:** 001208 (Introduction to Philosophy), PHILO 100
- Term:** [Empty field]
- Associated Class:** [Empty field]
- Topic ID:** [Empty field]
- Include Equivalent Courses**

Field or Control	Description
Refresh Parentheses	<p>This button is available only when you add a new detail line. Click this button to refresh the parentheses setting. You cannot explicitly set parentheses to group detail rows.</p> <p>If the main connector type is <i>AND</i>, then the system automatically groups <i>ORs</i> together with parentheses. For example, if A or B and C or D is entered, then the implied statement is (A or B) and (C or D).</p> <p>If the main connector type is <i>OR</i>, then the system automatically groups <i>ANDs</i> together with parentheses. For example, if A or B and C or D is entered, then the implied statement is A or (B and C) or D.</p>
Line	The system generates the line number. The number determines the order in which the system evaluates the detail lines. You can change the number, but no two lines can have the same number.

Field or Control	Description
Group Line Type	<p>Select the requirement line type. The group line type that you select determines the format for this line. Values for this field are delivered with your system as translate values. Do not modify these values in any way. Any modification to these values requires a substantial programming effort.</p> <p>The four group line types are:</p> <ul style="list-style-type: none"> • <i>Condition</i> <p>Specifies allowable values of data elements that are associated with a student, for example, a condition of <i>Academic Level</i>. When you specify a condition that you want to require in the Condition Code field, other fields appear that enable you to complete the condition statement. If you select the condition code <i>Dynamic Condition</i>, select a condition specification that was previously defined on the Define Requisite Conditions component. If you select the condition code <i>Test Score</i>, then you are presented with additional fields (Test ID, Test Component, Condition Operator, Test Score, Months Valid, and Test Score Method) based on the setup on the Define Tests for Requisites page.</p> • <i>Course</i> <p>Specific course a student must take to fulfill the requisite. Specify the course ID, and if you want to allow equivalent courses to satisfy this requisite, select the Include Equivalent Courses check box for the system to include in its evaluation both the course ID that you specify and all courses that are set up as equivalent to the selected course ID for this requirement. If you select this check box, the following fields become unavailable: Term, Associated Class, and Topic ID. <i>Clear</i> this check box to further narrow your course parameters with the Term, Associated Class, and Topic ID fields. For example, you can specify not only the course ID, but also the term in which the specific course must be taken to fulfill the requisite.</p> • <i>Requirement</i> <p>Specifies individual required elements. You are prompted for the requirement number. You can enter an enrollment requirement number or an academic requirement number. Enrollment requirements are used to fulfill your more complicated requirement rules and are created in the Enrollment Requirement component. Specify the enrollment requirement or academic requirement for this line in the Requirement field.</p> <p>You can view examples of how to use an academic requirement (as opposed to an enrollment requirement).</p> <p>See “Setting Up Academic Requirements” (Academic Advisement)</p> • <i>Wild Card Course</i>

Field or Control	Description
	Specifies a range of courses based upon subject area and catalog number, for example, wild card course of <i>English 1##</i> , where the range starts at any three-digit English course beginning with 1. Specify as few or as many criteria as you want using the Academic Group , Subject , and Catalog Nbr fields. Blank fields return all values.
Report Description and Report Long Description	Enter a report description and long description for the requisite detail to be used by the enrollment requirement checking processes. If neither of the fields is populated, the enrollment requirement checking processes generate a default description based on the data on the page.

This table shows the way the fields on this page change, depending on the group line type that you select:

Group Line Type	Fields That Appear	Fields That Are Hidden
Condition	<ul style="list-style-type: none"> • Condition Code • Condition Operator • Condition Data <hr/> <p>Note: The Condition Operator and Condition Data fields appear after you select the condition code.</p> <hr/>	<ul style="list-style-type: none"> • Requisite Type • Course ID • Include Equivalent Courses • Term • Associated Class • Topic ID • Requirement • Academic Group • Subject • Catalog Nbr • Test ID • Test Component • Condition Operator • Test Score • Months Valid • Test Score Method

Group Line Type	Fields That Appear	Fields That Are Hidden
Condition	If you select a condition code of <i>Dynamic Condition: Condition Data</i>	<ul style="list-style-type: none"> • Requisite Type • Course ID • Include Equivalent Courses • Term • Associated Class • Topic ID • Requirement • Academic Group • Subject • Catalog Nbr (catalog number) • Test ID • Test Component • Condition Operator • Test Score • Months Valid • Test Score Method
Condition	If you select a condition code of test score: <ul style="list-style-type: none"> • Test ID • Test Component • Condition Operator • Test Score • Months Valid • Test Score Method 	<ul style="list-style-type: none"> • Requisite Type • Course ID • Include Equivalent Courses • Term • Associated Class • Topic ID • Requirement • Academic Group • Subject • Catalog Nbr (catalog number)

Group Line Type	Fields That Appear	Fields That Are Hidden
Course	<ul style="list-style-type: none"> • Course ID • Include Equivalent Courses • Term • Associated Class • Topic ID 	<ul style="list-style-type: none"> • Condition Code • Condition Operator • Condition Data • Requirement • Academic Group • Subject • Catalog Nbr • Test ID • Test Component • Test Score • Months Valid • Test Score Method
Requirement	Requirement	<ul style="list-style-type: none"> • Course ID • Include Equivalent Courses • Term • Associated Class • Topic ID • Condition Code • Condition Operator • Condition Data • Academic Group • Subject • Catalog Nbr • Test ID • Test Component • Test Score • Months Valid • Test Score Method

Group Line Type	Fields That Appear	Fields That Are Hidden
Wild Card Course	<ul style="list-style-type: none"> • Academic Group • Subject • Catalog Nbr 	<ul style="list-style-type: none"> • Course ID • Include Equivalent Courses • Term • Associated Class • Topic ID • Condition Code • Condition Operator • Condition Data • Requirement • Test ID • Test Component • Test Score • Months Valid • Test Score Method

Field or Control	Description
Include Equivalent Courses	<p>Select for the system to include in its evaluation both the course ID that you specify and all courses that are set up as equivalent to the selected course ID for this requirement.</p> <p>If you select this check box, the following fields become unavailable: Term, Associated Class, and Topic ID.</p> <p>Clear this check box to further narrow your course parameters with the Term, Associated Class, and Topic ID fields. For example, you can specify not only the course ID, but also the term in which the specific course must be taken to fulfill the requisite.</p>
Term	<p>Enter the term in which the student must take the course that you specify for the course to be used in this enrollment requirement group. Leave this field blank to return all values.</p>

Field or Control	Description
Associated Class	<p>Enter the associated class number (of the course that you specify) that the student must take for the course to be used in this enrollment requirement group. For class associations, indicate a term to prompt off valid values. Leave this field blank to return all values.</p> <hr/> <p>Note: You cannot enter 9999, because this special associated class number can be associated with any other associated class number and is never an enrollment section.</p> <hr/> <p>See Defining Class Associations.</p>
Topic ID	<p>Enter the topic ID (of the course that you specify) that the student must take for the course to be used in this enrollment requirement group. This field prompts from the topics defined in the course catalog. Leave this field blank to return all values.</p>
Requisite Type	<p>Specify whether this requirement line is a prerequisite or a corequisite. A prerequisite is something that a student must complete before the start date of the desired class. If you use an enrollment course list (as part of an enrollment requirement), you can allow in-progress coursework to fulfill prerequisites. A corequisite is something that a student can complete prior to, or at the same time as, the desired class. Conditions are always set up as prerequisites in the background. Students either meet the condition at the time of enrollment (which means that they currently have the required condition), or they do not.</p>

Defining Requisite Detail Level Parameters

Access the Requisite Detail Parameters page ((**Curriculum Management > Enrollment Requirements > Enrollment Requirement Groups > Requisite Detail Parameters**)).

This example illustrates the fields and controls on the Requisite Detail Parameters page. You can find definitions for the fields and controls later on this page.

The screenshot shows a web interface with four tabs: 'Course Requisite', 'Requisite Parameters', 'Requisite Detail', and 'Requisite Detail Parameters'. The 'Requisite Detail Parameters' tab is active. Below the tabs, there are two main sections: 'Detail Parameters' and 'Course Validation Parameters'.
 The 'Detail Parameters' section includes:
 - Requirement Group: 008047
 - Description: Soc 100 Pre-Reqs
 - Effective Date: 01/01/1900
 - Status: Active
 The 'Course Validation Parameters' section includes:
 - Course Information: Introduction to Philosophy
 - Minimum Units: 3.00
 - Min Units/Course: 3.00
 - Minimum Courses: 1.00
 - Min Grade Points/Unit: 2.00
 - Transfer Level Allowed: Always Allow (dropdown menu)
 - Requirement Designation: (text input with search icon)
 - Valid Begin: (calendar icon)
 - Valid End: (calendar icon)
 - Course must be GPA material:
 - Test Credit is Allowed:
 - Other Credit is Allowed:
 - Exclude In-Progress Credit:

Note: This page is necessary only if you have a line type of course or wild card course on the Requisite Detail page.

Field or Control	Description
Minimum Units	Enter the minimum units that are required for the course or the wildcard course for this requisite detail line.
Min Units/Course (minimum units per course)	Enter the minimum units per course value to indicate the minimum number of units that a single course must be worth to be evaluated. For example, if you set this to 3, the system picks up only courses that are worth three units or greater. If the system finds a course on the student's record that matches the course on the Requisite Detail page, but it is only two units, the course is not used to meet the requisite.
Minimum Courses	Enter the minimum number of courses that are required of the course or wildcard course that you specify. For example, if you set this to 2, the system looks for at least two courses of the course or wildcard course that you specify. When the system finds at least two courses that match your requisite detail line, the requisite is satisfied.
Min Grade Points/Unit (minimum grade points per unit)	Enter the minimum grade points per unit that each course must have to be used to satisfy the course requisite. For example, if you set this to 7, then each course must be a grade C or greater to be evaluated ($.7 \times 3$ units = 2.1, or a grade of C).

Field or Control	Description
Transfer Level Allowed	<p>Enter a transfer-level-allowed value that indicates what type of transfer credit (if any) is acceptable. Values are:</p> <p><i>Always Allow:</i> All applicable transfer credit can be used to satisfy the requisite.</p> <p><i>Never Allow:</i> Transfer credit can never satisfy the requisite.</p> <p><i>Two Year Institution Only:</i> Only transfer credit from two-year institutions can be used to satisfy the requirement.</p> <p>On the School Data page, an institution can be identified as a two- or four-year institution.</p> <p>See Defining External Organizations.</p>
Requirement Designation	<p>Select the requirement designation that each course for this requisite detail line must possess to be evaluated. For example, if you specify a wild card course list of <i>ARCH 4##</i> on the Requisite Detail page, then specify a requirement designation of <i>DSGN</i> on the Requisite Detail Parameters page. Only <i>ARCH 400</i> - level courses that have a designation of <i>DSGN</i> (with a grade of Satisfied) meet this requisite.</p> <p>Requirement designation values are defined on the Requirement Designation Table page.</p> <p>See Understanding Requirement Designations.</p>
Valid Begin and Valid End	<p>Enter valid begin and valid end dates to specify the date range when the courses must be taken to satisfy the requisite. Leaving these fields blank means that it does not matter when the courses are taken. When the system compares the date range, it uses the start and end dates of the term in which the course was taken. For transfer courses, the system uses the start date and end date of the articulation term.</p>
Course must be GPA Material	<p>Select this check box to require that courses evaluated for this requisite must be applied toward the student's career GPA calculation. For instance, any courses that a student took for a pass/no pass grade basis would not be evaluated, as typically this grade basis does not have the Include in GPA check box selected on the Grading Scheme Table page.</p>
Test Credit is Allowed	<p>Select this check box to allow test credit courses to be evaluated.</p>
Other Credit is Allowed	<p>Select this check box to allow other credit courses to be evaluated.</p>

<i>Field or Control</i>	<i>Description</i>
Exclude In-Progress Credit	If the course that the student takes to satisfy this requisite must be fully graded for the system to consider it valid, select this check box. If this check box is cleared, the system will include in analysis, and pass all parameters any nongraded courses, as well as any graded courses that have the In-Progress flag enabled (such as incomplete courses), and that match the course ID or wild card course on the Requisite Detail page. Leaving this check box cleared is the least restrictive, and allows for maximum user/student flexibility.

Examples of Enrollment Requirement Groups

The enrollment requirement group feature is robust. While reviewing the Academic Advisement documentation will significantly enhance your knowledge of enrollment requirement groups, we review some examples in this section of how to set up the Requisite Detail page.

You can create course requirements many ways, and usually more than one way exists to create any particular course requirement. Some of the complex examples use the enrollment requirement and course list features, documented later in this section.

Course or Condition Requisite

At PSUNV, Psychology 288, Neuropsychology, requires that students have either passed Psychology 124 *or* declared a primary academic plan of psychology. In this example, Psychology 124 is a course prerequisite, and the primary academic plan of psychology is a condition prerequisite. Notice that for the condition, the **Requisite Type** field becomes unavailable for entry. This is because the system is populating the field to prerequisite in the background.

The Requisite Detail page has two requisite lines, joined together with an "or" statement:

The screenshot displays the 'Requisite Detail' page for 'Psych 288'. The page is divided into two main sections for the two requisite lines, separated by a horizontal line. Both sections have a 'Refresh Parentheses' button and a '*Line: NEW' indicator.

Line 1 (Course Prerequisite):

- *Group Line Type: Course
- Course ID: 003010 (Physiological Psychology)
- Requisite Type: Pre-Requisite
- Include Equivalent Courses:

Line 2 (Condition Prerequisite):

- Operator: OR
- *Group Line Type: Condition
- Academic Institution: PeopleSoft University
- Condition Code: Primary Academic Plan
- Condition Operator: Equal
- Condition Data: PSYCH (Psychology)

Wild-Card Course Requisite

At PSUNV, Education 338, Development of Reading Skills, requires a prerequisite of any Education 200-level course, *and* Psychology 240. In this example, the Education 200 level course is specified as a *Wild Card Course* prerequisite, and Psychology 240 is a regular *Course* prerequisite.

The Requisite Detail page would have two requisite lines, joined together with an "and" statement:

The screenshot shows the 'Requisite Detail' page for requirement group 000000, description 'Ed 338', effective date 01/01/1900, and status 'Active'. It displays two prerequisite lines:

- Line 0010:**
 - Group Line Type: Wild Card Course
 - Academic Institution: PeopleSoft University
 - Academic Group: LBART (College of Liberal Arts)
 - Subject: EDUC (Education)
 - Catalog Nbr: 2##
 - Requisite Type: Pre-Requisite
- Line 0020:**
 - Operator: AND
 - Group Line Type: Course
 - Course ID: 003018 (Learn Behv) and PSYCH 240
 - Include Equivalent Courses:
 - Requisite Type: Pre-Requisite

Requirement, Course, and Course List Requisite

At PSUNV, Biology 231, Neurobiology, requires Biology 1 and 2 (as almost all biology courses require), as well as Chemistry 101 and 102. Because the requisite of Biology 1 and 2 will be used repeatedly for virtually every biology course, we developed an enrollment requirement called Biology 1 and 2. Within that enrollment requirement is a course list of Biology 100 and 101. In our Biology 231 enrollment requisite group we define a group line type of *Requirement* that points to the Biology 1 and 2 requirement, as well two group line types of *Course* for Chemistry 101 and Chemistry 102.

Note: Alternative ways are available of defining such a requisite scenario without using course lists, but this is one way that you can define these requisites.

After we defined a Biology 1 and 2 course list and an enrollment requirement, we created the enrollment requirement group, entering the following detail lines on the Requisite Detail page. The page has three detail lines: one for the enrollment requirement of Biology 1 and 2, one for the course requirement of Chemistry 101, and the last for the course requirement of Chemistry 102:

The screenshot shows the 'Requisite Detail' page for Requirement Group 000000, Description NeuroBiology 231, Effective Date 01/01/1900, and Status Active. The 'Group Line Type' section shows a dropdown menu set to 'Requirement', with a search icon and the text 'Biology 1 and 2 Courses'. The 'Requirement Usage' is 'Requisite/Restriction' and the 'Requisite Type' is 'Pre-Requisite'. The line number is 'NEW'.

On the preceding page:

- This requisite is considered first by the system because the line number is 0010, the lowest number in our detail lines.
- The group line type is *Requirement*.
- The requirement is *Biology 1 and 2* (Biology 1 and Biology 2).

These are in a course list because they are used repeatedly together as a prerequisite requirement in a large number of courses.

- The requisite type is *Pre-Requisite*.

The second and third detail lines appear like this:

The screenshot shows the 'Requisite Detail' page for Requirement Group 000000, Description NeuroBiology 231, Effective Date 01/01/1900, and Status Active. The 'Group Line Type' section shows a dropdown menu set to 'Course', with a search icon and the text 'Elementary Chemistry I'. The 'Course ID' is '001163'. The 'Requisite Type' is 'Pre-Requisite'. The connector type is 'AND'. There is a checkbox for 'Include Equivalent Courses' which is checked.

On the preceding page:

- The connector type is *AND* because this rule must be fulfilled along with the Biology 1 and 2 requirement.

- The line number is *0020*. The system evaluates this rule second, because one rule line is preceding it.
- The group line type is *Course*.
- The course ID represents *Chemistry 101*.

The third detail line for Chemistry 102 is exactly like the preceding sample page.

Condition and Wild-Card Course Requisite, Exclude In-Progress Credit

At PSUNV, for a student to enroll in HONORS 499, he or she must have a verifiable cumulative GPA of greater than or equal to 3.0.

To create an enrollment requirement group for this course prerequisite:

1. On the Course Requisite page, enter the necessary data.
2. On the Requisite Parameters page, enter *1* in the **Minimum Course** field.
3. On the Requisite Detail page, create two detail lines and attach as a requisite to HONORS 499.
4. For the first detail line, create a condition of cumulative GPA greater than or equal to 3.0.

Example of the Requisite Detail page as discussed above:

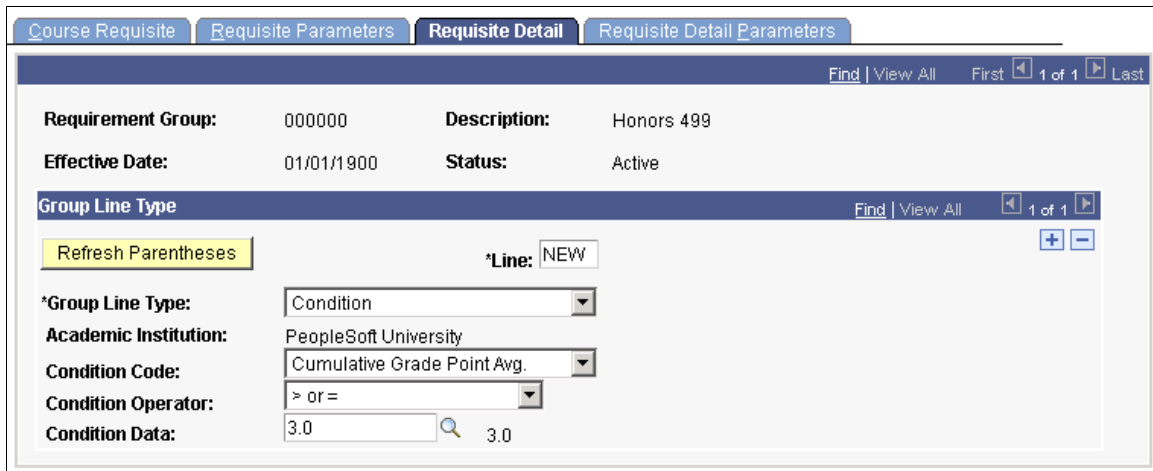

The screenshot displays the 'Requisite Detail' page with the following information:

- Requirement Group:** 000000
- Description:** Honors 499
- Effective Date:** 01/01/1900
- Status:** Active

The 'Group Line Type' section is expanded, showing:

- *Group Line Type:** Condition
- Academic Institution:** PeopleSoft University
- Condition Code:** Cumulative Grade Point Avg.
- Condition Operator:** > or =
- Condition Data:** 3.0

For the second detail line, set the connector type to *And*, then select a group line type of *Wild Card Course*.

Example of the Requisite Detail page as discussed above:

On the Wild Card Course Detail Requisite Detail page, select the **Exclude In-Progress Credit** box.

This requisite verifies that not only does the student have a cumulative GPA of greater than or equal to 3.0, but that the student is not a first semester student with no courses completed at all.

If you decide to include in-progress credit, then even those students who have no coursework completed, but at least one course in progress, will meet this requisite. This assumes that the student will not only complete his or her in-progress credit, but will also complete the in-progress credit with the required GPA.

If you want to be more conservative with this requisite and really ensure that the student has a proven track record, be sure to select the **Exclude In-Progress** check box on the Requisite Detail Parameters page.

Condition and Course Requisite, Exclude In-Progress Credit

At PSUNV, a total of five seats are reserved in Advanced Fiction Writing 2 for students who have a verifiable GPA of greater than or equal to 3.0 and have passed Advanced Fiction Writing 1 with a grade of A.

To create an enrollment requirement group for this reserve capacity check:

1. On the Course Requisite page, enter the necessary data.
2. On the Requisite Parameters page, enter *1* in the **Minimum Course** field.
3. On the Requisite Detail page, create two detail lines and attach as a reserve capacity to Advanced Fiction Writing 2 on the Schedule of Classes - Reserve Cap page.
4. For the first detail line, create a condition of cumulative GPA greater than or equal to 3.0.
5. For the second detail line, set the connector type to *And*, select a group line type of *Course*, select the course ID for Advanced Fiction Writing 1, and select a requisite type of *Pre-Requisite*.

Example of the Requisite Detail page as discussed above:

6. On the Detail Parameters page, select the **Exclude In-Progress Credit** box, and enter a minimum grade point per unit of 4.0.
7. This requisite line ensures that, if the system finds Advanced Fiction Writing 1 on the student's record, the student has completed the course and earned a grade of A.

If you decide to include in-progress credit, then a student with Advanced Fiction Writing 1 in-progress (but not yet completed or graded) will meet the reserve capacity, and the system will allow this student to enroll. Sometimes you may want to be this liberal, but in the instance here, we require that the course be verifiably an A grade.

Course Requisite, Include In-Progress Credit

At PSUNV, for a student to register for ECON 205, the student must either currently be enrolled in ECON 115, or have completed ECON 115 with a C grade or better.

To create an enrollment requirement group for this requisite:

1. On the Course Requisite page, enter the necessary data.
2. On the Requisite Parameters page, enter *1* in the **Minimum Course** field.
3. On the Requisite Detail page, create one detail line and attach as a requisite to ECON 205.
4. For this detail line, select a group line type of *Course*, select the course ID for ECON 115, and select a requisite type of *Pre-Requisite*.
5. On the Requisite Detail Parameters page, enter a minimum grade point per unit of *2.00* and leave cleared the **Exclude In-Progress Credit** box.

Example of the Requisite Detail page as discussed above:

The screenshot shows the 'Requisite Detail' page for requirement group 000000, description Econ 205. The page is divided into several sections:

- Requirement Group:** 000000, **Description:** Econ 205
- Effective Date:** 01/01/1900, **Status:** Active
- Group Line Type:** A sub-section with a 'Refresh Parentheses' button, a '*Line:' field set to 'NEW', and a '+ -' button.
- *Group Line Type:** A dropdown menu set to 'Course'.
- Course ID:** 001012, with a search icon and the text 'Economic Statistics'.
- Requisite Type:** A dropdown menu set to 'Pre-Requisite'.
- Include Equivalent Courses:** A checked checkbox.

This requisite enables both students with ECON 115 in-progress and students with ECON 115 completed with a C grade or higher to fulfill the requisite.

Condition Requisite, Include In-Progress Coursework

At PSUNV, all students with a cumulative GPA of 3.5 and higher may register for EDUC 100 (first semester freshmen with no verifiable GPA at all are also eligible).

To create an enrollment requirement group for this requisite:

1. On the Course Requisite page, enter the necessary data.
2. On the Requisite Parameters page, enter any necessary data.
3. On the Requisite Detail page, create one detail line and attach as a requisite to EDUC 100.

For this detail line, create a condition of cumulative GPA greater than or equal to 3.5.

Example of the Requisite Detail page as discussed above:

The screenshot shows the 'Requisite Detail' page for requirement group 000000, description EDUC 100. The page is divided into several sections:

- Requirement Group:** 000000, **Description:** EDUC 100
- Effective Date:** 01/01/1900, **Status:** Active
- Group Line Type:** A sub-section with a '*Line:' field set to 'NEW' and a '+ -' button.
- *Group Line Type:** A dropdown menu set to 'Condition'.
- Academic Institution:** PeopleSoft University
- Condition Code:** Cumulative Grade Point Avg.
- Condition Operator:** > or =
- Condition Data:** 3.5

This requisite is satisfied by students with some graded coursework (all of which averages greater than 3.5 GPA), as well as by first semester freshmen with no coursework completed at all. This is because a null value passes all parameters.

Example of Maximum Unit Limit for Enrollment

At PSUNV, students can take no more than 12 units of physical education courses. If students attempt to enroll in a physical education course that takes them over the 12-unit limit, their enrollment is blocked by a prerequisite requirement.

To create this maximum unit enrollment requisite:

1. Create an enrollment course list that references all physical education courses (wild card or course by course).

Set up any course parameters. Enter minimum grade point per unit values for each course if you want to count only physical education courses that were successfully completed. If you also want to limit F graded courses, you can leave this field clear.

2. Create an academic requirement that has a line item page line type of *Course Requirement*.
3. Set the **Credit Include Mode** field to *Verify*, and the **Maximum Units Allowed** field to *12.00*.

Be sure this is set to *Verify*. This is the power that regular ENR usage enrollment requirements do not have.

4. Point to your enrollment course list on the Line Item Detail page.
5. Create an enrollment requirement group that points to the academic requirement.

Attach this requirement as a corequisite.

Example of the Requisite Detail page as discussed above:

Course Requisite		Requisite Parameters		Requisite Detail		Requisite Detail Parameters	
Requirement Group:	000000	Description:	Phys Ed Limit			Find View All First 1 of 1 Last	
Effective Date:	07/28/2004	Status:	Active				
Group Line Type						Find View All 1 of 1	
*Group Line Type:	Requirement	*Line:	NEW			+ -	
Requirement:	000001169		Phys Ed Limit				
Requirement Usage:	Requisite/Restriction						
Requisite Type:	Co-Requisite						

Attach this enrollment requisite to all physical education courses.

Defining Enrollment Requirements

This section provides an overview of enrollment requirements and discusses how to:

- Define enrollment requirements.
- Define overall enrollment requirement parameters.

- Define enrollment requirement line types.
- Define line item parameters.
- Define line item course detail.

Understanding Enrollment Requirements

Enrollment requirements are for more complicated requisite needs, and are also great tools for reusability. Create enrollment requirements only if you are using the *Requirement* group line type in an enrollment requirement group. You can use enrollment requirements in conjunction with other enrollment-requirement group line types.

To fully understand enrollment requirements, see “Setting Up Academic Requirements” (Academic Advisement). The pages in PeopleSoft Academic Advisement mirror those in Student Records but with additional functionality. You can set up enrollment requirement groups that reference academic requirements (in the event that you need to take advantage of their complex functionality), so we suggest that you learn as much about them as possible.

Here is a high-level overview of how to define an enrollment requirement:

1. Evaluate your need to use the group line type of *Requirement* on the Requisite Detail page.
2. Enter a description of the enrollment requirement on the Enrollment Requirement page.
3. Determine whether GPA, units, or courses are part of the requirement on the Parameters page.
4. Select a requirement line type and enter a description on the Line Item page.
5. Enter course credit parameters on the Line Item Parameters page.
6. If you're using a course list, create it in the course list component, and add the course list number on the Line Item Detail page.

Note: If you are going to select the line type of condition and specify a dynamic condition or test score, then you must first have set up dynamic conditions and valid test IDs on the Define Requisite Conditions component and Define Tests for Requisites component, respectively.

Pages Used to Define Enrollment Requirements

<i>Page Name</i>	<i>Definition Name</i>	<i>Navigation</i>	<i>Usage</i>
Enrollment Requirement	CRSE_REQUIREMENT	Curriculum Management > Enrollment Requirements > Enrollment Requirements > Enrollment Requirement	Describe the enrollment requirement.

Page Name	Definition Name	Navigation	Usage
Parameters	CRSE_RQRMNT_PARM	Curriculum Management > Enrollment Requirements > Parameters	Enter overall GPA and unit requirements for the requirement.
Line Item	CRSE_RQRMNT_LINE	Curriculum Management > Enrollment Requirements > Enrollment Requirements > Line Item	Define the requirement line type.
Line Item Parm (line item parameters)	CRSE_RQ_LINE_PARM	Curriculum Management > Enrollment Requirements > Enrollment Requirements > Line Item Parm	Specify the unit and GPA requirements for the line type. The fields that appear on the page depend on the line type that you select on the Line Item page.
Line Item Detail	CRSE_RQ_LN_DETAIL	Curriculum Management > Enrollment Requirements > Enrollment Requirements > Line Item Detail	Link course lists, derived course lists, and conditions to your line items. The page controls that appear on the page depend on the line type that you select on the Line Item page.

Defining Enrollment Requirements

Access the Enrollment Requirement page (**Curriculum Management** > **Enrollment Requirements** > **Enrollment Requirements** > **Enrollment Requirement**).

This example illustrates the fields and controls on the Enrollment Requirement page. You can find definitions for the fields and controls later on this page.

Enrollment Requirement		Parameters	Line Item	Line Item Parm	Line Item Detail
Find View All First 1 of 1 Last					
Academic Requirement:	000001220 + -				
*Effective Date:	01/01/1900 31	*Status:	Active v		
Requirement Name:	Econ 100 Level Courses	*Short Description:	Econ 100s		
Description:	ER - D Econ 100 Level Courses ✓				
*Report Description:	ER - RD Econ 100 Level Courses				
*Report Long Description:	ER - RLD Take ECON 100 Level Courses ✓				
*Academic Institution:	PSUNV Q	PeopleSoft University			
Academic Group:	LBART Q	College of Liberal Arts			
Subject Area:	ECON Q	Economics			
Catalog Nbr:	<input type="text"/> Q				

<i>Field or Control</i>	<i>Description</i>
Effective Date	<p>Enter an effective date for this enrollment requirement. The effective date must be equal to or less than the effective date of the enrollment requirement group to which this course requisite is attached.</p> <hr/> <p>Note: The system accesses the enrollment requirement rules based on the start date of the term for which the requisite and restriction checking occurs. As long as your effective date is less than or equal to the term start date, and the status of the enrollment requirement is <i>Active</i>, the system checks the rule in the enrollment process.</p>
Status	<p>Select a status for this requirement. Select <i>Active</i> when you add a new requirement. Select <i>Inactive</i> only if your institution no longer uses this requirement.</p> <hr/> <p>Note: If you want to inactivate a requirement you also need to remove any reference to the requirement number on the Requisite Detail page.</p> <hr/> <p>To determine which enrollment requirement groups reference a particular requirement, run the reverse engineering report.</p> <p>See Generating a Reverse Engineering Report.</p>

Field or Control	Description
Report Description and Report Long Description	<p>Enter a report description and long description for the enrollment requirement to be used by the enrollment requirement checking processes.</p> <p>The report fields are hidden when the group line type is set to <i>Requirement</i>. In this case, the report descriptions are defined within the Enrollment Requirements component.</p>
Academic Institution	<p>The system populates this field by default when you access the page. You can change this value. The institution determines the enrollment requirement groups that can reference this requirement.</p>
Academic Group, Subject Area, and Catalog Nbr (catalog number)	<p>Academic group, subject, and catalog number are not used by the system in the analysis of the requirement, but are helpful tools for when you are searching the database for the appropriate requirement to attach to an enrollment requirement group. You may want to use these fields to signify the course to which the requisite will be attached, or to specify department "ownership" of the requisite. These values are optional.</p>

Defining Overall Enrollment Requirement Parameters

Access the Parameters page (**Curriculum Management > Enrollment Requirements > Enrollment Requirements > Parameters**).

This example illustrates the fields and controls on the Parameters page. You can find definitions for the fields and controls later on this page.

The screenshot shows the 'Parameters' page for an enrollment requirement. At the top, there are navigation tabs: 'Enrollment Requirement', 'Parameters', 'Line Item', 'Line Item Parm', and 'Line Item Detail'. Below the tabs is a search bar with 'Find | View All' and a page indicator 'First 1 of 1 Last'. The main content area displays the following information:

- Academic Requirement:** 000001220
- Description:** Econ 100 Level Courses
- Effective Date:** 01/01/1900
- Status:** Active

Below this information are two main sections:

- Course Credit Parameters:** This section contains four input fields: 'Minimum GPA', 'Minimum Units', 'Minimum Courses', and 'Min Grade Points/Unit'. A 'Default for Detail Level' button is located to the right of the 'Min Grade Points/Unit' field.
- Detail Selection Parameters:** This section contains a 'Connector Type' section with two radio buttons: 'AND' (which is selected) and 'OR'.

Course Credit Parameters

Course credit parameters are overall requirements for all line items. These fields are optional.

<i>Field or Control</i>	<i>Description</i>
Minimum GPA (minimum grade point average)	Enter the overall minimum GPA that all classes that are selected to meet this requirement must satisfy.
Minimum Units	Enter the total minimum units that all classes that are selected to meet this requirement must satisfy.
Minimum Courses	Enter the total minimum courses that all classes that are selected to meet this requirement must satisfy.

Default for Detail Level

<i>Field or Control</i>	<i>Description</i>
Min Grade Points/Unit (minimum grade points per unit)	The system uses the value that you enter as a filter in the evaluation process. This technique is used to simplify and generalize the comparison logic. The minimum grade points per unit are the minimum grade points that are allowed for any individual class enrollment that is selected to meet the requirement.

Detail Selection Parameters

<i>Field or Control</i>	<i>Description</i>
Connector Type	Select the appropriate connector type. The connector type indicates whether the student must meet <i>ALL</i> of the requirement detail conditions (<i>AND</i>) or whether the student needs to meet only one condition (<i>OR</i>). This page control is used as the connector default on the Requirement Line Item page when you insert rows.

Defining Enrollment Requirement Line Types

Access the Line Item page (**Curriculum Management > Enrollment Requirements > Enrollment Requirements > Line Item**).

This example illustrates the fields and controls on the Line Item page. You can find definitions for the fields and controls later on this page.

Field or Control	Description
Line	The number determines the order in which the system evaluates the detail lines. The system generates a sequential line number. You can override the number, but it is best to insert the rows in the correct order.
Line Type	<p>The line type that you select determines the format for this line, and it also determines the fields that become available for entry on the Line Item Detail page and Line Item Parm page. Values for this field are delivered with your system as translate values. Do not modify these values in any way. Any modification to these values requires a substantial programming effort.</p> <p>Each line type value is defined in the PeopleSoft Academic Advisement documentation.</p> <p>See “Creating a Requirement Line Item” (Academic Advisement).</p>
Report Description and Report Long Description	Enter a report description and long description for the line item to be used by the enrollment requirement checking processes.

Defining Line Item Parameters

Access the Line Item Parm page (**Curriculum Management > Enrollment Requirements > Enrollment Requirements > Line Item Parm**).

This example illustrates the fields and controls on the Line Item Parm page (when the line type is Course Requirement). You can find definitions for the fields and controls later on this page.

The screenshot shows a web interface with several tabs: Enrollment Requirement, Parameters, Line Item, Line Item Parm (selected), and Line Item Detail. Below the tabs, there are search and navigation options: Find | View All, First 1 of 1 Last. The main content area is divided into sections:

- Academic Requirement:** 000001220
- Description:** Econ 100 Level Courses
- Effective Date:** 01/01/1900
- Status:** Active
- Line Item Parameters:**
 - Line Nbr:** 0010
 - Description:** LI-LN Econ 100 Level Courses
- Course Credit Parameters:**
 - Minimum GPA:**
 - Minimum Units:**
 - Minimum Courses:**
 - Maximum Units Allowed:**
 - Maximum Courses Allowed:**
 - Min Grade Points/Unit:**

If the line type is *Condition*, no fields appear on the Line Item Parm page.

Field or Control	Description
Minimum GPA (minimum grade point average)	Enter the minimum GPA that is the minimum overall GPA requirement for classes that are selected to satisfy this requirement. (For example, if a requisite states that the student needs to take four Math 100-level classes with an overall GPA of 3.00 for a total of 12 units, then enter 3.00 in this field.) Any existing value in the Minimum GPA field on the Parameters page is supplied by default to the Line Item Parm page when you add a requirement line.
Minimum Units	Enter a value that represents the minimum total units for the courses that are selected to satisfy this requirement. If this line item references a course list, then the number of units represents the total number of units that all courses found on the student's record (that match the course list) must be worth.
Minimum Courses	Enter value that represents the minimum number of courses that are required for this requirement. If this line item references a course list, then the number of courses represents the total number of courses that all courses found on the student's record (that match the course list) must be worth.
Maximum Units Allowed	Enter a value that represents the maximum number of units that can be evaluated for this requirement. This is not a way to verify whether a student has exceeded a unit limit. This is a way to limit what is evaluated.

Field or Control	Description
Maximum Courses Allowed	Enter a value that represents the maximum number of units that can be evaluated for this requirement. This is not a way to verify whether a student has exceeded a course count limit. This is a way to limit what is evaluated.
Min Grade Points/Unit (minimum grade points per unit)	Enter the minimum grade points per unit that each course must have to satisfy the enrollment requirement. For example, if you set this to 2.0, then each course that is evaluated must be a grade C or greater. If a course is evaluated that does not meet this minimum, the requisite is not satisfied.

Related Links

“Specifying Requirement Line Item Parameters” (Academic Advisement)

Defining Line Item Course Detail

Access the Line Item Detail page (**Curriculum Management > Enrollment Requirements > Enrollment Requirements > Line Item Detail**).

This example illustrates the fields and controls on the Line Item Detail page (when the line type is Course Requirement). You can find definitions for the fields and controls later on this page.

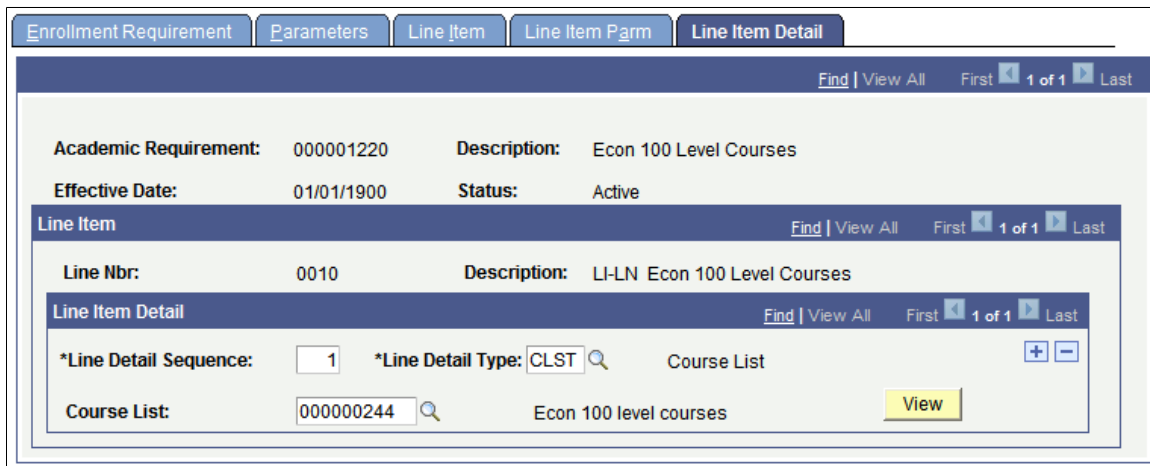

Field or Control	Description
Line Detail Sequence	The system assigns a sequential number to a specific line detail. You can have multiple detail line sequences under a single line number. The line detail sequence affects the order in which the system evaluates each line item detail. Those with the lowest number are evaluated first.

Field or Control	Description
Line Detail Type	Select the line detail type value that indicates the type of line detail. Values are: <i>CLST</i> : Indicates a static course list that can be used to satisfy the requirement. <i>DLST</i> : Indicates a dynamic, user-defined course list that the system draws from a subset of a student's transcript or academic record.
Course List	Appears with a line detail type of <i>CLST</i> . Enter the course list number that indicates a grouping of classes that the system can evaluate.
Derived Course List	Appears with a line detail type of <i>DLST</i> . Enter the derived course list that indicates a type of class that the system can draw from a subset of the student's transcript or academic record.
List Include Mode	Appears if you have multiple line item detail rows. Indicates how a previous line detail sequence interacts with a new line detail sequence. (This field is available for every line except the first one.) Choices include: <i>Y</i> , indicating union; <i>I</i> , indicating intersection; and <i>N</i> , indicating subtraction.
List Recall Mode	Appears with a line detail type of <i>DLST</i> . Indicates the conditions that the system uses to select courses from the student's transcript.
View	Appears with a line detail type of <i>CLST</i> . Click the View button to access the course list summary where you can review the course list details.

Related Links

“Setting Up Requirement Line Item Detail” (Academic Advisement)

Defining Enrollment Course Lists

This section provides an overview of enrollment course lists and discusses how to:

- Create course list descriptions.
- Link courses to the course list.
- Define details of courses in the course list.

Understanding Enrollment Course Lists

Create enrollment course lists only when you are creating enrollment requirements that have a course list requirement. Enrollment course lists should be set up before enrollment requirements are established.

Enrollment course lists and enrollment derived course lists are available. Enrollment course lists are static predefined lists of courses. Enrollment derived course lists are dynamically generated course lists as identified in a particular student's transcript. You can attach both types of course lists to enrollment requirements and can specify how many courses from the list (static or dynamic) are needed to satisfy specific enrollment requirements. Course lists and derived course lists are also used in the Academic Advisement application as a precursor for academic requirements.

Here is a high-level overview of how to define an enrollment course list:

1. Create the enrollment course list description on the Course List Description page.
2. Specify courses for the enrollment course list on the Course List Detail page, including a range of wild card courses.
3. Enter the parameters of each course list on the Course List Parameters page.

Related Links

“Setting Up Academic Course Lists” (Academic Advisement)

Pages Used to Create Enrollment Course Lists

<i>Page Name</i>	<i>Definition Name</i>	<i>Navigation</i>	<i>Usage</i>
Course List Description	RQ_COURSE_LIST_ENR	Curriculum Management > Enrollment Requirements > Enrollment Course Lists > Course List Description	Describe the course list.
Course List Detail	RQ_CRSE_LIST_DET	Curriculum Management > Enrollment Requirements > Enrollment Course Lists > Course List Detail	Link the actual courses to the course list. A course is specified either by a unique course ID or by using the wild card indicator.
Course List Parameters	RQ_CRSE_LST_DPR2	Curriculum Management > Enrollment Requirements > Enrollment Course Lists > Course List Parameters	Define the details of units, GPA, and other information for each course in the course list.

Creating Course List Descriptions

Access the Course List Description page (**Curriculum Management > Enrollment Requirements > Enrollment Course Lists > Course List Description**).

This example illustrates the fields and controls on the Course List Description page. You can find definitions for the fields and controls later on this page.

The screenshot shows a web interface for 'Course List Description'. It has three tabs: 'Course List Description' (selected), 'Course List Detail', and 'Course List Parameters'. At the top right, there are navigation controls: 'Find | View All', 'First', '1 of 1', and 'Last'. The form contains the following fields and values:

- Course List:** 00000127
- *Effective Date:** 01/01/1900
- *Status:** Active
- *Description:** ART 140 and 142
- *Short Description:** ART Test
- Long Description:** Art 140 and 142
- *Academic Institution:** PSUNV (PeopleSoft University)
- Academic Career:** UGRD (Undergraduate)
- Academic Group:** LBART (College of Liberal Arts)
- Subject Area:** (empty)
- Catalog Nbr:** (empty)

Field or Control	Description
Course List	The system generates a unique course list number each time that you add a new course list. You should use the system-generated course list number rather than entering your own course list number.
Effective Date	Enter an effective date for this course list. The effective date must be equal to or less than the effective date of the enrollment requirement to which this course list is attached.
Status	Select a status for this course list. Select <i>Active</i> when adding a new course list. Select <i>Inactive</i> only if your institution no longer uses this course list. If you want to inactivate a course list, you also need to remove all references to the course list on active Requirement Line Item Detail pages. To identify which Requirement Line Item Detail pages reference a particular course list, run the Reverse Engineering report.
Academic Institution	The system supplies the academic institution by default. In Add mode, you can change this value.

<i>Field or Control</i>	<i>Description</i>
Academic Career, Academic Group, Subject Area, and Catalog Nbr (catalog number)	Academic career, academic group, subject, and catalog number are not used by the system in the analysis of the course list, but are helpful tools for when you are searching the database for the appropriate course list to attach to an enrollment requirement. You may want to use these fields to signify the course to which the course list will be attached, or to specify department "ownership" of the course list.

Linking Courses to the Course List

Access the Course List Detail page (**Curriculum Management > Enrollment Requirements > Enrollment Course Lists > Course List Detail**).

This example illustrates the fields and controls on the Course List Detail page. You can find definitions for the fields and controls later on this page.

<i>Field or Control</i>	<i>Description</i>
Fetch	When you access this component, the system loads only effective-dated rows, without any detail. This is to enhance performance for those course lists that have hundreds of course sequence rows. Click the Fetch button to retrieve and display the course sequence data, including the related detail parameters for the effective-dated row.

Field or Control	Description
Course Sequence	This number acts as a course specification, indicating either a specific course ID or a group of equivalent courses. Each course sequence number indicates a unique component of the course list and can be arbitrarily assigned except when you are using a line type of sequential restriction on the Requirement Line Item page. If the sequence is important, enter the correct course order here so that the student must take the courses in the specified order.
WildCard Indicator	Select this check box to indicate a wild card course, rather than a specific course ID.
Academic Group	Appears if you select the WildCard Indicator check box. Specify an academic group for the course offering. All courses with this academic group may be considered.
Subject	Appears if you select the WildCard Indicator check box. Specify an academic subject for the course offering. All courses with this subject may be considered.
Catalog Nbr (catalog number)	Appears if you select the WildCard Indicator check box. Enter the required portion of the catalog number that is up to ten characters (NNNNAAAAAA), where the first four characters are numeric (leading zeroes are blank padded) and the last six characters are an alphanumeric suffix. For example, a catalog number of 3## indicates that any 300-level course is acceptable, including 301A, because suffixes are ignored when a number wild card is specified unless a suffix value is exclusively indicated.
Course ID	If the WildCard Indicator check box is cleared, use this field to specify the exact course ID.
Include Equivalent Courses	Select for the system to include in its evaluation both the course ID that you specify and all courses that are set up as equivalent to the selected course ID for this requisite. If you select this check box, the following fields become unavailable: Term, Associated Class, and Topic ID. Clear this check box to further narrow your course parameters with the Term, Associated Class, and Topic ID fields. For example, you can specify not only the course ID, but also the term in which the specific course must be taken.
Term	Enter the term in which the student must take the course that you specify for the course to be used in this enrollment course list. Leave this field blank to return all values.

Field or Control	Description
Associated Class	<p>Enter the associated class number (of the course that you specify) that the student must take for the course to be used in this enrollment course list. For class associations, indicate a term to prompt off valid values. Leave this field blank to return all values.</p> <hr/> <p>Note: You cannot enter 9999, because this special associated class number can be associated with any other associated class number and is never an enrollment section.</p> <hr/> <p>See Defining Class Associations.</p>
Topic ID	<p>Enter the topic ID (of the course that you specify) that the student must take in order for the course to be used in this enrollment course list. This field prompts from the topics that are defined in the course catalog. Leave this field blank to return all values.</p>
Include Cross-Listed Courses	<p>This check box is available when the Wildcard Indicator check box is selected. Select the Include Cross-Listed Courses check box to have cross-listed courses evaluated for purposes of satisfying a requisite. By default, the check box is cleared and cross-listed courses are not evaluated or used to satisfy the requisite.</p>

Defining Details of Courses in the Course List

Access the Course List Parameters page (**Curriculum Management > Enrollment Requirements > Enrollment Course Lists > Course List Parameters**).

This example illustrates the fields and controls on the Course List Parameters page. You can find definitions for the fields and controls later on this page.

The screenshot shows the 'Course List Parameters' page. At the top, there are three tabs: 'Course List Description', 'Course List Detail', and 'Course List Parameters'. The 'Course List Parameters' tab is active. Below the tabs, there is a search bar with 'Find | View All' and a page indicator '1 of 1'. The main content area displays the following information:

- Course List:** 000000127
- Description:** ART 140 and 142
- Effective Date:** 01/01/1900
- Status:** Active

Below this is a section titled 'Course Information' with a search bar and a page indicator '1 of 2'. The fields in this section are:

- Course Information:** 2D Design
- Min Units/Course:** 2.00
- Min Grade Points/Unit:** 2.00
- Transfer Level Allowed:** Always Allow
- Requirement Designation:** SR1T
- Valid Begin:** (calendar icon)
- Valid End:** (calendar icon)

At the bottom of the 'Course Information' section, there are several checkboxes:

- Course must be GPA material
- Test Credit is Allowed
- Other Credit is Allowed
- Exclude In-Progress Credit

Field or Control	Description
Min Units/Course (minimum units per course)	Enter the minimum number of units that the course to which this line refers must be worth to be used in the course list or as a wild card course. For example, if you set this to 3, the system uses only courses for this line that are worth three units each or greater. If the system finds a course on the student's record that meets the course list, but it is only two units, the course cannot be used to satisfy this requirement.
Min Grade Points/Unit (minimum grade points per unit)	Enter the minimum grade points per unit that the corresponding course or wild card course must have to be used in the analysis. For example, if you set this to 2.0, then the course must be a grade C or greater to fulfill this requisite.
Transfer Level Allowed	<p>Enter a value that indicates what type of transfer credit (if any) is acceptable. Values are:</p> <p><i>Always Allow:</i> All applicable transfer credit can be used to satisfy the requisite.</p> <p><i>Never Allow:</i> Transfer credit can never satisfy the requisite.</p> <p><i>Two Year Institution Only:</i> Only transfer credit from two-year institutions can be used to satisfy the requirement.</p> <p><i>Four Year Institution Only:</i> Only transfer credit from four-year institutions can be used to satisfy the requirement.</p>
Requirement Designation	<p>Select the requirement designation that the course or wild card course must have. For example, if you specify a wild card course of <i>ARCH 4##</i> on the Course List Detail page, then specify a requirement designation of <i>DSGN</i> on the Course List Parameters page. Only ARCH 400 - level courses that have a designation of <i>DSGN</i> (with a grade of Satisfied) meet this requisite.</p> <p>Requirement designation values are defined on the Requirement Designation Table page.</p> <p>See Defining Requirement Designations.</p>
Valid Begin and Valid End	Enter dates to specify the range of dates when the course must be taken to satisfy the requisite. Leaving these fields blank means that the courses can be taken anytime. When the system compares the date range, it uses the start and end date of the term in which the course was taken. For transfer courses, the system uses the start and end date of the articulation term.
Course must be GPA material (course must be grade point average material)	Select to require that the course taken for this requisite be applied toward the student's career grade-point-average calculation. For instance, any courses that a student took for a pass or no pass grade basis could not be used to meet this requisite if this grade basis does not have the Include in GPA check box selected on the Grading Scheme table page.

Field or Control	Description
Test Credit is Allowed	Select to allow test credit courses to be evaluated.
Other Credit is Allowed	Select to allow other credit courses to be evaluated.
Exclude In-Progress Credit	If the course taken to satisfy this course list must be fully graded for the system to consider it valid, select this check box. If this check box is cleared, the system will include in analysis and "pass" all parameters any non-graded course, as well as any graded course that has the In-Progress flag turned on (such as Incomplete), and that match the course ID or wild card course on the Requisite Detail page. Leaving this check box cleared is the least restrictive, and allows for maximum user/student flexibility.

Viewing Enrollment Requisite Summary Information

This section lists the pages used to:

- Review summary rules for enrollment requirement groups.
- Review summary rules for enrollment requirements.
- Review summary rules for enrollment course lists.

Related Links

[Defining Enrollment Requirement Groups](#)

[Defining Enrollment Requirements](#)

[Defining Enrollment Course Lists](#)

Pages Used to View Enrollment Requisite Summary Information

Page Name	Definition Name	Navigation	Usage
Enrollment Requisite Summary	ADVIS_RQ_GRP_SUMM	Curriculum Management > Enrollment Requirements > Enrollment Requisite Summary > Enrollment Requisite Summary	View enrollment requirement group rules. This page is shared with the Academic Advisement application.
Requirement Group Description	RQS_SUMM_DESC	Click the requirement group description link on the Enrollment Requisite Summary page.	View a summary of requisite description information. This page is shared with the Academic Advisement application.

Page Name	Definition Name	Navigation	Usage
Enrollment Requirement Summary	ADVIS_RQ_SUMMARY	Curriculum Management > Enrollment Requirements > Enrollment Requirement Summary > Enrollment Requirement Summary	View enrollment requirement rules. This page is shared with the Academic Advisement application.
Requirement Description	RQ_SUMM_DESC	Click the requirement description link on the Enrollment Requirement Summary page.	View a summary of enrollment requirement rules. This page is shared with the Academic Advisement application.
Requirement Line Description	RQ_LN_SUMM_DESC	Click the requirement line description link on the Enrollment Requirement Summary page.	View a summary of enrollment requirement rules. This page is shared with the Academic Advisement application.
Course List Summary	RQ_COURSELIST_SUMM	Curriculum Management > Enrollment Requirements > Course List Summary > Course List Summary	View the courses within an enrollment course list. This page is shared with the Academic Advisement application.
Course Description	CLST_SUMM_DESC	Click the course description link on the Course List Summary page.	View the course ID and description for each requisite course. This page is shared with the Academic Advisement application.

Generating a Reverse Engineering Report

This section provides an overview of the Reverse Engineering Report and discusses how to generate the report.

Related Links

“Producing a Reverse Engineering Report” (Academic Advisement)

Understanding the Reverse Engineering Report

Use the Reverse Engineering Report page to search for a requirement, course, course list, or condition that the system is using. You can search to find out which requirement group contains a specific requirement; which course list contains a specific course; which requirement contains a specific course list; and which requirement group, requirement, or requirement line contains a specific condition.

The Reverse Engineering reports include enrollment and academic advisement requirement groups, requirements, and course lists.

To produce a Reverse Engineering report:

1. Enter the report type and any other general parameters on the Reverse Engineering Report page.
2. Click the **Run** button to process the report.

Page Used to Generate a Reverse Engineering Report

<i>Page Name</i>	<i>Definition Name</i>	<i>Navigation</i>	<i>Usage</i>
Reverse Engineering Report	RUNCTL_SRREVENG	<ul style="list-style-type: none"> • Academic Advisement > Advisement Reports > Reverse Engineering • Curriculum Management > Enrollment Requirements > Reverse Engineering Report 	Enter the parameters that are to capture the data that you want to review. Select a report type to enable the page to display the appropriate parameter fields.

Generating the Enrollment Requirement Group Report

This section provides an overview of the enrollment requirement group report and discusses how to generate the report.

Understanding the Requirement Group Report

The Requirement Group report lists the contents (or structure) of a specific enrollment requirement group or all enrollment requirement groups that meet the criteria established for the report. This report provides an easy way to verify the enrollment requirement groups for any institution, subject, or catalog number. For example, if you need a list of all the enrollment requirement groups defined for courses at PSUNV with a subject of BIOLOGY, you can run this report.

Here is a high-level overview of how to run the requirement group report:

1. Enter your processing parameters for the requirement group report.
2. Specify details about how much or little you want to print about each enrollment requirement group.
3. Click the **Run** button to process the report.

Page Used to Generate the Requirement Group Report

<i>Page Name</i>	<i>Definition Name</i>	<i>Navigation</i>	<i>Usage</i>
Requirement Group Report	RUNCTL_SRENRADV	Curriculum Management > Enrollment Requirements > Requirement Group Report > Requirement Group Report	Enter your processing parameters for the requirement group report.

Generating the Requirement Group Report

Access the Requirement Group Report page (**Curriculum Management > Enrollment Requirements > Requirement Group Report > Requirement Group Report**).

<i>Field or Control</i>	<i>Description</i>
As of Date	<p>The system automatically populates this field with the current date, but you can modify it.</p> <p>The report accurately reflects the requirements contained in the specified requirement group (or requirement groups that meet the search criteria) as of this date.</p>
Requirement Group	<p>Enter the requirement group for this report. Each enrollment requirement group consists of detail lines pointing to conditions, courses, or requirements as well as parameters that include unit and course requirements.</p> <hr/> <p>Note: If you enter a requirement group number, then the remaining search fields on the page become unavailable. If you do not enter a requirement group number, then the remaining search fields are available for entry and you can use them to identify a set of enrollment requirement groups.</p> <hr/>
Academic Institution, Academic Group, Subject, Catalog Nbr (catalog number)	Enter the institution, group, subject, or catalog number for which you want to report related enrollment requirement groups. Leave this field blank to return all values (wild card).
Honor Blank Values	Select to indicate that the blank fields on this page represent actual values. For example, if the check box is selected and the Academic Group field is left blank, then the report does not contain enrollment requirement groups with an academic group because no academic group has been specified. If the check box is not selected, the blank field acts as a wild card and every enrollment requirement group with an academic group in the specified academic institution is contained in the report.

Description Options

Use this group box to control how descriptions are presented in the summary report.

Values for these fields are delivered with your system as translate values. Do not modify these values. Any modifications to these values require a substantial programming effort.

Field or Control	Description
Print Group Level	<p>Select the type of requirement group description to be included in the report. Values are:</p> <ul style="list-style-type: none"> • <i>All</i>: Indicates that the standard, short, and long descriptions on the Requirement Group page, plus the catalog description print on the report. • <i>Catalog</i>: Indicates that the description on the Requirement Group page prints on the report. • <i>All Except Cat</i>: Indicates that the standard, short, and long descriptions on the Requirement Group page print on the report. • <i>Long</i>: Indicates that the long description on the Requirement Group page prints on the report. • <i>Standard</i>: Indicates that the description on the Requirement Group page prints on the report. This value appears by default.
Print Requirement Level, Print Line Level , Print Course Level	<p>Select the type of requirement level, requirement line, and course list description to be included in the report. Values are:</p> <ul style="list-style-type: none"> • <i>All</i>: Indicates that the standard, short, and long descriptions on the Requirement page, Requirement Line Item page, or Course List Description page print on the report. • <i>Long</i>: Indicates that the long description on the relevant page prints on the report. • <i>Standard</i>: Indicates that the description on the relevant page prints on the report. This value appears by default.

Detail Options

Use this group box to control how details are presented in the summary report.

Field or Control	Description
Print Group Level, Print Requirement Level , Print Line Level	Select to print the requirement group detail, requirement detail, or line detail on the report. If the check box is cleared, no group detail prints.
Course List Detail Level	<p>Select how the course list detail should appear in the report. Values are:</p> <ul style="list-style-type: none"> • <i>None</i>: Converts to List and Courses. • <i>List and Courses</i>: Indicates that the course list, plus specific courses print on the report. This value appears by default. • <i>List and Courses with Detail</i>: Indicates that the course list, plus specific courses with detail print on the report. • <i>List Only</i>: Indicates that only the course list prints on the report. • <i>List Only with Detail</i>: Indicates that the course list with detail prints on the report. <p>Values for this field are delivered with your system as translate values. Do not modify these values. Any modifications to these values require a substantial programming effort.</p>

Generating the Requirement Report

This section provides an overview of the enrollment requirement report and discusses how to generate the report.

Understanding the Requirement Report

The Requirement report lists the contents (or structure) of a specific enrollment requirement or all of the academic requirements that meet the criteria established for the report. This report is an easy way to verify the academic requirements that you have defined for enrollment requisites. For example, if you need a printout of all of the enrollment requirements that are defined at PSUNV with an academic group of LBART you can run this report.

While preparing to print this report, you can request that the requirements, lines, and courses be summarized in generalized terms or in specific detail. The parameters that you define for the requirement advisement report appear on the report.

Here is a high-level overview of how to run the requirement group report:

1. Select the academic requirement or enter other general parameters on the Requirement Report page.

2. Enter the description and detail options.
3. Click the Run button to generate the report.

Page Used to Generate the Requirement Report

<i>Page Name</i>	<i>Definition Name</i>	<i>Navigation</i>	<i>Usage</i>
Requirement Report	SSR_RUNCTL_RQR_ADV	Curriculum Management > Enrollment Requirements > Requirement Report > Requirement Report	Enter your processing parameters for the requirement report.

Generating the Requirement Report

Access the Requirement Report page (**Curriculum Management** > **Enrollment Requirements** > **Requirement Report** > **Requirement Report**).

<i>Field or Control</i>	<i>Description</i>
As of Date	The system automatically populates this field with the current date, but you can modify it. The report accurately reflects the requirement lines in the specified requirement (or requirements that meet the search criteria) as of this date.
Academic Requirement	Enter the requirement for this report. Each enrollment requirement consists of detail lines pointing to conditions as well as parameters that include unit and course requirements. Note: If you enter a requirement number, then the remaining search fields on the page become unavailable. If you do not enter a requirement number, then the remaining search fields are available for entry and you can use them to identify a set of enrollment requirements.

For information about other fields on this page, refer to the field descriptions for the Requirement Group Report page in the previous section.

Generating the Entity Group Table and Condition Table Reports

The Entity Group Table report and Condition Table report display all the information about the appropriate data defined in the tables for the particular institution and the as of date.

To generate an Entity Group Table or Condition Table report:

1. Select the as of date and institution on the Entity Group Table and Condition Table Reports page for which you want to report conditions.
2. Click the **Run** button.
3. Select either the Condition Table Report or the Entity Group Table Report process to specify the report type.
4. Click the **OK** button to process the report.

Page Used to Generate the Entity Group Table and Condition Table Reports

<i>Page Name</i>	<i>Definition Name</i>	<i>Navigation</i>	<i>Usage</i>
Entity Group Table and Condition Table Reports	SSR_RUNCTL_MIS_RPT	Curriculum Management > Enrollment Requirements > Miscellaneous Requisite Report > Entity Group Table and Condition Table Reports	<p>Process one or both enrollment requirement administrative reports: the Entity Group Table report and the Condition Table report.</p> <p>The Entity Group Table report lists all the entity groups for the institution based on the as of date that you enter.</p> <p>The Condition Table report lists all the dynamic conditions for the institution based on the as of date that you enter.</p>

Processing the Entity Group Table and Condition Table Reports

Access the Entity Group Table and Condition Table Reports page (**Curriculum Management > Enrollment Requirements > Miscellaneous Requisite Report > Entity Group Table and Condition Table Reports**).

<i>Field or Control</i>	<i>Description</i>
As of Date	The report accurately reflects the retrieved information as of this date. This field is automatically populated with the current date, but you can modify it. A value is required in this field.

Setting Up Program Enrollment

Understanding Program Enrollment

In order to gain the most value from the documentation about Program Enrollment, we recommend that you are familiar with the following features:

- Basic PeopleSoft tree structure, vocabulary and components.
- Campus Solutions academic structure.
- Campus Solutions course catalog.
- Basic academic structure security.

We also recommend that you access the Activity Management documentation. See:

[Setting Up an Activity Management Framework](#)

[Understanding Activity Management](#)

Program Enrollment describes an educational model where students must complete a strictly defined set of courses towards their academic objective in a specified sequence. Requirements must also be completed at certain points in the program and are often structured in a series of levels or stages, where one stage must be successfully completed before a student can progress and enroll in the next set of courses, examinations, or other academic activities. In core Campus Solutions, enrollment is largely a course driven process in which students select courses (with some controls and restrictions) that apply toward degree requirements. The Program Enrollment feature provides a flexible structure that can enable institutions to build frameworks that use various program requirements to organize curriculum and provide the structure to order and control enrollment.

At the center of the setup for Program Enrollment are two important components:

- **Academic Item Types:** Academic programs that follow the Program Enrollment model have various items like courses, milestones, study periods, and groups of courses, for example, that organize what students are required to enroll in and when they are required to enroll. Academic Item Types allow you to define the attributes and to establish the role and level of each of these types of items and build them into a program structure hierarchy.
- **Academic Item Registry (AIR):** The foundation of program enrollment setup is the Academic Item Registry (AIR). Use AIR to define the framework, content, and rules for a *program of study* – essentially a set of academic requirements that define what courses a student needs to take and the sequence in which they need to be taken and satisfactorily completed.

The features described in this documentation, principally Academic Item Types and the Academic Item Registry, allow you to create program offerings using hierarchical frameworks that support institutional policies and practice for recording and calculating results, tracking student progress through a program of study, and ultimately assessing whether a student is eligible for the relevant

degree or award upon completion. These hierarchies are organized using parent child relationships, in which the various levels can contribute to the next level. These hierarchies can be generated and viewed as a *tree* that represents the various levels of a program of study.

This is an example of the Program Structure page.

Expand / Collapse	Item Description	Item Type	Item ID	Format Node
[-]	Business Administration - Graduate	Program of Study	00000001780	100 - Graduate Business
[-]	- Business Administration - Graduate Year One	Year	00000001781	200 - Year One
[-]	- Busn Admin - Yr One Semester One	Semester	00000001784	220 - Term One Year One
[+]	- BUSADM 515: Ethics Mgmt	Course	00000001788	
[+]	- and BUSADM 520: Political Bus Envir	Course	00000001789	
[+]	- and BUSADM 510: Securities Law	Course	00000001791	
[+]	- and BUSADM 521B: Adv Organizational Behavior	Course	00000001792	
[+]	- and BUSADM 521A: Organizational Behavior	Course	00000001790	
[+]	- and Busn Admin - Yr One Semester Two	Semester	00000001785	240 - Term Two Year One
[+]	- BUSADM 525: Manag Writing	Course	00000001793	
[+]	- and BUSADM 561: Corp Strategy I	Course	00000001796	
[+]	- and BUSADM 565: Oral Comm for Bus	Course	00000001797	
[+]	- and BUSADM 528: Manag Writ Strat	Course	00000001794	
[+]	- and BUSADM 545: Acquisitions	Course	00000001795	
[+]	- and Business Administration - Graduate Year Two	Year	00000001782	300 - Year Two
[+]	- Busn Admin - Yr Two Semester One	Semester	00000001786	320 - Term One Year Two
[+]	- BUSADM 620: Corp Strategy II	Course	00000001798	
[+]	- and BUSADM 635: Expt Sys for Bus	Course	00000001799	
[+]	- and BUSADM 670: Adv Comp Anly	Course	00000001800	
[+]	- and BUSADM 625A: Business Communications	Course	00000001801	
[+]	- and BUSADM 625B: Intl Business Communications	Course	00000001802	
[+]	- and Busn Admin - Yr Two Semester Two	Semester	00000001787	340 - Term Two Year Two
[+]	- BUSADM 675: App Regr Anly	Course	00000001803	
[+]	- and BUSADM 676: App Multivariate	Course	00000001804	
[+]	- and BUSADM 682: Japanese Bus System	Course	00000001805	
[+]	- and (BUSADM 725A: Strategic Management Seminar	Course	00000001806	
[+]	- or Corporate Internship)	Student Milestone	00000001808	
[+]	- and BUSADM 713: Forecasting	Course	00000001807	
[+]	- and Communications Competency	Course Cluster	00000001783	
[+]	- BUSADM 525: Manag Writing	Course	00000001793	
[+]	- and BUSADM 625A: Business Communications	Course	00000001801	
[+]	- and BUSADM 625B: Intl Business Communications	Course	00000001802	

The example above shows a program constructed based on the Academic Item Registry. This particular component (Build Program by Format) shows the tree-like framework of the program and, in the grid section, shows how the parent and child data represent the program structure depicted in the tree.

The Academic Item Registry allows an administrative user to generate a full view of a program's structure in a Program Template. AIR setup represents an extensive way for an institution to categorize all of the objects that are used to define and constitute a full program offering. This structure is used to organize enrollment transactions.

This is an example of the Template page.

Expand / Collapse	Item Description	Enrollment Category	Item Type	Item ID
	Business Administration - Graduate		Program of Study	00000001780
[-]	- Business Administration - Graduate Year One		Year	00000001781
[+]	[-] [-] - Busn Admin - Yr One Semester One		Semester	00000001784
	[-] [-] [-] - BUSADM 515: Ethics Mgmt	Mandatory	Course	00000001788
	[-] [-] [-] - and BUSADM 520: Political Bus Envir	Mandatory	Course	00000001789
	[-] [-] [-] - and BUSADM 510: Securities Lw	Mandatory	Course	00000001791
	[-] [-] [-] - and BUSADM 521B: Adv Organizational Behavior	Electives	Course	00000001792
	[-] [-] [-] - and BUSADM 521A: Organizational Behavior	Mandatory	Course	00000001790
[+]	[-] [-] - and Busn Admin - Yr One Semester Two		Semester	00000001785
	[-] [-] [-] - BUSADM 525: Manag Writing	Mandatory	Course	00000001793
	[-] [-] [-] - and BUSADM 561: Corp Strategy I	Required Electives	Course	00000001796
	[-] [-] [-] - and BUSADM 565: Oral Comm for Bus	Required Electives	Course	00000001797
	[-] [-] [-] - and BUSADM 528: Manag Writ Strat	Electives	Course	00000001794
	[-] [-] [-] - and BUSADM 545: Acquisitions	Electives	Course	00000001795
[+]	[-] - and Business Administration - Graduate Year Two		Year	00000001782
[+]	[-] [-] - Busn Admin - Yr Two Semester One		Semester	00000001786
	[-] [-] [-] - BUSADM 620: Corp Strategy II	Electives	Course	00000001798
	[-] [-] [-] - and BUSADM 635: Expt Sys for Bus	Required Electives	Course	00000001799
	[-] [-] [-] - and BUSADM 670: Adv Comp Anly	Electives	Course	00000001800
	[-] [-] [-] - and BUSADM 625A: Business Communications	Required Electives	Course	00000001801
	[-] [-] [-] - and BUSADM 625B: Intl Business Communications	Required Electives	Course	00000001802
[+]	[-] [-] - and Busn Admin - Yr Two Semester Two		Semester	00000001787
	[-] [-] [-] - BUSADM 675: App Regr Anly	Electives	Course	00000001803
	[-] [-] [-] - and BUSADM 676: App Multivariate	Electives	Course	00000001804
	[-] [-] [-] - and BUSADM 682: Japanese Bus System	Electives	Course	00000001805
	[-] [-] [-] - and (BUSADM 725A: Strategic Management Seminar	Required Electives	Course	00000001806

Other features that comprise the fundamental support of Program Enrollment setup are:

- Program format
- Enrollment cohort
- Enrollment category
- Item attributes
- Course group

Understanding the Academic Item Registry

The Academic Item Registry (AIR) is used to define the framework, content, and rules for a ‘program of study’, such as a bachelor’s or master’s degree, or set of academic requirements that specify what courses a student needs to take and when they need to be taken, as well as the rules for calculating results and degree or qualification awards. The AIR allows you to organize academic requirements into a hierarchy that can be used to provide a program template for driving and controlling enrollment activity.

The AIR provides a flexible way for your institution to define all of the objects that constitute a program offering. These entries must be categorized and grouped in order to define program hierarchies. The categories are established by system and user defined Academic Item Types that allow you to define the types of attributes an item can have, and to establish the role and level of an item in a program hierarchy.

Academic item types can:

- Represent a level in a program of study hierarchy, the program itself, a year or stage, a list of courses, or a single course.
- Provide user defined values with configurable attributes.
- Allow you to create as many items/levels as you need to define your program offerings.
- Point to existing Campus Solutions *core* objects such as courses, components, and milestones.
- Be configured to represent a level in a structure where statistics (for example, credits, results) can accumulate.

Although you can define your own academic item types, some item types are delivered as system data. For further information,

See [Using Delivered Academic Item Types](#)

This documentation discusses the AIR (and supporting features) and its role as a tool to define and maintain the programs of study for an institution.

The AIR also provides the data or *academic items* that feed into the student data structure—the Academic Progress Tracker (APT).

See [Understanding the Academic Progress Tracker](#)

Setting Up Academic Item Types

This section discusses how to:

- Define academic item types.
- Define academic item type attributes.
- Use delivered academic item types.

Pages Used to Set Up Academic Item Types

<i>Page Name</i>	<i>Definition Name</i>	<i>Navigation</i>	<i>Usage</i>
Academic Item Type	SSR_ITEM_TYPE	Set Up SACR > Product Related > Student Records > Program Enrollment > Academic Item Type > Academic Item Type	Define academic item types.

<i>Page Name</i>	<i>Definition Name</i>	<i>Navigation</i>	<i>Usage</i>
Attributes	SSR_ITEM_TYPE_DEFN	Set Up SACR > Product Related > Student Records > Program Enrollment > Academic Item Type > Attributes	Define academic item type attributes.

Defining Academic Item Types

Access the Academic Item Type page (**Set Up SACR > Product Related > Student Records > Program Enrollment > Academic Item Type > Academic Item Type**).

This example illustrates the fields and controls on the Academic Item Type page. You can find definitions for the fields and controls later on this page.

Academic Item Type		Attributes				
Academic Item Type	Description	Short Description	*Item Order	Program Format Tree Node		
PRG	Program of Study	Program of Study	100	<input checked="" type="checkbox"/>	<input type="button" value="+"/>	<input type="button" value="-"/>
PHASE	Phase	Phase	200	<input checked="" type="checkbox"/>	<input type="button" value="+"/>	<input type="button" value="-"/>
STAGE	Stage of Program	Stage	300	<input checked="" type="checkbox"/>	<input type="button" value="+"/>	<input type="button" value="-"/>
ACCUMUSPECIAL	Specialisation generic	Specialisation gener	325	<input checked="" type="checkbox"/>	<input type="button" value="+"/>	<input type="button" value="-"/>
LEVEL	Level	Level	350	<input checked="" type="checkbox"/>	<input type="button" value="+"/>	<input type="button" value="-"/>
YEAR	Year	Year	350	<input checked="" type="checkbox"/>	<input type="button" value="+"/>	<input type="button" value="-"/>
SEMESTER	Semester	Semester	400	<input checked="" type="checkbox"/>	<input type="button" value="+"/>	<input type="button" value="-"/>
STUDYPERIOD	Study Period	Study Period	400	<input checked="" type="checkbox"/>	<input type="button" value="+"/>	<input type="button" value="-"/>
MAJOR	Major	Major	425	<input type="checkbox"/>	<input type="button" value="+"/>	<input type="button" value="-"/>
REQUIREMENT	Requirement	Requirement	450	<input type="checkbox"/>	<input type="button" value="+"/>	<input type="button" value="-"/>
SPECIALISATION	Specialisation	Specialisation	460	<input type="checkbox"/>	<input type="button" value="+"/>	<input type="button" value="-"/>
MINOR	Minor	Minor	460	<input type="checkbox"/>	<input type="button" value="+"/>	<input type="button" value="-"/>
DIFFERENTIATION	Differentiation	Differentiation	460	<input type="checkbox"/>	<input type="button" value="+"/>	<input type="button" value="-"/>
CLUSTER	Course Cluster	Course Cluster	500	<input type="checkbox"/>	<input type="button" value="+"/>	<input type="button" value="-"/>
COURSELIST	Course List	Course List	600	<input type="checkbox"/>	<input type="button" value="+"/>	<input type="button" value="-"/>
COURSEGROUP	Course Group	Course Group	600	<input type="checkbox"/>	<input type="button" value="+"/>	<input type="button" value="-"/>
UE	Teaching Unit	Teaching Unit	600	<input type="checkbox"/>	<input type="button" value="+"/>	<input type="button" value="-"/>
INTERNSHIP	Internship	Internship	700	<input type="checkbox"/>	<input type="button" value="+"/>	<input type="button" value="-"/>
COURSE	Course	Course	700	<input type="checkbox"/>	<input type="button" value="+"/>	<input type="button" value="-"/>
THESIS	Thesis	Thesis	700	<input type="checkbox"/>	<input type="button" value="+"/>	<input type="button" value="-"/>
COMPONENT	Component	Component	800	<input type="checkbox"/>	<input type="button" value="+"/>	<input type="button" value="-"/>
MILESTONE	Student Milestone	Student Milestone	900	<input type="checkbox"/>	<input type="button" value="+"/>	<input type="button" value="-"/>

Define academic item types (by installation) on the Academic Item Type page by inserting new rows in a grid. When you insert a new row, you are taken to the Attributes page to define the detail for the item type. The Academic Item Type page also provides a summary view of all academic items. You can also update Item Order and Program Format Tree Node values on this page. The default sort order for the grid is by Item Order so that you can quickly scan items to verify logical order.

Note: You cannot delete an academic item type row here if an academic item of this type has been created in the Academic Item Registry.

See [Setting Up Academic Item Registry Entries, Item Details, and Item Security](#)

Field or Control	Description
Description and Short Description	Click the Description or Short Description links to access the Attributes page and further define the item type.
Item Order	<p>Enter a number to define the hierarchy and sort order of the items in the user interface. The lowest number represents the highest node – for example, the number that you enter for YEAR is lower than the number you enter for COURSE.</p> <p>The potential children of an academic item type must have an item order greater than that of the item type itself. You define child item types for an academic item type in the Item Type Matrix component.</p> <p>See Identifying Child Item Types and Syncing Entities</p> <p>We advise you to increment child item orders by ranges of 50 or 100, ensuring that you have space between two levels so that you can insert additional items in your structure if needed in the future. If two academic items are at the same level in your program hierarchy, they can bear the same Item Order number.</p> <p>PRG item type is delivered with an item order of 100 but you can change the item order. The system ensures that the item order for PRG is always the lowest.</p> <p>For more information about delivered item types, see Using Delivered Academic Item Types</p>
Program Format Tree Node	<p>Select to identify an academic type as one that can be used to construct a Program Format definition. The Program Format Tree Node field also appears on the Attributes page. For more information about this field, see Setting Up Program Formats</p> <p>See Defining Academic Item Type Attributes</p>

See [Setting Up Academic Item Registry Entries, Item Details, and Item Security](#)

Defining Academic Item Type Attributes

Access the Attributes page (**Set Up SACR > Product Related > Student Records > Program Enrollment > Academic Item Type > Attributes**).

This example illustrates the fields and controls on the Attributes page. You can find definitions for the fields and controls later on this page.

Academic Item Type | **Attributes**

Find | View All | First | 23 of 24 | Last

Academic Item Type COMPONENT System Data

*Description Component

Short Description Component

*Item Order 800

Program Format Tree Node

Grading Item Type

Item Type Properties

Credits

Degree

Instructions

Item Parameters

Child Academic Items

Show Connectors

Add parent before children

Results

Child Grading Items

Requires Enrollment Category

Activity Management Mapping

Content Definition Coursework

Content Type Component

AIR Entity SCC_ENTITY_20120613165411

APT Entity SCC_ENTITY_20120525001442

Extension Record SSR_AIR_H_CMPNT

	Associated Field	Required
1	SSR_COMPONENT	<input checked="" type="checkbox"/>

Use the Attributes page to define the types of attributes that are available for an item in the AIR, and, through the Extension Record, what type of external (to AIR) objects can be referenced by the item (such as courses or milestones).

See [Defining Academic Item Type Attributes](#)

The setup options that you select on the Attributes page impact the Academic Item Registry component (AIR).

See [Setting Up Academic Item Registry Entries, Item Details, and Item Security](#)

Field or Control	Description
System Data	If an academic item type is delivered as system data, the System Data check box is selected and is not available for edit. See Using Delivered Academic Item Types
Item Order	Define the value for this field on the Academic Item Type page. You can update the value here.
Program Format Tree Node	This check box identifies an academic item type as one that is used to define a Program Format, which provides the framework for a program of study, based on level, such as year or stage, study period or semester.
Grading Item Type	If you select this check box, academic items of this type can be assigned as child grading items for another academic item type using the Grading Academic Items grid on the Item Details page in AIR. When selected, this check box makes the Grading Items check box in the Item Type Properties group box unavailable for editing—an academic item that is identified as a grading item cannot itself have grading items attached to it. A grading academic item type could represent a set of courses for which a result might need to be calculated outside of the regular, structured program requirements. For example, a Chemistry student might need to achieve an average score of 70 in all courses taken from the Chemistry department. A grading academic item type could also be used to determine if a student was eligible for some kind of degree or certificate award.

Item Type Properties

Field or Control	Description
Credits	If you select this check box, the Credits field is available for the academic item on the Academic Items Registry page. This allows you to assign a credit value to an academic item which is also reflected in student's APT instance (if the item is added to it). The field is disabled for COURSE items, because a course credit value is established and maintained in the course catalog.

Field or Control	Description
Degree	<p>If you select this check box, the Degree field is available for the academic item on the Academic Items Registry page, allowing you to assign the item a Degree value in AIR. You would typically select the check box only for an item type that represents an overall program of study leading to a degree or certificate, or for an item type that represents an element of a program (for example, a year or stage) for which a student might receive an award (or intermediate degree) during progress towards the overall degree/certification objective.</p> <hr/> <p>Note: Note: Currently this field is informational only.</p> <hr/>
Instructions	<p>Select this check box to enable the Instructions field on the Item Details page in the AIR component.</p>
Item Parameters	<p>Select this check box to enable the Academic Item Parameters grid on the Item Details page in the AIR component. This check box is disabled for the delivered COURSE item type.</p> <p>See Using Delivered Academic Item Types</p>
Child Academic Items	<p>If you select this check box, academic items of this type can have other academic items associated with them as children—the Child Academic Items grid becomes available in AIR on the Item Details page. For example, an item representing a Year or Stage would probably need to have child items such as courses.</p> <p>For COURSELIST item types, the Child Academic Items check box is selected and not available for edit.</p>
Show Connectors	<p>Select this check box to activate AND/OR connectors in the AIR Child Academic Items grid.</p>

Field or Control	Description
Add parent before children	<p>This property is used in the student self-service user interface. When the check box is selected, no child item of the item can be selected until the item itself is added to APT. For example, if a CONCENTRATION has four child courses, you must first add the CONCENTRATION item to APT before you can add the child course. This serves two main purposes: It provides another way of representing the parent/child dependency to self-service users and allows you to attach rules to a parent item that can enforce eligibility before course selection—for example, a student might need a particular number of credits in order to select a particular concentration.</p> <hr/> <p>Note: Select this check box only for an academic item type that is truly an optional selection, regardless of the child items and enrollment categories.</p> <hr/>
Results	<p>If you select this check box, results can be attached to academic items of this type in the Item Type Usage grid on the Result Type page.</p> <p>See Setting Up Result Types</p>
Child Grading Items	<p>If you select this check box, the Grading Academic Items grid is available in AIR on the Item Details page.</p>
Requires Enrollment Category	<p>If you select this check box, items of this type require an Enrollment Category code when they are inserted as child items of another item.</p> <p>See Defining Academic Item Details</p>

Activity Management Mapping

These mapping fields allow you to map an academic item type to one of the delivered Activity Management Content Types. This mapping is used when defining Result Types.

See [Setting Up Result Types](#)

See [Setting Up an Activity Management Framework](#)

Field or Control	Description
Content Definition	Currently only the Coursework content definition is available.

Field or Control	Description
Content Type	This field lists all Activity Management Content Types flagged as system data.

Entities

Field or Control	Description
AIR Entity and APT Entity	<p>A system generated ID for the entity that is created for this academic item ID.</p> <p>Program Enrollment uses the Entity Registry to access AIR and APT data.</p> <p>See “Setting Up Entity Registry” (Campus Community Fundamentals)</p>

Note: For information about the Sync Entities process and when you must run the process,

See [Identifying Child Item Types and Syncing Entities](#)

See [Using Item Attributes to Extend AIR Data Elements](#)

See [Using Item Attributes to Extend APT Instance Header Data Elements](#)

Note: Each time that you create a new academic item type or make changes to an existing academic item type, you must run various entity sync processes. The steps you must follow are documented in the “Identifying Child Item Types and Syncing Entities” section.

See [Identifying Child Item Types and Syncing Entities](#)

Using Academic Item Type Extensions

An academic item type can point to an existing Campus Solutions object. The AIR structure can use core functionality, such as courses and milestones and Program Enrollment features such as Course Groups.

An object that is created outside of the AIR, for example, a course, must still be *registered* within the structure. To do this, you create academic items that are linked to the external object through an extension record. The extension record contains the necessary keys to allow the external (to AIR) object to be referenced within the hierarchy. The addition of an extension record (and associated fields) to an academic item type opens up the indicated fields in the AIR, providing the link to the external object.

The **Extension Record** field prompts against PS record definitions with the pattern `%_AIR_H_%` (where % represents the record prefix and name/suffix). This is the recommended naming convention for any custom extension that you add.

The following extension records are delivered:

- SSR_AIR_HDR_PRG: Program Extension: Used by the delivered Academic Item Type PRG. Used to store Program (item type) specific fields.

This example illustrates a SSR_AIR_HDR_PRG extension record.

Extension Record SSR_AIR_HDR_PRG		
	Associated Field	Required
1	SSR_AVAIL_TO_USE	<input checked="" type="checkbox"/>
2	SSR_FORMAT_ID	<input checked="" type="checkbox"/>
3	SSR_LAST_ADM_DT	<input type="checkbox"/>
4	SSR_LAST_PRS_DT	<input type="checkbox"/>

- SSR_AIR_H_CRSE: Course Catalog extension: Used by the delivered Academic Item Type COURSE and references a Course defined in the Course Catalog. As delivered, you can create academic items that point to a course ID or a course offering or to a course ID/offering with a specific Course Topic ID.

Note: Course ID is always required (Required check box is selected and not available for edit).

This example illustrates a SSR_AIR_H_CRSE extension record.

Extension Record SSR_AIR_H_CRSE		
	Associated Field	Required
1	CRSE_ID	<input checked="" type="checkbox"/>
2	CRSE_OFFER_NBR	<input type="checkbox"/>
3	CRS_TOPIC_ID	<input type="checkbox"/>

- SSR_AIR_H_CMPNT: Course Component extension: Allows you to create academic items at a level below the course. Academic items representing Course Components can be built and graded in AIR and then be available for use in calculating the overall course and for evaluation outside of the course. For example a student might need a CHEM 101 LAB score of 65 in addition to an overall course result of 60, in order to pass a particular requirement.

This example illustrates a SSR_AIR_H_CMPNT extension record.

Extension Record SSR_AIR_H_CMPNT		
	Associated Field	Required
1	SSR_COMPONENT	<input checked="" type="checkbox"/>

- SSR_AIR_H_CGRP: Course Group extensions: Used by the delivered COURSEGROUP Academic Item Type, and allows you to create academic items that reference the Course Group feature which makes available loosely defined group of courses (using wild card indicators within a program hierarchy).

See [Setting Up Course Groups](#)

This example illustrates a SSR_AIR_H_CGRP extension record.

Extension Record SSR_AIR_H_CGRP		
	Associated Field	Required
1	SSR_CRS_GRP_ID	<input checked="" type="checkbox"/>

- SSR_AIR_H_MLSTN: Milestone extension: Used by the delivered MILESTONE Academic Item Type, and allows you to create academic items that point to existing Milestone records, making the Milestone itself available in a program hierarchy.

This example illustrates a SSR_AIR_H_MLSTN extension record.

Extension Record SSR_AIR_H_MLSTN		
	Associated Field	Required
1	MILESTONE	<input checked="" type="checkbox"/>

Using Delivered Academic Item Types

The following academic item types are delivered as system data. The item order value shown for each item can be modified if needed.

- PRG: Program of Study:
 - PRG is used for all academic items that represent an overall educational objective and that comprise all of the child items necessary to achieve the objective.

Note: You must define an academic item with an Academic Item Type of PRG for every Program of Study that you want to build in AIR.

This example illustrates an academic item type of PRG.

Academic Item Type

Attributes

Find | View All First 1 of 24 Last

System Data

Academic Item Type PRG

*Description

Short Description

*Item Order

Program Format Tree Node

Grading Item Type

Item Type Properties

Credits

Degree

Instructions

Item Parameters

Child Academic Items

Show Connectors

Add parent before children

Results

Child Grading Items

Requires Enrollment Category

AIR Entity SCC_ENTITY_20120613165705

APT Entity SCC_ENTITY_20120525001729

Extension Record SSR_AIR_HDR_PRG

	Associated Field	Required
1	SSR_AVAIL_TO_USE	<input checked="" type="checkbox"/>
2	SSR_FORMAT_ID	<input checked="" type="checkbox"/>
3	SSR_LAST_ADM_DT	<input type="checkbox"/>
4	SSR_LAST_PRS_DT	<input type="checkbox"/>

- PRG is the root item for all AIR based programs. All other academic item types must have an item order greater than the PRG item order value.
- Attribute Restrictions: All attributes are available except for Requires Enrollment Category.

- COURSE: Course
- COURSE points to a predefined Course Catalog offering (can be defined down to the Course Topic ID).

Note: All Courses that are used in an AIR program definition must be defined as academic items in AIR.

This example illustrates an academic item type of COURSE.

The screenshot shows the 'Academic Item Type' configuration window for 'COURSE'. The window has two tabs: 'Academic Item Type' and 'Attributes'. The 'Attributes' tab is active. At the top right, there are navigation controls: 'Find | View All', 'First', '22 of 24', and 'Last'. Below these are '+ -' buttons. The main configuration area includes:

- Academic Item Type:** COURSE
- *Description:** Course
- Short Description:** Course
- *Item Order:** 700
- Program Format Tree Node
- Grading Item Type
- System Data

Below this is the 'Item Type Properties' section with the following options:

- Credits
- Degree
- Instructions
- Item Parameters
- Child Academic Items
 - Show Connectors
 - Add parent before children
- Results
- Child Grading Items
- Requires Enrollment Category

Next is the 'Activity Management Mapping' section:

- Content Definition:** Coursework
- Content Type:** Course

Below that are the AIR and APT Entity fields:

- AIR Entity:** SCC_ENTITY_20120613165428
- APT Entity:** SCC_ENTITY_20120525001450

Finally, the 'Extension Record' section shows:

- Extension Record:** SSR_AIR_H_CRSE

	Associated Field	Required
1	CRSE_ID	<input checked="" type="checkbox"/>
2	CRSE_OFFER_NBR	<input type="checkbox"/>
3	CRS_TOPIC_ID	<input type="checkbox"/>

- The main purpose of the COURSE academic item is to serve as a pointer to an established Course ID, Course offering (CRSE_OFFER) or Course topic. Because a course has predefined unit/

credit value (at the CRSE_CATALOG level) the credits and so on for a COURSE item are always inherited directly from there—the item has no credit value itself.

- Attribute Restrictions:

Cannot have Credits or Item Parameters, because these define a credit value that could contradict the Course Catalog definition. The Credits check box and the Item Parameters check box are not available for selection.

Child Items are allowed, because AIR can be used to support a model where components could be graded, (themselves defined as academic items) rolling up to a parent course.

Cannot have Grading Items.

The Requires Enrollment Category check box is selected and cannot be edited.

- COMPONENT: Component

- COMPONENT is used to build Course components in AIR, such as Lectures and Labs. When a COMPONENT item type is built in AIR, the component field is visible and prompts against the XLATABLE for the field SSR_COMPONENT

This example illustrates an academic item type of COMPONENT.

Academic Item Type | Attributes

Find | View All | First 23 of 24 Last

Academic Item Type COMPONENT System Data

*Description Component

Short Description Component

*Item Order 800

Program Format Tree Node

Grading Item Type

Item Type Properties

Credits

Degree

Instructions

Item Parameters

Child Academic Items

Show Connectors

Add parent before children

Results

Child Grading Items

Requires Enrollment Category

Activity Management Mapping

Content Definition Coursework

Content Type Component

AIR Entity SCC_ENTITY_20120613165411

APT Entity SCC_ENTITY_20120525001442

Extension Record SSR_AIR_H_CMPNT

	Associated Field	Required
1	SSR_COMPONENT	<input checked="" type="checkbox"/>

- Use the Component item type if you want to represent course component structures in AIR program structure for possibly grading students at the component level in the Academic Progress Tracker (APT).
- Attribute Restriction: The Component item type is delivered with the check boxes for all attributes cleared, but you can select the check boxes.
- COURSEGROUP: Course Group

- COURSEGROUP is used to point to a Course Group ID that allows you to define a ‘wild card’ course listing.

This example illustrates an academic item type of COURSEGROUP.

The screenshot shows the 'Academic Item Type' configuration window for 'COURSEGROUP'. The 'Attributes' tab is active. The 'Academic Item Type' is set to 'COURSEGROUP' with a checked 'System Data' option. The '*Description' and 'Short Description' fields both contain 'Course Group'. The '*Item Order' is set to 600. Under the 'Item Type Properties' section, 'Grading Item Type' is checked, while 'Credits', 'Degree', 'Child Academic Items', 'Results', and 'Child Grading Items' are unchecked. 'Instructions' and 'Item Parameters' are checked. Under 'Child Academic Items', 'Show Connectors' and 'Add parent before children' are unchecked. 'Requires Enrollment Category' is checked. The 'AIR Entity' is 'SCC_ENTITY_20120613165454' and the 'APT Entity' is 'SCC_ENTITY_20120525001532'. The 'Extension Record' is 'SSR_AIR_H_CGRP'. At the bottom, a table lists associated fields:

	Associated Field	Required
1	SSR_CRS_GRP_ID	<input checked="" type="checkbox"/>

- The main purpose of the COURSEGROUP item type is to serve as a placeholder (or pointer) to a loosely defined list of courses defined using wildcard indicators. Some attributes are therefore restricted.

- Attribute Restrictions:

Cannot have Child Academic Items or Grading Items.

The Requires Enrollment Category check box is selected and cannot be edited.

- COURSELIST: Course List
 - COURSELIST is used to define a list of courses that can be attached to another academic item.

This example illustrates an academic item type of COURSELIST.

The screenshot displays the configuration page for the 'COURSELIST' academic item type. The 'Attributes' tab is active, showing the following details:

- Academic Item Type:** COURSELIST
- *Description:** Course List
- Short Description:** Course List
- *Item Order:** 600
- System Data:**
- Program Format Tree Node:**
- Grading Item Type:**

The 'Item Type Properties' section includes the following options:

- Credits
- Degree
- Instructions
- Item Parameters
- Child Academic Items
 - Show Connectors
 - Add parent before children
- Results
- Child Grading Items
- Requires Enrollment Category

Entity information at the bottom:

- AIR Entity: SCC_ENTITY_20120613165445
- APT Entity: SCC_ENTITY_20120525001514

- The COURSELIST academic item type is provided for defining academic items that represent lists of courses. While user defined items can be used for this same purpose, various system edits are triggered by using the delivered COURSELIST item.

See [Setting Up Academic Item Registry Entries, Item Details, and Item Security](#)

- Attribute Restrictions:

Only COURSE items can be assigned as child items.

Cannot have Grading Items.

The Child Academic Items check box is selected and cannot be edited.

The Requires Enrollment Category check box is selected and cannot be edited.

- MILESTONE: Student Milestone
- MILESTONE points to a predefined Milestone definition.

This example illustrates an academic item type of MILESTONE.

Academic Item Type

Attributes

[Find](#) | [View All](#) [First](#) ◀ 24 of 24 ▶ [Last](#)

+
-

Academic Item Type **MILESTONE** System Data

*Description

Short Description

*Item Order

Program Format Tree Node

Grading Item Type

Item Type Properties

Credits

Degree

Instructions

Item Parameters

Child Academic Items

Show Connectors

Add parent before children

Results

Child Grading Items

Requires Enrollment Category

AIR Entity SCC_ENTITY_20120613165353

APT Entity SCC_ENTITY_20120830020753

Extension Record SSR_AIR_H_MLSTN

	Associated Field	Required
1	MILESTONE	<input checked="" type="checkbox"/>

- The main purpose of the MILESTONE academic item is to serve as a pointer to an established Milestone table entry, where the rules for the completion of the milestone are defined.
- Attribute Restrictions: Cannot have Child Academic Items or Grading Items.

Identifying Child Item Types and Syncing Entities

This section discusses how to use the Item Type Matrix to identify child item types. It also discusses the processes that you must run each time that you create a new academic item type or make changes to an existing item type.

Page Used to Identify Child Items and Sync Entities

<i>Page Name</i>	<i>Definition Name</i>	<i>Navigation</i>	<i>Usage</i>
Item Type Matrix	SSR_CHILD_ITEM_TYP	Set Up SACR > Product Related > Student Records > Program Enrollment > Item Type Matrix	Identify child item types and sync entities.

Using the Item Type Matrix

Access the Item Type Matrix page ((**Set Up SACR > Product Related > Student Records > Program Enrollment > Item Type Matrix**)).

This example illustrates the fields and controls on the Item Type Matrix page (1 of 3). You can find definitions for the fields and controls later on this page.

Item Type Matrix

Expand All Collapse All *Sort items by Item Order

▶ PRG: Program of Study

▶ PHASE: Phase

▶ STAGE: Stage of Program

▶ ACCUMUSPECIALISATION: Specialisation generic

▶ LEVEL: Level

▶ YEAR: Year

This example illustrates the fields and controls on the Item Type Matrix page (2 of 3). You can find definitions for the fields and controls later on this page.

▼ **SEMESTER: Semester**

Academic Item Type SEMESTER

Description Semester System Data

Item Order 400 Program Format Tree Node

Valid Child Item Types				
Select	Academic Item Type	Description	Item Order	Program Node
<input type="checkbox"/>	MAJOR	Major	425	<input type="checkbox"/>
<input checked="" type="checkbox"/>	REQUIREMENT	Requirement	450	<input type="checkbox"/>
<input checked="" type="checkbox"/>	DIFFERENTIATION	Differentiation	460	<input type="checkbox"/>
<input checked="" type="checkbox"/>	MINOR	Minor	460	<input type="checkbox"/>
<input checked="" type="checkbox"/>	SPECIALISATION	Specialisation	460	<input type="checkbox"/>
<input checked="" type="checkbox"/>	CLUSTER	Course Cluster	500	<input type="checkbox"/>
<input checked="" type="checkbox"/>	UELIST	UE List	500	<input type="checkbox"/>
<input type="checkbox"/>	DSTEST3	Test Item	550	<input type="checkbox"/>
<input checked="" type="checkbox"/>	COURSEGROUP	Course Group	600	<input type="checkbox"/>
<input checked="" type="checkbox"/>	COURSELIST	Course List	600	<input type="checkbox"/>
<input type="checkbox"/>	DSTEST2	DS Test	600	<input type="checkbox"/>
<input checked="" type="checkbox"/>	UE	Teaching Unit	600	<input type="checkbox"/>
<input checked="" type="checkbox"/>	COURSE	Course	700	<input type="checkbox"/>
<input checked="" type="checkbox"/>	INTERNSHIP	Internship	700	<input type="checkbox"/>
<input checked="" type="checkbox"/>	THESIS	Thesis	700	<input type="checkbox"/>
<input checked="" type="checkbox"/>	COMPONENT	Component	800	<input type="checkbox"/>
<input checked="" type="checkbox"/>	MILESTONE	Student Milestone	900	<input type="checkbox"/>

[Select All](#)
 [Deselect All](#)

This example illustrates the fields and controls on the Item Type Matrix page (3 of 3). You can find definitions for the fields and controls later on this page.

▼ COURSEGROUP: Course Group

Academic Item Type COURSEGROUP

Description Course Group System Data

Item Order 600 Program Format Tree Node

This item is not set up to have child academic items.

Identifying Child Item Types

As explained earlier in the “Setting Up Academic Item Types” section, the Item Order value of an academic item (defined on the Academic Item Type page) indicates which items are potential child items for that academic item.

After you create your academic item types, use the Item Type Matrix component to determine which item types (those with a higher item order than the item itself) can be defined as child item types for each academic item.

When the Child Academic Items check box is cleared on the Attributes page for an academic item type, a message appears in the Item Type Matrix for that item type: *This item is not set up to have child academic items.*

The Valid Child Item Types grid is refreshed whenever the component is opened. For each item type, the system retrieves all other academic item types with an item order (SSR_ITEM_TYPE.SSR_ITEM_LVL) that is greater than its own item order.

Field or Control	Description
Select	<p>Select this check box to identify the item as a valid child for the academic item type.</p> <hr/> <p>Note: Only item types for which this check box is selected are listed as potential child items in any prompt for this item. This applies in:</p> <ul style="list-style-type: none"> Program Format definition. Academic Item Registry: adding child elements Academic Progress Tracker: adding child items and substituting items. <hr/> <p>See Setting Up Program Formats</p> <p>See Defining Academic Item Details</p> <p>See Managing APT Items</p>

Field or Control	Description
Sort items by	Sort by <i>Item Order</i> , <i>Item Type</i> , or <i>Item Description</i> . The default value is <i>Item Order</i> .

Syncing Entities

If you implemented Program Enrollment before April 2013, you must run the processes listed here after you apply those updates.

Each time that you create a new academic item type, make changes to an existing academic item type, or set or make changes to the child item matrix for an academic item type, you must run the following processes:

1. Item Type Matrix Sync Entities

Here on the Item Type Matrix page (SACR, Product Related, Student Records, Program Enrollment, Item Type Matrix):

- Click the Sync Entities button. This initiates the SSR_PE_SYNC process.
- Check the Process Monitor to ensure that the process completes successfully.

This process can be scheduled using the process scheduler

Note: If you make changes on the Item Matrix page, be sure to *save* those changes before you launch the Sync Entities Process.

2. Entity Property Sync

Go to the Entity Property Sync page (SACR, System Administration, Entity, Entity Property Sync) and:

- Click the Sync All Entities button.
- Check the Process Monitor to ensure that the process completes successfully.

3. Wipe Entity Cache

Remain on the Entity Property Sync page and:

- After the Sync All Entity Properties process has completed successfully, click the Wipe Entity Cache button.
- Check the Process Monitor to ensure that the process completes successfully.

See “Setting Up Entity Registry” (Campus Community Fundamentals)

Note: You must also run these processes when you add common attributes for the AIR (SSR_AIR_HDR, SSR_AIR_ELEM) and APT (SSR_APT_HDR) record contexts.

See [Using Item Attributes to Extend AIR Data Elements](#)

See [Using Item Attributes to Extend APT Instance Header Data Elements](#)

Setting Up Rules for Program Enrollment

This section discusses how to:

- Set up rule types.
- Associate rule types with execution events.

See Program Enrollment Activity Management (PEAM) Documentation in My Oracle Support (ID 1400723.1).

- Using the Rules Engine for Program Enrollment Student Self-Service: System/Example Data
- Using the Rules and Engine for Program Enrollment Calculation and Evaluation: System/Example Data

Note: The Rules Engine requires PeopleTools 8.53.

See “Understanding the Rules Engine” (Campus Community Fundamentals)

See “Setting Up the Rules Engine” (Campus Community Fundamentals)

Page Used to Set Up Rules for Program Enrollment

<i>Page Name</i>	<i>Definition Name</i>	<i>Navigation</i>	<i>Usage</i>
Program Enrollment - Rule Type Table	SSR_RULE_TYPE_TBL	Set Up SACR > Product Related > Student Records > Program Enrollment > Rule Type Table	Set up rule types.
Program Enrollment - Execution Event Rule Types	SSR_EXEC_EVENT	Set Up SACR > Product Related > Student Records > Program Enrollment > Execution Event Rule Types	Associate rule types with execution events.

Setting Up Rule Types for Program Enrollment

The Program Enrollment - Rule Type Table provides a link between Program Enrollment-related features and the Rules Engine (RE) in these ways:

- Provides a functional 'wrapper' around a RE Rule Group (the RE construct that determines what a rule can do, the inputs and outputs of a rule and so on) that makes sense in the context of the Academic Item Registry, and which therefore simplifies rule prompting, and provides context for the user.

- When attached to an execution event, a rule type enables the invocation of rules, based on a user action (in the User Interface) or some other system event (see “Associating Rule Types with Execution Events” later in this section).
- Because a rule type can categorize rules from a functional perspective, the combination of type and execution event can be used to enable different behaviors and controls in a User Interface.
- Controls rule prompting in the Academic Item Registry component such that available rules can be restricted by item type.

Access the Program Enrollment - Rule Type Table page (**Set Up SACR > Product Related > Student Records > Program Enrollment > Rule Type Table**).

This example illustrates the fields and controls on the Program Enrollment - Rule Type Table page. You can find definitions for the fields and controls later on this page.

Rule Type Table

Rule Type System Data

*Description

Long Description

Rule Group Name

Rule Category Name

*APT Usage

Associated Academic Item Types

All
 Selected

Academic Item Type
1 Course -

[Add row](#)

Field or Control	Description
Rule Type and Description	Enter a Rule Type code (20 character limit) and a Description (30 character limit).
System Data	If a rule type is delivered as system data, this check box is selected and is not available for edit.
Rule Group ID, Search, Rule Group Name, and Rule Category Name	A Rule Type must be associated with a single Rule Group. Click the Search button to launch a search using a standard Rules Engine search utility. When you select a Rule Group ID, the Rule Group Name and Rule Category Name are displayed.

Field or Control	Description
APT Usage	<p>Determines how rules of this type relate to an APT Instance. Select from:</p> <ul style="list-style-type: none"> • <i>Validation</i>: Rules of this type can be associated with an Execution Event and can be used to validate APT entries. A Validation rule type must be associated with at least one academic item type. • <i>Result Calculation</i>: Rules of this type can be associated with an academic item type on the Result Type component as the default calculation rule for that result type/academic item type combination. • <i>APT Status Evaluation</i>: Rules of this type can be associated with an academic item type on the Rule Type table. Academic Item types associated on the rule type table can be used in APT Status Evaluation rules in the APT Administrative Roster. <p>See Setting Up Result Types.</p>
Copy	<p>This button is available only when you add a new rule type. The copy feature provides a prompt against all rule types defined in the system, including those for which the System Data check box is selected (delivered rule types).</p>
Delete	<p>When a rule type is saved successfully, a Delete button is available. Delete is not available for rule types for which the System Data check box is selected.</p>

Associated Academic Item Types

This grid is available only when the APT Usage value is *Validation* or *Evaluation*.

Field or Control	Description
All	<p>Select this option to indicate that this rule type can be assigned to any academic item regardless of academic item type. Assign rule types to academic items on the Rules / Results page in the Academic Item Registry component.</p> <hr/> <p>Note: This option is not available for APT Status Evaluation</p> <hr/>
Selected	<p>When you select this option, the Academic Item Type field becomes available and you can select the academic item types to which the rule type can be assigned. The Rules / Results page is available in the AIR component only for academic items of the type selected here.</p>

Delivered Rule Types

The following Rule Type definitions are delivered as system data, specifically for use in Program Enrollment Self-Service. These rule types can be used on the My Education Plan and Schedule Builder components.

See “Using Program Enrollment Self-Service Features” (Campus Self Service)

SSR_ ACE - AIR Connector Engine:

This rule type is not tied to a Rules Engine Rule Group definition and does not invoke the Rules Engine, but rather serves as a hook to invoke the AIR Connector Engine API. This API validates a student’s course choices against the structure or ‘tree’ defined in the Academic Item Registry for a particular planning node.

The following example shows the program tree requirements for year one of a program. In this particular case, the Item Type *Stage* is a planning node for this program.

Expand / Collapse	Item Description	Enrollment Category	Item Type	Item ID
[-]	Year 1 - Foundation and Business Core		Stage	00000002139
[-]	[-] B.A. Bus Mgt - Semester 1		Study Period	00000002140
[]	[] [-] ECON 2: Macroeconomic Principles	Mandatory	Course	00000000388
[]	[] [-] and ECON 3: Microeconomic Principles	Mandatory	Course	00000000389
[]	[] [-] and POL SCI 1: Intro to US Govt and Politics	Mandatory	Course	00000000100
[]	[] [-] and Modern European Languages - Intro Level	Electives	Course Group	00000001697
[]	[] [-] or Survey of Modern Math I	Electives	Course	00000002151
[-]	[-] and B.A. Bus Mgt - Semester 2		Study Period	00000002141
[]	[] [-] ECON 198: Special Topics in Economics	Mandatory	Course	00000002152
[]	[] [-] and ECON 1004B: Economic Methods II	Mandatory	Course	00000000446
[]	[] [-] and Social Sciences for Business	Electives	Course Group	00000002210
[-]	[-] and Business Foundation - Economics Options	Electives	Requirement	00000002153
[-]	[-] [-] [-] Economics Year 1 Option List A	Required Electives	Course List	00000001743
[]	[] [-] [-] [-] (ECON 1011: Industrial Economics	Required Electives	Course	00000000397
[]	[] [-] [-] [-] and SOC 103: Social Problems)	Required Electives	Course	00000000019
[]	[] [-] [-] [-] or (ECON 1014: Economics of Social Problems	Required Electives	Course	00000000400
[]	[] [-] [-] [-] and SOC 180: World Pop Probs)	Required Electives	Course	00000000171
[-]	[-] [-] [-] [-] or Economics Year 1 Option List B	Required Electives	Course List	00000001744
[]	[] [-] [-] [-] [-] (ECON 1012: Intnl Political Economy	Required Electives	Course	00000000398
[]	[] [-] [-] [-] [-] and POL SCI 101: Introduction to Government)	Required Electives	Course	00000000095
[]	[] [-] [-] [-] [-] or (ECON 1013: Public Sector Economics	Required Electives	Course	00000000399
[]	[] [-] [-] [-] [-] and POL SCI 105: Intro to World Politics)	Required Electives	Course	00000000097

To satisfy the course requirements for Year 1, students must satisfy the course requirements for each Study Period within the year, Semester 1 and Semester 2 as follows:

- For Semester 1, students must have ECON 2 and ECON 3 and POL SCI 1 and select a course from the Modern Languages Course Group or select Survey of Modern Math.
- For Semester 2, students must have ECON 198 and ECON 1004B and select a course from the Social Sciences Course Group and satisfy the Business Foundation options requirement.
- For Business Foundation options, students must select one pair of courses from List A or List B.
- To satisfy List A or List B student must select a matching pair of courses.

The Air Connector Engine (ACE) process traverses this tree and verifies that each of these requirements – as defined by the AND/OR connectors in AIR – have been met. If all items are not satisfied, an error message is returned.

Currently, ACE can be invoked on the student My Education Plan and Scheduler Builder components. (see Execution Event Rule Types below).

SSR_PE_COURSE_REQ - Course Requisite:

This rule type is linked to the delivered Rules Engine Rule Group *Academic Progress Tracker Item (version 1.1)*. It is associated with delivered COURSE academic item type, but others, including user defined item types can be added. This rule type allows the user to deploy a subset of their rules such as those that check for course requisites.

SSR_PE_ITEM_PRECOND - Academic Item Precondition:

This rule type is also linked to the Rule Group *Academic Progress Tracker Item (version 1.1)*. It is associated with the delivered COURSELIST academic item type, but others, including user defined item types can be added. This rule type allows the user to deploy a subset of their rules such as whether a student has meet a condition that is satisfied based on data typically associated with the student, such as a particular Academic Plan or Sub-Plan code.

The following Rule Type definitions are also delivered as system data, and are used to calculate and evaluate results.

- SSR_PE_CALC_RESULTS:
- This rule type is linked to the *Rule Group Academic Progress Tracker Item (version 1.1)*. Rules of this type can be used to calculate student results for a specific academic item and result type.
- SSR_PE_EVAL_STATUS:

This rule type is linked to the *Rule Group Academic Progress Tracker Item (version 1.1)*. Rules of this type can be used to evaluate the APT Statuses for an academic item within the student's APT. Only academic item types associated against this rule type can be used in APT Status Evaluation rules in the APT Administrative Roster.

See Program Enrollment Activity Management (PEAM) Documentation in My Oracle Support (ID 1400723.1).

- Using the Rules Engine for Program Enrollment Student Self-Service: System/Example Data
- Using the Rules and Engine for Program Enrollment Calculation and Evaluation: System/Example Data

Related Links

[Assigning Rules and Result Types to Academic Items](#)

“Understanding the Rules Engine” (Campus Community Fundamentals)

“Setting Up the Rules Engine” (Campus Community Fundamentals)

Associating Rule Types with Execution Events

Execution Event rule types determine how and when the Rules Engine is invoked in Program Enrollment, by tying rule types to a specific action that a user might take in the delivered User Interface. The

PeopleCode event referenced in the Execution Event definition is a pointer to the code that invokes the Rules Engine when the action occurs, such as user a clicking a button in the User Interface. Each event in turn can invoke certain rule types, each of which can be set to active or inactive.

See the Using the Rules Engine for Program Enrollment Student Self-Service: System/Example Data document in My Oracle Support (ID 1400723.1).

Access the Program Enrollment - Execution Event Rule Types page (**Set Up SACR > Product Related > Student Records > Program Enrollment > Execution Event Rule Types**).

This example illustrates the fields and controls on the Program Enrollment - Execution Event Rule Types page. You can find definitions for the fields and controls later on this page.

Execution Event Rule Types

Execution Event **SSR_PE_VAL_PLANNER** **System Data**

*Status **Active**

*Description **MEP Validate Planner**

Event Description **Student Self-Service My Education Plan - Audit/Validate button: this event executes when a user clicks the Audit/Validate button. The validation process acts on the Planning node selected in the**

PeopleCode Event **FieldChange**

Menu Name **SSR_PROG_ENRL_SS** PE Self-Service

Component Name **SSS_PE_SS_PLNR** My Education Plan

Page Name **SSS_MEP** My Education Plan

Record (Table) Name **SSR_MEP_WRK**

Field Name **SSR_PB_VALIDATE** Validate / Audit

Run All Rules

	Rule Type	Description	Process Entire Rule	*Rule Execution Error Handling	*Status	System Data	
1	SSR_ACE	AIR Connector Engine	<input type="checkbox"/>	Obey	Active	<input checked="" type="checkbox"/>	-
2	SSR_PE_COURSE_REQ	Course Requisite	<input type="checkbox"/>	Obey	Active	<input checked="" type="checkbox"/>	-
3	SSR_PE_ITEM_PRECOND	Academic Item Precondition	<input type="checkbox"/>	Obey	Active	<input checked="" type="checkbox"/>	-

[Add row](#)

Field or Control	Description
System Data	This check box displays for Execution Event Rule Types definitions delivered by Campus Solutions Development. See further information below.
Status	Campus Solutions Development events are delivered as <i>Inactive</i> . Events must be <i>Active</i> for Rules Engine invocation to occur.
Copy	This button is available only when you add a new execution event. The copy feature provides a prompt against all execution events defined in the system, including those for which the System Data check box is selected. (see below).

Field or Control	Description
Delete	When an execution event is saved successfully, a Delete button is available (Delete is not available for execution events for which the System Data check box is selected).
PeopleCode Event	Select a value: <i>Field Change</i> , <i>Field Edit</i> , <i>Save Edit</i> , or <i>Save Pre-Change</i> . The event selected here documents where the trigger PeopleCode that invokes the Rules Engine is called from by the component processor. In most cases, and specifically for the delivered self-service execution events, the PeopleCode event is <i>Field Change</i> .
Menu Name , Component Name, Page Name and Field Name	These fields are used to document the actual page/field location where the execution event occurs.
Run All Rules	When this check box is deselected, rule execution stops when the first error is encountered. For example, if a student adds three courses to their planner in self-service and each of those courses has a Course Requisite rule attached to them, and the student fails the first requisite, an error is returned for the first requisite but the other two requisite rules are not checked. If the Run All Rules check box is selected, all three rules are executed.

Rule Types Grid

Use this grid to indicate which types of rules should be executed when the triggering event occurs.

Field or Control	Description
Rule Type	Prompts against the Program Enrollment - Rule Type table.
Process Entire Rule	This check box determines whether the entire rule (of this type) is executed when it is invoked for this event. For example, if a Course Requisite rule requires successful completion of Course A and Course B and the Process Entire Rule check box is selected, the Rules Engine checks to see if both conditions are satisfied and can return the results of both parts of the rule to the User Interface (for example, Course A was not satisfied but Course B was satisfied). Otherwise the Rules Engine executes the rule until the first error condition. Using the same requisite example, processing stops when the Course A component of the rule fails.

Field or Control	Description
Rule Execution Error Handling	<p>Determines whether a rule type is applicable to a certain event and – if it is applicable – whether the user or process can proceed with a task (or system process) if the called rule(s) return errors or failure. Select from:</p> <ul style="list-style-type: none"> • <i>Obey</i>: If error/failure is returned by the called rule, the user cannot proceed; record would not be processed in a batch process. • <i>Warn</i>: If error/failure is returned by the rule, the system returns a warning message, but the user/process can continue. • <i>N/A</i> (not applicable): Rules of this type are not invoked for this event.
Status	<p>Determines whether a rule type is active for a particular event. If the status is <i>Inactive</i>, rules of this type are not executed.</p>

Delivered Execution Event Type Definitions

The following Execution Event Rule Type definitions are delivered. These events are tied specifically to the My Education Plan and Scheduler Builder components to enable invocation of both Rules Engine based rules and the AIR Connector Engine.

See the Using the Rules Engine for Program Enrollment Student Self-Service: System/Example Data document in My Oracle Support (ID 1400723.1).

Note: The trigger code for these execution events has been added only for the PeopleCode events specified in the definition (FieldChange).

- SSR_PE_UPD_PLANNER - My Education Plan Update Planner

If active, this event executes when a user clicks the Update Planner button on the student self-service My Education Plan component. The Update Planner button saves any course selection if all validation (including Rules Engine validation) logic is satisfied. Only those rule types with a status of *Active* are executed. The following rule types are tied to this event:

- SSR_PE_COURSE_REQ - Course Requisite
- SSR_PE_ITEM_PRECOND - Academic Item Precondition

- SSR_PE_VAL_PLANNER - My Education Plan Validate Planner

If active, this event executes when a user clicks the Audit/Validate button on the student self-service My Education Plan component. The validation process acts on the Planning node selected in the component. All rules for the planning node and its child items are invoked if they are of a rule type that is valid for this event. Only rule types with an *Active* status are executed. The following rule types are tied to this event:

- SSR_ACE - AIR Connector Engine
- SSR_PE_COURSE_REQ - Course Requisite
- SSR_PE_ITEM_PRECOND - Academic Item Precondition
- SSR_PE_AUD_SCHD - Schedule Builder Audit

If active, this event executes when a user clicks the Audit button on the student self-service Schedule Builder component. The Audit button invokes validation logic (including Rules Engine Validation) and return messages to the user if error conditions are found. Only those rule types with a status of Active are executed. The following rule types are tied to this event:

- SSR_ACE - AIR Connector Engine
- SSR_PE_COURSE_REQ - Course Requisite
- SSR_PE_ENRL_SCHD - Schedule Builder-Enroll in Classes

If active, this event executes when a user clicks the Enroll in Classes button on the student self-service Schedule Builder component. The Enroll in Classes button saves class selections and invokes validation logic (including Rules Engine Validation) for the current (enrollment) term node and takes the user to the next step of the enrollment process. *The rule invocation applies to all APT items for the term node, meaning that any rules attached to non-course items can be invoked.*

- If no errors or warnings are returned, the user is transferred to a confirmation page where they can confirm their class selections before submitting.
- If errors or warnings are returned, the user is first transferred to a results page, where errors and warnings are listed by item.
- If at least one class selection is error free (that is, the associated APT course item or parent item passed validation) a continue button is available and the user can proceed to the confirmation step: *Class selections where the validation for the associated APT course item (or parent items) failed is not included on the confirmation page.*

Only those rule types with a status of Active are executed. The following rule types are tied to this event:

- SSR_ACE - AIR Connector Engine
- SSR_PE_COURSE_REQ - Course Requisite
- SSR_PE_ITEM_PRECOND - Academic Item Precondition
- SSR_PE_ENRL_SCHD_CAL - Schedule Builder Calendar view-Enroll in Classes

If active, this event executes when a user clicks the Enroll in Classes button on the student self-service Schedule Builder Weekly Calendar view page. Although rule types for this event can be configured differently, the behavior associated with it mimics that for the Schedule Builder Enroll in Classes button (see above). Only those rule types with a status of Active are executed. The following rule types are tied to this event:

- SSR_ACE - AIR Connector Engine
- SSR_PE_COURSE_REQ - Course Requisite
- SSR_PE_ITEM_PRECOND - Academic Item Precondition

Related Links

- “Using Program Enrollment Self-Service Features” (Campus Self Service)
- “Understanding the Rules Engine” (Campus Community Fundamentals)
- “Setting Up the Rules Engine” (Campus Community Fundamentals)

Setting Up Program Formats

This section provides an overview of program formats and discusses how to define program formats.

Understanding Program Formats

Program Format determines the structure of a Program of Study. In AIR, program format applies specifically to an academic item that has a type of Program of Study (PRG).

The inherent flexibility of the AIR structure means that different institutions define their program hierarchies in different ways. You must therefore define frameworks to assign to the programs for your particular institution. The system then uses that framework to impose a template on a PRG academic item.

The Program Format:

- Identifies those levels (or nodes) of a program that equate to a year of program (or level, stage).
- Identifies the levels that equate to term (STRM) value for enrollment purposes.
- Provides the basis for a template for building a program of study.

See [Building Programs by Format](#)

Page Used to Set Up Program Formats

<i>Page Name</i>	<i>Definition Name</i>	<i>Navigation</i>	<i>Usage</i>
Program Format	SSR_PROG_FORMAT	Set Up SACR > Product Related > Student Records > Program Enrollment > Program Format > Program Format	Define program formats.

Defining Program Formats

Program Format definitions are created by Institution, with a user defined Format ID. The program format is created by assigning a tree node ID to the academic items that are used to build a program of study. Because this format represents the structure or framework of a program of study, it uses only those academic items that have been identified as Program Format Tree Nodes.

Note: If you built out Program Formats in your environment before January 2012, you must adjust your Program Format definitions after you apply the January 2012 updates. In order to use the APT Activation process, you must enter a Planning Node Item Type value here on the Program Format page. (See the description of the Planning Node Item Type field for further information.)

If you built out Program Formats in your environment before October 2012 using the *add session level property*, you must adjust your Program Format definitions after you apply the October 2012 updates.

Access the Program Format page (**Set Up SACR > Product Related > Student Records > Program Enrollment > Program Format > Program Format**).

This example illustrates the fields and controls on the Program Format page. You can find definitions for the fields and controls later on this page.

Program Format

Institution PeopleSoft University UK

Format ID UK-3YR-SEM-PRG

***Description**

Item Type Usage

Planning Node	YEAR	Year
Year of Program	YEAR	Year
Equates to Term	YEAR	Year

Add Session Level

Session Semester

Date Controls

Student Planning Term/Session Table

Tree View

- 10 - Programme of Study
 - 20 - Year 1
 - 25 - Semester 1
 - 30 - Semester 2
 - 35 - Year 2
 - 40 - Semester 1
 - 45 - Semester 2
 - 50 - Year 3
 - 55 - Semester 1
 - 60 - Semester 2

Find | View All First 1 of 10 Last

***Node ID**

Academic Item Type PRG Program of Study

***Description**

The Planning Node Item Type, Year of Program Item Type, and Equates to Term Item Type fields all prompt against the Item Type Matrix (SSR_ITEM_CHILD) table for item types for which the Program Format Tree Node check box is selected in the Academic Item setup component.

See [Identifying Child Item Types and Syncing Entities](#)

See [Setting Up Academic Item Types](#)

Item Type Usage

Field or Control	Description
Planning Node	<p>Enter a value to indicate which node of the Program Format definition should be used for APT Activation purposes. If, for example, the Planning Node Item Type is Phase, this indicates that a student is allowed to plan and enroll by Phase—the Activate icon is available at the Phase level in APT as the student progresses through a program. If a Planning Node Item Type is not entered, the entire program is available for planning and enrollment.</p> <p>See Managing APT Items</p>
Year of Program	<p>Enter a value to identify this item type as the one that is used to map to Year Of Program in the Program Format tree, where the program is constructed of a number of units which are completed in a number of years. You cannot select PRG item type for this field.</p>
Equates to Term	<p>Enter a value to indicate that the node is used to map to a Campus Solutions Term (STRM) value for enrollment purposes. This flag is used for Enrollment Cohort purposes. You cannot select PRG item type for this field.</p> <p>See Setting Up Enrollment Cohorts</p> <p>See Managing APT Items</p>
Add Session Level	<p>If you select this check box, you are prompted to enter a session academic item. Enrollment cohorts attached to this program format can be mapped to term and session combinations, using the Session field on the Program Enrollment Cohort page.</p> <hr/> <p>Note: If you use session level, the Equates to Term Item Type must be mapped to a term and session combination.</p> <hr/> <p>See Setting Up Enrollment Cohorts</p> <p>See Managing APT Items</p>
Session	<p>Enter a value for an academic item type that represents a Campus Solutions Session in your program format. This might be used if you have configured your Campus Solutions Term values to represent an academic year within which Campus Solutions Sessions represent your actual terms, semesters or some other component of an academic year.</p>

Date Controls

The Date Controls setup is used in student self service.

Field or Control	Description
Student Planning	<p>When you add a new program format definition, you must specify whether Student Planning is controlled by the <i>Academic Period Table</i> or the <i>Term/Session Table</i>.</p> <hr/> <p>Note: When the item type values in the Planning Node and Equates to Term fields are the same, the system sets the Student Planning period value to <i>Term/Session Table</i> and grays the field. When these values are not the same, users can select <i>Academic Period Table</i> or <i>Term/Session Table</i>, but this value cannot be changed after the component is saved.</p> <hr/> <ul style="list-style-type: none"> • <i>Academic Period Table:</i> Student planning is subject to the start and end dates of an Academic Period for which the Period Type is <i>Planning Period</i>. When you select this option, the Planning Period field is available on the Enrollment Cohort page for those cohorts based on this on this program format. See Defining Academic Periods See Setting Up Enrollment Cohorts • <i>Term/Session Table:</i> Student planning is subject to the dates in the Display in Self-Service group box on the Term Table page. If the program format includes session level, planning is subject to the dates in the Program Enrollment Controls group box on the Session Table page. See “Defining Terms, Sessions, and Session Time Periods” (Campus Solutions Application Fundamentals)

Tree View

The tree view provides a tree representation of the node structure that you enter at the Node ID scroll level—see the example page above. Each node in the tree links to the node definition that it represents.

Field or Control	Description
Node ID	Enter a node ID. The lowest Node ID value must have an Academic Item Type value of PRG. Node IDs for successive (child) nodes must increment. For example, a Program Format with three nodes, such as Program, Stage and Study Period could use 10 for Program, and then numbers starting at 1000 for the Stage nodes - for example 1000, 2000 and 3000. The child Study Period nodes could then number within each range (for example 1100, 1200 for Study Periods within the first stage).
Parent Node ID	Enter a parent node ID. The value that you enter here must already exist as a node ID. For example, if you previously added a Node ID of 100 for Academic Item Type PRG, then if you enter a Node ID of 200 for Academic Item Type STAGE, you can assign it a Parent Node ID of 100 to indicate that 200 (STAGE) is a child node of 100 (PRG).
Academic Item Type	<p>Select an academic item type. This field prompts against a view of the Item Type Matrix table (SSR_ITEM_CHILD) for items that are defined as Program Format Tree Nodes.</p> <p>See Identifying Child Item Types and Syncing Entities</p> <p>See Setting Up Academic Item Types</p> <p>Node IDs that have the same parent node ID must share the same academic item type: the value appears by default in the field and is not available for edit when this is true. For example, if you add Node ID 200 for Academic Item Type STAGE with a Parent Node ID 100 (PRG), then, when you add Node ID 300 with a Parent Node ID of 100, the Academic Item Type of STAGE is automatically assigned to Node ID 300.</p>

Setting Up AIR Administrator Security

It is useful to read this section in the context of these other sections in the document:

- [Setting Up Program Formats](#) (earlier in document).
- [Setting Up Academic Item Registry Entries, Item Details, and Item Security](#) (later in document).
- [Building Programs by Format](#) (later in document).

A Program Format definition provides a framework for building academic requirements in the Academic Item Registry. Program Format provides a template for building programs in a prescribed way, using the

Build Program by Format component. This component is the main tool for defining programs of study using academic items that are defined in the Academic Item Registry.

The majority of users will use the Academic Item Registry component primarily to build the content that is compiled into a program of study using the Build Program by Format component. For this reason, the use of Program Format node academic items is restricted in the Academic Item Registry component, so that most users can assign only non-Program Format Tree node items as children of other items. This prevents deviation from authorized program structures.

Exceptions to program formats can be made only by users who are authorized as Academic Item Registry Administrators.

Warning! We recommend that any exceptions be given careful consideration and testing as an exception to an established hierarchy may not be supported in the various processes and user interfaces that use the program format definition for validation and formatting purposes.

Page Used to Set Up AIR Administrator Security

Page Name	Definition Name	Navigation	Usage
Academic Item Registry Admin	SSR_AIR_OPR_SCRTY	Set Up SACR > Secure Student Administration > User ID > Academic Item Registry Admin	Set up AIR administrator security.

Setting Up AIR Administrator Security

Access the Academic Item Registry Admin page (**Set Up SACR > Secure Student Administration > User ID > Academic Item Registry Admin**).

This example illustrates the fields and controls on the Academic Item Registry Admin page. You can find definitions for the fields and controls later on this page.

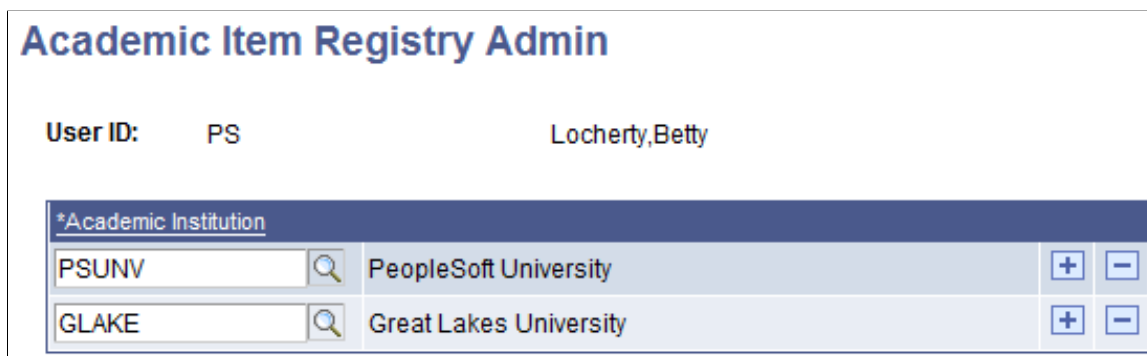

AIR Administrator security is based on User ID.

<i>Field or Control</i>	<i>Description</i>
Academic Institution	Select the institution to grant administrator privileges for this user ID.

AIR Administrator privileges apply to the Academic Item Registry component only. When User ID: PS adds child items to an Academic Item in the Academic Item Registry component the prompt shows all authorized child items, including those items identified as Program Format tree nodes.

See [Setting Up Program Formats](#)

See [Setting Up Academic Item Registry Entries, Item Details, and Item Security](#)

See [Building Programs by Format](#)

Setting Up Enrollment Cohorts

This section provides an overview of enrollment cohorts and discusses how to define program enrollment cohorts.

Understanding Enrollment Cohorts

The AIR feature allows you to define programs without regard to term, using stages or years for example. For enrollment purposes, the requirements that a student must take for a phase, year, or stage (or whatever type of item designation might be used) must be mapped to a Campus Solutions term (STRM). The Enrollment Cohort feature provides this link, attaching a student to a list of terms (beginning at the student's admit term) that follows the outline of the student's program of study. The Enrollment Cohort uses the Program Format definition to produce a term-based enrollment map for a cohort of students (based on admit term) and is assigned to a student on matriculation.

Page Used to Set Up Enrollment Cohorts

<i>Page Name</i>	<i>Definition Name</i>	<i>Navigation</i>	<i>Usage</i>
Program Enrollment Cohort	SSR_PE_COHORT	Set Up SACR > Foundation Tables > Term Set Up > Enrollment Cohort > Program Enrollment Cohort	Define enrollment cohorts

Defining Enrollment Cohorts

Access the Enrollment Cohort page (**Set Up SACR > Foundation Tables > Term Set Up > Enrollment Cohort > Enrollment Cohort**).

This example illustrates the fields and controls on the Enrollment Cohort page. You can find definitions for the fields and controls later on this page.

The screenshot shows the 'Enrollment Cohort' page with the following details:

- Academic Institution:** PeopleSoft University
- Academic Career:** Undergraduate
- Format ID:** 1 YEAR NURSING 1 Year Nursing Certificate
- Category:** *Description: sasd. A table titled 'Term Categories to Include' shows one entry: 'Regular Term' with '+' and '-' buttons. A 'Refresh Term Prompts' button is below.
- Criteria:** *Academic Load: Full-Time. Cohort Tag: (empty). *Cohort Term: 0630 2009 Fall. A 'Generate' button is present.
- Schedule:** A table with columns: *Seq Nbr, *Node ID, Node Description, *Term, Term Description.

*Seq Nbr	*Node ID	Node Description	*Term	Term Description		
100	30	Semester 1 Nursing	0630	2009 Fall	+	-
200	40	Semester 2 Nursing	0631	2009 Year	+	-
300	50	Nursing Summer Session	0632	2009 Fall Qtr	+	-

Enrollment Cohort definitions are created by Institution, Career, which enables prompting for term values (because terms are created by Institution and Career) and Program Format ID.

Field or Control	Description
Term Category	The Term Category values that you select here determine which terms are available for use by the Generate function. See information about the Generate function later in this section.
Academic Load	Enrollment cohorts are assigned by academic load. You must enter at least one Acad Load value. The same enrollment cohort can be used for different academic loads. For example if a 3 year program is completed over six terms, and the requirements for a part-time version of that program can be easily distributed over more terms, for example, twelve, you could use the same enrollment cohort. However, if the enrollment pattern is markedly different depending on a student's approved academic load, it would be more practical to create distinct program formats and enrollment cohorts for each possible academic load configuration.

Field or Control	Description
Cohort Tag	<p>Use this field to assign different versions of the same Academic Load/Cohort Term to different students.</p> <p>This feature might be used when an institution uses a Term value to represent an academic year, and the terms or semesters that constitute the academic year are represented as sessions on the Session Table. A Cohort Tag could be assigned for each session to which students are admitted.</p> <p>The values available here are defined on the Academic Cohort Table page for the Institution/Career combination.</p> <p>See “Defining Academic Cohorts for Program Enrollment” (Campus Solutions Application Fundamentals)</p>
Cohort Term	<p>The value that you select here represents the first term of enrollment for this particular cohort. For example a cohort admitted for a 3 year program beginning Fall 2010 would have a Cohort Term equal to the term value Fall 2010, 0670.</p>
Generate	<p>The generate function provides a quick way of assigning term values to a particular program format framework. The process works as follows:</p> <ul style="list-style-type: none"> • Selects all Node IDs that are attached to a Program Format ID where the Equates to Term field on the Program Format page indicates that the node will be used to map to a Campus Solutions Term value for enrollment purposes. • Using the Cohort Term value, selects all Term (STRM) values from the TERM_TBL (using the Institution and Academic Career values). If Term Categories have been entered, the selection is narrowed to include only those terms that meet the criteria. • The number of terms selected depends on the number of Equates to Term nodes in the Program Format definition. • Inserts a row in the grid for each Equates to Term node, where the first node term value equals the Cohort Term value. • The term value for each subsequent row is the next highest term value from the previously selected list of TERM_TBL.STRM values. • When no terms match the term categories selected, you receive an error message and the Term grid is not populated. This message (Message Catalog entry 14731, 95) is delivered with a severity of <i>Error</i>. If the installation chooses to change this to <i>Warning</i> the message is displayed and the grid is populated with the Program Format Tree Nodes. <p>See Managing APT Items</p>

Field or Control	Description
Seq Nbr (sequence number)	Enter a user defined sequence number for ordering the term rows.
Node ID	Select a node ID to map to a term. The values available are based on the Node IDs that you set up on the Program Format page. A node can be mapped to one or more terms. Multiple nodes can be mapped to the same term.
Session	This field is available if the Add Session Level check box is selected and a Session academic item type has been entered on the Program Format page.
Planning Period	This field is available when the Program Format (on which the Enrollment Cohort is based) uses the Academic Period Table for Student Planning Date Controls. <u>See Setting Up Program Formats</u> The default value is <i>Always Open</i> . To display other values, the system uses the Institution/Career of the enrollment cohort and lists all academic periods with a type of Student Planning for which the academic period end date is greater than the system date.

Setting Up Enrollment Categories for Program Requirements

This section provides an overview of enrollment categories and discusses how to define enrollment categories.

Understanding Enrollment Categories

Enrollment Categories are user defined codes that determine how academic items (courses or other items) are represented and seeded in a student APT record. In student self-service, Enrollment Category also determines the actions that students can take in relation to an individual course, such as whether can they can add or remove it from their schedule builder or whether they can drop once enrolled.

Page Used to Set Up Enrollment Categories for Program Requirements

<i>Page Name</i>	<i>Definition Name</i>	<i>Navigation</i>	<i>Usage</i>
Enrollment Category	SSR_ENRL_CAT	Set Up SACR > Product Related > Student Records > Program Enrollment > Enrollment Category > Enrollment Category	Define enrollment categories.

Defining Enrollment Categories

Access the Enrollment Category page ((**Set Up SACR > Product Related > Student Records > Program Enrollment > Enrollment Category > Enrollment Category**)).

This example illustrates the fields and controls on the Enrollment Category page. You can find definitions for the fields and controls later on this page.

<i>Field or Control</i>	<i>Description</i>
Automatically move to APT	If you select this check box, academic items with this enrollment category are moved to a student’s APT instance during the APT seeding process. See Managing APT Items

<i>Field or Control</i>	<i>Description</i>
Auto-request Cart/Enrollment	If you select this check box, courses with this enrollment category are available for selection by the process which builds enrollment requests/schedule builder entries for groups of students.
Student Self Service Access	Select check boxes to allow students to perform various enrollment functions in Self Service.

See “Using Program Enrollment Self-Service Features” (Campus Self Service)

Setting Up Result Types

Due to the flexible nature of AIR based program requirements, you must define the level at which you track unit and credit totals for example, and also, the type of data that you want to track at those levels. The Result Types feature provides you with the means to build these student data profiles, to define the type of data to be tracked (for example, Total Enrolled Credits, Total Completed Credits) and the format of that data.

This section discusses how to define result types.

Note: The Result Type design is still being finalized and some components of this feature are planned for the future.

Page Used to Set Up Result Types

<i>Page Name</i>	<i>Definition Name</i>	<i>Navigation</i>	<i>Usage</i>
Result Type	SSR_RESULT_TYPE	Set Up SACR > Product Related > Student Records > Grading > Result Type.	Define result types.

Defining Result Types

Access the Result Type page (**Set Up SACR > Product Related > Student Records > Grading > Result Type**).

This example illustrates the fields and controls on the Result Type page. You can find definitions for the fields and controls later on this page.

Result Type
Result Type: STAGE_WGHT_AVG

Find | View All First 1 of 1 Last

*Effective Date: 01/01/1900
*Status: Active

*Description: Weighted Average for Stage of Program
*Short Description: W. Average - Stage System Data

*Result Value Field Type: Free-form Text

Associated Academic Institutions
*Institution: PeopleSoft University

Show in Student Self-service
 Print in Transcript

Item Type Usage

*Academic Item Type	Calculation Rule ID	Rule Name	Auto-create in AIR
Stage of Program	SCC_RULE_ID_20140401143152	Calculate Stage Weighted Average	<input type="checkbox"/>

Content Type Usage

*Content Definition	*Academic Content Type	Auto-create in AM
		<input type="checkbox"/>

Result Types are defined by Institution.

<i>Field or Control</i>	<i>Description</i>
System Data	For future use.

Field or Control	Description
Result Value Field Type	<p>Determines which fields are available for entry on the page, and, when the Result Type is applied to an APT attempt, which fields are available for entry in APT.</p> <p>See Using Item Attributes to Extend AIR Data Elements</p> <p>Values are:</p> <ul style="list-style-type: none"> • <i>Free-form Text</i>: A 50 character description field. This is the default value. • <i>List of Valid Values</i>: The Valid values for this Result Type grid becomes available. • <i>Numeric</i>: The Integer Positions and Decimal Positions fields become available. • <i>Result Scale</i>: Enables the Result Scale field in the Associated Academic Institutions grid. Use the Result Scale table (SSR_RES_MAP_TBL) to define the rules for a set of scores or results for use in Activity Management and for use with a Result Type in APT. The result scale can specify a valid range/format, and map scores/marks to a grade. <p>See Setting Up an Activity Management Framework</p> <ul style="list-style-type: none"> • <i>Table Validation</i>: The Record (Table) Name field becomes available. • <i>Translate Table Validation</i>: The Field Name field becomes available.
Valid values for this Result Type	<p>Available when the Result Value Field Type is <i>List of Values</i>.</p> <p><i>Result Value</i>: The values that you define here appear in the Result prompt in an APT attempt.</p> <p>See Managing APT Items</p>
Integer Positions	<p>Available when the Result Value Field Type is <i>Numeric</i>.</p> <p>Controls the number of digits before the decimal for Numeric attribute types.</p>
Decimal Positions	<p>Available when the Result Value Field Type is <i>Numeric</i>.</p> <p>Controls the number of decimal places available for Numeric attribute types.</p>

Field or Control	Description
Record (Table) Name	<p>Available when the Result Value Field Type is <i>Table Validation</i>.</p> <p>Prompts against a view listing all tables where there is:</p> <ul style="list-style-type: none"> • A single key or • Records with two keys where the second key is Effective Date (EFFDT) or • Records with two keys where the first key is either INSTITUTION or SETID or • Records with three keys where the first key is either INSTITUTION or SETID and the third is EFFDT.
Field Name	<p>Available when the Result Value Field Type is <i>Translate Table Validation</i>.</p> <p>Prompts against the PSXLATTABLE.</p>

Updated by Activity Management, Display in Self Service and Print in Transcript fields are planned for future use.

Associated Academic Institutions

Use the Associated Academic Institutions grid to enable a result type for one or more institutions and to assign a result scale if the Result Value Field Type is *Result Scale*. When an Institution and Result Scale combination is defined, the specified result scale is used to validate entries for this result type.

Field or Control	Description
Institution	Select an institution.
Result Scale	If the Result Value Field Type value is <i>Result Scale</i> , the Result Scale field is available and lists all active result scales for this institution.
Default	You must select a default result scale if more than one result scale is entered for the same institution. The default is used when a result (for this result type) is manually entered on the Academic Progress Tracker component.

Item Type Usage

Field or Control	Description
Academic Item Type	Select the academic item types to which this result type can be attached in AIR.
Calculation Rule ID	<p>Select a Calculation Rule ID to be used for the select item type. The prompt returns rules that meet the following criteria:</p> <ul style="list-style-type: none"> The rule must be associated with a rule type for which the APT Usage is <i>Result Calculation</i>. Note that rules are associated with a rule type based on their rule group. <p>See Setting Up Rules for Program Enrollment</p> <ul style="list-style-type: none"> The rule type must also be attached (again, via the rule group) with the delivered Rule Category <i>APT Functions</i>. <p>In My Oracle Support (ID 1400723.1), see:</p> <ul style="list-style-type: none"> Using the Rules Engine for Program Enrollment Student Self-Service: System/Example Data Using the Rules and Engine for Program Enrollment Calculation and Evaluation: System/Example Data
Auto-create in AIR	When you select this check box, an AIR Result Type row is created each time that a user adds a new academic item of this type in AIR.

Content Type Usage

Field or Control	Description
Content Definition	Currently <i>Coursework</i> is the only delivered Content Definition.
Academic Content Type	Select the academic content type to which this result type can be attached in Activity Management.
Auto-Create in AM	This check box is planned for future use.

See [Setting Up Academic Item Registry Entries, Item Details, and Item Security](#)

See [Setting Up an Activity Management Framework](#)

Setting Up Academic Item Registry Entries, Item Details, and Item Security

This section provides an overview of AIR entries and discusses how to:

- Access the AIR component: AIR Search.
- Define AIR entries.
- Use item attributes to extend AIR data elements.
- Use item attributes in AIR.
- Assign item attributes to child academic items.
- Define academic item details.
- Assign rules and result types to academic items.
- Maintain AIR rich text fields.
- Define academic item security.
- Manage Special Edits in AIR for COURSE, COURSEGROUP, and COURSELIST Academic Items.
- Use the Academic Item Registry Copy Function.

Understanding AIR Entries

Use the Academic Item Registry (AIR) component (SSR_PE_AIR) to define Academic Item Registry entries, item details, and security.

The Academic Item Registry allows you to define all the various parts of a program offering—courses, lists of courses, milestones, years, stages—and to connect those parts into an overall program template. The data defined in this template is then available to all types of users, from prospective students, applicants, and students, to advisors, faculty, and administrators. Hierarchies are built using parent/child relationships. Within the hierarchies, each item can have its own parameters (for example, total number of credits, minimum result) that define how any child items are used in determining an outcome/result for the item.

Note: To prevent deviation from authorized program structures, most users can assign only non-Program Format Tree node items as children of other items in AIR. Exceptions to program formats can be made only by users who are authorized as Academic Item Registry Administrators.

See [Setting Up AIR Administrator Security](#)

Effective Dates in AIR

The academic item elements (child academic items) of an academic item must have an effective date that is less than or equal to the item itself. For example, you set up 3 COURSE items with the following effective dates:

- Course 1: 01/01/1900
- Course 2: 01/01/2000
- Course 3: Today's date

A STUDYPERIOD item with an effective date of 01/01/1900 can use only Course 1 as a child item.

A STUDYPERIOD item with an effective date of today's date can use all three courses as child items.

Course Academic Items

You can create course academic items here in the AIR component. Alternatively, you can use the SSR_CRSE_AIR batch process in the Create Course Academic Item component to create academic items for multiple courses at the same time. You can then use the AIR component or the Course Academic Item (SSR_CRSECAT_AIR) component to add individual courses as needed.

See [Creating Academic Items for Courses](#)

Pages Used to Set Up Academic Item Registry Entries, Item Details, and Item Security

<i>Page Name</i>	<i>Definition Name</i>	<i>Navigation</i>	<i>Usage</i>
AIR Search	SSR_AIR_SRCH_MAIN	Curriculum Management > Academic Item Registry > Academic Item Registry (AIR) > Search	Access the Academic Item Registry.
Find References	SSR_AIR_SRCH_REFS	Curriculum Management > Academic Item Registry > Academic Item Registry (AIR) > Find References	Find out where a particular academic item ID is being used in the Academic Item Registry.
Academic Item Registry	SSR_AIR	Access this page from the AIR Search component.	Define AIR entries.
Item Details	SSR_AIR_DTL	Access this page from the AIR Search component.	Define academic item type details
Element Parameters	SSR_AIR_ENPARAM_SEC	Click the Element Parameters link on the Item Details page.	View and update parameters
Rules / Results	SSR_AIR_RULE	Access this page from the AIR Search component.	Assign rules and result types to academic items.

Page Name	Definition Name	Navigation	Usage
Rich Text Fields	SSR_AIR_DESCR	<p>Access this page from the AIR Search component or:</p> <p>Click the Report Description link on the Academic Item Registry page.</p> <p>Click the Instructions link on the Item Details page.</p> <p>Click the Rule Report Description link on the Rules / Results page.</p>	Maintain AIR Rich Text enabled fields.
Security	SSR_AIR_SCRTY	Access this page from the AIR Search component.	Define academic item security.

Accessing the Academic Item Registry Component - AIR Search

A custom search component is used to access the AIR component (Curriculum Management, Academic Item Registry, Academic Item Registry (AIR)). You can perform targeted searches to retrieve existing items and also use the Find References feature to see whether a particular academic item is referenced by another item. For delivered academic item types, item type specific fields are provided for additional search criteria. The following example shows fields available for item type COURSE.

Access the AIR Search page (**Curriculum Management > Academic Item Registry > Academic Item Registry (AIR) > Search**)).

This example illustrates the fields and controls on the Academic Item Registry Search page. You can find definitions for the fields and controls later on this page.

Add a New Value
Find an Existing Value
Find References

From To

*Academic Institution PeopleSoft University

Academic Item Type

Academic Item ID

Description

Internal Description

Academic Item Attribute













Academic Organization

<i>Field or Control</i>	<i>Description</i>
Saved Search	Prompts against saved searches for the user.
Delete	Deletes the saved search selected in the Saved Search field.
Academic Institution	Select the institution value for the search or to add a new academic item.
Academic Item Type	Select the academic item type for the search or to add a new academic item.
Academic Item ID	Select an academic item ID.
Description	Enter all or part of an academic item description. The system uses this value to search against the AIR description field.
Internal Description	Enter a searchable Internal Description .
Academic Item Attribute	Enter an academic attribute to search by. The system uses this value to search against academic item attributes attached to academic items.

Field or Control	Description
Academic Organization	Enter an academic organization. The system uses this value to search against the academic organization values attached to academic items.
Format ID and Available to Assign	This field and check box are available when the search Academic Item Type value is PRG (Program).
Subject and Catalog Nbr	These fields are available when the search Academic Item Type value is COURSE.
Course Group ID	This field is available when the search Academic Item Type value is COURSEGROUP.
Course ID Course Offering Nbr and Course Topic ID	These fields are available when the search Academic Item Type value is COURSE.
Course Component	This field is available when the search Academic Item Type is COMPONENT.
Milestone	This field is available when the search Academic Item Type is MILESTONE.
Search	Launches a search against the Academic Item Registry using the specified criteria.
Reset	Clears the search criteria.
Add New Item	Academic items are created by Institution and Academic Item Type. You must enter these values on the search page to add a new item.
Save Search As	Provide a name for the search criteria. The system saves these criteria to the database under the User ID of the user.

Search Results

The system returns a list of academic items matching the search criteria. The results grid can be used to retrieve a selected item in the Academic Item Registry component or to search for references for that item by other academic items.

Personalize Find View All   First 1-20 of 73 Last			
	Item ID	Description	Find References
1	00000000614	LAW 620: Econ Anly Law	
2	00000000567	ECON 110: International Economics	
3	00000000559	ECON 100: Macroeconomic Analysis	
4	00000000545	ECON 312: Intership Applied Economics	
5	00000000544	ECON 311: Independent Study	
6	00000000543	ECON 310: Directed Readings	
7	00000000542	ECON 230: Government and Economy	
8	00000000541	ECON 224: Health Economics	
9	00000000540	ECON 220: Labor Economics	
10	00000000539	ECON 217: Pol Economy of the Military	

<i>Field or Control</i>	<i>Description</i>
Item ID	Click this link to access the Academic Item Registry component.
Find References	Click this icon to access the Find References page of the search component.

Using the Find References Page

Use the Find References page to find out where a particular academic item ID is being used in the Academic Item Registry.

This example illustrates the fields and controls on the Academic Item Registry Find References page. You can find definitions for the fields and controls later on this page.

Search
Find References

*Academic Institution PeopleSoft University

Academic Item ID ECON 112: Intl Political Economy

	Parent Item ID	Parent Item Type	Reference Hierarchy
1	00000001757	STUDYPERIOD	{PRG - 00000001753}B.A. Economics > {PHASE - 00000001754} B.A. Economics Part I > {STAGE - 00000001755} BA Econ - Year 1 > {STUDYPERIOD - 00000001757} BA Econ - Year 1 - Semester 2
2	00000001804	STUDYPERIOD	{STUDYPERIOD - 00000001804}BA Econ - Year 1 - Semester 2

Field or Control	Description
Parent Item ID	Click this link to view the AIR item for which the selected item is an immediate child item.
Parent Item Type	The Academic Item Type value of the parent item.
Reference Hierarchy	Displays a representation of the AIR based <i>tree</i> in which the Parent Item ID exists. The system displays the data as follows: {Academic Item Type/Academic Item ID} Academic Item description.

Accessing an Existing Item in the Academic Item Registry

Existing academic items in the AIR component are always retrieved using search results. When an item is retrieved, your page security determines the mode in which you access the component. For example if you have Update/Display access only, you cannot access historical rows. Once you are in the Academic Item Registry component, you can:

- Click OK to save changes and return to the Search component.
- Click Cancel to return to the Search component without saving changes.
- Click Apply to save changes and continue working with the same academic item in the Academic Item Registry component.

Adding a New Item to the Academic Item Registry

As described in the previous documentation, you add a new item by entering an Institution and Academic Item Type value and clicking Add New Item on the Search page. Once you are in the AIR component, the OK, Cancel, and Apply controls are available.

Defining AIR Entries

AIR entries are created by Institution and Academic Item Type.

The Academic Item Type definition determines which fields are available in the component.

Academic Item Type prompts against the Academic Item Type Definition table (SSR_ITEM_TYPE) for the installation.

Access the Academic Item Registry page (access this page from the AIR Search component).

Here is an example of the Academic Item Registry page for Academic Item Type: Program of Study.

Academic Item Registry

Academic Item Registry | Item Details | Rules / Results | Rich Text Fields | Security

Academic Institution PeopleSoft University
Academic Item ID 00000001780
Academic Item Type Program of Study

Find First 1 of 1 Last

*Effective Date 08/01/2008 *Status Active

*Description Business Administration - Graduate

Internal Description

Report Description

Degree MS

Requires Approval

Available to Assign

Last Prospect Date

Last Admit Date

Format ID GB-2YR Graduate Business - 2 Year

Report Template Mapping Find | View All First 1 of 1 Last

*Report Name

*Template ID

Component Name

Process Name

Item Attributes Find First 1 of 1 Last

*Attribute

Show in Student Self-service

Here is an example of the Academic Item Registry page for Academic Item Type: Course.

Academic Item Registry

Academic Institution PeopleSoft University
 Academic Item ID 00000000003
 Academic Item Type Course

Find First 1 of 1 Last

*Effective Date 01/01/1900 *Status Active

*Course ID 001157 Art Survey

Course Offering Nbr 1 Subject / Catalog ART 101

Course Topic ID

*Description ART 101: Art Survey

Internal Description

[Report Description](#)

Requires Approval

Item Attributes Find First 1 of 1 Last

*Attribute

Show in Student Self-service

Go to [Add to New Activity Registry](#) [Add to Existing Activity Registry](#)

Some fields appear on this page only when a particular extension record is used. You associate extension records with academic item types on the Attributes page (Set Up SACR, Foundation Tables, Academic Structure, Academic Item Type, Attributes).

See [Defining Academic Item Type Attributes](#)

The Course ID, Course Offering Nbr, and Course Topic ID fields are available when the extension record SSR_AIR_H_CRSE is used (associated with the delivered item type of COURSE). Course Offering Nbr and Course Topic ID may or may not be required depending on the way that you have configured the extension record for the COURSE academic item type.

Field or Control	Description
Academic Item ID	A system generated identifier.

Field or Control	Description
Course ID	Click on the related link to access the Course Catalog component for the Course ID. Click OK or Cancel to return to this page.
Course Component	This field is available when the extension record SSR_AIR_H_CMPNT is used—you can define components within AIR that can be used as child items of courses.
Course Group ID	This field is available when the extension record SSR_AIR_H_CGRP is used (associated with the delivered item type of COURSEGROUP). Click on the related link to access the Course Group component for the Course Group ID.
Milestone	This field is available when the extension record SSR_AIR_H_MLSTN is used (associated with the delivered item type of MILESTONE). Click on the related link to access the Milestone Table component for the Milestone ID.
Internal Description	Enter a searchable description.
Report Description	Click this link to move to the Rich Text Fields page of this component where Rich Text Editor features are available for this for this description field. See Maintaining AIR Rich Text Fields
Degree	This field is available if the Degree check box is selected on the Attributes setup page for an academic item type. The Degree attribute is typically used for a Program of Study item that leads to a degree/certificate award. Note: Currently this field is informational only.
Credits	This field is available if the Credits check box is selected on the Attributes setup page for the academic item type. Enter a credit value.
Requires Approval	Note: This check box is planned for future use.
Available to Assign	This check box appears only for Program of Study academic item types. The check box is selected by default, indicating that the program of study can be assigned to students. Clear the check box if you want to build a program but not make it available to be assigned to students.
Last Prospect Date	This field is available only for Program of Study academic item types. Enter the last date that this PRG item can be used for a prospect. Note: Currently this field is informational only.

Field or Control	Description
Last Admit Date	This field is available only for Program of Study academic item types. Enter the last date that this PRG item can be used for an applicant. Note: Currently this field is informational only.
Format ID	This field is available and required only for Program of Study academic item types.
Add to New Activity Registry and Add to Existing Activity Registry	<p>When the Academic Item Type is Course, this page displays links to Activity Management.</p> <p>Click the Add to New Activity Registry link to access the Activity Registry component (SSR_AC_REGISTRY) in Add mode and create a new Activity Registry entry.</p> <p>Click the Add to Existing Activity Registry link to access the Maintain Course Content Cross Reference component and add the course to an existing Activity Registry entry.</p> <p>See Setting Up an Activity Management Framework</p> <p>See Understanding Activity Management</p>

Report Template Mapping

The Report Template Mapping fields appear on the page only for Program item types.

The flexible nature of the Academic Item Registry requires that users have a way to define reports that can interpret and illustrate their user defined program structures. This is particularly important in the area of student results and outcomes, where user defined result types can allow an institution to hold and report student results (grades, scores, credits and so on) and statistics at any point in a program tree. For this reason, we have delivered a self-service component that can be populated with HTML via a Peoplesoft BI Publisher Report Definition. This feature allows users to create a Results page referencing their user defined program structures and result/statistics profile. The AIR Report Template Mapping feature allows users to map a specific BI Report to specific program. The same report can also be shared by different programs with the same program format and result profile.

Currently the Report Template Mapping feature is used solely to attach a user defined BI report definition to the student self-service results component. The steps for associating a report to the self-service results component are:

- In BI Publisher:
 - Create a data source/upload a sample data file.
 - Design and define a report definition.
- In AIR: Associate the report with the self-service Results component using Report Template Mapping.

A sample report has been delivered with the April 2014 updates.

See the following document in My Oracle Support (ID 1400723.1): Using BI Publisher and the XMLP Results Template to Display Students' Results and Outcomes in Program Enrollment Self Service: Sample Template.

See *PeopleTools: BI Publisher for PeopleSoft*

Field or Control	Description
Report Name	Prompts against a view of active BI reports defined with a type of 'XML' (XML File) or 'XMD' (XML Doc Object).
Template ID	Prompts against valid templates for the selected Report Name.
Component Name	Currently prompts against a view that returns components enabled for the program enrollment student self-service XML menu (currently the delivered SSR_APT_DAT_RPT_CM component).
Process Name	Planned for the future.

Item Attributes

The Item Attributes area is available when a Common Attribute(s) has been associated with an academic item type entity. Associate item attributes and academic item types on the Common Attributes – Record Context page. See the following section “Using Item Attributes to Extend AIR Data Elements”.

Using Item Attributes to Extend AIR Data Elements

The Common Attribute Framework allows you to extend the delivered AIR functionality without customizations, by enabling you to add different types of data elements to your program structures. An item attribute can be associated with one or more academic item types, and after it is linked to an academic item type, that attribute can be assigned to all academic items of that type. You can link to the attribute at the academic item level itself, or when the attribute is added as a child academic item of another academic item.

Note: Any existing academic item attributes (created prior to Additional Features July 2012) must be recreated using the Common Attribute Framework.

The Common Attribute Framework allows you to associate attributes with a functional area by a *Record Context*. Common Attributes have been enabled for the Academic Item Registry at the Academic Item and Child Element levels, each with its own Common Attribute Record Context and Attribute Record.

Field or Control	Description
Academic Item	<ul style="list-style-type: none"> Record Context: SSR_AIR_HDR Attribute Record: SSR_AIR_ADD <p>Attributes associated with this Record Context/Attribute Record combination are attached to an academic item and can be assigned on the Academic Item Registry page of the AIR component.</p>
Child Element	<ul style="list-style-type: none"> Record Context: SSR_AIR_ELEM Attribute Record: SSR_AIR_ELEM_AD <p>Attributes associated with this Record Context/Attribute Record combination are attached to child academic items (that is, they exist as an attribute of an academic item in the context of a parent academic item) and can be assigned using the Element Attributes link on the Academic Item Elements grid in the AIR component.</p>

See “Understanding Common Attribute Framework” (Campus Community Fundamentals)

See “Defining a Common Attribute” (Campus Community Fundamentals)

See “Associating a Common Attribute to a Record” (Campus Community Fundamentals)

Steps for Creating Common Attributes for AIR

To create common attributes for AIR:

1. Define the attribute using the Common Attribute component (Set Up SACR, Common Definitions, Common Attributes Setup, Common Attribute).
2. Attach that attribute to the Academic Item (SSR_AIR_HDR) and/or Child Element (SSR_AIR_ELEM) Record Contexts (Set Up SACR, Common Definitions, Common Attributes Setup, Record Context).
3. Associate the attribute with one or more Academic Item Entities, using the Entities Association field in the Record Context component. Entity Association controls usage in the AIR component. An attribute without an entity association can be used with any item type.

Note: If you implemented Program Enrollment before April 2013, you must run the processes listed here after you apply the April 2013 updates.

4. Item Type Matrix Sync Entities

Navigate to the Item Type Matrix component (Set Up SACR, Product Related, Student Records, Program Enrollment, Item Type Matrix) and run the SSR_PE_SYNC process. The sync process ensures that the newly added attribute(s) are recognized as valid properties of the designated AIR Entities (or all AIR Entities if specific entities were not specified):

- Click the Sync Entities button. This initiates the SSR_PE_SYNC process.

- Check the Process Monitor to ensure that the process completes successfully.

This process can be scheduled using the process scheduler.

5. Entity Property Sync

Navigate to the Entity Property Sync page (SACR, System Administration, Entity, Entity Property Sync) and:

- Click the Sync All Entities button.
- Check the Process Monitor to ensure that the process completes successfully.

6. Wipe Entity Cache

Remain on the Entity Property Sync page and:

- After the Sync All Entity Properties process has completed successfully, click the Wipe Entity Cache button.
- Check the Process Monitor to ensure that the process completes successfully.

See [Identifying Child Item Types and Syncing Entities](#)

See “Defining a Common Attribute” (Campus Community Fundamentals)

See “Associating a Common Attribute to a Record” (Campus Community Fundamentals)

See “Setting Up Entity Registry” (Campus Community Fundamentals)

Defining Attributes for Academic Items and Child Elements

Note that because attributes each have their own specific Record Context, you must associate attributes that can be used at both levels under each context. For example if the Common Attribute ‘Course Level’ can be assigned to a COURSE academic item and then overridden at the child element level (that is, when the course is a child of another item) you must associate the Course Level attribute to the SSR_AID_HDR record context and the SSR_AIR_ELEM record context. Attributes can be copied from one Common Attribute Framework Record Context to another.

Using Item Attributes in AIR

As explained above:

- The selections that you make in the Entity Associations field in the Record Context component determine which types of academic items those attributes can be applied to in AIR.
- The Attribute Type determines the type of data that you can enter in the Item Attributes grid in AIR.
- An Attribute can be required when associated with a particular record context (the **Required** check box is selected on the Record Context page in Common Attributes setup). If an attribute associated with the SSR_AIR_HDR context is set to required, the attribute is added automatically when a user

creates a new academic item, and a value is required to save the component (if a default has not been assigned in the attribute definition).

Note: Users must provide a value even if they add a non-required attribute.

- Attributes can also be repeatable if this property is enabled in the Record Context definition (the **Repeatable** check box is selected on the Record Context page in Common Attributes setup).

See “Defining a Common Attribute” (Campus Community Fundamentals)

See “Associating a Common Attribute to a Record” (Campus Community Fundamentals)

However, despite these variations, you always use the same process to add attributes in AIR: select the Attribute and then enter or select a Value—for example, date, text, numeric value, or a code where the code is a member of the List of Values defined for the attribute, a Table value, or XLAT value.

An academic item:

- Can have multiple item attributes, at the academic item level itself or as a child item of another academic item (see Child Academic Items below).
- Can have multiple rows for the same item attribute as long as the attribute Value is different (for example Attribute A, with Value 1, Attribute A with Value 2).

When attributes have been assigned to the SSR_AIR_HDR context, the Item Attributes scroll area is available on the Academic Item Registry page.

The screenshot displays the 'Academic Item Registry' page with the following details:

- Academic Institution:** PeopleSoft University
- Academic Item ID:** 00000001757
- Academic Item Type:** Study Period

The main form area includes:

- *Effective Date:** 01/01/1900
- *Status:** Active
- *Description:** BA Econ - Year 1 - Semester 2
- Report Description:** BA Econ - Year 1 - Semester 2 - Study Period is made up of 3 mandatory courses as well as the opportunity to select electives.
- Requires Approval:**

The **Item Attributes** section shows:

- *Attribute:** Cluster Code
- Value:** CLUSTER A
- Show in Student Self-service:**

Field or Control	Description
Attribute	The name of the attribute. This value comes from the description entered for the attribute on the Common Attribute component.
Value	This field changes depending on the type of attribute. This could be a numeric, date, time or text field. Alternatively, the field could prompt against a list of values if one has been defined for the attribute.
Show in Student Self-service	<p>If you select this check box, the attribute is displayed in the filter results in Course Groups component.</p> <p>Wider use of this check box is planned for the future.</p> <p>See Defining Filters</p>

See [Setting Up Academic Item Registry Entries, Item Details, and Item Security](#)

Assigning Item Attributes to Child Academic Items

As mentioned previously, item attributes can be assigned to child academic items, allowing you to assign attributes to academic items in the context of a parent item. For example, an item that represents a course CHEM 399 might have a requirement for minimum score, but only when the course is taken at a certain point in certain program (for example, semester 3 of the Nursing program). This could be coded as a numeric attribute (applicable to the COURSE item type) that can be applied to CHEM 399 as a child of the item representing semester 3 of the nursing program.

Note: An element attribute can override or add to any and all attributes attached to that item at the header level.

Access the Element Attributes (SSR_AIR_ENATTR_SEC) page (click the **Element Attributes** link in the Attributes tab, Academic Item Elements grid on the Item Details page in AIR).

Here is an example of the AIR Item Details page from which you access the Element Attributes page:

Academic Item Registry
Item Details
Rules / Results
Rich Text Fields
Security

Academic Institution PeopleSoft University

Academic Item ID 00000001757

Academic Item Type Study Period

Find | View All
First
1 of 1
Last

Effective Date 01/01/1900 **Status** Active + -

Description BA Econ - Year 1 - Semester 2

Instructions

Each of the Mandatory courses for BA Economics - Year 1 - Semester 2 will automatically be placed in your Schedule Builder. Carefully review the options below for elective courses.

Personalize | Find | View All
First
1 of 1
Last

	*Academic Load	Enrollment Category	Minimum Credits	Maximum Credits	Minimum Number of Courses	Maximum Number of Courses
+ -	▼	▼	0.00	0.00	0.00	0.00

Personalize | Find | View All
First
1-4 of 4
Last

	Elements	Settings	Attributes	Parameters	Rules
	Description	*Element-level Attribute		Element Attributes	
+ -	ECON 1001B: Economic Principles II	Use default item attributes ▼		Element Attributes	
+ -	ECON 1004B: Economic Methods II	Use default item attributes ▼		Element Attributes	
+ -	ECON 112: Intl Political Economy	Use default item attributes ▼		Element Attributes	
+ -	Economics Year 1 Options	Use default item attributes ▼		Element Attributes	

The Element-level Attribute value selected on the Attributes tab carries over to the Element Attributes page but can be changed:

This example illustrates the fields and controls on the Element Attributes page. You can find definitions for the fields and controls later on this page.

Element Attributes

Academic Institution PSUNV PeopleSoft University

Academic Item ID 00000001757 BA Econ - Year 1 - Semester 2

Effective Date 01/01/1900

Seq Nbr 3

Child Item ID 00000000529 ECON 112: Intl Political Economy

▼ Default Attributes Find First ◀ 1 of 1 ▶ Last

Attribute Course Level

4 Level 4

Show in Student Self-service

***Element-level Attribute** Add to default attributes ▼

Element Attributes Find First ◀ 1 of 1 ▶ Last

+ -

***Attribute** Course Level ▼

5 🔍 Level 5

Show in Student Self-service

<i>Field or Control</i>	<i>Description</i>
Default Attributes	All attributes linked to this academic item (ECON 112 in the example) at the item header level are displayed. This attribute is associated with the Record Context SSR_AIR_HDR and stored in the SSR_AIR_ADD table.

Field or Control	Description
Element-level Attribute	<p>The value selected in the Attributes tab (on the Item Details page) appears by default but can be changed. Values are:</p> <ul style="list-style-type: none"> • <i>Use default item attributes:</i> The user cannot enter new values. • <i>Add to default attributes:</i> The Attribute and Value fields in the Elements Attributes group box are available. Any value that is added is used <i>in addition to</i> the default value (s). In the example above, ECON 112 would have two attributes when used as child of BA Econ – Year 1 – Semester 2: Level 2 <i>and</i> Level 3. • <i>Override default attributes:</i> The Attribute and Value fields are available in the Element Attributes group box. Any value that is added is used <i>instead of</i> the default value(s). In the example above, ECON 112 would have an attribute of Level 3 rather than Level 2 when used as child of BA Econ – Year 1 – Semester 2. <p>See Defining Academic Item Details</p>
Attribute	<p>Select an attribute. The values available here are based on the attributes that are associated with the Child Element (SSR_AIR_ELEM) context.</p>
Value	<p>This field becomes available when you select an attribute.</p>

For information about the Item Details page, see Defining Academic Item Type Details later in this section.

Defining Academic Item Details

Access the Item Details page (access this page from the AIR Search component.)

This example illustrates the fields and controls on the Item Details page (1 of 2). You can find definitions for the fields and controls later on this page.

Academic Item Registry | **Item Details** | Rules / Results | Rich Text Fields | Security

Academic Institution PeopleSoft University
Academic Item ID 00000001756
Academic Item Type Study Period

Find | View All | First 1 of 1 Last

Effective Date 01/01/1900 **Status** Active

Description BA Econ - Year 1 - Semester 1

[Instructions](#)

Each of the Mandatory courses for BA Economics - Year 1 - Semester 1 will automatically be placed in your Schedule Builder. Where available, you will be able to select the section in which you wish to enroll.

Academic Item Parameters Personalize | Find | View All | First 1-2 of 2 Last

	*Academic Load	Enrollment Category	Minimum Credits	Maximum Credits	Minimum Number of Courses	Maximum Number of Courses
+ -	Full-Time		15.00	15.00	5.00	5.00
+ -	Full-Time	Mandatory	15.	15.	5	5

This example illustrates the fields and controls on the Item Details page (2 of 2). You can find definitions for the fields and controls later on this page.

Academic Item Elements Personalize | Find | View All | First 1-5 of 5 Last

Elements | Settings | Attributes | Rules

	*Seq Nbr	Connector	{	*Academic Item Type	*Child Item ID	}	Description	+ (+)	- (-)
+ -	1			COURSE	00000000388		ECON 2: Macroeconomic Principles	+ (+)	- (-)
+ -	2	And		COURSE	00000000389		ECON 3: Microeconomic Principles	+ (+)	- (-)
+ -	3	And		COURSE	00000000346		ECON 10: Introduction to Intl Economics	+ (+)	- (-)
+ -	4	And		COURSE	00000000100		POL SCI 1: Intro to US Govt and Politics	+ (+)	- (-)
+ -	5	And		COURSE	00000000566		STATS 101: Statistical Analysis I	+ (+)	- (-)

Grading Elements Personalize | Find | View All | First 1 of 1 Last

	Item Type	*Child Item ID
+ -		

Field or Control	Description
Instructions	<p>This field is available if the Instructions check box is selected on the Attributes page in Academic Item Type setup. Click the Instructions link to access the AIR Rich Text Fields page and enter instructions for self-service users.</p> <p>See Maintaining AIR Rich Text Fields</p>

Academic Item Parameters

This grid is available if the Item Parameters check box is selected on the Attributes page in the Academic Item Type setup.

Enter parameter data by load and enrollment category, to be used in Self Service (planned for the future).

Parameters can be overridden at the child item level.

Field or Control	Description
Enrollment Category	<p>When a value is not selected in the Enrollment Category field, the values in the Minimum/Maximum fields represent overall totals. Enrollment Category values are defined on the Enrollment Category (SSR_ENRL_CAT) page.</p> <p>See Setting Up Enrollment Categories for Program Requirements</p>
Minimal Credits	<p>Enter the minimum credits that a student must achieve for the child items of this item in order to pass the item, if applicable. Note: Currently this field is informational only.</p>
Maximum Credits	<p>Enter the maximum credits allowed for child items of this item, if applicable. Note: Currently this field is informational only.</p>
Minimum Number of Courses	<p>Enter the minimum number of child courses that a student must pass in order to pass this item, if applicable. Note: Currently this field is informational only.</p>
Maximum Number of Courses	<p>Enter the maximum number of child courses that can be taken for this item, if applicable. Note: Currently this field is informational only.</p>

Academic Item Elements

This grid is available if the Child Academic Items check box is selected on the Attributes setup page for an academic item type.

Academic Item Elements establish the relationship between one academic item and one or more other academic items, where one or more items are connected as *children* of another item. Child elements typically represent all of the items that a student must complete in order to satisfy the requirements for a particular academic item. For example a Program of Study academic item might have a number of child elements that are Year or Stage academic items, and the student might need to successfully complete each of those stages in order to complete the program.

Elements Tab:

Field or Control	Description
Connector	<p>This field is available if the Show Connectors check box is selected on the Attributes page for an academic item type. The <i>And</i> option is selected by default, except for COURSELIST items—when child COURSE items are added, the Connector default option is <i>Or</i>.</p> <p>Special processing applies when a child item with an academic item type identified as a Program Format Tree Node is used - the child item connector attribute is limited to <i>And</i>. An error message is returned on save if the Academic Item Elements grid contains one or more items that are identified as Program Format Tree Nodes and there is one row in which the connector is <i>Or</i>.</p> <p>See Setting Up Academic Item Types</p>
Academic Item Type	<p>Select a child academic item type based on the values that you set up in the Item Type Matrix component. Only items identified in the Item Type Matrix as valid child items of this AIR item are available for selection.</p> <p>See Using the Item Type Matrix</p> <p>Available values are also dependent on the AIR security of the user. Academic Item Types defined as Program Format tree nodes are excluded from the prompt unless the user has been authorized as an AIR administrator.</p> <p>See Setting Up AIR Administrator Security</p>
Child Item ID	<p>Select a child item ID. The values that are available here are based on the Academic Item ID value (system generated) that appears on the Academic Item Registry page for the academic item type.</p>
Description	<p>Displays the description for the Child Academic Item ID. Click the link to view the item definition for the child item.</p>

Use the Parentheses buttons to add or delete left or right parentheses. Parentheses are used to group items for AND/OR constructs. For example: (course 1 and course 2) or (course 3 and course 4).

Settings Tab:

This example illustrates the fields and controls on the Item Details page: Settings tab. You can find definitions for the fields and controls later on this page.

Academic Item Elements								
		Personalize Find View All 1-5 of 5 First Last						
		Settings		Attributes		Rules		
		Description	Minimum Units	Maximum Units	Enrollment Category	Description	Weight	Number of Attempts Allowed
<input type="checkbox"/>	<input type="checkbox"/>	ECON 2: Macroeconomic Principles	3.00	3.00	MAND <input type="checkbox"/>	Mandatory	<input type="text" value="1"/>	<input type="text" value="1"/>
<input type="checkbox"/>	<input type="checkbox"/>	ECON 3: Microeconomic Principles	3.00	3.00	MAND <input type="checkbox"/>	Mandatory	<input type="text" value="1"/>	<input type="text" value="1"/>
<input type="checkbox"/>	<input type="checkbox"/>	ECON 10: Introduction to Intl Economics	3.00	3.00	MAND <input type="checkbox"/>	Mandatory	<input type="text" value="1"/>	<input type="text" value="1"/>
<input type="checkbox"/>	<input type="checkbox"/>	POL SCI 1: Intro to US Govt and Politics	3.00	3.00	MAND <input type="checkbox"/>	Mandatory	<input type="text" value="1"/>	<input type="text" value="1"/>
<input type="checkbox"/>	<input type="checkbox"/>	STATS 101: Statistical Analysis I	3.00	3.00	MAND <input type="checkbox"/>	Mandatory	<input type="text" value="1"/>	<input type="text" value="1"/>

In order to show all fields on this tab, the example Settings tab is for a different academic item – Study Period - than the one used in the example of the Elements tab – Stage of Program.

Minimum Units and Maximum Units values are displayed if the child academic item is a Course.

Field or Control	Description
Enrollment Category	<p>The Enrollment Category column appears only if the Requires Enrollment Category check box has been selected for the child academic item type.</p> <p>See Defining Academic Item Type Attributes</p>
Weight	<p>Enter a numeric value to determine the weight given to the child item in calculating the overall result/score for an item. The default is 1 and the value can be set to 0. Note: Currently this field is informational only.</p>
Number of Attempts Allowed	<p>Enter a numeric value to indicate the maximum number of times that this child element can be attempted for this academic item. For example, you might indicate that a Course can be attempted only once within a Study Period.</p> <p>This value is used by the APT Request process when creating new attempts for a planning node.</p>

Attributes Tab:

This example illustrates the fields and controls on the Item Details page: Attributes tab.

Academic Item Elements			
Elements		Settings	Attributes
	Description	*Element-level Attribute	Element Attributes
+ -	ECON 2: Macroeconomic Principles	Use default item attributes	Element Attributes
+ -	ECON 3: Microeconomic Principles	Use default item attributes	Element Attributes
+ -	ECON 10: Introduction to Intl Economics	Use default item attributes	Element Attributes
+ -	POL SCI 1: Intro to US Govt and Politics	Use default item attributes	Element Attributes
+ -	STATS 101: Statistical Analysis I	Use default item attributes	Element Attributes

Field or Control	Description
Element-level Attribute	<p>Determines how attributes that are linked to the child element are to be used in the context of the parent item. The values are:</p> <p><i>Use default item attributes:</i> Any attributes linked to this element at the item header level apply in the context of the parent. For example if ECON 2 has attribute ‘Level’ with a value of ‘2’, this value applies when the course is used as a child of this item (for example, a semester or study period).</p> <p><i>Override default attributes:</i> Any attributes linked to this element at the item header level are to be ignored in favor of attributes that are applied to this item in the context of the parent (see Element Attributes below).</p> <p><i>Add to default attributes:</i> Any attributes linked to this element at the item header level are used in addition to Element attributes defined at this level (see Element Attributes below).</p>
Element Attributes	<p>Click this link to access the Element Attributes page to view, override or add attributes.</p> <p>See Assigning Item Attributes to Child Academic Items</p>

Parameters Tab:

This example illustrates the fields and controls on the Item Details page: Parameters tab.

Academic Item Elements			
Elements		Settings	Parameters
	Description	*Element-level Parameters	Element Parameters
+ -	BA Econ - Year 1 - Semester 1	Use default item parameters	Element Parameters
+ -	BA Econ - Year 1 - Semester 2	Use default item parameters	Element Parameters

This tab is available only if the Item Parameters check box is selected on the Attributes page in the Academic Item Type setup.

To add to or override the data in the Academic Item Parameters grid, select *Add to default parameters* or *Override default parameters* and then click the Element Parameters link to access the Element Parameters page and update the data.

Viewing and Updating Parameters

Access the Element Parameters page (click the **Element Parameters** link on the Item Details page).

This example illustrates the fields and controls on the Element Parameters page.

Element Parameters

Academic Institution PSUNV PeopleSoft University

Academic Item ID 00000001755 BA Econ - Year 1

Effective Date 01/01/1900

Seq Nbr 1

Child Item ID 00000001756 BA Econ - Year 1 - Semester 1

Default Parameters					
Academic Load	Enrollment Category	Minimum Credits	Maximum Credits	Minimum Number of Courses	Maximum Number of Courses
Full-Time		15.00	12.00	4.00	4.00
Full-Time	Mandatory	12.00	12.00	4.00	4.00

*Element-level Parameters Add to default parameters ▼

Element-Level Parameters					
*Academic Load	Enrollment Category	Minimum Credits	Maximum Credits	Minimum Number of Courses	Maximum Number of Courses
▼	▼	0.00	0.00	0.00	0.00

Use the Element Parameters page to view the parameters defined for this item. You can also override the parameters or make additions to them. This allows the overridden (or additional) values to be used for display purposes when an item is accessed in the context of its parent.

Grading Elements

<i>Field or Control</i>	<i>Description</i>
Item Type	Select a grading academic item type. Only those academic item types for which the Grading Item Type check box has been selected on the Attributes setup page are available here. See Defining Academic Item Type Attributes

Assigning Rules and Result Types to Academic Items

Access the Rules / Results page (access this page from the AIR Search component.)

This example illustrates the fields and controls on the Rules / Results page. You can find definitions for the fields and controls later on this page.

The screenshot displays the 'Rules / Results' page for an academic item. At the top, there are navigation tabs: 'Academic Item Registry', 'Item Details', 'Rules / Results' (selected), 'Rich Text Fields', and 'Security'. Below the tabs, the page shows the following information:

- Academic Institution:** PeopleSoft University
- Academic Item ID:** 00000002155
- Academic Item Type:** Concentration

The main content area is divided into several sections:

- Item Rules:** A section with a search bar containing 'SSR_PE_ITEM_PRECOND' and a 'Rule Search' button. Below the search bar, a rule is displayed:
 - Rule Name:** Check for Sub-Plan Condition: Marketing
 - Checkboxes:** Show in Student Self-service
 - Rule Report Description:** Checks APT/Program stack for MARKETING Sub-Plan as a conditon for seleting an APT option.
- Result Types:** A table with columns: *Result Type, Use Default Calc Rule, Rule Name, Result Scale, and Description.

*Result Type	Use Default Calc Rule	Rule Name	Result Scale	Description
W. Average - Stage	<input checked="" type="checkbox"/>	Calculate Stage Weighted Average		

The Rules / Results page is available if an item is configured to have Rules and/or Result Types attached to it as explained in the following documentation.

Item Rules

The Item Rules section is available only if the academic item type (of the item) is associated with at least one rule type on the Rule Type Table page.

See [Setting Up Rules for Program Enrollment](#)

You can assign multiple rules to an academic item but each rule must be of a different rule type.

The rules that you assign here are available for use in User Interfaces and batch processing.

Field or Control	Description
Rule Type	Select a rule type from those defined on the Program Enrollment - Rule Type Table page.
Rule Search	<p>Click to launch the standard Rules Engine search:</p> <ul style="list-style-type: none"> • The Rule Group Name associated with the rule type on the Program Enrollment - Rules Type Table is passed to the search criteria and cannot be changed. • Rule Category is required. • Rule Engine Search is used to return rules with the passed group name as well as any criteria that you add. <p>See “Understanding the Rules Engine” (Campus Community Fundamentals)</p> <p>See “Setting Up the Rules Engine” (Campus Community Fundamentals)</p>
Show in Student Self-service	When this check box is selected, the Rule Name and associated description appear on the self-service Item Details page.
Rule Report Description	When a rule is returned from the search, the Rules Engine Long Description is used as a default but you can edit it by clicking the Rule Report Description link and accessing the Rich Text fields page.

Result Types

The Result Types grid is available only if the academic item type (of the item) is associated with at least one result type on the Result Type page.

Note: Any result type, for which the Auto-create in AIR check box is selected (by academic item type) on the Result Type setup component, is inserted into the Result Types grid when a new academic item is created. Calculation rules associated to the result type are also inserted in the grid.

<i>Field or Control</i>	<i>Description</i>
Result Type	The result types available here are those attached to the academic item type in the Item Type Usage grid on the Result Type page.
Use Default Calc Rule	If this check box is selected, the default calc rule associated with this item type/result type combination on the Result Type setup component is used and cannot be changed. If the check box is deselected, the Rule Name field is available and the prompt can be used to select a valid rule.

See [Setting Up Result Types](#)

The result types assigned to an item are moved to APT when the item is added for a student.

See [Creating and Managing APT Instances Using the Academic Progress Tracker Component](#)

Maintaining AIR Rich Text Fields

Access the Rich Text Fields page (click the **Report Description** link on the Academic Item Registry page).

This example illustrates the fields and controls on the Rich Text Fields page.

Maintaining AIR Rich Text fields

Academic Item Registry | Item Details | Rules / Results | **Rich Text Fields** | Security

Academic Institution PeopleSoft University
 Academic Item ID 00000002155
 Academic Item Type Concentration

Find | View All | First 1 of 1 Last

Effective Date 01/01/1900
 Description Marketing Concentration

▶ Report Description

▶ Instructions

▼ Rules Find | View All | First 1 of 1 Last

Rule Type SSR_PE_ITEM_PRECOND Academic Item Precondition
 Rule ID SCC_RULE_ID_20130607153122
 Rule Name Check for Sub-Plan Condition: Marketing

Rule Report Description

Format [] Font [] Size []

B *I* U abc

Checks APT/Program stack for MARKETING Sub-Plan as a condition for selecting an APT option.

The Rich Text fields page allows you to maintain all three AIR Rich Text enabled fields in one place. A rich text field is available for Report Description and Instructions. Each Rule associated with this item can also have its own rich text enabled description.

See [Defining AIR Entries](#)

See [Defining Academic Item Details](#)

See [Assigning Rules and Result Types to Academic Items](#)

Defining Academic Item Security

Access the Security page (Click the **Item ID** link or **Add New Item** button on the AIR Search page).

This example illustrates the fields and controls on the AIR Security page. You can find definitions for the fields and controls later on this page.

The screenshot displays the 'Security' tab of the AIR system. At the top, there are navigation tabs: 'Academic Item Registry', 'Item Details', 'Rules / Results', 'Rich Text Fields', and 'Security'. Below these, the following information is shown:

- Academic Institution: PeopleSoft University
- Academic Item ID: 00000001757
- Academic Item Type: Study Period

A search bar at the top right contains the text 'Find | View All' and navigation controls 'First', '1 of 1', and 'Last'. Below this, the item details are listed:

- Effective Date: 01/01/1900
- Status: Active
- Description: BA Econ - Year 1 - Semester 2

The 'Security Access' section is highlighted in blue and contains two radio button options:

- Available to all academic organizations
- Grant access to selected academic organizations

Security for AIR Entries

AIR items are secured using the existing User ID based Campus Solutions Academic Organization security. A user's academic organization privileges (as defined under Academic Organization Security (SACR, Security, Secure Student Administration, User ID, Academic Org Security) determine whether a user has update or read only access to a particular academic item.

See "Securing Academic Organizations" (Campus Solutions Application Fundamentals)

- Updating or viewing an existing academic item:

When a user retrieves an AIR entry, the system compares the entries in the AIR security table (SSR_AIR_SCRTY) to the user's academic organization security profile (SCRTY_TBL_ACAD). If the security option is *Grant access to selected academic organizations* and a matching academic organization row is found (or if *Available to all academic organizations* is selected), the user has update access to the item. If no match is found, the user has read only access to the component.

- Adding a child academic item:

A user can select any academic item, however the same edit (as explained above) is performed to determine if the child item is accessible (once added to the grid) in update or read-only mode.

- Course Academic Items:

When a user creates a new course item, the *Grant access to selected academic organizations* option is selected by default and not available for edit. If the user specifies a course offering, the system also displays the relevant academic organization. If the user does not specify a course offering, the system retrieves the academic organizations for *all* offerings of the course when the component is saved. Only users with access to the organizations listed on the Security page can maintain the course.

Managing Special Edits in AIR for COURSE, COURSEGROUP, and COURSELIST Academic Items

Academic items with the delivered item type of COURSE, COURSEGROUP, and COURSELIST are subject to a series of edits and restrictions:

- Course Item (Academic Item Type = COURSE):
 - Only one instance of a Course ID/Offer Number/Topic ID combination is allowed in AIR. When a COURSE academic item type is saved, an edit is performed to check for a match on Course ID, Course Offer Nbr, and Topic ID. If you try to create an academic item with the following attributes: Course ID: 007125, Course Offer Nbr: 1 (ECON 198), Course Topic ID: 1, and a match is found, you receive an error message pointing to the existing academic item. The same edit applies for offerings for which no course topics are defined - only one academic item is allowed for the course offering.
 - When a COURSE item is added as a child of another academic item other than COURSELIST (see the following information about COURSELIST items), the COURSE item must have an Enrollment Category.
- Course List Item (Academic Item Type = COURSELIST):
 - Only COURSE item types can be assigned as child items.
 - When a COURSELIST item is added as a child of another academic item the COURSELIST item must have an Enrollment Category.
- Course Group Item (Academic Item Type = COURSEGROUP):

When a COURSEGROUP item is added as a child of another academic item the COURSEGROUP item must have an Enrollment Category.

Using the Academic Item Registry Copy Function

A copy function is available when you create a new AIR item. This allows you to clone a previously created item of the same type (and all of the related children etc.) and make adjustments to it for another use. For example a generic year 1 or foundation year stage could be defined and then copied and adjusted to suit the needs of different types of programs.

Note that when you copy an item that has child items, the cloned item and the original item share the same child items.

In Add mode on the Academic Item Registry page, the Copy from AIR button is available. Click the button to access a look up page.

<i>Field or Control</i>	<i>Description</i>
Academic Institution	Displays the value of the Institution that you entered when adding the new academic item.

Field or Control	Description
Academic Item Type	Displays the Item Type that you entered for the new academic item.

After you select an item, the data is copied and can be edited.

Course List Copy Function

For Course List academic items, in Add mode, the Copy AA Course List button is available in addition to the Copy from AIR button. If you select the Copy AA Course List option, only those rows in the AA course list that do not have a wild card indicator are copied. Click the button to access a look up page:

- AA Academic structure fields are available for searching, in addition to Course List.
- When an item is selected, all course list rows that do *not* have wild card indicator rows are copied over: that is any row from CLST_DETL_TBL where WILDCARD_ID = Y is excluded.

Creating Academic Items for Courses

Program Enrollment, as delivered, allows you to create academic items that point to a course ID, course offering, course topic, or course offering/topic.

Use the Course Academic Item (SSR_CRSECAT_AIR) component to create academic items for individual courses or the Create Course Academic Item (SSR_RC_CRSEAIR) component batch process to create academic items for multiple courses.

This section discusses how to:

- Create academic items for an individual course.
- View academic item details for courses.
- Create academic items for multiple courses.

Pages Used to Create Academic Items for Courses

Page Name	Definition Name	Navigation	Usage
Course Academic Item	SSR_CRSECAT_AIR	Curriculum Management > Academic Item Registry > Course Academic Item	Create academic items for an individual course.
Course Academic Items Details	SSR_CRSE_AIR_DTL	Click the Details link on the Course Academic Item page.	View course academic item details.

Page Name	Definition Name	Navigation	Usage
Create Course Academic Item	SSR_RC_CRSEAIR	Curriculum Management > Academic Item Registry > Create Course Academic Item	Create academic items for multiple courses.

Creating Academic Items for an Individual Course

Access the Course Academic Item page (**Curriculum Management > Academic Item Registry > Course Academic Item**).

Click the link next to the Course ID to access the Course Catalog (CRSE_CATALOG) component.

See [Creating Course Offerings](#)

Field or Control	Description
Effective Date	This is the maximum effective dated row (less than or equal to the system date) for the course from the Course Catalog (the Course Academic Item search page prompts are the same as those for the Course Catalog search page but only the maximum effective dated row is returned).
Course Catalog, Course Offer, Course Catalog Topic, and Course Offer Topic	Data appears based on the data in the Course Catalog – for example, if no topic exists in the Course Catalog, the Select check box is not available for edit for the Course Catalog Topic.
Select	Use this check box to indicate that you want to create an academic item for a course, offering, topic, or offering/topic.
Item ID	This link appears if an academic item already exists in the Academic Item Registry component - click the link to access the component. See Setting Up Academic Item Registry Entries, Item Details, and Item Security
Description	View the description for an existing academic item. If no academic item exists, the Course Description appears here by default and you can edit it. <hr/> Note: The Description field for entries under Course Offer and Course Offer Topic is populated with the Subject and Catalog Number values for the offering as well as the Course Description, For example a course with the Description <i>Intro Spanish</i> , with an offering with a subject of <i>SPAN</i> and a Catalog Number of <i>100</i> , appears as <i>SPAN 100: Intro Spanish</i> . <hr/>

Field or Control	Description
Select All and Clear All	Click these buttons to select or clear all the check boxes in the Select column.
Create Academic Item	<p>Click this button to create academic items in the AIR component for the course, offering, topic, and offering/topic for which the Select check box is selected. When an academic item is created:</p> <ul style="list-style-type: none"> • The Item ID link appears here on the Course Academic Item page. • The Course Academic Item link appears on the Offerings page in the Course Catalog component. Click the link to access the Course Academic Item page. <p>See Creating Course Offerings</p>
Details	Click this link to access the Course Academic Item Details page and view a summary of the course academic items that have been created.

Item Attributes

Any attributes that have been defined as required for the Academic Item record context (SSR_AIR_HDR)—the Required check box is selected on the Record Context page in the Common Attribute setup—and associated with the COURSE item type entity (‘AIR Course’) defaults into the Item Attributes scroll area. These attributes cannot be deleted and you must select a value in order to create an academic item.

See [Setting Up Academic Item Registry Entries, Item Details, and Item Security](#)

See “Defining a Common Attribute” (Campus Community Fundamentals)

See “Associating a Common Attribute to a Record” (Campus Community Fundamentals)

Viewing Academic Item Details for Courses

Access the Course Academic Item Details page (click the **Details** link on the Course Academic Item page).

This example illustrates the fields and controls on the Course Academic Item Details page . You can find definitions for the fields and controls later on this page.

Course Academic Item Details

Academic Institution	PSUNV	Effective Date	01/01/1900
Course ID	003276	Status	Active
Description	Survey of American Literature		

Details

<i>Field or Control</i>	<i>Description</i>
Details	View details of all the academic items that have been created for the course. This is not a stored message and exists for the life of the component or until the Create Academic items button is clicked again.

Creating Academic Items for Multiple Courses

Access the Create Course Academic Item page (**Curriculum Management > Academic Item Registry > Create Course Academic Item**).

This example illustrates the fields and controls on the Create Course Academic Item page. You can find definitions for the fields and controls later on this page.

Create Course Academic Item

Run Control ID: PS [Report Manager](#) [Process Monitor](#) Run

Run Control Options

*Academic Institution: PeopleSoft University
 Course Catalog Course Catalog Topic
 Course Offer Course Offer Topic

Population Selection

Population Selection

Selection Tool: PS Query [Edit Prompts](#)

Query Name: SSR_POP_CRSEAIR_ACADORG
[Launch Query Manager](#) [Preview Selection Results](#)

Manual Selection

Use Course Select Clear List

1	Course ID	Description	
	001248	General Accounting	+ -

Item Attributes [Find](#) First 1.2 of 2 Last

*Attribute: Campus + -

🔍

*Attribute: Course Level + -

🔍

Run Control Options

<i>Field or Control</i>	<i>Description</i>
Course Catalog	This check box is selected by default. The SSR_CRSE_AIR process creates an academic item for the course for the selected institution.
Course Catalog Topic	If this check box is selected, the process creates an academic item for each course topic that exists for the course ID.
Course Offer	If this check box is selected, the process creates an academic item for each course offering that exists for the course ID.

Field or Control	Description
Course Offer Topic	If this check box is selected, the process creates an academic item for each course offering and topic combination that exists for the course ID.

Population Selection

The Population Selection group box is a standard group box that appears on run control pages when the Population Selection process is available or required for the transaction. Selection tools are available based on the selection tools that your institution selected in the setup of the Population Selection process for the application process and on your user security. Fields in the group box appear based on the selection tool that you select. The fields behave the same way from within the group box on all run control pages and application processes. If your institution uses a specific delivered selection tool to identify IDs for a specific transaction, you must use it.

Select the Population Selection check box to use the Population Selection process to select the courses for which you want to create academic items. When you select this check box, the Selection Tool and Query Name fields become available.

Field or Control	Description
Selection Tool	Select <i>External File</i> or <i>PS Query</i> .
Query Name	<p>The following queries are delivered:</p> <ul style="list-style-type: none"> • <i>SSR_POP_CRSEAIR_ACADGROUP</i>: Select courses by institution and academic group. • <i>SSR_POP_CRSEAIR_ACADORG</i>: Select courses by institution and academic organization. • <i>SSR_POP_CRSEAIR_BYDATE</i>: Select courses by creation date using institution, operator id and date/time when the course was added. • <i>SSR_POP_CRSEAIR_SUBJECT</i>: Select courses by institution and course subject. <p>If you create queries, you must use the bind record <i>SSR_CRSECAT_BND</i>.</p>

See “Understanding Population Selection” (Campus Community Fundamentals)

See “Using the Population Selection Process” (Campus Community Fundamentals)

Manual Selection

<i>Field or Control</i>	<i>Description</i>
Use Course Select	If this check box is selected, you can manually select the courses for which you want to create academic items.
Clear List	Click this button to remove all Course ID rows and clear the Course ID field.

Item Attributes

Any attributes that have been defined in the Common Attribute setup as required for the Academic Item record context (SSR_AIR_HDR) and associated with the COURSE item type entity ('AIR Course') default into the Item Attributes scroll area. These attributes cannot be deleted and you must select a value in order to run the process.

See [Using Item Attributes to Extend AIR Data Elements](#)

See “Defining a Common Attribute” (Campus Community Fundamentals) “Associating a Common Attribute to a Record” (Campus Community Fundamentals)

Running the Create Course Academic Items Process

<i>Field or Control</i>	<i>Description</i>
Run	<p>Click to run the SSR_CRSE_AIR process and create course academic items in AIR.</p> <p>When an academic item is created:</p> <ul style="list-style-type: none"> • The Item ID link appears on the Course Academic Item page. • The Course Academic Item link appears on the Offerings page in the Course Catalog component. Click the link to access the Course Academic Item page. <p>See Creating Course Offerings</p>

Building Programs by Format

This section provides an overview of building programs by format and discusses how to:

- Use the Build Program by Format component in Add mode.
- Use the Build Program by Format component in Update/Display mode.

Understanding How to Build Programs by Format

The Academic Item Registry component allows you to create program elements and to establish links between those elements. However, because no intrinsic program hierarchy is built into the structure, you cannot use the component to build a program in ‘top-down’ fashion. That is, the program and its parts cannot be built and assembled in a single task flow. The Build Program by Format component provides this single task flow user experience by using the Program Format structure to establish a framework—and therefore a program hierarchy—upon which you can assemble a program of study. This single task flow streamlines the program building process, allowing you to chart your progress towards completion. When data entry is complete you can easily access a complete view of the program.

See [Setting Up Program Formats](#)

Note: Build Program by Format always obeys the Program format. Therefore, a user cannot insert an unauthorized tree node (even if the user is an AIR administrator).

See [Setting Up AIR Administrator Security](#)

The task is accomplished in three steps:

- You provide a Program Format ID.
- The component renders the Program Format Tree structure.
- You follow the tree guideline to build the elements of the program by adding new academic items or using previously built academic items.

All program items are audited against their program format definition when the program academic item is retrieved in the Build Program by Format or Program Template components.

Note: The Build Program by Format component restricts the type of items that can be assigned within a program tree:

When you assign an item to a tree node, you must create or use an academic item of the same type that was used in the program format definition.

Child Items: Only items with an item type that is not defined as a Program format tree node can be assigned as a child to an item that you create or update in this component.

Page Used to Build Programs by Format

<i>Page Name</i>	<i>Definition Name</i>	<i>Navigation</i>	<i>Usage</i>
Build Program by Format	SSR_PROG_BUILDER	Curriculum Management > Academic Item Registry > Build Program by Format > Build Program by Format	Build programs by format.
Build Program by Format (select mode)	SSR_PRG_BLDR_SEL	Click the link for any item type in the tree other than PRG.	Specify how you want to assign the item for the node.

Using the Build Program by Format Component in Add Mode

To build a program by format in Add mode:

1. Add the program by selecting an Institution and Program Format.

This example illustrates step 1 in the Build Program by Format (Add mode) process.

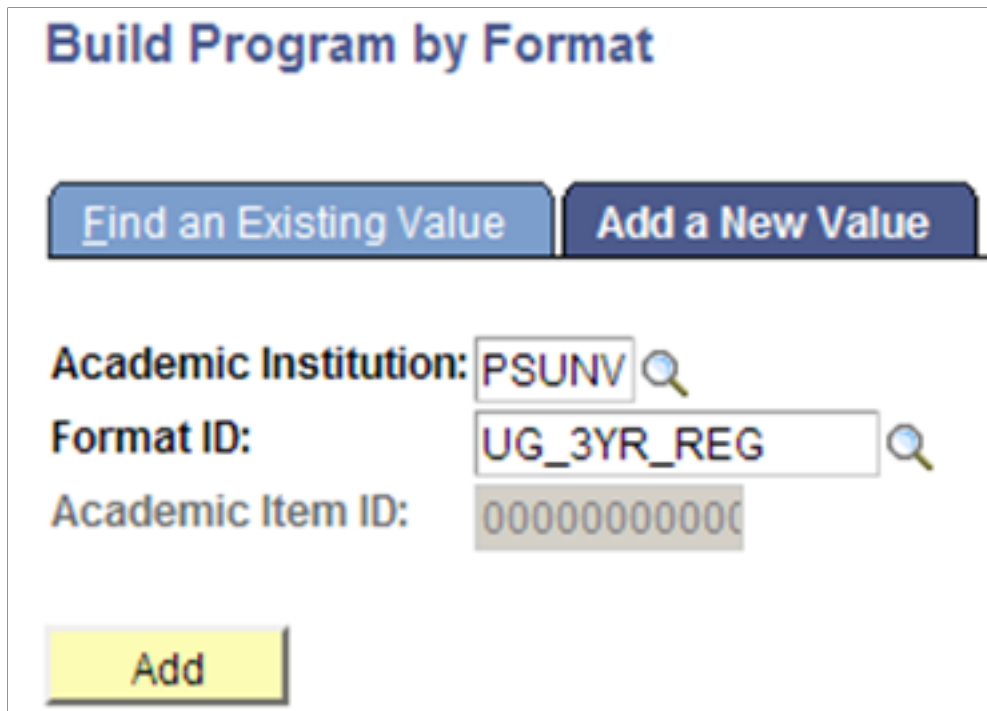

The screenshot shows a web interface titled "Build Program by Format". At the top, there are two buttons: "Find an Existing Value" and "Add a New Value". Below these buttons, there are three input fields:

- Academic Institution:** A text input field containing "PSUNV" with a magnifying glass icon to its right.
- Format ID:** A text input field containing "UG_3YR_REG" with a magnifying glass icon to its right.
- Academic Item ID:** A text input field containing "0000000000".

At the bottom left of the form, there is a yellow "Add" button.

2. The Program Format appears in a Tree view when the component opens:

This example illustrates step 2 in the Build Program by Format (Add mode) process.

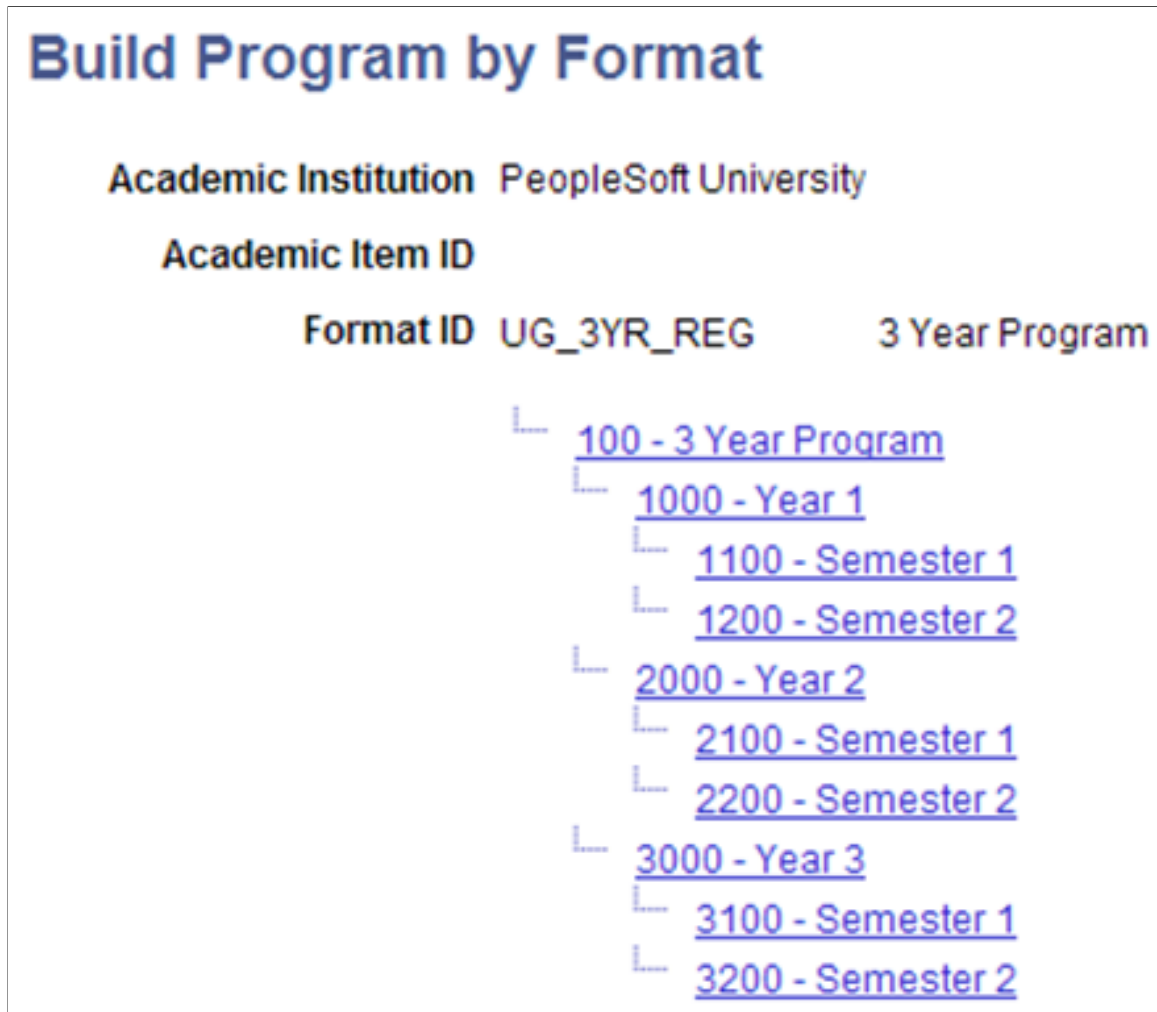

Each node of the tree is a link/prompt for you to:

Build a new academic item for the node or

Associate an existing item with the node or

Clone an existing item to create a new item for the node.

You must assemble the program in accordance with the tree structure. Begin at the root (program) node. If you click any other link you receive a message instructing you to assign the item for the Parent node. The message returns the node ID that should be used (in this example it would be 100). This same message is returned if you skip a level in the tree. In this example if you assign the item for node 100, but then click the link for 1100, the error message instructs you to first assign the item for the parent (1000).

3. Program (Node Academic Item Type = PRG):

Click the link for the root node that represents the Program of Study: you are transferred to the AIR component where you create a new academic item for the Program node.

This example illustrates step 3 in the Build Program by Format (Add mode) process.

The screenshot shows the 'Academic Item Registry' form. At the top, there are tabs for 'Academic Item Registry', 'Item Details', 'Rich Text Fields', and 'Security'. The form displays the following information:

- Academic Institution:** Great Lakes University
- Academic Item ID:** (empty)
- Academic Item Type:** Stage of Program

Below this, there is a search bar with 'Find', 'First', '1 of 1', and 'Last' buttons. The main form fields include:

- *Effective Date:** 01/01/1900
- *Status:** Active (dropdown menu)
- *Description:** (text input field)
- Internal Description:** (text input field with a search icon)
- Report Description:** (text area)
- Degree:** (text input field with a search icon)
- Requires Approval:**

At the bottom, there is an 'Item Attributes' section with a search bar and 'Find', 'First', '1 of 1', and 'Last' buttons. It includes:

- *Attribute:** (dropdown menu)
- Show in Student Self-service:**

The Institution and Academic Item Type (Program of Study) appear by default and cannot be changed. All of the features of the AIR component are available. You can:

Save and return to the Build Program by Format page by clicking OK.

Discard any changes and return by clicking Cancel.

Save any changes and remain on the AIR component by clicking Apply.

When you click OK, the item is saved, an academic item ID is assigned, and you are returned to the Build Program by Format main page:

This example illustrates the Build Program by Format main page after you save the AIR component.

The screenshot shows the 'Build Program by Format' interface. At the top, it displays 'Academic Institution: Great Lakes University' and 'Academic Item ID: 00000001469'. Below this, it shows 'Format ID: UG_3YR_REG' and '3 Year Program'. A tree structure of items is shown, with the root node '100 - 00000001469' highlighted in yellow. The tree includes sub-nodes for '1000 - Year 1', '2000 - Year 2', and '3000 - Year 3', each with its own semester sub-nodes. At the bottom, a 'Program Structure' tab is active, displaying a table with the following data:

Item Description	Item Type	Item ID	Format Node
BS Chemistry	Program of Study	00000001469	100 - 3 Year Program

The tree node where the item was assigned is highlighted and inactivated. The Program Structure tab opens and the academic item (and any child items) that was assigned to the node is listed.

If updates are required, use the Item ID link to access the item.

Any Other Item Type (other than PRG) in the Tree

When you click the link for any other item type in the tree, you are transferred to the Build Program by Format - Select Mode (SSR_PRG_BLDL_SEL) page where you specify how you want to assign the item for this node. By default, the Item Type value is the item type of the node and cannot be changed.

This example illustrates the fields and controls on the Build Program by Format (select mode) page. You can find definitions for the fields and controls later on this page.

Build Program by Format

Institution PeopleSoft University

Format ID UG_3YR_REG 3 Year Program

Select Mode

Create New Item

Use Existing Item

Clone Existing Item

Item Type STAGE

<i>Field or Control</i>	<i>Description</i>
Create New Item	When you select this option, you are transferred to the AIR component. Institution and Academic Item Type values appear by default and cannot be changed. After you create the item in AIR and click OK, you are returned to the Build Program by Format main page and the node is inserted in the program structure.
Use Existing Item	When you select this option, the Academic Item ID field becomes available (the Item Type value is the item type of the node and cannot be changed). The academic items that are available match the Institution, Item Type, and <i>Effective Date</i> of the Program Node. If you select an existing item, you are returned to the Build Program by Format main page and the node is inserted in the program structure.

Field or Control	Description
Clone Existing Item	<p>If you select this option, the academic items that are available match the Institution, Item Type, and <i>Effective Date</i> of the Program Node. If you select an existing item, you are transferred to the AIR component. The Effective Date is, by default, the Effective Date of the Program Node and cannot be changed. After you clone the item, you are returned to the Program by Format main page and the node is inserted in the program structure.</p> <p>Note that when you copy an item that has child items, the cloned item and the original item share the same child items.</p>

Using the Program Structure Tab

When academic items are assigned to the tree nodes, the program structure is tracked in the Program Structure tab on the Build Program by Format page. The display is updated as academic items are created/assigned to tree nodes. Rows are inserted for each assigned item as well as any child items entered for the item (or child items that were attached to an existing item).

This example illustrates the fields and controls on the Build Program by Format page (Program Structure tab). You can find definitions for the fields and controls later on this page.

Build Program by Format

Academic Institution PeopleSoft University
 Academic Item ID 00000001715
 Format ID UG_3YR_REG 3 Year Program

- └ 100 - 00000001715
 - └ 1000 - Year 1
 - └ 1100 - Semester 1
 - └ 1200 - Semester 2
 - └ 2000 - Year 2
 - └ 2100 - Semester 1
 - └ 2200 - Semester 2
 - └ 3000 - Year 3
 - └ 3100 - Semester 1
 - └ 3200 - Semester 2

+

Expand / Collapse	Item Description	Item Type	Item ID	Format Node
[-]	B.S. Economics	Program of Study	00000001715	100 - 3 Year Program
[-]	└ B.S. Economics - Year 1	Stage	00000001687	1000 - Year 1
[-]	└ └ Y1-Sem 1 - B.S. Economics	Study Period	00000001688	1100 - Semester 1
	└ └ └ ECON 2: Macroeconomic Principles	Course	00000000405	
	└ └ └ and ECON 3: Microeconomic Principles	Course	00000000406	
	└ └ └ and ECON 10: Introduction to Intl Economics	Course	00000000407	
	└ └ └ and ACCT 1001: Introduction to Accounting	Course	00000000303	
	└ └ └ and COMM 3: Public Communication	Course	00000000002	
[-]	└ └ and Y1-Sem 2 - B.S. Economics	Study Period	00000001689	1200 - Semester 2
	└ └ └ ECON 213: Money and Banking	Course	00000000172	
	└ └ └ and ECON 112: Intl Political Economy	Course	00000000193	
	└ └ └ and ECON 203: Public Economics	Course	00000000412	
[-]	└ └ and BS Econ Y1-Sem1 Electives	Requirement	00000001707	
[-]	└ └ └ BS Economics Year 1 Electives	Course List	00000001705	
	└ └ └ └ ECON 113: Latin America	Course	00000000164	
	└ └ └ └ and ECON 146: The Economics of Crime	Course	00000000165	
	└ └ └ └ and ECON 167: Econ and Social Challenges	Course	00000000166	
	└ └ └ └ and ECON 176: Economic Themes in Film	Course	00000000167	
	└ └ └ └ and ECON 183: The Middle East	Course	00000000168	
[-]	└ └ └ or BS Economics Year 1 - Finance	Course List	00000001706	

Field or Control	Description
Expand/Collapse	You can expand or collapse any related child data.
Item ID	Click this link to transfer to the AIR component.
Format Node	The value that appears here is based on the setup on the Program Format (SSR_PROG_FORMAT) page.

Using the Build Program by Format Component in Update/Display Mode

You can use the Build Program by Format component to retrieve and update an existing program. Items can be assigned to tree nodes and existing items can be maintained. The search record is restricted to academic items with an academic item type of PRG.

Viewing Program Format Audit Messages

When you retrieve a program, the Program Format audit is run and missing tree nodes (and missing child nodes) are identified and listed on the page in the Program Format Audit Messages grid:

Build Program by Format

Academic Institution PeopleSoft University
 Academic Item ID 00000001715
 Format ID UG_3YR_REG 3 Year Program

- └ 100 - 3 Year Program
 - └ 1000 - Year 1
 - └ 1100 - Semester 1
 - └ 1200 - Semester 2
 - └ 2000 - Year 2
 - └ 2100 - Semester 1
 - └ 2200 - Semester 2
 - └ 3000 - Year 3
 - └ 3100 - Semester 1
 - └ 3200 - Semester 2

Expand / Collapse	Item Description	Item Type	Item ID	Format Node
[-]	B.S. Economics	Program of Study	00000001715	100 - 3 Year Program
[+]	└ B.S. Economics - Year 1	Stage	00000001687	1000 - Year 1
[+]	└ and B.S. Economics - Year 2	Stage	00000001690	2000 - Year 2
[-]	└ Y2-Sem 1 - B.S. Economics	Study Period	00000001691	2100 - Semester 1
[-]	└ and Y2-Sem 2 - B.S. Economics	Study Period	00000001692	2200 - Semester 2

Program Format Audit Messages	
Description	
1 Missing Stage item (Node 3000) under parent Academic Item ID 00000001715.	
2 Missing Study Period item (Node 3100) under parent node 3000.	
3 Missing Study Period item (Node 3200) under parent node 3000.	

The audit occurs each time that you retrieve a program using the Build Program by Format component— if a program is left unfinished, the audit messages appear the next time that a program is retrieved.

When an item has not been assigned to a node in a particular branch of a tree, a message is returned in the following format: Missing <Item Type Description> item (Node <Tree node ID of child>) under parent Academic Item ID <Academic Item ID assigned to the PRG node>.

In the example above an academic item has not been assigned for the tree node 3000 – Year 3:

Error message sequence 1 identifies the item type and the ID for the missing node, with a reference to the item ID of the parent program node.

Error messages 2 and 3 (for the missing study periods) refer to the parent only by the node ID, because an academic item has not been assigned.

Using the Messages Tab

Select the Build Program by Format page, Messages tab.

This example illustrates the fields and controls on the Build Program by Format page (Messages tab).

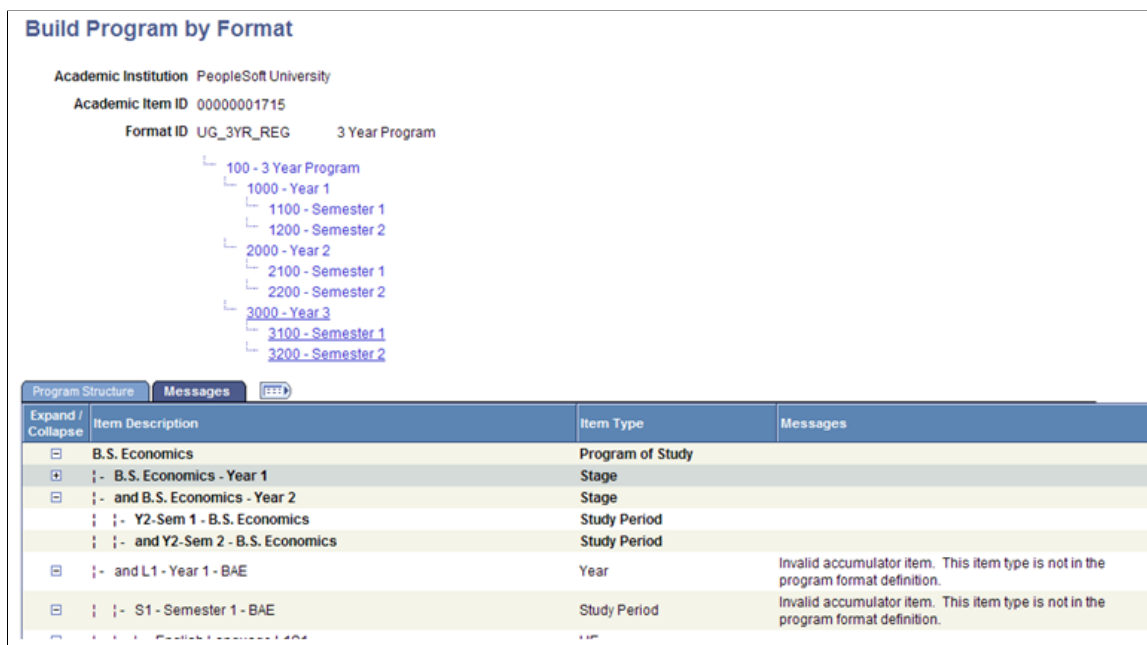

In addition to the program format audit messages, the Build Program by Format component also displays messages when an invalid Program Format Tree Node item has been inserted in a program tree. This could occur if you retrieved an item associated with a tree node in the Academic Item Registry component, because this action is prevented on the Build Program by Format component. The error is detected by the audit process and an error message is displayed on the Errors tab on the Build Program by Format page. When messages are present, the Errors tab appears as the Messages tab.

Field or Control	Description
Messages	The message identifies the invalid node. This item type is not attached to a node in the tree branch.

Generating and Viewing Program Templates

This section provides an overview of program templates and discusses how to:

- Generate and view an AIR based program template.
- View the Template – Long page.

Understanding Program Templates

Use the program template to generate and view a program of study (or any other academic item) in its entirety. On the page, the academic item and its children appear in a composed view that displays all the levels within that item. You can use links to view detailed information and make changes at any level in the template.

Pages Used to Generate and View Program Templates

Page Name	Definition Name	Navigation	Usage
Template	SSR_AIR_TEMPLATE	Curriculum Management > Academic Item Registry > Program Template > Template	Generate and view a program of study or other academic item in its entirety.
Template – Long	SSR_AIR_TMPLT1	Curriculum Management > Academic Item Registry > Program Template > Template – Long	View the long display of the AIR Report description for the selected academic item.

Generating and Viewing an AIR Based Program Template

Access the Template page (**Curriculum Management > Academic Item Registry > Program Template > Template**).

This example illustrates the fields and controls on the Template page. You can find definitions for the fields and controls later on this page.

Template Template - Long

Academic Institution PeopleSoft University UK
 Academic Item ID 0000001103 BSc (Eng) in Mechanical Engineering
 Academic Item Type Program of Study

As of Date 19/03/2013

Expand / Collapse	Item Description	Enrollment Category	Item Type	Item ID
<input type="checkbox"/>	BSc (Eng) in Mechanical Engineering		Program of Study	0000001103
<input type="checkbox"/>	├ BSc Mechanical Engineering First Year of Study		Year	0000001099
<input type="checkbox"/>	├ and BSc Mechanical Engineering Second Year of Study		Year	0000001100
<input type="checkbox"/>	├ and BSc Mechanical Engineering Third Year of Study		Year	0000001101
<input type="checkbox"/>	├ and BSc Mechanical Engineering Fourth Year of Study		Year	0000001102

Here is an example of the page with the items expanded:

Template
Template - Long

Academic Institution PeopleSoft University UK
 Academic Item ID 00000001103 BSc (Eng) in Mechanical Engineering
 Academic Item Type Program of Study

As of Date

Expand / Collapse	Item Description	Enrollment Category	Item Type	Item ID
<input type="checkbox"/>	BSc (Eng) in Mechanical Engineering		Program of Study	00000001103
<input type="checkbox"/>	- BSc Mechanical Engineering First Year of Study		Year	00000001099
<input type="checkbox"/>	- EB005/EB010 - Common 1st Year Core Courses	Core	Course List	00000001078
	- CHEM 1008FA: Chemistry for Engineers	Core	Course	00000001022
	- and MATHS 1017F: Engineering Mathematics A	Core	Course	00000001023
	- and MATHS 1018F: Engineering Mathematics B	Core	Course	00000001024
	- and MATHS 1042S: Engineering Statistics	Core	Course	00000001025
	- and MENG 1002W: Engineering Drawing	Core	Course	00000001026
	- and MENG 1004W: Engineering I	Core	Course	00000001027
	- and PHYSICS 1012F: Engineering Physics A	Core	Course	00000001028
	- and PHYSICS 1013F: Engineering Physics B	Core	Course	00000001029
	- and MENG 1000X: Practical Training	Core	Course	00000001030
<input type="checkbox"/>	- and BSc Mechanical Engineering Second Year of Study		Year	00000001100
<input type="checkbox"/>	- EB005/EB010 - Common 2nd Year Core Courses	Core	Course List	00000001079
	- EENG 2030F: Electrical Engineering I	Core	Course	00000001031
	- and EENG 2031S: Electrical Engineering II	Core	Course	00000001032
	- and MATHS 2083F: Vector Calculus for Engineers	Core	Course	00000001033
	- and MATHS 2084F: Linear Algebra	Core	Course	00000001034
	- and MENG 2020W: Design I	Core	Course	00000001035
	- and MENG 2022S: Thermofluids I	Core	Course	00000001036
	- and MENG 2023F: Dynamics I	Core	Course	00000001037

Field or Control	Description
As of Date	The system uses the date that you enter to retrieve the correct effective dated row for the select item and related child items.
Generate	<p>Click this button to retrieve the definition for the selected academic item, and all child items attached to it.</p> <p>When the template is generated, the item and any related child items are displayed in the collapsed form, as shown in the first page example above. Items can be expanded using the Expand/Collapse button. After an item has been expanded, the Program Format Structure View button becomes available and can be used to collapse all items, as shown in the second page example.</p>
Expand/Collapse	Expand or collapse any related child data.
Item Description	The Description from the Academic Item header is displayed (SSR_AIR_HDR.DESCR50).
Enrollment Category	The description for the Enrollment category of the item (SSR_AIR_ENRL.SSR_ENRL_CAT) is displayed.
Item Type	The item type description is displayed for the academic item.

Field or Control	Description
Item ID	<p>Click the link to access the Academic Item Registry component for the selected ID. You can make and save changes in that component before you return to the Program Template component.</p> <hr/> <p>Note: When a Program item is accessed from the Template view, the Program Format structure is enforced and academic item types that are identified as Program Format Tree Nodes cannot be added or deleted.</p> <hr/>

See [Setting Up Academic Item Types](#)

See [Setting Up Program Formats](#)

Viewing the Template – Long Page

Access the Template – Long page (**Curriculum Management > Academic Item Registry > Program Template > Template – Long**).

This example illustrates the fields and controls on the Template Long page.

Template
Template - Long

Academic Institution PeopleSoft University UK
 Academic Item ID 0000001103 BSc (Eng) in Mechanical Engineering
 Academic Item Type Program of Study

As of Date

Item Description	Enrollment Category	Item Type	Item ID
DEPARTMENTS			
Mechanical Engineering			
BSc (Eng) in Mechanical Engineering			
<p>The Mechanical Engineering degree provides students with a solid understanding and appreciation of the materials and forces of nature. The undergraduate programme is structured around the study of mathematics, physics, chemistry, materials, basic electrical engineering, the design process and management studies. Exciting careers, requiring the talents of mechanical engineers for the design, development and manufacture of technologies, products and processes, include automotive, aircraft and space industries, air conditioning and refrigeration, food and packaging industry, biomechanical research and development, energy and power utilisation, and the environmental industry, to name a few. Many of our graduates have followed successful career paths and are now captains of industry.</p> <p>This programme concentrates on instruction in the areas of solid mechanics, dynamics and thermofluids, accompanied by experimental verification. Communication skills are addressed through expert instruction and application in reports of experimentation and design. Design is made central to the curriculum where team skills and, finally, individual skills are developed. Curriculum flexibility in the final year of study allows students to select courses that can provide an introduction to a career in Mechanical Engineering.</p>		Program of Study	0000001103
<p>▼ The first year of study contains Common First Year Core Courses equating to 144 credits, and a Practical Training Course. Students should attempt and complete all Core Courses and the Practical Training Course.</p>		Year	0000001099
<p>▼ Bachelor of Science in Engineering in Electro-Mechanical Engineering (EB010)</p> <p>▼ Bachelor of Science in Engineering in Mechanical Engineering (EB005)</p>			
<p>The undergraduate Bachelor of Science in Engineering degree programmes in Electro-Mechanical Engineering and Mechanical Engineering have a common first and second year Curriculum.</p> <p><i>Students should complete and pass all Core Courses in the list below:</i></p> <ul style="list-style-type: none"> • CHEM 1008FA: Chemistry for Engineers • and MATHS 1017F: Engineering Mathematics A • and MATHS 1018F: Engineering Mathematics B • and MATHS 1042S: Engineering Statistics • and MFNG 1002W: Engineering Drawing 	Core	Course List	0000001078
	Core	Course	0000001022
	Core	Course	0000001023
	Core	Course	0000001024
	Core	Course	0000001025
	Core	Course	0000001026

The Template - Long page includes the long display of the AIR Report description for the selected academic item (that is, the highest item node).

Setting Up Course Groups

This section provides an overview of course groups and discusses how to:

- Define course groups.
- Define course group details.
- View test output.
- Define filters.

- Copy course groups.

Understanding Course Groups

The AIR feature provides the ability to define simple or complex lists of courses (Course ID, Course Offering, Course Topics), but the structure cannot accommodate the commonly used (in academic requirements) wild card course option, where, for example, the student is instructed to take *one 200 level course from the Economics Department*.

Use the Course Group feature in conjunction with the academic item type COURSEGROUP. A Course Group consists of one or more sets of wild card criteria that can be used to build a loosely defined list of courses.

Pages Used to Set Up Course Groups

Page Name	Definition Name	Navigation	Usage
Course Group Header	SSR_CRS_GRP_HDR	Curriculum Management > Academic Item Registry > Course Groups > Course Group Header	Define course groups.
Course Group Detail	SSR_CRS_GRP_DTL	Curriculum Management > Academic Item Registry > Course Groups > Course Group Detail	Define course group details.
Test Output	SSR_CRS_GRP_OUT	Curriculum Management > Academic Item Registry > Course Groups > Test Output	View test output.
Filters	SSR_CRS_GRP_FILTER	Curriculum Management > Academic Item Registry > Course Groups > Filters	Define a subset of the available Course Group criteria fields as filters for use in student self-service.

Defining Course Groups

Access the Course Group Header page (**Curriculum Management > Academic Item Registry > Course Groups > Course Group Header**).

This example illustrates the fields and controls on the Course Group Header page. You can find definitions for the fields and controls later on this page.

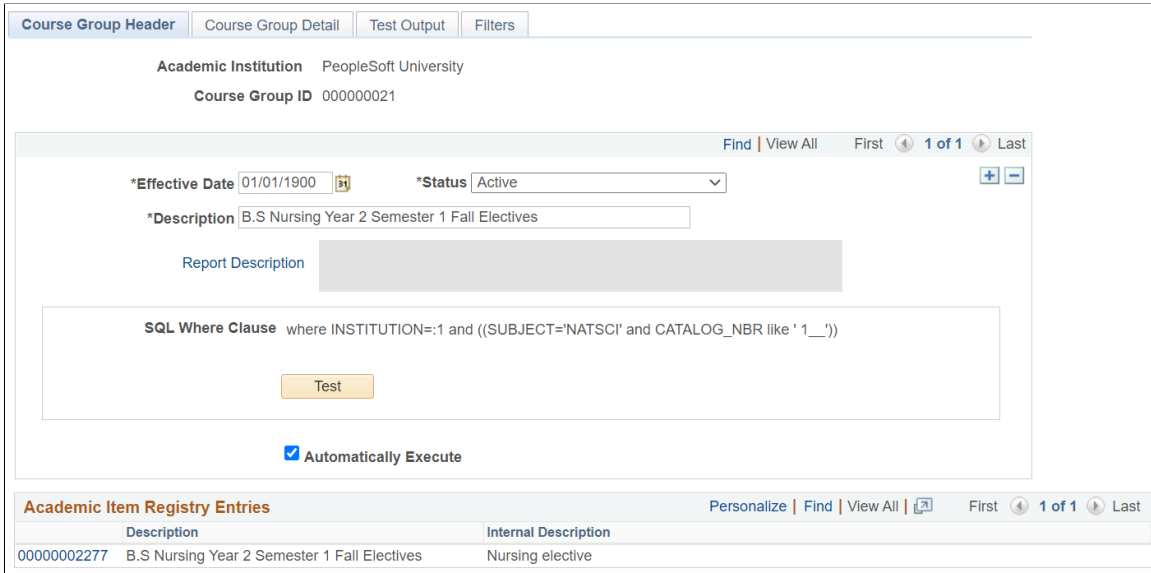

Course Groups are defined by Institution and a system generated ID number.

Field or Control	Description
Report Description	Click this link to access a new window in which Rich Text Editor features are available. The HTML output for the formatted text appears as display only in the Report Description field.
Automatically Execute	When this check box is selected, the list of courses defined by this Course Group is returned directly to the self-service UI (My Education Plan); otherwise, the results are accessed on a secondary page. See “Using Program Enrollment Self-Service Features” (Campus Self Service)
SQL Where Clause	On save, the system connects all of the Course Group Detail lines and generates and displays a SQL where clause using the criteria from each detail row.
Test	Click to initiate a SQL count statement which returns the number of course offering (CRSE_OFFER) rows that meet the criteria in the Course Group Detail line(s): The row count is returned in a modal message, with an option to view the results. To address performance concerns, you receive a warning when over 300 rows are returned, giving you the option to refine the search or continue to view the results.

<i>Field or Control</i>	<i>Description</i>
Add AIR Entry for this Course Group	Click this button to create an academic item for this Course Group definition. The button creates a new item for this course group and transfers the user to the Academic Item Registry component.

Defining Course Group Details

Access the Course Group Detail page (**Curriculum Management > Academic Item Registry > Course Groups > Course Group Detail**).

This example illustrates the fields and controls on the Course Group Detail page. You can find definitions for the fields and controls later on this page.

Course Group Header
Course Group Detail
Test Output
Filters

Academic Institution PeopleSoft University
 Course Group ID 00000018

[Find](#) | [View All](#) First ◀ 1 of 1 ▶ Last

Effective Date 01/01/1900 Status Active + -

Description Liberal Arts and Management Upper Division

[Find](#) | [View All](#) First ◀ 1 of 2 ▶ Last

*Sequence Number + -

*Description

Subject Area 🔍

Catalog Nbr 🔍 ?

Academic Career 🔍

Academic Group 🔍 College of Liberal Arts

Academic Organization 🔍

Campus 🔍

Requirement Designation 🔍

Course Attribute 🔍

Course Attribute Value 🔍

Academic Item Attribute ▼

SQL Where Clause CATALOG_NBR like '3___' and ACAD_GROUP='LBART'

Test

Field or Control	Description
Sequence Number	Enter a user defined sequence number.
Description	Enter a description for the Group Detail row.

Field or Control	Description
Catalog Nbr	<p>Enter % to match one or more characters—for example, 20% retrieves all catalog numbers where the first two characters are 2 and 0.</p> <p>Enter _ (underscore) to match a single character.</p> <p>Enter # to match any single numeric character.</p>
Academic Career, Academic Group, Academic Organization, Campus, Requirement Designation, Course Attribute, and Course Attribute Value	Enter valid values in these fields to further refine the selection criteria for the Course List against the Course Catalog.
Academic Item Attribute	Enter an academic item attribute to further refine the selection criteria. The system uses this to select criteria against the academic item registry.
Value	When an Attribute is used, you can enter a Value—a prompt is available if the Academic Item Attribute has an Attribute Type of <i>LOV</i> , <i>Table</i> , or <i>Translate</i> .

Refer to the previous documentation for the Course Group Header page for descriptions of SQL Where Clause and Test.

Viewing Test Output

Access the Test Output page (**Curriculum Management > Academic Item Registry > Course Groups > Test Output**).

This example illustrates the fields and controls on the Test Output page. You can find definitions for the fields and controls later on this page.

Course Group Header		Course Group Detail		Test Output		Filters	
Academic Institution PeopleSoft University Course Group ID 000000018 Where Clause where INSTITUTION=:1 and ((CATALOG_NBR like '3____' and ACAD_GROUP='LBART') or (SUBJECT='MGMT' and CATALOG_NBR like '3____'))							
Personalize Find View All First 1-14 of 14 Last							
Subject / Catalog	Academic Item ID	Course ID	Offer Nbr	Description	Approved		
1 ECON 3001A	00000000414	666741	1	Microecon Policy Analysis I	Approved		
2 ECON 3001B	00000000415	666742	1	Microecon Policy Analysis II	Approved		
3 ECON 3002A	00000000416	666743	1	Macro Stabilization Policy I	Approved		
4 ECON 3002B	00000000417	666744	1	Macro Stabilization Policy II	Approved		
5 ECON 3003A	00000000421	666748	1	Technology and Growth I	Approved		
6 ECON 3003B	00000000429	666756	1	Technology and Growth II	Approved		
7 ECON 3012A	00000000423	666750	1	Mathematical Economics I	Approved		
8 ECON 3012B	00000000424	666751	1	Mathematical Economics II	Approved		
9 ECON 3020A	00000000419	666746	1	Dissertation I	Approved		
10 ECON 3020B	00000000420	666747	1	Dissertation II	Approved		
11 FINANCE 3071A	00000000447	666774	1	Financial and Risk Analysis I	Approved		
12 FINANCE 3071B	00000000448	666775	1	Financial and Risk Analysis II	Approved		
13 MGMT 3001A	00000000453	666780	1	Strategic HR Management I	Approved		
14 MGMT 3001B	00000000454	666781	1	Strategic HR Management II	Approved		

When you click the Test button on the Course Group Header or Course Group Detail page and click OK to view the results, you are transferred to the Test Output page where the results appear in a grid that you can scroll through (the Tools zoom feature is available).

Defining Filters

Access the Filters page (**Curriculum Management > Academic Item Registry > Course Groups > Filters**).

This example illustrates the fields and controls on the Filters page. You can find definitions for the fields and controls later on this page.

Course Group Header
Course Group Detail
Test Output
Filters

Academic Institution PeopleSoft University
 Course Group ID 00000018

Find | View All | First 1 of 1 Last

Effective Date 01/01/1900 Status Active + -

Description Liberal Arts Upper Division

SQL Where Clause where INSTITUTION=:1 and ((CATALOG_NBR like '3____' and ACAD_GROUP='LBART') or (SUBJECT='MGMT' and CATALOG_NBR like '3____'))

Automatically Execute

Select filters for student self service

- Subject
- Career
- Campus
- Academic Organization
- Academic Group
- Academic Item Attribute

Refresh

Matching values for selected filter fields:

Field / Attribute	Description
SUBJECT	Subject Area

Find View All (🔍) First 1-3 of 3 Last		
	Field Value	Description
1	ECON	Economics
2	FINANCE	Finance
3	MGMT	Management

Field / Attribute	Description
ACAD_GROUP	Academic Group

Find View All (🔍) First 1 of 1 Last		
	Field Value	Description
1	LBART	College of Liberal Arts

Field / Attribute	Description
INSTRUCTION LANGUAGE	Language of Instruction

Find View All (🔍) First 1-2 of 2 Last		
	Field Value	Description
1	ENGLISH	English
2	SPANISH	Spanish

Use this page to define a subset of the Course Group criteria fields as filters for use in Student Self Service. Because the filters are to be used only when a course group definition returns a large result set, the *Select filters for student self service* options are available only if the course group is *not* set up to automatically return results in the user interface (the Automatically Execute check box is not selected on the Course Group Header page).

<i>Field or Control</i>	<i>Description</i>
Select Filters for student self service	<p>The options are: Subject, Career, Campus, Academic Organization, Academic Group, Academic Item Attribute.</p> <p>If an option is selected, then when you save or refresh the page, the system creates a list of distinct values (with descriptions) for the filter field, using the entire result set for the Course Group. For example, if the result set for a Course Group is 100 courses and Subject and Academic Group are the filters, then a list of distinct Subject values and Academic Group values are displayed. Because the filter values are saved to the database, use the Refresh button if changes have been made to the filter options or if changes have occurred in the Course Catalog or Academic Item Registry that could have affected the result set.</p>
Matching values for selected filter fields:	<p>For each filter that is selected, a value field is generated with a Field/Attribute, Description format. This format accommodates the use of Common Attribute Framework based attributes. Only those attributes for which the Show in Student Self-service check box is selected on the Academic Item Registry page can be used as filters. For example, if the result set includes three distinct attributes but only one is set to Show in Student Self-service, then only that attribute is displayed in the filter results.</p> <p>See Using Item Attributes in AIR</p> <p>See “Using Program Enrollment Self-Service Features” (Campus Self Service)</p>

Copying Course Groups

When you add a new Course Group, two copy options are available on the Course Group Header page:

<i>Field or Control</i>	<i>Description</i>
Copy AA Course List	Copy an existing Academic Advisement course list that uses a Wild Card indicator. When you select this option, the copy process copies only those rows in the AA course list where the wild card indicator = Y.
Copy Course Group	Copy previously created course groups.

This is an example of the Course Group Header page with the two copy options.

The screenshot shows the 'Course Group Header' page with the following elements:

- Navigation Tabs:** Course Group Header (selected), Course Group Detail, Test Output, Filters.
- Academic Institution:** PeopleSoft University
- Course Group ID:** 000000000
- Buttons:** Copy AA Course List, Copy Course Group.
- Search Bar:** Find | View All | First 1 of 1 Last
- Filters:**
 - *Effective Date: 07/03/2013
 - *Status: Active
 - *Description: (empty text box)
 - [Report Description](#) (link)
- Checkbox:** Automatically Execute

<i>Field or Control</i>	<i>Description</i>
Copy AA Course List	<p>When you click the Copy AA Course List button:</p> <ul style="list-style-type: none"> You are transferred to the Copy Academic Advisement Course List look up page. You select a Course List for the Institution of the new Course Group. The Course List look-up prompts against a view of the Course List Detail table, for Course Lists that have a Wild Card Indicator (CLST_DETL_TBL where WILDCARD_IND = 'Y'). If the selected Course List has detail rows within it where the wild card indicator = N, those rows are not copied.
Copy Course Group	<p>When you click the Copy Course Group button:</p> <ul style="list-style-type: none"> You are transferred to the Copy Course Group look up page. You select a Course Group ID from a list of existing Course Groups for the Institution of the new Course Group. You are transferred back to the Course Group component and all eligible data is copied. You can then make adjustments as needed.

Setting Up for the Academic Progress Tracker

The program data that you define in the Academic Item Registry is ultimately stored at the student level in the Academic Progress Tracker (APT). The APT record for a student is keyed by an *instance* which also provides a link to the academic program of the student.

See [Understanding the Academic Progress Tracker](#)

This section discusses how to:

- Enable program enrollment.
- Map Campus Solutions academic programs, plans and subplans to AIR based programs of study.

Note: As of April 2012, the option to hold the APT Instance at the Academic Plan level is no longer available. The APT Instance is held at the Academic Program level only.

Pages Used to Set Up for the Academic Progress Tracker

<i>Page Name</i>	<i>Definition Name</i>	<i>Navigation</i>	<i>Usage</i>
Academic Institution 9	SSR_INST_PE	Set Up SACR > Foundation Tables > Academic Structure > Academic Institution Table > Academic Institution 9	Enable Program Enrollment.
Program Enrollment Mapping	SSR_PROG_PE	Set Up SACR > Foundation Tables > Academic Structure > Academic Program Table > Program Enrollment Mapping	Map Campus Solutions academic programs, plans and subplans to AIR based programs of study.

Enabling Program Enrollment

Your institution must enable Program Enrollment at the Academic Structure level in order to define academic program/plan/subplan mapping and to enable the tracking of an *APT instance* on the Admissions and Student Records program stacks.

See “Enabling Program Enrollment and Activity Management Defaults” (Campus Solutions Application Fundamentals)

Mapping Campus Solutions Academic Programs, Plans and SubPlans to AIR Based Programs of Study

Admission applications, admission, matriculation, and core student program management continue to use Campus Solutions academic program structures. Institutions that want to use AIR based programs for

tracking student programs and enrollment must map the Campus Solutions academic structure attributes of those offerings - the programs, plans, and subplans - to AIR program of study academic items. A mapping table is provided at the Academic Program Table level for this purpose.

Access the Program Enrollment Mapping page (**Set Up SACR > Foundation Tables > Academic Structure > Academic Program Table > Program Enrollment Mapping**).

This example illustrates the fields and controls on the Program Enrollment Mapping page. You can find definitions for the fields and controls later on this page.

Use this page to create rules that map an academic program and one or more plan combinations to AIR Program of Study academic items.

This page is available only if the Enable Program Enrollment check box is selected on the Academic Institution 9 page.

Academic Item Registry Mapping

<i>Field or Control</i>	<i>Description</i>
Group ID	Enter a number to be used as an identifier for a group of plans and subplans.
Default	Select this check box to indicate which Group ID is the default. When you select this check box, the Academic Plan/ Academic Sub-Plan grid is not available because the default is a catch-all for a program with any unmapped plan/subplan combination.

Field or Control	Description
Academic Plan	Enter one or more academic plans per Group ID.
Academic Sub-Plan	Enter one or more subplan values associated with the plan. You must enter a new row of Academic Plan for each subplan that you enter.
Approved Academic Load and Academic Item ID	Enter at least one Approved Academic Load value and one Academic Item ID value per Group ID.

Edits

A Plan cannot be used with a null subplan value and an actual subplan value within the same group. A combination like the following is invalid:

Group ID: *10*

- Academic Plan: *PSYCH*
- Academic Sub-Plan: *AI*
- Academic Plan: *PSYCH*
- Academic Sub-Plan: *null*

This mapping combination is not allowed because it is contradictory - with subplan equals *AI* and subplan equals *any plan*. This condition returns an error message for incorrect definition, referencing the group number.

Related Links

“Defining Academic Programs” (Campus Solutions Application Fundamentals)

“Defining Academic Plans” (Campus Solutions Application Fundamentals)

“Defining Academic Subplans” (Campus Solutions Application Fundamentals)

Setting Up APT Action Security

Use the APT Action Security page to determine the actions that a user can select on the APT Administrative Roster page, based on User ID security. For example, a user may be able to add a course academic item to a student’s Academic Progress Tracker (APT) but not remove it. Be careful when granting users access to APT actions such as remove items, because a user can remove planning nodes and even the program if no action has been taken on the item or any of its children.

Note: When setting up security for the APT Action *Add Item*, add the parent item as well as the academic item. For example, if you set up an APT Action *Add Item* for *Course* academic item and the course is to be added to a parent semester, you must also set up the APT Action *Add Item* for *Semester* academic item.

If security is not granted for a specific academic item and action, the user cannot select the academic item on the search pages and prompts on the APT Administrative Roster page.

See [Managing the APT Administrative Roster](#)

Page Used to Set Up APT Action Security

Page Name	Definition Name	Navigation	Usage
APT Action Security	SSR_APT_ACT_SCRTY	Set Up SACR > Security > Secure Student Administration > User ID > APT Action Security	Secure APT actions for the adding, removal, and substitution of academic items and result entry, calculation and evaluation.

Defining Security for APT Actions

Access the APT Action Security page (**Set Up SACR > Security > Secure Student Administration > User ID > APT Action Security**).

This example illustrates the fields and controls on the APT (Academic Progress Tracker) Action Security page. You can find definitions for the fields and controls later on this page.

APT Action Security

User ID: SR9878 Administrator,APT

*Academic Item Type		*APT Action	Access Code		
COURSE <input type="text" value="x"/>	Course	Add Item	Read/Write	+	-
COURSELIST	Course List	Add Item	Read/Write	+	-
COURSE	Course	Remove Item	Read/Write	+	-
COURSELIST	Course List	Remove Item	Read/Write	+	-
REQUIREMENT	Requirement	Remove Item	Read/Write	+	-
COURSE	Course	Create Substitution	Read/Write	+	-
COURSELIST	Course List	Create Substitution	Read/Write	+	-
COURSELIST	Course List	Enter Results	Read/Write	+	-
COURSE	Course	Enter Results	Read/Write	+	-
SEMESTER	Semester	Enter Results	Read/Write	+	-
YEAR	Year	Enter Results	Read/Write	+	-
SEMESTER	Semester	Enter APT Status	Read/Write	+	-
COURSE	Course	Enter APT Status	Read/Write	+	-
YEAR	Year	Enter APT Status	Read/Write	+	-
COURSELIST	Course List	Enter APT Status	Read/Write	+	-
COURSELIST	Course List	Calculate Results	Read/Write	+	-

Setting Up APT Reason Codes

Your institution can use the APT Reason Code Table page to set up reason codes to be used in the Academic Item Attempt Results section of the APT Items page. For example, a student may be granted a higher result and compensation due to ill-health or other mitigating circumstances; a result may be excluded due to plagiarism. You can set up reasons to be added to a specific result. A reason code can be stored for each result row in the APT Items page if required. You can also add the reason code when you enter results on the APT Administrative Roster page.

See [Managing APT Items](#)

See [Managing the APT Administrative Roster](#)

Page Used to Set Up APT Reason Codes

<i>Page Name</i>	<i>Definition Name</i>	<i>Navigation</i>	<i>Usage</i>
APT Reason Code Table	SSR_APT_RSN_TBL	Set Up SACR > Product Related > Student Records > Program Enrollment > APT Reason Code Table	Set up reason codes for Academic Item Attempt Results.

Defining APT Reason Codes

Access the APT Reason Code Table page (**Set Up SACR > Product Related > Student Records > Program Enrollment > APT Reason Code Table**).

This example illustrates the fields and controls on the APT Reason Code Table page.

APT Reason Code Table

Academic Institution: PSUNV PeopleSoft University

Reason Code: COMP

Find | View All First 1 of 1 Last

***Effective Date:** 01/01/1900 ***Status:** Active

Show in Student Self Service

***Description:** Result Compensation

Short Description: Comp

Long Description:

🔍 📄 📁 🔗 📧 📧 🔍 ↩ ➡ 🔗 🔗

📄 📄 📄 🌐 🌐 🌐

Format Font Size

B *I* U abc

☰ ☰ ☰ ☰ ☰ ☰ ☰ ☰ ☰ ☰ ☰ ☰ ☰

Student result compensated and higher mark authorized due to exceptional performance on the program to date.

<i>Field or Control</i>	<i>Description</i>
Show in Student Self Service	Planned for the future.

Using the Common Attribute Framework to Extend Class Associations for Program Enrollment

The Common Attribute Framework (CAF) can be used with Program Enrollment Self-Service to associate a student with specific sections of a class. There are two configuration options: Required Match and Filter Default. An example of a Required Match is where a student’s attribute value, e.g. Student Language French, matches only those classes with the same value. Filter Default automatically selects classes based

on the student’s attribute value, but students can deselect the filter and select another student language attribute value (for example, English). Institutions can define the values they want to use within the Common Attribute Framework to be able to associate students with specific classes.

Related Links

[Using the Common Attribute Framework to Extend Class Associations](#)

Setting Up Common Attribute Framework to Extend Class Associations for Program Enrollment

1. Add the common attributes you want to use to associate students with specific classes.
 - a. Go to **Set Up SACR > Common Definitions > Common Attribute Setup > Record Context**).
 - b. In Record (Table) Name, make sure you select *ACAD_PROG*.
 - c. In the Attributes region, specify the common attributes you want to use. The following images show examples of adding Student Language and Student Shift as the common attributes.

This example illustrates adding common attribute "Student Language" to filter classes.

The screenshot displays the 'Record Context' configuration interface. At the top, there are two tabs: 'Record Context' (selected) and 'Secondary Page Options'. A yellow button labeled 'Delete Record Context' is in the top right. The main form contains the following fields and options:

- Record (Table) Name:** ACAD_PROG
- *Description:** Student Program attributes
- *Attribute Record:** SSR_PROG_CAF (with a search icon and the text 'Student Program CAF table')
- Override Prompt Table:** (empty field with a search icon)
- Extend to staging record**
- Entity Name:** Attribute Student Program attr (with a search icon)
- Attribute Filter Class:** (empty field with a search icon)
- Attribute Display Type:**
 - Inline Subpage**
 - Secondary Page**
- Copy Attributes from:** (empty field with a search icon and a yellow 'Copy' button)
- Attributes Section:**
 - Find | View All | First | 1 of 2 | Last
 - *Attribute Sequence:** 1
 - Status:** Active (dropdown menu with '+' and '-' icons)
 - *Common Attribute:** STUDENT LANGUAGE (with a search icon and the text 'Student Language')
 - Required** **Repeatable**
 - Entity Associations:** (collapsible section)

This example illustrates adding common attribute "Shift" to filter classes.

Record Context

Secondary Page Options

Delete Record Context

Record (Table) Name: **System Data**

***Description:**

***Attribute Record:** Student Program CAF table

Override Prompt Table:

Extend to staging record

Entity Name:

Attribute Filter Class:

Attribute Display Type

Inline Subpage **Secondary Page**

Copy Attributes from

Attributes Find | View All First ◀ 2 of 2 ▶ Last

***Attribute Sequence:** **Status:**

***Common Attribute:** Student Shift

Required **Repeatable**

▶ **Entity Associations**

- d. Click Save.
- e. Access the Record Context page again (**Set Up SACR > Common Definitions > Common Attribute Setup > Record Context**).
- f. In Record (Table) Name, select *CLASS_ASSOC*.

This illustrates adding a common attribute to Record Name CLASS_ASSOC. You can find definitions for the fields and controls later on this page.

The screenshot displays the configuration interface for the CLASS_ASSOC record. It is divided into several sections:

- Record Context:** Includes fields for Record (Table) Name (CLASS_ASSOC), Description (CAF for CLASS_ASSOC Record), Attribute Record (SSR_ASSOC_CAF), and Entity Name (ClassAssocAttribute). A 'Delete Record Context' button is present.
- Secondary Page Options:** Includes an 'Extend to staging record' checkbox and an 'Attribute Filter Class' field.
- Attribute Display Type:** Radio buttons for 'Inline Subpage' (selected) and 'Secondary Page'.
- Copy Attributes from:** A search field and a 'Copy' button.
- Attributes:** A list of attributes with fields for *Attribute Sequence (1), *Common Attribute (STUDENT LANGUAGE), and checkboxes for Required and Repeatable (checked). A 'Status' dropdown is set to 'Active'.
- Entity Associations:** A table with one entry for *Entity Name.

- g. Add the same attributes you added to ACAD_PROG so that you can select these attributes on the Associated Class Attributes page (step 3), and then click Save.
2. Configure class search to use the common attribute.

This example illustrates configuring class search filters for program enrollment.

Class Search Profile SSAPT

Instructions

Show Class Result Instructions

Message Set Number Message Number

Message Text

Filters

Use Search Result Filters

Sequence Number	Use Common Attribute	Criteria	Common Attribute	Match		
1	<input checked="" type="checkbox"/>		Student Shift	Required Match	+	-
2	<input checked="" type="checkbox"/>		Student Language	Required Match	+	-

- Go to **Set Up SACR > Product Related > Student Records > Curriculum Management > Class Search Configuration**.
- In Class Search Profile, click **SSAPT**.
This profile allows you to match students to specific classes based on certain filters.
- Click **Class Result Options**.
- In the Filters group box, select *Use Search Filter Results* if there are a number of class attributes so that students can use these as filters when searching for classes.
- In the Filters group box, select *Use Common Attribute* to add the attributes you created.
- In the Match column, you can select:

Required Match, which requires an exact match on the Student Program and Class Association attributes. If there is only one class attribute that matches the Student Program attribute, the class section appears by default in My Schedule Builder. If there are multiple classes that match the Student Program attribute, then all classes are displayed. If you select *Use Search Results Filters* on the Class Result Options page, the student cannot deselect the filter for the attribute that is set as a 'Required Match' in My Schedule Builder. For example, there may be classes taught in French and Flemish. The Student Program attribute is 'Flemish'. In the class table, there are two Flemish courses and one French course. The student cannot deselect the matching language Flemish classes, but can view, and (optionally) select the other French class.

Filter Default, which does not require a match between the Student Program and Class Association attributes. For example, there may be multiple classes for the attribute Shift (Shift 1, Shift 2, and so on). The Student Program attribute is Shift 2. Because Filter Default does not require a match, the attribute for Shift 1 is also displayed and can be selected. Although Shift 2 is selected as the default (because it matches the Student Program value), the student can deselect

Shift 2 and then select Shift 1. The classes that appear in the search results are based on the initial default. It is also possible to select both attributes.

For more information about the Class Result Options page, see [Defining Class Search Result Options](#).

3. Link the attribute to classes:
 - a. Go to **Curriculum Management > Schedule of Classes > Maintain Schedule of Classes**.
 - b. Click Associated Class Attributes.
 - c. From the Associated Class Attributes region, add the attribute and assign a value.

This illustrates how to linking common attributes to a class.

Associated Class Attributes

Course ID:	666670	Course Offering Nbr: 1
Academic Institution:	PSUNV PeopleSoft University	Class Section: 2
Term:	0770 2016 Fall	Session: Regular
Subject Area:	ECON Economics	Associated Class: 2
Catalog Nbr:	3 Microeconomic Principles	

Associated Class Attributes Find First 1-2 of 2 Last

+ -

*Attribute Student Shift ▼

2 Second Shift

+ -

*Attribute Student Language ▼

FL Flemish

- d. When you are done adding attributes and assigning values, click OK.
 - e. If there are other sections to which you want to link attributes, go to the next section in the list, then repeat steps b to d.
 - f. Click Save.
4. Link the attributes and values to the student's Program/Plan record.
 - a. Go to **Records and Enrollment > Career and Program Information > Student Program/Plan**.
 - b. Click **Additional Information**.

This tab appears when you set up the attribute for the Record Name ACAD_PROG.
 - c. In the Program Data region, add a program attribute and assign a value.

d. Make sure you select **Show in Student SS**.

This example shows program attributes set for Student Shift = 2, and Student Language = FL.

This shows an example of linking common attributes to a student's program plan.

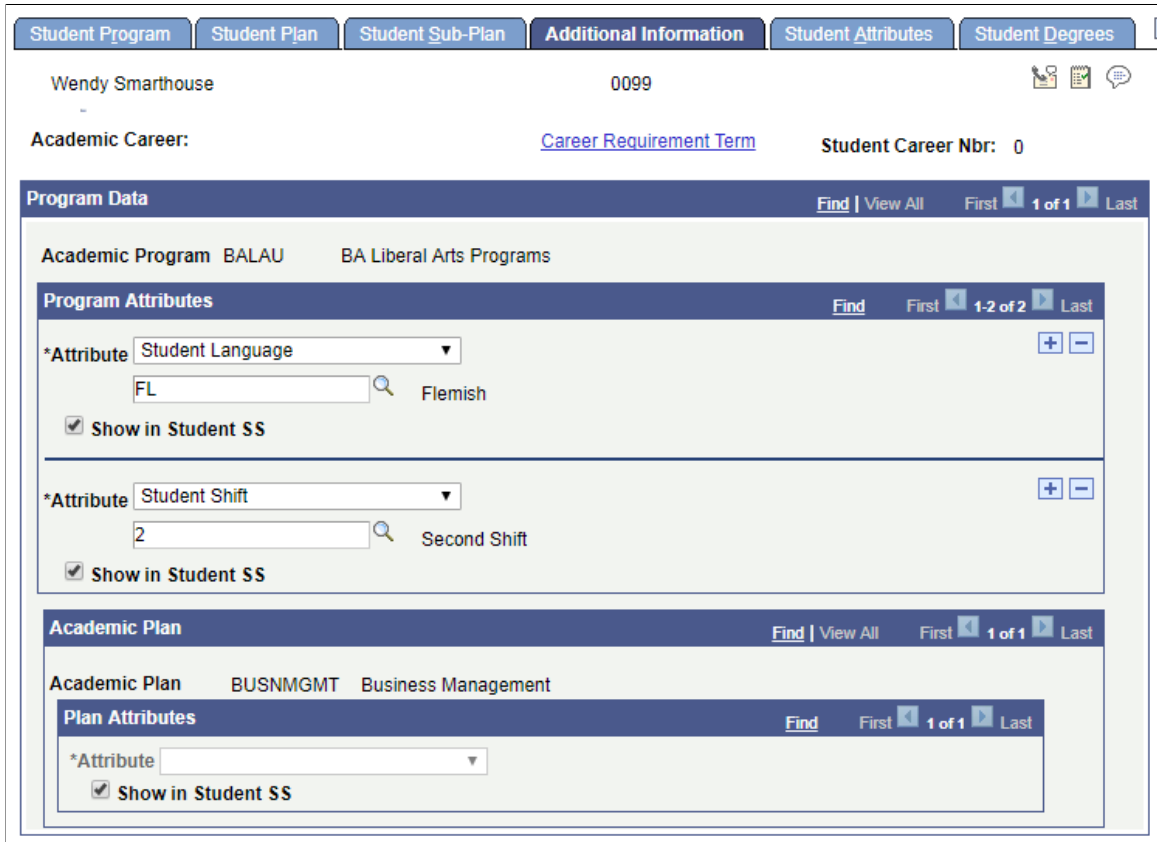

To check your setup, log in as a student:

1. Go to **Self Service > My Education Plan**.
2. Click Build Schedule.

The first example shows classes that have a 'Required Match'. The student cannot deselect the attribute that is required (Flemish). The classes initially displayed are based on the required attribute.

This illustrates an example of class search results when filtered by Student Language.

My Schedule Builder

Search Results

PeopleSoft University | 2016 Fall

● Open ■ Closed ▲ Wait List

[Return to My Schedule Builder](#)

2 class section(s) found

▼ ECON 2: Macroeconomic Principles

Class	Section	Days & Times	Room	Instructor	Meeting Dates	Status	
1862	2-LEC Regular	TBA	TBA	Staff	TBA	●	select
2875	3-LEC Regular	TBA	TBA	Staff	TBA	●	select

Apply Filter

Student Language

French (1)

Flemish (2)

If an attribute is set as ‘Filter Default’ on the Class Result Options page, a match is not required.

In the following example, a student may have a Student Program attribute of Shift with a value of Shift 2. Because this is not a required match, students can deselect the Shift 2 attribute and select Shift 1 or both.

This illustrates an example of class search results using a default filter.

My Schedule Builder

Search Results

PeopleSoft University | 2016 Fall

● Open ■ Closed ▲ Wait List

[Return to My Schedule Builder](#)

1 class section(s) found

▼ ECON 3: Microeconomic Principles

Class	Section	Days & Times	Room	Instructor	Meeting Dates	Status	
2874	2-LEC Regular	TBA	TBA	Staff	TBA	●	select

Apply Filter

Student Shift

First Shift (1)

Second Shift (1)

Student Language

Flemish (2)

Setting Up Instructor Workload

Understanding Instructor Workload

Higher-education institutions, particularly community colleges, need to set maximum limits on the workload that is assigned to faculty and other individuals. These institutions also need to track and report actual workload assignments. To accommodate these needs, Student Records has a feature called Instructor Workload, which performs full-time equivalency tracking.

The Instructor Workload feature enables you to monitor the instructional and non-instructional workload for selected faculty, instructors, and staff. This feature enables you to define workload limits for groups or individuals. In addition, you can define multiple types of instructional and non-instructional work assignments, using different workload standards for each type of assignment. You can have separate workload upper limits for part-time and full-time individuals and can set automated controls that prevent workload assignments beyond those limits.

If you use the Instructor Workload feature, the system automatically updates full-time equivalency workload values when you enter data on the class scheduling pages. You can also use a background process to copy workload data from one term to another, to update term workload records, or to produce a simple report.

Note: The term *instructor* predominates in this product documentation and in field names on pages, but it can include any individual with an employee ID at the institution. Advisors, teaching assistants, and even students can be tracked using this feature. This information is entirely user-defined.

The formulas described in the following sections are the two primary calculations that the Instructor Workload feature performs to update an individual's total term full-time equivalency percentage. Refer to these formulas for clarification when you are familiar with all of the setup pages.

Course Component Workload Hours Formula

The Instructor Workload feature uses the following formula to calculate the default workload hours of a course component on the Meetings page:

$$[(\text{academic progress units} \times \text{assigned percent}) + (\text{component workload hours} \times \text{assigned percentage})] \\ \times (\text{subject/component multiplier}) \times (\text{instructor term multiplier}) \times (\text{load factor})$$

Note: The system supplies the multiplier values to 100 percent by default if the user does not specify them.

At the academic institution level (Academic Institution 4 page), workload hours for courses are a combination of *academic progress units* and *component workload hours* (for example, 0 percent academic progress units and 100 percent component workload hours). Workload hours for noncourses are entered directly on the Term Workload page.

The Academic Subject Table has a *subject/component multiplier* specific to both the subject and component (for example, math laboratory component multiplier 80 percent, math lecture component 110 percent, math independent study component 50 percent, and so on).

The Term Workload page has an *instructor term multiplier* that is supplied by default from the Instructor Assignment Class table.

To divide one course component into more than one assignment, you can use a load factor. Inserting multiple rows per course component and assigning each one a load factor (percentage) enables you to divide a component into different assignment types, divide a component among instructors, or both. For example, you might assign instructor A to teach 30 percent of the lecture component, and instructor B to teach 70 percent of the lecture component. The user is responsible to set the load factor. The total load factor for one course component should equal 100 percent.

Note: You must manually enter workload hours for all assignments that are made directly on the Term Workload page. In other words, the system does not supply these types of manual noncourse-based assignments by default using the previous calculation.

In the following example, instructor A is sharing the teaching load for Math 200 with another instructor. This is why you set the load factor to 50 percent. This causes the default workload hours to change from 5 to 2.5 and the assignment full-time equivalency percent to change from 33.33 percent to 16.67 percent. Notice that instructor B, who is sharing the load with instructor A to teach Math 200, somehow earns an assigned full-time equivalent (FTE) of 33.33 percent. In addition, the default workload hours read 5, rather than 2.5, as they do for instructor A. This is because you assigned a multiplier of 200 percent to instructor B for this term. All class components to which you assign instructor B count double for this term. Also, notice that instructor A is supervising an independent study course, Physics 499. This subject and component are set to be multiplied by only 50 percent. This is so that whoever teaches physics with a component of independent study earns half credit for the task. Because of this, even though the component workload hours of 3 are 10 percent of the 100 percent weekly workload hours for this assignment type, the subject component multiplier halves this value so that the instructor earns an assigned FTE of 5 percent. This process also causes the default workload hours to differ from those set on the Class Associations - Class Components page (halved from 3 to 1.5).

Instructor	Assignment	Class Associations - Class Component Page: Workload Hours	Subject / Component Multiplier	Assignment Type / 100% Weekly Workload Hours	Load Factor	Meetings Page: Default Workload Hours	Assign FTE
Instructor A Term Multiplier = 100%	Math 200	5	Math Lecture/ 100%	RegLec/ 15	50%	2.5	16.67%
	Physics 201	5	Phys Lecture/ 100%	RegLec/15	100%	5	33.33%

<i>Instructor</i>	<i>Assignment</i>	<i>Class Associations</i> - <i>Class Component Page:</i> <i>Workload Hours</i>	<i>Subject / Component Multiplier</i>	<i>Assignment Type /</i> <i>100% Weekly Workload Hours</i>	<i>Load Factor</i>	<i>Meetings Page:</i> <i>Default Workload Hours</i>	<i>Assign FTE</i>
	Physics 499	3	Phys Ind Study/50%	IndStudy/30	100%	1.5	5%
							Total Term FTE% = 55%
Instructor B Term Multiplier = 200%	Math 200	5	Math Lecture/100%	RegLec/ 15	50%	5	33.33%
						Total Term FTE% = 33.33%	Total Term FTE% = 33.33%

Instructor Assignment Percentage Formulas

The Instructor Workload feature uses three formulas to calculate an individual's assignment full-time equivalency percentage. The system uses one of two formulas to calculate assignment FTE for regular classes and for open entry and open exit (OEE) classes. It uses another formula to calculate assignment FTE for assignments made directly to the Term Workload page.

Note: The Use Term/Session Weeks in Calc check box on the Academic Institution 4 page enables you to exclude the assigned number of weeks—in the session—and the total weeks in a term from the workload calculation formulas.

Regular Assignment FTE Formula

The system uses the following formula to calculate an individual's assignment full-time equivalency percentage for a regular scheduled class (non-OEE):

$$(\text{assignment workload hours} \times \text{assigned number of weeks} \times 100) / (100 \text{ percent weekly workload hours} \times \text{total weeks in term}).$$

<i>Term</i>	<i>Definition</i>
assignment workload hours	The number of workload hours that are assigned to the instructor.

Term	Definition
assigned number of weeks	The total number of weeks in the session for which the instructor is teaching. This number is derived from the session table.
100 percent weekly workload hours	The standard number of weekly hours that are required (for example, 15 hours). This number is derived from the assignment type table.
total weeks in term	Derived from the term/session table.

Open Entry and Open Exit Assignment FTE Formula

The system uses the following formula to calculate an individual's assignment full-time equivalency percentage for an OEE class:

$$(\text{assignment workload hours} \times \text{assigned number of weeks} \times 100) / (100 \text{ percent OEE workload hours} \times \text{total weeks in term})$$

Term	Definition
assignment workload hours	The number of workload hours that are assigned to the instructor.
assigned number of weeks	The total number of weeks in the session for which the instructor is teaching. This number is derived from the session table.
100 percent OEE workload hours	The standard number of term hours that are required (for example, 225 hours). This number is derived from the assignment type table.

The formula that the Instructor Workload feature uses to calculate an individual's assignment full-time equivalency percentage from an assignment that is made directly to the Term Workload page is:

$$(\text{assignment workload hours} \times 100) / (100 \text{ percent weekly workload hours})$$

Term	Definition
assignment workload hours	The number of workload hours that is assigned to the instructor.

Term	Definition
100 percent weekly workload hours	The standard that is required (for example, 15 hours). This number is derived from the assignment type table.

Examples of FTE Percent Formulas

The following example shows instructor C's assignments. The Biology 100 lecture is quite straightforward. Three workload hours, compared to a 100 percent weekly workload hours value of 15, result in the Biology 100 course totaling 20 percent of the instructor's workload (3 hours is 20 percent of 15 hours). The Biology 100 lab, however, is associated with an assignment type of *NotIncl/0* (do not include). This results in zero workload hours, therefore contributing no assignment FTE percentage.

In addition, instructor C teaches Biology 105 over the internet, with an assignment type of *Internet*. Notice that this assignment type has a 100 percent weekly workload hours value of 6, which means that 6 hours taught on the internet is 100 percent of an individual's workload. This course assignment creates an assignment FTE of 50 percent (3 hours is 50 percent of 6).

Finally, instructor C advises the Pre-Med Club. This assignment has a workload hours value of 9, which translates into 30 percent of the instructor's assignments (9 is 30 percent of 30).

Instructor D is a good example of how an individual can earn a total term FTE of 100 percent, while assigned only to advising (no class instruction). All types of assignments can contribute to total term FTE percentage.

Instructor E shows how OEE classes can effect FTE. This instructor teaches Psych (psychology) 210, with a workload hours value of 60. Because this section of Psych 210 is an OEE class, multiply the workload hours by the total weeks in the session, and then multiply by 100 ($60 \times 15 \times 100 = 90000$). Divide the result by the 100 percent OEE workload hours (225), times the total weeks in the session (15), and you get an FTE of 26.67 percent for this class.

Instructor	Assignment	Component	Class Component Workload Hours / OEE Workload Hours	Assign Type/ 100% Weekly Workload Hours or 100% OEE Wkld Hrs	Assignment FTE %
Instructor C	Biology 100	Lecture	3	RegLec/15	20%
	Biology 100	Laboratory	1	NotIncl/0	0
	Biology 105	Lecture (Internet)	3	Internet/6	50%

<i>Instructor</i>	<i>Assignment</i>	<i>Component</i>	<i>Class Component Workload Hours / OEE Workload Hours</i>	<i>Assign Type/ 100% Weekly Workload Hours or 100% OEE Wkld Hrs</i>	<i>Assignment FTE %</i>
	Advise Pre-Med Club	N/A	9	Student Club Advisor/ 30	30%
					Total Term FTE% = 100%
Instructor D	Advise Math Club	N/A	15	Student Club Advisor/ 30	50%
	Advise Math Honor Society	N/A	15	Student Club Advisor/ 30	50%
					Total Term FTE% = 100%
Instructor E	Psych 210	OEE Lecture	[60]	[RegLec/225 (15 weeks)]	26.67%
	Psych 378	OEE Lecture	[90]	[RegLec/225 (15 weeks)]	40%
	Psych 378	Lecture	3	RegLec/15	26.67%
	Advise Psych Club	N/A	1	Student Club Advisor/9	11.11%
					Total Term FTE% = 104.45%

Prerequisite for Setting Up Instructor Workload

Before you can track instructor workload, Student Records setup tables must be fully operational so that the faculty workload pages can retrieve complete and accurate data.

Related Links

[Student Records Integrations](#)

[Student Records Business Processes](#)

[Student Records Implementation](#)

Implementing Instructor Workload Setup Tables

To set up instructor workload, use the Assignment Type component (ASSIGNMENT_TYPE) and the Instructor Assignment Class component (INSTRUCTOR_CLASS).

Here is a high-level overview of how to set up instructor workload:

1. Create assignment types.
2. Create instructor assignment classes.
3. Activate the Instructor Workload feature by selecting the **Calculate Workload** check box and updating required fields.
4. Update Academic Subject table with component multiplier percentage.
5. Update the Course Catalog - Components page with workload hours, as necessary.
6. Adjust workload hours on the Class Components page, as necessary.
7. (Optional) Update the Term Workload page with instructor assignment class value and other data.

This task is optional because assignments that are made on the Meetings page automatically create a Term Workload record for the individual if none exists for the term that you are assigning. However, this process uses default values to specify a full-time equivalency percentage for the individual.

8. Schedule a new course, assign an instructor, and enter workload hours, if needed.
9. Update workload hours after you schedule a course or manually create a noncourse assignment on the Term Workload page.
10. Return to the Term Workload page so that you can view the instructor's updated workload.

Pages Used to Implement Instructor Workload Setup Tables

<i>Page Name</i>	<i>Definition Name</i>	<i>Navigation</i>	<i>Usage</i>
Assignment Type	ASSIGNMENT_TYPE	Curriculum Management > Instructor/Advisor Information > Assignment Type > Assignment Type	Establish new assignment type values that can be associated with course components or other noncourse-based instructor assignments.

Page Name	Definition Name	Navigation	Usage
Instructor Assignment Class	INSTRUCTOR_CLASS	Curriculum Management > Instructor/Advisor Information > Instructor Assignment Class > Instructor Assignment Class	<p>Establish new instructor assignment class values and defaults that the system can reference on both the Term Workload page and the Academic Institution 4 page.</p> <p>Enter an alphanumeric code (one to six characters in length) for the instructor assignment class. Each instructor assignment class value is associated with only one academic institution.</p>
Academic Institution 4	INSTITUTION_TABLE4	Set Up SACR > Foundation Tables > Academic Structure > Academic Institution Table > Academic Institution 4	<p>Activate the Instructor Workload feature to establish high-level limits, workload preferences, and default values for instructor workload at your institution.</p> <p>Before you access the Academic Institution page, create an assignment type and an instructor assignment class.</p>
Subject Workload	SUBJ_WORKLD_TBL	Set Up SACR > Foundation Tables > Academic Structure > Academic Subject Table > Subject Workload	Specify the weight of each component in each subject.
Components	CRSE_CATALOG_CMPNT	Curriculum Management > Course Catalog > Course Catalog > Components	Enter workload hour data that serve as a default value that the system uses to populate the same components on the Class Components page when you schedule a class.
Class Components	CLASS_ASSOC_CMPNT	Curriculum Management > Schedule of Classes > Adjust Class Associations > Class Components	Use the Workload Hours field to enter or update workload hours data for each scheduled class component of a course.

Creating Assignment Types

Access the Assignment Type page (**Curriculum Management > Instructor/Advisor Information > Assignment Type > Assignment Type**).

This example illustrates the fields and controls on the Assignment Type page. You can find definitions for the fields and controls later on this page.

Assignment Type

Find | View All
 First ◀ 1 of 1 ▶ Last

Assignment Type:	REG	+ -
Academic Institution:	PSUNV	PeopleSoft University
*Effective Date:	<input type="text" value="01/01/1900"/> <small>31</small>	*Status: <input type="text" value="Active"/>
*Description:	<input type="text" value="Regular"/>	
Short Description:	<input type="text" value="Regular"/>	
	<input checked="" type="checkbox"/> View on Schedule of Classes <input checked="" type="checkbox"/> Include Assignment in Workload	
100% Weekly Workload Hours:	<input type="text" value="15.00"/>	
100% OEE Workload Hours:	<input type="text" value="225.00"/>	

The assignment type affects how the system calculates the assignment full-time equivalency percentage when you assign an instructor to a course component (on the Meetings page) or to any other type of manual assignment (on the Term Workload page).

Note: To use the Instructor Workload feature, an Assignment Type with ASSIGN_TYPE = 'NON' must exist (hard-coded) for each academic institution in your database. This value is automatically created when you activate the feature on the Academic Institution 4 page. You cannot delete or inactivate these values for any academic institution for which you have activated the Instructor Workload feature.

Assignment types might include *standard lecture class*, *standard lecture Internet*, *standard lab*, *overload*, *unpaid*, *academic counseling*, *thesis supervision*, and so on. For example, a course that is taught on the internet might weigh differently than a course that is taught in a classroom. You can create different assignment types to represent this variation. In addition, some assignment types (such as academic counseling) might not be applicable for association with a course. In these instances, you can specify assignment type options that disable this value as a choice on the Meetings page.

Field or Control	Description
Effective Date	Enter an effective date for the assignment type value that you establish on this page. <hr/> Note: You can use only those assignment types with effective dates that are earlier than or equal to the effective date of the Academic Institution table as academic institution defaults on the Academic Institution 4 page. Assignment types with effective dates later than the effective date of the Academic Institution table can still be used throughout the system; they cannot be set up as academic institution default values.

Field or Control	Description
Status	<p>Select a status for the assignment type value. Select <i>Active</i> when adding a new assignment type. Select <i>Inactive</i> only if your institution no longer uses the listed values. In particular, you cannot inactivate assignment type values (set on the Academic Institution 4 page) that the system references. Values for this field are delivered with your system as translate values. Do not modify these values in any way. Any modifications to these values require a substantial programming effort.</p>
Short Description	<p>Enter the short description to associate with the assignment type value. This description appears in the grid on the Meetings page and on the Term Workload page. Be sure to use a short value that clearly describes the assignment type value. For example, you might want to describe an assignment type of Standard 15-Hour Assignment with a short description of <i>Std15</i>. In that case, the grid prompt value also appears as <i>Std15</i>. The short description is to the first ten characters of the description.</p>
View on Schedule of Classes	<p>Select if you want the assignment type to be an available drop-down choice on the Meetings page. This check box does not control whether the assignment type appears on the Schedule of Classes report; it just determines whether the assignment type can be associated with a course component. Leave this check box cleared if you do not want the assignment type available for pairing with components. For example, an assignment type of <i>academic counseling</i> or <i>student club advisor</i> might not be something that you want associated with a course component. It is an assignment type that is created specifically for use on the Term Workload page. In this case, do not select this check box. However, an assignment type of <i>In-person lecture</i> might be something that you want available on the Meetings page. In this case, do select this check box.</p>
Include Assignment in Workload	<p>Select if you want components with this assignment type to be included in the instructor's total term full-time equivalency percentage.</p>
100% Weekly Workload Hours	<p>Enter the 100 percent weekly workload hours value that specifies the normal weekly workload for this assignment type. This field enables you to assign different weekly full-time hours for different assignment types. For example, the standard class lecture full-time hours might be 15 per week, the standard internet lecture full-time hours might be 20 per week, and academic counseling full-time hours might be 35 per week.</p>

Field or Control	Description
100% OEE Workload Hours	If this assignment type can be affiliated with classes that are offered in an open entry and exit format, enter a 100 percent OEE workload hours value that represents the full-time load for an entire term. For example, if you have a 100 percent weekly workload hours value of 15 for this assignment type, you can multiply this value by the number of weeks in the term to which this assignment type belongs (100 percent weekly workload hours [15] × number of weeks in a term [15] = 100 percent OEE workload hours [225]).

Creating Instructor Assignment Classes

Access the Instructor Assignment Class page (**Curriculum Management > Instructor/Advisor Information > Instructor Assignment Class > Instructor Assignment Class**).

This example illustrates the fields and controls on the Instructor Assignment Class page. You can find definitions for the fields and controls later on this page.

Instructor Assignment Class

Find | View All
First ◀ 1 of 1 ▶ Last

Instructor Assignment Class: FULL + -

Academic Institution: PSUNV PeopleSoft University

***Effective Date:** 01/01/1900 BY ***Status:** Active ▼

***Description:** Full-time

***Full/Part Time:** Full-Time ▼

Calculate Workload:

Limit Workload:

***Assigned FTE %:** 120.00

***Instructor Multiplier %:** 100

Instructor assignment class values cluster different types of individuals with similar workload requirements. For individuals in a particular instructor assignment class, the default settings that you establish here can be modified on the Term Workload page.

Field or Control	Description
Effective Date	<p>Enter an effective date for the instructor assignment class that you establish on this page.</p> <hr/> <p>Note: Only those active instructor assignment classes with effective dates less than or equal to the effective date of the Academic Institution table can be used as academic institution defaults on the Academic Institution 4 page. Instructor assignment classes with effective dates greater than the effective date of the Academic Institution table can still be used throughout the system, but they cannot be set up as academic institution default values.</p> <hr/>
Status	<p>Select a status for the instructor assignment class. Select <i>Active</i> when adding a new instructor assignment class. Select <i>Inactive</i> only if your institution no longer uses the value listed. In particular, you cannot inactivate an instructor assignment class that the system references on the Academic Institution 4 page. Values for this field are delivered with your system as translate values. Do not modify these values in any way. Any modifications to these values require a substantial programming effort.</p>
Description	<p>Enter the description to associate with the instructor assignment class value. All alphanumeric characters are valid. This description appears in a related display on the Term Workload and Academic Institution 4 pages.</p>
Full/Part Time	<p>Select a full-time or part-time value to indicate the traditional status of instructors who are assigned to this instructor assignment class. The default is <i>Full-Time</i>. Values for this field are delivered with your system as translate values. Do not modify these values in any way. Any modifications to these values require a substantial programming effort.</p>
Calculate Workload	<p>Select to apply the Instructor Workload feature to instructors in this assignment class by default. This selection determines whether the system creates term detail records at all. This selection alone does <i>not</i> control whether the Instructor Workload feature produces a limit warning. You must select the Limit Workload check box in conjunction with this check box for warnings to appear. If you want to set up an instructor assignment class specifically for those instructors who never have load calculations performed, set up a separate instructor assignment class and do not select this check box. The value selected here is used to populate the Calculate Workload check box on the Term Workload page as a default value. You can change this setting on an individual and term-by-term basis on the Term Workload page.</p>

Field or Control	Description
Limit Workload	Select to apply the limits to instructors in this instructor assignment class by default. This feature controls whether the system produces error messages or warnings when assignments cause an individual's total term FTE percent to exceed either the individual's assigned FTE percent or the academic institution warning limits, whichever comes first. If you select the Calculate Workload check box, this check box is available. The value selected here is used to populate the Limit Workload check box on the Term Workload page as a default value. You can change this setting on an individual and term-by-term basis on the Term Workload page.
Assigned FTE % (assigned full-time equivalent percent)	Enter the assigned FTE percentage to indicate the traditional assignment of instructors assigned to this instructor assignment class. This value represents the percentage of the institution-wide standard to assign to instructors in this class. For example, a field value of <i>100.00</i> enables you to make assignments for instructors in this instructor assignment class up to a total term FTE percent of 100. If you want to hold instructors in this instructor assignment class to only 80 percent of the institution-wide standard, then you might set the value to <i>80.00</i> . Finally, if you often overbook full-time instructors in a particular instructor assignment class (perhaps to ultimately drop them from an assignment at the beginning of the term), then you might want to set this value to <i>120.00</i> . This field's default value corresponds to the full-time and part-time value that you select. The value entered here is used to populate the Term Workload page as a default value for individuals in this instructor assignment class. You can change this setting on an individual and term-by-term basis on the Term Workload page.
Instructor Multiplier %	Enter the instructor multiplier percent to associate with this instructor assignment class. This value contributes to the default workload hours formula for courses that are assigned on the Meetings page for individuals in this instructor assignment class. For example, if you want to give a certain group of instructors double credit for the course components to which they are assigned, set this value to <i>200</i> . However, if you want instructors to get only half credit for their course assignments, you might assign them to a different instructor assignment class with this field set to <i>50</i> . This multiplier does not apply to noncourse-based assignments that are made directly to the Term Workload page. By default, this field displays <i>100</i> when you are in Add mode. The value that is entered here is used to populate the Term Workload page as a default value. You can change this setting on an individual and term-by-term basis on the Term Workload page.

Defining Instructor Workload Preferences for Your Institution

Access the Academic Institution 4 page (**Set Up SACR > Foundation Tables > Academic Structure > Academic Institution Table > Academic Institution 4**).

This example illustrates the fields and controls on the Academic Institution 4 page. You can find definitions for the fields and controls later on this page.

<i>Field or Control</i>	<i>Description</i>
Calculate Workload	Select to activate the workload feature for your institution and to display related fields. Before you select this check box, you may want to insert a new effective-dated row on the Academic Institution 1 page.
Full-Time Warning Limit %	Enter the full-time warning limit percent for the Instructor Workload feature to reference at all times across the institution. This value indicates the institution-wide setting for those individuals who are assigned to an instructor class that is <i>full-time</i> . If an assignment is made that causes a full-time individual's total term FTE percentage to exceed this value, the system issues a soft warning. The system produces the soft warning only if the individual's Limit Workload check box is selected on the Term Workload page.
Part-Time Warning Limit %	Enter the part-time warning limit percent for the Instructor Workload feature to reference at all times across the academic institution. This value indicates the institution-wide setting for those individuals who are assigned to an instructor class that is <i>part-time</i> . If an assignment is made which causes a part-time individual's total term FTE percentage to exceed this value, a soft warning is issued. The system issues the warning only if the individual's Limit Workload check box is selected on the Term Workload page.

Field or Control	Description
Use Term/Session Weeks in Calc (use term/session weeks in calculation)	Select this check box to include the assigned number of weeks—in the session—and the total weeks in the term within the workload assignment FTE calculation. Clear this check box to exclude the assigned number of weeks—in the session—and the total weeks in the term within the workload assignment FTE calculation.

Choosing How to Sum Workload Hours

Field or Control	Description
Course Component Workload Hrs% (course component workload hours percent)	Enter a percentage to specify your institution standard for compiling course workload. For example, you might want to calculate workload hours based solely on the defined workload hours that are associated with the course component. In this instance, set the Course Component Workload Hrs% field to <i>100</i> and the Academic Progress Units % field to <i>0</i> (or leave the second field cleared). When these two fields are set this way, any time that you assign an instructor to teach a course component at the specified academic institution, the course component workload hours calculation uses only the course component workload hours value (and not the progress units) for the course. In addition, if you want to sum workload hours based on both fields, you can do this by setting each of the fields to the appropriate percentages. In this instance, ensure that the two values total 100.

Field or Control	Description
Academic Progress Units %	<p>Enter a percentage to specify your institution standard for compiling course workload. For example, you might want to calculate workload hours at your institution based solely on the academic progress units that are associated with the course component. In this instance, set the Course Component Workload Hrs% field to 0 (or leave this second field cleared) and the Academic Progress Units % field to 100. When these two fields are set this way, any time that you assign an instructor to teach a course component at the specified academic institution, the course component workload hours calculation uses only the academic progress units for the overall course as set on the Class Associations page (and not the course component workload hours). This causes any component of the course (lecture, laboratory, and so on) to be calculated based on the academic progress units for the overall course as set on the Class Associations page. In addition, if you want to sum workload hours based on both fields, you can do this by setting each of the fields to the appropriate percentages. In this instance, ensure that the two values total 100.</p> <hr/> <p>Note: The preceding field values apply only to assignments that are made on the Meetings page. Although not required by the system, these two fields should total 100.</p> <hr/> <p>Note: Workload hours for assignments (which are not course-based) that are made directly to the Term Workload page do not reference either the Course Component Workload Hrs % or Academic Progress Units % fields. Instead, the user enters the assignment workload hours manually. For example, an assignment that is made directly to the Term Workload page for <i>advising the math club</i> might have a manually assigned workload entry of 3 to represent the number of hours per week that this assignment requires.</p> <hr/>

Assigning Workload Hours to Courses and Class Components

Workload for courses can comprise academic progress units and course component workload hours. If your Academic Institution 4 page setting specifies that some percentage (1-100) of workload comprises course component workload hours, specify course workload hours in the course catalog. In addition, you might want to specify or update these hours for each component on the Class Associations - Class Components page.

Specifying Default Values for Your Institution

Field or Control	Description
Full-Time Assigned FTE % (full-time assigned full-time equivalent percent)	Enter the full-time assigned FTE percent to appear in the Assigned FTE % field on the Instructor Assignment Class page when a value of <i>Full-Time</i> is selected for the Full/Part Time field on that page. This is only a default value, and you can change it on the Instructor Assignment Class page.
Part-Time Assigned FTE % (part-time assigned full-time equivalent percent)	Enter the part-time assigned FTE percent to appear in the Assigned FTE % field on the Instructor Assignment Class page when a value of <i>Part-Time</i> is selected for the Full/Part Time field on that page. This is only a default value, and you can change it on the Instructor Assignment Class page.
Assignment Type	Enter the assignment type to appear on the Meetings page each time that the system assigns a course component. This setting is only a default value, and you can change it on the Meetings page.
Instructor Assignment Class	Enter the instructor assignment class to appear on the Term Workload page. This setting is only a default value, and you can change it on a case-by-case basis on the Term Workload page.

Note: You cannot inactivate or delete the assignment type and instructor assignment class that are referenced on the Academic Institution 4 page.

Related Links

“Defining Academic Institutions” (Campus Solutions Application Fundamentals)

Defining Subject and Component Multipliers

Access the Subject Workload page (**Set Up SACR > Foundation Tables > Academic Structure > Academic Subject Table > Subject Workload**).

This example illustrates the fields and controls on the Subject Workload page. You can find definitions for the fields and controls later on this page.

The screenshot shows the 'Subject Workload' page with the following details:

- Academic Institution:** PSUNV PeopleSoft University
- Subject Area:** PHYSICS Physics
- Effective Date:** 01/01/1900
- Status:** Active
- Course Component 1:** Lecture, *Component Multiplier %: 100
- Course Component 2:** Ind Study, *Component Multiplier %: 50
- Course Component 3:** Laboratory, *Component Multiplier %: 75

The system uses these values as part of the course component workload hours formula to calculate the assignment FTE percentage on the Meetings page. You do not need to enter values for course components that are multiplied by 100 percent.

Field or Control	Description
<p>Course Component</p>	<p>Select a course component to associate with courses in the academic institution and subject area that you specify. Values for this field are delivered with your system as translate values. You can modify these values. The course component value indicates the parts of the course offering, for example, <i>Lecture</i>, <i>Laboratory</i>, <i>Ind Study</i> (independent study), and so on.</p> <p>One subject area can have multiple components.</p> <p>See Defining Course Components.</p>
<p>Component Multiplier %</p>	<p>Enter a component multiplier percentage value that represents the weight of this type of component. By default, this field displays <i>100</i>. The system uses this value as part of the course component workload hours formula to calculate default workload hours on the Meetings page. You do not need to enter values for course components that are multiplied by 100 percent unless you prefer to store this data for documentation.</p> <p>As noted in the workload hours formula, multiplier values are 100 percent by default if they are not found.</p> <p>See Course Component Workload Hours Formula.</p>

Linking Workload Hours to Courses

You can use the **Workload Hours** field and the **OEE Workload Hours** (open entry and exit workload hours) field on the Course Catalog - Components page to enter workload hour data. The value that

you specify in each of these fields serves as a default value that the system uses to populate the same components on the Class Components page when you schedule a class. In other words, if you set the lecture **Workload Hours** field to 3 on the Course Catalog - Component page, then whenever you schedule a lecture for this course, the lecture component **Workload Hours** field has a default value of 3 workload hours on the Class Components page for this component. Similarly, if you set the lecture **OEE Workload Hours** (open entry and exit workload hours) field to 45 on the Course Catalog - Component page, then whenever you schedule a lecture for this course in an open entry and open exit session, the lecture component **OEE Workload Hours** (open entry and exit workload hours) field has a default value of 45 workload hours on the Class Components page. If necessary, you should modify the component values on the Class Components page.

Related Links

[Defining Course Components](#)

Linking Workload Hours to Class Components

Use the **Workload Hours** field on the Class Associations - Class Components page to enter or update workload hours data for each scheduled class component of a course.

Related Links

[Modifying Class Components](#)

Chapter 9

Setting Up Transfer Credit Processing

Understanding the Transfer Credit Business Process

This section lists prerequisites and discusses the transfer credit business process.

Prerequisites

Before you set up transfer credit rules and process transfer credit, complete all other setup for Student Records. You must define academic careers, academic programs, academic plans, the course catalog, grading bases, terms, and sessions. It is helpful to write out the rules for accepting transfer credit before you enter the rules in the system.

Transfer Credit Business Process

Setting up the Transfer Credit feature is complicated but can save you a lot of time in the future.

Setting up for processing transfer credit involves defining the external organizations from which you accept transfer credit and defining all of the subject areas and courses that the external organization can transfer. A key aid to completing the setup for the Transfer Credit feature is to point any external organization or internal institution to any other external organization's or internal institution's catalog of courses. It is thus possible to create one group of external courses that a number of external organizations share. Sharing course information saves time because you do not have to duplicate your data entry effort if one or more organizations have the same or similar courses. It is especially helpful when dealing with a large transfer population from schools where courses are virtually the same or catalogs are shared. For instance, if your academic institution receives many transfer students from a state college system, you can create one catalog of external courses for the state college system where all state colleges in that system can point to for these courses.

Transfer equivalency rules that you create are the foundation of the Transfer Credit process. After you define external organizations, you create equivalency rules for courses and tests, then attach these equivalency rules to specific academic programs and academic plans. You also attach an equivalency rule to an external organization or internal institution.

After you complete the setup, you are ready to process transfer credit. Transfer credit processing is based on a concept of modeling various scenarios of transfer credit articulation. You set up model scenarios for an individual, dependent on the individual's chosen academic program and plan to demonstrate different options of transferring credit. Based on your setup, you have the ability to model as many transfer credit scenarios as you want for prospects, applicants, and current students. You also have the flexibility to articulate models based on predefined rules or rules that you create manually.

Important! Much of this organizational setup is shared with PeopleSoft Campus Community and PeopleSoft Recruiting and Admissions. Therefore, you should coordinate your efforts.

Defining External Organizations

Before you can use transfer credit processing, use the Organization Table (ORGANIZATIONS) component to define external organizations. As you define external organizations, specify their locations, contacts, departments, and characteristics. Also, specify whether the organization is a vendor.

As part of the external organization setup within this component, transfer credit processing requires that you:

- Select the **Offers Courses** check box on the School Data page in the Organization School Data (SCC_EXT_ORG_ADM) component to identify the external organization as one that offers courses.

You can also access this page via a link on the Organization Table page. This page enables you to create external courses to be used in transfer credit articulation rules.

- Enter the data that applies to the external organizations that offer courses on the School Data page.

When forming transfer credit rules, the system uses the values that you define for the external organization in the **Career**, **Term Type**, and **Unit Type** fields and the **Catalog Information** group box as system default values. Furthermore, if you indicate that an external organization has a shared catalog with another external organization, the system uses the catalog organization that you specify as the default value on the Course Transfer Rule page.

Defining external organizations functionality is shared with Campus Community and Recruiting and Admissions.

Related Links

“Understanding Organizations” (Campus Community Fundamentals)

“Creating Organization Records” (Campus Community Fundamentals)

Setting Up External Subjects

You define subject categories for external organizations on the External Subject Table page. Then, you link these subjects to external organizations and the courses they offer. The subject area that you enter on the External Subject Table page can be tied to specific external organizations on the School Subject Maintenance page. For every external organization from which you anticipate receiving academic work for transfer articulation, define all subject areas on this page.

Related Links

“Entering Codes for External Organizations” (Campus Community Fundamentals)

Setting Up External School Subjects

To set up external school subjects, use the School Subject Maintenance (SCHOOL_SUBJECTS) component.

This section discusses how to link external subjects to external organizations.

Page Used to Set Up External School Subjects

<i>Page Name</i>	<i>Definition Name</i>	<i>Navigation</i>	<i>Usage</i>
School Subject Maintenance	SCHOOL_SUBJECTS	Set Up SACR > Common Definitions > External Education > School Subject Maintenance > School Subject Maintenance	Link external subjects to specific external organizations, specifying the subject areas that your institution accepts as transfer credit from the external organization. You use these subject areas to build external courses.

Linking External Subjects to External Organizations

Access the School Subject Maintenance page (**Set Up SACR > Common Definitions > External Education > School Subject Maintenance > School Subject Maintenance**).

Important! The catalog of courses for one external organization can be used by multiple institutions. Plan carefully before you use this page to enter every subject area for every institution from which you might receive transfer credit.

<i>Field or Control</i>	<i>Description</i>
School Subject	Enter a school subject for the external organization. This field contains no edits and, thus, enables you to enter any value. Only the values in the prompt box display a description.
External Subject Area	Enter the external subject area that corresponds to the school subject. This field is useful when an external organization has a number of school subjects that are the same but have different names, such as <i>ENGL</i> and <i>English</i> . You can associate both school subjects with each other, for example, by tying each school subject to the external subject area of <i>ENGL</i> .

Entering External Courses

To set up external courses, use the School Course Classification (SCHOOL_COURSES) component.

This section discusses how to record external courses.

Page Used to Enter External Courses

<i>Page Name</i>	<i>Definition Name</i>	<i>Navigation</i>	<i>Usage</i>
School Course Classification	SCHOOL_COURSES	Set Up SACR > Common Definitions > External Education > School Course Classification > School Course Classification	Record the specific course offerings for each subject area of an external organization. You use these course classifications when you create course transfer rules.

Recording External Courses

Access the School Course Classification page ((**Set Up SACR > Common Definitions > External Education > School Course Classification > School Course Classification**)).

This example illustrates the fields and controls on the School Course Classification page. You can find definitions for the fields and controls later on this page.

School Course Classification

Org ID: 000010133 Cornell College

School Subject: ENGL

School Course Number Find | View All First 1 of 1 Last

*School Course Number: 210

School Course Details Find First 1 of 1 Last

*Effective Date: 01/01/1990 *Status: Active

*Description: English Literature to 1800

Short Description: Lit 1800

*External Subject Area: ENGL English

*Career: Undergrad

External Course Type: Course Course Level: Regular

External Units: 3.00

Note: If you want to inactivate an external course, you must enter a status of inactive *and* remove the external course from your course equivalency rules.

<i>Field or Control</i>	<i>Description</i>
School Course Number	Enter the course number at the specified external organization for the course that you are classifying. This value is usually the catalog number of the external course.
External Subject Area	Enter the external subject area for this course at the specified external organization. This field is where school subjects that are the same but have different names can both be represented by the single external subject area that you enter.

Field or Control	Description
Career	Enter the career for this course at the specified external organization. Values for this field are delivered with your system as translate values. You can modify these values.
External Course Type	Enter the external course type for this course at the specified external organization. Values for this field are delivered with your system as translate values. You can modify these values.
Course Level	Enter the level for this course at the specified external organization. Values for this field are delivered with your system as translate values. You can modify these values.
External Units	Enter the number of external units that this course is worth at the specified external organization.

Note: External courses are converted to the unit type of your academic institution based on the rules on the External Term Table page.

Setting Up External Terms

Define external terms on the External Term page. When tracking information about external institutions for a prospect, applicant, or student, you may want to know the specific term to which that information is related. For example, if you are entering external transfer credit information, you want to record the term to which the transfer credit information pertains. Because external institutions use various term structures, use this page to define all external terms. You can also set up how you want external terms converted to your term structure on this page.

Note: The system uses the conversion multipliers on the Unit Conversion Table page when calculating internal transfer credit (for instance, transferring between academic careers).

Related Links

“Entering Codes for External Organizations” (Campus Community Fundamentals)

Setting Up Test and Component Information

To create test credit transfer rules, define your test components and test codes:

- Use the Test Component page to set up test components used in your rules for test credit equivalencies.

Example test components include English Composition and Essay, German Language and Listening, and so forth.

- Use the Test Tables page to set up test codes and to link test components to them.

Note: Minimum scores are also defined for test transfer equivalency rules.

Related Links

“Understanding External Test Score Data Processing” (Recruiting and Admissions)

Setting Transcript and Statistics Defaults

Use the Organization Affiliation page to enter details about the affiliation of your institution with specific external organizations. The only relevant fields for transfer credit processing that contain the default values for printed transcripts are in the **Transfer Credit Transcript Print** group box on this page. You can override the default values for specific transcript types on the Transfer/Test/Other Credits page of the Transcript Type (TSCRPT_TYPE) component.

<i>Field or Control</i>	<i>Description</i>
Level of Detail	<p>Enter a value to indicate the transfer credit level of detail to print on transcripts for a student transferring credit from this external organization:</p> <p><i>Summary:</i> Enter this value to print a student's total transferred units and grade point average (GPA) from this external organization on the student's transcript. Enter this value if you use the Historical Course Enrollment page for your conversion process.</p> <p><i>Detail:</i> Enter this value to print what you selected in the Details to Print field.</p>
Details to Print	<p>If you enter <i>Detail</i> in the Level of Detail field, use this field to enter the details to print on the transcript: <i>None, External Courses, External and Internal, or Internal Equivalent Courses.</i></p>
Include Transfer Credit in GPA	<p>Select this check box if you want the transfer credit from this organization to be included in the student's GPA. If you clear this check box, the system does not include transfer credit grade points in the student's GPA.</p>

Related Links

“Entering Affiliations with Organizations” (Campus Community Fundamentals)

Making Overall Statistics Adjustments

Use the Terms in Residence page to modify a student's terms in residence or to adjust transfer credit values.

Related Links

[Maintaining a Student's Terms in Residence](#)

Defining Study Agreements

To set up study agreements, use the Student Agreement Table (STUDY_AGREEMNT_TBL) component.

You can attach study agreements to individual student records on the External Study page of the Term Activation (STDNT_ACTIVATION) component. Study agreement codes are normally used to represent study abroad, exchange, and visiting programs.

This section lists the page used to define study agreements.

Page Used to Define Study Agreements

<i>Page Name</i>	<i>Definition Name</i>	<i>Navigation</i>	<i>Usage</i>
Study Agreement Table	STUDY_AGREEMNT_TBL	Set Up SACR > Common Definitions > Study Agreement Table > Study Agreement Table	Create study agreements for use with external organizations.

Creating Course Transfer Equivalency Rules

To set up course transfer equivalency rules, use the Transfer Subject Area (TRNSFR_SUBJ_AREA) component and the Course Transfer Rules (TRNSFR_RULE) component.

This section provides an overview of course transfer equivalency rules and discusses how to:

- Define component subject areas.
- Define subject area elements.
- Review and adjust incoming course information.
- Define course transfer rules.

Understanding Course Transfer Equivalency Rules

After you set up all of the tables discussed in the previous topics, you can begin to create your course transfer equivalency rules. The Transfer Credit process enables you to articulate course credit manually or with predefined course transfer equivalency rules. Most likely, you will create predefined rules for external organizations or internal academic institutions from which you receive the majority of your transfer students. You can create manual rules for those organizations from which you infrequently receive transfer students.

In this section, we review how to create the predefined course equivalency transfer rules for modeling transfer articulations for a prospect, applicant, or student. An equivalency rule is attached to an external organization or internal academic institution and can contain numerous transfer components. You might even decide to define more than one course transfer equivalency rule for an external organization or internal academic institution to account for academic program and academic plan differences in articulation rules.

The term *component* is used in documentation about the Transfer Credit process and should be distinguished from the same term used in PeopleSoft PeopleTools, where it refers to a page or a group of pages under a menu item. In the Transfer Credit feature, a component ties each incoming course and its internal equivalents together. Thus, for each incoming course and its matched equivalent, a corresponding component exists. Together, these data elements represent a line or sequence within the overall course transfer rule. Thus, a course transfer rule is generally made up of hundreds, possibly thousands, of components, each of which contains a number of data elements, including the transfer priority number, the incoming courses, and the internal equivalents. For simplicity, we refer to components related to transfer credit as *transfer components*.

To manage this large volume of transfer components, group them into distinct component subject areas for each external organization or internal academic institution by using the Transfer Subject Area component. Because component subject areas are user-defined and not enforced by the Subject table of your academic institution, you can define a component subject area with a value that you can later associate with a given course transfer equivalency rule. For example, you can create a component subject area called Mathematics for an external organization and define all of the incoming math and statistics courses and their internal equivalent courses within this component subject area. Alternatively, you can define one component subject area for math courses and one component subject area for statistics courses.

After you define component subject areas, use the Course Transfer Rules component to assign component subject areas to the course transfer rules that you create for each external organization or internal academic institution.

The system stores the data for each component subject area in intermediary tables (TRNSFR_RULE and TRNSFR_RSUB) that are independent of the course-transfer equivalency rule tables (TRNSFR_SUBJ, TRNSFR_COMP, TRNSFR_FROM, TRNSFR_TO). All of these tables are associated with each other through parent-and-child relationships in the table structure.

Articulating Variable Unit Courses

To ease the articulation of variable unit courses, Campus Solutions can determine transfer unit values in one of three ways:

1. By the units of the internal equivalent course as they appear in the course catalog.
2. By a fixed value, determined by the institution.
3. By the units of the incoming course, whether a set or variable value, with the option of setting a maximum limit.

Rather than having the transfer model determine the transfer units for an incoming course based on the units of the internal equivalent course in the course catalog as they appeared at the time that you set up the transfer rule, which can cause the system to get out of synchronization, you can determine the units by the internal equivalent course or by a fixed value. See the examples at the end of this section for more information.

Excess Credit Courses

You can award excess credit to a specified course. For example, if a student took MATH 1A for four units, but the internal equivalent was only worth three units, then you can set up an excess credit course and award the excess units to that course. See the examples at the end of this section for more information.

Note: The PeopleSoft Academic Advisement application treats the excess credit course as another transfer course, bringing in the course ID, grade, and requirement designation as it does for the internal equivalent course. Like the internal equivalent, the excess credit course is also coded as "TR" on the degree audit. If your business practice is to use one particular course ID to collect excess credit for a variety of incoming courses, be aware that each instance of the course will appear on the advising report.

Transfer Status: Rejected

The system automatically rejects courses for any of these reasons:

- The **Transfer Course** check box is cleared on the Subject Area Elements page for the applicable rule.
- The enrollment date of the incoming course is not entered or the system is unable to calculate it.

When no date is entered, the system automatically calculates a date like this:

- If no term year is entered, the system uses the year 1900 as the year that the class was taken.
- If no external term is entered, the system uses January 1 as the month and day that the class was taken.
- If an external term is entered without a term year, the system finds the appropriate month from the external term table (for instance, fall may be month 8) and calculates the rest.

In this instance, the date that the class was taken would be August 1, 1900.

- The official grade is blank.

Related Links

[Understanding Transfer Credit Processing](#)

Pages Used to Create Course Transfer Equivalency Rules

<i>Page Name</i>	<i>Definition Name</i>	<i>Navigation</i>	<i>Usage</i>
Transfer Subject Area	TRNSFR_SUBJECT	Records and Enrollment > Transfer Credit Rules > Transfer Subject Area > Transfer Subject Area	Describe component subject areas for a transfer credit source, otherwise known as an external organization or internal academic institution. Also set up incoming course default information for the transfer components that you define within this component subject area. The system applies these defaults to each incoming course that you specify on the Subject Area Elements page of this component.
Subject Area Elements	TRNSFR_DETAIL	Records and Enrollment > Transfer Credit Rules > Transfer Subject Area > Subject Area Elements	Define the transfer components of the component subject area.
Incoming Course Information	TRNSFR_FR_SEC	Click the Incoming Course Information link on the Subject Area Elements page.	Adjust the default information for a particular incoming course within the component subject area. Default information for incoming courses of a particular component subject area is defined on the Transfer Subject Area page.
Course Transfer Rules	TRNSFR_RULE	Records and Enrollment > Transfer Credit Rules > Course Transfer Rules > Course Transfer Rules	Define course transfer equivalency rules for external organizations or internal academic institutions.

Defining Component Subject Areas

Access the Transfer Subject Area page (**Records and Enrollment** > **Transfer Credit Rules** > **Transfer Subject Area** > **Transfer Subject Area**).

This example illustrates the fields and controls on the Transfer Subject Area page. You can find definitions for the fields and controls later on this page.

Transfer Subject Area
Subject Area Elements

Academic Institution: PSUNV PeopleSoft University
Source ID: 000010143 Fresno City College
Component Subject Area: FCC-ENGLISH

Find | View All First ◀ 1 of 1 ▶ Last

Effective Date: **Status:** Active

Description:

Catalog Org Type:

Catalog Organization: Fresno City College

Component Defaults

Min / Max Units: **Term Type:**

Min / Max Grade Pts per Unit:

Internal Equiv Course Value:

Excess Credit Defaults

Course ID:

Requirement Designation:

General Fields

<i>Field or Control</i>	<i>Description</i>
Catalog Org Type (catalog organization type)	Designates the table from which you select a catalog organization for the component subject area of the specified source. <i>External:</i> The system prompts you with external organizations in your system. Define external organizations on the Organization Table page. <i>Internal:</i> The system prompts you with academic institutions in your system. Define academic institutions on the Academic Institution Table page.

Field or Control	Description
Catalog Organization	<p>Enter the catalog organization for this component subject area of the specified source. By default, the system displays the specified source as the catalog organization, but you can override this value. The system prompts you with values based on the value that you entered in the Catalog Org Type field. When defining course equivalencies for the component subject area of the specified source on the Subject Area Elements page, the system prompts you with incoming courses based on the catalog organization value that you enter here.</p> <p>You can use any external organization or internal academic institution as the catalog organization to define course equivalencies for this component subject area of the specified source. However, after you define a course equivalency on the Subject Area Elements page, the Catalog Org Type and Catalog Organization fields become unavailable.</p>

Component Defaults

Use the fields in the **Component Defaults** group box to define default information for incoming courses that you select for this component subject area of specified source on the Subject Area Elements page. Later, you can override these default values for an individual incoming course by clicking the **Incoming Course Information** link for the incoming course to change on the Subject Area Elements page.

Field or Control	Description
Min/Max Units (minimum and maximum units)	Enter the default minimum and maximum units for all incoming courses that you define for this component subject area of the specified source.
Term Type	<p>Enter the default term type for all incoming courses that you define for this component subject area of the specified source. By default, the system displays the term type defined on the School Data page in the Organization School Data component. Values for this field are delivered with your system as translate values. You can modify these values.</p>
Min/Max Grade Pts Per Unit (minimum and maximum grade points per unit)	Enter the default minimum and maximum grade points per unit for all incoming courses that you define for this component subject area of the specified source.

Field or Control	Description
Internal Equiv Course Value (internal equivalent course value)	<p>Enter a default value for this component subject area. Select from these options:</p> <p><i>Use Catalog Units:</i> The system determines the number of units that the student obtains for the incoming course based on the unit setting for the internal equivalent course in the course catalog.</p> <p><i>Specify Maximum Units:</i> The system uses the units of the incoming course but does not exceed the maximum units that you enter in the Max Units to Transfer field.</p> <p><i>Specify Fixed Units:</i> The system awards the student the number of units that you enter in the Units field.</p>

Excess Credit Defaults

Field or Control	Description
Course ID	<p>If you want to create excess credit courses, enter a default for this component subject area. The system places excess units into this course when a student has taken more units for the incoming course than is allowed in the internal equivalent course. See the Course ID field description in the following section: Defining Subject Area Elements.</p>
Requirement Designation	<p>If you want to assign a requirement designation to your excess credit courses, enter a default for this component subject area. Requirement designations further define the type of transfer credit being received. Requirement designation values are defined on the Requirement Designation Table page.</p>

Related Links

[Understanding Requirement Designations](#)

Defining Subject Area Elements

Access the Subject Area Elements page (**Records and Enrollment > Transfer Credit Rules > Transfer Subject Area > Subject Area Elements**).

This example illustrates the fields and controls on the Subject Area Elements page (1 of 2). You can find definitions for the fields and controls later on this page.

This example illustrates the fields and controls on the Subject Area Elements page (2 of 2). You can find definitions for the fields and controls later on this page.

Within each transfer component, you define the incoming courses and internal equivalent courses. For each transfer component, you define the term type of the incoming course, the transfer priority in relation to other transfer components within the component subject area, and some general information.

General Fields

<i>Field or Control</i>	<i>Description</i>
Sequence Number	The sequence number is the numeric counter that distinguishes each transfer component of the component subject area from other transfer components. By default, the system populates the first sequence number of the component subject area with <i>0001</i> and increases the number by one as you add transfer components.

Field or Control	Description
Description	This field describes the transfer component of the component subject area. By default, the system displays the description from the Transfer Subject Area page. You can override this default value.
Term Type	Enter the term type for this transfer component of the component subject area. By default, the system displays the term type from the Transfer Subject Area page. Values for this field are delivered with your system as translate values. You can modify these values.
Transfer Course	<p>Select to have the incoming courses on this transfer component of the component subject area transfer to your academic institution, provided that the student's incoming course meets all conditions of the course transfer rule.</p> <p>Clear to have the Transfer Credit process reject the incoming courses that you enter on this row of the component subject area. A course evaluated in this way has a status of <i>rejected</i> on the Transfer Course Details page of the Course Credits component.</p>
Transfer Priority	<p>Enter the transfer priority number for this transfer component. The Transfer Credit process evaluates the courses within the component subject area according to the transfer priority of each transfer component. The transfer component that has the highest priority takes precedence. If an individual's incoming course meets all conditions of the course transfer rule to which this component subject area is assigned, the Transfer Credit process uses the equivalent course as defined on the transfer component that has the highest transfer priority. If the individual's incoming course does not meet the conditions of the course transfer rule to which this component subject area is assigned, the Transfer Credit process evaluates the incoming course against the transfer component with the next highest transfer priority.</p> <p>For example, if you have a rule where a student can receive credit based on the grade or the number of units that the student completes, you set up two separate components using a different transfer priority for each. If a student takes math 101 for two units or gets an A, the internal equivalent is Math 102; and if a student takes math 101 for three units or gets a C, the internal equivalent is Math 99.</p>

Field or Control	Description
Contingent Credit	<p>Select to have the incoming courses transfer to your academic institution as contingent credit, provided that the individual's incoming course meets all conditions of the course transfer rule to which this component subject area is assigned. A course evaluated in this way has a status of <i>contingent</i> on the Transfer Course Details page of the Course Credits (TRNS_CRSE) component. You can manually change the status of the incoming course from <i>contingent</i> to <i>accepted</i> after the individual meets the contingency.</p> <p>For example, Education 310 at UC Santa Cruz is equivalent to Education 312 at PSUNV, provided that the student also has submitted verification of an internship. Select the Contingent Credit check box for this incoming course. During the Transfer Credit process, the course credit transfers but the incoming course has a status of <i>contingent</i> on the Transfer Course Details page.</p>

Field or Control	Description
<p>Internal Equiv Course Value (internal equivalent course value)</p>	<p>Enter a value to indicate how you want the system to determine the number of units the student receives from the incoming course. Select from the following:</p> <ul style="list-style-type: none"> <p><i>Use Catalog Unit:</i> The system determines the number of units the student gets for the incoming course based on the unit setting for the internal equivalent course in the course catalog.</p> <p>To determine the units in the course catalog, the system compares the start date of the articulation term to the effective date in the course catalog.</p> <p><i>Specify Maximum Units:</i> With two internal equivalents, the system adds the values of the incoming courses to determine the total amount that is available to transfer, up to the maximum specified, and uses the rest for the excess course when the Save Excess Units to a Course check box is selected.</p> <hr/> <p>Note: Entering this value precludes the user from having two internal equivalents without selecting the Save Excess Units to a Course check box. To use a many-to-many or one-to-many rule, select <i>Specify Fixed Units</i> or <i>Use Catalog Units</i>.</p> <hr/> <p><i>Specify Fixed Units:</i> The system uses the number of units that you enter in the Units field, which appears in the Internal Equivalent group box when you select this option.</p> <p>By default, the system populates the Units field with the course catalog unit value of the internal equivalent when the transfer rule is set up. You can change this value.</p> <hr/> <p>Note: If the unit value or effective date in the course catalog changes, the Units field on this page does not change.</p> <hr/>

Field or Control	Description
Save Excess Units to a Course	<p>Select if you want to save excess units from the incoming course to a specified internal course. For example, if the incoming course was taken for four units, and the internal equivalent course is worth only three units, the extra unit can be credited to a second internal course, most likely an elective course.</p> <hr/> <p>Note: Only one excess unit course can be assigned per transfer equivalency rule. Also, you cannot save excess units to a course when there is more than one internal equivalent.</p> <hr/>

Incoming Course

Use the **Incoming Course** group box to define the external course information for a specific transfer component. The incoming courses and internal equivalent courses that you define are the transfer components of the component subject area.

Field or Control	Description
Seq# (sequence number)	The system automatically assigns a sequential number to each incoming course to identify unique transfer component records within the data table. These sequence numbers have no programming significance.
W (wildcard)	Select to use the # wildcard character at the end of the <i>Course Number</i> field value for the incoming course. If you clear this check box, the system requires you to use a complete course number.
Subject	Enter the subject area of the incoming course. For incoming courses from external organizations, define subject values on the School Subject Maintenance page. For incoming courses from internal academic institutions, subject areas are tied to courses in that academic institution's course catalog.

Field or Control	Description
Course Number	<p>Enter the course number for the incoming course. If you are using an external organization for the catalog organization (as defined on the Transfer Subject Area page), the system prompts you with courses that you associated with the external organization on the School Course Classification page. If you are using an internal academic institution for the catalog organization, the system prompts you with courses defined for that academic institution in the Course Catalog (CRSE_CATALOG) component.</p> <p>If you selected the W check box, you can substitute the # wildcard character for the last character of the course number so that you can map a series of incoming courses to one internal equivalent course. For example, you can enter <i>1#</i> to map course numbers 10 through 19 to a specific internal equivalent course, you can enter <i>10#</i> to map course numbers 100 through 109 to specific internal equivalent course, or you can enter <i>1##</i> to map all 100 level courses to a specific internal equivalent course. Otherwise, the system prompts you with values from the School Course Classification Table page.</p>
Incoming Course Information	Click to access the Incoming Course Information page, where you can enter detail information about this incoming course.

Internal Equivalent

Use the **Internal Equivalent** group box to define the internal course that is equivalent to the incoming course for this transfer component.

Field or Control	Description
Course ID	Enter the course that is equivalent to the incoming course for this transfer component.
Offer Number	Defaults to the offer number of the course that you entered, as defined in your academic institution's course catalog. You can override this value.

Field or Control	Description
Max Units to Transfer (maximum units to transfer)	This field appears when you enter <i>Specify Maximum Units</i> in the Internal Equiv Course Value field. Enter the maximum number of units that a student can transfer for this incoming course. For example, if the incoming course is a variable unit course that can be taken for one to five units, and you want the system to use the incoming units to populate the internal equivalent units, but you want to accept only up to three units for this course, you could enter 3 in this field. However, if you want the system to use the units of the incoming course, but do not want to impose a maximum, accept the default of 99.
Units	This field appears when you enter <i>Specify Fixed Units</i> in the Internal Equiv Course Value field. Enter the number of units that you want the internal equivalent to be worth, regardless of the number of units the incoming course is worth. For example, if you enter 3 in this field, a student can take the course for one unit, two units, or seven units, but still receives three units for the internal equivalent. Defaults to the value are defined in the course catalog. You can change this value. This value does not change when you change the units in the course catalog.

Field or Control	Description
Default Grade	<p>Enter a value in this field to indicate how you want the Transfer Credit process to determine the grades for internal equivalent courses.</p> <p>The <i>By Grade Order</i> value is available only for many-to-one and many-to-many equivalency rules. When you enter this value, the Grade Order field becomes available. The value that you enter in this field determines which incoming grade the Transfer Credit process uses. For example, if the rule is that two incoming courses—ENG101 with a grade of A and ENG102 with a grade of B—can be transferred as the internal equivalent ENGL1301, and you enter a grade order of <i>2nd Highest</i>, the Transfer Credit process transfers the B grade to the internal equivalent course.</p> <hr/> <p>Note: The Transfer Credit process copies the grade from the incoming course to the equivalent course if the grade is a valid value for the grading scheme and the grading basis of the student's academic program.</p> <hr/> <p>Enter the value of <i>Incoming Course</i> in the Default Grade field if you want the Transfer Credit process to copy the grade from the incoming course to the internal equivalent course. When you enter this value, the Course field becomes available. For many-to-one and many-to-many equivalency rules, enter a value in the Course field to indicate which course you want the transfer credit process to use. In a many-to-many rule, each internal equivalent can use a different incoming course to determine the grade.</p> <hr/> <p>Note: The Transfer Credit process copies the grade from the incoming course to the equivalent course if the grade is a valid value for the grading scheme and the grading basis of the student's academic program.</p> <hr/> <p>Enter the value of <i>By Transfer Equivalency Setup</i> in the Default Grade field if you want the Transfer Credit process to use the transfer grade value defined on the Academic Program Table (ACADEMIC_PROG_TBL) component for the academic program specified on the transfer credit model.</p>

Excess Credit Group Box

This group box appears when you select the **Save Excess Units to a Course** check box.

Field or Control	Description
Course ID	<p>Enter an excess credit course for this transfer equivalency rule. If a student earns more units for an incoming course than the internal equivalency rule allows, the system awards the student units in the course that you enter here. The course should be an elective course for which repeat checking is not activated.</p> <hr/> <p>Note: Each time that a student is awarded excess units in a course, the articulation of units appears as a separate instance of the class. Therefore, you should select the Repeat for Credit check box on the Catalog Data page in the course catalog for the course that you enter. Also, you should set the Units Allowed for the course to 999 and the Total Completions Allowed to 99 on the Catalog Data page.</p>
Offer Nbr (offer number)	By default, the system displays the offering number of the course that you entered according to the definition of that course in your academic institution's course catalog. You can override this value.
Max Units to Transfer (maximum units to transfer)	Enter the maximum number of excess units that you want to award students. If you do not want to set a maximum, accept the default value of 99.
Requirement Designation	Enter a requirement designation if you want to define the type of transfer credit being received. This value appears by default from the course catalog.

Related Links

[Defining Course Catalog Data](#)

[Understanding Requirement Designations](#)

Reviewing and Adjusting Incoming Course Information

Access the Incoming Course Information page (click the **Incoming Course Information** link on the Subject Area Elements page).

This example illustrates the fields and controls on the Incoming Course Information page. You can find definitions for the fields and controls later on this page.

Incoming Course Information		
School Subject:	MATH	Mathematics
School Course Nbr:	15	Trigonometry
Course Level:	Regular	
External Units:	3.00	
Begin / End Date:	01/01/1900 <input type="text"/>	12/31/9999 <input type="text"/>
Min / Max Units:	<input type="text" value="1.00"/>	<input type="text" value="99.00"/> *Maximum Age: <input type="text" value="99"/>
Min / Max Grade Pts per Unit:	<input type="text" value="1.000"/>	<input type="text" value="4.500"/>

<i>Field or Control</i>	<i>Description</i>
Begin / End Date	By default, the system populates the begin and end date of the incoming course with 01/01/1900 and 12/31/9999. You can override these default values. These dates inform the Transfer Credit process when this incoming course is valid for the course transfer equivalency rule to which you attach this component subject area.
Min / Max Units (minimum and maximum units)	The system displays the default minimum and maximum units for incoming courses within this component subject area. You can override these default values. For example, you might want to specify the same incoming course twice but differentiate each specification by how many units are earned. In this case, specify the same incoming course multiple times but with different minimum and maximum unit ranges.
Min/Max Grade Pts Per Unit (minimum and maximum grade points per unit)	The system displays the default minimum and maximum grade points per unit for incoming courses within this component subject area. You can override these default values.
Maximum Age	This field defines the maximum age in years of the incoming course. This prevents an individual from transferring credit for this course to your academic institution when the individual took the course more years ago than the number that you specify here. By default, the system sets the maximum age of an incoming course to 99 years, but you can override this default value. For instance, you might want restrict individuals from receiving transfer credit for a course when an individual has taken the course more than 4 years previous to the date your institution processes that individual's transfer credit.

Defining Course Transfer Rules

Access the Course Transfer Rules page (**Records and Enrollment > Transfer Credit Rules > Course Transfer Rules > Course Transfer Rules**).

This example illustrates the fields and controls on the Course Transfer Rules page. You can find definitions for the fields and controls later on this page.

The screenshot shows the 'Course Transfer Rules' page. At the top, there are navigation links: 'Find | View All', 'First', '1 of 1', and 'Last'. Below this, the main form contains the following fields:

- Academic Institution:** PSUNV PeopleSoft University
- Source ID:** 000010147
- Equivalency Rule:** SMCC
- *Effective Date:** 01/01/1990
- *Status:** Active
- *Description:** Santa Monica College - LAU/FAU

Below the main form is a 'Transfer Subject Area' section with a table:

Transfer Subject Area		Find	First	1-5 of 5	Last
+ -	SMCC-ARTS	Art Courses			
+ -	SMCC-ENGLISH	English Courses			
+ -	SMCC-HISTORY	History Courses			
+ -	SMCC-LANGUAGES	Foreign Languages			
+ -	SMCC-MATH	Math Courses			

For each transfer equivalency rule, attach component subject areas that you have defined for the source in the Transfer Subject Area (TRNSFR_SUBJ_AREA) component. You can define multiple course transfer equivalency rules for a single source. For example, you might define multiple rules to account for academic program and academic plan differences in equivalency rules. The effective date functionality enables you to add and delete component subject areas that are no longer valid for the equivalency rule.

When adding a new transfer equivalency rule, you must also specify the credit source type of either *external organization* or internal academic *institution*. The credit source type instructs the system from which table you will select your source ID. By selecting *external organization*, the system prompts you with the source IDs of external organizations in your system. By selecting *institution*, the system prompts you with source IDs of academic institutions in your system.

Field or Control	Description
Transfer Subject Area	Enter the component subject areas to tie to the course transfer equivalency rule. Each component subject area defines the incoming courses, their internal equivalent courses, and detail about how the Transfer Credit process must function. The Transfer Credit process uses the transfer component data for component subject areas to determine an individual's transfer credit.

Reviewing Examples of Course Equivalencies

This section provides examples of the following course equivalencies:

- Many-to-one.
- Many-to-many.
- Course rejection.
- Multiple equivalencies for the same course.
- Excess credit.

These examples demonstrate some of the ways that you can set up the Subject Area Elements page for course equivalencies.

Example of a Many-to-One Course Equivalency

This example illustrates a many-to-one course equivalency:

Transfer Subject Area		Subject Area Elements	
Academic Institution:	PSUNV	PeopleSoft University	
Source ID:	000010147	Santa Monica City College	
Component Subject Area:	SMCC-MATH	Review History	
Find View All First 1 of 1 Last			
Effective Date:	01/01/1982	Status:	Active
Description:	Math Courses		
Find View All First 11 of 11 Last			
'Sequence Number:	0011		
'Description:	Math 16 and 20		
'Term Type:	Quarter		
Transfer Course:	<input checked="" type="checkbox"/>		
'Transfer Priority:	1	'Internal Equiv Course Value:	Specify Fixed Units
Contingent Credit:	<input type="checkbox"/>	Save Excess Units to a Course:	<input type="checkbox"/>
Incoming Course		Internal Equivalent	
'Seq#:	1	'Course ID:	001004 MATH 107
Wildcard:	<input type="checkbox"/>	'Offer Number:	1 Precalculus
'Subject:	MATH Math	Units:	2.00
Course Number:	16 Pre-Calculus	'Default Grade:	By Transfer Equivalency Setup
Incoming Course Information			
'Seq#:	2		
Wildcard:	<input type="checkbox"/>		
'Subject:	MATH Math		
Course Number:	20 Calculus 1		
Incoming Course Information			

When the Transfer Credit process applies this rule, it uses the transfer grade value defined on the Academic Program Table component for the academic program specified on the transfer credit model.

Example of a Many-to-Many Course Equivalency

This example illustrates a many-to-many course equivalency:

When the Transfer Credit process applies this rule, it uses the transfer grade for MATH 14 for one course and the transfer grade for MATH 15 for the other course.

Example of a Course Rejection Equivalency

To reject a course, clear the **Transfer Course** check box. The **Internal Equivalent** group box fields become unavailable.

This example illustrates a course rejection equivalency:

Transfer Subject Area		Subject Area Elements	
Academic Institution:	PSUNV	PeopleSoft University	
Source ID:	000010147	Santa Monica City College	
Component Subject Area:	SMCC-MATH		Review History
Find View All First 1 of 1 Last			
Effective Date:	01/01/1982	Status:	Active
Description:	Math Courses		
Find View All First 13 of 13 Last			
*Sequence Number:	0013		
*Description:	Math 8 - Reject		
*Term Type:	Quarter		
Transfer Course:	<input type="checkbox"/>		
*Transfer Priority:	1	*Internal Equiv Course Value:	Specify Fixed Units
Contingent Credit:	<input type="checkbox"/>	Save Excess Units to a Course:	<input type="checkbox"/>
Incoming Course		Internal Equivalent	
*Seq#:	1	*Course ID:	
Wildcard:	<input type="checkbox"/>	*Offer Number:	
*Subject:	MATH Math	Units:	0.00
Course Number:	08 Preparatory Math	*Default Grade:	By Transfer Equivalency Setup
Incoming Course Information			

Example of Multiple Equivalencies for the Same Course

The following examples show multiple equivalencies for the same course.

For Santa Monica City College, the student's transfer course articulates to different math courses at PSUNV, depending on the number of units that a student takes for Math 20. In this example, there are two component rules—one for Math 20 taken between one and two units and another for Math 20 taken between three and four units.

This example illustrates the one to two unit equivalency:

Transfer Subject Area		Subject Area Elements	
Academic Institution:	PSUNV	PeopleSoft University	
Source ID:	000010147	Santa Monica City College	
Component Subject Area:	SMCC-MATH	Review History	
Find View All First 1 of 1 Last			
Effective Date:	01/01/1982	Status:	Active
Description:	Math Courses		
Find View All First 12 of 12 Last			
*Sequence Number:	0012		
*Description:	Math 20 - 1 to 2 units		
*Term Type:	Quarter		
Transfer Course:	<input checked="" type="checkbox"/>		
*Transfer Priority:	1	*Internal Equiv Course Value:	Specify Fixed Units
Contingent Credit:	<input type="checkbox"/>	Save Excess Units to a Course:	<input type="checkbox"/>
Incoming Course		Internal Equivalent	
*Seq#:	1	*Course ID:	001004 MATH 107
Wildcard:	<input type="checkbox"/>	*Offer Number:	1 Precalculus
*Subject:	MATH Math	Units:	2.00
Course Number:	20 Calculus 1	*Default Grade:	By Transfer Equivalency Setup
Incoming Course Information			

The incoming course maps to *Pre-calculus*.

This example illustrates the Incoming Course Information page for the one-to-two unit equivalency:

Incoming Course Information			
School Subject:	MATH	Math	
School Course Nbr:	20	Calculus 1	
Course Level:	Regular		
External Units:	3.00		
Begin / End Date:	01/01/1900	12/31/9999	
Min / Max Units:	1.00	2.00	*Maximum Age: 99
Min / Max Grade Pts per Unit:	1.000	4.500	

The minimum and maximum units are *1.00* and *2.00*, respectively.

This example illustrates the three-to-four unit equivalency:

Transfer Subject Area		Subject Area Elements	
Academic Institution:	PSUNV	PeopleSoft University	
Source ID:	000010147	Santa Monica City College	
Component Subject Area:	SMCC-MATH	Review History	
Find View All First 1 of 1 Last			
Effective Date:	01/01/1982	Status:	Active
Description:	Math Courses		
Find View All First 13 of 13 Last			
*Sequence Number:	0013		
*Description:	Math 20 - 3 to 4 units		
*Term Type:	Quarter		
Transfer Course:	<input checked="" type="checkbox"/>		
*Transfer Priority:	2	*Internal Equiv Course Value:	Specify Fixed Units
Contingent Credit:	<input type="checkbox"/>	Save Excess Units to a Course:	<input type="checkbox"/>
Incoming Course		Internal Equivalent	
*Seq#:	1	*Course ID:	001005 MATH 111
Wildcard:	<input type="checkbox"/>	*Offer Number:	1 Calculus I
*Subject:	MATH Math	Units:	3.00
Course Number:	20 Calculus 1	*Default Grade:	By Transfer Equivalency Setup
Incoming Course Information			

The incoming course maps to a *Calculus 1* instead of *Pre-calculus*.

This example illustrates the Incoming Course Information page for the three-to-four unit equivalency:

Incoming Course Information			
School Subject:	MATH	Math	
School Course Nbr:	20	Calculus 1	
Course Level:	Regular		
External Units:	3.00		
Begin / End Date:	01/01/1900	12/31/9999	
Min / Max Units:	3.00	4.00	*Maximum Age: 99
Min / Max Grade Pts per Unit:	1.000	4.500	

The minimum and maximum units are 3.00 and 4.00, respectively.

Example of an Excess Credit Course Equivalency

Excess credit occurs when the external course is worth more units than the internal equivalent course. Identify an existing course or create a new course to manage excess credit.

This example illustrates an excess credit course equivalency:

Transfer Subject Area		Subject Area Elements	
Academic Institution:	PSUNV	PeopleSoft University	
Source ID:	000010147	Santa Monica City College	
Component Subject Area:	SMCC-MATH		Review History
Effective Date:	01/01/1982	Status:	Active
Description:	Math Courses		
Subject Area Elements		Find View All First 1 of 1 Last	
*Sequence Number:	0011		
*Description:	Math 16		
*Term Type:	Quarter		
Transfer Course:	<input checked="" type="checkbox"/>		
*Transfer Priority:	1	*Internal Equiv Course Value:	Specify Fixed Units
Contingent Credit:	<input type="checkbox"/>	Save Excess Units to a Course:	<input checked="" type="checkbox"/>
Incoming Course		Internal Equivalent	
*Seq#:	1	*Course ID:	001004 MATH 107
Wildcard:	<input type="checkbox"/>	*Offer Number:	1 Precalculus
*Subject:	MATH Math	Units:	2.00
Course Number:	16 Pre-Calculus	*Default Grade:	By Transfer Equivalency Setup
Incoming Course Information		Excess Credit	
		*Course ID:	666674 MATH 1X
		*Offer Number:	1 Math Excess
		Max Units to Transfer:	99.00
		Requirement Designation:	

Converting Existing Transfer Components into Component Subject Areas

If you are upgrading your Student Records system and you have existing transfer component data in your application tables, run the delivered upgrade script, UPG_SR. This upgrade script moves your existing transfer component data from the former application-data table structure into the current application-data table structure. It assigns all transfer components within an existing course transfer equivalency rule to a single component subject area that is named after the original rule in which the transfer component resides. After you run the upgrade script, use the Transfer Subject Area component to access each of the component subject areas that the upgrade script creates, just as you would any other component subject area that you manually define. The data for all component subject areas, regardless of how they were created, are stored in the same table (EXT_TRNSFR_SUBJECT).

Next, you must go to the Course Transfer Rules page and create your course transfer equivalency rules, attaching the component subject area to rules, as appropriate. The system writes course transfer equivalency rule data to the EXT_TRNSFR_RULE_SUBJ table. You can continue course transfer credit processing using predefined rules, as usual.

Copying Transfer Components Between Component Subject Areas

This section discusses how to copy transfer components between component subject areas.

Page Used to Copy Transfer Components Between Component Subject Areas

<i>Page Name</i>	<i>Definition Name</i>	<i>Navigation</i>	<i>Usage</i>
Subject Area Copy Function	RUNCNTL_TRNSFR_CPY	Records and Enrollment > Transfer Credit Rules > Copy Subject Areas > Subject Area Copy Function	As necessary and as time permits, copy transfer components from larger, more general component subject areas into new, smaller component subject areas.

Copying Transfer Components Between Component Subject Areas

Access the Subject Area Copy Function page (**Records and Enrollment > Transfer Credit Rules > Copy Subject Areas > Subject Area Copy Function**).

This example illustrates the fields and controls on the Subject Area Copy Function page. You can find definitions for the fields and controls later on this page.

Subject Area Copy Function

Run Control ID: PS [Report Manager](#) [Process Monitor](#) Run

Refresh

Subject Area Information Find | View All First 1 of 1 Last

From Seq #: 1 Description: Long Beach City College + -

*Academic Institution: PSUNV PeopleSoft University

*Source ID: 000010146 Long Beach City College - LAU

*Component Subject Area: LBCC Long Beach City College 1

*Effective Date: 01/01/1970

Incoming Subject: BIOL

Break by Incoming Subject

*From Component Seq#: 0001 *To Component Seq#: 9999

TO Subject Area Info

*To Component Subject Area: BIOL Descr: BIOL

*Effective Date To: 31

Deselect All
Filter
Fetch Data

Find | View All First 1 of 2 Last

Sequence# / Description	Incoming Course	Equivalent Course												
<input checked="" type="checkbox"/> 0001 Long Beach City College 1	<table border="1" style="width: 100%; border-collapse: collapse;"> <thead> <tr> <th>Subject</th> <th>Course Nbr</th> </tr> </thead> <tbody> <tr> <td>BIOL</td> <td>11</td> </tr> <tr> <td>Biology</td> <td>Biology I</td> </tr> </tbody> </table>	Subject	Course Nbr	BIOL	11	Biology	Biology I	<table border="1" style="width: 100%; border-collapse: collapse;"> <thead> <tr> <th>Course ID</th> <th>Offer Nbr</th> </tr> </thead> <tbody> <tr> <td>003700</td> <td>1</td> </tr> <tr> <td>General Biology I</td> <td>BIOLOGY 100</td> </tr> </tbody> </table>	Course ID	Offer Nbr	003700	1	General Biology I	BIOLOGY 100
Subject	Course Nbr													
BIOL	11													
Biology	Biology I													
Course ID	Offer Nbr													
003700	1													
General Biology I	BIOLOGY 100													

The copying functionality is intended primarily for academic institutions that receive a large number of transfer credit courses from a single source. On this page, you select the component subject area from which you want to retrieve transfer components, define the basics of the new component subject area to create, then retrieve the transfer components from the existing component subject area based on your parameters. Sort through the list of results to select the transfer components to include in the new transfer subject area, then run the Transfer Rule Subject Area Copy COBOL/SQL process (SRPCCARX) to create the new, smaller component subject area and to copy the selected components into it. After you run the process, you can edit the newly created component subject area in the Transfer Subject Area component. Attach this new component subject area to course transfer equivalency rules in the Course Transfer Rules (TRNSFR_RULE) component and resume course transfer credit processing as usual.

Important! If you are copying a large component subject area, you should either use the **Incoming Subject** field or the **Break by Incoming Subject** check box to separate the large component subject area into smaller ones based on incoming subject. Alternatively, use the **From Component Seq#** and **To Component Seq#** fields to copy blocks of 500 transfer components at a time into smaller component subject areas based on transfer component sequence numbers. You are not required to copy transfer components by subject area—it is just a logical breaking point for large component subject areas.

Field or Control	Description
Refresh	Click to refresh the page.
From Seq # (from sequence number)	The sequence number is the numeric counter that distinguishes each row of the process request apart from other rows. By default, the system sets the first sequence number to 1 and increases the number by one as you add rows.
Description	Enter a description for this row of the process request.
Academic Institution	Enter the academic institution to which the component subject area to copy belongs.
Source ID	Enter the identification code of the source to which the component subject area to copy belongs.
Component Subject Area	Enter the component subject area to copy. The system displays values based on the academic institution and source that you specified for this process request.
Effective Date	Enter the effective date of the specified component subject area. The effective date indicates the row to copy within the specified component subject area.
Incoming Subject	<p>Enter an incoming subject to filter by subject through all transfer components of the specified transfer component subject area. When you click the Fetch button, the system retrieves only the transfer components with this incoming subject and automatically selects to copy them into the new, smaller component subject area during processing. This field prompts against the external subject table for the specified external organization. If you use this field, the Break by Incoming Subject check box becomes unavailable for entry.</p> <p>Note that you can assign the To Component Subject Area field and its related Description field the same name as the incoming subject because component subject areas are keyed by source ID. Alternatively, you can assign these fields unique values.</p>

Field or Control	Description
Break by Incoming Subject	<p>Select to break by incoming subject all the transfer components of the specified component subject area. If you select this check box, the Incoming Subject field, To Component Subject Area field, and its related Description field become unavailable for entry.</p> <p>When you click the Fetch button, the system retrieves all transfer components, separates them by incoming subject into unique rows on the run control page, assigns each row a sequence number, and automatically selects to copy all transfer components into new, smaller component subject areas during processing. For example, LBCC has eight different incoming subjects in their component subject area, so the system creates eight rows for eight new component subject areas. In addition, the system automatically populates the Incoming Subject field, the To Incoming Subject Area field, and its related Description field for each row. The Incoming Subject field remains unavailable for edit, but you can edit the other two fields.</p>
From Component Seq# (from component sequence number)	Indicate the first transfer component to retrieve from the specified component subject area. By default, the system sets the value of this field to <i>0001</i> . You can override this default value.
To Component Seq# (to component sequence number)	Indicate the last transfer component to retrieve from the specified component subject area. When you click the Fetch button to retrieve transfer components, the system displays all transfer components within the specified range. By default, the system sets the value of this field to <i>9999</i> . You can override this default value.
To Component Subject Area	Enter the identification code of the new component subject area to create based on the preexisting component subject area that you specified.
Description	Enter a description of the new component subject area.
Effective Date To	Enter the effective date of the new component subject area to create based on the preexisting component subject area that you specified to copy.
Fetch	Click to retrieve the transfer components from the preexisting component subject area that you specified to copy.
Sequence # (sequence number)	The system displays the sequence number of the transfer component from the preexisting component subject area that you specified to copy.

Field or Control	Description
Description	The system displays the description of the transfer component from the preexisting component subject area that you specified to copy.
Incoming Course	The system displays the subject, course number, and description for the incoming course of the transfer component.
Equivalent Course	The system displays the course ID, offering number, and description for the internal equivalent course of the transfer component.
Select All or Deselect All	<p>Click to select or clear all of the transfer components in the list at the bottom of the page. This functionality is useful when you are splitting a component subject area with a large amount of transfer components.</p> <p>For example, you have a math component subject area with 300 transfer components and you want to group 250 within a new, higher math component subject area and the remaining 50 within a new, lower math component subject area. To create the higher math component subject area, retrieve all of the transfer components from the math component subject area, click the Select All button, and then clear the check boxes for the 50 excluded components. When you create the lower math component subject area, select all of the 50 included transfer components.</p>
Filter	Click to filter the list of transfer components that appear at the bottom of this page. The system displays only the transfer components that you have checked. The checked transfer components are the only ones that the Subject Area Copy Function process uses when creating the new component subject area.
Unfilter	The system displays this button whenever you have filtered the list of transfer components that appear at the bottom of the page. Click this button to reset the list back to its original number of transfer components.

Defining Course Equivalencies for Academic Programs and Plans

This section provides an overview of course equivalencies for academic programs and plans and discusses how to:

- Set up basic academic program and plan data.
- Set equivalency rules.

Understanding Course Equivalencies for Academic Programs and Plans

To set up course equivalencies for academic programs and plans, use the Program/Source Equivalency (EXT_EQUIV) component.

After you set up your course transfer equivalency rules, you must use the Program/Source Equivalency component to select the academic programs and plans within your academic institution to which you want to assign these rules.

If you have multiple equivalency rules for a given external organization or internal academic institution, you can attach these rules to various academic program and academic plan combinations. For instance, if you create two course transfer equivalency rules for an external organization, then you can link one rule to the Liberal Arts program and the other rule to the Liberal Arts program and English plan. The English equivalency rule includes English course-specific equivalencies that are different from the liberal arts equivalencies.

Note: The Basic page enables you to attach course transfer equivalency rules to a specific academic program or academic plan. The system requires that you attach the rule to an academic program, but attaching the rule to an academic plan is optional.

Example of How the System Uses Effective Dating

The Transfer Credit Setup tables use effective dating to determine the correct row of data to use when determining the correct rule to be used at articulation.

You are articulating a student in Term 0370 - Fall 1999. The begin date for Fall 1999 is September 1, 1999. The system determines the correct row of data to use using this procedure:

1. The system accesses the Program/Source Equivalency page and finds the row that is less than or equal to September 1, 1999.

The date of this row is January 1, 1900.

2. The system accesses the Course Transfer Rules and finds the row that is less than or equal to January 1, 1900.

The date for this row is January 1, 1990.

3. The system locates the rules for the row that is less than or equal to January 1, 1900, and uses that rule.

Pages Used to Define Course Equivalencies for Academic Programs and Plans

<i>Page Name</i>	<i>Definition Name</i>	<i>Navigation</i>	<i>Usage</i>
Program/Source Equivalency - Basic	EXT_TRNSFR	Records and Enrollment > Transfer Credit Rules > Program/Source Equivalency > Basic	Set up basic parameters, such as grading basis and transfer grade, for processing transfer credit within a specified academic program or plan.

Page Name	Definition Name	Navigation	Usage
Rules Specification	EXT_TRNSFR_EQUIV	Records and Enrollment > Transfer Credit Rules > Program/Source Equivalency > Rules Specification	Set the course equivalency rules for academic programs or academic plans. The system uses these rules to evaluate transfer credit from the specified institution. On this page, like the external course catalog, you have the flexibility to point to any organization's ID to use as the source ID for course equivalency rules.

Setting Up Basic Academic Program/Plan Data

Access the Program/Source Equivalency - Basic page (**Records and Enrollment > Transfer Credit Rules > Program/Source Equivalency > Basic**).

This example illustrates the fields and controls on the Program/Source Equivalency - Basic page. You can find definitions for the fields and controls later on this page.

When accessing this page in Add mode, enter the credit source type from which you select your source ID. By entering *external organization*, the system prompts you with the source IDs of external organizations in your system. You define external organizations on the Organization Table page. By entering *institution*, the system prompts you with source IDs of academic institutions in your system. You define institutions on the Academic Institution Table page.

Field or Control	Description
Effective Date	In addition to the common definition of this element, the system uses the effective date in conjunction with the articulation term on the Transfer Course Detail page to determine the validity of equivalency rules.

Field or Control	Description
Grading Scheme	By default, the system displays the grading scheme of the specified academic program. Define grading schemes for academic programs on the Academic Program page in the Academic Program Table component. Define grading schemes for academic careers on the Academic Career Table page. You can override this default value now, and you can override this value later for individual transfer courses that you process. This grading scheme defines all of the valid grading bases from which you can select a default transfer grade for this academic program/plan and source combination.
Grading Basis	By default, the system displays the grading basis default for transfer credit according to the specified academic program. Define grading-basis defaults for transfer-credit values on the Academic Program page in the Academic Program Table component for academic programs. Define grading-basis defaults for transfer-credit values on the Academic Career Table page for academic careers. You can override this default value now, and you can override this value later for individual transfer courses that you process. This grading basis defines all of the valid grades from which you can select a default transfer grade for this academic program, academic plan, and source combination.
Transfer Grade	By default, the system displays the default transfer grade of the specified academic program. Define default transfer grades for academic programs on the Academic Program page in the Academic Program Table component. Define default transfer grades for academic careers on the Academic Career Table page. You can override this default value now, and you can override this value later for individual transfer courses that you process. This transfer grade defines the grade that an individual receives for courses that articulate into the specified academic program or academic plan.
Transfer HS Courses (transfer high school courses)	To include any course taken during high school in an individual's transfer credit for this academic program, academic plan, and source combination, select this check box. Clear this check box to exclude courses taken during high school.

Setting Equivalency Rules

Access the Rules Specification page (**Records and Enrollment > Transfer Credit Rules > Program/Source Equivalency > Rules Specification**).

This example illustrates the fields and controls on the Rules Specification page. You can find definitions for the fields and controls later on this page.

The screenshot shows a web interface with two tabs: 'Basic' and 'Rules Specification'. Under 'Rules Specification', the following information is displayed:

- Academic Institution:** PSUNV (PeopleSoft University)
- Academic Program:** LAU (Liberal Arts Undergraduate)
- Academic Plan:** (empty)
- Source ID:** 000010147 (Santa Monica City College)
- Effective Date:** 02/01/1990

Below this is a table with three columns: 'Rule Source Type', 'Rule Source ID', and 'Course Equivalency Rule'. The table has three rows: 'Default', 'Override', and 'Agreement'. The 'Default' row is populated with 'Ext Org' (dropdown), '000010147' (text input with search icon), and 'SMCC' (text input with search icon). The 'Override' and 'Agreement' rows have empty dropdowns and text inputs with search icons.

You must specify the credit source type from which you will select your source ID. If you enter *external organization*, the system prompts you with the source IDs of external organizations in your system. If you enter *institution*, the system prompts you with source IDs of academic institutions that you defined in your system.

All of the following group boxes have **Agreement**, **Override**, and **Default** fields. Each identically named field functions as a row of data to define a course equivalency rule. Each of these fields is documented once, following the group box definitions. As the Transfer Credit process evaluates courses, it uses the rules in this order: agreement, override, default.

Rule Source Type

Use the fields in this group box to select the table from which you will select each of your course equivalency rules for this academic program/plan and source combination. Select from the following choices.

Field or Control	Description
External Org (external organization)	The system prompts you with the external organization source IDs in your system. Because external organizations and internal academic institutions can share the same course catalog, you might want to point to a different source ID for the course catalog.
Institution	The system prompts you with institution source IDs in your system.

Rule Source ID

Use the fields in this group box to select the source ID for the course transfer equivalency rule for this academic program/plan and source combination. You can point to any sources rules.

Course Equivalency Rule

Use the fields in this group box to select the specific course transfer equivalency rules for this academic program, academic plan, and source combination.

Common Course Equivalency Rule Fields

Field or Control	Description
Agreement	The Transfer Credit process uses the course equivalency rule that you specify on this row first. If the transfer course meets the criteria of the rule specified on this row, the process applies the rule to the transfer course and evaluates the course no further. If you did not specify a rule for this row, or if the transfer course does not meet the criteria of the rule, the process then evaluates the course equivalency rule that you specify on the Override row.
Override	The Transfer Credit process uses the course equivalency rule that you specify on this row next. If the transfer course meets the criteria of the rule specified on this row, the process applies the rule to the transfer course and evaluates the course no further. If you did not specify a rule for this row, or if the transfer course does not meet the criteria of the rule, the process then evaluates the course equivalency rule that you specify on the Default row.
Default	The Transfer Credit process uses the course equivalency rule that you specify on this row last. If the transfer course meets the criteria of the rule specified on this row, the process applies the rule to the transfer course and evaluates the course no further. If you did not specify a rule for this row, or if the transfer course does not meet the criteria of the rule, the process will not articulate the course. In this case, the transfer course appears on the Transfer Course Details page with a status of <i>no rule</i> .

Note: If you have only one rule for this source, you must enter it in **Course Equivalency Rule** field in the Default row. The Default row is the only row on the page that requires a course equivalency rule.

Creating Test Transfer Equivalency Rules

To set up test transfer equivalency rules, use the Test Transfer Rules component (TEST_RULES).

This section discusses how to define test transfer equivalency rules.

Page Used to Create Test Transfer Equivalency Rules

Page Name	Definition Name	Navigation	Usage
Test Credit Rule/Component	TEST_CREDIT_COMP	Records and Enrollment > Transfer Credit Rules > Test Transfer Rules > Test Credit Rule/Component	Define sets of test transfer equivalency rules.

Defining Test Transfer Equivalency Rules

Access the Test Credit Rule/Component page ((**Records and Enrollment > Transfer Credit Rules > Test Transfer Rules > Test Credit Rule/Component**)).

This example illustrates the fields and controls on the Test Credit Rule/Component page. You can find definitions for the fields and controls later on this page.

Test Credit Rule/Component

Institution: PSUNV PeopleSoft University
Test Equivalency Rule: SATI

Find | View All First 1 of 1 Last

***Effective Date:** 01/01/1900 ***Status:** Active

***Description:** SAT Test Rules - LAU

Find | View All First 1 of 5 Last

***Test ID:** SATI Scholastic Assessment Test I

Test Component: MATH Math

***Equiv Component:** 0001

***Description:** Math **Priority:** 1

Min / Max Score: 200.00 800.00 **Min Percentile:**

Begin / End Date: 01/01/1900 12/31/9999 **Maximum Age:** 99

+ -

***Course ID:** 001310 Complex Variables for Apps

***Course Offering Nbr:** 1 MATH 125

Units Taken: 3.00

Setting up test transfer equivalency rules is similar to setting up course credit transfer equivalency rules. For each test equivalency rule that you define, describe the rule, select the test and test component for the rule, and specify course equivalencies for the test component.

Field or Control	Description
Test ID	Enter the identification number of the test for which you are defining this test equivalency rule.
Test Component	Enter the component of the test for which you are defining this test equivalency rule.
Equiv. Component (equivalent component)	The equivalency component number is the numeric counter that distinguishes each row of the test equivalency rule apart from other rows. By default, the system enters the first equivalency component of the test equivalency rule as <i>0001</i> and increases the number by one as you add rows.
Description (lower)	This field describes the row of the equivalency test rule. By default, the system displays the description of the test component according to the description on the Test Component Table page. You can override this default value.
Transfer Priority	Enter the transfer priority number for this row of the test equivalency rule. The Transfer Credit process evaluates the rows within the test equivalency rule according to the transfer priority of each row. The test component within the row that has the highest value takes priority. If an individual's transfer test meets all conditions of the test equivalency rule, then the Transfer Credit process uses the equivalent course as defined on the row with the highest transfer priority. However, if the individual's transfer test does not meet the conditions of the test equivalency rule, then the Transfer Credit process evaluates the row with the next highest transfer priority.
Min/Max Score (minimum and maximum score)	Enter the minimum and maximum score of applicable transfer tests for this row of the test equivalency rule, or enter the minimum percentile.
Minimum Percentile	Enter the minimum percentile of the applicable transfer tests for this row of the test equivalency rule, or enter the minimum and maximum score.
Begin/End Date	By default, the system sets the begin and end date of the transfer test to <i>01/01/1900</i> and <i>12/31/9999</i> . You can override these default values. These dates inform the Transfer Credit process when the applicable transfer test must be taken for this row of the test equivalency rule.

Field or Control	Description
Maximum Age	This field defines, in years, the maximum age of the transfer tests for this row of the test equivalency rule. This prevents an individual from transferring test credit into your academic institution if the individual took the test more years ago than the number of years that you specify here. By default, the system sets the maximum age of a transfer test to 99, but you can override this default value. For instance, you might want to restrict an individual from receiving transfer credit for a test if the individual took the test more than 4 years prior to the date that your institution processes the individual's transfer credit.
Course ID	Enter the course to which the given test component is equivalent. The system prompts you with courses from your academic institution's course catalog. You can add rows to create a one-to-many test equivalency rule. You are prompted from your course catalog. The system automatically populates the Course Offering Number and Units Taken fields with values from the course catalog definition. You can enter a different offering number and enter different units.
Course Offering Number	By default, the system displays the course offering number of the specified course according to the value in your academic institution's course catalog. You can override this default value.
Units Taken	By default, the system displays the units taken value of the specified course according to the value in your academic institution's course catalog. You can override this default value.

Related Links

[Creating Course Offerings](#)

Defining Test Equivalencies for Academic Programs and Plans

To set up test equivalencies for programs and plans, use the Program/Test Equivalency (TEST_EQUIV) component.

This section discusses how to set test equivalencies for academic programs and plans.

Page Used to Define Test Equivalencies for Academic Programs and Plans

Page Name	Definition Name	Navigation	Usage
Test Credit Equivalency	TEST_CREDIT_EQUIV	Records and Enrollment > Transfer Credit Rules > Program/Test Equivalency > Test Credit Equivalency	Set the test transfer equivalency rules that the Transfer Credit process uses to evaluate transfer test credit for specific academic programs and academic plans.

Setting Test Equivalencies for Academic Programs and Plans

Access the Test Credit Equivalency page (**Records and Enrollment > Transfer Credit Rules > Program/Test Equivalency > Test Credit Equivalency**).

This example illustrates the fields and controls on the Test Credit Equivalency page. You can find definitions for the fields and controls later on this page.

Test Credit Equivalency

Institution: PSUNV PeopleSoft University
Academic Program: LAU Liberal Arts Undergraduate
Academic Plan:

Find | View All First 1 of 1 Last

*Effective Date: 01/01/1900 BT *Status: Active ▼

*Description: SAT Test Results - LAU

*Grading Scheme: UGD 🔍 Undergraduate Grading Scheme

*Grading Basis: GRD 🔍 Graded

*Transfer Grade: T 🔍 Transfer

Test Equivalency Rules

*Default: SATI 🔍 SAT Test Rules - LAU

Override: 🔍

General Fields

Field or Control	Description
Grading Scheme	By default, the system displays the grading scheme of the specified academic program. Define grading schemes for academic programs on the Academic Program page in the Academic Program Table component. Define grading schemes for academic careers on the Academic Career Table page. You can override this default value now, and you can override this value later for individual transfer tests that you process. This grading scheme defines all of the valid grading bases from which you can select a default transfer grade for this academic program or academic plan.
Grading Basis	By default, the system displays the grading basis default for transfer credit according to the specified academic program. Define grading-basis default for transfer-credit values for academic programs on the Academic Program page in the Academic Program Table component. Define grading-basis default for transfer-credit values for academic careers on the Academic Career Table page. You can override this default value now, and you can later override this value for individual transfer tests that you process. This grading basis defines all of the valid grades from which you can select a default transfer grade for this academic program or academic plan.
Transfer Grade	By default, the system displays the default transfer grade of the specified academic program. Define default transfer grades for academic programs on the Academic Program page in the Academic Program Table component. Define default transfer grades for academic careers on the Academic Career Table page. You can override this default value now, and you can override this value later for individual transfer tests that you process. This transfer grade defines the grade an individual receives for tests that articulate into the specified academic program or academic plan.

Test Equivalency Rule

Use the fields in this group box to select the specific test transfer equivalency rules for this academic program or academic plan. As the Transfer Credit process evaluates test credit, it applies the rules in this order: Override, Default.

Field or Control	Description
Default	<p>The Transfer Credit process uses the test equivalency rule that you specify on this row last. If the transfer test meets the criteria of the rule specified on this row, the process applies the rule to the transfer test and evaluates the test no further. If you did not specify a rule for this row, or if the transfer test does not meet the criteria of the rule, the process does not articulate the test. In this case, the transfer test appears on the on the Test Credit Details page with a status of <i>no rule</i>.</p> <hr/> <p>Note: If you have only one rule for this academic program or academic plan, you must enter it in the Default field. The Default field is the only required field on the page.</p>
Override	<p>The Transfer Credit process uses the test equivalency rule that you specify on this row first. If the transfer test meets the criteria of the rule specified on this row, the process applies the rule to the transfer test and evaluates the test no further. If you did not specify a rule for this row, or if the transfer test does not meet the criteria of the rule, the process then evaluates the test equivalency rule that you specify on the Default row.</p> <p>For example, you might have a general test equivalency rule for the Undergraduate Liberal Arts program but have a different rule for the English plan within this academic program. You would create two test transfer equivalency rules, enter the Liberal Arts program equivalency rule in the Default field, and then enter the English plan equivalency rule in the Override field.</p>

Chapter 10

Setting Up Attendance Tracking

Prerequisites for Setting Up Attendance Tracking

Before you can generate class attendance rosters or record student attendance, you must:

1. Define attendance type translate values in PeopleSoft Application Designer.
2. Set a default attendance type for each academic institution in your system.
3. Define courses in the course catalog.
4. Define all possible instruction modes, attendance types, and attendance type data for each course component in the course catalog.
5. (Optional) Set the attendance tracking generation flag for each class in the schedule of classes.

Setting Up Attendance Tracking Data

This section discusses how to:

- Define attendance type translate values.
- Select a default class meeting attendance type.
- Define attendance tracking options for course components.
- Indicate attendance roster generation for a class.

Pages Used to Set Up Attendance Tracking

<i>Page Name</i>	<i>Definition Name</i>	<i>Navigation</i>	<i>Usage</i>
Academic Institution Table 3	INSTITUTION_TABLE3	Set Up SACR > Foundation Tables > Academic Structure > Academic Institution Table > Academic Institution 3	Specify a default class meeting attendance type for each institution.
Course Catalog - Components	CRSE_CATALOG_CMPNT	Curriculum Management > Course Catalog > Course Catalog > Components	Set catalog-level defaults for both batch attendance roster generation and instruction mode.

Page Name	Definition Name	Navigation	Usage
Schedule of Classes - Basic Data	CLASS_ENTRY	<ul style="list-style-type: none"> • Curriculum Management > Schedule of Classes > Schedule New Class > Basic Data • Curriculum Management > Schedule of Classes > Maintain Schedule of Classes > Basic Data 	Modify the Generate Class Mtg Attendance (generate class meeting attendance) check box and instruction mode values that appear by default from the Course Catalog - Components page.

Defining Attendance Type Translate Values

PeopleSoft Application Designer delivers the following attendance type translate values: Conference, Instructor Consultation, Field Trip, Class Meeting, and Study Group. Use PeopleSoft Application Designer to modify or add to these values. The field name is CLASS_ATTEND_TYP. However, be careful to not delete a value that is in use.

Selecting a Default Class Meeting Attendance Type

Use the Academic Institution Table 3 page to specify a default class meeting attendance type for each institution. In background processing mode, the system generates only one roster per class (even if you specified multiple attendance types on the Components page), so the value that you specify applies to all classes. The system uses the default attendance type value that you specify to determine the correct attendance type row and related attendance type detail for each class. Each class should have at least one row on the Course Catalog - Components page, with the same attendance type as the default attendance type.

Related Links

“Setting Additional Institution Defaults and Options” (Campus Solutions Application Fundamentals)

Defining Attendance Tracking Options for Course Components

Use the Course Catalog - Components page to set catalog-level defaults for both batch attendance roster generation and instruction mode and to define all possible attendance types and attendance type detail data.

Related Links

[Defining Course Components](#)

Indicating Attendance Roster Generation for a Class

Use the Schedule of Classes - Basic Data page to modify the **Generate Class Mtg Attendance** (generate class meeting attendance) check box and instruction mode values that are supplied by default from the Course Catalog - Components page. You can set this option at the catalog level and the schedule of

classes level. This check box enables you to select the exact course components and classes for which your institution generates attendance rosters.

Related Links

[Defining Basic Data for Class Sections](#)

Preparing to Track Student Data

Common Elements Used in Preparing to Track Student Data

<i>Field or Control</i>	<i>Description</i>
Transcript Level	Select the transcript level on which you want the given data to print. Values for this field are delivered with your system as translate values. You can modify these values. The delivered values are <i>Degr Prog</i> (degree progress), <i>Not Print</i> , <i>Official</i> , <i>Stdnt Life</i> (student life), and <i>Unofficial</i> .

Related Links

[Understanding Transcript Levels](#)

Setting Up Academic Standing

To set up academic standing, use the Academic Standing Table component (ACAD_STDNG_TBL) and the Academic Standing Rule component (ACAD_STDNG_RULE).

With academic standing action codes and rules, you can create sets of guidelines for every academic career within your institution. You can then use these codes and rules to assign academic standing to students, either by running the Acad Standing/Honors Awards process (SRPCEASD) through the Academic Standing/Honors and Awards page to evaluate students' academic standing, or by entering academic standing codes directly onto a student's term history record through the Academic Standing page.

This section discusses how to:

- Define academic standing action codes.
- Create academic standing rules.
- Link academic standing, honors, and award rules to academic programs.

Related Links

[Tracking Academic Standing](#)

Pages Used to Set Up Academic Standing

Page Name	Definition Name	Navigation	Usage
Academic Standing Table	ACAD_STDNG_TBL	Set Up SACR > Product Related > Student Records > Student Standing and Awards > Academic Standing Table > Academic Standing Table	Define academic standing action codes for every academic career within your institution.
Academic Standing Rule	ACAD_STDNG_RULE	Set Up SACR > Product Related > Student Records > Student Standing and Awards > Academic Standing Rule > Academic Standing Rule	Create academic standing rules. Academic standing rules are keyed by academic career, so define a broad description for an academic standing rule (such as <i>Undergraduate Rules</i> or <i>Graduate Rules</i>). Within each rule, you create detail lines that correspond with academic standing action codes that you define.
Standing/Honors	ACAD_PROG_STDG_TBL	Set Up SACR > Foundation Tables > Academic Structure > Academic Program Table > Standing/Honors	Link academic standing rules to academic programs.

Defining Academic Standing Action Codes

Access the Academic Standing Table page (**Set Up SACR > Product Related > Student Records > Student Standing and Awards > Academic Standing Table > Academic Standing Table**).

This example illustrates the fields and controls on the Academic Standing Table page. You can find definitions for the fields and controls later on this page.

Academic Standing Table

Academic Institution: PSUNV PeopleSoft University

Academic Career: UGRD Undergraduate

Find | View All 1 of 1

***Effective Date:** 01/01/1900 BT ***Status:** Active + -

Find | View All 1 of 8 + -

***Academic Standing Action:** DIS1

***Description:** Dismissal 1 **Short Description:** Dismissal

***Academic Standing Status:** Dismissed + -

***Formal Description:** Dismissed

***Internal Description:** Dismissed

***Transcript Level:** Official + -

Creating academic standing action codes is a precursor to defining academic standing rules. Therefore, to define academic standing action codes, you must think about how they can be used in the rule sets for the academic standing process.

For example, suppose that students at your institution receive two warnings before being placed on probation and the warnings are of different degrees. That is, if students receive a second warning it is more severe. In this case you would define two different academic standing action codes for warnings because you want to distinguish them. Later, you define rule details for these codes, and for all other academic standing action codes defined on this page.

Note: If you want to inactivate an academic standing action code that is attached to an academic standing rule, delete the code where it is attached to the rule on the Academic Standing Rule page and enter a status of *Inactive* on the Academic Standing Table page.

Field or Control	Description
Academic Standing Action	Enter an academic standing action code.
Academic Standing Status	<p>Select an academic standing status. Values for this field are delivered with your system as translate values. You can modify these values. The delivered values are <i>Dismissed</i>, <i>Good Standing</i>, <i>Probation</i>, and <i>Subject to Dismissal</i>.</p> <p>You can have many academic standing action codes that contain the same academic standing status. For example, <i>DIS1</i>, <i>DIS2</i>, and <i>DIS3</i> can all contain a status of <i>Dismissed</i>.</p>
Formal Description	Enter a formal description. If you choose to have the academic standing action appear on a student's transcript, the system displays the formal description.

Field or Control	Description
Internal Description	Enter a description to be used for internal purposes only.
Transcript Level	Select the transcript level on which you want the academic stranding to print. Values for this field are delivered with your system as translate values. These translate values can be modified. The delivered values are <i>Deg Prog</i> (degree progress), <i>Not Print</i> , <i>Official</i> , <i>Stdnt Life</i> (student life), and <i>Unofficial</i> .

Related Links

[Understanding Transcript Levels](#)

Creating Academic Standing Rules

Access the Academic Standing Rule page (**Set Up SACR > Product Related > Student Records > Student Standing and Awards > Academic Standing Rule > Academic Standing Rule**).

This example illustrates the fields and controls on the Academic Standing Rule page (1 of 2). You can find definitions for the fields and controls later on this page.

Academic Standing Rule

Academic Career: UGRD Undergraduate PeopleSoft University

*Academic Standing Rule	*Effective Term	Term	Description	Short Description	
UGRD	0290	1997 Fall	Academic rules for undergrads	AS-Ugrd	+ -

Find | View All 1 of 1

Academic Standing Rule: UGRD **Effective Term:** 0290 1997 Fall

GPA and Units Detail Find | View All First 1 of 8 Last

Seq. No: 10 ***Academic Standing Action:** DIS1 Dismissal 1

Cumulative GPA:	<input type="text" value="LT"/>	<input type="text" value="2.000"/>	And/Or:	<input type="text" value="And"/>
Current Term GPA:	<input type="text" value="LT"/>	<input type="text" value="2.000"/>	And/Or:	<input type="text"/>
Cumulative Units Passed:	<input type="text"/>			
Current Units Passed:	<input type="text"/>			
Cumulative Units Attempted:	<input type="text"/>			
Current Units Attempted:	<input type="text"/>			
Academic Year GPA:	<input type="text"/>			

Exclude No GPA Attempted Units

This example illustrates the fields and controls on the Academic Standing Rule page (2 of 2). You can find definitions for the fields and controls later on this page.

The screenshot shows a web interface titled "Academic Standing Detail". At the top right, there are navigation controls: "Find | View All", "First", "1 of 8", and "Last". Below the title bar, the "Seq. No." is set to "10" and the "Academic Standing Action" is "DIS1 Dismissal 1". There are two checkboxes: "Any Academic Standing Set" (unchecked) and "No Academic Standing Set" (unchecked). Under "Prior Term Academic Standing:", there are two columns of input fields. The first column has five fields, with the first containing "PRB1" and "Probation 1" below it. The second column has five empty fields. Each input field has a magnifying glass icon to its right.

Field or Control	Description
Academic Standing Rule	Enter an alphanumeric code that identifies this academic standing rule code.
Effective Term	Select the effective term of the rule. When the system uses the rules that you define here in the Academic Standing process, it verifies that the rule is effective within the term for which the process is running.
Seq No (sequence number)	Enter the sequence number order in which the system evaluates the rule. Sequence your rules from the most severe academic standing action to the least severe. After a student's academic standing matches one academic standing rule, the Academic Standing process applies the academic standing action code to the student's record and moves on to the next student.
Academic Standing Action	Enter the academic standing action code that you want the system to post to students' records if the rule is satisfied. The system populates the Academic Standing page with the appropriate code once you run the academic standing process.

Field or Control	Description
<p>Cumulative GPA, Current Term GPA, Cumulative Units Passed, Current Units Passed, Cumulative Units Attempted, Current Units Attempted, and Academic Year GPA</p>	<p>These criteria form your rules. For each criterion that you choose to use in this rule, select a qualifier: <i>Greater Than</i>, <i>Greater Than or Equal To</i>, <i>Less Than</i>, or <i>Less Than or Equal To</i>. Do not modify these values. Then, enter the numeric value for each criterion. In the preceding example, the cumulative grade point average must be less than 2.000 <i>and</i> the current grade point average must be less than 2.000.</p> <p>Use the last prompt box to add the connector for the rule: <i>And</i>, <i>Or</i>, and blank for none.</p> <p>You can skip any criteria and only enter information in the criteria pertinent for your rule. See the examples to understand the sequencing of rules.</p> <hr/> <p>Note: For the Academic Year GPA field, the system looks at the term for which academic standing is being processed, determines the academic year in which the term falls based on the value in the Term/Session Table component, determines the student's statistics from all terms in that academic year, calculates the student's grade point average, then compares the student's grade point average against the value that you enter on this page.</p>
<p>Exclude No GPA Attempted Units</p>	<p>Select this check box in order to exclude from reporting all classes that were attempted, but are not included in the student's GPA (for example, Pass/No Pass courses, W grades, and so on). The grade's corresponding Include in GPA check box on the Grading Scheme Table page must be cleared (not selected) in order for the system to exclude it from processing. Clear this check box in order to include in your report all attempted coursework, regardless of the assigned grade.</p>
<p>Any Academic Standing Set</p>	<p>Select if it does not matter what academic standing action codes students can have on their records prior to this rule evaluation. The other fields on the page become unavailable for input.</p>
<p>No Academic Standing Set</p>	<p>Select if the student's record should possess no academic standing action code.</p>
<p>Prior Term Academic Standing</p>	<p>Select any academic standing code that the student must possess in a prior term to satisfy the rule. For example, in the preceding page shot, the student must possess the <i>PRB1</i> (probation 1) code in addition to meeting the grade point average requirements.</p>

Note: By selecting the **No Academic Standing Set** check box and selecting prior academic standing values, the academic standing rule reads as an OR statement. For this rule to apply, the student's record must either possess the academic standing values for the prior term that you select, possess no academic standing action code, or have no prior term for comparison.

Example of an Academic Standing Rule

Suppose that you defined seven different academic standing action codes for undergraduates. Because you want to use all of these codes in the Academic Standing process, you have eight rule detail lines in your academic standing rule, each line numbered from sequence number 10 (being the most severe academic standing action code) to sequence number 90 (being the least severe academic standing action code).

The following examples demonstrate some ways to set up academic standing rules.

The Sequencing of Rule Details

This example illustrates the Academic Standing Rule page for the *Dismissal 2* action:

Academic Standing Rule

Academic Career: UGRD Undergraduate PeopleSoft University

*Academic Standing Rule	*Effective Term	Term	Description	Short Description	
UGRD	0290	1997 Fall	Academic rules for undergrads	AS-Ugrd	+ -

Find | View All 1 of 1

Academic Standing Rule: UGRD Effective Term: 0290 1997 Fall

GPA and Units Detail Find | View All First 2 of 8 Last

Seq. No: 20 *Academic Standing Action: DIS2 Dismissal 2 + -

Cumulative GPA: LT 2.000 And/Or: And

Current Term GPA: LT 2.000 And/Or: And

Cumulative Units Passed: []

Current Units Passed: []

Cumulative Units Attempted: GE 20.000 And/Or: []

Current Units Attempted: []

Academic Year GPA: [] Exclude No GPA Attempted Units

Academic Standing Detail Find | View All First 2 of 8 Last

Seq. No: 20 Academic Standing Action: DIS2 Dismissal 2 + -

Any Academic Standing Set No Academic Standing Set

Prior Term Academic Standing:

PRB1 Probation 1 PRB2 Probation 2

PRB3 Probation 3 []

On this page:

- The system evaluates this rule second because the sequence number is 20, and one other rule detail line with a lower sequence number exists.
- The cumulative grade point average and current grade point average requirements are higher than that of the sequence number 10 rule, but can be the same or less than that of subsequent rules.

You can have the same grade point average requirement, for instance, for probation and dismissal. Differentiate these actions by the prior academic standing codes students must possess.

- Students must possess one of the academic standing action codes listed in the **Prior Term Academic Standing Value** field in addition to satisfying the grade point average rules, to satisfy the *Dismissal 2* rule detail.

This example illustrates the Academic Standing Rule page for the *Probation 2* academic standing action code:

Academic Standing Rule

Academic Career: UGRD Undergraduate PeopleSoft University

*Academic Standing Rule	*Effective Term	Term	Description	Short Description
UGRD	0290	1997 Fall	Academic rules for undergrads	AS-Ugrd

Find | View All 1 of 1

Academic Standing Rule: UGRD Effective Term: 0290 1997 Fall

GPA and Units Detail

Find | View All First 4 of 8 Last

Seq. No: 40 *Academic Standing Action: PRB2 Probation 2

Cumulative GPA:

Current Term GPA: And/Or:

Cumulative Units Passed:

Current Units Passed:

Cumulative Units Attempted:

Current Units Attempted:

Academic Year GPA: Exclude No GPA Attempted Units

Academic Standing Detail

Find | View All First 4 of 8 Last

Seq. No: 40 Academic Standing Action: PRB2 Probation 2

Any Academic Standing Set No Academic Standing Set

Prior Term Academic Standing:

Warning - may be placed on PRB Warning-may be placed on prbn

On this page:

- The rule detail line is evaluated fourth by the system because the sequence number is 40, and three other detail lines with lower sequence numbers precede it.
- The system posts the *Probation 2* academic standing action code on student records when they possess a current term grade point average less than 2.000 in conjunction with one of the academic standing action codes selected.
- Students must possess one of the academic standing action codes listed in the **Prior Term Academic Standing Value** field in addition to satisfying the grade point average rules, to satisfy the *Probation 2* rule detail.

Least Severe Rule Detail

In your rules, the least severe rule detail line is one for *Warning-may be placed on prbn* (warning-may be placed on probation).

This example illustrates the Academic Standing Rule for this rule:

Academic Standing Rule

Academic Career: UGRD Undergraduate PeopleSoft University

*Academic Standing Rule	*Effective Term	Term	Description	Short Description
UGRD	0290	1997 Fall	Academic rules for undergrads	AS-Ugrd

Find | View All 1 of 1

Academic Standing Rule: UGRD **Effective Term:** 0290 1997 Fall

GPA and Units Detail

Find | View All First 7 of 8 Last

Seq. No: 70 ***Academic Standing Action:** WRN2 Warning-may be placed on prbn

Cumulative GPA: LT 2.000 **And/Or:** And

Current Term GPA: GE 2.000 **And/Or:**

Cumulative Units Passed:

Current Units Passed:

Cumulative Units Attempted:

Current Units Attempted:

Academic Year GPA: Exclude No GPA Attempted Units

Academic Standing Detail

Find | View All First 7 of 8 Last

Seq. No: 70 **Academic Standing Action:** WRN2 Warning-may be placed on prbn

Any Academic Standing Set No Academic Standing Set

Prior Term Academic Standing:

WRN1 Warning - may be placed on PRB

On this page:

- The rule detail line is evaluated last by the system because the sequence number is 80, and seven other detail lines with lower sequence numbers precede it.
- Students must possess a cumulative grade point average and a current term grade point average that is greater than or equal to 2.000.

In addition, the student must possess one of the following academic-standing action codes stipulated on the Academic Standing Rule page.

- Students must possess at least one of the academic standing action codes on their record, in addition to the rules set on the Academic Standing Rule page to satisfy the *Warning-may be placed on prbn* rule detail.

Good Standing Rule Detail

In your rules, the last rule detail line is one for *Good Standing*.

This example illustrates the Academic Standing Rule page for this rule:

Academic Standing Rule

Academic Career: UGRD Undergraduate PeopleSoft University

*Academic Standing Rule	*Effective Term	Term	Description	Short Description
UGRD	0290	1997 Fall	Academic rules for undergrads	AS-Ugrd

Find | View All 1 of 1

Academic Standing Rule: UGRD Effective Term: 0290 1997 Fall

GPA and Units Detail Find | View All First 9 of 9 Last

Seq. No: 90 *Academic Standing Action: GOOD Good Standing

Cumulative GPA: GE 2.000 And/Or: And

Current Term GPA: GE 2.000 And/Or: Or

Cumulative Units Passed:

Current Units Passed:

Cumulative Units Attempted:

Current Units Attempted:

Academic Year GPA: Exclude No GPA Attempted Units

Academic Standing Detail Find | View All First 9 of 9 Last

Seq. No: 90 Academic Standing Action: GOOD Good Standing

Any Academic Standing Set No Academic Standing Set

On this page:

- This detail line is evaluated last because the sequence number is 90, and all other rule detail lines precede it possessing lower sequence numbers.
- Students must possess a cumulative grade point average and a current-term grade point average that is greater than or equal to 2.000.

In addition, the student may possess any academic standing action codes stipulated on the Academic Standing Rule page.

Linking Academic Standing, Honors, and Awards Rules to Academic Programs

Access the Standing/Honors page (Set Up SACR > Foundation Tables > Academic Structure > Academic Program Table > Standing/Honors).

This example illustrates the fields and controls on the Standing/Honors page. You can find definitions for the fields and controls later on this page.

Academic Program
Standing/Honors
Taxonomy/Campus
Repeat/Incomplete
Enrollment
▶

Academic Institution: PSUNV PeopleSoft University
Academic Program: LAU Liberal Arts Undergraduate

Find | View All First ◀ 1 of 1 ▶ Last

Effective Date: 01/01/1900 **Status:** Active

Academic Standing

Academic Standing Rule: Academic rules for undergrads

Calculate in Batch Only

Associate with Academic Prog

Obey Fully Graded Date

Exclude Term Category 1:

Exclude Term Category 2:

Exclude Term Category 3:

Honors/Awards

Honor Award Rule: Undergraduate Honors

Calculate in Batch Only

Associate with Academic Prog

Obey Fully Graded Date

Exclude Term Category 1:

Exclude Term Category 2:

Exclude Term Category 3:

Honor and Award Date Flag:

Academic Standing

<i>Field or Control</i>	<i>Description</i>
Academic Standing Rule	Select the academic standing rule for this academic program.

Field or Control	Description
Calculate in Batch Only	<p>Select to calculate academic standing through a background process using the Academic Standing/Honors Awards page.</p> <p>If you select this check box, the system does not calculate academic standing dynamically, such as when you post grades.</p> <p>Clear to have the system call the academic standing process when posting or changing a grade on the Quick Enrollment or Enrollment Request pages, and when posting a grade on the Grade Roster page. The academic standing process inserts an updated academic standing row, viewable on the Academic Standing page of the Term History component, except when a student's class is graded with a grade that count towards GPA and then later changed to a non-GPA grade. In such a scenario, you must manually update the student's academic standing on the Academic Standing page.</p>
Obey Fully Graded Date	<p>Select to calculate academic standing only when grades are posted on or later than the fully graded date. The system does not calculate academic standing if this check box is selected and grades are posted before the student's fully graded date.</p> <p>You define the default fully graded date on the Academic Term Calendar 3 page in the Academic Calendar component and an individual student's fully graded date on Term Control Dates page in the Term Activation component.</p>
Associate with Academic Prog (associate with academic program)	<p>Select to associate the academic standing rule only with students in this academic program. This is especially useful for students who might be in multiple academic programs; you might want to apply different academic standing rules with different academic programs. If you do not select this check box, the system associates the academic standing rule with the student's academic career.</p>
Exclude Term Category 1, Exclude Term Category 2, and Exclude Term Category 3	<p>Select the terms in which the system does not calculate academic standing. Values for this field are delivered with your system as translate values. You can modify these values.</p>

Honors/Awards

Field or Control	Description
Honor Award Rule	Select the honor award rule for this academic program.

Field or Control	Description
Calculate in Batch Only	Select to calculate the honors and awards in batch through the Academic Standing/Honors Awards page. If you select this check box, the system does not calculate honors and awards dynamically, such as when you post grades.
Obey Fully Graded Date	Select to calculate honors and awards only when grades are posted on or later than the fully graded date. The system does not calculate honors and awards if the Obey Fully Graded Date check box is selected and grades are posted before the student's fully graded date. You define the default fully graded date on the Academic Term Calendar 3 page in the Academic Calendar component and an individual student's fully graded date on Term Control Dates page in the Term Activation component.
Associate with Academic Prog (associate with academic program)	Select to associate the honor/award rule only with students in this academic program. This is especially useful for students who might be in multiple academic programs; you might want to apply different honor/award rules with different academic programs. If you do not select this check box, the system associates the honor/award rule with the student's academic career.
Exclude Term Category 1, Exclude Term Category 2, and Exclude Term Category 3	Select the terms in which the system does not calculate honors/awards. Values for this field are delivered with your system as translate values. You can modify these values.
Honor and Award Date Flag	Select the date type that the system posts to students' records for their honors and awards. Values for this field are delivered with your system as translate values. You can modify these values with some programming effort. Values are <i>System Date</i> and <i>Fully Graded Date</i> .

Setting Up Honors and Awards

To set up honors and awards, use the Honors/Awards Table component (SA_HONORS_AWARDS) and the Honors/Awards Rule component (HONOR_AWRD_RULE).

Honors and awards include internal and external awards that you want to record for students. With honor and award codes and rules, you can create sets of guidelines for every academic career within your institution. You can then use these codes and rules to assign honors and awards to students, either by running the Acad Standing/Honors Awards process (SRPCEASD) through the Academic Standing/Honors and Awards page to evaluate students' honors and awards, or by entering honor/award codes directly onto a student's record through the Honors and Awards page.

This section discusses how to:

- Define honor/award codes.
- Create honor and award rules.

Related Links

[Tracking Honors and Awards](#)

Pages Used to Set Up Honors and Awards

<i>Page Name</i>	<i>Definition Name</i>	<i>Navigation</i>	<i>Usage</i>
Honors/Awards Table	SA_HON_AWRD_TABLE	Set Up SACR > Product Related > Student Records > Student Standing and Awards > Honors/Awards Table > Honors/Awards Table	Define honor and award codes for internal and external awards.
Honors and Awards Rule	HONOR_AWRD_RULE	Set Up SACR > Product Related > Student Records > Student Standing and Awards > Honors/Awards Rule > Honors and Awards Rule	Create honor and award rules.
Standing/Honors	ACAD_PROG_STDG_TBL	Set Up SACR > Foundation Tables > Academic Structure > Academic Program Table > Standing/Honors	Select honor and award rules and parameters for this academic program.

Defining Honor/Award Codes

Access the Honors/Awards Table page (**Set Up SACR > Product Related > Student Records > Student Standing and Awards > Honors/Awards Table > Honors/Awards Table**).

<i>Field or Control</i>	<i>Description</i>
Internal/External	Indicate whether the honor or award relates to an external organization or your internal institution.
Grantor	Enter the grantor of the honor or award.

Field or Control	Description
Transcript Level	Select the transcript level on which you want the honor or award to print. Values for this field are delivered with your system as translate values. These translate values can me modified. The delivered values are <i>Degr Prog</i> (degree progress), <i>Not Print</i> , <i>Official</i> , <i>Stdnt Life</i> (student life), and <i>Unofficial</i> .

Creating Honor Award Rules

Access the Honors and Awards Rule page ((Set Up SACR > Product Related > Student Records > Student Standing and Awards > Honors/Awards Rule > Honors and Awards Rule).

This example illustrates the fields and controls on the Honors and Awards Rule page. You can find definitions for the fields and controls later on this page.

Honors and Awards Rule

Academic Career: UGRD Undergraduate PeopleSoft University

Honor Award Rule	Effective	Term	Description	Short Desc
UGRD	0290	1997 Fall	Undergraduate Honors	Ugrd Honor

Find | View All First 1 of 1 Last

Honor Award Rule: UGRD Effective Term: 0290 1997 Fall

Find | View All First 2 of 5 Last

GPA and Units Detail

*Honor/Award Group:	01	*Seq. No:	20
*Honor/Award:	DEANLS	Dean's List	
Cumulative GPA:	GE	3.500	And/Or: And
Current Term GPA:			
Cumulative Units Passed:			
Current Units Passed:			
Cumulative Units Attempted:			
Current Units Attempted:	GE	12.000	
Academic Year GPA:			

Find | View All First 2 of 5 Last

Honor/Award Group:	01	Seq. No:	20
Honor/Award:	DEANLS	Dean's List	
Any Academic Standing Set	<input checked="" type="checkbox"/>	No Academic Standing Set	<input type="checkbox"/>
Current Term Academic Standing:			

Define rules for every honor and award code that you want to use in the Honors/Awards process. Honor and award rules are keyed by academic career; therefore, create a broad description for your honor and award rules (such as *Undergraduate Rules* or *Graduate Rules*). To define honor and award rules, name the rule, define parameters for the rule, and select the academic standing codes that a student must currently possess in order for the rule detail line to be satisfied. Every rule detail line can have current academic-standing code requirements. For instance, you can require that in addition to other criteria you defined,

the student possesses the academic standing code of *GOOD* to meet the requirements for the *Highest Freshman GPA Award*.

Field or Control	Description
Honor Award Rule	Enter an alphanumeric code that identifies this honor and award rule code.
Effective Term	Select the effective term for the rule. When the system uses the rules in the Honor/Award process, it verifies that the rule is effective within the term for which the process is run.
Honor/Award Group	<p>The default honor and award group number is 01. Group awards together that are mutually exclusive, because the system processes honors and awards by group, and within a group by sequence number.</p> <p>For example, the President's Award and the Dean's List honors are mutually exclusive. If students are granted one award they are not granted the other. By grouping the awards together, you prevent the system from granting a student both awards.</p>
Seq No (sequence number)	<p>Enter the sequence in which the system evaluates the rule. Sequence your rules from the most restrictive to the least restrictive.</p> <p>In our example, the President's Award has a sequence number of 10 and the Dean's List honor has a sequence number of 20. The President's Award is more restrictive than the Dean's List honor, so it is sequenced first. The Dean's List honor is slightly less selective, so it is sequenced second.</p>
Honor/Award	Select the honor and award code that the system posts to students' records if they satisfy the rule. Define honor and award codes on the Honors/Awards Table page. The system populates the student Honors and Awards page with the appropriate code when you run the Honors/Awards process.

Field or Control	Description
<p>Cumulative GPA, Current Term GPA, Cumulative Units Passed, Current Units Passed, Cumulative Units Attempted, Current Units Attempted, and Academic Year GPA</p>	<p>These criteria form your rules. For each criterion that you choose to use in this rule, select a qualifier: <i>Greater Than</i>, <i>Greater Than or Equal To</i>, <i>Less Than</i>, or <i>Less Than or Equal To</i>. Do not modify these values. Then, enter the numeric value for each criterion. In the preceding example, the cumulative grade point average must be greater than or equal to 3.750 and the current grade point average must be greater than or equal to 3.750.</p> <p>Use the last prompt box to add the connector for the rule: <i>And</i>, <i>Or</i>, and blank for none.</p> <p>You can skip any criteria and only enter information in the criteria pertinent for your rule.</p> <hr/> <p>Note: For the Academic Year GPA field, the system looks at the term for which academic standing is being processed, determines which academic year the term falls in based on the value in the Term/Session Table component, determines the student's statistics from all terms in that academic year, calculates the student's grade point average, then compares the student's grade point average against the value that you enter on the page.</p>
<p>Any Academic Standing Set</p>	<p>Select if the student would be eligible for this honor or award no matter what his or her academic standing.</p>
<p>No Academic Standing Set</p>	<p>Select if the student would be eligible for this honor or award only if he or she was not assigned an academic standing code.</p>
<p>Current Academic Standing Values</p>	<p>Select the academic standing values a student must possess to satisfy this rule. Define academic standing values on the Academic Standing Table page. In the preceding example, the student must possess the academic standing code of GOOD to satisfy the rule. Define academic standing values on the Academic Standing Table page.</p>

Setting Up Special Grade Point Averages

To set up special grade point averages, use the Student Special GPA component (SPECIAL_GPA_TYPE).

Every institution has its own unique way of calculating grade point averages. Special grade point averages are averages that you define for your institution that differ from the cumulative grade point average. You can enter special grade point averages for a student's academic program, academic plan, or academic subplan. You can then use these special grade point averages to meet your institution's analysis and reporting needs.

This section lists the page used to set up special grade point averages.

Related Links

[Tracking Special Grade Point Averages](#)

Page Used to Set Up Special Grade Point Averages

<i>Page Name</i>	<i>Definition Name</i>	<i>Navigation</i>	<i>Usage</i>
Student Special GPA	SPCGPA_TYPE_TBL	Set Up SACR > Product Related > Student Records > Grading > Student Special GPA > Student Special GPA	Define the types of grade point averages (GPAs) that your institution tracks by entering an effective date, status, and description for each GPA type.

Reviewing Committees and Committee Members

Use committees to indicate advisory roles. Committees can be faculty standing committees, dissertation committees, thesis committees, and so on. Because committees are discussed in more detail in the PeopleSoft Campus Community documentation, we only review them briefly here.

To use committees and committee members:

1. Define committee types and the roles of committee members on the Committee Table page.
2. Assign specific committees to the committee types that you defined on the Committee Table page.
3. Assign committee members to specific committees on the Committee Members page.

Related Links

“Setting Up Committee Types and Roles” (Campus Community Fundamentals)

“Creating Committees” (Campus Community Fundamentals)

“Assigning Committee Members” (Campus Community Fundamentals)

Setting Up Milestones

To set up milestones, use the Milestone Table component (MILESTONE_TBL) and Milestone Template component (MILESTONE_TMPL).

Milestones are non-course related but vital requirements that a student must complete toward degree progress to graduate. You might be able to relate milestones most easily to graduate student progress, but your institution might also use milestones for undergraduates as well. After you define milestones, you can assign milestones and advisors to a student, as well as record the student's completions of milestones and attempts to fulfill them, by using the Student Milestones component.

This section discusses how to:

- Define milestone codes.

- Create milestone templates.

Related Links

[Tracking Milestones](#)

Pages Used to Set Up Milestones

<i>Page Name</i>	<i>Definition Name</i>	<i>Navigation</i>	<i>Usage</i>
Milestone Table	MILESTONE_TBL	Set Up SACR > Product Related > Student Records > Enrollment > Milestone Table > Milestone Table	Define milestones.
Milestone Templates	MILESTONE_TMPL	Set Up SACR > Product Related > Student Records > Enrollment > Milestone Templates > Milestone Templates	Create milestone templates to reduce data entry later on.

Defining Milestone Codes

Access the Milestone Table page (**Set Up SACR > Product Related > Student Records > Enrollment > Milestone Table > Milestone Table**).

This example illustrates the fields and controls on the Milestone Table page. You can find definitions for the fields and controls later on this page.

Milestone Table

Academic Institution: PeopleSoft University
Milestone: AUDITION

Find 1 of 1

*Effective Date: 01/01/1900 31 *Status: Active + -

*Description:

*Formal Description:

*Calculate Required Date: v

*Calculate Anticipated Date: v

*Transcript Level: v

*Print Milestone Detail: v

Attempts Allowed:

Grading Scheme: 🔍 Undergraduate Grading Scheme

Grading Basis: 🔍 Pass/Not Pass

Self-Service Availability

Allow Student Self-Service Allow Advisor Self-Service

Allow Student Attachment Allow Advisor Attachment

Information For Students:

Performance students should contact their assigned advisor for instructions and requirements regarding auditions. 📄

Enter Milestone Levels Here Personalize | Find | 📄 | 📅 | First 1-2 of 2 Last

*Milestone Level	*Description	*Formal Description	+ -
DANCE	Dance Audition	Dance Audition	+ -
MUSIC	Music Performance Audition	Music Performance Audition	+ -

Note: To inactivate a milestone code, remove that code from every milestone template in addition to entering a status of Inactive on this page.

<i>Field or Control</i>	<i>Description</i>
Calculate Required Date and Calculate Anticipated Date	If you enter a value, for example <i>Expected Grad Term Start Date</i> , the date/term is calculated when you add a milestone for a student on the Student Milestone page or when you run the Process Milestone process.

Field or Control	Description
Print Milestone Detail	Select a print milestone detail to indicate whether the milestone detail information appears on the transcript. Milestone detail information includes the details on the Student Milestones page.
Attempts Allowed	Enter the number of attempts students can make at completing the milestone. This field is a default data entry and tracking aid. You can override the attempts allowed on individual student records.
Grading Scheme	Select a grading scheme for the milestone. When you enter the milestone on a student's record, you can override the grading scheme.
Grading Basis	Select a grading basis for the milestone. Link grading bases to grading schemes on the Grading Scheme Table page. You can override this value on individual student records.

Self-Service Availability

Field or Control	Description
Allow Student Self-Service	<p>Select the check box to allow students to access information about the milestone in Self Service.</p> <p>If the check box is selected, the milestone appears in the Milestone section on the Student Center page. Students click the details link to access the Student Milestones Details self-service page (SS_SR_MILESTON_SEC).</p>

Field or Control	Description
Allow Advisor Self-Service	<p>Select the check box to allow advisors to access information about the milestone in Self Service.</p> <p>If the check box is selected, advisors can access the Student Milestones Details self-service page through the Advisor Center.</p>

Field or Control	Description
Allow Student Attachment and Allow Advisor Attachment	Select the check box to allow students and advisors to add attachments — for example, an advisor might attach instruction or reference materials for students to use.
Information for Students	The information that you enter here can be viewed by students in Self Service.

See “Setting Up a Self-Service Student Center” (Campus Self Service).

“Understanding Self-Service Student Center” (Campus Self Service)“Using Self-Service Student Center” (Campus Self Service)

Enter Milestone Levels Here

Field or Control	Description
Milestone Level	Enter an alphanumeric code that identifies this milestone level code. You use milestone levels for detailing the progress of a milestone and for informational purposes. For example, you might define a milestone of <i>Written Comprehensive Exams</i> for doctoral students and have four levels within that milestone to designate the four sets of comprehensives required.

(NZL) Defining Milestones for Unit Standards

When you define a milestone for New Zealand institutions, use the NQF Detail group box to enter a **Milestone Type** of *U* and link NQF codes to the milestone.

See [Linking NQF Codes to Milestones](#).

Related Links

[Tracking Milestones](#)

[Creating Transcript Text](#)

[Reviewing Transcript Print Areas](#)

Creating Milestone Templates

Access the Milestone Templates page (**Set Up SACR > Product Related > Student Records > Enrollment > Milestone Templates > Milestone Templates**).

This example illustrates the fields and controls on the Milestone Templates page. You can find definitions for the fields and controls later on this page.

Milestone Templates

Academic Institution: PeopleSoft University Academic Career: Undergraduate
 Academic Program: Academic Plan:

Find | View All 1 of 1

*Effective Date: 02/04/1997 *Status: Active

*Description: Undergraduate

Find | View All 1 of 2

*Milestone: QUALEXAM *Milestone Nbr: 10

Milestone Level: Milestone Level: Milestone Level:

*Description: Undergrad Qualifying Exam

*Formal Description: Undergrad Qualifying Exam

Milestone Title:

Comment:

[Manage Milestone Documents](#)

*Calculate Required Date: Do Not Calculate

Term Required: Date Required: Date Required:

*Calculate Anticipated Date: Do Not Calculate

Anticipated Term: Anticipated Date: Anticipated Date:

*Transcript Level: Official *Print Milestone Detail: Always

Advised by Committee

Personalize | Find First 1 of 1 Last

*Advisor	Name	
<input type="text"/>	<input type="text"/>	+ -

Attempts Allowed: 3

Grading Scheme: GRA Graduate School Grading Scheme

Grading Basis: SUS Satisfactory/Unsatisfactory

If you link a milestone template to only an academic institution and academic career, it can be used as a template for any academic program or plan. If you want a milestone template to be restricted to a specific academic program or plan, enter the program and plan in the search dialog box. When you link milestones to academic programs you are making a template, not a permanent link. This information appears in the Student Milestones component when you copy the template to the student's record.

For information about the fields on this page:

See [Defining Milestone Codes](#).

Related Links

[Tracking Milestones](#)

Setting Up Extracurricular Activities

To set up extracurricular activities, use the Extracurricular Activity Table component (EXTRA_ACTIVITY_TBL).

You can track both internal and external extracurricular activities for individuals.

This section discusses how to set up extracurricular activity codes for this purpose. You later use the Extracurricular Activity page to link these codes to students.

Page Used to Set Up Extracurricular Activities

<i>Page Name</i>	<i>Definition Name</i>	<i>Navigation</i>	<i>Usage</i>
Extracurricular Activity Table	EXTRA_ACTIVITY_TBL	Set Up SACR > Product Related > Campus Community > Define Campus Community > Setup > Extracurricular Activity Table > Extracurricular Activity Table	Set up extracurricular activity codes, and define the primacy of the extracurricular activities for your setID.

Setting up Extracurricular Activity Codes

Access the Extracurricular Activity Table page ((**Set Up SACR > Product Related > Campus Community > Define Campus Community > Setup > Extracurricular Activity Table > Extracurricular Activity Table**)).

<i>Field or Control</i>	<i>Description</i>
Activity Type	Select the type of activity that you are entering. Values for this field are delivered with your system as translate values. You can modify these values. The delivered values are <i>Athletics, Club, Employment, Music, Other, Publications, Student Government, Theater, and Volunteer</i> .
Internal and External	Select this option to indicate that this extracurricular activity exists at your institution as well as at external institutions.
Internal	Select this option to indicate that this extracurricular activity exists at your institution only.
External	Select this option to indicate that this extracurricular activity exists at external institutions only.

<i>Field or Control</i>	<i>Description</i>
Extra Activity Primacy	Enter the primacy number for this extracurricular activity. When you run the Consolidate Academic Statistics process it searches students' extracurricular activity records for only the <i>athlete</i> extracurricular activity. The <i>athlete</i> extracurricular activity is delivered with your system. It should not be modified in any way because it has code attached to it. If the Consolidate Academic Statistics process finds multiple <i>athlete</i> records for a student, it writes the one with the lowest primacy number to the student's consolidated statistics record.

Related Links

[Understanding Consolidated Statistics Processes](#)

[Understanding Consolidate Academic Statistics Process Calculations](#)

Managing Student Groups

Student groups enable you to set up groups (such as *Athlete* or *Freshman*) and assign these groups to individuals. Then you can perform actions (such as run reports and processes) on a group, which affects all of the individuals in the group.

This section lists the page used to manage student groups. You later use the Student Groups page to assign student groups to students.

Page Used to Manage Student Groups

<i>Page Name</i>	<i>Definition Name</i>	<i>Navigation</i>	<i>Usage</i>
Student Groups	STDNT_GROUPS	Student Recruiting > Maintain Prospects > Academic Information > Student Groups > Student Groups	Set up student groups (such as <i>Athletes</i> and <i>Resident Assistants</i>) by entering the effective date, status, and description of each student group.

Setting Up Student Attributes

To set up student attributes, use the Student Attribute Table component (STDNT_ATTR_TBL).

This section provides an overview of student attributes and discusses how to:

- Define student attribute codes.
- Define student attribute values.

Related Links

[Tracking Student Attributes](#)

Understanding Student Attributes

Although student groups enable you track attributes such as participation in clubs, sports, and student government, you might need an additional, more flexible structure that lets you track the attributes of your students based on their career and program. To meet this need, use the Student Attributes feature.

The Student Attributes feature enables you to assign all sorts of attributes to a student within an academic career or program and group together the students with similar student attributes. You can then track and report on the student attribute data. For instance, you can track students that begin their education at the same time as a single cohort by creating a student attribute for undergraduate incoming freshmen and attaching the attribute to the records of these students. You can then use the data for federal reporting and also for institutional research purposes to gain information about the type of students that you have in a particular cohort, such as a student's typical course load or how long it takes a student to complete his or her program and graduate.

You can create multiple attributes and multiple attribute values within a single attribute. Then when you assign these attributes to students, you can attach to their records multiple attributes and multiple values within each student attribute. With this flexibility, your students can belong to as many cohorts as necessary to meet your tracking and reporting needs. You can assign these attributes to students at any time, even during the recruiting and admissions processes because the attributes roll from PeopleSoft Recruiting and Admissions to Student Records as part of the student's academic career and academic program.

Use the Student Attribute Table component to define different student attributes and student attribute values. You can create broad student attributes for entire academic careers, then attach single student attribute values to each of those careers. For example, you can create a student attribute for undergraduate students called *Student Cohort*. You can then create different values for *Student Cohort* on the Student Attribute Value Table page (such as *Fall 2005 Entry Class*, *Fall 2006 Entry Class*, and *Fall 2007 Entry Class*). In addition, you can create smaller student attributes for individual academic programs. You can also define student attribute values for plans and subplans and group them under a specific academic program.

After you define all your student attributes and student attribute values, use the Student Attributes page to attach these attributes and attribute values to individual students and build reports on the data so you can track statistics such as how many students in a particular cohort graduated in three years, four years, and five years, and how heavy their course load was. The system also reports a primary student attribute as part of the Consolidate Academic Statistics process.

Pages Used to Set Up Student Attributes

<i>Page Name</i>	<i>Definition Name</i>	<i>Navigation</i>	<i>Usage</i>
Student Attributes Table	STDNT_ATTR_TBL	Set Up SACR > Product Related > Student Records > Student Standing and Awards > Student Attribute Table > Student Attributes Table	Define the various student attributes your institution uses for tracking and reporting on different cohorts.

<i>Page Name</i>	<i>Definition Name</i>	<i>Navigation</i>	<i>Usage</i>
Student Attribute Value Table	STDNT_ATTR_VAL_TBL	Set Up SACR > Product Related > Student Records > Student Standing and Awards > Student Attribute Table > Student Attribute Value Table	Define the values associated with a particular student attribute.

Defining Student Attribute Codes

Access the Student Attributes Table page (**Set Up SACR > Product Related > Student Records > Student Standing and Awards > Student Attribute Table > Student Attributes Table**).

<i>Field or Control</i>	<i>Description</i>
Academic Career	(Optional) Select the academic career to which the student attribute is linked.
Academic Program	(Optional) Select the academic program to which the student attribute is linked.

Defining Student Attribute Values

Access the Student Attribute Value Table page (**Set Up SACR > Product Related > Student Records > Student Standing and Awards > Student Attribute Table > Student Attribute Value Table**).

<i>Field or Control</i>	<i>Description</i>
Student Attribute Value	Enter an alphanumeric code that identifies this student attribute value.
Primacy	Enter the primacy number for the student attribute. The system uses the number to determine the primary student attribute value it uses when you extract data to report on cohorts. This primacy value has no relation to Financial Aid primacy. The lowest number takes precedence.

Note: Always assign the lowest primacy number to the student attribute value that you want to use for federal reporting of this student attribute.

Chapter 12

Setting Up Grading

Understanding Grade Preparation

Student Records provides a variety of grade-related features. From institution and career-based rules to repeat schemes, grade rosters, grade change audits, and midterm deficiency analysis, you can use the different grade-related components to set up and manage grading processes.

Grade bases comprise individual grades, and grade schemes comprise grade bases. Typically, grade schemes are unique for each career in your institution. Grade schemes are not manually assigned to individual classes. Instead, the system dynamically matches grade schemes that are assigned to one career with classes of the same career.

Before you can grade students, you must define all possible grading schemes for all careers. You can have different grading schemes for different careers. Within each grading scheme, you define all valid grade bases, grades, and grade-related detail.

In addition, the system enables you to convert grades from one grading scheme to another. We call this grade-basis mapping feature our *intelligent grade basis exception table*. For example, when an undergraduate student enrolls in a graduate course (and the graduate course is associated with a graduate grading scheme), you might not want to grade the student according to the graduate grade scheme. Rather, you set up exception rules so that the system reroutes the student's grade scheme to the appropriate undergraduate grade scheme. On the Grading Basis Exception Rule page, you define all possible exception scenarios that the system must handle. For example, you can set up a rule that requires the system to convert a graduate grading scheme into an undergraduate grading scheme. This way, you ensure that grade schemes are appropriate for the student, based on the student's career (rather than the career of the class). Setting up exception rules is optional.

Finally, when all of your grade data is set up and instructors are ready to enter grades, you must generate the grade rosters. You can generate rosters on an individual class basis or in batch. Generating the rosters is a required, final step in making the rosters available for grade entry.

Setting Up Your System for Grading

To set up your system for grading, use the Grading Scheme Table component (GRADE_SCHEME) and the Grading Basis Exception Rule component (GRD_BASE_EXCEPTION).

This section provides an overview of grading setup and discusses how to:

- Define grading schemes.
- Define grading basis exception rules.
- Run the Grade Basis Exception report.

- Create grade rosters for a single class.
- Create grade rosters for multiple classes.

Understanding Grading Setup

Complete these steps to set up grading:

1. Define grade basis values:
 - a. Select PeopleTools, Utilities, Translate Values to add or change translate values.
 - b. Search on the GRADING_BASIS field name, which takes you to the table where you define grade basis values.
2. Define grading schemes on the Grading Scheme Table page.
3. (Optional) Define grade basis exceptions on the Grading Basis Exception Rule page.
4. (Optional) Run the Grade Basis Exception Report to review active grade basis exception mapping rules and their details.
5. Generate grade rosters on either the Grade Roster Type page or the Create Grade Rosters page.

Pages Used to Set Up Your System for Grading

<i>Page Name</i>	<i>Definition Name</i>	<i>Navigation</i>	<i>Usage</i>
Grading Scheme Table	GRADING_SCHEME_TBL	Set Up SACR > Foundation Tables > Academic Structure > Grading Scheme Table > Grading Scheme Table	Define all valid grading schemes. Enter each grading scheme and the associated grades on this page.
Grading Basis Exception Rule	GRD_BASE_EXCEPTION	Set Up SACR > Product Related > Student Records > Grading > Grading Basis Exception Rule > Grading Basis Exception Rule	Map typical student-requested grade bases to existing grading basis rules.
Grade Basis Exception	RUNCTL_SRGBEXCPT	Set Up SACR > Product Related > Student Records > Reports > Grade Basis Exception > Grade Basis Exception	Run reports that display active grade basis exception mapping rules and their details.

Page Name	Definition Name	Navigation	Usage
Grade Roster Type	GRADE_ROSTER_TYPE	Curriculum Management > Grading > Grade Roster > Grade Roster Type	Define grade rosters on a class-by-class basis. To print the grade roster, use the Grade Roster Print page. Prerequisite: If you want to use blind grading for this class, select the Use Blind Grading check box on the Class Associations page or select the Use Blind Grading check box on the Course Catalog Offerings page. Then, the system populates the Use Blind Grading check box each time that you create a class association.
Create Grade Rosters	RUNCTL_GRD_ROSTER	Curriculum Management > Grading > Create Grade Rosters > Create Grade Rosters	Create grade rosters for each term and session by subject area or by academic organization. To print the grade rosters, use the Grade Roster Print page. If you want to use blind grading for this class, select the Use Blind Grading check box on the Class Associations page or select the Use Blind Grading check box on the Course Catalog Offerings page so that the system uses blind grading each time that you schedule the class. The system then populates the Use Blind Grading check box each time that you create a class association.
Complete Grade Flag	SSR_GRADE_FLAG_TBL	Set Up SACR > Product Related > Student Records > Grading > Complete Grade Flag > Complete Grade Flag	Define complete grade flag values to be used on the Grading Scheme Table page. In New Zealand, these values are used for reporting purposes.

Defining Grading Schemes

Access the Grading Scheme Table page (**Set Up SACR > Foundation Tables > Academic Structure > Grading Scheme Table > Grading Scheme Table**).

This example illustrates the fields and controls on the Grading Scheme Table page. You can find definitions for the fields and controls later on this page.

The screenshot shows the 'Grading Scheme Table' interface. At the top, there are navigation links: 'Find | View All' and 'First 1 of 1 Last'. Below this, the 'SetID' is 'PSUNV' and the 'Grading Scheme' is 'UGD'. The 'Effective Date' is '01/01/1900' and the 'Status' is 'Active'. The 'Description' is 'Undergraduate Grading Scheme' and the 'Short Desc' is 'Undergrad'. The 'Grade Basis' section includes fields for 'Grade Basis' (AUD), 'Formal Description' (Audit), 'Grade Basis Convert', 'Grade Basis Choice Default', and 'Default AA What If Grade' (AU). It also has checkboxes for 'Include in GPA', 'Grade Required', 'Elective Grade Basis', 'Print On Transcript', 'Print Grade Basis Desc', and 'Audit Grade Basis'. The 'Grade Input' section includes fields for 'Grade Input' (AU), 'Convert To Grade', 'Description' (Audit), 'Short Desc' (Audit), 'Grade Points' (0.000), 'Complete', and 'Grade Category' (NONE). It also has checkboxes for 'In Progress Grade', 'Include in GPA', 'Earn Credit', 'Valid Attempt', and 'Include in Self Service'. The 'Drop/Withdraw Penalty Grades' section includes fields for 'Drop with Penalty', 'Drop with Greater Penalty', 'Withdraw with Penalty', and 'Withdraw with Greater Penalty', all set to 'W' (Withdraw).

Grading schemes are linked to academic careers and academic programs.

Field or Control	Description
Status	Enter a status for this grading scheme. Enter <i>Active</i> when adding a new grading scheme. Enter <i>Inactive</i> only if your institution no longer uses this grading scheme.
Description	Enter a description for the grading scheme.
Short Desc (short description)	Enter a short description for the grading scheme.
Grade Basis	Enter a grade basis. Grade basis values are entered into your system as translate values, which you can modify. A Grade Basis of NON (Non-Graded) is required for each grading scheme. This value is assigned for non-graded sections, such as labs associated with a lecture. To activate this grading basis, do not select any of the check boxes and do not enter any grades.

Field or Control	Description
Formal Description	Enter a formal description of the grading basis.
Grade Basis Convert	Enter a grade basis convert value to use grades that are associated with another grading basis. If you enter a value in this field, the Grade Input group box becomes unavailable because the grade basis references the grade input data of another grade basis.
Grade Basis Choice Default	If you select the Elective Grade Basis check box, you can enter a grade basis choice default to specify the default grade basis for this grading scheme. In addition, you can enter all of the possible grading basis choices in the fields that become available in the bottom third of the page. The system uses the default value during enrollment. If students have the option to select other grade bases, they can do so at enrollment time.
Include in GPA (include in grade point average)	Select to include grades from this grading scheme in grade point average (GPA) calculations.
Grade Required	<p>Select to specify this grade basis as required, for the purposes of the Grade Review - Transcript Release process. When you evaluate students using the Grade Review process, those classes in which the students are enrolled with a <i>required</i> grade basis must have all of their grades; otherwise, a transcript is not generated for the student.</p> <p>Selecting this option can prevent transcripts from printing until all of a student's term grades are posted.</p> <p>See Processing Batch Transcripts (Application Engine).</p>
Elective Grade Basis	Select to enter the grading bases from which the student may select during enrollment.
Print on Transcript	Select to display, on the transcript, classes that are graded with this grade basis. If you do not select this option, all class data for courses that have grades that are from this grade basis do <i>not</i> appear on the transcript.
Print Grade Basis Desc (print grade basis description)	Select to have the formal description of the grade basis appear on the transcript.
Audit Grade Basis	Select to indicate that the grading scheme is audit-only. If you select this check box, the following check boxes in the Grade Input group box become unavailable: In Progress Grade , Include in GPA , and Earn Credit .

Field or Control	Description
Grade Input	If you enter a grade basis and clear the Elective Grade Basis check box, or if you do not enter a value in the Grade Basis Convert field, the Grade Input field becomes available. Enter all of the valid grade values for the grading scheme in the Grade Input field. Add rows as necessary.
Convert To Grade	When you post grades, the system converts the originally entered grade to the convert to grade if a value exists in the Convert to Grade field. This field is optional. The convert to grade must be within the grading scheme that you are currently defining.
Description	Enter a description for the grade input.
Short Desc (short description)	Enter a short description for the grade input.
Exclude Progress Units	Select to have the system exclude this grade from progress units. For example, you would select this check box for a <i>W</i> or withdrawal grade.
Grade Points	Enter the grade points for the grade input. The system uses these grade points, in conjunction with the units attempted for the class, when it calculates GPA.
Complete	This field is user-defined. Define complete values on the Complete Grade Flag page. In New Zealand, this field is used for reporting purposes.
Grade Category	<p>Use this field to give a grade additional identity. You can assign a grade category to a particular grade or a group of grades, and then use these assignments for advanced advising analysis purposes, such as requisite checking or academic advising limits. By default, the system populates the Grade Category field with <i>None</i>.</p> <p>A typical example of a grade category is <i>Pass</i> or <i>Transfer Pass</i>. You can use academic advising to limit the number of classes with grade categories of <i>Transfer Pass</i> that count toward degree requirements. Select from a list of grade categories that are defined by your institution.</p> <p>Grade categories are defined on the Grade Category Table page.</p> <p>See “Setting Up Grade Category Values” (Academic Advisement).</p>
In Progress Grade	Select to indicate that this is an in-progress type of grade. A typical example of an in-progress grade would be an incomplete grade.

Field or Control	Description
Include in GPA (include in grade point average)	Select to include the grade that you specify in GPA calculations. An example of when you would <i>not</i> select this check box is for a <i>Pass</i> grade.
Earn Credit	Select to specify that the grade can be counted toward course and academic advising credit.
Valid Attempt	<p>Select to mark each grade value as representing a valid course attempt. PeopleSoft Academic Advisement uses this setting to distinguish between grades for valid course attempts (A, B, C, D, F, and so forth) and grades for invalid course attempts (AU, W, and so forth).</p> <p>If you select this check box, Academic Advisement can distinguish between valid and invalid course attempts when the values in the Units Attempted, Earned Credit, and GPA fields are the same.</p>
Include in Self Service	Select to enable the grade input value to be assigned and edited on the Faculty Center Grade roster. If you clear this check box, instructors cannot assign or edit this grade on the self-service grade roster. A typical example is to clear the check box for a <i>W</i> , an administrative withdrawal grade.
Repeat Checking Option	<p>Select an option to indicate whether a class with this grade should be counted as a repeat candidate and whether the class should be processed by the Repeat Checking process. Values are:</p> <ul style="list-style-type: none"> • <i>1) Count = Y Process = Y:</i> If you select this option, any class with this grade is counted in the pool of repeat attempts and is selected and processed when the Repeat Checking process is run. • <i>2) Count = Y Process = N:</i> If you select this option, any class with this grade is counted in the pool of repeat attempts, but is not selected and processed when the Repeat Checking process is run. • <i>3) Count = N Process = Y:</i> If you select this option, any class with this grade is not counted in the pool of repeat attempts, but is selected and processed when the Repeat Checking process is run. • <i>4) Count = N Process = N:</i> If you select this option, any class with this grade is not counted in the pool of repeat attempts, nor is it selected and processed when the Repeat Checking process is run.

This table shows an example:

Course	Grade	Units Attempted	Earned Credit	GPA	Valid Attempt
English 101	W (user defined)	3.00	0.00	0.00	No
English 101	F	3.00	0.00	0.00	Yes

Note: The PeopleSoft Academic Advisement application considers class attempts that have no grade as valid attempts.

Drop/Withdraw Penalty Grades

When processing drops during the penalty periods, the enrollment engine uses the penalty grades specific to the student's grading basis, as defined on the Grading Scheme Table page. If you do not define penalty grades for the student's grading basis, the enrollment engine instead uses the grading bases and grades that you define on the Session Calendar1 page (for withdraw grades) and the Session Calendar 2 page (for drop grades). We strongly suggest that you define penalty grades at the grade basis level to ensure that students receive penalty grades specific to their intended grade basis for the class, and not the penalty grade that is assigned to all students in the session, regardless of whether the penalty grade is from the student's original grade basis.

For example, when you drop a student from a class for which the `stdnt_enrl.grading_basis_enrl = AUD` during Drop With Greater Penalty and a drop with greater penalty grade exists in the `GRADE_TBL` for AUD, the system assigns the drop with greater penalty grade to the student. If no drop with greater penalty grade exists at the grade table level for an AUD grade basis, the system instead uses the grading basis and grade from the `ACAD_CALSES_TBL`, as defined on the Session Calendar2 page.

See “Setting Up Session Cancellation and Withdrawal Dates” (Campus Solutions Application Fundamentals).

See “Setting Up Session Drop Dates” (Campus Solutions Application Fundamentals).

Field or Control	Description
Drop with Penalty	Enter the penalty grade that students who are enrolled with this grade basis receive for a class if they drop the class <i>after</i> the drop-and-retain-record deadline but <i>on or before</i> the drop-with-penalty deadline. The grade for the class appears on students' transcripts and affect their GPA accordingly. Grade values are defined on the Grading Scheme Table page.
Drop with Greater Penalty	Enter the grade that students who are enrolled with this grade basis receive for a class if they drop the class <i>after</i> the drop-with-penalty deadline but <i>on or before</i> the drop-with-greater-penalty deadline. The grade for the class appears on students' transcripts and affect their GPA accordingly. Grade values are defined on the Grading Scheme Table page.

Field or Control	Description
Withdraw with Penalty	Enter the grade that students who are enrolled with this grade basis receive for a class if they withdraw after the withdraw-without-penalty deadline but on or before the withdraw-with-penalty deadline. The grade for the class appears on students' transcripts and affect their GPA accordingly. Grade values are defined on the Grading Scheme Table page.
Withdraw with Greater Penalty	Enter the grade that students who are enrolled with this grade basis receive for a class if they withdraw after the withdraw-with-penalty deadline but on or before the withdraw-with-greater penalty deadline. The grade for the class appears on students' transcripts and affect their GPA accordingly. Grade values are defined on the Grading Scheme Table page.

Grade Scheme Example: Using an Elective Grading Basis

Select the **Elective Grade Basis** check box for grade bases that permit students to choose different modes of grading for a class. Before you select this check box, define all of your grading basis choices

Grading Scheme Table

Find | View All First 1 of 1 Last

SetID: PSUNV Grading Scheme: UGD

*Effective Date: 01/01/1900 *Status: Active

*Description: Undergraduate Grading Scheme Short Desc: Undergrad

Grade Basis Find | View All First 4 of 8 Last

*Grade Basis: OPT Student Option Formal Description: Student Option Grade Basis Convert: <input type="text"/> Grade Basis Choice Default: GRD Graded Default AA What If Grade: <input type="text"/>	<input type="checkbox"/> Include in GPA <input checked="" type="checkbox"/> Grade Required <input checked="" type="checkbox"/> Elective Grade Basis <input type="checkbox"/> Print On Transcript <input type="checkbox"/> Print Grade Basis Desc <input type="checkbox"/> Audit Grade Basis
---	--

Grading Basis Choice Find First 1-3 of 3 Last

*Grading Basis Choice: AUD Audit	+ -
*Grading Basis Choice: GRD Graded	+ -
*Grading Basis Choice: PNP Pass/Not Pass	+ -

On this page, select:

- The **Elective Grade Basis** check box.

The system displays the **Grading Basis Choice** scroll area.

- All valid possible grading basis choices from which a student can choose for a class that is offered with this grade basis of *OPT*.

Grade Scheme Example: Converting Grade Basis

Enter a grade basis in the **Grade Basis Convert** field for *Satisfactory/Unsatisfactory (SUS)* grades to convert to your new and preferred grade basis of *Pass/Not Pass (PNP)*.

The screenshot shows the 'Grading Scheme Table' interface. At the top, it displays 'SetID: PSUNV' and 'Grading Scheme: UGD'. Below this, 'Effective Date' is set to '01/01/1900' and 'Status' is 'Active'. The 'Description' is 'Undergraduate Grading Scheme' and 'Short Desc' is 'Undergrad'. A sub-section titled 'Grade Basis' contains the following fields: 'Grade Basis' is 'SUS' (Satisfactory/Unsatisfactory), 'Formal Description' is 'Satisfactory/Unsatisfactory', 'Grade Basis Convert' is 'PNP' (Pass/Not Pass), and 'Default AA What If Grade' is 'S' (Satisfactory). On the right side of the 'Grade Basis' section, there are several checkboxes: 'Include in GPA' (unchecked), 'Grade Required' (checked), 'Elective Grade Basis' (unchecked), 'Print On Transcript' (unchecked), 'Print Grade Basis Desc' (unchecked), and 'Audit Grade Basis' (unchecked).

On this page, select the grade basis value in the **Grade Basis Convert** field. All courses that have a grade basis of *SUS* convert to a grade basis of *PNP*.

Grade Scheme Example: Setting Up a Requirement That References a Grade Category

At PSUNV, the maximum number of pass grades that can apply towards a Bachelor's degree is 24 units. From these 24 units, no more than six units can be from another institution. To establish this academic advising limit on pass grades, create two grade categories on the Grade Category Table page: *PASS* for Internal Pass and *TXFR* for Transfer Pass. Then, on the Grading Scheme Table page, assign to the grade *P* the grade category of *PASS* and assign to the grade *T* the grade category of *TXFR*.

In PeopleSoft Academic Advisement, create an academic requirement that is a global limit. Its first requirement line points to a derived list of all courses on a student's transcript with a grade that has a grade category of *PASS unioned* with a derived list of all courses on a student's transcript with a grade category of *TXFR*. The requirement line limit allows a maximum of 24 units and maximum of 999 courses (the system enforces the lower of these). Create a second requirement line (in the same academic requirement) that is also a global limit. It points to a derived list of all courses on a student's transcript with a grade that has a grade category of *TXFR*. The requirement line limit allows a maximum of six units. Attach this academic requirement to a requirement group at the career level, with a low reporting sequence number, so that the degree audit system evaluates it first during an advising evaluation. Any courses over the limit of allowed credits are excluded from the evaluation and are not counted towards the remaining career, program, plan, or subplan degree requirements.

Related Links

“Setting Up Requirement Line Item Detail” (Academic Advisement)

Defining Grading Basis Exception Rules

Access the Grading Basis Exception Rule page (**Set Up SACR > Product Related > Student Records > Grading > Grading Basis Exception Rule > Grading Basis Exception Rule**).

This example illustrates the fields and controls on the Grading Basis Exception Rule page. You can find definitions for the fields and controls later on this page.

Grading Basis Exception Rule

Find | View All First 1 of 1 Last

Academic Institution: PSUNV PeopleSoft University + -

Grading Basis Mapping Rule: UGRAD

***Effective Date:** 01/01/1900 B1 ***Status:** Active ▼

***Description:** Undergraduate Mappings

***Short Description:** Undergradu

Grading Basis Mapping

Find First 1-5 of 5 Last

*Grading Basis for Requested Class	Grading Basis Mapped for Student	
CNC 🔍 Crd/No Crd	<input type="checkbox"/> Grading Basis is Invalid	PNP 🔍 P/INP + -
GRD 🔍 Graded	<input type="checkbox"/> Grading Basis is Invalid	GRD 🔍 Graded + -
PNP 🔍 P/INP	<input type="checkbox"/> Grading Basis is Invalid	PNP 🔍 P/INP + -
SUS 🔍 Sat/Unsat	<input type="checkbox"/> Grading Basis is Invalid	PNP 🔍 P/INP + -
TRN 🔍 Transfer	<input checked="" type="checkbox"/> Grading Basis is Invalid	+ -

If grade bases are variable at your institution, you should define grade basis mapping rules. When students in one academic program or career enroll in classes in another program or career (that have a different grade basis), the system uses your grade basis mapping rules to convert grade basis values to those that are appropriate for the students' careers and programs.

Grading basis rules designate any and all schemes for grading, including the grade points for each grade.

You link grading basis exception rules to career pointer exception rules. Career pointer exceptions are linked to academic programs.

Grading basis exception rules are keyed by academic institution.

Field or Control	Description
Effective Date	Enter an effective date for this mapping rule.
Status	Enter a status for this mapping rule. Enter <i>Active</i> when adding a new mapping rule. Enter <i>Inactive</i> only if your institution no longer uses the mapping rule. <hr style="border: 0.5px solid black;"/> Note: If you inactivate the grading basis mapping rule, you must also remove it from the Career Pointer Exception page.
Description	Enter a description for the mapping rule.
Short Description	Enter a short description for the mapping rule.

Field or Control	Description
Grading Basis for Requested Class	<p>The grading basis from which you are mapping. Grading basis values are defined on the Grading Scheme Table page.</p> <hr/> <p>Warning! If a student attempts to enroll in a mapped cross-career course and the student selects a grade basis that you did not specify in the Grading Basis for Requested Class field as eligible for remapping, then the system considers their request invalid and denies the enrollment request.</p> <hr/>
Grading Basis is Invalid	<p>Select to invalidate the grading basis. In the preceding example, the <i>Transfer</i> grading basis is invalid. Students cannot select the <i>Transfer</i> grading basis for classes with this mapping rule.</p>
Grading Basis Mapped for Student	<p>The grading basis to which you are mapping. In our example, when an undergraduate student enrolls in a graduate class with a grading basis of <i>Satisfactory/Unsatisfactory</i>, the system converts their grade basis to <i>Pass/No Pass</i>. Grading basis values are defined on the Grading Scheme Table page.</p> <hr/> <p>Note: When a student enrolls, the mapped values appear prior to posting the enrollment, regardless of whether the student is using Campus Solutions Enrollment Request, Enrollment, Quick Enroll, or Student Self Service Enrollment.</p> <hr/>

Grade Basis Mapping Example

To understand how the enrollment engine determines the grade basis for a particular enrollment, look at how the system determines whether a student can enroll in a class that is not in the student's career. For example, Michael Holt, an undergraduate, wants to enroll in Marketing 500 in the Graduate Business career.

Michael's Career and Program	Requested Class	Course's Career	Grading Basis of Course	Expected Grading Basis
Undergraduate/liberal arts undergraduate (LAU) program	Marketing 500	Graduate Business	Satisfactory/Unsatisfactory (SUS)	Pass/No Pass (PNP)

When Michael tries to enroll in Marketing 500, the system first looks at the **Career Pointer Exception Rule** field on the Academic Program page for Michael's academic program (LAU).

Academic Program | Standing/Honors | Taxonomy/Campus | Repeat/Incomplete | Enrollment

Academic Institution: PSUNV PeopleSoft University
Academic Program: LAU

Find | View All | First 1 of 1 Last

*Effective Date: 01/01/1900 ***Status:** Active

*Description: Liberal Arts Undergraduate

*Short Description: Lib Arts **First Term Valid:** 0000 Begin Term

*Academic Career: UGRD Undergraduate

Grading Scheme: UGD Undergraduate Grading Scheme

GB Default for Transfer Credit: GRD Graded

Default Grade- Transfer Credit: T Transfer

*Academic Group: LBART College of Liberal Arts

*Academic Level Rule: UGRD Undergraduate

*Academic Calendar: USEM Undergraduate Semester Cal

Dual Academic Program:

Default Academic Plan: UNDECL-UG Undeclared Undergraduate

Default Campus: WALCR Walnut Creek Campus

*Transcript Level: Official

Career Pointer Exception Rule: LIBARTS Liberal Arts Exceptions

Only if Outside Career

If the field is cleared, grading basis mapping does not occur. Instead, the system looks at the Academic Career Pointers page to determine whether the student is eligible to enroll in the class. If enrollment is allowed, the system pulls from the course grading scheme as determined by the academic career that is noted on the Course Catalog - Offerings page. However, in our example, *LIBARTS* is selected in the **Career Pointer Exception Rule** field. Therefore, the system uses the LIBARTS exception rule on the Career Pointer Exception Rule page.

This example illustrates the Career Pointer Exception Rule page as explained above.

Career Pointer Exception Rule

Academic Institution: PSUNV PeopleSoft University
Career Pointer Exception Rule: LIBARTS

Find | View All | First 1 of 1 Last

*Effective Date: 01/01/1900 ***Status:** Active

*Description: Liberal Arts Exceptions

*Short Description: Lib Arts

Course Requested Find | First 1-2 of 2 Last

*Academic Group	Subject Area	Catalog Nbr	*Allow Enrollment	Grading Basis Mapping Rule
LBART	MATH	300	Yes	UGRAD
LBART	MATH	400	Permission	UGRAD

The system searches the **Course Requested** group box for rows that match the class in which the student is enrolling. In our example, Michael Holt is trying to enroll in Marketing 500. The system looks at the **Academic Group, Subject Area, and Catalog Nbr** (catalog number) fields. The catalog number of the requested course must be equal to or greater than the catalog number on this page. Because Marketing 500 is in the *MGMT* academic group and the *Marketing* subject area, and it is greater than or equal to 500, the system allows Michael to enroll in the class with permission. The system then maps the grading basis to the student's career or program using the value in the **Grading Basis Mapping Rule** field (*UGRAD*). Grading basis mapping rules are defined on the Grading Basis Exception Rule page.

This example illustrates the Grading Basis Exception Rule page as explained above.

*Grading Basis for Requested Class		Grading Basis Mapped for Student	
CNC	Crd/No Crd	<input type="checkbox"/> Grading Basis is Invalid	PNP P/NP
GRD	Graded	<input type="checkbox"/> Grading Basis is Invalid	GRD Graded
PNP	P/NP	<input type="checkbox"/> Grading Basis is Invalid	PNP P/NP
SUS	Sat/Unsat	<input type="checkbox"/> Grading Basis is Invalid	PNP P/NP
TRN	Transfer	<input checked="" type="checkbox"/> Grading Basis is Invalid	

The system uses the values on this page to determine how to map each grading basis. Because the grading basis for the requested class is *SUS* (satisfied/unsatisfied), the system maps to *PNP* (pass/no pass). Therefore, Michael's grading basis appears as *PNP* on enrollment pages.

The system maps the grading basis when you exit the **Class Input** field.

Special Note About the Elective Grading Basis

When a student attempts to enroll in a class outside of the student's career and the class is offered with a grade basis for which the **Elective Grade Basis** check box is selected, the system presents the student with the student's grading basis choice and a corresponding *grade basis convert to* value. Each of the pre-mapped choices is set up in the Grade Scheme table under the career of the class and under the elective grade basis. Because students in this cross-career enrollment situation can be exposed to grade bases that are outside of their career, it is essential that you set up remapping rules that accommodate each of the possible grade bases from which a student may choose. Insert rows to accommodate all possibilities in the grading basis for the **Requested Class** field on the Grading Basis Exception Rules page. You do *not* need to insert rows for grade bases that are invalid, but you can do so. In these situations, select the **Grading Basis is Invalid** check box. For elective grading bases, you *must* add a row for the elective basis (for example, if *OPT*, then convert to *OPT*), for individual grade bases that make up the elective (*OPT*) grading basis (for example, if *SUS*, then convert to *PNP*), and so on.

Running the Grade Basis Exception Report

Access the Grade Basis Exception page (**Set Up SACR > Product Related > Student Records > Reports > Grade Basis Exception > Grade Basis Exception**).

<i>Field or Control</i>	<i>Description</i>
Academic Institution	The academic institution for which you are reporting. The system populates this field. You can change the value.
As Of Date	Enter an as of date to report on all grade basis exception rules that are active as of this date. Normally, you enter a date that is the start of the term or term enrollment period.

Creating Grade Rosters for a Single Class

Access the Grade Roster Type page (**Curriculum Management > Grading > Grade Roster > Grade Roster Type**).

This example illustrates the fields and controls on the Grade Roster Type page. You can find definitions for the fields and controls later on this page.

Grade Roster Type		Grade Roster						
Course ID: 001276	Foundations of Higher Math	Offer Nbr: 1	PeopleSoft University					
Catalog: MATH 100		Class Section: 1	2006 Fall					
<input type="checkbox"/> Use Blind Grading		Class Nbr: 1192	Regular Academic Session					
*Grade Roster Type	*Description	Approval Status	Final Roster Grading Status	Override	Partial Post			
1 Mid-Term Grade	Mid-Term Grade	Not Reviewed		<input type="checkbox"/>		Create		+ -
2 Final Grade	Final Grade	Not Reviewed	Grade Input Allowed	<input checked="" type="checkbox"/>	<input type="checkbox"/>	Create	Post	+ -

<i>Field or Control</i>	<i>Description</i>
Grade Roster Type	Enter the type of grade roster that you want to generate. Grade roster type values are delivered with your system as translate values. While you should not change the <i>Final Grade</i> value, you can add as many nonfinal grade values as you want.
Description	The system provides the grade roster type description, taking it from the translate table. You can change this value.

Field or Control	Description
Approval Status	<p>Values for this field are delivered with your system as translate values. Do not modify these values in any way. Any modifications to these values require substantial programming. Values for approval status are <i>Not Reviewed</i>, <i>Ready for Review</i>, and <i>Approved</i>.</p> <p>The system does not permit you to post grade rosters that have an approval status of <i>Not Reviewed</i> or <i>Ready for Review</i> unless you select the Partial Post check box.</p> <hr/> <p>Note: You can save the data and make changes to the grades. After you approve and post, however, you must make any grade revisions on a student-by-student basis using one of the enrollment pages.</p> <hr/>
Final Roster Grading Status	The system populates the Final Roster Grading Status field based on the approval status for the class.
Override	<p>Select this check box and click the Create button to delete the previous grade roster and generate a new one for the class. If you do not select this check box and just click the Create button, the system appends any new students to the existing grade roster.</p>
Partial Post	<p>Select to manually enter and post grades for a class section, save it, and return later to finish entering and posting grades.</p> <hr/> <p>Note: Although you cannot approve the entire grade roster until you enter all grades, if you select the Partial Post check box, the system posts all grades that you entered to those students' records.</p> <hr/>
Posting Date	The system displays the posting date when the grade roster post process finishes.
Create	Click to create the grade roster. Go to the Grade Roster page to enter grades.
Post	Click to post the final grades to the grade roster after you enter them. The system changes the status on the Grade Roster 1 page to <i>Posted</i> . The system does not permit you to post grade rosters that have an approval status of <i>Not Reviewed</i> or <i>Ready for Review</i> unless you select the Partial Post check box.

Creating Grade Rosters for Multiple Classes

Access the Create Grade Rosters page (**Curriculum Management > Grading > Create Grade Rosters**).

This example illustrates the fields and controls on the Create Grade Rosters. You can find definitions for the fields and controls later on this page.

Create Grade Rosters

Run Control ID: PS [Report Manager](#) [Process Monitor](#)

*Academic Institution: PeopleSoft University

*Term: 2009 Spring

Session	Class End Date From	Class End Date To	Academic Organization	*Grade Roster	*Override Existing Grade Roster	*Total
<input type="text" value="Twelve Wk"/>	<input type="text" value="02/06/2009"/>	<input type="text" value="03/20/2009"/>	<input type="text" value="LIBARTS"/>	<input type="text" value="Final Grade"/>	<input type="text" value="No"/>	1 <input type="button" value="+"/> <input type="button" value="-"/>

Field or Control	Description
Academic Institution	Enter the academic institution for the grade roster process. This value controls the type of data that is available in the remaining fields.
Term	Enter the term for the grade roster. Term values are defined on the Term Table page.
Session	Enter the session for the grade roster. The session value is optional. Use it to limit your roster production to a single session within the specified term. Session values are defined on the Session Table page.
Class End Date From and Class End Date To	Select the class end date from and to dates. The system selects rosters to create for classes with an end date that is greater than or equal to the value in the Class End Date From field and less than or equal to the value in the Class End Date To field. Both fields are optional and one may be entered without the other.
Academic Organization and Subject Area	Enter the academic organization or subject area for which to produce the rosters. You can enter the academic organization or subject area, but not both. If you enter an academic organization, the Subject Area field is unavailable for entry. Conversely, if you enter a subject area, the Academic Organization field is unavailable for entry. Academic organization values are defined on the Academic Organization Table page. Subject area values are defined on the Academic Subject Table page.
Grade Roster	Enter the type of grade roster that you want to generate. Grade roster values are delivered with your system as translate values. While you should not change the <i>Final Grade</i> value, you can add as many nonfinal grade values as you want.

Field or Control	Description
Override Existing Grade Roster	<p>Available values are:</p> <p><i>Yes</i>: Enter to delete and override any preexisting grade rosters when you run the Create Grade Roster process, regardless of whether you selected the Override Grade Roster check box on the Grade Roster Type page.</p> <p><i>No</i>: Enter to retain all prior grade rosters when you run the Create Grade Roster process, regardless of whether you selected the Override Grade Roster check box on the Grade Roster Type page. The system produces rosters only for those classes for which rosters have not yet been generated and appends any currently enrolled students who are not on the original roster.</p>
Total	<p>If you selected a grade roster type of <i>MidTerm</i>, this field becomes available. The system enables you to create as many rosters as you need for each class, as long as it is not a <i>Final Grade</i> roster type. Enter the total number of non-final grade rosters that are needed for each class in the Total field.</p>

Run the PSJob SRPCGPR. Results of the Create Grade Rosters process appear on the Grade Roster page.

Chapter 13

Setting Up Degrees and Honors

Setting Up Degrees and Degree Honors

To set up degrees and degree honors, use the Degree Table component (SA_DEGREE_TABLE) and the Degree Honors Table component (DEGREE_HONORS_TBL).

The process of graduating students requires you to set up degrees and degree honors, to update student program records, and, if necessary, to report and audit degree changes. This section discusses the first of these requirements in detail. You should also familiarize yourself with the PeopleSoft Academic Advisement application, an important and automated precursor to approving students for graduation.

This section discusses how to:

- Define degrees.
- Attach degrees to academic plans.
- Define degree honors.

Related Links

“Understanding Online and Batch Advisement Transcript Reports” (Academic Advisement)

Pages Used to Set Up Degrees and Honors

<i>Page Name</i>	<i>Definition Name</i>	<i>Navigation</i>	<i>Usage</i>
Degree Table	SA_DEGREE_TABLE	Set Up SACR > Foundation Tables > Academic Structure > Degree Table > Degree Table	Define both internal and external degrees for PeopleSoft Recruiting and Admissions and Student Records.
Academic Plan Table	ACADEMIC_PLAN_TBL	Set Up SACR > Foundation Tables > Academic Structure > Academic Plan Table > Academic Plan Table	Define a degree for each academic plan.

Page Name	Definition Name	Navigation	Usage
Degree Honors Table	DEGREE_HONORS_TBL	Set Up SACR > Product Related > Student Records > Student Standing and Awards > Degree Honors Table > Degree Honors Table	<p>Define degree honors for your institution. Example degree honors might be <i>with Distinction, Highest Honors in, and Summa Cum Laude</i>.</p> <p>Student Records shares this page with Recruiting and Admissions because admissions staff may need to track external degree honors of applicants.</p>

Defining Degrees

Access the Degree Table page (**Set Up SACR > Foundation Tables > Academic Structure > Degree Table > Degree Table**).

This example illustrates the fields and controls on the Degree Table page. You can find definitions for the fields and controls later on this page.

Degree Table

Degree: BA

Find | View All
First 1 of 1 Last

*Effective Date:	01/01/1900	
*Status:	Active	
*Description:	Bachelor of Arts	
Short Description:	B.A.	
Formal Description:	Bachelor of Arts	
<input checked="" type="checkbox"/> Internal Degree		
Years Of Education:	<input type="text"/>	
Education Level:		
Previous Degree Type:	<input type="text"/>	
NZVCC Qualificatn Degree Code:	<input type="text"/>	
*Prospectus Code:	<input type="text"/>	
Qualification Award Category:	20 Bachelors	
<input checked="" type="checkbox"/> Report to MoE - SDR		

Field or Control	Description
Status	Select a status for this degree. Select <i>Active</i> when the degree is valid for your institution. You can keep all degrees in the database for historical purposes by setting any degrees that you no longer award to <i>Inactive</i> .
Description, Short Description, and Formal Description	Enter descriptions of the degree. Later, you can identify which description appears on the transcript.
Internal Degree	Select to indicate that the degree is internal to your institution and that it does not represent a degree from another organization.
Years of Education	No programming is tied to this field; use it for informational purposes only.
Educational Level	No programming is tied to this field; use it for informational purposes only. Values for this field are delivered with your system as translate values. You can modify these values.
(NZL) NZVCC Qualificatn Degree Code (New Zealand Vice Chancellors Committee qualification degree code)	Enter the NZVCC qualification code for this degree. The system uses this value when generating the Graduate Destinations Survey report. This field is available only when you select the NSI and SDR Personal Data, SDR Degree check box on the SA Features page on the Installation table.
(NZL) Prospectus Code	Enter the Ministry of Education (MoE) identifier. The system uses this value when generating the Qualification Completion file. This field is available only when you select the NSI and SDR Personal Data, SDR Degree check box on the SA Features page on the Installation table.
(NZL) Qualification Award Category	(Optional) No programming is tied to this field; use it for informational purposes only. Values for this field are delivered with your system as translate values. You can modify these values. This field is available only when you select the NSI and SDR Personal Data, SDR Degree check box on the SA Features page on the Installation table.
(NZL) Report to MoE - SDR (report to Ministry of Education - Single Data Return)	Select to include students awarded this degree in the Qualification Completions file. This field is available only when you select the NSI and SDR Personal Data, SDR Degree check box on the SA Features page on the Installation table.

Related Links

[Processing SDR Extracts](#)

Attaching Degrees to Academic Plans

Access the Academic Plan Table page (**Set Up SACR > Foundation Tables > Academic Structure > Academic Plan Table > Academic Plan Table**).

A student who is active in a program with more than one plan can potentially receive more than one degree when you set the student's degree checkout status to *Approved* and click the **Update Degrees** button on the Student Degrees page. Conversely, if a student has multiple plans under one program, and each of those plans is associated with the *same* degree, then the student receives only one degree when you set the degree checkout status to *Approved* and click the **Update Degrees** button on the Student Degrees page.

This is important to consider when you are setting up degrees for plans that are linked to the same program and in which students may have two or more of such plans under a single program at a given time. This is also important to consider when setting up double majors. For example, if you have a particular double major combination, for which you want only one degree, you may want to create two separate plans to represent each major but tie the double major degree to only one of the plans. Or you may want to create one plan that represents the double major. For students who attempt a degree with only one of these two majors, you would assign a different plan to them, with a slightly different degree. For example, instead of a bachelor of science degree in architecture and engineering, you might also create a degree that is a bachelor of arts in architecture, a degree that is a bachelor of science in architecture, and yet another degree that is a bachelor of science in engineering. Of course, you must also consider the effect that plan assignment has on your academic advisement setup and the way that you define plan- or program-based requirements.

Related Links

“Defining Academic Plans” (Campus Solutions Application Fundamentals)

Defining Degree Honors

Access the Degree Honors Table page (**Set Up SACR > Product Related > Student Records > Student Standing and Awards > Degree Honors Table > Degree Honors Table**).

Note: The Degree Honors Table page differs from the Honors/Awards Table page in that it relates to only internal degrees, plans, and subplans.

Field or Control	Description
Honor Type	<p>The type of honor and where it appears on the transcript.</p> <p>For example, an honors type of <i>Degree Plan Suffix</i> indicates that the honor appears on the transcript <i>after</i> the degree plan.</p> <p>Honor type choices are <i>Degree Prefix</i>, <i>Degree Suffix</i>, <i>Degree Honors</i>, <i>Degree Plan Prefix</i>, <i>Degree Plan Suffix</i>, <i>Degree Sub-Plan Prefix</i>, and <i>Degree Sub-Plan Suffix</i>. Values for this field are delivered with your system as translate values. Do not modify these values in any way. Any modifications to these values require a substantial programming effort.</p>
Status	<p>Select a status for the degree honor. Select <i>Active</i> when adding a new degree honor. Select <i>Inactive</i> only if your institution will no longer use this degree honor.</p>
Formal Description	<p>You can set up your transcript type so that the formal description prints on the diploma and transcript.</p>
Print on Diploma	<p>No programming is tied to this field; use for informational purposes only.</p>
Print on Transcript	<p>Select this check box to display the formal description of the degree honor on the transcript.</p>

Setting Up Transcripts

Understanding Transcript Levels

Important! The COBOL transcript process is a deprecated product. It is strongly recommended that you use the Application Engine transcript process instead. For more information on the Application Engine transcript process, see [Understanding Transcript-Related Processes](#).

On various pages throughout your Student Administration system, you are prompted to select the transcript level for which you want to print information. The transcript level you select determines the type of transcript on which the information appears. Transcript levels are hierarchically based on the two-digit numeric code in the value column of the translate table for the field TRANSCRIPT_LEVEL. The following table lists the transcript levels and their values in the translate table, and describes each one.

Note: Information in the table about the Advising Report applies only if you set up for COBOL based transcripts, using the Transcript Type component (TSCRPT_TYPE).

<i>Transcript Level</i>	<i>Value</i>	<i>Description</i>
Not Print	00	Do not print the information on any transcript.
Official	20	Print the information on the official transcript, the unofficial transcript, and the student life transcript. Includes all information that is flagged throughout the system as Official, Unofficial, Student Life, and Degree Progress. Can include an Advising Report if you select the Advising Report or Special Advising Report check box.
Unofficial	40	Print the information on the unofficial transcript and the student life transcript. Includes all information that is flagged throughout the system as Unofficial, Student Life, and Degree Progress. Can include an Advising Report if you select the Advising Report or Special Advising Report check box.

<i>Transcript Level</i>	<i>Value</i>	<i>Description</i>
Stdnt Life (student life)	60	Print the information on the student life transcript. Includes all information that is flagged throughout the system as Student Life and Degree Progress. Can include an Advising Report if you select the Advising Report or Special Advising Report check box.
Degr Prog (degree progress)	80	Print the information on the degree progress transcript, which can include academic advisement information in addition to a transcript. Does not include a transcript. Includes an Advising Report only if you select the Advising Report or Special Advising Report check box. The advising report is ordered and evaluated for each student by career.

When you generate transcripts, the system includes the applicable information for all transcripts types with a value on the translate table greater than or equal to the transcript level you select. For example, if you select Official, the system includes the applicable information on all transcript types. However, if you select Stdnt Life, the system only includes the applicable information on student life transcripts and degree progress transcripts.

Transcript level values are delivered with your system as translate values. Do not modify these values in any way. Any modifications to these values require a substantial programming effort.

Defining Transcript Type Security

You can assign different levels of transcript type security to each user in your organization. Transcript type security authorizes users who have access to the transcript request pages to create transcript requests only for those transcript types for which they have security.

Related Links

“Setting Security for Transcript Types” (Campus Solutions Application Fundamentals)

Creating Transcript Notes

To set up transcript notes, use the Transcript Notes Table component (TSCRPT_NOTES_TBL).

Use the Transcript Notes Table page to define transcript notes that can appear alongside a particular student enrollment record. Transcript notes only print on a student's transcript when you both attach the predefined note to an individual student's enrollment record and process a transcript type for which the

Print Transcript Note check box is selected. Typically, transcript notes are generic enough that they can be reused for multiple students' enrollment records. You can attach notes to a student's enrollment record using either the **Transcript Note** link on the Enrollment Request page or the **Transcript Note** fields on the Student Enrollment 3 page.

Related Links

[Understanding Class Enrollment Processing](#)

Page Used to Create Transcript Notes

<i>Page Name</i>	<i>Definition Name</i>	<i>Navigation</i>	<i>Usage</i>
Transcript Notes Table	TSCRPT_NOTES_TBL	Set Up SACR > Product Related > Student Records > Transcript > Transcript Notes Table > Transcript Notes Table	Define transcript notes.

Defining Transcript Notes

Access the Transcript Notes Table page (**Set Up SACR > Product Related > Student Records > Transcript > Transcript Notes Table > Transcript Notes Table**).

<i>Field or Control</i>	<i>Description</i>
Effective Date	Enter an effective date for this transcript note. The effective date defines when the status you select is valid.
Status	Select a status for this transcript note. Select <i>Active</i> when adding a new transcript note. The <i>Inactive</i> option should only be used if your institution will no longer use this transcript note.
Description	The description is used for system related display purposes only. The description does not appear in the transcript.
Short Description	The short description is used for system-related display purposes only. The short description does not appear in the transcript.
Transcript Note Sequence Nbr (transcript note sequence number)	The transcript note sequence number enables you to create multiple note lines under one note ID. When you select a transcript note to appear on a transcript, all notes under the note ID appear.

<i>Field or Control</i>	<i>Description</i>
Transcript Note	Enter the transcript note in the free-form text field. This text appears on the student's transcript when you both attach the note to a student's enrollment record and process a transcript type for which the Print Transcript Note check box is selected.

Creating Transcript Text

Important! The COBOL transcript process is a deprecated product. It is strongly recommended that you use the Application Engine transcript process instead. For more information on the Application Engine transcript process, see [Understanding Transcript-Related Processes](#).

Use the Transcript Text page to define transcript text for a specific student. Unlike transcript notes, which are predefined and attached to students on the enrollment request pages, transcript text is created for a specific student and is not necessarily associated with a specific enrollment record. After you create transcript text for a student, it always appears on transcripts with the transcript type you specify, or on a transcript that is at or above the transcript level you specify. No options at the transcript type setup level enable you to inactivate or hide transcript text. You can limit when and how the transcript text appears by using the filtering options on the Transcript Text page to specify valid transcript types, levels, and relative positions for the transcript text.

Page Used to Create Transcript Text

<i>Page Name</i>	<i>Definition Name</i>	<i>Navigation</i>	<i>Usage</i>
Transcript Text	TRANSCRIPT_TEXT	Records and Enrollment > Transcripts > Transcript Text > Transcript Text	Define transcript text for a specific student.

Defining Transcript Text

Access the Transcript Text page (**Records and Enrollment > Transcripts > Transcript Text > Transcript Text**).

This example illustrates the fields and controls on the Transcript Text page. You can find definitions for the fields and controls later on this page.

Field or Control	Description
Print Loc Seq (print location sequence)	Enter the print location sequence to identify the order in which notes appear within a print location. The default is 1, and each additional row increases by one.
Relative Position	<p>Select the relative position of the note within the chosen print location. You are prompted from the translate table. Values for this field are delivered with your system as translate values. Do not modify these values in any way. Any modifications to these values require a substantial programming effort.</p> <p>Values include:</p> <p><i>After</i>: Select this value if you want the transcript text to appear immediately after the specified print location sequence.</p> <p><i>Before</i>: Select this value if you want the transcript text to appear immediately before the specified print location sequence.</p>

Field or Control	Description
Print Location	<p>Enter the print location of the text. Print location values are delivered with your system and you can view them on the Print Area Table page. Modifying these values requires programming effort. The system uses this value in conjunction with the relative position value to determine where to print the transcript text. If the Transcript Type or Transcript Level that you specify is associated with a transcript type that has the Print Location set to <i>Do Not Display</i>, then the transcript text does not appear on the transcript. The transcript type setup is the overriding rule. Print Location values are: <i>Academic Program, Academic Standing, Cumulative Stats, Degrees - External, Degrees - Local, Enrollment, Milestones, Student Personal Data, Term Honors, Term Statistics, Transcript Print Date, Transcript Recipient, Transcript Request Reason, Transcript Requester, Transfer Credit - Courses, Transfer Credit - Others, Transfer Credit - Tests, and Withdrawal Info.</i></p> <hr/> <p>Note: Transcript text associated with a print location of <i>Academic Program</i> appears on the transcript only if the associated transcript type is configured such that the academic program prints in the Transcript Header. To review a particular transcript type's setup data, access the Transcript Type - Program page.</p> <hr/> <p>Note: Transcript text associated with a print location of <i>Institution Data</i> appears differently on transcripts printed through Crystal than it does on transcripts you view online. Transcripts printed through Crystal always display institution data in a reserved area in the header of the transcript (upper left corner). This reserved area has a limited number of lines of text. For this reason, we have inactivated the <i>Institution Data</i> value. Any transcript text created with a print location of <i>Institution Data</i> prior to PeopleSoft Student Administration 8 remains in the database, and print as always. However, no new entries with a print location of <i>Institution Data</i> can be made. To review the setup data for a particular transcript type, access the Transcript Type - General page.</p> <hr/> <p>Note: Transcript text associated with a print location of <i>Student Personal Data</i> does not appear as expected for transcript types for which student personal data is set to print in the page header. This is because the page header has a limited number of text lines available for printing. Therefore, transcript text associated with student personal data and a transcript type with student personal data printing in the page header, will instead print the transcript text in the first lines of text in the body of the transcript. To review the setup data for a particular transcript type, access the Transcript Type - General page.</p>

Field or Control	Description
	<p>Note: Transcript text for all types of <i>Transfer Credit</i> must be associated with a transfer model. Because the model can be applied to multiple articulation terms, the effect on printing associated with transcript text is significant. Therefore, transcript text associated with a transfer credit model can be printed successfully only when the transfer credit is configured to print in the transcript header or transcript trailer. Transfer credit that is configured to print in the enrollment detail or enrollment trailer does not display any associated transcript text. To review the setup data for a particular transcript type, access the Transcript Type - Transfer/Test/Other Credits page.</p>
Institution	Enter the institution for which you want to create the transcript text. The institution value determines which transcript types are available in the Transcript Type field.
Model Nbr (model number)	Based on the print location you select, the system prompts you for additional information. For instance, if you select a print location of <i>Transfer Credit - Courses</i> , the Model Number field appears. If you select a print location of <i>Milestones</i> , the Milestone Number field appears, and so on.
Text Seq Nbr (text sequence number)	The system populates the text sequence number to 1 by default. You can insert text rows and increase the text sequence number. The sequence number determines the order of printing on the student's transcript before or after a print location.
Transcript Level	<p>Select either a transcript level or a transcript type, but not both. Select a transcript level to determine the types of transcripts on which the system includes this transcript text.</p> <p>Depending on the transcript level you select, the system prints the transcript text on transcript types set to the same level, and all other greater numbered transcript types on the translate table. For example, if you select <i>Official</i> for your transcript level (which has a level value of 20 in the translate table), the system prints the transcript text on all transcript types that have transcript levels of 20 to 80. However, if you select <i>Stdnt Life</i> for your transcript level (which has a level value of 60 in the translate table), the system prints the transcript text only on those transcript types where the transcript level is set to <i>Stdnt Life</i> or <i>Degr Prog</i> (degree progress), levels 60 - 80. The only exception to this rule is <i>Not Print</i>.</p> <p>If you select <i>Not Print</i>, the transcript text never prints.</p>

Transcript Type and Transcript Text

Use the Transcript Report group box for XML transcripts or the Transcript Report COBOL group box for COBOL transcripts.

Field or Control	Description
Transcript Type	Select either a transcript level or a transcript type, not both. Enter a transcript type if you want the text to appear only on the type you specify.
Transcript Text	Enter your free-form text in the Transcript Text field. This text appears on the student's transcript. For XML transcripts, this field is 1000 characters.

Note: If you use the Historical Course Enrollment page for conversion purposes, and want to display term statistics for those enrollments, use transcript text for those statistics. Otherwise, display summary statistics that you converted using the transfer credit process.

“Understanding Data Conversion” (Campus Solutions Application Fundamentals)

“Performing Data Conversion” (Campus Solutions Application Fundamentals)

Reviewing Transcript Print Areas

To set up transcript print areas, use the Transcript Print Area Table component (TSCRPT_PRT_AREA).

Transcript print areas are associated with codes that define areas of the transcript on which various types of transcript data appear. Print area values are delivered with your system as translate values. Do not modify these values in any way. Any modifications to these values require a substantial programming effort.

Page Used to Review Transcript Print Areas

Page Name	Definition Name	Navigation	Usage
Transcript Print Area Table	PRINT_AREA_TABLE	Set Up SACR > Product Related > Student Records > Transcript > Transcript Print Area Table > Transcript Print Area Table	Review delivered transcript print areas.

Reviewing the Transcript Print Area Table

Access the Transcript Print Area Table page (**Set Up SACR > Product Related > Student Records > Transcript > Transcript Print Area Table > Transcript Print Area Table**).

This example illustrates the fields and controls on the Transcript Print Area Table page. You can find definitions for the fields and controls later on this page.

Transcript Print Area Table						
*Print Area Code	Sort Print Area	Secondary Print Area	*Description	Short Desc		
ED	5	3	Enrollment Detail	Enrol Dtl	+	-
EH	5	1	Enrollment Header	Enrol Hdr	+	-
ET	5	5	Enrollment Trailer	Enrol Trl	+	-
ND	ND		Do Not Display	No Display	+	-
PH	1		Page Header	Page Hdr	+	-
TH	3		Transcript Header	Tscrpt Hdr	+	-
TT	9		Transcript Trailer	Tscrpt Trl	+	-

<i>Field or Control</i>	<i>Description</i>
Print Area Code	An acronym that defines the transcript print area.
Sort Print Area, Secondary Print Area	The values in these fields determine how the system sorts the print areas on the transcript.
Description	Text used on the Define Transcript Type component to determine print detail.
Short Desc (short description)	Value used internally by system processes. Not visible on any pages.

Note: The values on the Transcript Print Area Table page are delivered with your system as translate values. Do not modify these values in any way. Any modifications to these values require a substantial programming effort.

Defining Transcript Types

Important! The COBOL transcript process is a deprecated product. It is strongly recommended that you use the Application Engine transcript process instead. For more information on the Application Engine transcript process, see [Understanding Transcript-Related Processes](#).

To set up transcript types, use the Define Transcript Type component (SSR_TSCRPT_TYPE).

This component enables you to define various types of transcripts for your institution, each type with its own unique purpose, design, and formality level.

Note: The pages of the Transcript Type component (TSCRPT_TYPE) still exist in the system: TSCRPT_TYPE, TSCRPT_CARS, TSCRPT_TYPE_GEN, TSCRPT_TYPE_LOCDGR, TSCRPT_TYPE_ENRL, TSCRPT_TYPE_TRNSFR, and TSCRPT_TYPE_SORT. Use this component to set up COBOL-based transcripts.

Prerequisites

Before you can create transcript types, you must create academic careers. In addition, if you want to create an academic advisement report that references a special requirement usage (one other than standard), you must create requirement usage values.

Pages Used to Define Transcript Types

Page Name	Definition Name	Navigation	Usage
Basic Data	SSR_TSCRPT_TYPE	Set Up SACR > Product Related > Student Records > Transcript > Define Transcript Type > Basic Data	Define transcript types, associate service indicators, specify transcript levels, define self-service availability. Typical transcript types include official, unofficial, graduate, undergraduate, NCAA, and continuing education.
Careers	SSR_TSCRPT_CARS	Set Up SACR > Product Related > Student Records > Transcript > Define Transcript Type > Careers	For transcript types with a Detail Organization value of <i>by Career</i> , define all possible careers that this transcript type can report. When you run the transcript request process for this transcript type, the system generates transcripts. Transcripts are processed for each career specified, that matches a career of the student.
General	SSR_TSTYPE_GEN	Set Up SACR > Product Related > Student Records > Transcript > Define Transcript Type > General	Define the print areas and details about appearance for types of information such as institution, student, print date, and reason.
Degrees/Program	SSR_TSTYPE_LOCDGR	Set Up SACR > Product Related > Student Records > Transcript > Define Transcript Type > Degrees/Program	Define the print areas and details about appearance for academic program related elements.

Page Name	Definition Name	Navigation	Usage
Enrollment/Statistics	SSR_TSTYPE_ENRL	Set Up SACR > Product Related > Student Records > Transcript > Define Transcript Type > Enrollment/Statistics	Define the print areas and details about appearance for enrollment information.
Transfer/Test/Other Credits	SSR_TSTYPE_TRNSFR	Set Up SACR > Product Related > Student Records > Transcript > Define Transcript Type > Transfer/Test/Other Credits	Define the print areas and details about appearance for transfer, test, and other credits.
Test Scores	SSR_TSTYPE_TEST	Set Up SACR > Product Related > Student Records > Transcript > Define Transcript Type > Test Scores	Define the print areas and details about appearance for test scores.
Special GPA	SSR_TSTYPE_SGPA	Set Up SACR > Product Related > Student Records > Transcript > Define Transcript Type > Special GPA	Define the print areas and details about appearance of Special GPAs.
View Sort	SSR_TSTYPE_SORT	Set Up SACR > Product Related > Student Records > Transcript > Define Transcript Type > View Sort	Display the sorting order for how the transcript type information appears.
Fee Setup	SSR_TSTYPE_FEES	Set Up SACR > Product Related > Student Records > Transcript > Define Transcript Type > Fee Setup	Set up transcript fees for official transcript requests through Fluid user interface.

Defining Transcript Type Basic Data

Access the Basic Data page (**Set Up SACR > Product Related > Student Records > Transcript > Define Transcript Type > Basic Data**).

This example illustrates the fields and controls on the Basic Data page. You can find definitions for the fields and controls later on this page.

Enter an Academic Institution and an alphanumeric Transcript Type code (one to five characters in length).

You should not define a Transcript Type of *ALL* because this value is used on the Transcript Type Security page to grant users access to all transcript types.

See “Setting Security for Transcript Types” (Campus Solutions Application Fundamentals).

Field or Control	Description
Effective Date	Enter the effective date that determines when this transcript type is available on the batch and online transcript request pages.
Description	Enter a description. This information does not appear on the transcript. It is for related display purposes.

Field or Control	Description
Formal Description	Enter a formal description. This information appears at the beginning of the transcript.
Transcript Level	<p>Enter the transcript level that you want to associate with this transcript type. Transcript level is hierarchical and based on the two-position numeric code in the value column of the translate table. Values for this field are delivered with your system as translate values. Do not modify these values in any way. Any modification to these values requires substantial programming effort.</p> <p>See Understanding Transcript Levels.</p>
Detail Organization	<p>Select how the system sorts information on the transcript. Values are:</p> <p><i>by Career</i>: Select this value to sort information by the student's academic career, and then by term. For instance, if the student has an undergraduate and graduate record, the system first displays all of the academic career information that matches one academic career, and then all of the academic career information that matches the other career. Within each academic career grouping, information is ordered by term. The system determines the order in which academic career records appear on the transcript by referencing the sequence number of each academic career on the Careers page. Those academic careers with the lowest sequence numbers print first, and so on. The system only seeks and evaluates the academic careers on the Careers page that match the student. Be sure to enter all possible academic careers that you want to capture and report with this transcript type.</p> <p><i>Chrono</i>: Select this value to sort information chronologically. For example, all academic careers in which the student has been active (that are also listed on the Careers page) print in chronological order, by term.</p> <hr/> <p>Note: If you set up for COBOL based transcripts, using the Transcript Type component (TSCRPT_TYPE), the <i>Chrono</i> setting is <i>not</i> intended for use with the advising check boxes. Advising reports <i>always</i> print by academic career.</p> <hr/>
Transcript Fee Required	<p>If you select:</p> <ul style="list-style-type: none"> • <i>Yes</i>, you require a transcript fee to be assessed when students request an official transcript through Fluid user interface. <p>You must set how the transcript fee is assessed on the Fee Setup page. See Setting up Transcript Fees.</p> <ul style="list-style-type: none"> • <i>No</i>, you do not require a transcript fee to be assessed. By default, this field is set to this value. If you do not select a value, the system also treats it as <i>No</i>.

Field or Control	Description
Term Activated Careers Only	<p>Select this check box to exclude career data from printing on the transcript for which a student has no academic history, such as those careers added to students for prospect records.</p> <p>The following warning applies if you set up for COBOL based transcripts, using the Transcript Type component (TSCRPT_TYPE):</p> <hr/> <p>Warning! If your institution produces Academic Advisement reports for students who are not term-activated (for example, for prospective transfer students), this check box should be cleared for the transcript types associated with these report types.</p> <hr/>
Allow XML Output File	<p>Use this check box to create your own XML file for testing.</p> <p>If you select the Allow XML Output File check box, the Output XML File and Output File Path fields appear on the Process Transcripts page when you select a value of <i>Generate and Print Transcript</i>, <i>Print Transcript</i>, or <i>Request, Generate and Print</i> in the Process Action field on that page.</p>
Report Definition ID and Template ID	<p>Select the template to be used with this transcript type. First, select the Report Definition ID then one of the Template IDs associated with that Report Definition. If these fields are left blank, the default template from the Report Definition of SSR_TSRPT is used. The transcript type defined report definition and template can be overridden on the Process Transcripts component. If not overridden, the process uses the report definition and template ID as defined on the transcript type.</p>
FERPA Information	<p>The message that you define in this field prints in the header of the transcript when the FERPA check box is selected for a student on the FERPA page (Campus Community > Personal Information (Student) > Biographical (Student) > Student FERPA > FERPA).</p> <p>If the field is left blank, nothing prints on the transcript for FERPA.</p>
Check Service Indicators	<p>Select this check box to have the transcript process identify indicators (holds or positive services) that you specify in the Service Impacts fields.</p>
Service Impacts	<p>Select the service impacts that the system evaluates in the transcript process. If the system finds on a student's record a service indicator with any one of the up to three service impacts you list, the system does not generate a transcript for the student. Instead, the system generates an error message in the transcript output. Service impact values are defined on the Service Impact Table page.</p>

Field or Control	Description
Allow Student Self-Service	<p>If you select this check box and the transcript level is <i>Official</i>, the system generates a request for this transcript type on the Request Official Transcript self-service page. Select this check box for only one transcript type per institution.</p> <p>If you select this check box and the transcript level is <i>Unofficial</i>, the system displays this transcript type on the Unofficial Transcript self-service page. You can select this check box for multiple transcript types.</p> <p>If you select this check box and the transcript level is <i>Degree Progress</i>, the system displays this transcript type on the View Degree Progress Report self-service page, and the Evaluate Transfer Credit - Process a Degree Progress Report page. You can select this check box for multiple transcript types.</p>
Allow Advisor Self-Service	<p>If you select this check box and the transcript level is <i>Unofficial</i>, the system displays this transcript type on the View Advisee Information self-service page (unofficial transcript). You can select this check box for multiple transcript types.</p> <p>If you select this check box and the transcript level is <i>Degree Progress</i>, the system displays this transcript type on the View Advisee Information self-service page (degree progress report). You can select this check box for multiple transcript types.</p> <p>This check box does not have any use with a transcript level of <i>Not Print</i> and <i>Stdnt Life</i> (student life).</p>
Information for Students	<p>This free-form text appears to students for the respective transcript type on the View Degree Progress Report self-service page.</p>

Linking Academic Careers to Transcript Types

Access the Careers page (**Set Up SACR > Product Related > Student Records > Transcript > Define Transcript Type > Careers**).

This example illustrates the fields and controls on the Careers page. You can find definitions for the fields and controls later on this page.

Note: If the **Detail Organization** field on the Basic Data page is set to *Chrono*, no fields appear on the Careers page. All student information, regardless of career, prints chronologically by term.

Field or Control	Description
<p>Seq Nbr (sequence number)</p>	<p>The system populates this field for the first row with a value of 1 and increments each additional row by one. Sequence number indicates a unique row of information and the order in which academic career information appears on the transcript. For example, if a student is active in two academic careers (Undergraduate and Graduate), the transcript type setup such as that shown in the exhibit would produce a transcript where the student's Undergraduate (Seq Nbr 1) transcript or degree audit appears first, then a section break, then the student's Graduate (Seq Nbr 2) transcript or degree audit appears. The order in which a student becomes active in a career has no effect on transcript print order. Career print order is always specified by the transcript type sequence.</p>
<p>Academic Career</p>	<p>Enter all possible careers that this transcript type can report. Use multiple rows as necessary. When you run the transcript request process for this transcript type, the system generates individual enrollment detail or degree audits for each career in which the evaluated student is active. For example, if you have ten careers specified for a single transcript type, and you run the transcript type for a student who has one career that matches one of the careers specified, and another career which does not match, only enrollment detail associated with the matching career appears. The other non-matching career's enrollment detail or degree audit information does not appear. Academic career values are set up as translate values and are defined on the Academic Career Table page.</p>

Field or Control	Description
Formal Description	The system populates the formal description by default. You can change this value. This description appears on the transcript.

If you set up for COBOL based transcripts, using the Transcript Type component (TSCRIPT_TYPE): Advising reports are processed for each career in which the student has a current program action of *activate, data change, plan change, program change, or readmit*. A transcript type can have multiple academic careers linked to it.

Designating Student and Institutional Information

Access the General page (**Set Up SACR > Product Related > Student Records > Transcript > Define Transcript Type > General**).

This example illustrates the fields and controls on the General page. You can find definitions for the fields and controls later on this page.

The screenshot displays the 'General' configuration page for a transcript type. At the top, there are tabs for 'General', 'Degrees/Program', 'Enrollment/Statistics', 'Transfer/Test/Other Credits', 'Test Scores', and 'Special GPA'. The 'General' tab is active. Below the tabs, there are search and navigation options: 'Find | View All', 'First', '1 of 2', and 'Last'. The main content area is divided into several sections:

- Academic Institution:** PSUNV PeopleSoft University
- Transcript Type:** ALLOF Official Transcripts - All
- Effective Date:** 07/19/1997
- Institution Data:**
 - 'Print Area': Page Header
 - Print Seq: 10
 - Print Institution Address
 - Print Institution ID
 - Institution ID: 123456
- Student Personal Data:**
 - Name Usage: NAME USG 5 Oth, Ftr, Deg, Pri, Mdn, Mtr
 - 'Print Area': Page Header
 - Print Seq: 30
 - Print Student SSN
 - Print Student Sex
 - Print Student Birthday
 - Print Campus ID
 - Print Student Address
 - Address Usage: SLCT ORD 1 Home, Mailing, Permanent, Work
 - Print Student Phone
- Print Date:**
 - 'Print Area': Page Header
 - Print Seq: 20
- Requester:**
 - 'Print Area': Do Not Display
- Reason:**
 - 'Print Area': Do Not Display
- Recipient:**
 - 'Print Area': Do Not Display
- Basis of Admission:**
 - 'Print Area': Do Not Display

Note: Print area values are delivered with your system on the Print Area Table page. Any modification to these values requires programming effort.

Field or Control	Description
Institution Data Print Area	Select the print area in order to indicate where the system displays academic institution data. Values are <i>Do Not Display</i> , <i>Transcript Header</i> , and <i>Page Header</i> .
Institution Data Print Seq (institution data print sequence)	The system populates the print sequence by default. The print sequence determines the order in which institution data information appears within the print area. You can change the value. In the example, both student and institution data prints in the page header area. However, the institution data prints first and the student data second because of the print sequence numbers.
Print Institution Address	Displays the institution address in the area specified.
Print Institution ID	Displays the institution ID in the area specified.

Field or Control	Description
Student Personal Data Name Usage	Specify the logic that the system uses to select the name printed on the transcript.
Student Personal Data Print Area	Select the print area in order to indicate where the system displays student personal data. Values are <i>Do Not Display</i> , <i>Transcript Header</i> , and <i>Page Header</i> .
Student Personal Data Print Seq (student personal data print sequence)	The print sequence determines the order in which student personal data appears within the print area. The system populates the print sequence by default. You can change the value.
Print Student SSN (print student social security number)	Displays the student's social security number in the area specified.
Print Student Birthday	Displays the student's date of birth in the area specified.
Print Student Address	Displays the student's address that corresponds with the setting in the Home Address Type field on the Names/Addresses Page.
Address Usage	Specify the logic that the system uses to select the address printed on the transcript.

Field or Control	Description
Print Student Sex	Displays the student's gender in the area specified.
Print Campus ID	Displays the student's campus ID in the area specified.

Field or Control	Description
Print Date Print Area	The date on which the transcript is generated (and not necessarily printed). Select the print area in order to indicate where the system displays print date information. Values are <i>Do Not Display</i> , <i>Transcript Header</i> , and <i>Page Header</i> .
Print Date Print Seq (print date print sequence)	The print sequence determines the order in which print date information appears within the print area. The system populates the print sequence by default. You can change the value.
Requester Print Area	The last name, first name of the user who created the transcript request. Select the print area to indicate where the system displays requester information. Values are <i>Do Not Display</i> , <i>Transcript Header</i> , and <i>Page Header</i> .
Requester Print Seq (requester print sequence)	The print sequence determines the order in which requester information appears within the print area. The system populates the print sequence by default. You can change the value.
Reason Print Area	The reason for the transcript request as specified in the Request Reason field on the Request Header page. Select the print area to indicate where the system displays request reason information. Values are <i>Do Not Display</i> , <i>Transcript Header</i> , and <i>Page Header</i> .
Reason Print Seq (reason print sequence)	The print sequence determines the order in which request reason information appears within the print area. The system populates the print sequence by default. You can change the value.
Recipient Print Area	Recipient is the name of the institution, department, or individual that receives the transcript. You must enter send to information during the transcript request process in order to specify this. Select the print area to indicate where the system displays recipient name information. Values are <i>Do Not Display</i> , <i>Transcript Header</i> , and <i>Page Header</i> .
Recipient Print Seq (recipient print sequence)	The print sequence determines the order in which recipient information appears within the print area. The system populates the print sequence by default. You can change the value.

Field or Control	Description
Basis of Admission Print Area	Select the print area to indicate where the system displays basis of admission information. Values are <i>Do Not Display</i> , <i>Transcript Header</i> , and <i>Page Header</i> . If you select <i>Transcript Header</i> or <i>Page Header</i> , the system displays basis of admission information for students who have the Include in Transcript check box selected on the Basis of Admission page.
Basis of Admission Print Seq (basis of admission print sequence)	The print sequence determines the order in which basis of admission information appears within the print area. The system populates the print sequence by default. You can change the value.

Designating Degree and Program Data

Access the Degrees/Program page (Set Up SACR > Product Related > Student Records > Transcript > Define Transcript Type > Degrees/Program).

This example illustrates the fields and controls on the Degrees/Program page (1 of 2). You can find definitions for the fields and controls later on this page.

The screenshot displays the 'Degrees/Program' configuration page. At the top, there are tabs for 'Basic Data', 'Careers', 'General', 'Degrees/Program' (selected), 'Enrollment/Statistics', and 'Transfer/Test/Other Credits'. Below the tabs, the page shows the following information:

- Academic Institution:** PSUNV PeopleSoft University
- Transcript Type:** ALLOF Official Transcripts - All
- Effective Date:** 07/19/1997

The main configuration area is divided into three sections:

- Academic Program:**
 - *Print Area: Transcript Header
 - Print Seq: 90
 - Print Plans with Program
 - Print Subplans
 - What to Print:**
 - Active Program for Term
 - All Plan Changes
 - Changes in Program Status
 - Program Status to Include:**
 - Active
 - Completed
 - LOA
 - Discontnd
 - Suspended
 - Dismissed
 - Admitted
 - Applicant
 - Cancelled
 - Waitlisted
 - Prematric
 - Deceased
- Local Degrees:**
 - *Print Area: Enrollment Header
 - Print Seq: 10
 - Print Degree GPA
 - Print Degree Rank
 - Print Degree Honors
 - Print Degree Plan GPA
 - Print Degree Plan Rank
 - Print Degree Sub-Plan
- Other Institutions Attended:**
 - *Print Area: Transcript Header
 - Print Seq: 30

This example illustrates the fields and controls on the Degrees/Program page (2 of 2). You can find definitions for the fields and controls later on this page.

External Degrees	
*Print Area:	Transcript Header <input type="text"/> <input type="button" value="v"/> Print Seq: <input type="text" value="70"/>
<input checked="" type="checkbox"/> Print Honors	
Milestones	
*Print Area:	Transcript Trailer <input type="text"/> <input type="button" value="v"/> Print Seq: <input type="text" value="10"/>
<input type="checkbox"/> Sort Milestones by Program	
Scholarships and Grants	
*Print Area:	Do Not Display <input type="text"/> <input type="button" value="v"/>
Academic Project	
*Print Area:	Do Not Display <input type="text"/> <input type="button" value="v"/>
Thesis	
*Print Area:	Do Not Display <input type="text"/> <input type="button" value="v"/>

Field or Control	Description
Academic Program Print Area	Select the print area to indicate where the system displays academic program information. Values are <i>Enrollment Header</i> , <i>Enrollment Trailer</i> , <i>Transcript Header</i> , and <i>Do Not Display</i> . Print area values are delivered with your system on the Print Area Table page. Any modification to these values requires programming effort. Depending on which print area you select, the system selects an option in the What to Print group box.
Academic Program Print Seq	The print sequence determines the order in which academic program information appears within the print area. The system populates the print sequence by default. You can change the value.
Print Plans with Program	Select this check box to display all the academic plans associated with each of the student's reported programs.
Print Subplans	Select this check box to display all the subplans associated with each of the student's reported programs.

Field or Control	Description
What to Print	<p>The system selects a What to Print option and a Program Status to Include check box based on your choice of academic program print area. You cannot override these defaults.</p> <p>If you select <i>Enrollment Header</i>, the system selects the Active Program for Term option and the value of <i>Active</i> for the Program Status to Include field.</p> <p>If you select <i>Enrollment Trailer</i>, the system selects the Changes in Program Status option and the appropriate academic program status values become available for selection in the Program Status to Include group box. Select the appropriate academic program status values.</p> <p>If you select <i>Transcript Header</i>, the What to Print group box becomes available for entry, and you can select which information to print. In addition, the Program Status to Include group box becomes available for entry. Select the appropriate academic program status values.</p>
Program Status to Include	<p>Select the appropriate check boxes to indicate the program statuses that the system includes. Values are <i>Active</i>, <i>Discontnd</i> (discontinued), <i>Admitted</i>, <i>Waitlisted</i>, <i>Completed</i>, <i>Suspended</i>, <i>Applicant</i>, <i>Prematric</i>, <i>LOA</i> (leave of absence), <i>Dismissed</i>, <i>Cancelled</i>, and <i>Deceased</i>.</p>
Local Degree Print Area	<p>Local degrees are degrees that a student obtains at your institution. Select the print area to indicate where the system displays local degree information. Values are <i>Enrollment Header</i>, <i>Enrollment Trailer</i>, <i>Transcript Header</i>, <i>Transcript Trailer</i>, and <i>Do Not Display</i>. Print area values are delivered with your system on the Print Area Table page. Any modification to these values requires programming effort.</p> <hr/> <p>Note: If you configure Local Degrees to print on the transcript, the system displays all degrees for the student across all of the student's careers, regardless of whether or not the degrees were earned in association with the specific career for which the transcript is reporting.</p> <hr/>
Local Degree Print Seq	<p>The print sequence determines the order in which local degree information appears within the print area. The system populates the print sequence by default. You can change the value.</p>
Other Institution Attended Print Area	<p>The system extracts information for other institutions attended from the student's education component. Select the print area to indicate where the system displays other institutions attended. Values are <i>Transcript Header</i>, <i>Transcript Trailer</i> and <i>Do Not Display</i>. Print area values are delivered with your system on the Print Area Table page. Any modification to these values requires programming effort.</p>

Field or Control	Description
Other Institution Attended Print Seq	The print sequence determines the order in which other institution attended information appears within the print area. The system populates the print sequence by default. You can change the value.
External Degree Print Area	The system extracts external degree information from the student's education component. Select the print area to indicate where the system displays external degree information. Values are <i>Transcript Header</i> , <i>Transcript Trailer</i> , and <i>Do Not Display</i> . Print area values are delivered with your system on the Print Area Table page. Any modification to these values requires programming effort.
External Degree Print Seq	The print sequence determines the order in which external degree information appears within the print area. The system populates the print sequence by default. You can change the value.
Print Honors	Select this check box to display honors that the student received from other institutions.
Milestones Print Area	Select the print area in order to indicate where the system displays milestone information. Values are <i>Do Not Display</i> and <i>Transcript Trailer</i> . Print area values are delivered with your system on the print area Table page. Any modification to these values requires programming effort.
Milestones Print Seq	The print sequence determines the order in which milestone information appears within the print area. The system populates the print sequence by default. You can change the value. See Setting Up Milestones .
Print Honors	Select this check box to display any student honors on the transcript.
Sort Milestones by Program	Select this check box to sort and display milestones by academic program on the transcript.
Scholarships and Grants Print Area	Select the print area to indicate where the system displays scholarship and grant information. Values for this field are delivered with your system as translate values. Do not modify these values in any way. Any modifications to these values require a substantial programming effort. Values are <i>Transcript Header</i> , <i>Transcript Trailer</i> , and <i>Do Not Display</i> . The system extracts other institution-attended information from the student's admissions record.

Field or Control	Description
Academic Project Print Area	Select the print area to indicate where the system displays Academic Project information. Values for this field are delivered with your system as translate values. Do not modify these values in any way. Any modifications to these values require a substantial programming effort. Values are <i>Transcript Header</i> , <i>Transcript Trailer</i> , and <i>Do Not Display</i> .
Thesis Print Area	Select the print area to indicate where the system displays thesis information. Values for this field are delivered with your system as translate values. Do not modify these values in any way. Any modifications to these values require a substantial programming effort. Values are <i>Transcript Header</i> , <i>Transcript Trailer</i> , and <i>Do Not Display</i> .

Designating Enrollment and Statistics Data

Access the Enrollment/Statistics page (**Set Up SACR > Product Related > Student Records > Transcript > Define Transcript Type > Enrollment/Statistics**).

This example illustrates the fields and controls on the Enrollment/Statistics page. You can find definitions for the fields and controls later on this page.

The screenshot displays the 'Enrollment/Statistics' configuration page. At the top, navigation tabs include 'Basic Data', 'Careers', 'General', 'Degrees/Program', 'Enrollment/Statistics', and 'Transfer/Test/Other Credits'. The page header shows 'Find | View All' and 'First 1 of 1 Last'. The main content area is divided into several sections:

- Academic Institution:** PSUNV PeopleSoft University
- Transcript Type:** ALLOF Official Transcripts - All
- Effective Date:** 07/19/1997
- Enrollment:**
 - *Print Area: Enrollment Detail
 - Print Seq: 30
 - Term Title to Use: Short Desc
 - Course List Sort Order: Session / Subj
 - Session Title to Use: Short Desc
 - Include Historical Enrollment
 - Print Course Topic
 - Print Course Attributes
 - Print Contact Hours
 - Print Instructor Name
 - Print Transcript Notes
 - Print Class Dates
 - Print OEE Class Dates
 - Obey Enrlmnt on Transcript Dt
 - Obey Fully Graded Date
- Withdrawal Information:**
 - *Print Area: Enrollment Detail
 - Print Seq: 20
- Term Statistics:**
 - *Print Area: Enrollment Trailer
 - Print Seq: 40
 - Print Transfer Credit Stats
 - Obey Show Stats on Tscript Dt
- Cumulative Statistics:**
 - Print Cums at Change of Pgm
 - Print Cums at End of Tscript
- Term Honors:**
 - *Print Area: Enrollment Trailer
 - Print Seq: 50
- Academic Standing:**
 - *Print Area: Enrollment Trailer
 - Print Seq: 60

Field or Control	Description
Enrollment Print Area	Select the print area in order to indicate where the system displays enrollment information. Values for this field are delivered with your system as translate values. Do not modify these values in any way. Any modification to these values requires substantial programming effort. Values are <i>Enrollment Detail</i> and <i>Do Not Display</i> .
Enrollment Print Seq (enrollment print sequence)	The print sequence determines the sequence in which enrollment information appears within the print area. The system populates the print sequence by default. You can change this value.
Term Title to Use	Select the type of term title that you want to appear on the transcript. Values for this field are delivered with your system as translate values. Do not modify these values in any way. Any modifications to these values requires a substantial programming effort. Values are <i>Long Description</i> and <i>Short Description</i> .
Course List Sort Order	Select the course list sort order in which the system displays courses within a term. You can select to sort by <i>Session Number and Subject Area</i> or <i>Subject Area and Course Catalog Number</i> .
Session Title to Use	If you select a course list sort order of <i>Session Number and Subject Area</i> , the Session Title to Use field becomes available for entry. Select the <i>Long Description</i> or <i>Short Description</i> of the session title that you want to appear on the transcript.
Include Historical Enrollment	Select this check box for the system to display historical enrollment information that was entered into the Historical Course Enrollment page and its corresponding table. This information is separate from the usual student enrollment data. See Creating Historical Enrollment Records .

Note: If you select the **Include Historical Enrollment** check box, be sure that you set the **Last Term for Historical Enrollment** field to the latest term possible for historical enrollment records on the Academic Career Table page.

Also note that term *0000* does not allow historical enrollment data to print on a transcript. If you want historical enrollment data to print on a student's transcript, you must select a term value other than *0000*.

See “Describing Academic Career Parameters” (Campus Solutions Application Fundamentals).

Field or Control	Description
Print Course Topic	Displays course topics associated with specific courses.

Field or Control	Description
Print Course Attributes	Displays the course attributes associated with specific courses.
Print Contact Hours	Displays the instructor's contact hours.
Print Instructor Name	Displays the instructor name for each class.
Print Transcript Notes	Displays the transcript notes attached to student enrollment records.
Print Class Dates	Displays the class begin and end dates if set on the term/session table.
Print OEE Class Dates (print open entry/exit class dates)	Displays the student's unique begin date for each Open Entry/Open Exit class taken.
Obey Enrlmnt on Transcript Dt (obey enrollment on transcript date)	Select this check box for the system to display all enrollment information that is <i>fully enrolled</i> as of the transcript create date. The fully enrolled date is defined on the Academic Term Calendar 3 page. The date is set by default to the student's term activation record during term activation. You can manually change the date on a per student basis. The transcript process looks at the date on the student's term activation record. If you do not select this check box, all enrollment information that exists at the time that the transcript is processed appears on the transcript.
Obey Fully Graded Date	<p>If you do not select this check box, partially graded terms and sessions print on the transcript.</p> <p>Select this check box for the system to only display classes with fully graded dates less than or equal to the run date.</p> <p>The fully graded date is defined on the Academic Term Calendar 3 page. The date is set by default to the student's term activation record during term activation. You can manually change the date on a per student basis. The transcript process looks at the date on the student's term activation record.</p>
Withdrawal Information Print Area	Select the print area to indicate where the system displays withdrawal information. Values are <i>Enrollment Detail</i> and <i>Do Not Display</i> .

Field or Control	Description
Withdrawal Information Print Seq (withdrawal information print sequence)	<p>The print sequence determines the order in which withdrawal information appears within the print area. The system populates the print sequence by default. You can change the value.</p> <p>In the example, the enrollment information appears before the withdrawal information because both types of information have a print area of enrollment detail, and the print sequence for withdrawal information is greater than the print sequence enrollment information.</p>
Term Statistics Print Area	<p>Select the print area to indicate where the system displays term statistics information. Values are <i>Enrollment Header</i>, <i>Enrollment Trailer</i>, and <i>Do Not Display</i>. The system calculates statistics when you run the grade posting process. Print area values are delivered with your system on the Print Area Table page. Any modification to these values requires programming effort.</p>
Term Statistics Print Seq (term statistics print sequence)	<p>The print sequence determines the order in which term statistics information appears within the print area. The system populates the print sequence by default. You can change the value. In the example, term statistics, term honors, and academic standing print in the Enrollment Trailer area. Term statistics print first because the print sequence is less than both term honors and academic standing print sequence values.</p>
Print Transfer Credit Stats (print transfer credit statistics)	<p>Select this check box for the system to include transfer credit statistics in the display.</p> <p>When this check box is selected, transfer credit statistics appear separately from enrollment statistics wherever the term and cumulative statistics have been selected to print. In addition, when this check box is selected, the transfer credit is added into the combined statistics for both the term and the cumulative.</p>
Obey Show Stats on Tscript Dt (obey show statistics on transcript date)	<p>Select this check box for the system to display statistics only if the transcript process date is greater than or equal to the show statistics on transcript date value. The show statistics on transcript date value is defined on the Academic Calendar 3 page. The date is set by default to the student's term activation record during term activation. You can manually change the date on a per student basis. The transcript process looks at the date on the student's term activation record. If you do not select this check box, the system displays the statistics as of the last term.</p>

Field or Control	Description
Cumulative Statistics	The Cumulative Statistics group box enables you to determine where the system displays statistics. You can select the Print Cums at Change of Pgm (print cumulatives at change of program) check box. You can also select the Print Cums at End of Tscript (print cumulatives at end of transcript) check box on its own or in combination with the other check box.
Term Honors Print Area	Select the print area in order to indicate where the system displays term honors information. Values are <i>Enrollment Header</i> , <i>Enrollment Trailer</i> , and <i>Do Not Display</i> . Print area values are delivered with your system on the Print Area Table page. Any modification to these values requires programming effort.
Term Honors Print Seq (term honors print sequence)	The print sequence determines the order in which term honors information appears within the print area. The system populates the print sequence by default. You can change the value.
Academic Standing Print Area	Select the print area in order to indicate where the system displays academic standing information. Values are <i>Enrollment Header</i> , <i>Enrollment Trailer</i> , and <i>Do Not Display</i> . Values for this field are delivered with your system as translate values. Do not modify these values in any way. Any modification to these values requires a substantial programming effort.
Academic Standing Print Seq (academic standing print sequence)	The print sequence determines the order in which academic standing information appears within the print area. The system populates the print sequence by default. You can change the value.

Designating Transfer/Test/Other Data

Access the Transfer/Test/Other Credits page (**Set Up SACR > Product Related > Student Records > Transcript > Define Transcript Type > Transfer/Test/Other Credits**).

This example illustrates the fields and controls on the Transfer/Test/Other Credits page. You can find definitions for the fields and controls later on this page.

Transfer Credits

<i>Field or Control</i>	<i>Description</i>
<p>Print Area</p>	<p>Select the print area to indicate where the system displays Transfer Credit information. Values for this field are delivered with your system as translate values. Do not modify these values in any way. Any modification to these values requires substantial programming effort. Values are <i>Enrollment Detail</i>, <i>Enrollment Trailer</i>, <i>Transcript Header</i>, <i>Transcript Trailer</i>, and <i>Do Not Display</i>.</p> <hr/> <p>Note: If you select a value of <i>Enrollment Detail</i> with a Level of Detail field value of <i>Detail</i>, then the system populates by default and makes the following fields unavailable for entry: Print Posted Models Only: <i>Selected</i>; Inter-Career Transfer (Detail to Print): <i>Internal Equivalent Course</i>; Inter-Institution Transfer (Detail to Print): <i>Internal Equivalent Course</i>; and External Organization Transfer: <i>Internal Equivalent Course</i>.</p>

Field or Control	Description
Print Seq (print sequence)	The print sequence determines the order in which transfer credit information appears within the print area. The system populates the print sequence by default. You can change the value.
Print Posted Models Only	<p>If you select any print area other than <i>Enrollment Detail</i>, the Print Posted Models Only check box is available for entry. Select the Print Posted Models Only check box to display transfer credit from posted models only.</p> <p>If this check box is available and you do not select it, transfer credit from all models (posted, completed, and not posted) appears.</p> <p>Transfer credit print details are organized in three categories: Inter-Career, Inter-Institution, and External Organization transfers.</p>
Inter-Career Transfer	Transfers from academic career to academic career (or academic program to academic program, same academic career) in your institution. The source of data is the student's enrollment record at your institution.
Inter-Institution Transfer	Transfer between an external institution with which your institution shares a database. The source of data is the student's enrollment record at the external institution, but with a shared database you can bypass the data entry of external courses.
Level of Detail	<p>Select the level of detail to print for each type of transfer. Values are:</p> <p><i>Summary</i>: The system only displays total units transferred.</p> <p><i>Detail</i>: The system displays the course details, depending upon your selection in the Detail to Print field.</p>
Detail to Print	If you select <i>Detail</i> in the Level of Detail field, the Detail to Print field becomes available for entry. Values are <i>External and Internal</i> , <i>External Courses</i> , and <i>Internal Equivalent Course</i> .
External Organization Transfer	Most transfers fall into this category. Transfers between an external institution and your institution. The source of data is the external organization and is entered as external course work.

Field or Control	Description
Obey External Org Parm (obey external organization parameters)	Select this check box to obey the external organization transfer credit parameters on the Organization Affiliation page. Usually, you select this check box in order for official transcripts to follow the defaults set for printing external transfer information.

Test Credits

Field or Control	Description
Print Area	Select the print area to indicate where the system displays test credit information. Values for this field are delivered with your system as translate values. Do not modify these values in any way. Any modification to these values requires a substantial programming effort. Values are <i>Enrollment Detail</i> , <i>Transcript Header</i> , <i>Transcript Trailer</i> , and <i>Do Not Display</i> .
Print Seq	The print sequence determines the order in which test credit information appears within the print area. The system populates the print sequence by default. You can change the value.
Level of Detail	Select the level of detail to print for test credit. Values are: <i>Summary</i> : The system displays only total test credit units. <i>Detail</i> : The system displays the test credit details, depending upon your selection in the Details field.
Details	<p>If you select <i>Enrollment Detail</i> as the print area and a level of detail value of <i>Detail</i>, the system populates the Details field with <i>Internal Equivalent Course</i>. You cannot alter the details value.</p> <p>If you select <i>Transcript Header</i> or <i>Transcript Trailer</i> as the print area, and a level of detail value of <i>Detail</i>, you can select which details to print. Values are <i>Internal Equivalent Course</i>, <i>Test and Internal Equivalents</i>, and <i>Test Credits</i>.</p> <hr/> <p>Note: If you select a level of detail of <i>Summary</i>, regardless of the print area you select, the Details field is unavailable for entry.</p> <hr/>

Field or Control	Description
Print Posted Models Only	If you select any print area other than enrollment detail, the Print Posted Models Only check box becomes available for entry. Select the Print Posted Models Only check box to display only test credit from posted models. If this check box is available but you do not select it, test credit from all models (posted and not posted) appears.

Other Credits

Field or Control	Description
Print Area	Select the print area where other credit information is printed. Print area values are delivered with your system in the Print Area Table page. Any modification to these values requires programming effort. Values are <i>Enrollment Detail</i> , <i>Transcript Header</i> , <i>Transcript Trailer</i> , and <i>Do Not Display</i> .
Print Seq	The system populates the print sequence by default. The print sequence determines the order in which other credit information appears within the print area. You can change the value.
Level of Detail	Select the level of detail to print for other credit. Values are: <i>Summary</i> : The system only displays the cumulative total of other credit units. <i>Detail</i> : The system displays the other credit details, depending upon your selection in the Details field.
Details	If you select <i>Enrollment Detail</i> as the print area and a level of detail value of <i>Detail</i> , the system populates the Details field with <i>Internal Equivalent Course</i> . You cannot alter the details value. If you select <i>Transcript Header</i> or <i>Transcript Trailer</i> as the print area, and a level of detail value of <i>Detail</i> , you can select which details to print. Values are <i>Internal Equivalent Course</i> , <i>Other Credit and Internal Equivalents</i> , and <i>Other Credits</i> . Note : If you select a level of detail of <i>Summary</i> , regardless of the print area you select, the Details field is unavailable for entry.

Field or Control	Description
Print Posted Models Only	If you select any print area value other than <i>Enrollment Detail</i> , the Print Posted Models Only check box becomes available. Select the Print Posted Models Only check box for the system to display other credit from posted models only. If this check box is available and you do not select it, other credit from all models (posted and not posted) appears.

Designating Transcript Type Test Scores

Access the Test Scores page (**Set Up SACR > Product Related > Student Records > Transcript > Define Transcript Type > Test Scores**).

This example illustrates the fields and controls on the Test Scores page. You can find definitions for the fields and controls later on this page.

Field or Control	Description
Test Scores Print Area	Select the print area to indicate where the system displays test score information. Values for this field are delivered with your system as translate values. Do not modify these values in any way. Any modification to these values requires substantial programming effort. Values are <i>Transcript Header</i> , <i>Transcript Trailer</i> , and <i>Do Not Display</i> .
Test Scores Print Seq	The print sequence determines the order in which test score information appears within the print area. The system populates the print sequence by default. You can change the value.
Latest Test Only	Select this check box to only include the student's latest test scores on file in the system.

Field or Control	Description
Test ID	Select the identification number of the tests to be displayed.
Test Component	Select the component of the tests to be displayed.
Data Source	Select the data source of the tests to be displayed.

Designating Special GPA Information

Access the Special GPA page (**Set Up SACR > Product Related > Student Records > Transcript > Define Transcript Type > Special GPA**).

This example illustrates the fields and controls on the Special GPA page. You can find definitions for the fields and controls later on this page.

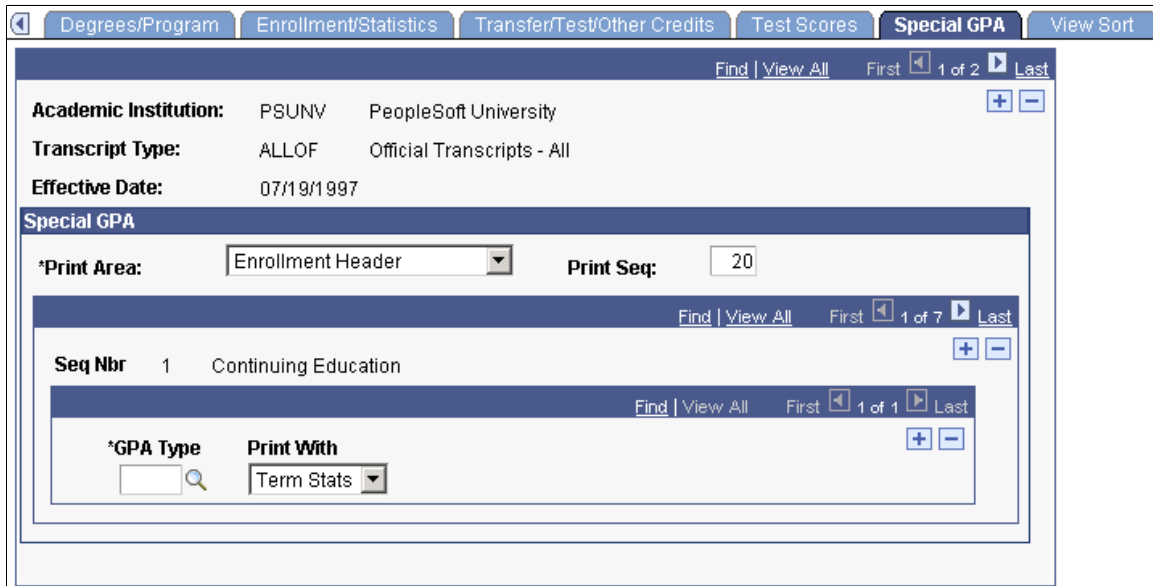

Field or Control	Description
Special GPA Print Area	Select the print area to indicate where the system displays GPA information. Values for this field are delivered with your system as translate values. Do not modify these values in any way. Any modification to these values requires substantial programming effort. Values are <i>Transcript Header</i> , <i>Transcript Trailer</i> , and <i>Do Not Display</i> .
Special GPA Print Seq (special GPA print sequence)	The print sequence determines the order in which GPA information appears within the print area. The system populates the print sequence by default. You can change the value.

Field or Control	Description
GPA Type	Special GPAs are defined by academic career. Select the special GPAs to be displayed.
Print With	This field identifies whether the special GPA represents a GPA for one term or represents a cumulative GPA. This setup determines where the special GPA prints, with term statistics or with the cumulative statistics.

Defining Data Sorting Order

Access the View Sort page (**Set Up SACR > Product Related > Student Records > Transcript > Define Transcript Type > View Sort**).

This example illustrates the fields and controls on the View Sort page (1 of 2). You can find definitions for the fields and controls later on this page.

Academic Institution: PSUNV PeopleSoft University
Transcript Type: ALLOF Official Transcripts - All

Effective Date: 07/19/1997

Page and Transcript Header		
Print Area	Row Type	Sort
Page Header	Institution Data	10
Page Header	Print Date	20
Transcript Header	Admissions	10
Transcript Header	Attendance Dates	20
Transcript Header	External Institutions	30
Transcript Header	External Degrees	70
Transcript Header	Program	90
Transcript Header	Test Scores	100

Enrollment		
Print Area	Row Type	Sort
Enrollment Header	Local Degrees	10
Enrollment Header	Special GPA	20
Enrollment Detail	Withdrawal	20
Enrollment Detail	Enrollment	30
Enrollment Detail	Transfer Credits	40
Enrollment Trailer	Term Statistics	40
Enrollment Trailer	Term Honors	50
Enrollment Trailer	Academic Standing	60

This example illustrates the fields and controls on the View Sort page (2 of 2). You can find definitions for the fields and controls later on this page.

Transcript Trailer	
Customize Find First 1 of 1 Last	
Row Type	Sort
Milestone	10

Do Not Display	
Customize Find First 1-8 of 8 Last	
Row Type	
Student Info	
Test Credits	
Other Credits	
Basis of Admission	
Requester	
Reason	
Recipient	
Scholarships and Grants	

<i>Field or Control</i>	<i>Description</i>
Page and Transcript Header	View the rows that the system displays on the header portion of the transcript, and the order in which they are set to appear.
Enrollment	View the rows that the system displays in the enrollment portion of the transcript, and the order in which they are set to appear.
Transcript Trailer	View the rows that the system displays in the trailer portion of the transcript, and the order in which they are set to appear.
Do Not Display	View the rows that the system does not display in the transcript.

Setting up Transcript Fees

Access the Fee Setup page (**Set Up SACR > Product Related > Student Records > Transcript > Define Transcript Type > Fee Setup**).

This example illustrates the fields and controls on the Fee Setup page. You can find definitions for the fields and controls later on this page.

Enrollment/Statistics | Transfer/Test/Other Credits | Test Scores | Special GPA | View Sort | **Fee Setup**

Details Find | View All First 1 of 1 Last

Academic Institution PSUNV PeopleSoft University + -

Transcript Type DEMO Official Transcript Demo

Effective Date 01/01/1900

Transcript Fee Item Types

Payment Required? Yes No

Post to GL from Transcript App

Charge Item Type 810000000200 Transcript Fees

SF Merchant ID EPMTCRCRD ePayment Credit Card

Credit Card Item Type 310000000150 Credit Card - Direct to GL

SF eCheck Merchant ID EPMTCHECK ePayment Check

eCheck Item Type 310000000525 eCheck - Direct to GL

Transcript Fee

Flat Amount 25.00 USD

Transcript Fee Rule

Rule Name

Rule Search

Use the Fee Setup page to set up the fee structure for official transcript requests made through Fluid user interface.

You can edit this page only when the following conditions are set on the Basic Data page:

- Transcript Level = Print on Official
- Allow Student Self Service is selected
- Transcript Fee Required = Yes

Transcript Fee Item Types

Use this region to specify the item types related to the transcript fee.

Field or Control	Description
Payment Required	<p>If you select:</p> <ul style="list-style-type: none"> • <i>Yes</i>, you require payment for official transcript requests. The fields for item types and financial merchants appear on the page. <p>You must specify one merchant ID and its corresponding item type.</p> <ul style="list-style-type: none"> • <i>No</i>, you do not require payment for official transcript requests. <p>If you do not select a value, the system also treats it as <i>No</i>.</p> <p>If you set Transcript Fee Required to “Yes” on the Basic Data page and Payment Required is set to “No,” you can still define transcript fees — either a flat amount or an amount calculated through the rules engine. You can also define delivery methods and fees. The fee is calculated and stored in the transcript table. Your institution can extract the total fee and then collect the payment outside of Campus Solutions, or manually post the total fee to the student’s account.</p>
Post to GL from Transcript App	If Payment Required is set to “Yes,” then this field is automatically selected and you are not able to modify it.
Charge Item Type	<p>Select a value. This field is required for Direct to GL.</p> <p>This field is required as well as one payment type. Make sure you already set up the GL chart of accounts for accurate general ledger transactions.</p>
SF Merchant ID	Select a value. This field is used for hosted payment framework.
Credit Card Item Type	Select a value. This field is used for Direct to GL.
SF eCheck Merchant ID	Select a value. This field is used for hosted payment framework.
eCheck Item Type	Select a value. This field is used for Direct to GL.

Transcript Fee

Use this region to define the fee you want to charge for an official transcript. You can edit the values in this region whether or not you require payment for a transcript. However, if you set Payment Required = “Yes,” you must specify at least one amount: a flat amount, an amount calculated using rules engine, or a delivery fee.

<i>Field or Control</i>	<i>Description</i>
Flat Amount	Set the transcript fee amount. The amount you specify here is multiplied by the quantity the student requests.
Rule ID	Select the rule you want to use to calculate the transcript fee. Your institution can create its own rule for assessing transcript fees. Campus Solutions provides a sample transcript fee rule: Transcript Fee Calculation Sample. The sample rule calculates a discount if a student requests three or more transcripts. See also “Library of System-Delivered Rules Engine Objects” (Campus Community Fundamentals).

Related Links

[Setting Up Delivery Methods](#)

“Setting Up Electronic Payments for Self Service” (Student Financials)

“Setting Up Hosted Payment” (Recruiting and Admissions)

Setting Up Delivery Methods

Use the Define Delivery Method component to set up various delivery methods and delivery fees when students request an official transcript using PeopleSoft Fluid User Interface.

To add a delivery method, and then set it up:

1. Go to **Set Up SACR > Product Related > Student Records > Transcript > Define Delivery Methods CS**.
2. Click **Add a New Value**.
3. Select an academic institution. and then define a delivery method.
4. In **Delivery Method**, specify a four-character code for the delivery method.
5. Click **Add**.
6. Locate the delivery method you added, and then select it to access the Define Delivery Methods page.

Pages Used to Set Up Delivery Methods

<i>Page Name</i>	<i>Definition Name</i>	<i>Navigation</i>	<i>Usage</i>
Define Delivery Methods	SSR_DELIVER_TBL	Set Up SACR > Product Related > Student Records > Transcript > Define Delivery Methods CS	Set up various delivery methods and fees.

Defining Delivery Methods and Fees

Access the Define Delivery Methods page (**Set Up SACR > SSR_DELIVER_TBL Product Related > Student Records > Transcript > Define Delivery Methods CS**).

This example illustrates the fields and controls on the Define Delivery Methods page. You can find definitions for the fields and controls later on this page.

The screenshot shows the 'Define Delivery Methods' page with the following details:

- Academic Institution:** PSUNV
- Delivery Method:** INTL (with a 'Default' checkbox)
- Description:** International Federal Express
- Delivery Charge:** 35.00
- Currency Code:** USD
- Display Notes to Student:** Includes a checkbox for 'Display in Self Service' and a text area for 'Notes'.

<i>Field or Control</i>	<i>Description</i>
Default	Select if you want this method to be the default delivery method that appears when students request transcripts using Fluid user interface.
Description	Enter a description of the delivery method. This appears in Self Service Fluid user interface.
Delivery Charge	(Optional) Enter the fee for the delivery method.

<i>Field or Control</i>	<i>Description</i>
Base Currency	This value is derived from Set Up Common Objects > Install > Installation Table > Settings and Defaults .

Display Notes to Student

<i>Field or Control</i>	<i>Description</i>
Display in Self Service	Select if you want to display a message to students when they request an official transcript in Self Service Fluid user interface.
Notes	Enter the message you want to display in Self Service Fluid user interface.

Setting Up Electronic Transcript Processing

To set up electronic transcript processing, use the TS130/TS131 Setup component (TS130_CONTROL).

This section discusses how to:

- Define TS130 and TS131 controls.
- Define reporting codes and email information.
- Define TS130 contacts.
- Set up data maps for TS130 outbound processing.

Related Links

[Producing Electronic Transcripts](#)

Pages Used to Set Up Electronic Transcript Processing

<i>Page Name</i>	<i>Definition Name</i>	<i>Navigation</i>	<i>Usage</i>
TS130/TS131 Setup	TS130_CONTROL	Set Up SACR > Common Definitions > TS130/TS131 Setup > TS130/TS131 Setup	Define codes and values that are reported in the TS130 and TS131 files.

<i>Page Name</i>	<i>Definition Name</i>	<i>Navigation</i>	<i>Usage</i>
TS130 Setup	TS130_CONTROL2	Set Up SACR > Common Definitions > TS130/TS131 Setup > TS130 Setup	Define reporting code formats and information about the email message the system generates, such as the subject line and the sender email address.
TS130 Contacts	TS130_CONTROL_COM	Set Up SACR > Common Definitions > TS130/TS131 Setup > TS130 Contacts	Specify the contact information for your organization that you want included in the outbound file.

Defining TS130 and TS131 Controls

Access the TS130/131 Setup page (**Set Up SACR > Common Definitions > TS130/TS131 Setup > TS130/TS131 Setup**).

This example illustrates the fields and controls on the TS130/131 Setup page. You can find definitions for the fields and controls later on this page.

TS130/131 Setup
TS130 Setup
TS130 Contacts

Academic Institution: PSUNV PeopleSoft University

Find | View All First ◀ 1 of 1 ▶ Last

*Effective Date:	<input type="text" value="01/01/1900"/>		*Status:	<input type="text" value="Active"/>	+ -
Separator:	<input type="text" value=""/>				
*End of Line:	<input type="text" value="~"/>				
*Sub-element Separator:	<input type="text" value="^"/>				
*Institution Code to Report:	<input type="text" value="Mutually Defined"/>				
*Sending Institution Code:	<input type="text" value="123456789012345"/>				
*Sending Status:	<input type="text" value="Test Data"/>				
<input type="checkbox"/> Acknowledgement Requested					
*Receive Institution Code (ISA):	<input type="text" value="FICE Code"/>				
*Send Institution Code (N1):	<input type="text" value="ATP Code"/>				
*Sending Institution Code (N1):	<input type="text" value="54231"/>				
*Receive Institution Code (N1):	<input type="text" value="FICE Code"/>				
<input checked="" type="checkbox"/> Using TS130					

Field or Control	Description
Separator	Insert a character that separates values in the output file.
End of Line	Insert a character that ends a line in the output file. This value must be different from the separator value.
Sub-element Separator	Insert a character that the system uses to separate component data structure. This character must be different from the separator and end of line delimiters.
Institution Code to Report	Choose the type of code that you report on the ISA segment (Interchange Control Header Data Element Summary) as the Interchange ID Qualifier for the Interchange Sender ID. The values are <i>ACT Code</i> , <i>ATP Code</i> , <i>FICE Code</i> , <i>IPEDS Code</i> , <i>Mutually Defined</i> , <i>Stat Canada College Student</i> , <i>Stat Canada Postsecondary</i> , and <i>Stat Canada Uni Student Inst.</i>
Sending Institution Code	Enter your institution's appropriate code, as determined by the value you select in the Institution Code to Report field.
Sending Status	Select <i>Test Data</i> while the institution is sending test files to trading partners. Select <i>Production Data</i> after testing is complete and TS130 outbound transactions are official.
Acknowledgement Request	Select to request the receiving institution to respond with a TS997 Functional Acknowledgement.
Received Institution Code (ISA)	Choose the type of code that you report on the ISA segment (Interchange Control Header Data Element Summary) as the Interchange ID Qualifier for the Interchange Receiver ID. Values are <i>ACT Code</i> , <i>ATP Code</i> , <i>FICE Code</i> , and <i>IPEDS Code</i> . These values are defined on the Organization Table page for each institution.
Send Institution Code (N1)	Choose the type of code that you report on the N1 segment (Name [Sending/Receiving Institution]) as the identification code qualifier. Values are <i>ACT Code</i> , <i>ATP Code</i> , <i>College Board and ACT</i> , <i>FICE Code</i> , <i>IPEDS Code</i> , <i>Statistics Canada College</i> , and <i>Statistics Canada University</i> .
Sending Institution Code (N1)	Enter the appropriate code for your institution, as determined by the value entered in the Send Institution Code field.
Receive Institution Code (N1)	Select the appropriate code that the institution reports as the recipient in the N1 segment. Values are <i>ACT Code</i> , <i>ATP Code</i> , <i>FICE Code</i> , and <i>IPEDS Code</i> . These values are defined on the Organization Table page for each institution.

Field or Control	Description
Using TS130	Select if you process TS130 outbound transactions for this institution.

Note: If the characters you enter in the **Separator**, **End of Line** or **Sub-element Separator** fields appear within any text that is included in the output file, the receiving institution recognizes the character and inappropriately separates a field or ends a line. Select characters that are *not* found in any fields or text that is part of the output file.

Defining Reporting Codes and Email Information

Access the TS130 Setup page (**Set Up SACR > Common Definitions > TS130/TS131 Setup > TS130 Setup**).

This example illustrates the fields and controls on the TS130 Setup page. You can find definitions for the fields and controls later on this page.

TS130/131 Setup
TS130 Setup
TS130 Contacts

Academic Institution: PSUNV PeopleSoft University

Find | View All
First ◀ 1 of 1 ▶ Last

Effective Date: 01/01/1900 **Status:** Active + -

TS130 Report Setup

External Institution Code:

Course/Field of Study Code:

Lowest Possible GPA:

Highest Possible GPA:

Historic Enrol Grade Qualifier:

Email Address

TS130 E-Mail Subject:

Email Address:

File Name:

Default Path for Output File:

Field or Control	Description
External Institution Code	Select the type of code that the institution reports for students' previously attended institutions that are reported for other institutions attended. Values are <i>ACT Code</i> , <i>ATP Code</i> , <i>FICE Code</i> , and <i>IPEDS Code</i> . These values are defined on the Organization Table page for each institution.
Course/Field of Study Code	Select the type of course or field of study code that the institution reports. Values are <i>CIP Code</i> and <i>HEGIS Code</i> . Course codes are defined on the Offerings page of the Course Catalog component and field of study codes are defined on the Academic Plan Taxonomy page.
Lowest Possible GPA	Enter the numeric value for the lowest possible GPA at this institution to be reported in the SUM (Academic Summary) segment.
Highest Possible GPA	Enter the numeric value for the highest possible GPA at this institution to be reported in the SUM (Academic Summary) segment.
Historic Enrol Grade Qualifier	Enter the academic grade qualifier code that you report with historical course enrollments. The codes are based on the American Medical Colleges Admissions Services (AMCAS) grade scale. Please refer to Appendix B of the American National Standards Institute Accredited Standards Committee (ANSI ASC) X12 Version 4.0 Implementation Guide dated April 1998.
TS130 E-Mail Subject	Enter a free form text that the system uses as the subject line in the email that delivers the TS130.
Email Address	Enter free form text that the system uses as the sender of the TS130 email.
File Name	Enter the file name that you want the system to use for each TS130 file when the system creates the file. The system inserts the control number before the file extension to identify unique files.
Default Path for Output File	Enter the default path to which the system writes the TS130 file at the time it is generated. Note: Users must have write permission for this specified directory to prevent runtime errors. Also, you must enter the final slash in the file path.

Defining TS130 Contacts

Access the TS130 Contacts page (**Set Up SACR > Common Definitions > TS130/TS131 Setup > TS130 Contacts**).

<i>Field or Control</i>	<i>Description</i>
Contact Function Code	Select the function code, which identifies the major responsibilities of the person or office to which the system directs administrative communications about the TS130.
Name	Enter a free form name for the contact.
Communication Type	Select the type of communication that defines the communication number. You can add up to three communication types.
Communication Number	Enter a free form communication number, such as a telephone number.

Setting Up Data Maps for TS130 Outbound Processing

To report the correct standardized codes in the TS130 output file, users must map their internal values to the correct standard code. For instance, because the Degree table is a user-defined table, users must map an internal value of *BA* to a standard code of 2.4.

The system uses the Conversion Data Profile found within the EDI Manager to define these values. If you are currently using the TS130 Inbound process, you have already mapped several tables and fields. The TS130 Outbound process uses some of the same profiles, but it requires additional ones.

To set up data maps for TS130 Outbound processing, navigate to the EDI_CONV conversion data profile. Go to **PeopleTools > EDI Manager > Convert EDI/PeopleSoft Code > Conversion Date Profile**. Enter *EDI_CONV* in the **EC Convert Profile ID** field on the search page.

While mapping your internal values to external codes, you might find that you have a many-to-one mapping situation, where multiple internal values could be used to map to the same external code. In this situation, the process picks up the codes for which you selected the **Int Deflt** (internal default) check box.

We deliver the following convert type IDs, however, users must define the internal and external values for each type:

<i>Convert Type IDs</i>	<i>Internal Values</i>	<i>Maps To</i>
ACAD_CAR: TS130 Course Level per Career	ACAD_DEGREE.DEGREE AND EXT_ DEGREE.DEGREE	DEG01
DEGR_HONOR: TS130 Degree Honors	ACAD_DEGR_HONS.HONORS_ CODE	DEG05

Convert Type IDs	Internal Values	Maps To
FOS_LEVEL: TS130 Field of Study Level	ACAD_PLAN_TBL.ACAD_PLAN_TYPE	FOS01
GRADE_BAS: EDI TS130/TS189 Grade Basis	STDNT_ENRL.GRADING_BASIS_ENRL	CRS05
MILESTONE: TS130 Student Milestone	STDNT_CAR_MLSTN.MILESTONE	ATV02
STDNT_AWRD: EDI TS130 Student Award	HONOR_AWARD_CS.AWARD_CODE	ATV02
TERM_CATEG: EDI TS130 Term Category	TERM_TBL.TERM_CATEGORY	SES02

Mapping Transcript Type to TS130 Files

While several segments and elements are required with the TS130 file, users can define the overall content that the system reports in the electronic transcript. Depending on the transcript type associated with the electronic transcript request, you can choose what student information gets reported. If a piece of information is set to print as defined by the transcript type, and there is a corresponding functional segment available on the TS130, then the system reports it on the TS130, disregarding the exact print sequence and print area.

Exceptions to the previous rule include:

- Transcript text is not currently included in the output file.
- For transfer credit (course, test, and other) to be reported, the level of detail must include the internal equivalent.

Chapter 15

Setting Up Activity Management

Prerequisites for Setting Up Activity Management

In order to gain the highest value from this documentation, we suggest that readers be familiar with the following items:

- Basic PeopleSoft Tree Structure, vocabulary, and components.
 - Campus Solutions Academic Structure.
 - Campus Solutions Course Catalog.
 - Campus Solutions Schedule of Classes.
 - Campus Solutions Instructor/Advisor Table.
 - Campus Solutions Grading Setup.
 - Basic Academic Structure Security.
-

Setting Up an Activity Management Framework

This section discusses how to:

- Define content categories.
- Define content devices.
- Define exam types.
- Define forms of identification.
- Define a result scale.
- Define content messages.
- Define academic periods.
- Define Extenuating Circumstances.
- Define inclusion types.
- Review date sources.
- Define date settings.
- Define action dates.

- Define result dates.

Understanding Activity and Result Dates for Self Service

The Date Sources, Date Settings, Action Dates, and Result Dates components comprise a structure that allows schools to establish self-service controls for students and instructional staff (faculty and exam staff). This feature is designed to be a one-time setup using delivered date sources, negating the need to set up these controls on a term-by-term basis.

You must select a date source to control when to begin and end specific access for actions and results. Similar to the dynamic date feature, you have the ability to indicate how many days before or after this date the controls should begin or end.

For students, you must define when optional activities can be selected. For example, students may have a choice of submitting either a written report or presenting an oral report. You must define the range of dates, using the delivered date sources, that a student has to make that choice. For instance, your institution may want students to begin their selection of an optional assessment item on the session start date, but complete this selection five days before the assessment item due date. Define these dates on the Action Dates component. These can be defined down to the academic program level. If your institution does not allow optional selections of activities, you do not need to set up Action Dates.

You must also define when students can view their course activities results. Set this up on the Result Dates component using the *Student Self Service View* Release Type. Again, you can define these down to the academic program level, but you can also restrict the view of results to specific result statuses.

For instructional staff, you must define when to display the result rosters in the Activity Management WorkCenter and whether they can manually enter results (grades) and calculate results. Using the Result Dates component with the *Faculty Self Service Update* Release Type, your institution can define dates for specific academic organizations and which result access – calculate or grade – can be performed.

See the following sections for more details about defining activity and result dates for self service:

- Reviewing date sources.
- Defining date settings.
- Defining action dates.
- Defining result dates.

Pages Used to Set Up an Activity Management Framework

Page Name	Definition Name	Navigation	Usage
Content Categories	SSR_AC_TYPE_TBL	Curriculum Management > Activity Management > Setup > Content Categories	Set up content categories used in activity management.
Content Devices	SSR_AC_DEVICES_TBL	Curriculum Management > Activity Management > Setup > Content Devices	Set up content devices used in activity management.

Page Name	Definition Name	Navigation	Usage
Exam Types	SSR_AC_EXAMTYP_TBL	Curriculum Management > Activity Management > Setup > Exam Types	Set up exam types used in activity management.
Forms of Identification	SSR_AC_ID_REQ_TBL	Curriculum Management > Activity Management > Setup > Forms of Identification	Set up forms of ID accepted by your institution as part of activity management.
Result Scale Table	SSR_GRADE_MAP_TBL	Set Up SACR > Product Related > Student Records > Grading > Result Scale	Define a result scale that is attached to the various content types of a course.
Content Messages	SSR_AC_MESSAGES	Curriculum Management > Activity Management > Setup > Content Messages	Set up messaging that is used in activity management.
Academic Period Table	SSR_PERIOD_TBL	Set Up SACR > Foundation Tables > Term Setup > Academic Periods	Set up academic periods used as part of activity management.
Activity Extenuating Circumstances	SSR_AC_ITEMTYPE	Curriculum Management > Activity Management > Setup > Extenuating Circumstances	Define reason codes specific to an activity or a result.
Inclusion Types	SSR_AC_INCLTYPE	Curriculum Management > Activity Management > Setup > Inclusion Types	Activate inclusion types to be used in the Activity Definition.
Date Sources	SSR_ADC_SETUP	Curriculum Management > Activity Management > Setup > Date Sources	Indicates the available records when setting activity dates.
Date Settings	SSR_ADC_MAPPNG	Curriculum Management > Activity Management > Setup > Date Settings	Set date sources for actions and results.
Action Dates	SSR_ADC_ACTN_CTRL	Curriculum Management > Activity Management > Setup > Action Dates	Set parameters for when students can select optional activities.

Page Name	Definition Name	Navigation	Usage
Result Dates	SSR_ADC_RSLT_CTRL	Curriculum Management > Activity Management > Setup > Result Dates	Set parameters for when instructional staff can grade activities.

Defining Content Categories

Access the Content Categories page (**Curriculum Management > Activity Management > Setup > Content Categories.**).

You should define content categories if categories are utilized as a content type in your activity content tree. Content categories are used to group individual content items into a category that has meaning to your institution. This setup is optional, but provides the ability to set calculation rules against a given category, if necessary, the ability to group assignments for display purposes, or both. Categories are child items to courses and components in the content tree structure. They can also be children to conditions. Additional examples of categories include reading assignments, quizzes, in-class tests, research, and homework.

Defining Content Devices

Access the Content Devices page (**Curriculum Management > Activity Management > Setup > Content Devices.**).

A content device is any item that a student is allowed to utilize during an examination or required for a course or to complete a piece of coursework. Devices are associated with specific content items in the activity registry. Content devices are optional. Additional examples of content devices include dictionary, thesaurus, textbook, digital camera, and paint brushes.

Defining Exam Types

Access the Exam Types page (**Curriculum Management > Activity Management > Setup > Exam Types.**).

Exam types are required for course-level examinations and are a means to further define the nature of an exam; they are associated with an exam content item on the activity registry. Additional examples of exam types include open-book, closed-book, oral, and final.

Note: If you are using resit functionality and there are multiple examinations within a course, each exam must have a different exam type.

Defining Forms of Identification

Access the Forms of Identification page (**Curriculum Management > Activity Management > Setup > Forms of Identification.**).

Forms of identification are any items that a student may be required to provide prior to entrance into an examination at your institution. This setup is optional. Forms of identification are associated with a

specific exam content item in the activity registry. Additional examples of forms of identification include examination entry form, campus ID, and waiver form. Forms of Identification can be established at the Academic Institution, Career, or Organization level and can be applied automatically to course activity registries.

Defining a Result Scale

Access the Result Scale Table page (**Set Up SACR > Product Related > Student Records > Grading > Result Scale**).

This example illustrates the fields and controls on the Result Scale Table page (1 of 2). You can find definitions for the fields and controls later on this page.

Result Scale Table

Result Scale Find | View All First 1 of 1 Last

SetID PSUNV Peoplesoft University

Scale 100 PT *Effective Date 01/01/1900 *Status Active

Description 100 Point Scale - Undergraduate

Scale Options

Mandatory Pass Result Scale

Enable Score

Enable Mark

Integer Positions 3 Decimal Positions 2

Decimal Option Rounded To 0 Decimal(s) Apply to Course Mark Only

Minimum Mark 0.00 Maximum Mark 100.00

Display Mark Range

Enable Description

Enable Grade

Enable Outcome

Mandatory Pass Calculation Options

Use Course Result Scale

Use Mandatory Pass Result Scale Mandatory Pass Result Scale

This example illustrates the fields and controls on the Result Scale Table page (2 of 2). You can find definitions for the fields and controls later on this page.

Scales Find | View All First 1 of 2 Last

Grading Scheme UGD Undergraduate Grading Scheme

Grading Basis GRD Graded

Fetch Grades Copy From Copy To

Mark	Maximum Mark	Exclude Mark	Default Mark	Grade	Grade Description	Outcome	Resit Eligible
96.00	100.00			A+	Excellent	Pass	<input type="checkbox"/>
90.00	95.99			A	Excellent	Pass	<input type="checkbox"/>
80.00	89.99			B	Good	Pass	<input type="checkbox"/>
70.00	79.99			C	Average	Pass	<input type="checkbox"/>
60.00	69.99			D	Poor	Pass	<input type="checkbox"/>
0.00	59.99	<input type="checkbox"/>	<input checked="" type="checkbox"/>	F	Fail	Fail	<input checked="" type="checkbox"/>
0.00	59.99	<input type="checkbox"/>		I	Incomplete	Incomplete	<input type="checkbox"/>

On this page you establish how scores and marks map to grades and outcomes. If using program enrollment, users can define which of these fields, calculated at the activity level, they want to update to a student's Academic Progress Tracker (APT). The Grade In/Official value can also populate the Student Enroll record (STDNT_ENRL), in much the same way as the system currently does in the Student Records core grading process. A Result Scale can be established at the Academic Institution, Career, or Organization level and can be applied automatically to course activity registries.

Scale Options

The options you select in this group box determine the appearance of the Scales group box below.

Field or Control	Description
Mandatory Pass Result Scale	Select this check box to tag the scale as a scale that can be used for Mandatory Pass Calculation.
Mandatory Pass Calculation Options	<p>Select one of two options if mandatory fail is detected during calculation:</p> <ul style="list-style-type: none"> • Use Course Result Scale: Select this option to set the mark to zero and use the scale defined in the course activity if a mandatory fail is detected during calculation. • Use Mandatory Pass Result Scale: Select this option and specify a Mandatory Pass Result Scale to use if mandatory fail is detected during calculation. When this happens, the actual calculated mark is saved with the set grade and outcome using the provided Mandatory Pass Result Scale. <p>When you select Mandatory Pass Result Scale, then Mandatory Pass Calculation Options are disabled.</p> <p>When you select the Use Mandatory Pass Result Scale option, a message is displayed if the scale is currently in use my Activity Registry, Activity Manager, or Individual Activity Manager (IAM). If you click OK in the message box, another message informs you that any values in Mandatory Fail and Result Eligible columns will be removed.</p>
Enable Score	<p>Select this check box to display the Score column below, and define the field as either Character or Numeric. If you enable the Score column, users can enter a value that can be translated to a Mark. This check box is cleared by default.</p> <p>The score is an optional result field that can be used to map a value that is not used in calculation to a mark that is used in calculation.</p>
Score Value Field Type	This field appears when you select the Enable Score check box. Specify whether the free-form Score is entered as a <i>Character</i> or <i>Numeric</i> value.
Integer Positions, Decimal Positions	These fields appear when the Score Value Field Type is <i>Numeric</i> . Specify the position that the integer and decimal fields can use.

Field or Control	Description
Enable Mark	Select this check box to display the Mark column below. Marks are required for those scales where result values require calculation. This check box is selected by default.
Integer Positions, Decimal Positions	These fields appear when the Enable Mark check box is selected. Specify the position the integer and decimal fields can use. The default value is 0; you must define the position values.
Decimal Option, To __ Decimals	Indicate how to round or truncate the decimal position for an entered or calculated mark on a student's record.
Minimum Mark, Maximum Mark	These fields appear when the Enable Mark check box is selected. Together, they indicate the numerical range of the scale; that range is used to validate entered marks against a student's record. During the grading process if an entered mark falls outside the range of these minimum and maximum values, the user receives an error.
Apply to Course Mark Only	This is enabled when Mandatory Pass Result Scale is enabled.
Display Mark Range	This field appears when the Enable Mark check box is selected. Select the check box to allow users to view the upper end of the range for each mark entered. The upper end of the range appears in the Maximum Mark column of the Scale grid below. This check box is cleared by default.
Enable Description	Select this check box to display the Score/Mark Description column below. This check box is cleared by default.
Enable Grade	Select this check box to display the Grade and Grade Description columns below. If you select this check box, the Grading Scheme and Grading Basis fields also appear. This check box is selected by default. Note: Currently, to enter results on the Individual Activity Manager (IAM) a result scale must possess a student's enrollment grading scheme/grade basis.
Enable Outcome	Select this check box to display the Outcome column below, where you can define the outcome of a score/mark/grade combination. This check box is selected by default.

Scales

Field or Control	Description
Grading Scheme	Identify the grading scheme from which the grade basis and grade are mapped. A result scale can have multiple grading schemes and grade bases, but the course to which the result ID is associated must have one of the grading scheme and grade bases combinations defined here.
Grading Basis	Identify the grade basis from which the grade is mapped.
Fetch Grades	<p>You can click this button after a grading scheme and basis have been entered. The system displays all grades defined on the grade table for the given grading scheme and grading basis. The system then displays a message when grades are fetched and displays them here.</p> <p>Note that you can delete any grade from the scale after the fetch process is complete.</p>
Copy From	You can click this button if the Enable Grade check box is selected. To use Copy From , a previously saved scale within this result scale must exist. To execute the copy, insert a new row; enter the Grading Scheme and Grading Basis , then select Copy From .
Copy To	You can click this button if the Enable Grade check box is selected and a previously saved scale exists.
Score	<p>This column appears if the Enable Score check box is selected above. Use this field if the initial result provided to the student differs from the corresponding mark or grade field. The value entered here maps to the specific mark value.</p> <p>If you use this column, the Display Mark Range and Maximum Mark fields are disabled.</p>

Field or Control	Description
Mark	<p>This column appears if the Enable Mark check box is selected above. The system maps marks in one of two ways:</p> <ul style="list-style-type: none"> • If you enter a score here, the system maps it directly to a mark and disables the Display Mark Range and Maximum Mark fields. • If you do not enter a score, the system treats the mark as a range. The value entered here becomes the lowest value of the range used by the system to map to a grade and outcome. For example, the system grants an A grade for students receiving any mark from 90.00 to 97.99. A student receiving a 98.00 to 100.00 receives an A+. <p>Use this field, in combination with the Maximum Mark field, to indicate the range of each row.</p>
Maximum Mark	<p>This column appears if the Display Mark Range check box is selected above. Use this field, in combination with the Mark field, to show the full range of a specific row. The value that appears here is derived from the actual values entered in the Mark column.</p>
Exclude Mark	<p>This check box appears when the Mark value of a row is zero (0.00). Select this check box when a mark should not be used in a calculation.</p> <p>Rows containing grade outcomes such as Incomplete and Withdrawn are the most likely candidates to be excluded.</p>
Default Mark	<p>This check box appears when there is duplication in the Mark column. When duplication occurs, select which mark the system should use for calculation purposes.</p> <p>In the above example, a student who earns a mark between 60.00 and 69.99 receives a grade of <i>D / Poor</i> by default; faculty and administrative users have the ability to override and change the grade to <i>P / Pass</i> or <i>X / Transfer Pass</i> where necessary for individual students.</p>
Grade	<p>The values in this column are retrieved from the Grade Table when you select the Fetch button; you can also enter them manually. You can delete any fetched grade values.</p>

Field or Control	Description
Outcome	<p>Select <i>Passed, Failed, Withdrawn, Audit, or Incomplete</i>.</p> <p>The Outcome (SSR_RESULTS_STATUS) is populated based on the following logic when the grade field is populated:</p> <ol style="list-style-type: none"> 1. Grades with In Progress Grade flag = Y tagged as Incomplete. 2. Grades with Earn Credit flag = Y and Grade Points > 0, tagged as Passed. 3. Any Convert To grade pointing to a grade identified in step 2, tagged as Passed. 4. Any grade <=> steps 1, 2 or 3 and Include in GPA = Y, tagged as Failed. 5. Any Convert To grade pointing to a grade identified in step 4, tagged as Failed. 6. Any grades <=> 1, 2, 3, 4 or 5 left blank. <hr/> <p>Note: Any values added to SSR_RESULTS_STATUS must also be set up on SSR_IAM_OUTCOME.</p> <hr/>
Resit Eligible	<p>Indicate which mark, grade, and outcome combinations are eligible for reassessment. This field works in conjunction with the Resit Inclusion defined on the Activity Registry page and maintained on the Activity Manager page.</p>
Mandatory Fail	<p>This feature is used with the Mandatory Pass feature set up in the Activity Registry or the Activity Manager. It allows schools to indicate that if a particular activity of a course is failed, then the student fails the overall course. If an activity is noted as a Mandatory Pass and the student fails it, the system populates the mark indicated here as the Mandatory Fail result on the course result.</p> <p>In the example above—a student who fails an activity required as Mandatory Pass—the system inserts a course result row with a mark of 59.99, the grade of F, and the outcome of Fail. Any mark/grade/outcome combination can be set as the Mandatory Fail row. Another common setting for this the result row may be 0.00 / F / Fail.</p>

Defining Content Messages

Access the Content Messages page (**Curriculum Management > Activity Management > Setup > Content Messages**).

This example illustrates the fields and controls on the Content Messages page. You can find definitions for the fields and controls later on this page.

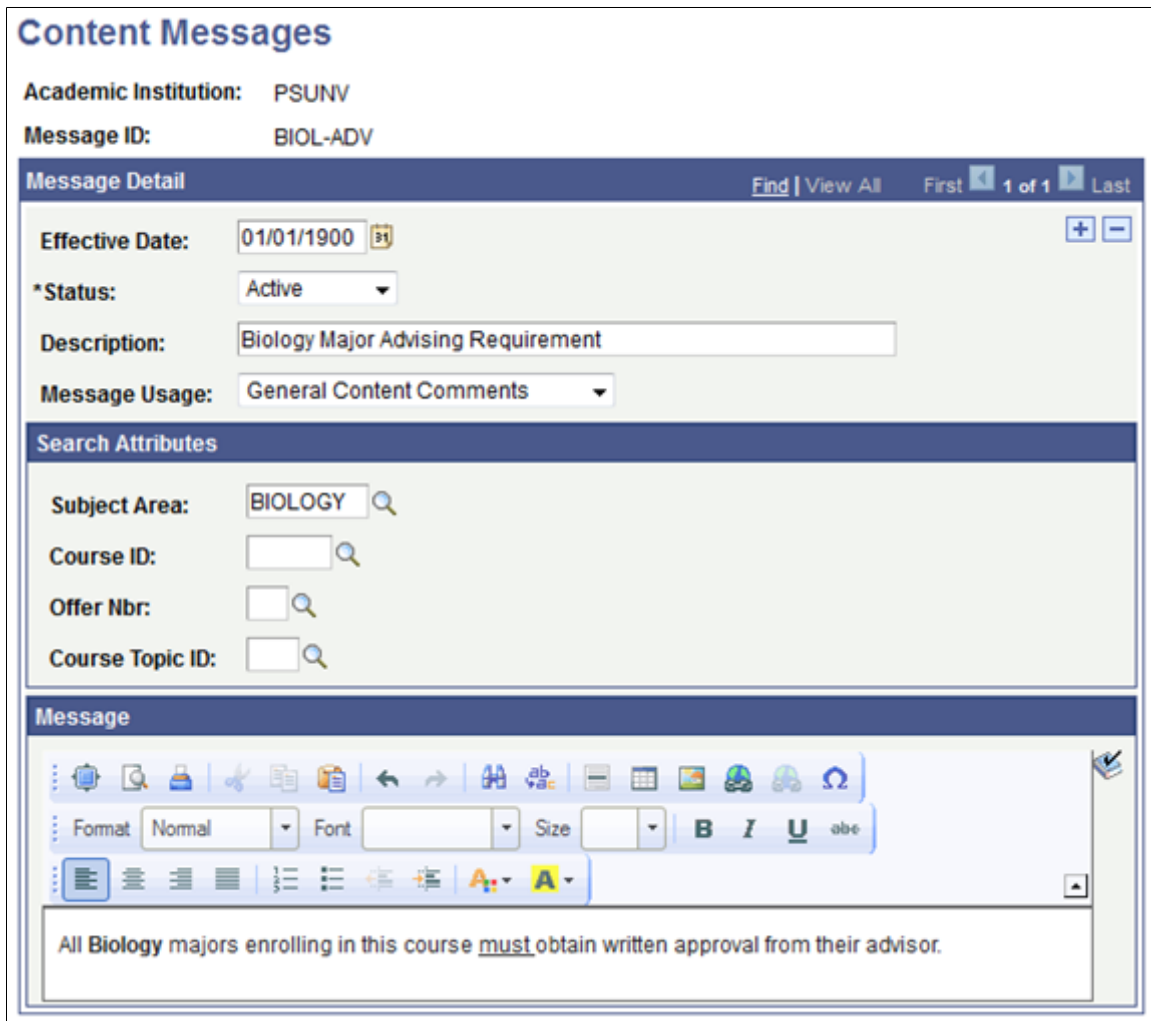

Content Messages

Academic Institution: PSUNV
 Message ID: BIOL-ADV

Message Detail Find | View All First 1 of 1 Last

Effective Date: 01/01/1900
 *Status: Active
 Description: Biology Major Advising Requirement
 Message Usage: General Content Comments

Search Attributes

Subject Area: BIOLOGY
 Course ID:
 Offer Nbr:
 Course Topic ID:

Message

All Biology majors enrolling in this course must obtain written approval from their advisor.

Content messages that you create here can be used within the activity registry. You can also enter free-form messages directly into the activity registry. Content messages are created as either *General Content Comments* or *Staff Instructions*. General content comments are directives for students and staff and are associated with content types in the activity. Staff instructions are associated with examination staff in the activity registry. Staff instructions are only visible to staff members assigned to a given exam.

Field or Control	Description
Message Usage	Select either <i>General Content Comments</i> or <i>Staff Instructions</i> . General content comments are prompted as content notes in the activity registry for each content type. Staff instructions are prompted as administrative instructions in the Staffing Requirements section in the activity registry for exam content types.
Subject Area, Course ID, Offer Nbr (number), Course Topic ID	These fields serve as search filters in the activity registry and activity manager for content notes and administrative instructions. Add subject, course ID, offering number, or course topic to aid in searching on the activity registry or activity manager.
Message	Enter text here to populate the Message ID prompt in content notes or administrative instructions (based on message usage) in the activity registry.

Defining Academic Periods

Access the Academic Period Table page (**Set Up SACR > Foundation Tables > Term Setup > Academic Periods**).

This example illustrates the fields and controls on the Academic Period table page. You can find definitions for the fields and controls later on this page.

Academic Period Table

Academic Institution: PSUNV
Academic Period ID: 2014 FALL EP

Period Details

***Description:**
***Period Type:**
Last Sequence Nbr:

Period Dates

***Start Date:**
Start Time:
***End Date:**
End Time:
Max EOC Program Date:

Related Periods Personalize | Find | First ◀ 1 of 1 ▶ Last

	Related Period ID	Description		
1	<input type="text" value=""/>		+	-

Academic Period Attributes Find | View All First ◀ 1 of 2 ▶ Last

***Career:** Undergraduate + -
Acad Year:
Term: 2014 Fall
Session:
Acad Org:

Academic periods are institutionally defined time periods that can be created to support exams in Activity Management. The **Period Type** of *Exam Period* is delivered for this purpose. Exam periods will be associated with exams in the Activity Generator, Activity Manager, and the Section Manager. The Program Enrollment feature also utilizes Academic Periods but with a different **Period Type**.

Field or Control	Description
Period Type	<p>Select <i>Exam Period</i> for Activity Management. Additional period types are delivered with Program Enrollment.</p> <p>This field indicates the type of academic period. When the Period Type is <i>Exam Period</i>, the Academic Period Attributes section becomes available.</p>

Field or Control	Description
Last Section Number	This field indicates the most recent section number associated with an exam section in the Section Manager.
Start Date	The beginning date of the academic period being defined.
Start Time	The beginning time of the academic period being defined.
End Date	The final date of the academic period being defined.
End Time	The final time of the academic period being defined.
Max EOC Program Date (maximum exam only course program date)	The maximum date that an Exam Only Course (EOC) can be created. If this field is left as null then start date is used as the maximum EOC program date.
Related Period ID	For future use.
Career	Enter the career(s) for which this academic period is applicable. When associating an exam period with a course exam, the career entered here must match the career associated with the course.
Academic Year	For future use. This attribute is used at a later date to associate an academic period with an academic year.
Term	Enter a term to associate it with the academic period. This association is used as follows: <ul style="list-style-type: none"> • It controls which academic periods are available to students who are enrolled in a particular term. • It is <i>required</i> for schools utilizing both the Exam Only Course and the Program Enrollment features by informing the system into which academic period a student should be enrolled when the enrollment is processed by the IAM Batch Generator.
Session	Enter a session to associate it with the academic period. This association is used as follows: it controls which academic periods are available to students who are enrolled in a particular term/session combination.
Acad Org	For future use. This attribute is used at a later date to restrict processing.

Field or Control	Description
Academic Period Attributes Section	<p>This section appears when the Period Type is <i>Exam Period</i> and allows users to define values for delivered common attributes. The record context used for the Academic Period Table is the Period Table Attributes (SSR_PERIOD_TBL) record. The entity names used for the Activity Registry are prefixed by 'SSR'.</p> <p>The delivered attributes are <i>Exam Period Type, Enrollment Start Date, Enrollment End Date, Fully Graded Date, Late Enrollment Date, and Service Indicator</i>. Of these, <i>Exam Period Type, Enrollment Start Date</i> and <i>Enrollment End Date</i> are required.</p> <p>See “Understanding Common Attribute Framework” (Campus Community Fundamentals)</p> <p>See “Defining a Common Attribute” (Campus Community Fundamentals)</p>
Exam Period Type	<p>Select <i>Regular</i> or <i>Resit</i>.</p> <p>When the period type is exam period, indicate if the period is designed to be a regular exam period or an exam period designated for resits only. The period type is analyzed during the reassessment evaluation process (see Resit Period Limit Assignment).</p>
Enrollment Start Date	Use this field to indicate the first date that students are able to select an exam activity during this academic period.
Enrollment End Date	Use this field to indicate the last date that students are able to select an exam activity during this academic period.
Fully Graded Date	Use this field to identify the date for an exam period where activities would be considered completely graded.
Late Enrollment Date	Use this field to indicate the first date that begins the late enrollment period to select an exam activity during this academic period.
Service Impact	Use this field to enter the service impact that would prohibit a student from selecting an exam activity in this academic period.

Defining Extenuating Circumstances

Access Activity Extenuating Circumstances page (**Curriculum Management > Activity Management > Setup > Extenuating Circumstances**).

This example illustrates the fields and controls on the Activity Extenuating Circumstances page. You can find definitions for the fields and controls later on this page.

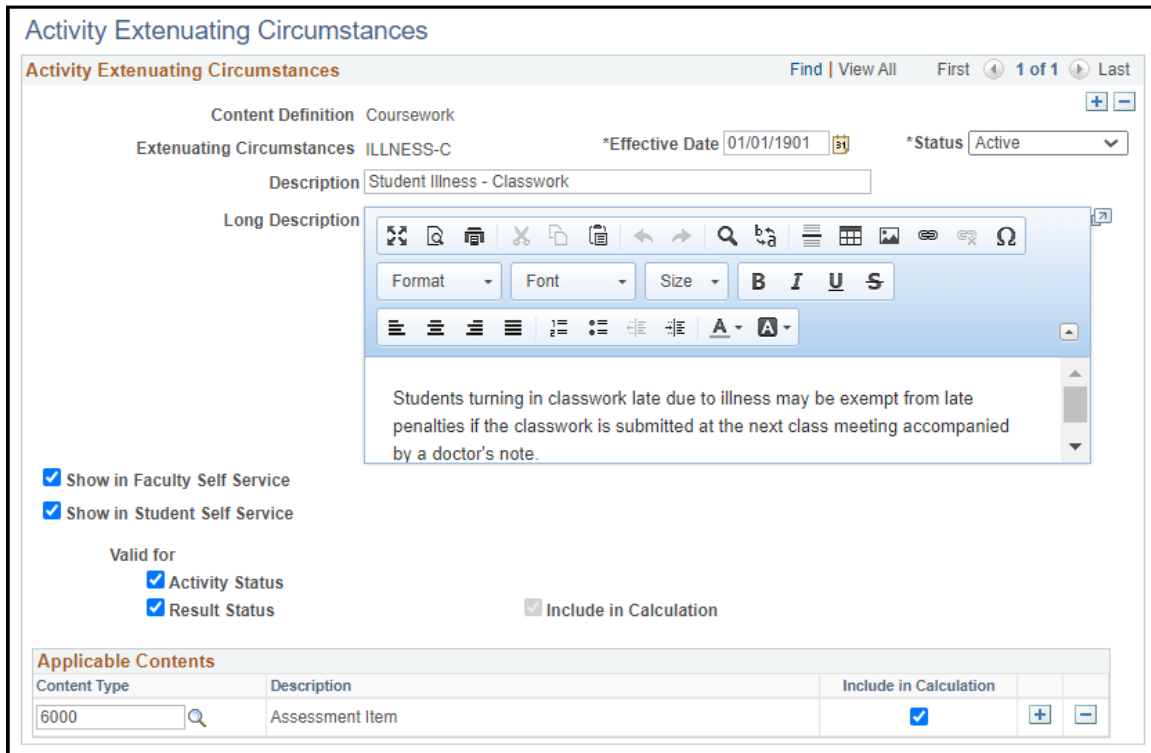

This component allows administrative users to define *reason codes* specific to an activity, a result, or both. The Extenuating Circumstance is stored and can be used to drive further processing. For instance, if a student is sick on the day of the exam, users can record this against the exam activity. With future processing the system will know to defer the student’s attempt to a later exam period (Rules Engine would be incorporated into this processing).

Field or Control	Description
Content Definition	Displays the Activity Definition for which the Extenuating Circumstance is applicable. Currently for Activity Management the only value is <i>Coursework</i> .
Extenuating Circumstances	Displays the user-defined code that identifies the Extenuating Circumstance.
Long Description	Enter a Long Description that explains the Extenuating Circumstance.
Show in Faculty Self Service	Select this check box to display the Extenuating Circumstances prompt in faculty self service.
Show in Student Self Service	Select this check box to display the Extenuating Circumstance to students in student self service.

Field or Control	Description
Valid for Activity Status	Select this check box if the Extenuating Circumstance is applicable to student's activity status. For example, if the student missed an assignment due to illness this Extenuating Circumstance can be recorded against the student's assignment activity on the IAM component.
Valid for Result Status	Select this check box if the Extenuating Circumstance is applicable to student's result status. For example, if a student sat for an exam but was ill, this Extenuating Circumstance can be recorded against the exam result to explain a poor result. This would be recorded on the Result Roster component or the IAM Result for an individual student.
Include in Calculation (for the Extenuating Circumstance)	Select this check box to activate the Include in Calculation check boxes for all of the Content Types added under Applicable Contents .
Applicable Contents	Indicates to which Content Types the Extenuating Circumstance is applicable. When the Include in Calculation check box at the Extenuating Circumstance level is selected, the Content Types Include in Calculation check boxes are selected and disabled. To select which Content Types should be included in the calculation, deselect the Include in Calculation check box at the Extenuating Circumstance level and select the Include in Calculation check boxes for the desired Content Types .

Defining Inclusion Types

Access the Inclusion Types page (**Curriculum Management > Activity Management > Setup > Inclusion Types**).

This example illustrates the fields and controls on the Inclusion Types page. You can find definitions for the fields and controls later on this page.

Inclusion Types							
Sort Sequence	Inclusion Type	*Status	Description	Created By	Created	Updated By	Last Update Date/Time
1	05-GEN	Active	General	PS	26/06/2013 2:14:20PM	PS	26/06/2013 2:32:27PM
2	10-INS	Active	Insufficient Mark Options	PS	26/06/2013 2:14:20PM	PS	26/06/2013 2:18:46PM
3	15-LTE	Active	Late Penalty Options	PS	26/06/2013 2:14:20PM	PS	26/06/2013 2:18:46PM
4	20-RST	Active	Resit Options	PS	26/06/2013 2:14:20PM	PS	26/06/2013 2:23:28PM
5	25-DTS	Active	Dates and Durations	PS	26/06/2013 2:14:20PM	PS	26/06/2013 2:18:46PM
6	30-CAP	Active	Capping Options	PS	26/06/2013 2:14:20PM	PS	26/06/2013 2:29:44PM
7	35-SCH	Active	Scheduling Options	PS	26/06/2013 2:14:20PM	PS	26/06/2013 2:18:46PM
8	40-STF	Active	Staffing Requirements	PS	26/06/2013 2:14:20PM	PS	26/06/2013 2:18:46PM
9	45-DEV	Active	Devices	PS	26/06/2013 2:14:20PM	PS	26/06/2013 2:18:46PM
10	50-IDS	Active	Forms of Identification	PS	26/06/2013 2:14:20PM	PS	26/06/2013 2:18:46PM
11	55-ATT	Active	Attendance Tracking Options	PS	26/06/2013 2:14:20PM	PS	26/07/2013 9:10:12AM

This page lists the delivered inclusion records available for use in the Activity Management feature. The statuses are delivered with an *Active* status. Deactivate any inclusion types that your institution will not use in creating activity management coursework structures.

See [Reviewing Content Inclusions](#)

Related Links

[Setting Up Anonymous Grading](#)

Reviewing Date Sources

Access the Date Sources page (**Curriculum Management > Activity Management > Setup > Date Sources**).

This example illustrates the fields and controls on the Date Sources page. You can find definitions for the fields and controls later on this page.

Date Source ID	Description	Source Record	Date or Date/Time Field	Date Field CAF Attribute	Time Field	System Data	Validate Source
AcadCaFullGrdDt	Acad Calendar Fully Grade Date	ACAD_CALTRM_TBL	FULLY_GRADED_DT			<input checked="" type="checkbox"/>	Validate Source
AcadPerEndDttm	Acad Period End Date & Time	SSR_PERIOD_TBL	SSR_PRD_END_DT		SSR_PRD_END_TIME	<input checked="" type="checkbox"/>	Validate Source
AcadPerEnrEndDt	Acad Period Enr End Date	SSR_PERIOD_CAF	SCC_CAF_ATTR_DVAL	SCC_ENRLEND_DT		<input checked="" type="checkbox"/>	Validate Source
AcadPerEnrStartDt	Acad Period Enr Start Date	SSR_PERIOD_CAF	SCC_CAF_ATTR_DVAL	SCC_ENRL_DT		<input checked="" type="checkbox"/>	Validate Source
AcadPerFullGrdDt	Acad Period Fully Graded Date	SSR_PERIOD_CAF	SCC_CAF_ATTR_DVAL	SSR_FULLY_GRD_DT		<input checked="" type="checkbox"/>	Validate Source
AcadPerLateEnrDt	Acad Period Late Enr Date	SSR_PER_ENRLEXT	SSR_PRD_LTENRL_DT			<input checked="" type="checkbox"/>	Validate Source
AcadPerOpenEnrDt	Acad Period Open Enr Date	SSR_PERIOD_CAF	SCC_CAF_ATTR_DVAL	SCC_ENRL_DT		<input checked="" type="checkbox"/>	Validate Source
AcadPerStartDttm	Acad Period Start Date & Time	SSR_PERIOD_TBL	SSR_PRD_START_DT		SSR_PRD_START_TIME	<input checked="" type="checkbox"/>	Validate Source
AdHocDateTime	Ad Hoc Date & Time					<input checked="" type="checkbox"/>	Validate Source
AssmDueDt	Assessment Due Date	SSR_ACMDATE_INC	SSR_ACM_DUE_DT			<input checked="" type="checkbox"/>	Validate Source
AssmStartDt	Assessment Start Date	SSR_ACMDATE_INC	SSR_ACM_START_DT			<input checked="" type="checkbox"/>	Validate Source
SessBeginDt	Session Begin Date	SESSION_TBL	SESS_BEGIN_DT			<input checked="" type="checkbox"/>	Validate Source
SessEndDt	Session End Date	SESSION_TBL	SESS_END_DT			<input checked="" type="checkbox"/>	Validate Source
SessFirstEnrDt	Session First Enr Date	SESSION_TBL	FIRST_ENRL_DT			<input checked="" type="checkbox"/>	Validate Source
SessLastEnrDt	Session Last Enr Date	SESSION_TBL	LAST_ENRL_DT			<input checked="" type="checkbox"/>	Validate Source
SessOpenEnrDt	Session Open Enroll Date	SESSION_TBL	ENROLL_OPEN_DT			<input checked="" type="checkbox"/>	Validate Source
TermBeginDt	Term Begin Date	TERM_TBL	TERM_BEGIN_DT			<input checked="" type="checkbox"/>	Validate Source
TermEndDt	Term End Date	TERM_TBL	TERM_END_DT			<input checked="" type="checkbox"/>	Validate Source

This component defines which dates in the system can be used as landmarks to control when students are allowed to select optional activities and review results in self service. Users also select from these dates when the result roster becomes available to instructional staff in the Activity Management WorkCenter and which actions can be performed. Eighteen date sources are delivered as system data and can be used when setting date controls for actions (students) and results (students and instructional staff). In most cases, no action is required on this page.

An Ad Hoc date source is provided that allows users to enter a specific date and time for activity actions and results. Keep in mind that unlike the other delivered date sources, an ad hoc date would need to be updated on a regular basis.

Users can also add new date sources if needed, but depending on the record keys this could require modifications to the SSR_ACTIVITY:UTIL app package.

Field or Control	Description
Content Definition	The delivered content definition value for Activity Management is <i>Coursework</i> .
Date Type	This indicates if the dates listed are for actions or results. Two date types are delivered: <i>Action Control</i> and <i>Result Control</i> . Action controls are specific to students being able to select optional activities in self service. Result controls are used to display results to students and to open the result roster to instructional staff for grading purposes.
System Data	An indicator showing that system data exists on this page.
Date Source ID	A unique identifier that stores the details of the date and time for each date source.
Date Field CAF Attribute	The Common Attribute Framework date field referenced.
System Data	Indicates whether the data is delivered as system data.
Validate Sources	Select to review any restrictions for the specific Date Source on the Date Source Validation secondary page.

Defining Date Settings

Access the Date Settings page (**Curriculum Management > Activity Management > Setup > Date Settings**).

This example illustrates the fields and controls on the Date Settings page. You can find definitions for the fields and controls later on this page.

Date Settings

Content Definition Coursework

Date Type Action Control

Find | View All First 1 of 1 Last

*Effective Date *Status Active

*Description Action Date Setup

Find | View All First 6 of 7 Last

Content Type and Date Mapping

Content Type Assessment Item

Personalize | Find | 📅 | 🗒️ First 1-3 of 3 Last

*Date Source ID	Description	Use for Start Date/Time	Use for End Date/Time		
<input type="text" value="AssmDueDt"/> <input type="button" value="🔍"/>	Assessment Due Date	<input type="checkbox"/>	<input checked="" type="checkbox"/>	<input type="button" value="+"/>	<input type="button" value="-"/>
<input type="text" value="AssmStartDt"/> <input type="button" value="🔍"/>	Assessment Start Date	<input checked="" type="checkbox"/>	<input checked="" type="checkbox"/>	<input type="button" value="+"/>	<input type="button" value="-"/>
<input type="text" value="SessBeginDt"/> <input type="button" value="🔍"/>	Session Begin Date	<input checked="" type="checkbox"/>	<input type="checkbox"/>	<input type="button" value="+"/>	<input type="button" value="-"/>

This page is used to define the date sources to be used for each content type of the activity management structure. Date sources are specified as either *Action Control* or *Result Control*. Only establish date settings for action control if your school utilizes optional activities. If activities are always defined as mandatory, it is not necessary to define a date setting structure for the action control date type.

Regardless of the date type selected, you will define for each available content type all the applicable start and end date sources to be used. In the above example, one start date and two end dates are identified for the action control for the course content type. When creating *Action Date IDs* on the Action Date page, the *Session Start Date* is available for selection as the start date and the *Assessment Start Date* and *Assessment Due Date* are available for selection as the end date.

Note: For the date type *Action Control*, the content type *Component* is not available for selection. Component selection is based on enrollment and is not available in the activity management structure as an optional activity. However, *Course* is listed to support Exam Only Course selection, although that feature is not yet functional.

Field or Control	Description
Content Definition	The delivered content definition value for Activity Management is <i>Coursework</i> .

Field or Control	Description
Date Type	This indicates if the dates listed are for activity actions or activity results. Two date types are delivered: <i>Action Control</i> and <i>Result Control</i> . Action controls are specific to students being able to select optional activities in self service. Result controls are used to display results to students and to open the result roster to instructional staff for grading purposes.
Content Type	Enter a row for each content type for which you enter an action date or an result date.
Date Source ID	Enter the date source ID you use as either a start or end date for the given content type.
Use for Start Date/Time	Select to indicate if the date source is used as a start date source.
Use for End Date/Time	Select to indicate if the date source is used as an end date source.

Defining Action Dates

Access the Action Dates page (**Curriculum Management > Activity Management > Setup > Action Dates**).

This example illustrates the fields and controls on the Action Dates page. You can find definitions for the fields and controls later on this page.

This component controls when students can perform certain actions for optional content types in self service.

Field or Control	Description
Content Definition	The delivered content definition value for Activity Management is <i>Coursework</i> .
Activity Action ID	Add a unique identifier when adding a new Action Date ID .
Valid Institution Days	Indicate the valid days of the week to count when using the Adjust Start Date and Adjust End Date fields below.
Holiday Schedule	Indicate which holiday schedule to use when using the Adjust Start Date and Adjust End Date fields below.
Institution	Enter the academic institution to which the Action Date ID applies. A blank value applies to all academic institutions.
Career	Enter the academic career to which the Action Date ID applies. A blank value applies to all academic careers of the institution.
Program	Enter the academic program to which the Action Date ID applies. A blank value applies to all academic programs of the career.
Exam Only Option	(for future use) Three options are available: <i>Include</i> to have the Action Date ID apply to Exam Only Courses, as well as regular courses; <i>Exclude</i> to not have the Action Date ID apply to exam only courses, or <i>Exam Only</i> to have the Action Date ID only apply to exam only courses. If different action dates exist for exam only and non-exam only courses, create different Action Date IDs .
Content Type	Enter a row for each content type for which the Action Date ID applies. You are not able to enter <i>Component</i> as this is not an optional content type.
Action Type	Select all applicable action types for the content type. <i>Select</i> and <i>Remove</i> are applicable actions for all content types. The exam section also has actions of <i>Confirm</i> and <i>Unconfirm</i> . The exam also includes <i>Resit Selection</i> and <i>Resit Remove</i> options.
Start Date Source	Select the appropriate date source. You only see those sources defined for the specific content type that were defined on the Date Setting component as an action control start date source.
Adjust Start Date	Enter the number of days before or after the source date for which the action should be allowed. For instance, if selections can be performed starting three days after the session start date, enter 3.

Field or Control	Description
Use Time from Start Source	Select to automatically use the start time associated with this source date. This field is only visible when the date source is <i>AcadPerStartDttm</i> or <i>AcadPerEndDttm</i> . Set up the academic period start time on the Academic Period Table.
Start Time	Enter a specific time the action should be allowed to start. A blank value default schedules the action to begin at <i>12:00AM</i> .
End Date Source	Select the appropriate date source. You only see those sources defined for the specific content type that were defined on the Date Setting component as an action control end date source.
Adjust End Date	Enter the number of days before or after the source date for which the action should be ended. For instance, if selections should end one day prior to the assessment start date, enter <i>-1</i> .
Use Time from End Source	Select to automatically use the end time associated with this source date. This field is only visible when the date source is <i>AcadPerStartDttm</i> or <i>AcadPerEndDttm</i> . Set up the academic period end time on the Academic Period Table.
End Time	Enter a specific time the action should end. A blank value ends the action at <i>11:59PM</i> by default.

Defining Result Dates

Access the Result Dates page (**Curriculum Management > Activity Management > Setup > Result Dates**).

This example illustrates the fields and controls on the Result Dates page — Student View. You can find definitions for the fields and controls later on this page.

Result Dates

Content Definition: Coursework
 Release Type: Student Self Service View
 Result Date ID: PSUNV UGRD STDNT

*Effective Date: 01/01/2001 *Status: Active

*Description: PSUNV UGRD Student Results

Valid Institution Days: Mon Tues Wed Thurs Fri Sat Sun

Holiday Schedule: FSS Academic Holiday Schedule

Seq Nbr	Institution	Description	Career	Acad Prog	Result Status	Include Lower Result Status	Exam Only Option
1	PSUNV	PeopleSoft University			50-Final	<input checked="" type="checkbox"/>	Exclude

Content Type Date Control

*Result Access	Display Result Status	Display Result History	Start Date Source	Description	Adjust Start Date	Start Time	End Date Source	Description	Adjust End Date	End Time
Display	<input type="checkbox"/>	<input type="checkbox"/>	AcadCalFullGrdDt	Acad Calendar Fully Grade Date		8:00AM	TermEndDt		<input type="checkbox"/>	365 11:59PM

This example illustrates the fields and controls on the Result Dates page — Faculty View. You can find definitions for the fields and controls later on this page.

This component controls release of results to students and roster access for instructional staff. Student result dates should be created using the **Release Type Student Self Service View**, while staff result dates should use the **Release Type Faculty Self Service Update**.

Field or Control	Description
Content Definition	The delivered content definition value for Activity Management is <i>Coursework</i> .
Release Type	Two release types are delivered: <i>Student Self Service Update</i> which is designed to only display results, and <i>Faculty Self Service Update</i> which is designed with calculate, grade and display options.
Result Date ID	This is a unique identifier you create when adding a new Result Date ID. Note: For Exam-Only Courses (EOC), make sure you use a different Result Date ID from the regular courses, and use the academic period as the date source.
Valid Days	Indicate the valid days of the week to count when using the Adjust Start Date and Adjust End Date fields below.
Holiday Schedule	Indicate which holiday schedule to use when using the Adjust Start Date and Adjust End Date fields below.

The following fields are valid for the Student Self Service View:

Field or Control	Description
Institution	Enter the academic institution to which the Result Date ID applies. A blank value applies to all academic institutions.
Career	Enter the academic career to which the Result Date ID applies. A blank value applies to all academic careers of the institution.
Program	Enter the academic program to which the Result Date ID applies. A blank value applies to all academic programs of the career.
Result Status	Enter the result status to display for the Result Date ID. A blank value will display all applicable result statuses.
Include Lower Result Status	Select to display the indicated result status and all other result statuses with a lower number. For example, if you select Result Status <i>10-Calculated</i> and then select this check box, the <i>07-Imported</i> , <i>05-Manual</i> , and <i>00-Undetermined</i> statuses are also displayed.
Exam Only Option	<p>Three options are available: <i>Include</i> to have the Result Date ID apply to Exam Only Courses, as well as regular courses; <i>Exclude</i> to not have the Result Date ID apply to Exam Only Courses, or <i>Exam Only</i> to have the Result Date ID only apply to Exam Only Courses. If different result dates exist for exam only and non-exam only courses, create different Result Date IDs.</p> <hr/> <p>Note: For Exam-Only Courses (EOC), make sure you use a different Result Date ID from the regular courses, and use the academic period as the date source.</p>

The following fields are valid for the Faculty Self Service Update:

Field or Control	Description
Institution	Enter the academic institution to which the Result Date ID applies. A blank value applies to all academic institutions.
Organization	Enter the academic organization to which the Result Date ID applies. A blank value applies to all academic organizations of the institution.
Instructor Type	Enter the instructor type to which the Result Date ID applies. The instructor type is associated to instructors on the Meetings tab of the Class Schedule. A blank value applies to all instructor types associated to the class.

Field or Control	Description
Staff Type	Enter the staff type to which the Result Date ID applies. The staff type is associated with exam staff in the Section Manager. A blank value applies to all staff types associated to the exam section.
Exam Only Option	Three options are available: <i>Include</i> to have the Result Date ID apply to exam only courses, as well as regular courses; <i>Exclude</i> to not have the Result Date ID apply to exam only courses, or <i>Exam Only</i> to have the Result Date ID only apply to exam only courses. If different result dates exist for exam only and non-exam only courses, create different Result Date IDs.
Content Type	Enter a row for each content type for which the Result Date ID applies. The following additional system settings must also be in place for results to display: the specified Result Type must be selected to <i>Show in Student Self-Service</i> (Result Type Table) and the activity must be identified as <i>Accessible</i> (Activity Manager).

Field or Control	Description
Result Access	<p>This value defaults to <i>Display</i> when the release type is Student Self Service View.</p> <p>When using the Faculty Self Service Update release type the values are:</p> <ul style="list-style-type: none"> • <i>Calculate</i> – allows instructional staff to calculate results to parent activities for those activities which were manually entered (grade). This setting controls the calculate function found on the Activity Management WorkCenter Manage Rosters page. The Allow Calculation (WorkCenter) field on the Institution Table, Institution Table 9 page must also be selected for calculations to be enabled in the Activity Management WorkCenter. • <i>Grade</i> – allows instructional staff to manually enter results onto the result roster found on the Activity Management WorkCenter. • <i>Display</i> - allows instructional staff to view (no edit) their result rosters prior to the calculate and grading result access start dates or after the calculate and grading result access dates have expired. This also controls when the result roster icon is visible in the Activity Management WorkCenter, Manage Rosters page. Students must also be associated to the activity for the icon to display <p>When you set up instructional staff to be able to <i>only</i>:</p> <ul style="list-style-type: none"> • calculate, they are also able to grade <i>and</i> view result rosters. • grade, they are able to grade and view result rosters, but <i>not</i> calculate. • view results, they will not be able to calculate nor grade.
Start Date Source	Select the appropriate date source. You only see those sources defined for the specific content type that were defined on the Date Setting component as a result control start date source.
Adjust Start Date	Enter the number of days before or after the source date for which the result action should be allowed. For instance, if results can be viewed starting two days after the assessment item due date, enter 2.
Use Time from Start Source	Select to automatically use the start time associated with this source date. This field is only visible when the date source is <i>AcadPerStartDtm</i> or <i>AcadPerEndDtm</i> . Set up the academic period start time on the Academic Period Table.
Start Time	Enter a specific time the action should be allowed to start. A blank value default schedules the action to begin at <i>12:00AM</i> .

Field or Control	Description
End Date Source	Select the appropriate date source. You only see those sources defined for the specific content type that were defined on the Date Setting component as a result control end date source.
Adjust End Date	Enter the number of days before or after the source date for which the action should be ended. For instance, if results can be viewed forever, enter <i>999</i> .
Use Time from End Source	Select to automatically use the end time associated with this source date. This field is only visible when the date source is <i>AcadPerStartDttm</i> or <i>AcadPerEndDttm</i> . The setup of the academic period end time is done on the Academic Period Table.
End Time	Enter a specific time the action should end. A blank value by default ends the action at <i>11:59PM</i> .

Setting Up an Activity Definition

This section provides an overview of activity definition setup and discusses how to:

- Define activity definitions.
- Review content inclusions.

Understanding Activity Definition Setup

The content definition Coursework is the delivered activity definition to support the Marks and Exam initiative. This definition establishes the content types and the attributes that are applicable to a coursework structure specific to a course. The coursework structure is built in the Activity Registry and references this Coursework content definition. The Activity and Section Managers, Activity Management WorkCenter, and IAM also reference this definition. Limited adjustments can be made within this definition to meet the particular needs of an institution.

Pages Used to Set Up an Activity Definition

Page Name	Definition Name	Navigation	Usage
Activity Definition	SSR_AC_ITEMTYPE	Curriculum Management > Activity Management > Setup > Activity Definition	Define all aspects of activities used by your institution.

Page Name	Definition Name	Navigation	Usage
Inclusion Options	SSR_AC_INCLUSIONS	Click the Content Inclusions link on the Activity Definition General Settings tab.	Select the inclusions associated with each coursework definition content type.

Defining Activity Definitions

Access the Activity Definition page (**Curriculum Management > Activity Management > Setup > Activity Definition**).

This example illustrates the fields and controls on the Activity Definition page: General Settings tab. You can find definitions for the fields and controls later on this page.

Activity Definition

Content Definition: Coursework Sync Entities

Content Control Record: SSR_AC_CRSE_EXT Process Monitor

Content Types Personalize | Find | First 1-8 of 8 Last

Content Type	Description	Short Description	Item Order	Content Active	System Data	Content Root	Child Content	Restricted	Self-Reference Allowed	Content Inclusions	Content Inclusions	Parent Types	Child Types
1000	Course	Course Root	100	<input checked="" type="checkbox"/>	<input checked="" type="checkbox"/>	<input checked="" type="checkbox"/>	<input checked="" type="checkbox"/>	<input type="checkbox"/>	<input type="checkbox"/>	Content Inclusions	Content Inclusions		<input type="checkbox"/>
2000	Component	Component	200	<input checked="" type="checkbox"/>	<input checked="" type="checkbox"/>	<input type="checkbox"/>	<input checked="" type="checkbox"/>	<input type="checkbox"/>	<input type="checkbox"/>	Content Inclusions	Content Inclusions		<input type="checkbox"/>
3000	Category	Category	300	<input checked="" type="checkbox"/>	<input checked="" type="checkbox"/>	<input type="checkbox"/>	<input checked="" type="checkbox"/>	<input type="checkbox"/>	<input type="checkbox"/>	Content Inclusions	Content Inclusions		<input type="checkbox"/>
4000	Exam	Exam	400	<input checked="" type="checkbox"/>	<input checked="" type="checkbox"/>	<input type="checkbox"/>	<input checked="" type="checkbox"/>	<input type="checkbox"/>	<input checked="" type="checkbox"/>	Content Inclusions	Content Inclusions		<input type="checkbox"/>
4500	Exam Section	Section	450	<input checked="" type="checkbox"/>	<input checked="" type="checkbox"/>	<input type="checkbox"/>	<input type="checkbox"/>	<input checked="" type="checkbox"/>	<input type="checkbox"/>	Content Inclusions	Content Inclusions		<input type="checkbox"/>
5000	Attendance	Attendance	500	<input checked="" type="checkbox"/>	<input checked="" type="checkbox"/>	<input type="checkbox"/>	<input type="checkbox"/>	<input type="checkbox"/>	<input checked="" type="checkbox"/>	Content Inclusions	Content Inclusions		<input type="checkbox"/>
6000	Assessment Item	Assignment	600	<input checked="" type="checkbox"/>	<input checked="" type="checkbox"/>	<input type="checkbox"/>	<input checked="" type="checkbox"/>	<input type="checkbox"/>	<input checked="" type="checkbox"/>	Content Inclusions	Content Inclusions		<input type="checkbox"/>
9000	Condition	Condition	900	<input checked="" type="checkbox"/>	<input checked="" type="checkbox"/>					Content Inclusions	Content Inclusions	Parent Types	Child Types

This example illustrates the fields and controls on the Activity Definition page: Registry Settings tab. You can find definitions for the fields and controls later on this page.

Activity Definition

Content Definition: Coursework Sync Entities

Content Control Record: SSR_AC_CRSE_EXT Process Monitor

Content Types Personalize | Find | First 1-8 of 8 Last

Content Type	Description	Valid	Extension Record	Entity ID	Entity Name
1000	Course	<input checked="" type="checkbox"/>		SCC_ENTITY_ID_20120430111959	ACR Course
2000	Component	<input checked="" type="checkbox"/>	SSR_AC_COMP_EXT	SCC_ENTITY_ID_20120430111958	ACR Component
3000	Category	<input checked="" type="checkbox"/>	SSR_AC_CAT_EXT	SCC_ENTITY_ID_20120430111721	ACR Category
4000	Exam	<input checked="" type="checkbox"/>	SSR_AC_EXAM_EXT	SCC_ENTITY_ID_20120430111720	ACR Exam
4500	Exam Section	<input type="checkbox"/>			
5000	Attendance	<input checked="" type="checkbox"/>		SCC_ENTITY_ID_20120430111719	ACR Attendance
6000	Assessment Item	<input checked="" type="checkbox"/>	SSR_AC_ASGN_EXT	SCC_ENTITY_ID_20120430111717	ACR Assessment Item
9000	Condition	<input checked="" type="checkbox"/>	SSR_AC_REQ_EXT	SCC_ENTITY_20120912160618	ACR Condition

This example illustrates the fields and controls on the Activity Definition page: Activity Manager Settings tab. You can find definitions for the fields and controls later on this page.

Activity Definition

Content Definition: Coursework Sync Entities

Content Control Record: SSR_AC_CRSE_EXT Process Monitor

Content Types Personalize | Find | [Grid Icon] | First 1-8 of 8 | Last

General Settings | Registry Settings | **Activity Manager Settings** | Activity Manager WorkCenter Settings | Individual Activity Manager | Self-Service Message Controls

Content Type	Description	Valid	Extension Record	Allow Structural Updates	Entity ID	Entity Name		
1000	Course	<input checked="" type="checkbox"/>	SSR_ACT_ROOTEXT	<input checked="" type="checkbox"/>	SCC_ENTITY_20120816145433	ACM Course	<input type="checkbox"/>	<input type="checkbox"/>
2000	Component	<input checked="" type="checkbox"/>	SSR_ACMCOMP_EXT	<input checked="" type="checkbox"/>	SCC_ENTITY_20120816145450	ACM Component	<input type="checkbox"/>	<input type="checkbox"/>
3000	Category	<input checked="" type="checkbox"/>	SSR_ACMCAT_EXT	<input checked="" type="checkbox"/>	SCC_ENTITY_20120816145508	ACM Category	<input type="checkbox"/>	<input type="checkbox"/>
4000	Exam	<input checked="" type="checkbox"/>	SSR_ACMEXAM_EXT	<input checked="" type="checkbox"/>	SCC_ENTITY_20120816145526	ACM Exam	<input type="checkbox"/>	<input type="checkbox"/>
4500	Exam Section	<input checked="" type="checkbox"/>	SSR_ACM_SCTNEXT	<input checked="" type="checkbox"/>	SCC_ENTITY_20120816145536	ACM Exam Section	<input type="checkbox"/>	<input type="checkbox"/>
5000	Attendance	<input checked="" type="checkbox"/>		<input checked="" type="checkbox"/>	SCC_ENTITY_20120816145555	ACM Attendance	<input type="checkbox"/>	<input type="checkbox"/>
6000	Assessment Item	<input checked="" type="checkbox"/>	SSR_ACMASGN_EXT	<input checked="" type="checkbox"/>	SCC_ENTITY_20120816145613	ACM Assessment Item	<input type="checkbox"/>	<input type="checkbox"/>
9000	Condition	<input checked="" type="checkbox"/>	SSR_ACMREQ_EXT	<input checked="" type="checkbox"/>	SCC_ENTITY_20120912163807	ACM Condition	<input type="checkbox"/>	<input type="checkbox"/>

This example illustrates the fields and controls on the Activity Definition page: Activity Manager WorkCenter Settings tab. You can find definitions for the fields and controls later on this page.

Activity Definition

Content Definition: Coursework Sync Entities

Content Control Record: SSR_AC_CRSE_EXT Process Monitor

Content Types Personalize | Find | [Grid Icon] | First 1-8 of 8 | Last

General Settings | Registry Settings | Activity Manager Settings | **Activity Manager WorkCenter Settings** | D | [Grid Icon]

Content Type	Description	Allow Structural Updates	Updatable Inclusions	Updatable Inclusions		
1000	Course	<input type="checkbox"/>	Updatable Inclusions	Updatable Inclusions	<input type="checkbox"/>	<input type="checkbox"/>
2000	Component	<input type="checkbox"/>	Updatable Inclusions	Updatable Inclusions	<input type="checkbox"/>	<input type="checkbox"/>
3000	Category	<input checked="" type="checkbox"/>	Updatable Inclusions	Updatable Inclusions	<input type="checkbox"/>	<input type="checkbox"/>
4000	Exam	<input type="checkbox"/>	Updatable Inclusions	Updatable Inclusions	<input type="checkbox"/>	<input type="checkbox"/>
4500	Exam Section	<input checked="" type="checkbox"/>	Updatable Inclusions	Updatable Inclusions	<input type="checkbox"/>	<input type="checkbox"/>
5000	Attendance	<input checked="" type="checkbox"/>	Updatable Inclusions	Updatable Inclusions	<input type="checkbox"/>	<input type="checkbox"/>
6000	Assessment Item	<input checked="" type="checkbox"/>	Updatable Inclusions	Updatable Inclusions	<input type="checkbox"/>	<input type="checkbox"/>
9000	Condition	<input checked="" type="checkbox"/>	Updatable Inclusions	Updatable Inclusions	<input type="checkbox"/>	<input type="checkbox"/>

This example illustrates the fields and controls on the Activity Definition page: Individual Activity Manager tab. You can find definitions for the fields and controls later on this page.

Activity Definition

Content Definition: Coursework Sync Entities

Content Control Record: SSR_AC_CRSE_EXT Process Monitor

Content Types Personalize | Find | [Grid Icon] | First 1-8 of 8 | Last

Activity Manager Settings | Activity Manager WorkCenter Settings | **Individual Activity Manager** | Self-Service Message Controls

Content Type	Description	Valid	Activity Actions	Extension Record	Entity ID	Entity Name		
1000	Course	<input checked="" type="checkbox"/>	<input type="checkbox"/>	SSR_IAM_ROOTEXT	SCC_ENTITY_20121009133038	IAM Course	<input type="checkbox"/>	<input type="checkbox"/>
2000	Component	<input checked="" type="checkbox"/>	<input type="checkbox"/>		SCC_ENTITY_20121009133017	IAM Component	<input type="checkbox"/>	<input type="checkbox"/>
3000	Category	<input checked="" type="checkbox"/>	<input checked="" type="checkbox"/>		SCC_ENTITY_20121009132955	IAM Category	<input type="checkbox"/>	<input type="checkbox"/>
4000	Exam	<input checked="" type="checkbox"/>	<input checked="" type="checkbox"/>	SSR_IAM_EXAMEXT	SCC_ENTITY_20121009132935	IAM Exam	<input type="checkbox"/>	<input type="checkbox"/>
4500	Exam Section	<input checked="" type="checkbox"/>	<input checked="" type="checkbox"/>		SCC_ENTITY_20121009132914	IAM Exam Section	<input type="checkbox"/>	<input type="checkbox"/>
5000	Attendance	<input checked="" type="checkbox"/>	<input checked="" type="checkbox"/>		SCC_ENTITY_20121009132858	IAM Attendance	<input type="checkbox"/>	<input type="checkbox"/>
6000	Assessment Item	<input checked="" type="checkbox"/>	<input checked="" type="checkbox"/>	SSR_IAM_ASGNEXT	SCC_ENTITY_20121009132838	IAM Assessment Item	<input type="checkbox"/>	<input type="checkbox"/>
9000	Condition	<input checked="" type="checkbox"/>	<input type="checkbox"/>		SCC_ENTITY_20121009132818	IAM Condition	<input type="checkbox"/>	<input type="checkbox"/>

This example illustrates the fields and controls on the Activity Definition page: Self Service Message Controls tab. You can find definitions for the fields and controls later on this page.

Activity Definition				
Content Definition:	Coursework	Sync Entities		
Content Control Record:	SSR_AC_CRSE_EXT	Process Monitor		
Content Types				
Activity Manager Settings		Activity Manager WorkCenter Settings	Individual Activity Manager	Self-Service Message Controls
Content Type	Description	Self-Service Messages Control		
1000	Course	Self-Service Messages Control	+	-
2000	Component	Self-Service Messages Control	+	-
3000	Category	Self-Service Messages Control	+	-
4000	Exam	Self-Service Messages Control	+	-
4500	Exam Section	Self-Service Messages Control	+	-
5000	Attendance	Self-Service Messages Control	+	-
6000	Assessment Item	Self-Service Messages Control	+	-
9000	Condition	Self-Service Messages Control	+	-

<i>Field or Control</i>	<i>Description</i>
Content Control Record	The extension record entered here controls the prompts for the course control record on the activity registry. This value should not be changed for the Coursework content definition.
Sync Entities	<p>This button builds/syncs the entities by running the SSR_AM_ESYNC program on the Process Scheduler. The sync process should only be run in the following circumstances:</p> <ul style="list-style-type: none"> • When adding or removing a Content Type from the structure (not recommended). • When adding, removing or changing an extension record (not recommended). • When selecting or deselecting the Valid content type check box. • When adding or removing a Parent Type or Child Type for a 9000 level content type. • When activating or deactivating an inclusion type. <p>Note: Altering a Content Type or an Extension Record from the structure requires technical intervention and is considered a major customization.</p>

General Settings

The content types of the Coursework definition make up the learning content of a course structure. The structure is built in the Activity Registry and can be edited in the Activity Manager. Adding or deleting a content type is considered a major customization. The eight delivered content types are:

- Course - this serves as the root of the coursework hierarchy and is the only required content type.

- **Component** - this is equivalent to the course component defined in the course catalog.
- **Category** - this can be used to group items for calculation and/or display purposes.
- **Exam** - this is used to define a course level examination.
- **Exam Section** - this is used to schedule an examination.
- **Attendance** - this is used to define an attendance requirement.
- **Assessment Item** - this is used to define all other course requirements.
- **Condition** - this is used to place a condition in the content tree, which would allow a student option to select a certain number of the child items, for example Lab Assignments - Select 2.

Each content type has attributes and marking rules that can be defined using the Inclusion Options and the Extension Record. Inclusion Options can be turned on or off to meet the particular needs of an institution for a given content type.

Note: Institutions should use the delivered content types for the Coursework definition, rather than add new content types into the structure, as added content types are not supported.

The **Content Type** and **Description** fields appear on all tabs of this page.

Field or Control	Description
Content Type	Delivered sequential number identifying the content type. It indicates the standard order for the content tree in the activity registry. A content type can have a parent greater than itself; for example, an exam can have a parent that is a category, a component, or a course. The exception to this is any 9000-level content type that uses the Parent Types and Child Types links to identify how the content item can be placed in the coursework hierarchy.
Description	This field describes the eight delivered content types for the coursework definition. These values appear in the Activity Registry and are used to create the coursework hierarchy. The labels can be changed in this definition to reflect a value that has more specific meaning to an institution. For instance, a school may prefer to change the <i>Assessment Item</i> label to <i>Assignment</i> .
Item Order	Defines the sort order of the content type.
Content Active	Select this check box to indicate that the content type is available for use in the activity registry.

Field or Control	Description
System Data	This noneditable field indicates that there is delivered programming code that sets specific functionality for this content type.
Content Root	This noneditable field indicates which content type is the root of the activity registry content tree. For the coursework definition, the content root is <i>Course</i> .
Child Content	This noneditable field indicates that the content type can have children content items in the coursework hierarchy.
Restricted	This noneditable field indicates that this content item is restricted to its immediate parent content type.
Self-Referenced Allow	This noneditable field indicates that the content type can have child items of the same content type in the content tree; for example, an assessment item can have a child of assessment item.
Content Inclusions	<p>Click to access the Inclusion Options page.</p> <p>Content inclusions are records that contain attributes that can be applied to content types. Content inclusion options are associated with multiple content types. Inclusion options include the following: <i>Insufficient Mark Options, General Options, Attendance Tracking Options, Resit Options, Content Capping Options, Scheduling Options, Staffing Requirements, Content Devices, Forms of Identification, Late Content Penalty Options, Anonymous ID Options, and Dates and Durations.</i></p> <p>Inclusion types must be set to <i>Active</i> on the Inclusion Types setup page to be visible here.</p> <p>See Reviewing Content Inclusions</p>
Parent Types	This link is applicable to 9000-level content types. It indicates which content types can be valid parents to the specific 9000-level content type.
Child Types	This link is applicable to 9000-level content types. It indicates which content types can be valid children to the specific 9000-level content type.

Registry Settings

Field or Control	Description
Valid	This noneditable flag indicates the content type is valid for the Activity Registry. To eliminate a content type from the coursework hierarchy, clear the Content Active check box on the General Settings tab.
Extension Record	Extension records are delivered and specific to a content type. For example, a <i>Category</i> content type requires users to indicate which content category is being defined.
Entity ID	This field is used to associate the entity record used by the record context definition with the content type. See “Associating a Common Attribute to a Record” (Campus Community Fundamentals)
Entity Name	This field identifies the name of the Entity ID.

Activity Manager Settings

Field or Control	Description
Valid	This noneditable flag indicates the content type is valid for the Activity Manager.
Allow Structural Updates	Select this check box to indicate what can be updated on the content tree in the Activity Manager component. This check box is selected by default for all content types. If selected, the system allows users to copy, move, or delete content types from the tree. You can override a selection here to <i>No</i> on the Activity Registry. If cleared, the system does not allow users to copy, move, or delete content types from the tree. Users cannot override this selection on the Activity Registry. However, child content types can be added in the Activity Manager if those child items do have the Allow Structural Updates check box selected.

Field or Control	Description
Entity ID	This field is used to associate the entity record used by the record context definition with the content type. See “Associating a Common Attribute to a Record” (Campus Community Fundamentals)
Entity Name	This field identifies the name of the Entity ID .

Activity Management WorkCenter Settings

Field or Control	Description
Allow Structural Updates	Select this check box to indicate what can be updated on the content tree on the Activity Management WorkCenter component. This check box is selected by default for Category, Attendance, Assessment Item and Condition content types. When selected, the system allows users to copy, move, or delete content types from the tree. You can override a selection here to <i>No</i> on the Activity Registry. If cleared, the system does not allow users to copy, move, or delete content types from the tree. Users cannot override this selection on the Activity Registry. However, child content types can be added in the Activity Management WorkCenter if those child items do have the Allow Structural Updates check box selected.
Updateable Inclusions	Select this link to identify which inclusions can be edited in the Activity Management WorkCenter. The inclusions available for edit are dependent on the content type. Selected inclusions allow users to edit values on the inclusion record. Non-selected inclusions appear to the user as display-only.

Individual Activity Manager Settings

Field or Control	Description
Valid	This noneditable flag indicates the content type is valid for the IAM.

Field or Control	Description
Activity Actions	<p>This field indicates which content types can have actions defined on the Activity Actions Setup page. Activity actions control which action types are available to students in self service and when those actions can be performed. You can apply these settings to all non-component/course activity types designated as selectable or confirmable.</p> <p>Activity actions are planned for future use.</p>
Extension Record	<p>Extension records are delivered and specific to a content type. For example, a Category content type requires users to indicate which content category is being defined.</p>
Entity ID	<p>This field is used to associate the entity record used by the record context definition with the content type.</p> <p>See “Associating a Common Attribute to a Record” (Campus Community Fundamentals)</p>
Entity Name	<p>This field identifies the name of the Entity ID.</p>

Self-Service Message Controls

The links in this tab allow users to indicate, by content type, whether inclusion data messages should appear to self-service users when the source of the data is the Activity Registry, the Activity Manager, or the IAM.

The source of data that a self-service user is able to view depends on whether they are viewing course data (the source is the Activity Registry), class data prior to enrollment (Activity Manager), or enrolled class data (IAM). For instance, if you want to only inform enrolled students about the specific late penalties for assessment items, then select the IAM, but deselect the Activity Registry and Activity Manager. These values can be overridden on the Activity Registry for a specific registry.

Click the **Self-Service Messages Control** link to access the Self-Service Messages Control page, where you can select the messages to appear in self service for each content type, for each listed inclusion based on the source of information. This setup applies to both student and administrative/faculty self service. The Scheduling and Staffing Requirements Options are not visible to students.

See [Reviewing Self-Service Message Controls](#)

On the Self-Service Messages Control page, the source of information in student self service is determined by the role of the individual accessing the information. If the person is enrolled in the class and has an IAM, the IAM is the source. If the person is enrolled but no IAM exists, the source is the Activity Manager. If the person is not enrolled but is drilling into the activities at the class level (where a term exists), the source is the Activity Manager. If the person is not enrolled and is drilling into the information from the course catalog level (where no term exists), the source is the Activity Registry.

Likewise, the source of information for administrative/faculty messages is determined from where access is gained, either course (Activity Registry) or class (Activity Manager). However, if reviewing a specific student, then the message source would be the student's IAM.

The Message Set Number for Activity Management is 14740 with the self-service message numbers ranging from 2000 to 2054. The values defined in the Activity Definition apply by default to the Activity Registry where they can be overridden for a specific course root.

Reviewing Content Inclusions

Access the Content Inclusions page (click the **Content Inclusions** link on the Registry Header page, General Settings tab).

This example illustrates the fields and controls on the Content Inclusions page (for Exam content type). You can find definitions for the fields and controls later on this page.

Content Inclusions (Exam)	
Description	Active
General	<input checked="" type="checkbox"/>
Insufficient Mark Options	<input checked="" type="checkbox"/>
Resit Options	<input checked="" type="checkbox"/>
Capping Options	<input type="checkbox"/>
Scheduling Options	<input checked="" type="checkbox"/>
Staffing Requirements	<input checked="" type="checkbox"/>
Devices	<input checked="" type="checkbox"/>
Forms of Identification	<input checked="" type="checkbox"/>
Attendance Tracking Options	<input type="checkbox"/>

Specific inclusion options have been associated with each coursework definition content type. When an inclusion option is selected, a data entry section appears for that content type on the Activity Registry. For instance, if the *Insufficient Mark Options* check box is selected here for the content type exam, then the data entry section for Insufficient Marks appears in the Activity Registry when an exam content type is entered into the structure.

Note: *Content Capping Options* is delivered turned off.

The Anonymous ID Options check box is:

- Selected by default for the Course Root content type. You can't disable this option. You can configure non-course content types to use anonymous IDs. This means that anonymous IDs appear for the non-course content types you select; it doesn't mean that anonymous IDs are generated.
- Deselected by default for components that were not previously set up to use anonymous grading.

The Exam Section content type derives the Anonymous ID Options setting from the Exam content type. You can override this setting for Exam Section in the Activity Manager before IAM generation.

Setting Up the Activity Registry

This section provides an overview of the activity registry and discusses how to:

- Define a registry header.
- Review self-service message controls.
- Define copy content.
- Define registry details.
- Define content notes.
- Establish common attributes.
- Review coursework item dates.
- Define staff instructions.
- Review the content tree.

Understanding the Activity Registry

The activity registry enables users to define the grading hierarchy of a course by establishing content types and setting details against the appropriate inclusion and extension records. The generic content tree structure can be applied to one or many courses.

Pages Used to Set Up the Activity Registry

<i>Page Name</i>	<i>Definition Name</i>	<i>Navigation</i>	<i>Usage</i>
Registry Header	SSR_AC_REG_HDR	Curriculum Management > Activity Management > Activity Registry > Activity Registry	Define the activity registry ID, set a course control record against which the activity registry ID references, and reviews the Activity Manager update capabilities.
Content Inclusions	SSR_AC_INCL_FAC2	Click the Updateable Inclusions link on the Registry Header page, Activity Manager WorkCenter Settings tab.	View or update inclusion settings defined as part of the Activity Definition.
Self-Service Messages Control	SSR_INCL_FAC2_NEW	Click the Self-Service Messages Control link on the Registry Header page, Self-Service Messages Controls tab.	View or update the inclusion message settings for the Activity Registry, Activity Manager, and IAM.

Page Name	Definition Name	Navigation	Usage
Copy Content	SSR_AC_CONT_CPY	Click the Copy Content button on the Registry Header page.	Copy content details from one Activity Registry ID to another. The system copies all content details, which can then be edited as needed. Part of the copy process is to identify a Course Control Record for the new activity registry ID.
Registry Detail	SSR_AC_REG_DTL	Curriculum Management > Activity Management > Activity Registry > Activity Registry > Registry Detail	Establish the content structure and content item details. Your institution can create a hierarchy of content items representing the coursework structure. The representation appears in a tree structure.
Content Notes	SSR_AC_CONT_MSGS	Click the Content Notes link on the Registry Detail page.	Select an existing content message or enter free-form text that should be displayed for a content item.
Attributes	SCC_CAF_DYN_SEC	Click the Attributes link on the Registry Detail page. Select to access common attribute fields that were defined on the Record Context page for Activity Registry Items.	Set up common attributes in the Activity Registry.
Review Content Item Dates	SSR_AC_COMP_DATES	Click the Review Dates link on the Registry Detail page.	View the dates that would be assigned for assessment items based on the Day values assigned in the Dates and Duration group box. You can view the dates that would be assigned for a given class section with a specific start date in a term or session.
Staff Instructions	SSR_AC_STAFF_MSGS	Click the Staff Instructions link on the Registry Detail page.	Define staffing content messages.
Content Tree	SSR_AC_REG_CONN	Curriculum Management > Activity Management > Activity Registry > Activity Registry > Content Tree	Build a content tree.

Defining a Registry Header

Access the Registry Header page (**Curriculum Management > Activity Management > Activity Registry > Activity Registry**).

This example illustrates the fields and controls on the Registry Header page: Activity Manager tab. You can find definitions for the fields and controls later on this page.

Registry Header
Registry Detail
Content Tree

Activity Registry ID: C-00000000002
Institution: PSUNV PeopleSoft University

Registry Header Definition Find | View All First 1 of 1 Last

*Effective Date: 01/01/1990 *Status: Active Copy Content

*Content Definition: Coursework [Related Courses](#)

*Description: English Literature

Course Control Record

*Course ID: 001245 Fiction Writing I Exam Only Course
 *Offer Nbr: 1 Subject Area: ENGLIT Catalog Nbr: 134
 Topic ID: 0

Activity Content Control Overrides Personalize | Find | 1-8 of 8 Last

Activity Manager
Activity Manager WorkCenter Settings
Self-Service Message Controls

	Description	Allow Structural Updates	Override
1	Course	<input checked="" type="checkbox"/>	<input type="checkbox"/>
2	Component	<input checked="" type="checkbox"/>	<input type="checkbox"/>
3	Category	<input checked="" type="checkbox"/>	<input type="checkbox"/>
4	Exam	<input checked="" type="checkbox"/>	<input type="checkbox"/>
5	Exam Section	<input checked="" type="checkbox"/>	<input type="checkbox"/>
6	Attendance	<input checked="" type="checkbox"/>	<input type="checkbox"/>
7	Assessment Item	<input checked="" type="checkbox"/>	<input type="checkbox"/>
8	Condition	<input checked="" type="checkbox"/>	<input type="checkbox"/>

This example illustrates the fields and controls on the Registry Header page: Activity Manager WorkCenter Settings tab. You can find definitions for the fields and controls later on this page.

Registry Header
Registry Detail
Content Tree

Activity Registry ID: C-00000000002
Institution: PSUNV PeopleSoft University

Registry Header Definition Find | View All First 1 of 1 Last

***Effective Date:** 01/01/1990 ***Status:** Active Copy Content

***Content Definition:** Coursework [Related Courses](#)

***Description:** English Literature

Course Control Record

***Course ID:** 001245 Fiction Writing I Exam Only Course

***Offer Nbr:** 1 **Subject Area:** ENGLIT **Catalog Nbr:** 134

Topic ID: 0

Activity Content Control Overrides Personalize | Find | First 1-8 of 8 Last

Activity Manager
Activity Manager WorkCenter Settings
Self-Service Message Controls

	Description	Allow Structural Updates	Override	Updatable Inclusions
1	Course	<input type="checkbox"/>		Updatable Inclusions
2	Component	<input type="checkbox"/>		Updatable Inclusions
3	Category	<input checked="" type="checkbox"/>	<input type="checkbox"/>	Updatable Inclusions
4	Exam	<input type="checkbox"/>		Updatable Inclusions
5	Exam Section	<input checked="" type="checkbox"/>	<input type="checkbox"/>	Updatable Inclusions
6	Attendance	<input checked="" type="checkbox"/>	<input type="checkbox"/>	Updatable Inclusions
7	Assessment Item	<input checked="" type="checkbox"/>	<input type="checkbox"/>	Updatable Inclusions
8	Condition	<input checked="" type="checkbox"/>	<input type="checkbox"/>	Updatable Inclusions

This example illustrates the fields and controls on the Registry Header page: Self-Service Message Controls tab. You can find definitions for the fields and controls later on this page.

The screenshot shows a web interface with three tabs: 'Registry Header', 'Registry Detail', and 'Content Tree'. The 'Registry Header' tab is active. It displays the following information:

- Activity Registry ID:** C-00000000002
- Institution:** PSUNV PeopleSoft University
- Registry Header Definition:** Includes a search bar, 'Find | View All', and pagination 'First 1 of 1 Last'. Fields include:
 - *Effective Date: 01/01/1990
 - *Status: Active
 - *Content Definition: Coursework
 - *Description: English Literature
- Course Control Record:** Includes fields for:
 - *Course ID: 001245 (Fiction Writing I)
 - *Offer Nbr: 1
 - Topic ID: 0
 - Subject Area: ENGLLIT
 - Catalog Nbr: 134
 - Exam Only Course:
- Activity Content Control Overrides:** Includes a search bar, 'Personalize | Find', and pagination 'First 1-8 of 8 Last'. It shows a table with 8 rows, each representing a different activity level with a 'Self-Service Messages Control' link.

Field or Control	Description
Activity Registry ID	The system sequentially assigns this value to indicate a unique activity registry. The prefix used for the number can be set and the last ID assigned can be viewed on the Student Admin Installation page.
Copy Content	You can copy an entire content tree from one activity registry ID to another. Click this button to access the Copy Content page, where you enter an activity registry ID to copy as well as to define the course control record for the new ID.
Content Definition	The delivered content definition value for the Marks and Exams initiative is <i>Coursework</i> .

Field or Control	Description
Related Courses	Click this link to access the Related Courses page, which displays the courses that have been associated with this registry. You can add additional courses on either the Maintain Course Content XRef or Manage Content to Courses components.

Course Control Record

This section is created based upon the extension record defined for the Coursework Activity Definition. The course identified here is considered the control course for this activity registry and is automatically associated with the registry. The system prompts for this course when determining the course catalog structure and ownership. This becomes particularly significant when multiple courses are associated with one activity registry.

Field or Control	Description
Course ID	Identify the course ID of the course control record.
Offer Nbr (number)	Identify the course offer number of the course control record.
Associate All Offerings	This field appears in Add mode. If the course has multiple offerings but all offering have the same content item requirements then this check box associates the Registry ID to all offerings. However, if the content item requirements differ among the course offerings, clear this flag and create unique Activity Registry IDs for each course offering.
Topic ID	(Optional) Identify the course topic of the course control record. If a topic exists at the class section level but no Topic ID is entered here, the registry is applicable to all sections regardless of topic. However if content item requirements differ within a course topic course, then create unique Activity Registry IDs for each course topic.
Exam Only Course	This check box is set to <i>Yes</i> by default when it is set to <i>Yes</i> on the CRSE_CATALOG_OFFER page of the Course Catalog. Exam-only courses (EOCs) are those for which no class sections are scheduled and no student class enrollment occurs; the student receives credit for the course only by sitting and successfully completing the course exam. When this flag is set to <i>Yes</i> , the Component content type is not available on the Registry Details page.

Activity Manager Structural Update Overrides

This section enables users to view and/or override the settings that control what users can update on the content tree in the Activity Manager.

<i>Field or Control</i>	<i>Description</i>
Content Type and Description	These two display-only fields indicate the sequential number of the content type and its description.
Allow Structural Updates	This check box indicates whether the content type was set up to allow updates in the Activity Manger. This setup occurs on the Activity Definition page.
Override	If the content type was set up to allow structural updates for a specific activity registry, this check box appears. Select the check box to enable users to change a content value only from <i>Yes</i> to <i>No</i> .

Activity Management WorkCenter Structural Update Overrides

This section enables users to view and/or override the settings that control what faculty and exam staff users can update on the coursework tree in the Activity Management WorkCenter.

<i>Field or Control</i>	<i>Description</i>
Content Type and Description	These two display-only fields indicate the sequential number of the content type and its description.
Allow Structural Updates	This check box indicates whether the content type was set up to allow updates in the Activity Management WorkCenter. This setup occurs on the Activity Definition page.
Override	If the content type was set up to allow structural updates for a specific activity registry, this check box appears. Select the check box to enable users to change a content value only from <i>Yes</i> to <i>No</i> .
Updateable Inclusions	Select this link to access the Inclusion Options secondary page where you can review or override the inclusion settings that were defined in the Activity Definition. In the Activity Management WorkCenter, faculty and exam staff users are only able to edit those inclusions set to <i>Yes</i> . Select the check box to enable users to change a content value only from <i>Yes</i> to <i>No</i> .

Self-Service Message Controls

Configure which messages the system should display in self service, based on the source of the data, the Activity Registry, the Activity Manager, or the IAM. The selections are populated by the Activity Definition, but can be overridden here for a specific registry.

Reviewing Self-Service Message Controls

Click the **Self-Service Messages Control** link on the Registry Header page, Self-Service Message Controls tab.

This example illustrates the fields and controls on the Self-Service Messages Control page (for exam content type). You can find definitions for the fields and controls later on this page.

Inclusion	Show Message in Registry	Override	Show Message in Manager	Override	Show Message in IAM	Override
General	<input type="checkbox"/>	<input type="checkbox"/>	<input type="checkbox"/>	<input type="checkbox"/>	<input checked="" type="checkbox"/>	<input type="checkbox"/>
Insufficient Mark Options	<input type="checkbox"/>	<input type="checkbox"/>	<input type="checkbox"/>	<input type="checkbox"/>	<input type="checkbox"/>	<input checked="" type="checkbox"/>
Resit Options	<input checked="" type="checkbox"/>	<input type="checkbox"/>	<input checked="" type="checkbox"/>	<input type="checkbox"/>	<input checked="" type="checkbox"/>	<input type="checkbox"/>
Scheduling Options	<input type="checkbox"/>	<input type="checkbox"/>	<input type="checkbox"/>	<input type="checkbox"/>	<input checked="" type="checkbox"/>	<input type="checkbox"/>
Staffing Requirements	<input type="checkbox"/>	<input type="checkbox"/>	<input type="checkbox"/>	<input type="checkbox"/>	<input type="checkbox"/>	<input checked="" type="checkbox"/>
Devices	<input type="checkbox"/>	<input type="checkbox"/>	<input type="checkbox"/>	<input type="checkbox"/>	<input checked="" type="checkbox"/>	<input type="checkbox"/>
Forms of Identification	<input type="checkbox"/>	<input type="checkbox"/>	<input checked="" type="checkbox"/>	<input checked="" type="checkbox"/>	<input checked="" type="checkbox"/>	<input type="checkbox"/>

This example illustrates the fields and controls on the Self-Service Messages Control page (for assessment item content type). You can find definitions for the fields and controls later on this page.

Description	Show Message in Registry	Show Message in Manager	Show Message in IAM
General	<input checked="" type="checkbox"/>	<input checked="" type="checkbox"/>	<input checked="" type="checkbox"/>
Insufficient Mark Options	<input type="checkbox"/>	<input type="checkbox"/>	<input checked="" type="checkbox"/>
Late Penalty Options	<input type="checkbox"/>	<input type="checkbox"/>	<input checked="" type="checkbox"/>
Resit Options	<input type="checkbox"/>	<input type="checkbox"/>	<input checked="" type="checkbox"/>
Dates and Durations	<input type="checkbox"/>	<input checked="" type="checkbox"/>	<input checked="" type="checkbox"/>

The values on this page appear by default from the Activity Definition. To change these values, select the **Override** field.

In the example above, if an individual is reviewing activity detail that comes from the Activity Registry, he does not see any information concerning **Forms of Identification** that would be required for an examination. However if the source of the data is the Activity Manager (overridden in this example) or the IAM, he sees the **Forms of Identification** information.

Defining Copy Content

Access the Copy Content page (click the **Copy** button on the Registry Header page).

This example illustrates the fields and controls on the Copy Content page. You can find definitions for the fields and controls later on this page.

Copy Content

Copy From

Institution: PSUNV

***As Of Date:** 01/01/2000

***Activity Registry ID:** C-000000000002 English Literature

Copy To (Course Control Rec)

***Course ID:** 003702 General Biology II

***Offer Nbr:** 1 **Subject Area:** BIOLOGY **Catalog Nbr:** 102

Topic ID: 0

<i>Field or Control</i>	<i>Description</i>
As Of Date	The effective date from which to copy the activity registry id. The effective dated row matching this date is copied.
Activity Registry ID	Enter the activity registry ID from which to copy all content detail.
Course ID and Offer Nbr (number)	Identify the course ID and offer number of the course control record.
Topic ID	(Optional) Identify the course topic of the course control record. If a Topic ID exists but it not entered, the system applies the registry to all sections of the Course ID/Offer Nbr/Topic ID combination.

Defining Registry Details

Access the Registry Detail page (**Curriculum Management > Activity Management > Activity Registry > Activity Registry > Registry Detail**).

This example illustrates the fields and controls on the Registry Detail page. You can find definitions for the fields and controls later on this page.

Registry Header
Registry Detail
Content Tree

Activity Registry ID: C-0000000002
Institution: PSUNV PeopleSoft University

Registry Header Definition Find | View All First 1 of 1 Last

Effective Date: 01/01/1990 **Status:** Active + -
Content Definition: Coursework
Description: English Literature

Content Item Auto-Sequencing Options

Content Item Step: 0010 **Last Sequence Number:** 000000050 Reset

Registry Content Detail Find | View All First 1 of 5 Last

***Content Item ID:** ITX-000010 + -
Parent ID: + -
***Content Code:** CRSE **Insert Child Item** + -
***Content Type:** 1000-Course **Root**
***Description:** Course [Content Notes](#)

Content Options

***Result Scale:** 100 PT +
Passing Mark/Grade: 70.000 / + **Service Impact:** GRADE +
Workload (hours): (minutes):

Show in Student SS **Anonymous Grading**
 Calculate Mark Average **Calculate Standardized Units**
 Calculate Mark Rank

Insufficient Mark Options

Mark Option: Blank Mark - Exclude +

Content Devices

Device ID	Description	Required	+	-
FLDICT +	Foreign Language Dictionary	<input checked="" type="checkbox"/>	+	-

The following group boxes always appear on this page:

- Registry Header Definition
- Content Item Auto-Sequencing Options
- Registry Content Detail
- Content Options

The system displays all other group boxes based on the extension and inclusion records (Activity Definition) associated with the content type being defined.

Content Item Auto-Sequencing Options

Field or Control	Description
Content Item Step	<p>The Content Item Step numbers the content item ID. When you create a content item in the Activity Registry the system assigns a content item ID (prefix + step number sequence). A value of 0010 indicates that content item ID numbers are sequenced by 10. You can change this value from the creation of one content item ID to the next.</p> <hr/> <p>Note: The prefix and default content item step are initially established on the Student Admin Installation table.</p>
Last Sequence Number	<p>This field records the last content item ID generated. It can be altered if there is a need to insert a new row into the content structure.</p> <p>To insert a new row, go to the row where the insert should be placed, and change the last sequence number to that content item ID. Then alter the content item step with the sequence number of the new row and then add the new row.</p> <p>For example, two rows are created: ITX-000010 and ITX-000020. You then need to insert a row between these two content items. On the ITX-000010 row, change the Last Sequence Number to <i>00000010</i> and change the Content Item Step to <i>0005</i>. Then insert a new row. The system assigns the new row as ITX-000015. Next, select the Reset button to reset the Last Sequence Number back to the highest assigned: <i>00000020</i>.</p>
Reset	<p>Select this button to reset the Last Sequence Number to the highest number assigned in this Activity Registry ID.</p>

Registry Content Details

It is within this section that you build the content tree structure using the content types defined on the coursework activity definition. Based on the content type entered, you are presented with attributes and grading options selections. Users should utilize the Insert Child/Insert Sibling options to ensure that valid parent/child relationships exist throughout the structure.

Note: Many of the elements entered in this section imply a calculation requirement. The calculation process is under construction and will be delivered fully functional in a later release.

Field or Control	Description
Content Item ID	The system assigns this ID based on the Content Item Prefix and the Content Item Step . You can override this number or manually assign it.
Parent ID	The system populates this field when inserting child or sibling items with the parent content item ID of that particular content item ID. You can override this number or manually assign it.
Copy/Paste Icons 	Click the icons to copy and paste detail from one content item to another. First select the copy icon, then select the Insert a Row icon, and then select the paste icon. Then, you can adjust different values on the new row.
Content Type	<p>The values in this field are concatenated from the Content Type and Description fields on the Activity Definition page. On the Activity Definition page, the Content Types must be <i>Active</i> to appear here. The root content type (Course for the Coursework definition) automatically defaults in add mode. You cannot delete this row. At the Course level, only children content items can be inserted. At all other levels, the Insert Sibling check box appears.</p> <p>Under the root level, you can add children and sibling content items. The children and sibling options available are dependent on the Item Order, the Child Item flag, and the Self-Reference Allowed flag defined on the Activity Definition page. Children and sibling items can only be added if the Item Order is \leq to the current content type and the child item and self-reference allowed settings are appropriate. The exception to this is the 9000-Condition type, which can be placed into the content tree based upon the defined parent and child types defined in the Activity Definition.</p> <p>If a course was identified as an EOC, the 2000-Component value is disabled.</p>
Description	The system displays this description in the content tree and in self-service user interfaces.
Content Code	Enter a short description of the coursework item.
Insert Child Item	Select this check box to allow insertion of a child item to this content item ID. The Parent Item ID carries forward to the new row.

Field or Control	Description
Insert Sibling Item	Select this check box to allow insertion of a sibling item to this content item ID. The Parent Item ID carries forward to the new row. This field is hidden when the content type is <i>Course</i> .
Root	This flag indicates whether the current content item ID is the content root. This check box is selected when the content type is <i>Course</i> .
Content Notes	Click this link to access the Content Notes page where you can select a content message ID or enter free form text. Information entered here pertains to the specific content item ID.

Content Options

These options are applicable to all content types, although some specific considerations are taken when the **Content Type** is *Course*.

Field or Control	Description
Result Scale	<p>Result scales that were defined on the Result Scale setup page appear here. This field value is required for the root content item and is inherited by all the children of the root. However, it can be overridden at any level. If different result scales exist in the course root, the primary result scale calculation can convert result scales and results. You can view the setup for the result scale conversion on the Academic Institution 9 page.</p> <p>Users can predefine this value using the Activity Management Default setup on the Academic Institution.</p> <p>For information, see:</p> <ul style="list-style-type: none"> • Calculation of Overall Course Results using Multiple Result Scales on My Oracle Support (Doc ID 1400723.1) • “Enabling Program Enrollment and Activity Management Defaults” (Campus Solutions Application Fundamentals)
Override	The Result scale for all content items, except the root, is inherited from its parent. Select this check box to allow users to change the Result Scale .

Field or Control	Description
Weighting Multiplier	Indicate what weighting is given to this content item in the calculation of its parent result. Percentages can be represented using less than whole numbers.
Assessed	Select this check box to indicate that the item is required to have a result and is to be used in a calculation. Clear this check box if the content item is for display purposes only.
Include in Calc	This check box is greyed out if Weighting Multiplier is greater than 0.00. If Weighting Multiplier is 0.00, you can modify this check box by deselecting it. This allows for a zero weighted item to be excluded from calculation.
Passing Mark/Grade	Enter the minimum passing mark and/or the minimum passing grade for the specific content item. Users can predefine these values using the Activity Management Default setup on the Academic Institution.
Service Impact	Indicate which service impact disallows the view of results in student self service. This field value is inherited by all the children of the content item against which it is set. However, you can override it at any level. Users can predefine this value using the Activity Management Default set up on the Academic Institution component.
Workload (hours) / (mins)	Enter the estimated hours and minutes that a student needs to allocate to complete this content item. This field is informational for students and is not used in any calculation.
Attributes	This link appears when a Common Attribute has been added to a content type entity on the Common Attribute Record Context page. See “Associating a Common Attribute to a Record” (Campus Community Fundamentals)
Show in Student SS (Self Service)	Select this check box to indicate that the content item details are available for display in self service. This flag must also be selected on parent items for the content item to appear. This field is selected by default.

Field or Control	Description
Calculate Mark Average	Select this check box to indicate that a mark average across all students should be calculated for this content item.
Calculate Mark Rank	Select this check box to indicate that student ranks should be calculated for this content item.
Mandatory Pass Required	<p>Select this check box to indicate that this content item is required to be passed to achieve an overall passed result for the course.</p> <p>When the system performs the primary course calculation, it analyzes this setting. For those items where this field is selected, the system reviews the corresponding result scale. For the mandatory pass processing to run, the result scale must use the Outcome field (it identifies a failed result) and must have the Mandatory Fail flag set. If these two items do not exist on the associated Result Scale, the system does not apply the mandatory pass processing.</p> <p>When an Activity is set to Mandatory Pass Required and the resulting outcome is Failed, all the parent Activities initiate the mandatory fail logic. If the Result Scale of a parent activity is set to use a Mandatory Pass Result Scale, the parent Activity creates the Calculated Result using the Mandatory Pass Result Scale. If the content allows for Resit and the resulting mark is Resit eligible, the activity is set to Resit Candidate.</p>
Override	Select this check box to indicate that you want to override the default setting for anonymous grading for this content. The current settings are displayed next to the check box.
Calculate Standardized Units	Select this check box to indicate that standardized units should be assessed when the student achieves a passing mark for this content item.
Standardized Units	This field appears when the Calculate Standardized Units check box is selected. Enter any standardized units for this content item. For example, this field can be used to store European Credit Transfer and Accumulation System (ECTS) units.

Extension Records

Additional group boxes appear on this page based on the **Content Type** selected. Extension records allow you to refine the functional properties of content types by assigning additional relevant attributes to them. These extension record definitions are set for specific content types on the Activity Definitions page.

Field or Control	Description
Course	<p>A course serves as the root of a coursework content tree. It is the only required content type that must be used in the content structure. The extension record for the course content type populates the course control record that appears on the Registry Header page of the activity registry.</p>
Component	<p>When the Content Type is <i>Component</i>, the Component Options group box appears.</p> <p>In the Course Component field, the system displays components that are specific to the course that was defined as the Course Control Record.</p> <p>The component used in Activity Management is SSR_COMPONENT; the same field is used in the course catalog structure. The valid values that appear are from the Course Control Record defined on the Activity Header page.</p> <p>Component results are calculated from their children, but can be overridden. Component results are also used to calculate their parents' result (course).</p> <p>Components are not required to be built into the coursework structure. When creating a content structure, consider the following when determining if a component should be added to the structure:</p> <ul style="list-style-type: none"> • Add component(s) if a result is required for that component. • Add component(s) if there is a need for the content structure to match the course catalog structure. • Add component(s) if there is a need to display components to students in self service.
Category	<p>When the Content Type is <i>Category</i>, the Category Options group box appears.</p> <p>In the Content Category field, the system displays categories that were defined on the Content Category setup page.</p> <p>A category is an optional level that can be added to the content structure to assist with grouping for display and/or calculation purposes. When calculated, category results are computed from their children, but can be overridden. Category results are also used to calculate their parents' result (component or course).</p>

Field or Control	Description
<p>Exam</p>	<p>When the Content Type is <i>Exam</i>, the Exam Options group box appears.</p> <p>In the Exam Type field, the system displays types that were defined on the Exam Type setup page. In addition, set the Exam Duration (in hours and minutes).</p> <hr/> <p>Note: If multiple exams are created for the course, and if the resit functionality is used, then each exam must have a different exam type.</p> <hr/> <p>This content type should be used for any examination that requires its own rules and attributes, is scheduled outside of a class construct, and has special enrollment considerations. Do not use exams for class section-specific tests (in class or a final that is section specific); define these as assessment items. An exam can have a child item of itself if it makes sense for an institution to create an exam in a hierarchical structure. Examination results are entered manually and are used to calculate their parents' result (exam, category, component, or course).</p>
<p>Attendance</p>	<p>There is no delivered extension record for the content type <i>Attendance</i>.</p> <p>Enter an <i>Attendance</i> content type into the content tree when your institution wants to store an attendance result and use it in a calculation for a parent result; however, there is no specific extension record for this content type. The attendance details are captured as part of the Attendance inclusion record.</p> <p>Users can track attendance without inserting the <i>Attendance</i> content type. You can select the attendance content inclusion for the other content types and record a result; however the system does not use this result in the primary course calculation. To use an attendance result in the primary course calculation, you must insert the <i>Attendance</i> content type into the content tree.</p> <p>Users can predefine these values using the Activity Management Default setup on the Academic Institution component.</p>

Field or Control	Description
Assessment Item	<p>When the Content Type is <i>Assessment Item</i>, the Assessment Item Options group box appears.</p> <p>Select the Extra Credit check box if the given assignment is undertaken for extra credit. The extra credit assignment can be added to all or individual students in the IAM. The system adds the points attained to the calculation for the overall category, component, or course result as applicable.</p> <p>Select the Question check box if the given assessment item is being created as part of an exam and you want to identify it as a question on the exam.</p> <p>An assessment item can have a child item of itself if it makes sense for an institution to create assessment items in a hierarchical structure. Assessment item results are entered manually and are used to calculate their parents' result (assessment item, attendance, exam, category, component, or course).</p>

Field or Control	Description
Condition	<p>When the Content Type is <i>Condition</i>, the Condition Options group box appears.</p> <p>Use a condition to inject an option for students. When you use a condition you indicate how many of the following child items a student must select and complete. The system applies the label <i>Select nbr</i> to the condition in the content tree. The child items of the condition have the <i>Or</i> condition inserted into the content tree. Conditions can be used to create varying And/Or scenarios. Below are a number of examples.</p> <p>Example 1: AND/OR/AND</p> <p>Each student must complete either HW1 <i>AND</i> HW2 <i>OR</i> Oral Presentation 1 <i>AND</i> Oral Presentation 2. A <i>condition</i> (Options – Select 1) is created as the parent of two <i>categories</i> (Option 1 – Homework and Option 2 – Oral Reports). Each category has two <i>assessment items</i>.</p> <p>Example 2: Option within an option</p> <p>Each student must complete either Option 1 (HW1 and HW2) <i>OR</i> Option 2 (either Report 1 <i>OR</i> Report 2). A <i>condition</i> is created as a parent to a <i>category</i> (Option 1 – Homework) and a <i>condition</i> (Option 2 – Report).</p> <p>Example 3: OR/AND/OR</p> <p>Each student must complete a homework assignment from both Option 1 and Option 2. A <i>condition</i> is created for each selection. Thus, it reads HW1 <i>OR</i> HW2 <i>AND</i> HW3 <i>OR</i> HW4.</p>

Inclusion Options

The following sections appear on the page based on the inclusion options defined for each content type on the Activity Definitions page. Include or exclude these options based upon your institution's needs.

General Options

Field or Control	Description
Mandatory	<p>Select this check box to indicate that this content item is required. When a content item is required the system automatically assigns it to a student when the student enrolls in the class or the EOC. When an item is not marked as mandatory it is considered optional. Optional items can be placed in a condition that allow a student to choose between several options. This field is selected by default.</p>

<i>Field or Control</i>	<i>Description</i>
Required by Institution	Select this check box to indicate that this content item is required by the institution and cannot be deleted by a faculty or administrative user.
Allow Override or Substitution	Select this check box to indicate that for a student this content item can be overridden or substituted with a different content item.
Topic Approval Required	Select this check box to indicate that a specific topic approval is required for this content item. For instance, a research project topic may require approval before students can begin the project.
Include for Mid Term Grade	Select this check box to indicate that this content item mark is used to calculate a midterm result.

Insufficient Mark Options

This group box applies to all content types, but can be turned off for any content type on the Activity Definition. Use these fields to define what should occur when there is an insufficient mark in the student record for a given content item.

Field or Control	Description
Mark Option	<p>During the calculation process, if no mark has been entered for an assigned content item, and if applicable, the Late Content Penalty Rule has expired, the system uses the value selected here to determine how to calculate the content item. Valid values are:</p> <ul style="list-style-type: none"> • <i>Blank Mark - Include</i> <ul style="list-style-type: none"> • Calculate the item mark as zero (0) or • Enter a Minimum Mark Value to calculate for a missing content item mark • <i>Blank Mark – Exclude</i>: the content item (if blank) is excluded from the calculation. <p>You can also use this feature to eliminate a result from a calculation.</p> <ul style="list-style-type: none"> • <i>Below Threshold – Exclude</i>: exclude a mark from calculation. • The content item mark is excluded from the calculation if the mark is less than or equal to the Insufficient Mark Threshold.
Minimum Mark Value	<p>This field appears when the <i>Blank Mark – Include</i> value is selected as the Mark Option.</p> <p>This indicates that even though there is no mark entered for the content item, this value will be used in calculation. If this field is left blank, a zero is used in the calculation.</p>
Insufficient Mark Threshold	<p>This field displays when the <i>Below Threshold – Exclude</i> is selected as the Mark Option.</p> <p>This indicates that the content item is excluded from the calculation when it is less than or equal to the mark indicated here.</p>

Attendance Tracking Options

This group box applies to all content types, except Exam Section. It is delivered as active only for the *Attendance* content type, but that can be adjusted on the Coursework Activity Definition. Users can predefine these values using the Activity Management Default setup on the Academic Institution.

Field or Control	Description
Track Using	Define the requirement for attendance as a <i>Number of Classes Attended</i> , <i>Percentage of Classes Attended</i> , or <i>Number of Allowed Absences</i> .
Required Attendance	This field appears when the Track Using field is set to <i>Number of Classes Attended</i> or <i>Percentage of Classes Attended</i> . Indicate the number or percentage of classes that a student must meet to pass the attendance requirement.
Allowed Absences	This field appears when the Track Using field is set to <i>Number of Allowed Absences</i> . Indicate the number of absences allowed.
Result	This check box appears when the attendance tracking inclusion is being used with a non-Attendance content type. The field should be selected to track an attendance result (it cannot be calculated) for any content item except Attendance.

Late Content Penalty Options

This group box applies to *Assessment Item* content types. Late penalties can be automatically calculated by setting one of five late penalty options. Both the earned mark and the penalized mark are stored but only the penalized mark is used in calculation. A late penalty is assessed for this content item when the student submits the assignment after the due date or the extended due date (if an extended due date exists).

Field or Control	Description
Penalty Type	Select the method to apply late penalties. Valid values include: <i>Capped</i> – students can earn no higher than the specified value; <i>Daily</i> – students have points deducted for each day the item is late <i>Fixed</i> – students automatically earn this mark <i>One Time</i> – students have this value deducted <i>Weekly</i> – students have points deducted for each week the item is late. <i>No Penalty</i> is the delivered default.

Field or Control	Description
Late Penalty	This field appears when you select a Penalty Type of <i>Daily</i> , <i>One Time</i> , or <i>Weekly</i> . When you select <i>Daily</i> or <i>Weekly</i> , the Penalty Max field also appears.
Penalty Mark	This field appears when you select a Penalty Type of <i>Capped</i> or <i>Fixed</i> . The system enters this value for the student when the item is submitted late.
Penalty Max	This field appears when you select a Penalty Type of <i>Daily</i> or <i>Weekly</i> . Enter the maximum number of points that an assessment item can be penalized.
Grade Expires to Zero in ___ Days	Select this check box if, at some point, the mark should be marked as zero. Then, enter the number of days that will pass before the assessment item turns to zero.

Dates and Durations

This group box applies to *Assessment Item* content types. In this section you define landmark days for the content item as well as the number of days from a date trigger the landmark dates should fall. When the content tree for the course is associated with a scheduled class, the landmark dates are populated based on these rules. The Review Dates page serves as a visual tool for a given term to see how the dates might populate.

Field or Control	Description
Date Trigger	Select which trigger date option to use to determine the landmark dates. The choices are to use the <i>Term Start Date</i> , <i>the Session Start Date</i> , or the <i>Class Start Date</i> .
Start Days	Enter the number of days from the Date Trigger when this content item can be started.
Due Days	Enter the number of days from the Date Trigger when this content item is due. The system dispenses late penalties against this content item beginning one day after this date unless an extended due date exists for an individual student.
Grading Days	Enter the number of days from the Date Trigger when this content item is to be graded.

Field or Control	Description
Review Dates	Click this link to access the Review Content Item Dates page where you can view estimated dates for a given term, session, or class start date.

Resit Options

This group box can be applied to *Category*, *Exam*, and *Assessment Item* content types. Use this section to support reassessment (resit) rules. Resit rules pertain to both standard reassessment (resitting the same activity) and supplemental resits (substituting the original activity with a different activity).

Field or Control	Description
Resits Allowed	Select this check box to indicate that this content type is allowed to be reassessed. When selected, the Supplemental Resit field, the Resit Period Option, and the Attempt Limit sections are displayed.
Supplemental Resit	<p>Select this check box to indicate if this content item is to be used as a supplemental resit content item. This content item is only used when a student must be reassessed. For instance, initially students may be assessed on a particular assessment item or exam. Students who fail this assessment item or exam, however, may be given an opportunity to be reassessed, but not on the same assessment item or exam. This secondary item should be noted as a supplemental resit. After indicating this item is a supplemental resit, it must be added as a Supplemental Resit Item on the initial content item.</p> <p>If several items can be used as a supplemental resit to an original attempt, the supplemental items should be created as a child of a category and the Supplemental Resit flag should be placed at the category level. Use a category if multiple supplemental items are to be used for reassessment.</p>
Calculation Option	<p>Indicate how to calculate a Resit in relation to the previous mark:</p> <ul style="list-style-type: none"> • <i>Average All Marks</i> – calculate the average mark across all attempts. • <i>Highest Mark</i> – count the highest mark among all previous attempts. • <i>Most Recent Mark</i> – count the most recent mark among all previous marks.

Field or Control	Description
Supplemental Resit Item	<p>This field is available when the Resits Allowed check box is selected. It should be used when the current content item is to be reassessed with a supplemental content item. The content item to be used as the supplemental item must already be created in the hierarchy and selected as a supplemental resit.</p>
Resit Period Assignment	<p>This grid is available when the Resits Allowed check box is selected. When the resit item is an exam, users can define how to assign the academic period for the resit exam. Values include <i>Next Exam Period</i>, <i>Next Exam Regular Period</i>, and <i>Next Exam Resit Period</i>. The Regular and Resit Period types are defined on the Academic Period Table.</p> <p>The automatic assignment of the academic period for these values occurs when running the IAM Resit Evaluation process. An additional value, <i>Student Selection</i>, allows students to select the academic period through self service on the Resit Exam Selection page. This page appears only when the student is eligible for this selection.</p>
Nbr Periods to Display	<p>This field is available when the Resit Period Assignment is <i>Student Selection</i>. You indicate the number of future academic periods that is available for the student to select.</p> <p>It is critical that you set up the number of future academic periods as well as scheduled exams during these periods. Otherwise, students are presented with the message: <i>No Future Periods</i>.</p>
Regular Exam	<p>This field is available when the Resit Period Assignment is <i>Student Selection</i>. Select if the student is allowed to select period of a regular exam for their resit.</p>
Resit Exam	<p>This field is available when the Resit Period Assignment is <i>Student Selection</i>. Select if the student is allowed to select period of a resit exam for their resit.</p>
Attempt Time Period	<p>Select the time periods against which reassessment limits are applied. This field works in conjunction with the Allowed Attempts field. Delivered time periods are: <i>Academic Year</i>, <i>Academic Career</i>, and <i>Academic Program</i>.</p>

Field or Control	Description
Allowed Attempts	<p>Enter the number of allowed attempts for the activity for the period selected.</p> <p>This value indicates total attempts at the activity, including the original. If an activity can be reassessed just once, the value entered should be 2 for the original attempt and the resit attempt.</p> <p>A supplemental exam cannot be reassessed and therefore the number of attempts is limited to 2 for the original content item.</p>

Scheduling Options

This group box applies to *Exam* content types. Use these fields to define exam scheduling requirements. You can override these requirements when the exam is scheduled in the Section Manager.

Note: If the **Exam Section** Content Type is not selected and inactive, these fields are disabled, and the Exam is generated without an Exam Section. Scheduling Options are also disabled in Activity Manager and Activity Manager Self-Service WorkCenter.

Field or Control	Description
Schedule Activity	<p>Select this check box to indicate that an exam section should be scheduled in the Section Manager.</p> <hr/> <p>Note: If Exam Section is selected and active in Activity Definition, but Schedule Activity not selected here, batch generation can still generate Activities.</p> <hr/>
Number of Sections to Schedule	<p>Indicate the number of exam sections to schedule in the Section Manager. Users cannot insert the Exam Section content type into the Activity Registry. By selecting the Schedule Activity check box and indicating the number of exams to schedule for the exam, the system automatically inserts the exam section row(s) into the content tree at the section level. The sections appear initially in the Activity Generator.</p>
Connector Type	<p>This field appears when the Number of Sections to Schedule is two or more. The connector type allows users to indicate whether students should be assigned to each of the scheduled exam sections (<i>And</i>) or if the students need to choose between multiple sections (<i>Or</i>). The system inserts Or connectors into the content tree in the Activity Generator when the exam sections are inserted.</p>

Field or Control	Description
Calculated Result	Select this check box to indicate that this particular exam level does not have a mark entered directly against it, but will have a calculated result based upon the calculation of child items.
Confirmation Required	Select this check box to indicate that a student must confirm his/her attendance in the assigned exam section.
Use 3rd Party Scheduler	Select to indicate you will find an alternative solution for scheduling exams.

Note: Exam sections inherit the exam type of the exam content type (its parent). If multiple scheduled sections require different exam types, users should create an exam for each type in the coursework hierarchy.

Staffing Requirements

This group box applies to *Exam* content types. Users can use these fields to define staffing requirements. You can override these requirements when the exam is scheduled.

Field or Control	Description
Staff Instructions	Click this link to access the Staff Instructions page where you can add staff instruction content messages.
Staff Type	Select an examination staff type. Staff Types are delivered as translate values. Delivered values include: <i>Chief Examiner, Examiner, Invigilator, and Proctor</i> . Additional staff types can be added to the translate field SSR_CW_EX_STF_TYPE.
Minimum Required	Enter the number required for each staff type. You can enter a flat number, or use the field in conjunction with the Student/Staff Ratio field by indicating the number of staff in this field per the number of students identified in the Student/Staff Ratio field.
Student/Staff Ratio	Use with the Minimum Required field to establish a staff (minimum required)-to-student ratio. For example, there could be requirement that two proctors are required for every 30 students.

Content Devices

This group box applies to all content types, but can be turned off for any content type on the Activity Definition. Users can indicate devices that are allowed or required for a content item. You can override these devices when a class or an exam is scheduled.

<i>Field or Control</i>	<i>Description</i>
Device ID	Indicate devices that may be required for a course, could be used during an examination, or are needed to complete an assessment item. The devices are setup on the Content Devices page.
Required	Select this check box to indicate whether students are required to have this device type for a content item. Otherwise, this device type is considered acceptable, but optional.

Forms of Identification

This group box applies to Exam content types. Users can use these fields to define acceptable forms of identification. You can override these requirements when the exam is scheduled. Users can predefine these values using the Activity Management Default setup on the Academic Institution.

<i>Field or Control</i>	<i>Description</i>
Form of Identification	Indicate which documents or identification a student is required to show for entrance into the examination.
Required	Select this check box to indicate if the form of ID is required for entrance into the examination. Otherwise, this form of ID is considered acceptable, but optional.

Defining Content Notes

Access the Content Notes page (click the **Content Notes** link on the Registry Detail page).

This example illustrates the fields and controls on the Content Notes page. You can find definitions for the fields and controls later on this page.

The screenshot shows the 'Content Notes' interface. At the top, the 'Content Item ID' is 'ITX-000010'. Below this is a 'Note Text' area with a search bar containing 'ENGLLIT - 23' and a search icon. To the right of the search bar is a checkbox labeled 'Administrative Use Only' which is currently unchecked. Below the search bar, the note text reads: 'Inform your faculty member if you plan to pursue Research Option 1, which includes an oral presentation or Research Option 2.' The interface also includes navigation buttons for 'Find', 'First', '1 of 1', and 'Last'.

The **Message ID** options available here are defined during Content Message setup. Only those messages defined as General Content Messages appear. This message appears to students, faculty, and administrative users unless the **Administrative Use Only** check box is selected. If selected, students do not see the message.

<i>Field or Control</i>	<i>Description</i>
Message Seq (sequence)	The system assigns the sequential number.
Message	If you enter a Message ID, that message appears; otherwise you can enter a free-form message.

Establishing Common Attributes

Access the Attributes page (click the **Attributes** link on the Registry Detail page). Select to access common attribute fields that were defined on the Record Context page for Activity Registry Items)

This example illustrates the fields and controls on the Attributes page. You can find definitions for the fields and controls later on this page.

The screenshot shows the 'Attributes' page. It features a table with the following information:

Registry ID:	English Literature
Institution:	PSUNV PeopleSoft University
Eff Date:	1990-01-01
Content Type:	1000-Course
Item ID:	ITX-000010
Description:	Course

Below the table, there are two dropdown menus with search icons:

- Course Level:** LEVEL 1 (Level 1)
- Language of Instruction:** SPANISH (Spanish)

The screenshot above provides an example of common attributes set up for the course content item in the Activity Registry.

The fields that appear on the Attributes page are customer-specific and are defined on the Common Attributes and Record Context pages. The record context used for the Activity Registry is the Content Item Attributes (SSR_AC_CONT_ITM) record. The entity names used for the Activity Registry are prefixed by 'ACR'.

See “Defining a Common Attribute” (Campus Community Fundamentals)

See “Associating a Common Attribute to a Record” (Campus Community Fundamentals)

Reviewing Coursework Item Dates

Access the Review Content Item Dates page (click the **Review Dates** link on the Registry Detail page).

This example illustrates the fields and controls on the Review Content Item Dates page. You can find definitions for the fields and controls later on this page.

Review Content Item Dates

Estimate Assignment Landmarks

Term Start Date

Session Start Date

Class Start Date

Estimate Dates From Date

Institution: PeopleSoft University

Career: Undergraduate

Term: 2013 Fall

Session:

Estimate Dates From Date:

Estimated Dates from Duration

	Estimate		Estimate
Start Days: <input type="text" value="15"/>	09/13/2013	Grading Days: <input type="text" value="35"/>	10/03/2013
Due Days: <input type="text" value="30"/>	09/28/2013		

Note: This page is designed to provide a visual estimate when originally defining the Activity Registry ID. These values are not stored.

Estimate Assignment Landmarks

<i>Field or Control</i>	<i>Description</i>
Term Start Date, Session Start Date, or Class Start Date	Select the trigger date to use to determine the landmark dates.
Estimate Dates from Date	Enter a class start date.

Estimated Dates from Duration

Based on the days entered in the fields of this group box, the system populates a date estimate.

Defining Staff Instructions

Access the Staff Instructions page (click the **Staff Instructions** link on the Registry Detail page).

This example illustrates the fields and controls on the Staff Instructions page. You can find definitions for the fields and controls later on this page.

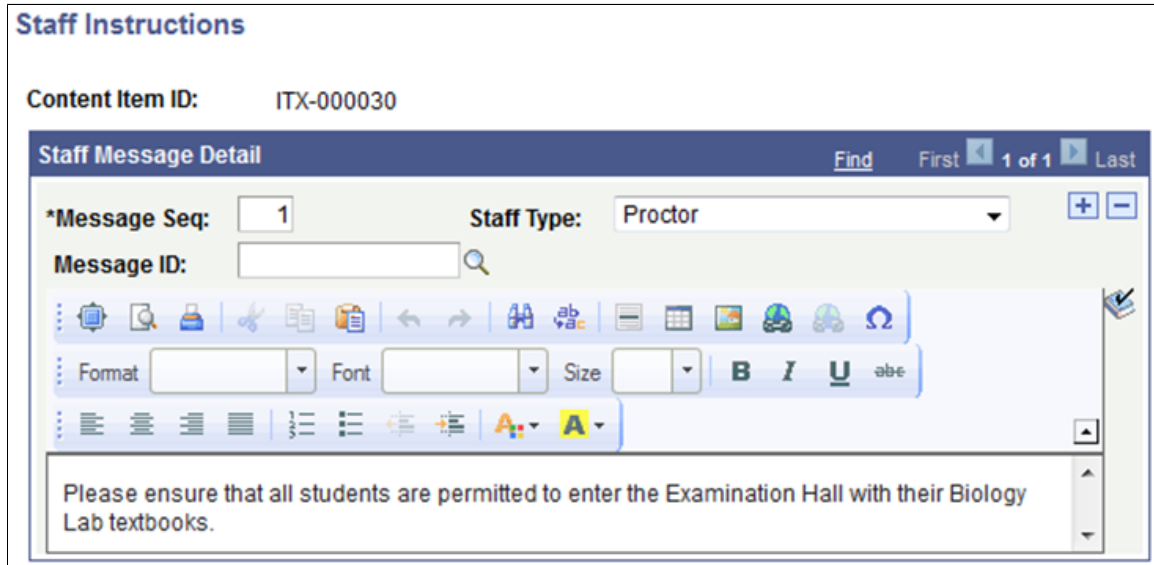

This page applies to *Exam* content types. The **Message ID** options available here are defined during Content Message setup. Only those messages defined as Staff Instructions appear. These requirements can be overridden when the exam is scheduled.

<i>Field or Control</i>	<i>Description</i>
Message Seq (sequence)	The system assigns the sequential number.
Message ID	If you enter a Message ID, that message appears; otherwise you can enter a free-form message.
Staff Type	Indicate to which staff type this instruction is applicable.

Reviewing the Content Tree

Access the Content Tree page (**Curriculum Management > Activity Management > Activity Registry > Activity Registry > Content Tree**).

This example illustrates the fields and controls on the Content Tree page. You can find definitions for the fields and controls later on this page.

The system builds the content tree as you save content types and can be viewed on the Content Conditions page. If a condition was established on the Registry Detail page you see it with the Select Nbr appended to the description and the Or conditions inserted into the condition children. In the above example the condition *Lab* was inserted as a parent to *Lab Assignments 1, 2, 3 and 4*. The condition was built indicating that the student must select and complete two of the lab assignments. Exam sections—the number defined on the Exam content type—is inserted on the Activity Generator component.

Refer to the field descriptions for the Registry Detail page, as needed. Here are some fields that are unique to this page:

Field or Control	Description
Display Item ID	Select this check box to display the Content Item ID in the content tree.
Item Details Icon 	Select the Items Detail icon to transfer to the corresponding row on the Registry Content Detail page.
Default	This check box appears on the child items of a condition. Indicate whether students should automatically be assigned certain conditional items. If items are indicated as the default (s) then these items carry an assigned status on the student's IAM. Students, though, have the option to change these assigned values in self service.

Setting Up Anonymous Grading

Before going through this section, make sure:

- You run the Entity Sync process whenever you make changes to entities. For information about running this process, see [Maintaining Campus Solutions Entities on MOS \(Doc ID 1546057.1\)](#).
- You run the data manipulation scripts (DMS) before you use anonymous grading for the first time. For information on using DMS, see [upd939729_details.pdf](#) in the `upd939729_install` folder of the release image.

Pages Used to Set Up Anonymous Grading

<i>Page Name</i>	<i>Definition Name</i>	<i>Navigation</i>	<i>Usage</i>
Academic Institution 9	SSR_INST_PE	Set Up SACR > Foundation Tables > Academic Structure > Academic Institution Table > Academic Institution 9	<p>Enable anonymous grading at the academic institution level. You can configure the display options for Activity Roster, AM Workcenter, and Individual Activity Manager.</p> <p>The academic institution default settings are also used for academic career and academic organization unless you override the settings at the career and organization level.</p> <p>See “Enabling Program Enrollment and Activity Management Defaults” (Campus Solutions Application Fundamentals).</p>
Installation Student Admin	INSTALLATION_SA	Set Up SACR > Install > Student Admin Installation > Installation Student Admin	<p>Enable anonymous grading, and set the length of the anonymous ID.</p> <p>See “Selecting Student Administration Installation Options” (Campus Solutions Application Fundamentals).</p>
Inclusion Types	SSR_AC_INCLTYPE	Curriculum Management > Activity Management > Setup > Inclusion Types	<p>Activate inclusion types to be used in the anonymous grading. The setting of anonymous grading on this page determines whether it is used and displayed in Activity Management.</p> <p>See Defining Inclusion Types.</p>
Activity Definition	SSR_AC_ITEMTYPE	Curriculum Management > Activity Management > Setup > Activity Definition	<p>Set which content types can use anonymous grading.</p> <p>See Defining Activity Definitions.</p>

Page Name	Definition Name	Navigation	Usage
Registry Detail	SSR_AC_REG_DTL	Curriculum Management > Activity Management > Activity Registry > Activity Registry > Registry Detail	Override the anonymous grading defaults for the activity registry. The activity registry inherits the anonymous grading settings from the Academic Institution, Academic Career, or Academic Organization. See Defining Registry Details .
Activity Manager	SSR_ACM_MAIN	Curriculum Management > Activity Management > Organize and Manage > Activity Manager	Configure settings for anonymous grading at the activity level. See Managing Content Tree Activities .
Anonymous ID Security	SSR_ANID_SCRTY_PG	Set Up SACR > Security > Secure Student Administration > User ID > Anonymous ID Security	Configure access to anonymous IDs. See Configuring Access to Anonymous IDs .
Anonymous ID Search	—	Records and Enrollment > Individual Activity Manager > Anonymous ID Search	Validate the anonymous IDs of students against the student ID and name.

Related Links

“Defining Academic Organizations” (Campus Solutions Application Fundamentals)

“Defining Academic Careers” (Campus Solutions Application Fundamentals)

[Generating Anonymous IDs](#)

Configuring Access to Anonymous IDs

Access Anonymous ID Security page (**Set Up SACR > Security > Secure Student Administration > User ID > Anonymous ID Security**).

This example illustrates the fields and controls on the Anonymous ID Security page.

Anonymous ID Security

User ID AADAMS Name Adams,Andrew

Security Access

*Access to Anonymous ID Look-up page

*Access to Student's ID & Names in Activity Roster

*Access to Student's ID & Names in AM Workcenter

Use this page to determine the level of access to anonymous IDs that a particular user is allowed. For example, you can allow an instructor to access only anonymous IDs but not the student ID or name in Workcenter or Activity Roster.

The access you set up on this page is not a requirement to be able to use the anonymous grading feature. Oracle recommends to limit access to anonymous IDs to only a system administrator or super user.

Validating Anonymous IDs

Access the Anonymous ID Search page (**Records and Enrollment > Individual Activity Manager > Anonymous ID Search**).

Use this page to check the anonymous IDs of students against their student ID and name. This page displays the anonymous IDs assigned to each student per activity.

<i>Field or Control</i>	<i>Description</i>
ID	Enter or search for the student ID against which you want to validate the anonymous ID.
Anonymous ID	Enter the anonymous ID of the course against which you want to validate a student ID or name.
Anonymous ID Type	Select the anonymous ID type: course or resit.
Exam Only Course	Select to limit your search to exam-only courses.

Setting Up Activity Management Throughout Campus Solutions

Additional academic structure setup — throughout core Campus Solutions — is necessary to support Activity Management. This section discusses how to:

- Define various Activity Management installation options.
- Enable Activity Management and set up activity management defaults.

- Set up EOCs.

Define Various Activity Management Installation Options

Use the Installation Student Administration page to define activity and result roster item settings.

See “Selecting Student Administration Installation Options” (Campus Solutions Application Fundamentals)

Enabling Activity Management and Setting Up Activity Management Defaults

Use the Academic Institution 9 page to enable Activity Management and set up default values.

When entering results in the Individual Activity Manager, Activity Roster and the Activity Management Workcenter, it is now possible to control whether or not results can be deleted in IAM, and whether or not the results can be updated in IAM, Roster and Workcenter. The control is based on the type of result entered or calculated.

- Non Calculated Result (manually entered result)
- Late Penalty Calculated Result
- Resit Calculated Result
- Other Calculated Result
- Result Scale Conversion Options

See “Defining Academic Institutions” (Campus Solutions Application Fundamentals)

Setting Up EOCs

Use the Offerings page to define EOC requirements on the course catalog.

See [Creating Course Offerings](#)

Chapter 16

Setting Up Research Tracking

Setting Up Research Tracking

This section discusses how to:

- Set up Student Administration options.
- Set up research tracking options for academic programs.
- Set up research tracking options for academic plans.
- Set up research status codes.
- Set up demographic data usage.
- Set up consumption load.
- Set up consumption actions for program actions.
- Use Common Attribute Framework for research tracking.

Pages Used to Set Up Research Tracking

<i>Page Name</i>	<i>Definition Name</i>	<i>Navigation</i>	<i>Usage</i>
Installation Student Admin	INSTALLATION_SA	Set Up SACR > Install > Student Admin Installation > Installation Student Administration	Specify the optional consumption model to use and monitor and, if necessary, update the Last Candidate Number and Last Service Request Number settings.
Academic Program – Research Processing Options	SSR_RS_PROG_SETUP	Set Up SACR > Foundation Tables > Academic Structure > Academic Program Table > Research Processing Options	Identify an academic program as research-enabled and specify other information about such programs.
Academic Plan – Research Processing Options	SSR_RS_PLAN_SETUP	Set Up SACR > Foundation Tables > Academic Structure > Academic Plan Table > Research Processing Options	Identify an academic plan as research-enabled and specify other information about such plans.

Page Name	Definition Name	Navigation	Usage
Process Status Codes	SSR_RS_STATUS_TYPE	Set Up SACR > Product Related > Student Records > Research Management > Process Status Codes	Set up status codes.
Demographic Data Use	SSR_RS_DEMSETUP	Set Up SACR > Product Related > Student Records > Research Management > Demographic Data Use > Demographic Data Use	Set up the address, email, and telephone usage to be associated with the Research module.
Research Consumption Load Setup	SSR_RS_CONSLOAD	Set Up SACR > Product Related > Student Records > Research Management > Research Consumption Load > Research Consumption Load Setup	Set up consumption load.
Program Action Process Setup	SSR_PRGRSN_DTL	Set Up SACR > Product Related > Student Records > Program Action > Program Action Process Setup	Set up automatic insertion of consumption rows for program action/action reasons entered in Student Program/Plan.

Setting Up Student Administration Options

Access the Installation Student Admin page (**Set Up SACR > Install > Student Admin Installation > Installation Student Administration**).

See “Selecting Student Administration Installation Options” (Campus Solutions Application Fundamentals).

Setting Up Research Tracking Options for Academic Programs

Access the Academic Program – Research Processing Options page (**Set Up SACR > Foundation Tables > Academic Structure > Academic Program Table > Research Processing Options**).

This example illustrates the fields and controls on the Academic Program – Research Processing Options page. You can find definitions for the fields and controls later on this page.

The system automatically identifies research candidates based on applying for admission into, or being active in, a research-enabled academic program or academic plan. This section and the following section discuss how this is set up.

Field or Control	Description
Use Research Processing	Select this check box to identify the academic program as being research-enabled. All processing rules that determine if a research candidate is eligible based on the academic program are determined by this field. In addition, if the check box is selected, the other fields on the page can be edited. If the check box is deselected, all the settings on the page are reset.

Consumption Controls

This setup determines what appears on the Candidature Details page in Admissions and on the Consumption and Submission page in the Candidate Management component.

See:

- [Updating Candidate Management Data Using Admissions Components](#)
- [Tracking Consumption and Submission](#)

Field or Control	Description
Consumption Model	The option that was selected on the Installation Student Admin page appears here by default but you can change it. See Setting Up Student Administration Options .
Candidacy Duration	Use this group box to indicate the maximum amount of time that a candidate is assigned to submit a thesis for review. The Days field is available only if the Consumption Model option is <i>Days</i> .
Consumption Load	Select a Consumption Load value. The related value then appears in the Consumption Rate field. Values are defined on the Research Consumption Load Setup page. See Setting Up Consumption Load .
Early Submission % (early submission percentage)	Enter a percentage (of the time allocated to complete the thesis) to indicate when a candidate can first submit his or her thesis for evaluation (Early Submission Date).

Thesis Examination Controls

Field or Control	Description
Evaluation Category	An Evaluation Management attribute which is used when Student Evaluation records are created for candidates for thesis evaluation. See: <ul style="list-style-type: none"> • “Understanding Evaluation Management” (Campus Community Fundamentals) • “Defining Evaluation Categories” (Campus Community Fundamentals)

Field or Control	Description
Evaluation Code	<p>The Evaluation Code field can be updated only after the Evaluation Category field is selected.</p> <p>This value identifies the thesis evaluation code (effectively the <i>evaluation scheme</i>) to be applied to this program, so that all candidates in this program are evaluated against the same collection of various rating schemes and components specified in this scheme when their Student Evaluation instance is created. This field prompts only on evaluation codes associated with the Evaluation Category value.</p>
Intent to Submit Required	<p>Indicates that candidates are required to formally notify the university of their intention to submit their theses for examination by lodging a <i>Notice Of Intention To Submit</i> form prior to submission. The check box is selected by default.</p> <p>The Exam Initiated check box on the Thesis Submission - Evaluation page can be selected only if the Intent to Submit Required check box is selected here.</p> <p>See Entering Thesis Evaluation.</p>
Submit Notice Offset (Days)	<p>This field defines when communications are sent to the candidate, supervisor, and any other interested parties to inform them that the candidature will soon end and that the candidate is required to submit the thesis. If the Intent to Submit Required check box has been selected, then the request for the submission of this notice is also sent.</p> <p>The value of the field is an integer between 0 and 999. Though no process checks the value in this field, generally you would use this value to alert the candidate, supervisor, and research administrator that the thesis submission deadline is imminent using a 3Cs Communication email. The default value for this field is 90 (approximately three months).</p>
Exam Return Default (Days)	<p>This information-only field indicates how long (number of days) after the thesis has been submitted for examination and sent to an examiner that the examiner's report is due. The value can include integers from 1 to 999.</p>
Minimum Examiners	<p>Enter the minimum number of examiners that must examine the thesis for the examination to be deemed valid. Valid values are whole numbers 2 through 9. This field is information-only and has no default value. You must specify a value.</p>

Field or Control	Description
Maximum Internal Examiners	Enter the maximum number of internal examiners permitted to examine a thesis for the examination to be deemed valid. The field can contain a single digit, and a value of 0 indicates that no internal examiners are permitted. The field must contain a value and defaults to 0 if no value is present when the page is saved.
Maximum Number of Submissions	Enter the maximum number of submissions that are allowed for a thesis. When a user clicks the Resubmit Thesis button on the Thesis Management page, the value that is entered here is used to determine if the maximum has been exceeded. See Entering Thesis Details .
Exam Certificate Required	Select this check box to indicate that an examination certificate is required. If this check box is selected, users must enter a value in the Exam Supervisor Approval and Certificate Final Approval fields on the Thesis Management – Evaluation page. See Entering Thesis Evaluation .
Transcript Level	Select the Transcript Level at which you want the Thesis Examination information to be published.

Related Links

“Defining Academic Programs” (Campus Solutions Application Fundamentals)

Setting Up Research Tracking Options for Academic Plans

Access the Academic Plan – Research Processing Options page (**Set Up SACR > Foundation Tables > Academic Structure > Academic Plan Table > Research Processing Options**).

This example illustrates the fields and controls on the Academic Plan — Research Processing Options page. You can find definitions for the fields and controls later on this page.

Academic Plan Table	Print Options	Taxonomy	Owner	Research Processing Options	Advisement
Academic Institution:	PSUNV	PeopleSoft University			
Academic Plan:	MEDRS1	Animal Testing Research 1			
Find View All First 1 of 1 Last					
Effective Date:	01/01/1900	Status:	Active		
<input checked="" type="checkbox"/> Use Research Processing					
Consumption Controls					
Consumption Model			Candidacy Duration		
<input type="radio"/> None <input checked="" type="radio"/> Days			Days: <input type="text" value="900"/>		
Consumption Load:	<input type="text" value="FULL"/> Full Time	Consumption Rate:	1.00		
Early Submission %:	<input type="text" value="80"/>				
Thesis Examination Controls					
Evaluation Category:	<input type="text" value="THESIS"/>	*Submit Notice Offset (Days):	<input type="text" value="30"/>		
Evaluation Code:	<input type="text" value="MEDTHESIS"/>	Exam Return Default (Days):	<input type="text" value="0"/>		
Minimum Examiners:	<input type="text" value="2"/>	Maximum Internal Examiners:	<input type="text" value="2"/>		
<input checked="" type="checkbox"/> Intent to Submit Required		*Maximum Number of Submissions:	<input type="text" value="3"/>		
<input checked="" type="checkbox"/> Exam Certificate Required					
Transcript Level:	<input type="text" value="Print on Official"/>				

This page is identical to the Research Processing Options page in the Academic Program Table component. Refer to the documentation in the previous section.

Note: When a research candidate is assigned an academic program and academic plan which have both been enabled for research processing, the academic plan settings are used.

Related Links

“Defining Academic Plans” (Campus Solutions Application Fundamentals)

Setting Up Research Status Codes

Access the Process Status Codes page (Set Up SACR > Product Related > Student Records > Research Management > Process Status Codes).

This example illustrates the fields and controls on the Process Status Codes page. You can find definitions for the fields and controls later on this page.

Process Status Codes

Academic Institution: PSUNV PeopleSoft University

Group Code: SERV

Effective Date: 01/01/1900 Status: Active

Description: Service Request Processing

System Usage: Requests

*Status	*Description	*Short Description	Self Service Description	*Status Level
RECVD	Request Received	Received	Candidate created new request	00
REVIEW	Review in Progress	Review	Provide more information	10
DENY	Request Denied	Deny	Admin denied request	20
APPROV	Request Approved	Approved	Admin approved request	30

User-defined status codes are used in the Candidate Management, Thesis Management, Service Request, Candidate Center, and the Academic Project Management components to track the state of the different business elements: the research topic, supervisor selection, consumption and submission dates, thesis processing, user-defined business assignments, and service requests. Use this setup component to define all status values that a school uses to manage its business processes.

Field or Control	Description
Description	Enter the description of the set of status codes you are creating.

System Usage

This setting is used by the system to identify the page in the Candidate Management component, the Thesis Management component, the Service Requests self-service components for students and administrators, the Candidate Center or the Student Project Management component on which the set of status code values are used. The field can contain one of the following values:

System Usage Value	Pages Used
Topic	Candidate Management, Research Topic page Admissions: Add/Maintain Applications page Candidate Center, Topic Details page

System Usage Value	Pages Used
Supervisor	<p>Candidate Management, Supervisors page</p> <p>Admissions: Add/Maintain Applications page</p> <p>Student Project Management, Additional Details page (Supervisors group box)</p> <p>Candidate Center, Supervisor Details page</p>
Consumption	<p>Candidate Management, Consumption and Submission page</p> <p>Admissions: Add/Maintain Applications page</p> <p>Candidate Center, Consumption/Submission Details page</p>
Assignment	<p>Candidate Management, Other Assignments page</p> <p>Admissions: Add/Maintain Applications page</p> <p>Student Project Management, Additional Details page (Supervisors group box)</p> <p>Candidate Center, Assignment Details page</p>
Thesis	<p>Thesis Management, Thesis Submission page</p> <p>Candidate Center, Thesis Details page</p>
Requests	<p>Service Request Management page</p> <p>Self Service, Requests, My Service Requests page (for students)</p> <p>Service Request Dashboard (Service Requests pagelet for administrators)</p>
Project	<p>Student Project Management, Project Management page</p>

Status Codes

<i>Field or Control</i>	<i>Description</i>
Status	<p>Use this value to track the business process. The field is alphanumeric and is required.</p> <hr/> <p>Note: You can assign a status code to trigger a 3C communication event from the Candidate Management and Thesis Management components. 3C Engine PeopleCode function calls have been added to these components to trigger online communication events. Adding the field SSR_RS_STATUS from the Edit Table SSR_RS_STATUS_D to the Trigger Prompt Table setup allows this functionality.</p> <hr/> <p>See “Defining 3C Engine Triggers” (Campus Community Fundamentals).</p>
Description	Enter the status description that is displayed on the Service Requests self-service component pages for administrator.
Self Service Description	Enter the status description that is displayed on the Candidate Center and Service Requests self-service component pages for students. This allows for a more student-friendly description than the internal value used by administrators.
Status Level	A numeric value that ranks the status code values. The greater the number, the higher the ranking of the code. The default value is 0. These status level codes are used to manage student update thresholds in Research Service Requests, and to determine whether to update candidate and thesis data from the Candidate Center.

Related Links

“Creating and Updating Service Requests (Candidates)” (Campus Self Service)

“Administering Service Requests (Administrators)” (Campus Self Service)

Setting Up Demographic Data Usage

Access the Demographic Data Use page (**Set Up SACR > Product Related > Student Records > Research Management > Demographic Data Use > Demographic Data Use**).

Use this page to set up how a person’s address, email, and telephone information are to be handled by the research module. Currently, the Research Topic Setup - Contact information uses this setup, but additional research features will be added as they are developed.

See [Associating Organizations and Contacts with Research Topics](#).

Related Links

“Establishing Address Usages” (Campus Community Fundamentals)

“Establishing Phone Usages” (Campus Community Fundamentals)

Setting Up Consumption Load

Access the Research Consumption Load Setup page (**Set Up SACR > Product Related > Student Records > Research Management > Research Consumption Load > Research Consumption Load Setup**).

This example illustrates the fields and controls on the Research Consumption Load Setup page. You can find definitions for the fields and controls later on this page.

Research Consumption Load Setup				
Academic Institution:	PSUNV PeopleSoft University			
Consumption Load:	FULL			
*Effective Date:	01/01/1900	*Effective Status:	Active	
*Description:	Full Time			
*Short Description:	Full			
*Consumption Rate:	1.00			

Use this page to set up the valid consumption load values at the institution. Consumption load defines the rate at which a candidate conducts his or her research. This is similar to the principle of academic load, but is not based on enrollment. A consumption rate of 1.0 implies that 100 percent of the candidate’s time is spent performing research and related activities. The consumption rate directly impacts the length of time a candidate is projected to complete the research and submit the thesis for evaluation. The values that you set up here are used on the Research Processing Options page in the Academic Program Table and Academic Plan Table components, as well as in the Candidature Details page in Admissions and in the Candidate Management component.

See:

- [Setting Up Research Tracking Options for Academic Programs](#)
- [Setting Up Research Tracking Options for Academic Plans](#)

Setting Up Consumption Actions for Program Actions

Access the Program Action Process Setup page (**Set Up SACR > Product Related > Student Records > Program Action > Program Action Process Setup**).

This example illustrates the fields and controls on the Program Action Process Setup page. You can find definitions for the fields and controls later on this page.

Program Action Process Setup

Academic Institution: PSUNV PeopleSoft University

Process: Research Consumption

*Effective Date: 01/01/1900
*Status: Active

#	*Program Action	Action Reason	All Other Reasons	*Consumption Action	*Status	Description	+	-
1	LEAV		<input checked="" type="checkbox"/>	Do Nothing	LOA	Leave of Absence		
2	LEAV	SUSP	<input type="checkbox"/>	Suspend	LOA	Leave of Absence		
3	PLNC		<input checked="" type="checkbox"/>	Do Nothing	PLNC	Plan Change		
4	PRGC		<input checked="" type="checkbox"/>	Suspend	PRGC	Program Change		
5	RLOA		<input checked="" type="checkbox"/>	Do Nothing	RLOA	Return from Leave of Absence		
6	RLOA	RSCH	<input type="checkbox"/>	Resume	RLOA	Return from Leave of Absence		
7	WADM		<input checked="" type="checkbox"/>	Do Nothing	ACTIVE	Active		
8	WADM	NRSP	<input type="checkbox"/>	Suspend	HOLD	On Hold		

Use this page to define Program Action/Action Reason combinations which can trigger an update of the student’s candidate information from the Student Program/Plan component.

Enter a Consumption Action and Status for a Program Action/Action Reason. When the Program Action/Action Reason combination is saved in the Student Program Plan component, the related Consumption Action and Status values are automatically inserted in the SSR_RS_CONSMPTN record (Consumption and Submission page in the Candidate Management component).

You can use this feature to automatically suspend and resume the consumption process. This action is performed only if the Days consumption model has been selected for the candidate.

Note: This is an optional feature and should be carefully implemented after an analysis of your business requirements.

Field or Control	Description
Program Action	You must select a value. Values are defined on the Program Action Table page.
Action Reason	The available values are those defined on the Program Action Reason Table page.
All Other Reasons	Select this check box to identify how Program Action / Action Reason values other than those specifically defined should be treated.

Field or Control	Description
Consumption Action	Indicates how the consumption calculation process is affected by the Program Action and Action Reason. The available values are: <i>Suspend</i> (the calculation), <i>Resume</i> (from a previously suspended state), and <i>Do Nothing</i> (no effect).
Status	The available values are the Status Codes defined for the System Usage Value of <i>Consumption</i> on the Process Status Codes page.

See [Tracking Consumption and Submission](#).

Using Common Attribute Framework for Research Tracking

The Common Attribute Framework enables you to define a common attribute and add the common attribute as a data field to any Campus Solutions page. A user can then enter a value on the page for the data field.

Use the Common Attribute Framework to create attributes for the Research Tracking feature. Create attributes using the Common Attribute component (Set Up SACR, Common Definitions, Common Attributes Setup, Common Attribute) and then use the Record Context component (Set Up SACR, Common Definitions, Common Attributes Setup, Record Context) to associate attributes with a particular record.

See:

- “Defining a Common Attribute” (Campus Community Fundamentals)
- “Associating a Common Attribute to a Record” (Campus Community Fundamentals)

This table lists the delivered record contexts for Research Tracking, the attributes, and the pages with which the record contexts are associated.

Record Context	Attribute	Page
SSR_RS_TPCSETUP	Topic Setup Attributes	Research Topic Setup - Additional Information
SSR_RS_TOPIC	Research Topic Attributes	Candidate Management – Research Topic
SSR_RS_SUPRVSR	Supervisor Attributes	Candidate Management – Supervisors
SSR_RS_CONSMPTN	Consumption Attributes	Candidate Management - Consumption and Submission
SSR_RS_OTHRQDTL	Other Assignments Attributes	Candidate Management - Other Assignments

<i>Record Context</i>	<i>Attribute</i>	<i>Page</i>
SSR_RS_THESIS	Thesis Attributes	Thesis Management – Additional Information
SSR_ADMN_DTL	Administrator Attributes	Administrator Profile Management

The pages are discussed in later topics related to setting up Research Tracking or in topics related to managing Research Tracking.

Note: Attributes defined for the Thesis Management, Supervisors, and Other Assignments pages are the same Common Attribute Framework records used in the Student Project Management component. Any attributes that you add appear in both the Student Project and Research Management areas. To configure attributes to be used exclusively for either the Research or Academic Project pages, use the Common Attribute Framework attribute filter class (SSR_RS_RESEARCH:CAF_Filters:ResearchAttributeFilter) and work entities (ResearchManagement, AcademicProject) to configure the attributes in the Common Attribute Framework Record Context setup page.

Setting Up Research Topics

This section discusses how to:

- Define research topic categories.
- Define research topics.
- Review available research supervisors.
- Associate organizations and contacts with research topics.
- Enter additional information.
- Enter Attachments.
- Set up self-service research topic search.

Pages Used to Define Research Topics

<i>Page Name</i>	<i>Definition Name</i>	<i>Navigation</i>	<i>Usage</i>
Research Topic Category	SSR_RS_TOPICCAT	Set Up SACR > Product Related > Student Records > Research Management > Research Topic Categories > Research Topic Category	Create research topic categories for assignment to research topics.

Page Name	Definition Name	Navigation	Usage
Topic Setup	SSR_RS_TOPIC_SETUP	Set Up SACR > Product Related > Student Records > Research Management > Research Topic Setup > Topic Setup	Create the research topics that are offered at the institution. Provide information about research topics, including a description and the academic programs and plans to which they are associated.
Research Topic Setup – Available Supervisors	SSR_RS_TOPIC_SUP	Set Up SACR > Product Related > Student Records > Research Management > Research Topic Setup > Available Supervisors	View all available research supervisors who have academic programs or academic plans that match the research topic.
Research Topic Setup – Organization and Contacts	SSR_RS_ORG_CONTACT	Set Up SACR > Product Related > Student Records > Research Management > Research Topic Setup > Organization and Contacts	Associate one or more academic or external organization(s) with the research topic and set up contacts for a research topic.
Research Topic Setup – Add Organization	SSR_RS_TPC_ORG	Click the Add Organization button on the Organization and Contacts page.	Select organizations to associate with a research topic.
Research Topic Setup – Academic Organization Details	SSR_RS_TPC_ACADORG	Click the View Details link on the Organization and Contacts page.	View details about academic organizations that are associated with a research topic.
Research Topic Setup – External Organization Details	SSR_RS_TPC_EXTORG	Click the View Details link on the Organization and Contacts page.	View details about external organizations that are associated with a research topic.
Research Topic Setup – Add Contact	SSR_RS_TPC_ADDCNCT	Click the Add Contact button on the Organization and Contacts page.	Select contacts to associate with a research topic.
Research Topic Setup – Contact Details	SSR_RS_TPC_CNCT	Click the Contact Details link on the Organization and Contacts page.	View details about contacts that are associated with a research topic.
Research Topic Setup - Additional Information	SSR_RS_TOPICST_CA	Set Up SACR > Product Related > Student Records > Research Management > Research Topic Setup > Additional Information	Enter and review Common Attribute fields associated with the research topic. This page appears only if Common Attribute fields have been created using the Common Attribute Framework.

Page Name	Definition Name	Navigation	Usage
Research Topic Setup – Attachments	SSR_RS_TOPICST_ATT	Set Up SACR > Product Related > Student Records > Research Management > Research Topic Setup > Attachments	Add one or more attachments for a research topic.

Defining Research Topic Categories

Access the Research Topic Category page (**Set Up SACR > Product Related > Student Records > Research Management > Research Topic Categories > Research Topic Category**).

Research topic categories are user-defined attributes that can be assigned to research topics. For example, you can create a category to group research topics that belong to a common organization or funding source.

Field or Control	Description
Status	Select <i>Active</i> to make the topic category available for use in the Topic Setup page.
Display in Self Service	<p>If you select this check box:</p> <ul style="list-style-type: none"> The Category Name can be used as search criteria on the Search for Research Topics self-service page. Enter a name for the category on the Topic Setup page. Category data (defined on the Topic Setup page) displays in the self-service page for the topic if the Display check box is selected for CATEGORY on the Fields Setup page. <p>See Setting Up Self-Service Research Topic Search</p> <p>See Defining Research Topics</p>

Defining Research Topics

Access the Research Topic Setup – Topic Setup page (**Set Up SACR > Product Related > Student Records > Research Management > Research Topic Setup > Topic Setup**).

This example illustrates the fields and controls on the Research Topic Setup page. You can find definitions for the fields and controls later on this page.

The screenshot shows the 'Topic Setup' page with the following details:

- Academic Institution:** PSUNV PeopleSoft University
- Topic Code:** CR0001
- Effective Date:** 07/12/2000
- Status:** Active
- Display in Self Service:**
- Description:** Increasing the efficiency of radio waves.
- Academic Program:** ELECE Electrical Engineering
- Academic Plan:** (empty)
- Academic Sub-Plan:** (empty)
- Long Description:** Increasing the efficiency of radio waves. Part of the Cancer Research Project.
- Number of Positions:** 5
- Number of Applicants:** 12

Category Information Table:

*Category	Description	Display in Self Service	Category Name
1 PJ	Project	<input type="checkbox"/>	Cancer Project 334455
2 SP	Sub Project	<input type="checkbox"/>	334455.1

Facilities Table:

*Facility ID	Description	Facility Type	Location Code	Address	Display in Self Service
1 ANGE0125A	Angel 125A	Laboratory	PSCSHCDA		<input checked="" type="checkbox"/>

Field or Control	Description
Display in Self Service	Select if you want the system to display this topic on the Search for Research Topics self-service page.

The Academic Program, Academic Plan, and Academic Sub-Plan fields on the Topic Setup page are used to control whether a topic is available to a research candidate. Because of the defined relationships between the fields, the page validates entries to prevent an invalid combination of values. A research topic can be defined as valid for:

- An academic program only.
- An academic program and academic plan combination.
- An academic plan and academic sub-plan combination.
- An academic program, academic plan, and academic sub-plan combination.

Field or Control	Description
Academic Program	Select the academic program to which the research topic belongs.
Academic Plan and Academic Sub-Plan	Select the academic plan and sub-plan (if any) to which the research topic belongs.
Long Description	Enter a description of the research topic.
Number of Positions and Number of Applicants	Enter the total number of available positions and maximum number of applicants for the research topic. These fields are informational only.

Category Information

Field or Control	Description
Category	The Category Code assigned to the topic. The Category value is optional.
Display in Self Service	<p>This check box is display-only on the Topic Setup page.</p> <p>Use the Display in Self Service check box on the Research Topic Category page to indicate whether category information should display on the Search for Research Topics self-service page.</p> <p>See Defining Research Topic Categories</p> <p>See Setting Up Self-Service Research Topic Search</p>
Category Name	Use this optional field to provide additional information to identify the assigned category.

Facilities

Set up information about the location and facilities used for this research.

See:

- [Defining Buildings, Rooms, and Classroom Facilities](#)
- “Setting Up Locations” (Campus Solutions Application Fundamentals)

Field or Control	Description
Display in Self Service	<p>If the Display check box is selected for FACILITY on the Fields Setup page, and you select this check box, data displays for the topic on the Search for Research Topics self-service page.</p> <p>See Setting Up Self-Service Research Topic Search</p>

Reviewing Available Research Supervisors

Access the Research Topic Setup - Available Supervisors page (**Set Up SACR > Product Related > Student Records > Research Management > Research Topic Setup > Available Supervisors**).

This example illustrates the fields and controls on the Research Topic Setup - Available Supervisors page. You can find definitions for the fields and controls later on this page.

The screenshot displays the 'Available Supervisors' page. At the top, there are navigation tabs: 'Topic Setup', 'Available Supervisors', 'Organization and Contacts', 'Additional Information', and 'Attachments'. Below the tabs, the following information is shown:

- Academic Institution:** PSUNV PeopleSoft University
- Topic Code:** CR0003

A summary bar includes 'Find | View All', 'First 1 of 1', and 'Last' with expand/collapse icons. Below this, the following details are listed:

- Effective Date:** 12/07/2000
- Status:** Active
- Description:** Psychological Effects of Long Term Radiologic Treatment
- Academic Program:** HLTHC Healthcare & Counseling
- Academic Plan:**
- Academic Sub-Plan:**

A table below lists the supervisors:

Personalize Find View All First 1-2 of 12 Last					
Emp ID	Name	Administrator Role Sequence	Affiliation Code	Academic Career	
1 0004	Ovedara,Atif		ALUMN_TMPL		
2 FA0333	Byron,Alion		ALUMN_TMPL		

The Available Supervisors page is display-only.

See [Setting Up Research Administrators](#)

Associating Organizations and Contacts with Research Topics

Access the Research Topic Setup - Organizations and Contacts page (**Set Up SACR > Product Related > Student Records > Research Management > Research Topic Setup > Organization and Contacts**).

This example illustrates the fields and controls on the Research Topic Setup - Organizations and Contacts page . You can find definitions for the fields and controls later on this page.

Organization

You can associate external organizations or academic organizations with a research topic.

External organizations are defined in the Organization Table (Campus Community, Organization, Create/Maintain Organizations, Organization Table).

See “Understanding Organizations” (Campus Community Fundamentals).

Academic organizations are defined in the Academic Organization Table (Setup SACR, Foundation Tables, Academic Structure, Academic Organization Table).

See “Defining Academic Organizations” (Campus Solutions Application Fundamentals).

Field or Control	Description
Description	Click this link to access the Organization Table (EXT_ORG_TABLE) page or the Academic Organization Table (ACADEMIC_ORG_TBL) page. The link is available only for users who are authorized to access the relevant component.

Field or Control	Description
View Details	<p>Click this link to access a display only page (External Organization Details page or Academic Organization Details page). This link allows users who do not have security access to the Organization Table or Academic Organization Table components to view the relevant organization data.</p> <p>See “Securing Academic Organizations” (Campus Solutions Application Fundamentals)</p>

Add Organization

When you click the Add Organization button, you are taken to the Add Organization (SSR_RS_TPC_ORG) page:

Depending on the option that you select, the External Organization or Academic Organization field appears and you can select the organization with which to associate the research topic.

Contact

You can also associate contacts with a research topic. Contacts must have an EmplID in the system.

Field or Control	Description
Contact Details	<p>Click this link to access the Contact Details (SSR_RS_TPC_CNCT) page and view address, email, and phone details for the contact. The Demographic Data Usage settings determine the contact details to display.</p>
Display in Self Service	<p>If the Display check box is selected for CONTACT, CONTACTEMAIL and CONTACTPHNBR on the Fields Setup page and you select this check box, then the contact name, email and phone data displays for the topic on the Search for Research Topics self-service page.</p> <p>See Setting Up Self-Service Research Topic Search</p>
Display in Self Service	<p>Select this check box to indicate that candidates can view contact details in the Research Topic Search self-service page.</p>

Add Contact

When you click the Add Contact button, you are taken to the Add Contact (SSR_RS_TPC_ADDCNCT) page:

Field or Control	Description
ID	When you select an ID, the address, phone, and email details appear here based on the address, phone, and email types that have been set up on the Demographic Data Use page. See Setting Up Demographic Data Usage
Active	Use the Active check box to indicate whether the contact is active or inactive.

Entering Additional Information

Access the Research Topic Setup – Additional Information page (**Set Up SACR > Product Related > Student Records > Research Management > Research Topic Setup > Additional Information**).

This example illustrates the fields and controls on the Research Topic Setup – Additional Information page. You can find definitions for the fields and controls later on this page.

The screenshot displays the 'Additional Information' tab of the Research Topic Setup page. At the top, there are navigation tabs: 'Topic Setup', 'Available Supervisors', 'Organization and Contacts', 'Additional Information' (selected), and 'Attachments'. Below the tabs, the following information is displayed:

- Academic Institution:** PSUNV PeopleSoft University
- Topic Code:** CR0003
- Effective Date:** 12/07/2000
- Status:** Active
- Description:** Psychological Effects of Long Term Radiologic Treatment
- Academic Program:** HLTHC Healthcare & Counseling
- Academic Plan:**
- Academic Sub-Plan:**

A 'Local Attributes' section is shown below, featuring a search bar with 'Find | View All' and a pagination indicator 'First 1 of 1 Last'. The attribute list includes:

- *Attribute: EU Project ID (dropdown menu)
- Value: 334455.3 (text input field)

Use this page to enter and review Common Attribute fields associated with the research topic.

This page appears only if common attributes have been created for the research topic setup using the Common Attribute Framework.

See [Using Common Attribute Framework for Research Tracking](#)

See “Defining a Common Attribute” (Campus Community Fundamentals)

“Associating a Common Attribute to a Record” (Campus Community Fundamentals)

Entering Attachments

Access the Research Topic Setup – Attachments page (**Set Up SACR > Product Related > Student Records > Research Management > Research Topic Setup > Attachments**). These attachments are made available for viewing in the Research Topic Search self-service page.

<i>Field or Control</i>	<i>Description</i>
Visible to Student	Select to set whether or not the attachment is visible to students through the Research Topic Search self-service page. By default, attachments added to administrator pages are not visible to students.

Setting Up Self-Service Research Topic Search

The Search for Research Topics page is available in Self Service if you select the Display in Self Service check box on the Topic Setup page.

Here is an example of the Search for Research Topics page:

This example illustrates the fields and controls on the Search for Research Topics page example. You can find definitions for the fields and controls later on this page.

Search for Research Topics

Institution: PeopleSoft University **Search:** RT0004 search

[Advanced Search](#)

Research Topics

[Expand All](#) [Collapse All](#)

▼ RT0004 Natural NSAIDs developed from the Amazon rain forest

New drugs developed from newly discovered plants of the Amazon rain forests.

Details

Positions: 1	Applicants: 11
Program: Medicine	Plan: Pharmacology
Sub-Plan:	

Categories

- Medical Campus
- European Union

Supervisors

- Cheryl Zen
- Raymond Reynolds

Organizations

- Ranger Incorporated
- Psychopathology

Contacts

- Maryann Hooks
- Phone:** 578/584-2255
- Email:** jhooks@usc.edu

Facilities

Angel 125C	Facility Type: Laboratory
Location: Hacienda	
Address: 4000 Owens Drive Pleasanton, CA 94855	

▼ Attachments

Admissions_Application_Materials.doc	Application Materials	View
--------------------------------------	-----------------------	----------------------

Fields Setup is a Research Management component (SCC_FIELD_SETUP) that is used by Research Tracking to control the display of sections and fields on the Search For Research Topic self-service page. The self-service display settings are provided. Search for Page = Research Topic.

See “Configuring Tasks” (Campus Community Fundamentals)

Here is an example of the Fields Setup page for Research Topic (**Set Up SACR > Product Related > Student Records > Research Management > Fields Setup**):

This example illustrates the fields and controls on the Fields Setup page example for Research Topic. You can find definitions for the fields and controls later on this page.

Fields Setup

Page: Research Topic

Field Name: SSR_RS_NO_APPL

***Description:**

Display

If the Display check box is selected on the Fields Setup page, the section (for example Supervisors) or field (for example Applicants) is displayed on the Search for Research Topic page for *all* topics that are available in Self Service.

Except for a few sections on the self-service page, data (defined in the Topic Setup component) is automatically displayed. If no data exists in Topic Setup, this message is displayed: *There is no Data setup for this Topic*.

You can control the display of data for the Categories, Contacts and Facilities sections at the *individual topic* level. For example, if the Display check box is selected for FACILITY in Fields Setup, but the Display in Self Service check box is not selected in the Facilities section of the Topic Setup page for topic RT0001, Facilities data does not display for RT001 on the self-service page. *There is no Data setup for this Topic* is displayed.

Note: For categories, the Display in Self Service check box is display-only on the Topic Setup page and the display of self-service data is controlled on the Research Topic Category page.

Note: For contacts, the Display in Self Service check box on the Topic Setup–Organization and Contacts page controls the display of the contact name, phone and email address in Self Service. If Display is selected for CONTACT (section), CONTACTEMAIL and CONTACTPHONENBR in Fields Setup and Display in Self Service is selected in Topic Setup for topic RT002, then the contact name, email address and phone number all display in Self Service for RT0002.

See:

- “Searching for Research Topics” (Campus Self Service)
- [Defining Research Topics](#)
- [Defining Research Topic Categories](#)

Setting Up Research Administrators

This section discusses how to:

- Define administrators.
- Define and manage administrator profiles.
- Define supervisor roles.
- Define additional business assignments.

Support is provided to define the following administrator roles:

- Research supervisor
- Thesis evaluator
- Project Supervisor

Pages Used to Set Up Research Administrators

<i>Page Name</i>	<i>Definition Name</i>	<i>Navigation</i>	<i>Usage</i>
Definition	SCC_AFL_TBL	Set Up SACR > Common Definitions > Affiliations > Affiliation Setup > Definition	Define affiliation codes and the hierarchical structure of those codes.
Trigger	SCC_AFL_TRGR	Set Up SACR > Common Definitions > Affiliations > Affiliation Setup > Trigger	Define simple events that trigger the system to determine whether to assign or remove an affiliation.
Academic Institution 10	SSR_ADMN_TYPAFL	Setup SACR > Foundation Tables > Academic Structure > Academic Institution Table > Academic Institution 10	Map affiliation codes to administrator roles.
Administrator Profile Management	SSR_ADMN_DTL	Records and Enrollment > Graduate Research Management > Administrator Profile > Administrator Profile Management	Enter and track administrators. The qualifications of the administrator and approval of the qualifications can be tracked. Academic areas of participation and availability of the administrator is also managed.
Supervisor Roles	SSR_RS_SUPR_TYP	Set Up SACR > Product Related > Student Records > Research Management > Supervisor Roles > Supervisor Roles	Define the valid supervisor roles for the institution.

Page Name	Definition Name	Navigation	Usage
Assignment Type Options	SSR_RS_REQTYP_STUP	Set Up SACR > Product Related > Student Records > Research Management > Assignment Types > Assignment Type Options	Define additional business requirements that can be assigned to research candidates.

Defining Administrators

Use the Affiliation Setup component and the Academic Institution 10 page to define administrators for Research Tracking.

Setting up Affiliation Codes for Research Tracking

The first step in defining administrators (supervisors and evaluators) is to use the Affiliation Setup component to set up affiliations, which can include child affiliations. Select the Root Indicator check box to indicate that the Affiliation Code is at the highest level of the affiliation hierarchy.

For example, you might set up an Affiliation Code of *Supervisor*, select the Root Indicator check box, then select the Children Indicator check box and set up Child Affiliations such as *Internal Supervisor* and *External Supervisor*.

Later you map the *root affiliations* to Supervisor and Evaluator roles on the Academic Institution 10 page.

A sample affiliation is provided for setting up supervisors:

SUPRV_TMPL: PSUNV Research Supervisor: Research Supervisor root affiliation code with child affiliation code PROF_TMPL. PROF_TMPL: PeopleSoft University Professor (Application Class Package ID: SSR_RS_RESEARCH and Trigger: SSR_ADMN_AFFL_DATA_SYNC).

Note: Before you can set up or use Affiliations functionality, your institution must enable Constituent Web Services.

See “Defining Affiliations” (Campus Community Fundamentals)

See [Setting Up Integration Broker For Research Administrator Profile Affiliations](#)

Mapping Affiliation Codes to Administrator Roles

After you set up your Affiliation codes, map the root affiliations to Supervisor and Evaluator roles on the Academic Institution 10 page (Setup SACR, Foundation Tables, Academic Structure, Academic Institution Table, Academic Institution 10).

See “Mapping Affiliation Codes to Administrator Roles” (Campus Solutions Application Fundamentals)

Defining and Managing Administrator Profiles

Access the Administrator Profile Management page (**Records and Enrollment** > **Graduate Research Management** > **Administrator Profile** > **Administrator Profile Management**).

This example illustrates the fields and controls on the Administrator Profile Management page. You can find definitions for the fields and controls later on this page.

Administrator Profile Management

Kate McCarty SR0493

Personalize | Find | [Grid Icon] | [Print Icon]
First 1-2 of 2 Last

Administrator Role	Select	Academic Institution	Administrator Role	Attachments
1	<input checked="" type="checkbox"/>	PeopleSoft University	Research Supervisor	Attachments (0)
2	<input type="checkbox"/>	PeopleSoft University	Project Supervisor	Attachments (0)

Add

Administrator Details

Find | View All First 1 of 1 Last

*Effective Date: [Calendar Icon] *Status: Active [Dropdown Arrow] [+] [-]

Organization Association

Academic Organization External Organization

Academic Organization: [Search Icon] Life Sciences Division

Approval Date: [Calendar Icon] Approver: [Search Icon] David James

Participation Information

Unrestricted

	*Academic Career	Academic Program	Academic Plan	Academic Sub-Plan	Supervision Maximum	Percent of Appointment		
1	<input type="text" value="GRAD"/> [Search Icon]	<input type="text" value="GSCI"/> [Search Icon]	<input type="text" value="MATH-PHD"/> [Search Icon]	<input type="text"/> [Search Icon]	<input type="text"/>	<input type="text"/>	<input type="text"/>	[+] [-]
2	<input type="text" value="MEDS"/> [Search Icon]	<input type="text" value="MEDRF"/> [Search Icon]	<input type="text" value="MEDRF1"/> [Search Icon]	<input type="text"/> [Search Icon]	<input type="text"/>	<input type="text"/>	<input type="text"/>	[+] [-]

Availability

	*Status	*Begin Date	End Date		
1	Available [Dropdown Arrow]	<input type="text" value="01/12/2011"/> [Calendar Icon]	<input type="text" value="31/12/2020"/> [Calendar Icon]	<input type="text"/>	[+] [-]

Transfer To: Go

Use this page to enter and track detailed information about administrators.

Research supervisors for whom a profile exists in the Administrator Profile component can be assigned to individual research candidates in the Candidate Management component (and similarly project supervisors in the Project Management component).

See [Assigning Candidate Supervisors](#)

See [Creating and Managing a Student Academic Project](#)

Evaluators for whom a profile exists in the Administrator Profile component can be assigned to committees for use by the Student Evaluation feature during thesis evaluation. A view (SSR_ADMIN_EVALVW) is used in the Committee Type/Role setup – the view selects evaluators for

whom data has been entered in the Approval Date and Approver fields on the Administrator Profile Management page.

See “Understanding Evaluation Management” (Campus Community Fundamentals)

Field or Control	Description
	For information about the Send Notification button, See Using Online Notifications

Administrator Role

Define all the roles available for an administrator.

Field or Control	Description
Select	Select an administrator role for which to enter and view details in the Administrator Details section. By default, the first role is selected.
Add	Click to add a role to the administrator's profile. The values available in the Affiliation Code field on the Add Administrator Role page are the child affiliation codes (of root affiliation codes) or the root affiliation codes (if no children exist) that are mapped to an administrator role of Research Supervisor, Project Supervisor or Evaluator on the Academic Institution 10 page. See “Mapping Affiliation Codes to Administrator Roles” (Campus Solutions Application Fundamentals)
Copy	When you click Add and enter a value in the Administrator Role field, the Copy button becomes available and you can copy settings from an existing administrator role to the new role.

Note: After you select an Administrator Role, enter the required Administrator Details data and save the page, an affiliation is associated with the person on the Add/Update Affiliations page.

If you change the Administrator Details Status to *Inactive*, the End Date field is populated on the Add/Update Affiliations page.

For these updates to the Affiliations page to occur, you must set up the appropriate Affiliations service operations through integration broker.

See [Setting Up Integration Broker For Research Administrator Profile Affiliations](#)

See “Understanding Affiliations” (Campus Community Fundamentals)

See “Defining Affiliations” (Campus Community Fundamentals)

See “Adding and Updating Affiliations” (Campus Community Fundamentals)

Administrator Details

<i>Field or Control</i>	<i>Description</i>
Academic Organization and External Organization	You must select an academic organization or an external organization.
Approval Date and Approver	Indicates that the administrator has met the qualifications to be assigned as a research supervisor or evaluator.
Unrestricted	Select this check box if the administrator can participate in all academic careers. Deselect this check box if participation is restricted to a specific academic career or to a specific academic career, program, plan, subplan combination. When you deselect the check box, the Academic Career, Academic Program, Academic Plan, Academic Sub-Plan, Supervision Maximum, and Percent of Appointment fields appear.
Academic Career	The academic career in which the supervisor can participate. This field is required for supervisors if you have deselected the Unrestricted check box.
Supervision Maximum	The maximum number of candidates that the supervisor can be assigned to supervise. This field is available for edit only if you have deselected the Unrestricted check box.
Percent of Appointment	Indicates the supervisor’s availability to the role. This value cannot exceed 100; if it does, an error message is displayed. This field is available for edit only if you have deselected the Unrestricted check box.

Use the Transfer To field to go to other components and enter qualifications of the administrator.

Affiliation Code

Add affiliation codes to an administrator role.

Defining Supervisor Roles

Access the Supervisor Roles page (**Set Up SACR > Product Related > Student Records > Research Management > Supervisor Roles > Supervisor Roles**).

This example illustrates the fields and controls on the Supervisor Roles page . You can find definitions for the fields and controls later on this page.

Find View All		First	1 of 1	Last
*Effective Date:	01/01/1900	*Effective Status:	Active	*Description: Research Supervisor

Use this page to define the role of the supervisor for a particular research candidature. Supervisor roles are also used for the Student Academic Projects feature.

Note: It is recommended that you use affiliation codes and the Administrator Profile Management structure to define supervisors.

The values that you define here are available in the Supervisor Role field on the Supervisors page in the Candidate Management component and in the Candidature Details page in Admissions.

See [Assigning Candidate Supervisors](#).

Defining Additional Business Assignments

Access the Assignment Type Options page (**Set Up SACR > Product Related > Student Records > Research Management > Assignment Types > Assignment Type Options**).

This example illustrates the fields and controls on the Assignment Type Options page. You can find definitions for the fields and controls later on this page.

Assignment Type Options

Academic Institution: PSUNV PeopleSoft University

Assignment Type: HU

Find | View All First 1 of 1 Last

***Effective Date:** ***Effective Status:**

***Description:**

***Group Code:** Human Test Subject Approval

Optional Display Fields

- Require Completion Date
- Require Approver ID
- Require Committee ID
- Require Approval Date
- Use Comments Functionality

Display in Self Service

Message Set Number: **Message Number:**

Message Text:

Self Service Description:

Institutions can define additional business requirements that can be assigned to their research candidates. Examples include:

- Animal testing clearance.
- Human testing approval.
- Intellectual property rights ownership.
- Graduate contract.

These assignments can be maintained in the Candidate Management component, on the Other Assignments page and in the Project Management component, Additional Details page.

Field or Control	Description
Assignment Type	The Business Assignment Type Code. The values are defined when the page is entered in Add mode.

Field or Control	Description
Effective Status	Select <i>Active</i> to allow the row to be selected on the Candidate Management-Additional Requirements, Project Management-Additional Details and the Create Assignments pages.
Group Code	Assigns the specific set of status codes that can be used for this business requirement.
Display in Self Service	Select to display assignment type in the Candidate Center.
Message Set Number ,Message Number, andMessage Text	The message text is instructional text that appears in the Candidate Center, My Research Projects region when the candidate hovers over the ? icon next to the assignment type name. You can configure the message using the PeopleTools Message Catalog component (PeopleTools, Utilities, Administration, Message Catalog) .
Self Service Description	Set an alternate description of the assignment type. This is used in the Candidate Center.

Optional Display Fields

Field or Control	Description
Require Completion Date, Require Approver ID, Require Committee ID, Require Approval Date and Use Comments Functionality	Controls whether the Completion Date, Approver ID, Committee ID, Approval Date, and Comments fields appear on the Candidate Management-Other Assignments, Project Management-Additional Details, and Create Assignments pages.

Related Links

[Tracking Additional Candidate Assignments](#)

[Creating Assignments for Multiple Students](#)

Setting Up Research Service Requests

This section provides an overview of Research Service Requests and discusses how to:

- Use the Notifications framework for service request notifications.
- Use the Notifications framework for service item notifications.
- Set up research service request categories.
- Set up research service request types.

- Set up self-service research service requests.
- Set up service request assignments.

Understanding Research Service Requests

Students can request services from their department such as a leave of absence, change of program, and extra time to complete a thesis. Administrators use the Service Request Management page to submit service requests on behalf of students. Alternatively, students can use self-service to submit service requests. After a student uses the self-service page to submit a service request, the administrator uses the Service Request Management page to take action on the submitted service request.

An administrator can also use the Service Request Dashboard self-service page to update the service requests assigned to him or her. For example, the administrator can use the dashboard to add comments to the assigned requests. The key difference between dashboard and Service Request Management page is that when an administrator signs into Campus Solutions, he or she can view all the service requests assigned to all the administrators (including himself or herself) on the Service Request Management page while the dashboard displays only the service requests assigned to the signed-in administrator. Another key difference is that an administrator cannot create a service request using the dashboard. To create a new service request, an administrator should use the Service Request Management page.

Service requests can be broadly classified under service request categories. Each service request category has different service request types. Each service request type may have subtypes. For example, an institution can define a service category *Applicant*. The Applicant category may have different types such as *Research Application* and *Request for Research Application Information*. The Research Application type may have different subtypes such as *Submit Offer Letter for Acceptance* and *Defer Application to a Future Term*.

When a student creates a service request from the My Service Requests page, the student first selects the service request category, then the type for the category, then the subtype for the type (if subtypes have been defined for the request type) and finally enters the request details such as a description of the service request. When an administrator creates a service request on the Service Request Management page, the administrator must provide the request category, request type for the request category, and the subtype for the request type (if defined). Once a service request has been entered, the request is automatically assigned to an administrator to review. Students can monitor the status of their requests using their self service page, or can be notified directly by the administrator. Service requests can also be created from the Candidate Center.

See:

- “Using Research Tracking Self Service” (Campus Self Service)
- [Managing Service Requests](#)
- “Creating and Updating Service Requests (Candidates)” (Campus Self Service)
- “Administering Service Requests (Administrators)” (Campus Self Service)

To set up service requests, use the Service Request Categories page to set up request categories. Then, for each request category, use the Service Request Type page to set up request types. Optionally, set up request subtypes for a request type on the Service Request Type page.

Additionally, use the Research Defaults Setup page to configure service request self service for students. Use the Service Request Assignment Setup page to control how service requests are assigned.

Pages Used to Set Up Research Service Requests

<i>Page Name</i>	<i>Definition Name</i>	<i>Navigation</i>	<i>Usage</i>
Service Request Categories	SSR_RS_REQSTCAT	Set Up SACR > Product Related > Student Records > Research Management > Service Request Categories	Set up service request categories for research applicants and candidates.
Service Request Type	SSR_RS_REQSTTYP	Set Up SACR > Product Related > Student Records > Research Management > Service Request Types > Service Request Type	Set up service request types for each service request category.
Research Defaults Setup	SSR_SS_REQSETUP	Set Up SACR > Product Related > Student Records > Research Management > Research Defaults Setup	Configure additional service request settings for self-service as well as default settings for Research Tracking.
Service Request Assignment Setup	SSR_RS_ASGN_SETUP	Set Up SACR > Product Related > Student Records > Research Management > Service Request Assignment > Service Request Assignment Setup	Set up the assignment of service requests.

Using the Notifications Framework for Service Request Notifications

Use the Notifications framework to set up service request notifications so that when a service request is created or reassigned, the system automatically sends a notification to the administrator to whom the request has been assigned/reassigned.

The Notification Consumer ID: SCC_NTF_CON_20130211040026 Service Request Notifications is delivered:

This example illustrates the fields and controls on the Notification Consumer Setup page example for Service Requests. You can find definitions for the fields and controls later on this page.

Notification Consumer Setup

Notification Consumer ID: SCC_NTF_CON_20130211040026

***Consumer Name:**

Status:

Description:

Notification Templates		Personalize Find View All	First 1-2 of 2 Last
*Template Name	*Application Class		
1 <input type="text" value="SSR_SR_CREATE"/>	<input type="text" value="SSR_RS_RESEARCH:NOTIFICATION:SRCreateTemplateProvider"/>	View Template Name	<input type="button" value="+"/> <input type="button" value="-"/>
2 <input type="text" value="SSR_SR_REASSIGN"/>	<input type="text" value="H:NOTIFICATION:SRNotification"/>	View Template Name	<input type="button" value="+"/> <input type="button" value="-"/>

Delivered settings for Service Request Notifications:

<i>Notification Trigger</i>	<i>Template Name</i>	<i>Generic Template</i>	<i>Application Classes</i>	<i>Notes</i>
Entry of a new Service Request by a student or administrator from the Service Request pages.	SSR_RS_CREATE	SSR_RS_CREATE	SSR_RS_RESEARCH:NOTIFICATION:SRCreateTemplateProvider	<p>You must use the delivered template name. You can change the notification to use a different notification channel instead of email. If the Notification Type is set to <i>Alert</i>, a PeopleTools alert is generated in the Notifications region of a fluid homepage as well as a Notification Framework alert in the Notifications Center.</p> <p>Use the sample generic template as an example for creating your own notification content. The sample template defines the available field variables that can be used in the notification message content.</p>
Reassignment of an existing service request from the administrator Service Request pages.	SSR_RS_REASSIGN	SSR_RS_REASSIGN	SSR_RS_RESEARCH:NOTIFICATION:SRReassignTemplateProvider	See Notes in the row above.

Field variables provide context data that can be used when creating notification text. Following is a list of variables that are delivered with the `SSR_RS_CREATE` and `SSR_RS_REASSIGN` templates. To modify templates, go to PeopleTools, Workflow, Notifications, Generic Templates.

Value	Description
%1	Recipient Name
%2	Recipient EmplID
%3	Service Request EmplID
%4	Student Name
%5	Institution
%6	Service Request ID
%7	Service Request Sequence
%8	Request Category
%9	Request Type
%10	Request Subtype
%11	Comment
%12	Status
%13	URL
%14	Research Candidate Number
%15	Request Date
%16	Approver ID
%17	Approver Name
%18	Service Request Assigned to EmplID
%19	Assigned to Name

Value	Description
%20	Action Date
%21	As of Date
%22	Request Number

Note: The list of variables contained in each message is delivered with your system and require extensive coding effort to be modified.

See “Setting Up and Consuming the Notifications Framework” (Campus Community Fundamentals)

Defining Notifications By Service Request Type

Request type-specific notifications are supported. When a service request is entered or reassigned and a notification has been set up for the request type, that specific notification is sent instead of the common notifications described above. In addition, a notification can be sent to the assigned administrator if the service request is updated by another person.

On the Notification Consumer Setup page, update the delivered Consumer Notification ID: SCC_NTF_CON_20130211040026 Service Request Notifications with any additional request type-specific notifications. For these templates, you must use the SSR_RS_RESEARCH:NOTIFICATION:SRTemplateProvider application class.

Then, on the Service Request Type page, add your templates to the service request types for which notification is required.

Notification Trigger	Template Name	Generic Template	Application Classes	Notes
When a service request has been created, reassigned, or updated by someone other than the request owner, the assigned administrator receives a notification. Select the required trigger value on the Service Request Type page.	User Defined	User Defined	SSR_RS_RESEARCH:NOTIFICATION:SRTemplateProvider	These notifications use the same field variables as the SSR_RS_CREATE and SSR_RS_REASSIGN generic templates.

See “Setting Up and Consuming the Notifications Framework” (Campus Community Fundamentals)

Related Links

[Setting Up Research Service Requests](#)

Using the Notifications Framework for Service Item Notifications

Use the Notifications framework to set up service item notifications so that when a service item is created from the Candidate Center, the system automatically sends a notification to a designated administrator.

The Notification Consumer ID: SCC_NTF_CON_20140110095615 Candidate Self Service Notifications is delivered:

This example illustrates the fields and controls on the Notification Consumer Setup page example for Service Items.

Notification Consumer Setup

Notification Consumer ID: SCC_NTF_CON_20140110095615

*Consumer Name:

Status:

Description:

Notification Templates				
*Template Name	Notification Type	Template Status	*Application Class	
1 SSR_RS_CAND_TASK_COMPLETED	Email	Active	SSR_RS_RESEARCH:NOTIFICATION	View Template Name + -

Delivered settings for Candidate Self Service Notifications:

Notification Trigger	Template Name	Generic Template	Application Classes	Notes
Entry of a new Research Service Item from the Candidate Center by the student.	SSR_RS_CAND_TASK_COMPLETED	SSR_RS_CAND_TASK_COMPLETED	SSR_RS_RESEARCH:NOTIFICATION:RSTaskTemplateProvider	Use the sample generic template as an example for creating your own notification content.

Field variables provide context data that can be used when creating notification text. Following is a list of variables that are delivered with the SSR_RS_CAND_TASK_COMPLETED generic template. To modify templates, go to PeopleTools, Workflow, Notifications, Generic Templates.

Value	Description
%1	Recipient Name
%2	Recipient EmplID
%3	Student EmplID
%4	Student Name
%5	Institution

Value	Description
%6	Candidate Number
%7	Service ID
%8	Service Label
%9	Comment
%10	URL

Note: The list of variables contained in each message is delivered with your system and require extensive coding effort to be modified.

See “Setting Up and Consuming the Notifications Framework” (Campus Community Fundamentals)

Setting Up Research Service Request Categories

Access the Service Request Categories page (**Set Up SACR > Product Related > Student Records > Research Management > Service Request Categories**).

This example illustrates the fields and controls on the Service Request Categories page. You can find definitions for the fields and controls later on this page.

Service Request Categories

Academic Institution: PSNLD PeopleSoft University - NLD

Service Request Category: APPLICANT

[Find](#) | [View All](#) First 1 of 1 [Last](#)

*Effective Date: <input type="text" value="01/01/1900"/>	*Effective Status: <input type="text" value="Active"/>
*Description: <input type="text" value="Admission process related"/>	
*Request Assigned To: <input type="text" value="FA0800"/> Wrench, Julia	
Order Number: <input type="text" value="0"/>	
Message Set Number: <input type="text" value="14751"/>	Message Number: <input type="text" value="531"/>
Message Text: User this category to create requests related to Admissions	

Field or Control	Description
Request Assigned To	Select any EmplID from the system. The selected ID is the designated administrator of last resort. When a service request is created and the system is unable to determine the appropriate administrator to whom to assign the request, this ID is used as the default.
Order Number	This field controls the sorting order of the category in the Select a Request Category self-service page. The system performs the sorting in ascending order. Default is 0.
Message Set Number, Message Number and Message Text	<p>The message text that you select here appears when the mouse cursor is moved over the category in the Select a Request Category self-service page.</p> <p>You can configure the message using the PeopleTools Message Catalog component (PeopleTools, Utilities, Administration, Message Catalog).</p>

Setting Up Research Service Request Types

Access the Service Request Type page (**Set Up SACR > Product Related > Student Records > Research Management > Service Request Types > Service Request Type**).

This example illustrates the fields and controls on the Service Request Type page. You can find definitions for the fields and controls later on this page.

Service Request Type

Academic Institution: PSUNV PeopleSoft University
Service Request Type: LOA

Find | View All | First 1 of 1 Last

***Effective Date:** 08/01/2013 BY

***Description:** Leave of Absence

***Short Description:** LOA

***Request Category:** ENROLL ? Enrollment

Approval Required

Message Set Number: ?

Message Text:

***Effective Status:** Active ▼

Order Number: 10

Use in Self Service

Message Number: ?

Personalize | Find | View All | First 1-2 of 3 Last

*Subtype	Description	Order Number	Message Set Number	Message Number	
1 CAN	Cancel LOA Request	10	<input type="text"/> ?	<input type="text"/> ?	+ -
2 OTHR	Other	40	<input type="text"/> ?	<input type="text"/> ?	+ -

Personalize | Find | View All | First 1 of 1 Last

*Trigger	*Notification Template ID	Template Name	
1 Updated ▼	<input type="text"/> ?		+ -

The Service Request Type values that you set up here are available in the Service Request Management component for administrators as well as the Service Request Assignment Setup component. You can choose whether or not to make the Service Request Type available in self service for students.

See [Managing Service Requests](#)

See “Administering Service Requests (Administrators)” (Campus Self Service)

See “Creating and Updating Service Requests (Candidates)” (Campus Self Service)

Field or Control	Description
Request Category	Select the category to which the type belongs.
Approval Required	The check box is informational-only.
Use in Self Service	Select if you want the type (and its subtypes) to be made available in the Select a Request Type self-service page.

Field or Control	Description
Order Number	This field controls the sorting order of the type in the Select a Request Type self-service page. The system performs the sorting in ascending order. Default is 0.
Message Set Number, Message Number and Message Text	The message text that you select here appears when the mouse cursor is moved over the type in the Select a Request Type self-service page. You can configure the message using the PeopleTools Message Catalog component.

Request Subtypes

Subtypes enable users to be more specific in the definition of the request (for example, Request type: Notice of intent to submit and Subtype: Request to extend submission date).

The fields for subtype are similar to the fields for the request type

Use of subtypes is optional. If you do not define a subtype, the Select a Request Subtype self-service page does not appear for the student (after the student selects a request type).

Notifications

Use this setup to define optional notifications by service request type. The administrator assigned to the service request receives the notification.

Field or Control	Description
Trigger	Select the action that initiates the corresponding notification template: <ul style="list-style-type: none"> • <i>Created</i>: A new service request is created. • <i>Reassigned</i>: An existing service request is reassigned to another administrator. • <i>Updated</i>: The service request record has been updated by another user.
Notification Template ID	The notification template ID prompts the templates setup for the Service Request Notifications consumer ID. Only templates associated with the SSR_RS_RESEARCH:NOTIFICATION:SRTemplateProvider application class can be used.

See [Using the Notifications Framework for Service Request Notifications](#)

Setting Up Self-Service Research Service Requests

Access the Research Defaults Setup page (**Set Up SACR > Product Related > Student Records > Research Management > Research Defaults Setup**).

This example illustrates the fields and controls on the Research Defaults Setup page. You can find definitions for the fields and controls later on this page.

Research Defaults Setup

Academic Institution: PSUNV PeopleSoft University

Service Request Defaults

*Default status on creation by student: Request Received

*Default status on updates by the student: Review in Progress

*Student Update Threshold: Request Completed

Display Administrator Name

Other Defaults

*Default Consumption Status: Pending Finalization

Service Request Defaults

<i>Field or Control</i>	<i>Description</i>
Default status on creation by student	Select the status which the system assigns to the new service request row when the student creates a new service request from self-service pages. This field prompts you with request status codes (System Usage = Request) from the Process Status Codes page.
Default status on updates by student	Select the default status code to be used when students update an existing service request.

Field or Control	Description
Student Update Threshold	<p>Select a status code level value. These values are defined on the Process Status Codes page. The status code level value here indicates the maximum status code level at which a student can update a service request using My Service Requests. For example, a student cannot update a service request from the self-service page if the threshold here is set at 30, and the student's service request status code level value is greater than or equal to 30.</p> <hr/> <p>Note: Students can view service requests that they can no longer update.</p> <hr/>
Display Administrator Name	<p>Select this check box if you want the student's My Request Detail self-service page to display the administrator's name. If you do not select this check box, the My Request Detail page displays the text <i>Staff</i> instead of the administrator name to insure anonymity.</p>

Other Defaults

Field or Control	Description
Default Consumption Status	<p>Select to assign an initial consumption status when the candidate record is created for the first time from a process that does not allow the user to manually set the value. The impacted processes are: Quick Admit, Student Program/Plan updates, and Program Addition.</p> <hr/> <p>Note: The impacted processes display an error message for any new candidate records until this setting is completed.</p> <hr/>

Related Links

“Administering Service Requests (Administrators)” (Campus Self Service)

“Creating and Updating Service Requests (Candidates)” (Campus Self Service)

Setting Up Service Request Assignments

Access the Service Request Assignment Setup page (**Set Up SACR > Product Related > Student Records > Research Management > Service Request Assignment > Service Request Assignment Setup**).

This example illustrates the fields and controls on the Service Request Assignment Setup page. You can find definitions for the fields and controls later on this page.

Service Request Assignment Setup

Academic Institution PeopleSoft University

Find | View All | First 1 of 1 Last

Effective Date 01/02/1900 + -

Personalize Find View All First 1-4 of 4 Last						
#	*Request Type	Request Subtype	Advisor Type Option	*Default ID	Name	
1	APPT	ADV	Supervisor	0006	Asanuma, Maeve	+ -
2	LOA			KU0007	Locherty, Betty	+ -
3	LOA	REQ	Advisor	SA0034	Hurley, Sean Michael	+ -
4	RLOA	CAN	Supervisor	SA0034	Hurley, Sean Michael	+ -

Use this page to define how a service request is assigned to an administrator for review.

When a service request is entered, the system uses the service request type and subtype values to find matching values in the setup.

If a matching row is found and if the Advisor Type Option is set, the system tries to find the student's academic advisor or research primary supervisor. If found, the system identifies the advisor and assigns the service request. If the advisor is not found (or if the Advisor Type Option was not set), the system assigns the Default ID as the administrator.

If a matching row is *not* found, the system searches for a row with a matching request type value and a blank request subtype and follows the same assignment logic if a match is found. If the system still does not find a match based on the preceding criteria, it then identifies the category of the service request and assigns the request to the administrator defined in that request category setup.

Beginning with April 2014, the Rules Engine performs the service request assignment functionality, with the rule following the parameters as previously described. If you require additional flexibility in how service requests need to be assigned in your institution, you can update the rule with your own business logic. The delivered rule is:

- Rule ID: SCC_RULE_ID_20140205065106
- Rule Name: "Service Request AssignedTo : Rule Trigger"
- Rule Category Name: Service Requests

For more information about the Rules Engine, see “Understanding the Rules Engine” (Campus Community Fundamentals).

<i>Field or Control</i>	<i>Description</i>
Request Type and Request Subtype	Select a value from those defined on the Service Request Type page. See Setting Up Self-Service Research Service Requests .
Advisor Type Option	Select Advisor, Supervisor or leave the field blank. If you select Advisor, the system assigns service requests of this type/subtype to the candidate's Academic Advisor, as indicated on the Student Advisor page. See Assigning Academic Advisors to Students . If you select Research Supervisor, the system assigns service requests of this type/subtype to the candidate's primary Supervisor as indicated on the Candidate Management - Supervisors page (the Supervisor record with the Primary Supervisor check box selected). See Assigning Candidate Supervisors
Default ID	If you do not select an Advisor Type Option, the system assigns service requests of this type/subtype to the person that you select as the Default ID.

Setting Up Candidate Center

This section discusses how to:

- Set up the My Research Projects region.
- Configure a Status Detail page.
- Set up the My Service Items region.
- Configure a service item.
- Set up the service item fields.

Pages Used to Set Up Candidate Center

<i>Page Name</i>	<i>Definition Name</i>	<i>Navigation</i>	<i>Usage</i>
Status Detail Window Setup	SSR_RS_CANDSS_STUP	Setup SACR > Product Related > Student Records > Research Management > Status Detail Window Setup	Set up the My Research Projects region in Candidate Center.

Page Name	Definition Name	Navigation	Usage
Status Field Setup	SSR_RS_POP_FLDSTP	Setup SACR > Product Related > Student Records > Research Management > Status Field Setup	Configure the information that appears in the various Status Detail pages from the My Research Projects region.
Service Window Setup	SSR_RS_TSKTABS	Setup SACR > Product Related > Student Records > Research Management > Service Window Setup	Set up the tabs that appear in the My Service Items region.
Service Item Setup	SSR_RS_TASK_SETUP	Setup SACR > Product Related > Student Records > Research Management > Service Item Setup	Create and configure service items.

Setting Up the My Research Projects Region

Access the Status Detail Window Setup page (**Setup SACR > Product Related > Student Records > Research Management > Status Detail Window Setup**).

This example illustrates the fields and controls on the Status Detail Window Setup Page. You can find definitions for the fields and controls later on this page.

Status Detail Window Setup

Academic Institution: PSUNV PeopleSoft University

Find | View All First 1 of 1 Last

Effective Date: 03/01/2014 + -

*Order	*Section Label	*Candidate Entity	Display 'None'		
10	Completion Dates	Submissior	<input type="checkbox"/>	+	-
40	Additional Assignments	Assignmen	<input type="checkbox"/>	+	-
4	Supervisors	Supervisor	<input type="checkbox"/>	+	-
20	Thesis Evaluation	Thesis	<input type="checkbox"/>	+	-
1	Research Topics	Topic	<input type="checkbox"/>	+	-

Hide Inactive Projects
 Hide Inactive Supervisors
 Hide Inactive Topics

When candidates select a project in the **My Research Projects** region, information about the project appears. Use the **Status Detail Window Setup** page to identify the research entities that appear in the **My Research Projects** region.

Field or Control	Description
Order	Indicates the order in which the research entities appear in the window.
Section Label	Assign the label to identify the content.
Candidate Entity	Set the corresponding entity to the section label. Each entity corresponds to candidate information displayed in the Candidate Management and Thesis Management components. The data from the selected entity is used for the section. The list of values are: Assignment, Submission, Supervisor, Thesis, Topic.
Display 'None'	Select to display 'None' next to the section label if data does not exist for the entity. If you do not select this option, the section label is hidden if data does not exist.
Hide Inactive Projects ,Hide Inactive Supervisors , and Hide Inactive Topics	Select to hide inactive records in the My Research Projects region. The Hide Inactive Projects option displays <i>only</i> research project records where the project's 'Assigned' status is set (visible in the Candidate Management Override page). The Hide Inactive Supervisors option displays <i>only</i> assigned supervisors where their current effective status is 'Active'. The Hide Inactive Topics option displays <i>only</i> assigned topics where their current effective status is 'Active'.

Configuring a Status Detail Page

When candidates click any link that appears in the **My Research Projects** region, a status detail page appears and displays current information about the selected link. Candidates could use this information to determine their current status, and whether any action may be required.

The following image shows an example of fields that are visible to candidates when they select an assignment link from the My Research Projects region.

This example illustrates the fields and controls on the Status Field Setup page for the Assignments Status Detail page (example). You can find definitions for the fields and controls later on this page.

*Field Name	Description	Display
1 COMMENTS	Comment	<input checked="" type="checkbox"/>
2 SSR_RS_ACTION_DT	Date of action	<input checked="" type="checkbox"/>
3 SSR_RS_APPRVL_DT	Approval Date Sought	<input checked="" type="checkbox"/>
4 SSR_RS_APPRVR_ID	Approver ID	<input checked="" type="checkbox"/>
5 SSR_RS_COMMITTEE	Advisory Committee	<input checked="" type="checkbox"/>

Use the **Status Field Setup** page to configure the information that is visible to candidates.

Field or Control	Description
All Attachments	Select to allow candidates to view all attachments associated with the selected detail page. Attachments can be viewed in the Candidate Management or Thesis Management components in their corresponding sections.
Public Attachments	Select to allow candidates to view <i>only</i> public attachments. This allows <i>only</i> attachments marked as 'Visible to Student' to be displayed.
Display	Select to display the field in the status detail page.

The following sections list the only fields that you can select to display in the corresponding status detail page.

Research Topic Status Detail Page

Field	Description
SSR_RS_TOPIC_ID	Topic Code

Field	Description
SSR_RS_RSRCH_TOPIC	Research Topic
SSR_RS_DESCRLONG	Topic Description
SSR_RS_THESIS_TITL	Thesis Title
SSR_RS_STATUS	Status
SSR_RS_ACTION_DT	Status Date
SSR_RS_TPCCMNT	Comments

Supervisor Status Detail Page

Field	Description
SSR_RS_SUPER_ID	Supervisor Name
SSR_RS_SUPER_TYPE	Supervisor Role
SSR_RS_PRI_SUPR	Primary Supervisor
SSR_RS_BEGIN_DT	Start Date
SSR_RS_END_DT	End Date
SSR_RS_SUPER_PRCNT	Supervision Percentage
ACAD_ORG	Academic Organization
SSR_RS_COMMITTEE	Advisor Committee
SSR_RS_STATUS	Status
SSR_RS_ACTION_DT	Status Date
COMMENTS	Comment

Assignment Status Detail Page

Field	Description
SSR_RS_REQUIRE_TYPE	Assignment Type
SSR_RS_EXP_COMP_DT	Completion Date
SSR_RS_APPRVL_DT	Approval Date
SSR_RS_APPRVL_ID	Approver ID
SSR_RS_COMMITTEE	Advisory Committee
SSR_RS_STATUS	Status
SSR_RS_ACTION_DT	Status Date
COMMENTS	Comment

Consumption Status Detail Page

Field	Description
SSR_RS_BEGIN_DT	Begin Date
SSR_RS_LOAD	Research Load
SSR_RS_CAN_CNSMPTN	Consumption Method
SSR_RS_CNSMPTN_DAY	Total Days
SSR_RS_DAYS_REMNG	Days Remaining
SSR_RS_SUB_DT_MIN	Early Submission Date
SSR_RS_SUB_DT_MAX	Final Submission Date
SSR_RS_STATUS	Status

Field	Description
SSR_RS_ACTION_DT	Status Date
COMMENTS	Comment

Thesis Status Detail Page

Field	Description
SSR_RS_THESIS_TITL	Thesis Title
SSR_RS_STATUS	Status
EFFDT	Effective Date
SSR_RS_INTD_SUB_DT	Intended Submission Date
SSR_RS_ACT_SUB_DT	Actual Submission Date
SSR_PROJ_DATE	Oral Defense Date
SSR_RS_NBR_SUBMIT	Number of Copies Submitted
SSR_RS_CERT_EMPLID	Certificate Approver
SSR_RS_NOITS_APRVL	Intent to Submit Approval
SSR_RS_CERTINT_FLG	Exam Initiated
SSR_RS_RETURN_FLG	Return of Thesis Requested
SSR_RS_DECLARE_FLG	Details Declared Correct
SSR_RS_CERT_SAPRVL	Exam Supervisor Approval
SSR_RS_COMPSEM_FLG	Ready for Completion Seminar
SSR_RS_EMBARGO_TYPE	Embargo Type

Field	Description
SSR_RS_EMB_STRT_DT	Embargo Start Date
SSR_RS_EMB_END_DT	Embargo End Date
SSR_RS_EX_PYMT_FLG	Examiner Payments Processed
SSR_RS_LIB_DEP_FLG	Library Submission Made
SSR_RS_CND_ADV_FLG	Candidate Advised
SSR_RS_GRDTN_FLG	Proceed to Graduation
COMMENTS	Comments

Setting Up the My Service Items Region

Access the Service Window Setup page (**Setup SACR > Product Related > Student Records > Research Management > Service Window Setup**).

This example illustrates the fields and controls on the Service Window Setup Page. You can find definitions for the fields and controls later on this page.

Service Window Setup

Academic Institution: PSUNV PeopleSoft University

Find | View All First 1 of 1 Last

Effective Date: 02/25/2014

*Tab Order	*Tab Label	*Tab Message		
1	Admissions Application	Please select an item to proceed	+	-
2	Research Tasks	Select an item to proceed	+	-
3	Other Tasks	Other, non-specific service items you can choose...	+	-
4	Access Requests	Select the appropriate item to proceed	+	-

*Window Message: Choose a service item to initiate and we will get busy on it!

Use the **Service Window Setup** page to add or remove the tabs that appear in the **My Service Items** region. At least one page tab must be defined. Use the page tabs to logically group service items. The tab labels should help candidates find the appropriate service item. You can create as many tabs as appropriate as well as the define the order in which the tabs appear. When a service item is created, administrators must indicate in which tab the service item appears.

Field or Control	Description
Tab Message	Define the introductory text that appears in each tab.
Window Message	Define the introductory text that appears in the My Service Items region.

Configuring a Service Item

The **My Service Items** region enables research candidates to initiate a service item transaction. Service items can be:

- Research service items. These are transactions that allow candidates to directly update their candidature information without administrator intervention.
- Research service requests. These are requests that are assigned and processed by an administrator.

You use the Service Item Setup page to create both types of transactions that can be initiated by candidates in the Candidate Center. However, make sure you set up the service request categories, types, and subtypes before you configure service items for use in the Candidate Center. Also, exercise care when you configure research service items because these items allow candidates to update their candidature information.

Configuring a Research Service Item

Access the Service Item Setup page (**Setup SACR > Product Related > Student Records > Research Management > Service Item Setup**).

This example illustrates the fields and controls on the Service Item Setup for Research Service Item - General page. You can find definitions for the fields and controls later on this page.

Use the Service Item Setup — General page to configure the settings of a service item.

Field or Control	Description
Service ID	You enter this value when you add a service item.
Ready for Use	Select if you want the service item to be available in the My Service Items region.

Field or Control	Description
Use during	<p>A service item appears in the My Service Items region based on a student's enrollment status.</p> <p>To display a service item accordingly, select one or more of the following conditions:</p> <ul style="list-style-type: none"> • <i>Pre-applicant</i> if a candidate record does <i>not</i> exist for the selected student regardless of whether the student is active in other non-research programs. • <i>Admissions applicant</i> if a candidate record exists for the selected student and a matching ACAD_PROG record for the candidate number does not exist, but a matching record is found in ADM_APPL_PROG. • <i>Post matriculation</i> if a candidate record exists for the selected student <i>and</i> a matching record for the candidate number is found in ACAD_PROG.
User	Select to assign a user. Candidate Center uses <i>only</i> service items whose users are set to Candidate .
Service Tab	Select to indicate the tab where the service item should appear.
Service Label	Set the name of the link label for the service item.
Item Order	This field controls the order in which the service item appears under the service tab. Service items are displayed in ascending order.
Status Group	Select so you can set the proper status code. Choices are filtered based on the Entity value.
Status	Sets the default value that is assigned when candidate records are updated. The values you can select depend on the Status Group you set.
Status Level	Use to prevent the candidate from updating their candidate and thesis information. Every research status code has an associated status level value. The status code level of the target entity must be less than this value, otherwise the service item cannot be submitted.

Field or Control	Description
Entity	<p>Select the research candidate entity that the service item should update. Select any one of the following:</p> <ul style="list-style-type: none"> • Topic • Supervisor • Submission (Consumption) • Assignment • Thesis • Service Request. If you select this option, rather than update the student's candidate records, a new service request record is created for the student.
Message Set Number, Message Number	<p>Select the help text that appears when candidates hover over the Service Label in the My Service Items region.</p>
Notification Template	<p>Select the notification template to be sent to the designated recipient of the service item.</p> <p>Add your notification templates in the Notification Consumer Setup page, Consumer ID: SCC_NTF_CON_20140110095615 Candidate Self Service Notifications.</p>
Notification Recipient	<p>If a rule is not used, this is the primary recipient of the notification generated by the creation of the research service item. If a custom rule is used to determine the notification recipient, this ID is used if the rule cannot determine a recipient. Note that the recipient must grant notification permissions for email and SMS.</p>

Field or Control	Description
Rule	<p>Shows the optional Rules Engine rule that can be used to determine the notification recipient. A sample rule exists that attempts to send the notification to the student's primary research supervisor. Use the Search and Clear buttons to manage the setting.</p> <p>Sample Rule:</p> <ul style="list-style-type: none"> • Rule ID: SCC_RULE_ID_20140115033240 • Rule Name: Research Std SS task notification recipient • Rule Category Name: Research Self Service Task <p>For information, see "Understanding the Rules Engine" (Campus Community Fundamentals).</p>

Configuring a Research Service Request

If a service item is configured to create a service request, the notification fields on the page (Status Group, Status, Status Level, Notification Template, Notification Recipient, and Rule) are hidden and two new fields appear (Service Request Type, Service Request Subtype). This is because service requests have their own status and notification settings, and the new fields indicate the appropriate service request settings to use. In addition, the Fields page is hidden. This is because a common service request entry form is used and does not require configuration. This is triggered when **Entity** is set to *Service Request*.

Access the Service Item Setup page (**Setup SACR > Product Related > Student Records > Research Management > Service Item Setup**).

This example illustrates the fields and controls on the Service Item Setup for Research Service Request - General page. You can find definitions for the fields and controls later on this page.

The fields on the Service Item Setup for Research Service Request - General page are similar to the setup page for research service items except for the following:

<i>Field or Control</i>	<i>Description</i>
Service Request Type	This field appears when the Entity is 'Service Request'. Select the appropriate service request type for the service item.
Service Request Subtype	This field appears when the Entity is 'Service Request'. Select the appropriate subtype (if any) for the service item.

Related Links

- “Using Research Tracking Self Service” (Campus Self Service)
- [Setting Up Research Service Requests](#)
- [Managing Service Requests](#)

Setting Up the Service Item Fields

Access the Service Item Setup — Fields page (**Setup SACR > Product Related > Student Records > Research Management > Service Item Setup > Fields**).

This example illustrates the fields and controls on the Service Item Setup — Fields Page. You can find definitions for the fields and controls later on this page.

Use the Service Item Setup — Fields Page to identify which fields and options are available to candidates when they initiate a service item. Depending on the value of the service item entity, additional options may be available.

<i>Field or Control</i>	<i>Description</i>
Display	Select to display the field in the service item status detail page.

You can enable these fields and options for the following service items:

Research Topic Optional Fields

<i>Field</i>	<i>Description</i>	<i>Notes</i>
Check box	Create a new Topic Sequence	If selected, this creates a new topic sequence. If deselected, the user is required to select an existing research topic record to update.
Check box	Use Topic Search	Enables the Topic Search functionality. Generally used in conjunction with the Create a New Topic Sequence option.

Field	Description	Notes
Check box	Attachments Support	Enables the attachment functionality.
SSR_RS_RSRCH_TOPIC	Research Topic	If selected, this field appears in the data entry page.
SSR_RS_DESCRLONG	Topic Description	If selected, this field appears in the data entry page.
SSR_RS_THESIS_TITL	Thesis Title	If selected, this field appears in the data entry page.
SSR_RS_TPCCMNT	Comments	If selected, this field appears in the data entry page.

Supervisor Optional Fields

Field	Description	Notes
Check box	Create a new Supervisor Sequence	If selected, a new supervisor sequence is created. Otherwise, the user is required to select an existing supervisor record to update.
Check box	Use Supervisor Search	Enables the supervisor search functionality. Generally used in conjunction with the Create a New Supervisor Sequence option. This records the EmplID of the supervisor.
Check box	Attachments Support	Enables the attachment functionality.
SSR_RS_BEGIN_DT	Supervision Begin Date	If selected, this field appears in the data entry page.
SSR_RS_END_DT	Supervision End Date	If selected, this field appears in the data entry page.
SSR_RS_SUPER_PRCNT	Supervision Percentage	If selected, this field appears in the data entry page.

Field	Description	Notes
SSR_RS_SUPER_TYPE	Supervisor Role	If selected, this field appears in the data entry page.
SSR_RS_PRI_SUPR	Primary Supervisor	If selected, this field appears in the data entry page.
COMMENTS	Comments	If selected, this field appears in the data entry page.

Thesis Optional Fields

Field	Description	Notes
Check box	Attachments (Support)	Enables the attachment functionality.
SSR_RS_THESIS_TITL	Thesis Title	If selected, this field appears in the data entry page.
SSR_RS_INTD_SUB_DT	Intended Submission Date	If selected, this field appears in the data entry page.
SSR_RS_ACT_SUB_DT	Actual submission Date	If selected, this field appears in the data entry page.
SSR_RS_NBR_SUBMIT	Number of Copies Submitted	If selected, this field appears in the data entry page.
SSR_RS_NOITS_APRVL	Intent to Submit for Approval	If selected, this field appears in the data entry page.
SSR_RS_DECLARE_FLG	Details Declared Correct	If selected, this field appears in the data entry page.
SSR_RS_COMPSEM_FLG	Ready for Completion Seminar	If selected, this field appears in the data entry page.
SSR_RS_RETURN_FLG	Return of Thesis Requested	If selected, this field appears in the data entry page.

Field	Description	Notes
SSR_RS_EMBARGO_TYP	Embargo Type	If selected, this field appears in the data entry page.
SSR_RS_EMB_STRT_DT	Embargo Start Date	If selected, this field appears in the data entry page.
SSR_RS_EMB_END_DT	Embargo End Date	If selected, this field appears in the data entry page.
SSR_PROJ_DATE	Oral Defense Date	If selected, this field appears in the data entry page.
COMMENTS	Comments	If selected, this field appears in the data entry page.

Consumption and Submission Date Optional Fields

Field	Description	Notes
Check box	Attachments Support	Enables the attachment functionality.
SSR_RS_BEGIN_DT	Begin Date	If selected, this field appears in the data entry page.
SSR_RS_LOAD	Consumption Load	If selected, this field appears in the data entry page.
SSR_RS_SUB_DT_MIN	Early Submission Date	If selected, this field appears in the data entry page.
SSR_RS_SUB_DT_MAX	Final Submission Date	If selected, this field appears in the data entry page.
COMMENTS	Comments	If selected, this field appears in the data entry page.

Assignments Optional Fields

Field	Description	Notes
Check box	Create a new Assignment Type	Select to allow any self-service-enabled assignment type to be used in creating a new assignment record. If not selected, the user is prompted to select an existing assignment record to update.
Check box	Attachments Support	Enables the attachment functionality.
SSR_RS_EXP_COMP_DT	Expected Completion Date	If selected, this field appears in the data entry page.
SSR_RS_APPRVL_ID	Approver ID	If selected, this field appears in the data entry page.
SSR_RS_COMMITTEE	Advisory Committee	If selected, this field appears in the data entry page.
SSR_RS_APPRVL_DT	Approval Date	If selected, this field appears in the data entry page.
COMMENTS	Comments	If selected, this field appears in the data entry page.

Setting Up Rules for Online Edits

The Rules Engine has been integrated for use in the Candidate Management, Thesis Management, and Academic Project Management components to support local business policies. Rules can be written to perform online editing of a student's project and display a warning message to administrator. A sample rule has been provided.

This section discusses how to:

- Set up rule types.
- Associate rule types with execution events.

Pages Used to Set Up Rules for Research Tracking

<i>Page</i>	<i>Definition Name</i>	<i>Navigation</i>	<i>Usage</i>
Rule Type Table	SSR_RS_RULE_TYPE	Set Up SACR > Product Related > Student Records > Research Management > Rule Types	Set up rule types.
Execution Event Rule Types	SSR_RS_EXEC_EVENT	Set Up SACR > Product Related > Student Records > Research Management > Execution Event Rules	Associate rule types with execution events.

Setting Up Rule Types

The Rule Type Table provides a link between Research Tracking-related features and the Rules Engine.

Access the Rule Type Table page (**Set Up SACR > Product Related > Student Records > Research Management > Rule Types**).

This example illustrates the fields and controls on the Rule Type Table. You can find definitions for the fields and controls later on this page.

Rule Type Table

Rule Type **PROJ_CAND** System Data

*Description

Long Description

Rule Group Name **Research Candidate**

Rule Category Name **Research Candidates**

Find	View All	First	1 of 1	Last	Search	Status
					Search	Active

[Add row](#)

<i>Field or Control</i>	<i>Description</i>
Rule Type and Description	Enter a Rule Type code (20 character limit) and a Description (30 character limit). For the research tracking and student academic project features, the rule groups used for on-line event triggers are predefined. New rules should be added to the appropriate rule group.

Field or Control	Description
System Data	If a rule type is delivered as system data, this check box is selected and is not available for edit.
Rule Group ID, Search, Rule Group Name, and Rule Category Name	A Rule Type must be associated with a single Rule Group. When adding a new rule type, click the Search button to launch a search using a standard Rules Engine search utility. When you select a Rule Group ID, the Rule Group Name and Rule Category Name are displayed.
Copy	This button is available only when you add a new rule type. The copy feature provides a prompt against all rule types defined in the system, including those for which the System Data check box is selected (delivered rule types).
Delete	When a rule type is saved successfully, a Delete button is available. Delete is not available for rule types for which the System Data check box is selected.

Delivered Rule Types and Sample Rules

The delivered rule types for online edits are:

- PROJ_CAND — Project Candidate
- RSCH_CAND — Research Candidate
- RSCH_CONS — Research Consumption
- RSCH_OTHR — Research Assignments
- RSCH_SUP — Research Supervisor
- RSCH_THES — Research Thesis
- RSCH_TOPC — Research Topic

The following rules are provided as samples to help you create your own rules. These sample rules are not intended for actual use.

Rule	Conditions
<ul style="list-style-type: none"> • Rule ID: SCC_RULE_ID_20140120084414 • Rule Name: Candidate has no available research Supervisors • Rule Category Name: Research Candidates • Rule Type: RSCH_CAND • Component: Candidate Management • PeopleCode Event: Component Post Build 	<p>When any of the following conditions are <i>not</i> met, a message about the supervisor’s ineligibility appears:</p> <ul style="list-style-type: none"> • Administrator profile record of the supervisor is active. • If the unrestricted check box is not selected, and the academic program <i>or</i> academic plan in the administrator profile matches the candidate header. • The current date is no longer within the supervisor's availability dates defined in the administrator profile page. <p>Message: <i>One of the candidate’s supervisors is no longer eligible to provide supervision (14751, 260).</i></p>
<ul style="list-style-type: none"> • Rule ID: SCC_RULE_ID_20140121001258 • Rule Name: Candidate has no available Project Supervisors • Rule Category Name: Research Candidates • Rule Type: PROJ_CAND • Component: Academic Project Management • PeopleCode Event: Component Post Build 	<p>When any of the following conditions are <i>not</i> met, a message about the supervisor’s ineligibility appears:</p> <ul style="list-style-type: none"> • Administrator profile record of the supervisor is active. • If the unrestricted check box is not selected, and the academic program <i>or</i> academic plan in the administrator profile matches the candidate header. • The current date is no longer within the supervisor's availability dates defined in the administrator profile page. <p>Message: <i>One of the candidate’s supervisors is no longer eligible to provide supervision (14751, 260).</i></p>
<ul style="list-style-type: none"> • Rule ID: SCC_RULE_ID_20140116235214 • Rule Name: Candidate has no active supervisors • Rule Category Name: Research Candidates • Rule Type: RSCH_CAND • Component: Candidate Management • PeopleCode Event: Component Post Build 	<p>A message appears when no record exists of at least one active supervisor record for the candidate.</p> <p>Message: <i>The candidate does not have an active supervisor (14751,263).</i></p>

Rule	Conditions
<ul style="list-style-type: none"> • Rule ID: SCC_RULE_ID_20140206012715 • Rule Name: Compare Thesis Title • Rule Category Name: Research Candidates • Rule Type: RSCH_THES • Component: Thesis Management • PeopleCode Event: Component Post Build 	<p>A warning appears when the following conditions are met:</p> <ul style="list-style-type: none"> • The topic <i>and</i> thesis record thesis title fields are not blank. • The current research topic status is equal to 'TF' - Title Finalized. <p>Message: <i>Warning: Thesis Title doesn't match the Topic Title (14751,270)</i></p>

Associating Rule Types with Execution Events

Execution Event rule types determine how and when the Rules Engine is invoked in Research Tracking by tying rule types to a specific action that a user might take. The PeopleCode event referenced in the Execution Event definition is a pointer to the code that invokes the Rules Engine when the action occurs, such as user a clicking a button in the system. Each event in turn can invoke certain rule types, each of which can be set to active or inactive.

Access the Execution Event Rule Types page (**Set Up SACR > Product Related > Student Records > Research Management > Execution Event Rules**).

This example illustrates the fields and controls on the Execution Event Rule Types Page. You can find definitions for the fields and controls later on this page.

Execution Event Rule Types

Execution Event RSCH_CAND_POSTBUILD System Data

*Status Active

*Description Candidate Management PostBuild

Event Description Rules to be executed from Candidate Management Component PostBuild

PeopleCode Event ComponentPostBuild

Menu Name SSR_RESEARCH_MGMT Research Management

Component Name SSR_RS_RSRCH_CAND Research Management

Page Name

Record (Table) Name

Field Name Run All Rules

Rule Type	Description	*Rule Execution Error Handling	*Status	System Data
1 RSCH_CAND	Research Candidate	Obey	Active	<input checked="" type="checkbox"/>

[Add row](#)

Field or Control	Description
System Data	This check box displays for Execution Event Rule Types definitions delivered by Campus Solutions Development.
Status	Campus Solutions Development events are delivered as <i>Inactive</i> . Events must be <i>Active</i> for Rules Engine invocation to occur.
Copy	This button is available only when you add a new execution event. The copy feature provides a prompt against all execution events defined in the system, including those for which the System Data check box is selected.
Delete	When an execution event is saved successfully, a Delete button is available. Delete is not available for execution events for which the System Data check box is selected.
PeopleCode Event	Select a value: <i>ComponentPostBuild</i> , <i>Field Change</i> , <i>Field Edit</i> , <i>Save Edit</i> , <i>SavePostChange</i> , or <i>Save Pre-Change</i> . The event selected here documents where the trigger PeopleCode that invokes the Rules Engine is called from by the component processor.

Field or Control	Description
Menu Name, Component Name, Page Name and Field Name	<p>These fields are used to document the actual page/field location where the execution event will occur.</p> <p>For the research tracking and student academic project features, the components that have been configured to support execution events are:</p> <ul style="list-style-type: none"> • Menu: SSR_RESEARCH_MGMT (Research Management) • Components: SSR_RS_CAND (Candidate Management) and SSR_RS_THESIS (Thesis Management) • Menu: SSR_PROJECT_MGMT (Academic Project Management) • Component: SSR_PROJ_MGMT (Project Management)
Run All Rules	<p>When this check box is deselected, rule execution stops when the first error is encountered. For example, if a student adds three courses to their planner in self-service and each of those courses has a Course Requisite rule attached to them, and the student fails the first requisite, an error is returned for the first requisite but the other two requisite rules are not checked. If the Run All Rules check box is selected, all three rules are executed.</p>

Setting Up Online Notifications

The Online Notifications feature uses the Notifications framework to allow administrators to send notifications from select administrator pages to any person defined in the Campus Solutions database. Notification Consumer IDs and templates (sample and generic) are delivered. You must use the delivered Application Class.

Component/Navigation	Notification Consumer ID / Consumer Name	Sample Template	Sample Generic Template	Application Class
Service Request Management (Records and Enrollment, Graduate Research Management, Service Request Management)	SCC_NTF_CON_20130925005259 Service Request Online Notifications	SCC_NTF_TMP_20130925003014 - Review Service Request	SSR_ONLINE_SREQ_EMAIL	SCC_COMMON: NOTIFICATION: BaseParameterProvider

Component/ Navigation	Notification Consumer ID / Consumer Name	Sample Template	Sample Generic Template	Application Class
<p>Administrator Service Request (Self Service page)</p> <p>(Records and Enrollment, Graduate Research Management, Service Request Dashboard)</p>	<p>SCC_NTF_CON_20130925010307</p> <p>Admin SS Online Notifications</p>	<p>SCC_NTF_TMP_20130925004359 - Review Service Request SS</p>	<p>SSR_ONLINE_ADMNSS_EMAIL</p>	<p>SCC_COMMON: NOTIFICATION: BaseParameterProvider</p>
<p>Candidate Management</p> <p>(Records and Enrollment, Graduate Research Management, Candidate Management)</p>	<p>SCC_NTF_CON_20130925005929</p> <p>Candidate Mgmt Online Notifications</p>	<p>SCC_NTF_TMP_20130925003917 - Review Request</p>	<p>SSR_ONLINE_CAND_EMAIL</p>	<p>SCC_COMMON: NOTIFICATION: BaseParameterProvider</p>
<p>Candidate Management Override</p> <p>(Records and Enrollment, Graduate Research Management, Candidate Management Override)</p>	<p>SCC_NTF_CON_20130925005745</p> <p>Candidate Mgmt Override Online Notifications</p>	<p>SCC_NTF_TMP_20130925003704 - Review Request</p>	<p>SSR_ONLINE_OVRD_EMAIL</p>	<p>SCC_COMMON: NOTIFICATION: BaseParameterProvider</p>
<p>Administrator Profile</p> <p>(Records and Enrollment, Graduate Research Management, Administrator Profile)</p> <p>(Records and Enrollment, Academic Projects, Administrator Profile)</p>	<p>SCC_NTF_CON_20130925010053</p> <p>Admin Profile Online Notifications</p>	<p>SCC_NTF_TMP_20130925004112 - Review Admin Details</p>	<p>SSR_ONLINE_ADPRF_EMAIL</p>	<p>SCC_COMMON: NOTIFICATION: BaseParameterProvider</p>
<p>Thesis Management</p> <p>(Records and Enrollment, Graduate Research Management, Thesis Management)</p>	<p>SCC_NTF_CON_20130925005440</p> <p>Thesis Mgmt Online Notifications</p>	<p>SCC_NTF_TMP_20130925003223 - Thesis Review Request</p>	<p>SSR_ONLINE_THESIS_EMAIL</p>	<p>SCC_COMMON: NOTIFICATION: BaseParameterProvider</p>

Component/ Navigation	Notification Consumer ID / Consumer Name	Sample Template	Sample Generic Template	Application Class
Student Project Management (Records and Enrollment, Academic Projects, Student Project Management)	SCC_NTF_CON_20130925005546 Project Mgmt Online Notifications	SCC_NTF_TMP_20130925003433 - Project Review Request	SSR_ONLINE_PROJ_EMAIL	SCC_COMMON: NOTIFICATION: BaseParameterProvider

See “Setting Up and Consuming the Notifications Framework” (Campus Community Fundamentals)

The Send Notification button which launches the Create Notification page appears on the various pages in Research Tracking and Student Academic Project components (listed in the earlier table) only if the Notification Consumer ID defined for the component is set to *Active*. The Notification Consumer IDs are set to *Inactive* on delivery and need to be activated once the templates to be used have been set up.

Use the delivered sample templates and generic templates as examples for setting up your own notifications. We recommend that you use a naming convention that uniquely identifies online notifications from others defined in the Notification Framework setup. The generic template lists the available field variables that can be used to create your own notifications. These variables are values derived from the component from which the notification originates. All notification channels are supported. The template status must be set to *Active* in order to be selected in the Create Notification page.

See [Creating Online Notifications](#).

Following is a list of the variables that are delivered with each generic template. Each set of variables is intended for use in a designated component.

Include these variables in the Template Variables section of the generic template to create context-specific online notifications. To modify templates, go to PeopleTools, Workflow, Notifications, Generic Templates.

Template variables for Service Request Management notifications:

Value	Description
%1	Student ID
%2	Sender Name
%3	Student Name
%4	Recipient Name
%5	Status

Value	Description
%11	Comments
%28	Request Type
%29	Request Subtype
%50	Additional Comments / Free text

Template variables for Administrator Service Request notifications (accessed from the Service Request dashboard):

Value	Description
%1	Student ID
%2	Sender Name
%3	Student Name
%4	Recipient Name
%5	Status
%11	Comments
%28	Request Type
%29	Request Subtype
%50	Additional Comments / Free text

Template variables for Candidate Management notifications:

Value	Description
%1	Student ID
%2	Sender Name
%3	Student Name

Value	Description
%4	Recipient Name
%7	Candidate Number
%8	Academic Program
%9	Academic Plan
%13	Academic Career
%50	Additional Comments / Free text

Template variables for Candidate Management Override notifications:

Value	Description
%1	Student ID
%2	Sender Name
%3	Student Name
%4	Recipient Name
%7	Candidate Number
%8	Academic Program
%9	Academic Plan
%14	Candidate Career
%15	Candidate Program
%16	Candidate Plan
%17	Program Status
%18	Admission (Application) Program

Value	Description
%19	Admission (Application) Plan
%20	Admission Status
%21	Review Required
%22	Messages
%50	Additional Comments / Free text

Template variables for Administrator Profile notifications:

Value	Description
%1	Student ID
%2	Sender Name
%3	Student Name
%4	Recipient Name
%26	Administrator Type
%27	Administrator Role
%50	Additional Comments / Free text

Template variables for Thesis Management notifications:

Value	Description
%1	Student ID
%2	Sender Name
%3	Student Name
%4	Recipient Name

Value	Description
%5	Thesis Status
%6	Thesis Title
%7	Candidate Number
%8	Academic Program
%9	Academic Plan
%10	Submission Number
%11	Comments
%12	Evaluation Status
%50	Additional Comments / Free text

Template variables for Student Project Management notifications:

Value	Description
%1	Student ID
%2	Sender Name
%3	Student Name
%4	Recipient Name
%5	Project Status
%6	Project Title
%7	Project Number
%8	Academic Program
%9	Academic Plan

Value	Description
%10	Submission Number
%11	Comments
%12	Evaluation Status
%23	Term
%24	Session
%25	Class Number
%50	Additional Comments / Free text

Note: The list of variables contained in each message is delivered with your system and require extensive coding effort to be modified.

See “Setting Up and Consuming the Notifications Framework” (Campus Community Fundamentals)

Entering Ad Hoc Comments on the Create Notification Page

Besides providing template variables to include information on the originating page, online notifications also support the capture and sending of ad hoc text entered by the user. The %50 template variable performs this function. If used in a template, the Create Notification page automatically renders a comment box. The text entered by the user is then used in the notification like a regular template variable. We recommend using this feature only in the message body and not in the message Subject line.

See [Creating Online Notifications](#).

Setting Up Integration Broker For Research Administrator Profile Affiliations

The configuration steps outlined here are specific to administrators created using the Administrator Profile Management component used for Research Tracking (or Student Academic Projects) and cannot be extended for any other Campus Solutions feature.

It is assumed that basic Integration Broker setup is complete and working. For example, you have already set up your Integration Gateway.

See the product documentation for *PeopleTools: Integration Broker*

Note: Setting up Integration Broker is a technical task. Functional users should not perform this task.

Integration Broker Setup for Research Administrator Profile Affiliations

Complete the following Integration Broker steps to ensure that Research Supervisor functionality works as expected.

Note: This setup is a requirement for the Student Academic Projects feature.

1. Integration Broker Message:

PeopleTools > Integration Broker > Integration Setup > Messages > Message Definition

A Message Definition is delivered for processing affiliations created through the Administrative Profile Management component. This is a rowset-based message. Verify that the message `SSR_ADMN_AFFL_DATA_SYNC` is available in your database and that schema exists for the message. Refer to the following example:

The screenshot shows the 'Message Definition' configuration page. The 'Message' field is 'SSR_ADMN_AFFL_DATA_SYNC' and the 'Version' is 'VERSION_1'. The 'Description' is 'Admin Affiliation Data Sync' and the 'Owner ID' is 'Student Records'. The 'Comments' field contains: 'Message to publish Administrative Affiliation data. Administrative Affiliation data can contain Instructor/Advisor or Supervisor information'. The 'Schema Exists' checkbox is checked and labeled 'Yes'. The 'Message Type' is 'Rowset-based'. The 'Schema' tab shows a tree view of the message structure:

- SSR_ADMN_AFFL_DATA_SYNC
 - HCR_PERSON_I
 - EMPLID
 - BIRTHDATE
 - BIRTHPLACE
 - BIRTHCOUNTRY
 - BIRTHSTATE
 - DT_OF_DEATH
 - SSR_ADMN_HDR

Note: If the Schema does not exist, generate the schema using the Message Schema Builder.

2. Integration Broker Service:

PeopleTools > Integration Broker > Integration Setup > Services

An Integration Broker Service definition is created to communicate with the Affiliation framework. Verify that the Service definition SSR_ADMN_AFFL_DATA_SYNC is available in your database.

Services

Service SSR_ADMN_AFFL_DATA_SYNC REST Service Type

'Description

Comments

Service to publish the Administrative affiliation data entity changes

Service Alias

Owner ID

'Namespace

[Link Existing Operations](#) [View WSDL](#)

Service Operations

Service Operation

Operation Type

Existing Operations

Personalize | Find | View All | | |

First 1 of 1 Last

Operation	Message Links	EEB
Operation.Default Version	Description	Active
Operation Type		
SSR_ADMN_AFFL_DATA_SYNC.v1	SSR_ADMN_AFFL_DATA_SYNC.v1	<input checked="" type="checkbox"/>
Asynch	<input type="button" value="Minus"/>	

3. Integration Broker Service Operation:

PeopleTools > Integration Broker > Integration Setup > Service Operations > General

An Integration Broker Service Operation is created to communicate with the Affiliation framework. Verify that the Service Operation definition SSR_ADMN_AFFL_DATA_SYNC is available in your database.

Select the Active check box.

General | Handlers | Routings

Service Operation: SSR_ADMN_AFFL_DATA_SYNC
 Operation Type: Asynchronous - One Way
 *Operation Description: Admin Affiliation data Sync
 Operation Comments: Asynchronous Service Operation to publish Administrative Affiliation data
 Owner ID: Student Records
 Operation Alias:

User/Password Required
 *Req Verification: None
[Service Operation Security](#)

Default Service Operation Version

*Version: v1
 Version Description: SSR_ADMN_AFFL_DATA_SYNC.v1
 Version Comments: The first Version of Asynchronous Service Operation to publish Administrative Affiliation data
 Non-Repudiation
 Runtime Schema Validation
[Introspection](#)

Default Active

Routing Status	
Any-to-Local:	Does not exist
Local-to-Local:	Does not exist
Local-to-Atom:	Does not exist.

Routing Actions Upon Save

Generate Any-to-Local
 Generate Local-to-Local

After the Service Operation is Active, perform the following steps:

1. Generate Local-to-Local routing.

When you select the Generate Local-to-Local check box the Local-to-Local value appears. Additionally, system generated Routing information is populated on the Routings page.

2. Set up Security.

Click the Service Operation Security link to access the Web Service Access page and assign one or more permission lists to the service operation.

This example illustrates the Web Service Access page as explained above.

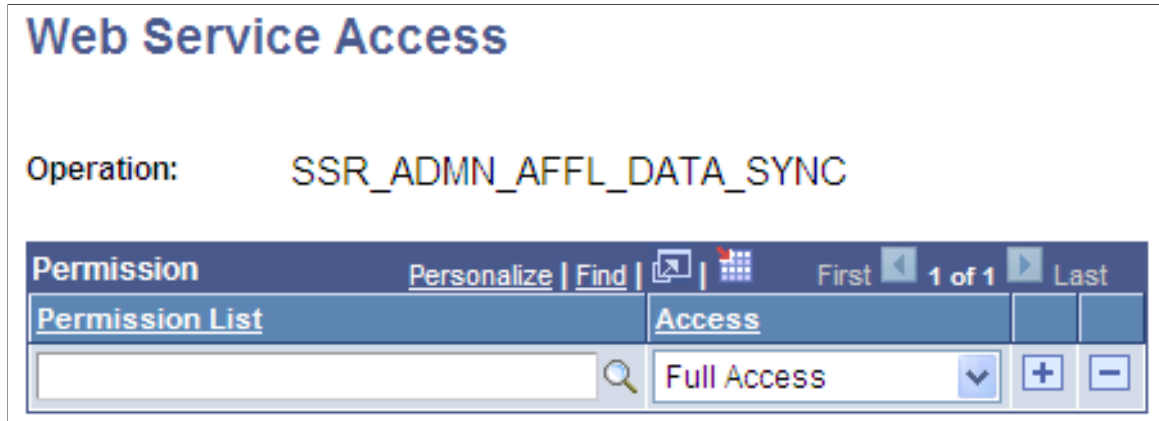

Additionally, ensure that the following Service Operation which is available in your database (SCC_CONSTITUENT_SYNC) is also Active and Service Operation Security has been set up.

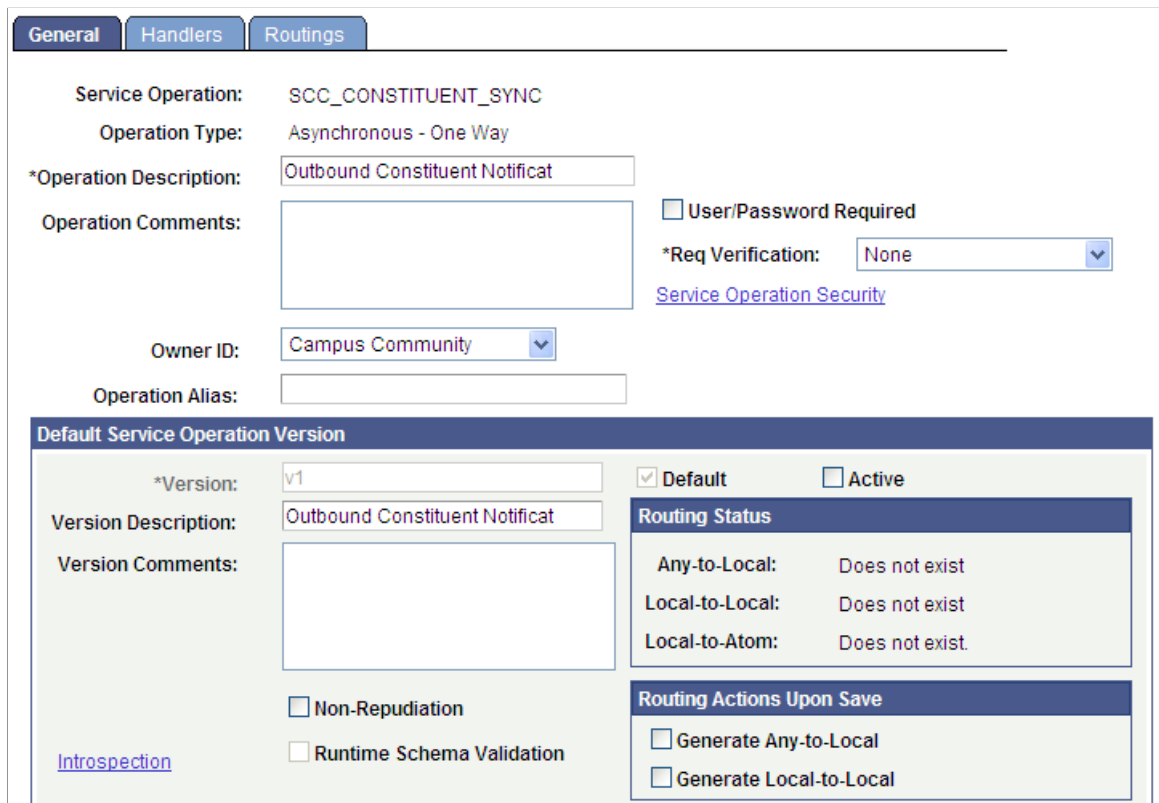

4. Integration Broker Service Operation Handler

PeopleTools > Integration Broker > Integration Setup > Service Operations > Handlers

An Integration Broker Service Operation Handler is delivered to support integration with the Affiliation framework. Verify that the following handler definition is available in your database.

Set the status to Active.

Service Operation: SSR_ADMN_AFFL_DATA_SYNC
 Default Version: v1
 Operation Type: Asynchronous - One Way

*Name	*Type	Sequence	*Implementation	*Status
Affiliations	On Notify	1	Application Class	Active

Additionally, set the following Integration Broker Service Operation Handler to Active:

Service Operation: SCC_CONSTITUENT_SYNC
 Default Version: v1
 Operation Type: Asynchronous - One Way

*Name	*Type	Sequence	*Implementation	*Status
ROUTERSENDHDLR	On Route		Application Class	Active

5. Service Operation Routing

Review the Service operation routing and note the local routing that was automatically generated when you saved the operation.

Service Operation: SSR_ADMN_AFFL_DATA_SYNC
 Default Version: v1
 Routing Name: Add

Selected	Name	Version	Operation Type	Sender Node	Receiver Node	Direction	Status
<input type="checkbox"/>	~GENERATED-69633166	v1	Asynch	HC900CMQ	HC900CMQ	Local	Active

Inactivate Selected Routings Activate Selected Routings

Additionally, review the Service operation routing and note the local routing that was automatically generated when you saved the operation for SCC_CONSTITUENT_SYNC.

Service Operation SCC_CONSTITUENT_SYNC
 Default Version v1
 Routing Name

Selected	Name	Version	Operation Type	Sender Node	Receiver Node	Direction	Status
<input type="checkbox"/>	SCC_CONSTITUENT_SYNC	v1	Asynch	HC900CMQ	HECH	Outbound	Active

6. Service Operation Queue Definition

A queue definition is delivered to support integration with the Affiliation framework. Verify that the following handler definition is available in your database.

Set the Queue Status to Run.

Queue Name SSR_ADMN_AFL_DATA
 Description Admin Affiliation Data queue Archive Unordered
 Comments Message Channel to publish Administrative Affiliation data
 Queue Status Run
 Owner ID Student Records

Operations Assigned to Queue

Service Operation	Version
SSR_ADMN_AFFL_DATA_SYNC	v1

Define Partitioning Fields

Include	Field	Alias Name
<input type="checkbox"/>	EMPLID	
<input type="checkbox"/>	BIRTHDATE	
<input type="checkbox"/>	BIRTHPLACE	
<input type="checkbox"/>	BIRTHCOUNTRY	
<input type="checkbox"/>	BIRTHSTATE	
<input type="checkbox"/>	DT_OF_DEATH	
<input type="checkbox"/>	OPERATIONNAME	
<input type="checkbox"/>	PUBLISHER	
<input type="checkbox"/>	PUBPROC	

Additionally, set the Queue Status to Run for the following queue definition (PERSON_DATA):

Queue Definitions

Queue Name: PERSON_DATA

Description: Archive Unordered

Comments: Queue Status: Owner ID:

Operations Assigned to Queue

Service Operation	Version
CS_ADM_APPL_DATA_FULLSYNC	VERSION_1
CS_ADM_PRSPCT_DATA_FULLSYNC	VERSION_1
CS_TEST_SCORES_FULLSYNC	VERSION_1
HCR_ADD_JOB	VERSION_1
HCR_ADD_JOB_ACK	VERSION_1
HCR_ADD_PERSON	VERSION_1
HCR_ADD_PERSON_ACK	VERSION_1
HCR_CAN_JOB	VERSION_1
PERSON_ACCOMP_FULLSYNC	VERSION_1
PERSON_ACCOMP_SYNC	VERSION_1

Define Partitioning Fields

Include	Field	Alias Name
<input type="checkbox"/>	OPERATIONNAME	<input type="text"/>
<input type="checkbox"/>	PUBLISHER	<input type="text"/>
<input type="checkbox"/>	PUBPROC	<input type="text"/>

Buttons: Save, Return, Add Field

7. Constituent Event Registry

Setup SACR > System Administration > Utilities > Constituent Management > Constituent Event Registration

A Constituent Event (SSR_ADMN_AFFL_DATA_SYNC) is registered to support integration with the Affiliation framework. Verify that following entry is available in your database.

Constituent Event Registration

***Event Name:** 

Description:

Details:

Implementation Class

***Root Package ID:** 

***Qualified Package/Class Path** 

***Application Class ID** 

8. SOA Framework Event Registry

Setup SACR > System Administration > Integrations > Event Register

An event is registered in Campus Solutions SOA Framework to support integration with the Affiliation framework. Verify that following entry is available in your database and is Active.

Event Registry

Service Operation: SSR_ADMN_AFFL_DATA_SYNC Active

Description: SSR_ADMN_AFFL_DATA_SYNC event

Long Description: Event registry entry for SSR_ADMN_AFFL_DATA_SYNC service operation

Owner ID: Student Records ▼

Batch Replay Chunk Size:

Event Replay Support Effective Dated Filtering

Application Class

Package Name: 🔍

Path: 🔍

Application Class ID: 🔍

See “Understanding Constituent Web Services” (Campus Community Fundamentals)

See “Outbound and Inbound Services” (Campus Community Fundamentals)

See “Configuring Constituent Event Triggers” (Campus Community Fundamentals)

See “Configuring Notification Handlers” (Campus Community Fundamentals)

See “Defining Affiliations” (Campus Community Fundamentals)

See “Setting Up Enrollment and Course Batch Processing” (Student Administration Integration Pack)

Setting Up Student Academic Projects

Understanding Student Academic Projects

The Student Academic Project feature supports student projects that result in either a written thesis or dissertation. The feature supports an evaluation by committee, that utilizes the Evaluation Management feature.

Characteristics of the Student Academic Project feature:

- Participating students are already admitted and matriculated.
- The student projects result in a thesis, dissertation, or a similar deliverable.
- Institution can associate projects with a term, term session, or with a particular course offered in a specific term and session.
- Projects may be assigned by the instructor or proposed by the student(s).
- The completed project may be evaluated by a committee of evaluators, or by an individual evaluator. A final grade for the project is recorded.
- The institution may associate a job or internship placement with the project.

Setting Up Academic Project Types

This section discusses how to set up academic project types.

Page Used to Set Up Academic Project Types

<i>Page Name</i>	<i>Definition Name</i>	<i>Navigation</i>	<i>Usage</i>
Academic Project Types	SSR_PROJ_TYPE	Set Up SACR > Product Related > Student Records > Student Projects Setup > Academic Project Types	Define the type of projects. Examples of academic project type include: thesis, dissertation, case study, and internship.

Defining Academic Project Types

Access the Academic Project Types page (**Set Up SACR > Product Related > Student Records > Student Projects Setup > Academic Project Types**).

This example illustrates the fields and controls on the Academic Project Types page. You can find definitions for the fields and controls later on this page.

Academic Project Types

Academic Institution: PSUNV PeopleSoft University

Project Type: HON

[Find](#) | [View All](#) First ◀ 1 of 1 ▶ Last

***Effective Date:** ***Effective Status:**

***Description:**

***Group Code:** Honors Project

<i>Field or Control</i>	<i>Description</i>
Group Code	Select a group code. The available values are those defined on the Process Status Codes page with a System Usage of <i>Project</i> . The process status codes defined for the group code are used to manage academic projects of this type. See Setting Up Research Status Codes

Setting Up Process Status Codes

Use the Process Status Codes page (Set Up SACR, Product Related, Student Records, Research Management, Process Status Codes) to set up status codes that are used for managing the student academic project.

See [Setting Up Research Status Codes](#)

Using Common Attribute Framework for Student Academic Projects

The Common Attribute Framework enables you to define a common attribute and add the common attribute as a data field to any Campus Solutions page. A user can then enter a value on the page for the data field.

Use the Common Attribute Framework to create attributes for the Student Academic Projects feature. Create attributes using the Common Attribute component (Set Up SACR, Common Definitions, Common Attributes Setup, Common Attribute) and then use the Record Context component (Set Up SACR, Common Definitions, Common Attributes Setup, Record Context) to associate attributes with a particular record.

See “Defining a Common Attribute” (Campus Community Fundamentals)

See “Associating a Common Attribute to a Record” (Campus Community Fundamentals)

The Student Project Management component pages are enabled for Common Attribute Framework. The Common Attribute Framework Record Name and Attribute Records for Student Project Management component are:

Common Attribute Framework Record Name	Attribute Record	How Common Attribute Framework Record is Accessed
SSR_RS_THESIS	SSR_RS_THESISCA	SSR_RS_THESIS: Student Project Management, Project Management page, Additional Information link
SSR_RS_SUPRVSRS	SSR_RS_SUPRS_CA	SSR_RS_SUPRVSRS: Student Project Management, Additional Details page, Supervisors section, Additional Information link
SSR_RS_OTHRQDTL	SSR_RS_OTREQ_CA	SSR_RS_OTHRQDTL: Student Project Management, Additional Details page, Assignments section, Additional Information link

Note: These are the same Common Attribute Framework records used in the Research Management feature's Candidate Management and Thesis Management components. By default, attributes added for these records appear in both the Student Project and Research Management areas. You can configure attributes exclusively for either the research or academic project pages using Common Attribute Framework attribute filter class (SSR_RS_RESEARCH:CAF_Filters:ResearchAttributeFilter) and work entities (ResearchManagement, AcademicProject) on the Common Attribute Framework Record Context setup page.

For information about the Student Project Management component, see [Creating and Managing a Student Academic Project](#)

The Common Attribute Framework Record Name and Attribute Record for Academic Project Topic Setup component are:

Common Attribute Framework Record Name	Attribute Record	How Common Attribute Framework Record is Accessed
SSR_RS_TPCSETUP	SSR_RS_TPCST_CA	Academic Project Topics, Additional Details page

For information about the Academic Project Topic Setup component, see [Setting Up Academic Project Topics](#)

Related Links

[Using Common Attribute Framework for Research Tracking](#)

Setting Up Demographic Data Usage

Use the Demographic Data Use page (Set Up SACR, Product Related, Student Records, Research Management, Demographic Data Use) to set up the address, email, and telephone usage to be associated with the Student Academic Projects module. Currently, the Academic Project Topics Setup - Contact information uses this setup.

Related Links

“Establishing Address Usages” (Campus Community Fundamentals)

“Establishing Phone Usages” (Campus Community Fundamentals)

Defining Student Academic Project Topic Categories

Use the Research Topic Category page (Set Up SACR, Product Related, Student Records, Research Management, Research Topic Categories, Research Topic Category) to create research topic categories for assignment to Student Academic Project topics.

Note that the Display in Self Service check box is not applicable for Student Academic Project topics.

See [Defining Research Topic Categories](#)

Setting Up Academic Project Topics

This section discusses how to:

- Define academic project topics.
- Review available academic project supervisors.
- Associate organizations and contacts with academic project topics.
- Enter additional information.
- Enter attachments.

Page Used to Set Up Academic Project Topics

<i>Page Name</i>	<i>Definition Name</i>	<i>Navigation</i>	<i>Usage</i>
Academic Project Topics – Topic Setup	SSR_RS_TOPIC_SETUP	Set Up SACR > Product Related > Student Records > Student Projects Setup > Academic Project Topics > Topic Setup	Create the project topics that are offered at the institution. Provide information about the topics, including a description and the academic programs and plans to which they are associated.

Page Name	Definition Name	Navigation	Usage
Academic Project Topics – Available Supervisors	SSR_RS_TOPIC_SUP	Set Up SACR > Product Related > Student Records > Student Projects Setup > Academic Project Topics > Available Supervisors	View all available supervisors who have academic programs or academic plans that match the topic.
Academic Project Topics – Organization and Contacts	SSR_RS_ORG_CONTACT	Set Up SACR > Product Related > Student Records > Student Projects Setup > Academic Project Topics > Organization and Contacts	Associate one or more academic or external organization(s) with the project topic and set up contacts for the project topic.
Academic Project Topics – Additional Information	SSR_RS_TOPICST_CA	Set Up SACR > Product Related > Student Records > Student Projects Setup > Academic Project Topics > Additional Information	Enter and review Common Attribute fields associated with the topic. This page appears only if Common Attribute fields have been created using the Common Attribute Framework.
Academic Project Topics – Attachments	SSR_RS_TOPICST_ATT	Set Up SACR > Product Related > Student Records > Student Projects Setup > Academic Project Topics > Attachments	Add one or more attachments for a topic.

Defining Academic Project Topics

Access the Academic Project Topics – Topic Setup page (**Set Up SACR > Product Related > Student Records > Student Projects Setup > Academic Project Topics > Topic Setup**).

This page is similar to the Research Topic Setup – Topic Setup page but the Display in Self Service check box is not functional here.

See [Defining Research Topics](#).

Reviewing Available Academic Project Supervisors

Access the Academic Project Topics – Available Supervisors page (**Set Up SACR > Product Related > Student Records > Student Projects Setup > Academic Project Topics > Available Supervisors**).

This page is similar to the Research Topic Setup – Available Supervisors page.

The page displays eligible project supervisors who can be assigned to the project topic. Eligibility is based on the supervisor's ability to participate in the same academic program and academic plan as the topic. Eligible persons are defined as project supervisors in the Administrator Profile component.

See [Reviewing Available Research Supervisors](#).

Associating Organizations and Contacts with Academic Project Topics

Access the Academic Project Topics – Organization and Contacts page (**Set Up SACR > Product Related > Student Records > Student Projects Setup > Academic Project Topics > Organization and Contacts**).

This page is similar to the Research Topic Setup – Organizations and Contacts page, but the Display in Self Service check box is not functional here.

See [Associating Organizations and Contacts with Research Topics](#).

Entering Additional Information

Access the Academic Project Topics – Additional Information page (**Set Up SACR > Product Related > Student Records > Student Projects Setup > Academic Project Topics > Additional Information**).

This page is similar to the Research Topic Setup – Additional Information page and is used to enter data for school-defined fields using the Common Attribute Framework.

See [Entering Additional Information](#).

Entering Attachments

Access the Academic Project Topics – Attachments page (**Set Up SACR > Product Related > Student Records > Student Projects Setup > Academic Project Topics > Attachments**).

Use this page, which is similar to the Research Topic Setup – Attachments page, to store project related documents. This information is currently not accessible to students in self service.

See [Entering Attachments](#).

Setting Up Project Supervisors

This section discusses how to set up the *project supervisor* administrator role. It discusses how to:

- Define administrators.
- Set up Integration Broker for profile affiliations.
- Define and manage administrator profiles.
- Define supervisor roles.

Defining Administrators

Use the Affiliation Setup component and the Academic Institution 10 page to define administrators (project supervisors) for Student Academic Project.

See [Defining Administrators](#)

Setting Up Integration Broker For Profile Affiliations

This is a technical task not for functional users.

See [Setting Up Integration Broker For Research Administrator Profile Affiliations](#)

Defining and Managing Administrator Profiles

Use the Administrator Profile Management page (Records and Enrollment, Academic Projects, Administrator Profile, Administrator Profile Management) to enter and track administrators who can participate as project supervisors. On this page, you can track the qualifications of the administrator and the approval of those qualifications. Also, manage academic areas of participation and availability of the administrator.

This page can also be accessed by selecting Records and Enrollment, Graduate Research Management, Administrator Profile, Administrator Profile Management.

See [Defining and Managing Administrator Profiles](#)

Defining Supervisor Roles

Use the Supervisor Roles page (Set Up SACR, Product Related, Student Records, Research Management, Supervisor Roles, Supervisor Roles) to define the valid supervisor roles for the institution.

The values that you define here are available in the Supervisor Role field on the Additional Details page in the Student Project Management component.

See [Creating and Managing a Student Academic Project](#)

See [Setting Up Research Administrators](#)

Defining Additional Business Assignments

Use the Assignment Type Options page (Set Up SACR, Product Related, Student Records, Research Management, Assignment Types, Assignment Type Options) to define additional business requirements that can be assigned to projects.

These assignments can be maintained in the Student Project Management component on the Additional Details page.

See [Defining Additional Business Assignments](#)

Defining Online Edits Using the Rules Engine

The Rules Engine has been integrated for use in the Academic Project Management component to support local business policies. Rules can be written to perform online editing of a student's project and display

a warning message to administrator. A sample rule has been provided. To define rules about online edits, see [Setting Up Rules for Online Edits](#).

Setting Up Online Notifications for Student Projects

You can set up online notification capability for the Student Project Management and Administrator Profile pages.

See [Setting Up Online Notifications](#)

See [Using Online Notifications](#)

Setting Up Evaluation Management for Student Projects

To evaluate and score student projects, complete the Evaluation Management System setup.

- Evaluation categories, evaluation codes, and evaluation schemes necessary to create the evaluation must be set up.
- Committees of evaluators must be defined to support evaluations performed by committee.
- Additional setup as required by Evaluation Management System based on additional functionality desired.

See “Setting Up Evaluation Codes” (Campus Community Fundamentals)

See “Defining Evaluation Categories” (Campus Community Fundamentals)

See “Defining Committees for Evaluation Management” (Campus Community Fundamentals) “Defining Individual Evaluator Schemes” (Campus Community Fundamentals)

Preparing to Consolidate and Report Academic Statistics

Prerequisites for Preparing to Consolidate and Report Academic Statistics

Before you can consolidate academic statistics and use them for reporting, you must perform prerequisite setup tasks. After you complete the prerequisites, you can run the Consolidate Academic Statistics process (SRPCCONP) to generate consolidated statistics data on students and then create reports based on this data.

Set up the following items for reporting:

1. Academic Institution. See [Setting Up Academic Institutions for Reporting](#)
2. Academic careers and programs. [Setting Up Academic Careers and Academic Programs for Reporting](#)
3. Academic level and load rules. [Setting Up Academic Level and Load Rules for Reporting](#)
4. Student attributes. [Setting Up Student Attributes for Reporting](#)
5. Extracurricular activities. [Setting Up Extracurricular Activities for Reporting](#)
6. National Student Clearinghouse (NSC) branch codes. [Setting Up Branch Codes for NSC Reporting](#)
7. Statistic period types. [Setting Up Statistic Period Types](#)
8. Academic statistics periods. [Setting Up Academic Statistics Periods](#)
9. NSC program level. [Setting Up For NSC Program Level Reporting](#)

Setting Up Academic Institutions for Reporting

Use the Academic Institution 3 page to set up the default student attribute for cohort that your academic institution uses for cohort reporting. Use this page also to define NSC reporting options, such as the default Federal Interagency Committee on Education (FICE) code for your academic institution, and how the NSC Extract process calculates each student's anticipated graduation date.

Related Links

“Defining Academic Institutions” (Campus Solutions Application Fundamentals)

Setting Up Academic Careers and Academic Programs for Reporting

Complete the following setup tasks for academic careers and programs:

- Define primacy for academic careers on the Academic Career Table 2 page and for programs on the Academic Program page.

Because reporting agencies require that you report a student at a given point in time under one academic career and one academic program, define primacy for all academic careers and programs. When the Consolidate Academic Statistics process (SRPCCONP) encounters a student who is active in multiple academic careers or academic programs for an academic statistics period, the process locates the student's primary academic career and program, based on the student's academic career and program that have the lowest primacy number at the academic institution. The process consolidates all of the student's academic career, program, level, load, and other academic statistic information into one record for reporting. For example, a student might be actively enrolled in a JD program and an MA program. These academic programs might be within different academic careers. At any point in time, the student might be enrolled part-time in the JD program and part-time in the MA program. By defining primacy, the Consolidate Academic Statistics process can calculate a student's level and load under one primary academic career and program, using *all* the level and load elements on a student's record. If the JD program has the lower primacy number at the academic institution, the student is reported full-time under the JD program. The process uses the institutional-level primacy rather than the student-level primacy so that the reports always coincide with your institution's financial aid processing.

- Indicate, on the Academic Career Table 2 page, whether an academic career qualifies as graduate level for reporting purposes.
- Indicate, on the Academic Program page, whether students in an academic program are eligible for financial aid.

The Consolidate Academic Statistics process excludes from its process calculations the academic programs in which students are not eligible for financial aid.

Related Links

“Setting Additional Academic Career Parameters” (Campus Solutions Application Fundamentals)

“Describing Academic Programs” (Campus Solutions Application Fundamentals)

Setting Up Academic Level and Load Rules for Reporting

Use the Level/Load Rules component to define academic level and load rules for *every* academic career. The Consolidate Academic Statistics process (SRPCCONP) uses the defined rules to locate a student's academic level and load.

Related Links

“Defining Academic Level and Load Rules” (Campus Solutions Application Fundamentals)

Setting Up Student Attributes for Reporting

Use the Student Attributes page to assign student attribute and student attribute values to a student, and to indicate the primacy of each one. The Consolidate Academic Statistics process (SRPCCONP) locates a student's primary cohort based on the data on this page. You can then use students' primary cohort data for reporting and analysis.

Related Links

[Tracking Student Attributes](#)

Setting Up Extracurricular Activities for Reporting

Use the Extracurricular Activity Table page to define extracurricular activity codes and to define the primacy of the extracurricular activities for your setID. Before you can track extracurricular activities for students, set up these extracurricular activity codes. After you set up the codes, you can use the Extracurricular Activity page in Student Records or PeopleSoft Recruiting and Admissions to track extracurricular activities for individuals.

Related Links

[Tracking Extracurricular Activities](#)

Setting Up Branch Codes for NSC Reporting

To set up branch codes, use the NSC Branch Table component (NSLC_BRANCH_TBL).

This section discusses how to define NSC branch codes for NSC reporting.

Page Used to Set Up NSC Branch Codes

<i>Page Name</i>	<i>Definition Name</i>	<i>Navigation</i>	<i>Usage</i>
NSC Branch Table (National Student Clearinghouse branch table)	NSLC_BRANCH_TBL	Set Up SACR > Product Related > Student Records > Enrollment Reporting Codes > NSC Branch Table > NSC Branch Table	Define the branch codes that your academic institution uses when reporting enrollment status to the NSC.

Defining NSC Branch Codes for Reporting

Access the NSC Branch Table page (**Set Up SACR > Product Related > Student Records > Enrollment Reporting Codes > NSC Branch Table > NSC Branch Table**).

This example illustrates the fields and controls on the NSC Branch Table page. You can find definitions for the fields and controls later on this page.

The screenshot shows the 'NSC Branch Table' interface. At the top, it displays 'Academic Institution: PSUNV PeopleSoft University'. Below this are fields for '*Branch Code: 81', '*Effective Date: 01/01/1900', 'Status: Active', '*Description: PSUNV', and 'Short Description: PSUNV'. A table below lists academic programs with columns for 'Acad Prog', 'Campus', and 'Career'. The table contains four rows: 'MED' (Medicine), an empty row, 'Medical', and 'WALCR' (Walnut Creek Campus) with 'D.V.M.' as the career.

The NSC requires that your institution defines a branch code for each group of students that has its own reporting time line. For example, if you have multiple campuses at your academic institution, and you are reporting each of these campuses separately to the NSC at different times of the year, you might use a different branch code for each campus.

Another example is if your institution has academic programs that are running on different calendars. For instance, your institution has a law program, a medical program, an undergraduate program, and a graduate program. Whereas the undergraduate and graduate programs might run on a semester term type, the law and medical programs might run on quarter term type. In such a case, your institution might use different branch codes for the semester programs and the quarter programs.

Field or Control	Description
Academic Institution	Select the academic institution for which you are defining the branch code.
Branch Code	Enter the branch code for the academic institution according to the NSC contractual agreement.
Acad Prog (academic program)	(Optional) Select the academic program associated with this branch code so that when you run the NSC Extract process, it reports data for only these students.
Campus	(Optional) Select the campus associated with this branch code so that when you run the NSC Extract process, it reports data for only these students.
Career	(Optional) Select the academic career associated with this branch code so that when you run the NSC Extract process, it reports data for only these students.

Setting Up Statistic Period Types

To set up statistic period types, use the Academic Statistics Type component (ACAD_STAT_TYPE).

This section discusses how to define statistic period types.

Page Used to Set Up Statistic Period Types

Page Name	Definition Name	Navigation	Usage
Academic Statistics Type	ACAD_STAT_TYPE	Records and Enrollment > Enrollment Reporting > Consolidated Statistics > Define Statistics Type > Academic Statistics Type	Define statistics period types.

Defining Statistics Period Types

Access the Academic Statistics Type page ((**Records and Enrollment** > **Enrollment Reporting** > **Consolidated Statistics** > **Define Statistics Type** > **Academic Statistics Type**).

This example illustrates the fields and controls on the Academic Statistics Type page. You can find definitions for the fields and controls later on this page.

Academic Statistics Type

Statistics Period Type: N

Find | View All First 1 of 1 Last

Effective Date: 01/01/1900 Status: Active

*Description: NSLC

Short Description: NSLC

Enforce FA Eligibility IPEDS Report NSC Report

Include the Following Program Statuses		Include if Term Activated		
1	Active in Program		+	-
2	Completed Program		+	-
3	Discontinued	<input checked="" type="checkbox"/>	+	-
4	Deceased	<input checked="" type="checkbox"/>	+	-
5	Dismissed	<input checked="" type="checkbox"/>	+	-
6	Leave of Absence	<input checked="" type="checkbox"/>	+	-
7	Suspended	<input checked="" type="checkbox"/>	+	-

Year CIP Code Published: 2010

Exclude Withdrawal Grades						Personalize Find	First 1-2 of 2 Last
*SetID	*Grading Scheme		*Grading Basis		*Grade Input		
PSUNV	UGD	Undergrad	GRD	Graded	WF	+	-
PSUNV	GRA	Graduate	GRD	Graded	WF	+	-

Statistics period types are descriptors of an academic statistics period, helping to identify the type of reporting requirement that relates to a particular academic statistics period. For example, you might define the statistics period type *IP* for IPEDS reporting, *N* for NSC reporting, and *SR* for the Student Record Census report. You can later attach statistics period types to academic statistics periods on the Academic Statistics Period page.

Field or Control	Description
Enforce FA Eligibility (enforce financial aid eligibility)	<p>Select to have the Consolidate Academic Statistics process (SRPCCONP) use the value of the Financial Aid Eligible check box on the Academic Program page for this statistics period type.</p> <p>Clear this check box to have the Consolidate Academic Statistics process disregard the value of the Financial Aid Eligible check box on the Academic Program page for this statistics period type. The Consolidate Academic Statistics process will retrieve all students that meet its processing parameters, regardless of the financial aid eligibility of the student's academic program.</p> <p>For example, you would clear this check box for any statistics period type in which you need to report statistics for all students regardless of their financial aid eligibility.</p>
IPEDS Report	<p>Select to identify an academic statistics type as being used for IPEDS reporting purposes. This field is available only when the installation country (INSTALLATION.COUNTRY) = USA.</p> <p>When attached to an academic statistics period, an IPEDS Report statistics type identifies the statistics period as an IPEDS reporting period, which enables the Consolidate Academic Statistics process (SRPCCONP) to report a student's ethnicity according to the IPEDS reporting requirements.</p>
NSC Report	<p>Select to identify the statistics type to be used for NSC Reporting. When you select the check box, the Year CIP Code Published field and the Exclude Withdrawal Grades grid become available.</p> <hr/> <p>Note: For information about excluding grades from academic load calculation for NSC Reporting, see Understanding Consolidated Statistics Processes.</p> <hr/>
Academic Program Status	<p>Select the students' academic program status for the Consolidate Academic Statistics process to consider and include in its results. For an academic statistics period to which this statistics period type is attached, the Consolidate Academic Statistics process includes in its results only the students with the academic program statuses specified here.</p> <p>Thus, you can define various statistics period types for different reporting needs. For example, you can define a statistics period type for NSC reporting that includes all of the academic program statuses that your institution is required to report to the NSC.</p>

Field or Control	Description
<p>Include if Term Activated</p>	<p>This check box is available for all Academic Program Status values other than <i>Active in Program</i> and <i>Completed Program</i> (because the Consolidate Academic Statistics process always selects these values).</p> <p>When the check box is selected, the process includes students with a non-active status, if they are term activated in the reporting term. For example, you select the Include if Term Activated check box for the program status of <i>Leave of Absence</i> for a particular statistics period type. You then run the process for a statistics period, with the updated statistics period type, and a date of 09/15/2007. The reporting term is Fall 2007 (8/30/2007 – 12/12/2007). A student has a program status of <i>Leave of Absence</i>, with an effective dated row of 07/15/2007 – the student's program is therefore not active at the begin date of the reporting term. However, if the student is term activated for Fall 2007, the Consolidate Academic Statistics process includes this student's record.</p>
<p>Year CIP Code Published (Year Classification of Instructional Program Code Published)</p>	<p>This field is available when the NSC Report check box is selected. The value that you enter here is used by in the NSC extract process to provide the program CIP Year value. You can update the year to 2020 once you're ready to begin reporting CIP 2020 codes for NSLDS.</p> <p>See Understanding Consolidate Academic Statistics Process Calculations</p>
<p>Exclude Withdrawal Grades</p>	<p>Use this grid to identify the grades that are to be excluded when calculating academic load for a statistics period with this statistics type. When a grade is listed in the Grade Input field, the Consolidated Statistics process (SRPCCONP) excludes the units associated with any student enrollment record that includes that grade. Using the page example above, if a student has a total of 12 units for a statistics period, and 3 of those units are graded with a WF, the process uses only the remaining 9 units to calculate the student's academic load.</p> <hr/> <p>Note: For information about excluding grades from academic load calculation for NSC Reporting,</p> <hr/> <p>See Understanding Consolidated Statistics Processes.</p>

Setting Up Academic Statistics Periods

To set up academic statistics periods, use the Academic Statistics Period component (ACAD_STATS_PERIOD).

This section provides an overview of academic statistic periods and discusses how to define them.

Understanding Academic Statistics Periods

An academic statistics period is the rule that the Consolidate Academic Statistics process (SRPCCONP) uses to control exactly when and how it functions. An academic statistics period defines the valid academic career and term combinations that the Consolidate Academic Statistics process uses to collect various academic statistics for students. An academic statistics period also defines the academic level and load rules and the statistics period type that the process uses.

The Consolidate Academic Statistics process locates the valid academic career and term combinations, based on the snapshot date for the academic statistics period. Valid academic career and term combinations can overlap each other and start and end independently yet can also roll up into one academic statistics period. You can even roll up different term values, such as semesters and quarters, into one academic statistics period.

In the following diagram, the semester and quarter terms from different academic careers roll up into one academic statistics period:

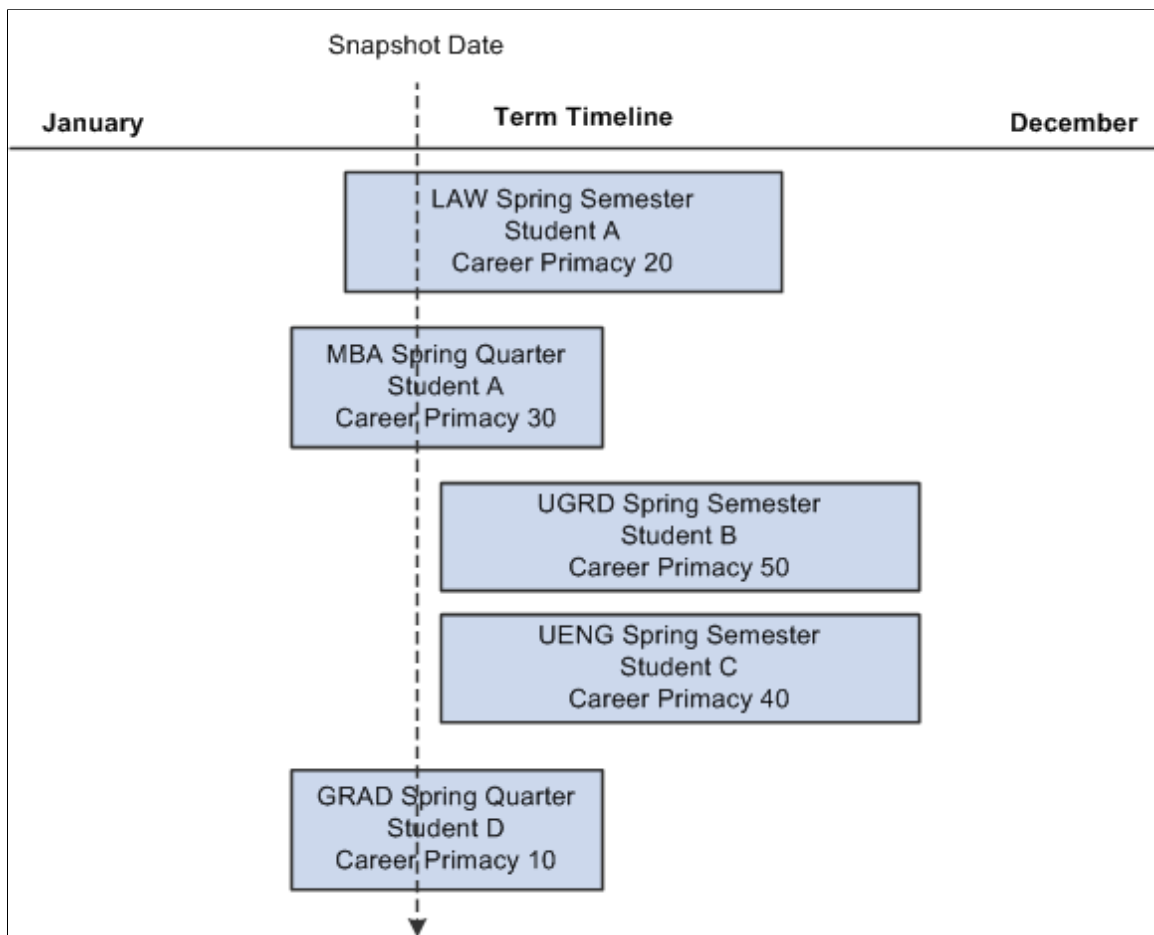

The vertical line defines the valid academic career and term combinations for the academic statistics period. The Consolidate Academic Statistics process gathers data for students in all academic career and term combinations that the line passes through. If a student has only one academic career in these terms, the process calculation is straightforward. However, if a student has multiple academic careers in these terms, such as how Student A has LAW and MBA academic careers, the process uses the academic career with the lowest primacy number to calculate the student's academic statistics. In this scenario, the process

uses LAW as the primary academic career for Student A and converts the student's MBA units from quarter units to semester units.

For information about NSC program level reporting, see [Setting Up For NSC Program Level Reporting](#).

Page Used to Set Up Academic Statistics Periods

Page Name	Definition Name	Navigation	Usage
Academic Statistics Period	ACAD_STATS_PERIOD	Records and Enrollment > Enrollment Reporting > Consolidated Statistics > Define Statistics Period > Academic Statistics Period	Describe an academic statistics period, including the statistics period type, academic load rule, consolidation trigger, and snapshot date.

Defining Academic Statistics Periods

Access the Academic Statistics Period page (**Records and Enrollment** > **Enrollment Reporting** > **Consolidated Statistics** > **Define Statistics Period** > **Academic Statistics Period**).

This example illustrates the fields and controls on the Academic Statistics Period page. You can find definitions for the fields and controls later on this page.

Academic Statistics Period

Academic Statistics Period: SPR14-01A PeopleSoft University

*Description: Short Description:

*Statistics Period Type: NSLC

*Academic Load Rule:

*Consolidation Trigger:

As of Date:

Aid Year: Financial Aid Year 2013 - 2014

*Academic Career	*Term	Term	Term Type	*Snapshot Date		
BUSN	0720	2014 Spr	Semester	02/09/2014	+	-
GRAD	0720	2014 Spr	Semester	02/09/2014	+	-
LAW	0715	2014 WIQT	Quarter	02/09/2014	+	-
UGRD	0720	2014 Spr	Semester	02/09/2014	+	-

Setting Up Academic Statistics Periods

Field or Control	Description
Description and Short Description	<p>Enter a description and short description for this academic statistics period. The system uses these descriptions on various pages to identify this academic statistics period.</p> <p>The system also uses these descriptions for the header record of the NSC Extract report. The NSC requires that the header record of the extract include the academic term for the reported data, such as spring 2012 or fall 2012. Be sure to include this information in the descriptions as necessary. For NSC academic statistics periods, use descriptions such as <i>Fall 2012-1st NSC Run</i>, <i>Fall 2012-2nd NSC Run</i>, and <i>Fall 2012-3rd NSC Run</i> so that your institution can distinguish between the numerous runs of the NSC Extract report. The detailed descriptions are especially useful if you are running the NSC Extract process multiple times within the same reporting period. By specifying, on the Consolidated Statistics page, the academic statistics period used as the source for the previous NSC extract, you can easily distinguish between the statistics of the previous NSC extract and the next NSC extract.</p>
Statistics Period Type	<p>Select a statistics period type, which is a descriptor of an academic statistics period. The statistics period type identifies the type of reporting requirement for which you are using this academic statistics period. For example, you might have defined the statistics period type <i>IP</i> for IPEDS reporting, <i>N</i> for NSC reporting, and <i>SR</i> for the Student Record Census report.</p> <p>Because the statistics period type can affect the results of the Consolidate Academic Statistic process and the reports derived from these results, be sure that you select a statistics period type that meets your reporting needs.</p>

Field or Control	Description
Academic Load Rule	<p>Select the academic load rule for the system to use when consolidating academic statistics. The Consolidate Academic Statistics process (SRPCCONP) uses your selection to calculate each student's academic load: full-time, half-time, part-time.</p> <p><i>Term Load Rule Applies:</i> When you run the Consolidate Academic Statistics process for an academic statistics period in which you have set this field to <i>Term Load Rule Applies</i> and the Load Determination field on the Level/Load Rules Table page to <i>Units</i>, the Consolidate Academic Statistics process uses the defined academic load rules from the Academic Level Table page to calculate a student's academic load, NSC academic load, and financial aid load. If you have set the Load Determination field on the Level/Load Rules Table page to <i>manual</i> or <i>default</i>, the Consolidate Academic Statistics process uses the student's career-term record or the value you enter in the Default Academic Load field, respectively, to calculate the student's academic loads, regardless of the setting for this field.</p> <p><i>Contiguous Terms:</i> Contiguous terms are consecutive terms in which you combine academic load information. Use this option for your academic load rule when you are combining student career-term records for consecutive terms. When you run the Consolidate Academic Statistics process for an academic statistics period in which you have set this field to <i>Contiguous Terms</i>, the Consolidate Academic Statistics process uses the defined contiguous-term academic load rules from the Statistics Period Load page to calculate a student's academic load, NSC academic load, and financial aid load. Thus, the process is able to accurately reflect each student's academic load for the combined terms.</p> <p>For example, if 12 units equals a full-time academic load for an individual-term academic load rule, but you want to combine two consecutive terms during the Consolidate Academic statistics process, indicate on the Statistics Period Load page that 24 units equals a full-time academic load. If you do not define contiguous-term academic load rules, the Consolidate Academic Statistics process reports anyone with 12 or more units as full-time for that academic statistics period, which might not accurately reflect your data.</p>

Field or Control	Description
Consolidation Trigger	<p>Select from the following choices the consolidation trigger to instruct the Consolidate Academic Statistics process which snapshot date to use. The snapshot date is the date that the process uses to locate the valid academic career and term combinations for this academic statistics period.</p> <hr/> <p>Note: If you select a consolidation trigger of <i>As of Date</i> or <i>As of Today</i>, the Consolidate Academic Statistics process takes the class start and end dates for all classes in which the student is actively enrolled and compares it to the snapshot date to determine if a student's class units should count towards her or his academic level and load calculation.</p> <hr/> <ul style="list-style-type: none"> • <i>As of Date:</i> Select to have the Consolidate Academic Statistics process base the snapshot date on the date in the As of Date field. • <i>As of Today:</i> Select to have the Consolidate Academic Statistics process base the snapshot date on the current system date when you run the process. • <i>Consolidation Date:</i> Select to have the Consolidate Academic Statistics process generate the statistics based on values retrieved from the term statistics instead of the calculating the values based on the student's enrollment on a specific date. Depending on which consolidation option you use, the consolidation date is used slightly different. <p>When you select this option, a grid in the lower portion of the page appears for you to specify multiple academic career and terms combinations for each individual snapshot date for the consolidation. When this option is selected, you must run either the Take Term Statistics Snapshot process (SRPCCONA) or the Recurring Term Snapshot process (SRPCCONU) before running the Consolidated Academic Statistics process. Both SRPCCONA and SRPCCONU retrieve PS_STDNT_CAR_TERM information for each student active in the specified academic career and term combination for the corresponding row in the grid and stores the values in a temporary holding table, PS_STDNT_CARTRM_PD.</p> <p>If a consolidation is needed for the term, you should run the SRPCCONA process. This process consolidates enrollment by term using statistics from PS_STDNT_CAR_TERM. The snapshot date in this case is used for effective date processing when retrieving data from the setup tables. This process can also be rerun as often as needed, allowing for new students to be brought</p>

Field or Control	Description
	<p>into the consolidation as well as updating the data for students who have had academic history changes since the previous run. This type of reporting is appropriate for processes like National Student Clearinghouse processing, where the units for the term are important, not the date when the snapshot of the data occurs.</p> <p>If you want to take a snapshot of the student’s term statistics on a specific date, you enter the appropriate date as the snapshot date in the consolidation details and run the SRPCCONU process.</p> <hr/> <p>Note: You must run the process on the snapshot date for it to return data.</p> <hr/> <p>The snapshot date is also used for effective date processing when retrieving data from the setup tables. Once run, the snapshot process cannot be rerun and trying to do so results in the process failing. If the data must be regenerated, either the existing data must be deleted from PS_STDNT_CARTRM_PD table or a new statistics type period must be created. This type of processing would be appropriate for census date reporting and consolidating units across multiple terms to be reported in a larger unit, such as an academic year.</p> <p>After running the Consolidation Date process for all the rows listed in the grid, you must then run the Consolidate Academic Statistics process (SRPCCONP). This process uses the date in the As of Date field as the effective date for all effective dated processes used in the consolidation of the data. For a student to be present in the consolidation, the student must have a <i>valid program status as defined for this statistics type</i> for the specified academic career / term combinations defined and have records in the temporary holding table (PS_STDNT_CARTRM_PD).</p> <hr/> <p>Note: The Consolidated Academic Statistics process derives NSC program level data only if the Consolidation Trigger of <i>Consolidation Date</i> is selected (and the NSC Report check box is selected on the Academic Statistics Type page).</p> <p>See: Setting Up For NSC Program Level Reporting Understanding Consolidate Academic Statistics Process Calculations</p> <hr/>

Field or Control	Description
As of Date	<p>This field becomes available when you select <i>As of Date</i> or <i>Consolidation Date</i> in the Consolidation Trigger field. If you select <i>As of Date</i> as your consolidation trigger, the Consolidate Academic Statistics process uses this date as the snapshot date. If you select <i>Consolidation Date</i> as your consolidation trigger, the Consolidate Academic Statistics process uses the date in this field as the effective date for all records that it generates. The date in this field must be after the latest snapshot date in the grid in the lower portion of this page. This ensures that the academic statistics for all of the academic career and term combinations have been gathered and stored in the temporary holding table prior to consolidation.</p>
Aid Year	<p>This field is available when the NSC Report check box is selected for the statistics period type on the Academic Statistics Type page. The value that you enter here is used to retrieve Credential Level Cross Reference and Title IV Weeks values from Financial Aid setup data.</p> <p>See Setting Up For NSC Program Level Reporting</p>

Defining Valid Academic Career, Term, and Snapshot Date Combinations

When you define an academic statistics period to have *Consolidation Date* for its *consolidation trigger*, the system displays a grid in the lower portion of that page for you to enter the specific academic career, term, and snapshot date combinations to include in this academic statistics period. When you run the Take Recurring Term Snapshot process, it accepts as valid only the combinations on this grid for the given academic statistics period. The process gathers the most current statistics on students active in these academic career and term combinations as of the run date, then stores this data in a temporary holding table (PS_STDNT_CARTRM_PD) for future consolidation through the Consolidate Academic Statistics process.

To gather statistics that reflect different times of the year, you must run the Take Recurring Term Snapshot process on a regular basis because the statistics themselves are based on the run date, not the snapshot date.

For example, perhaps you have a fall semester and a spring semester for each of your academic careers and your want to combine the historic academic statistics for all of these academic career and term combinations so that you have year-long academic statistics for your entire academic institution.

In the grid, indicate that you want to take one snapshot in the fall term and one snapshot in the spring term for each academic career. Set the academic statistics period to a consolidation mode of *insert* so that you do not overwrite the data in the temporary holding table on subsequent runs of the Take Recurring Term Snapshot process.

On or shortly following each snapshot date for all of the academic career and term combinations listed for the academic statistics period, run the Take Recurring Term Snapshot process (through the Consolidated Statistics page) to capture the data current as of the run date for these academic career and term combinations. The process writes the data to the temporary holding table.

After running the Recurring Term Snapshot process for all of the academic career and term combinations listed for the academic statistics period, run the Consolidate Academic Statistics process to consolidate the academic statistics for this academic statistics period. The process consolidates each student's academic statistics for all applicable rows in the temporary holding table.

Field or Control	Description
Academic Career	Select the academic career that the Take Recurring Term Snapshot process will consider as part of a valid combination for this academic statistics period.
Term	Select the term within the academic career that the Take Recurring Term Snapshot process will consider as part of a valid combination for this academic statistics period.
Snapshot Date	<p>Select the date that the Take Recurring Term Snapshot process should be run for this academic career and term combination. For the process to consider this academic career and term combination valid, the term must be in progress as of the specified date.</p> <hr/> <p>Note: If you select a consolidation trigger of <i>As of Date</i> or <i>As of Today</i>, the Consolidate Academic Statistics process takes the class start and end dates for all classes in which the student is actively enrolled and compares it to the snapshot date to determine if a student's class units should count towards her or his academic level and load calculation.</p> <hr/>

Related Links

[Understanding Consolidate Academic Statistics Process Calculations](#)

“Defining Academic Level and Load Rules” (Campus Solutions Application Fundamentals)

Setting Up For NSC Program Level Reporting

Institutions must report program level data for students enrolled in eligible programs, in addition to overall enrollment status and status effective date data. This means that if a student is pursuing multiple programs, an institution must report enrollment data by program in addition to overall (per student) enrollment status-related data. Within the single row of data per student required by the National Student Clearinghouse (NSC), columns are available to report up to six sets of program level data (enrollment status, program start date and so on) per student.

In Campus Solutions, the requirement to report program level data is managed as follows:

- The Consolidated Statistics process reports all of a student’s eligible Academic Plans. A plan is identified as an eligible NSC program using an attribute in the Academic Plan Table.

- The process reports a maximum of six NSC programs across all of a student's academic careers for the specified Consolidated Statistics reporting period. The career consolidation logic that determines career primacy and program/plan primacy within each career has not changed.

Steps for Implementing NSC Program Level Reporting

1. In Update Image 28, we delivered a number of options to allow institutions to change the way they report program-level enrollment data to NSC. We provided these options in response to updated guidance from NSC. These options are set at the academic institution level (**Set Up SACR > Foundation Tables > Academic Institution Table**).

See “Setting Additional Institution Defaults and Options” (Campus Solutions Application Fundamentals).

2. Academic Plan Table: You must identify the academic plans that should be reported as NSC programs, as well as define related NSC data. NSC program level data is sourced from the Academic Plan Table (**Set Up SACR > Foundation Tables > Academic Structure > Academic Plan Table**).

See “Setting Up Taxonomy” (Campus Solutions Application Fundamentals).

3. Financial Aid Set Up: Work with your Financial Aid office to ensure that the SULA Credential Level Cross Reference page is populated and that Title IV Weeks of Instruction data is available for students (by Aid Year).

Credential Level values are entered on the SULA Credential Level Cross Reference page which maps Academic Plan Table NSC Classification values to SULA Credential Level values (**Set Up SACR > Product Related > Financial Aid > Loans > COD > Credential Cross Reference**).

See: “Setting Up 150 Percent Direct Subsidized Loan Limit (SULA)” (Financial Aid)

The **Title IV Weeks of Instruction** field is required when reporting program data where the published program length is measured in weeks or months. Financial Aid Academic Base Weeks is used to populate this field and the value is determined according to an established hierarchy.

See:

[Understanding Consolidate Academic Statistics Process Calculations](#)

“Establishing Defaults” (Financial Aid)

4. Statistics Type: Update (or create) your NSC Statistics Type: Enter a Year CIP Code Published value.

See [Setting Up Statistic Period Types](#)

5. Statistics Period(s): Create Academic Statistics Period(s) for NSC Reporting. The statistics period must use a **Consolidation Trigger** of *Consolidation Date* and you must assign an **Aid Year** value so that the process can access Financial Aid set up data.

See [Setting Up Academic Statistics Periods](#)

Chapter 19

(AUS) Setting Up Government Reporting

Understanding Australian Government TCSI Reporting

This section discusses the government departments that require higher education reporting.

Prerequisites

In order to generate required government reports, in addition to the setup covered in the topics specific to Australian government reporting, you must set up these tables:

- Field of Study AUS
- Field of Education AUS
- Discipline Group Table AUS
- AOU Code Table AUS
- Program Code Table AUS
- Program Type Table AUS
- Level/Load Rules Table

See “Setting Up Reporting Codes” (Campus Solutions Application Fundamentals).

See “(AUS) Defining Level Dependent Load Rules” (Campus Solutions Application Fundamentals).

See “(AUS) Setting Up Australian Academic Programs” (Campus Solutions Application Fundamentals).

The Government Departments That Require Higher Education Reporting

The Australian Department of Education requires all institutions in Australia that receive funding from the Commonwealth government to provide statistical reports about programs offered, student enrollments and academic load, student liabilities under the Higher Education Loan Program (HELP), Commonwealth scholarships, enrollment and program completions, and application data.

The Australian Tax Office (ATO) also requires institutions to provide information about students and their HELP debts that are to be recovered through the taxation system. In a simple process for institutions, all returns are forwarded to the Department of Education, which forwards the necessary information to the ATO.

Related Links

[TCSI Reporting](#)

Connecting to the TCSI System

To use the TCSI system, you need to set up Campus Solutions (CS) to connect to TCSI. Before you set up CS, make sure your organization is registered in PRODA.

Note: You must use PeopleTools 8.57 or later.

This section describes:

- [Configuring Campus Solutions to Connect to TCSI](#)
- [Providing Device Registration Details](#)
- [Testing Your Connection](#)
- [Testing Your Connection to the Errors API](#)
- [Configuring the Integration Broker for TCSI/PRODA Endpoints](#)

Pages Used to Connect to the TCSI System

<i>Page Name</i>	<i>Definition Name</i>	<i>Navigation</i>	<i>Usage</i>
Organisation	SSR_HM_ORG	Records and Enrollment Reporting > AUS Regulatory Reporting > TCSI > TCSI API Setup > Organisation	Enter the organization information Oracle gave you.
Devices	SSR_HM_DEVICES	Records and Enrollment Reporting > AUS Regulatory Reporting > TCSI > TCSI API Setup > Devices	Provide the device information you registered in PRODA.
Campuses API Test	SSR_HM_CAMPUS_GET	Records and Enrollment Reporting > AUS Regulatory Reporting > TCSI > TCSI API Setup > Campus API Test	Test whether your configuration is correct by retrieving a list of all your campuses in TCSI.
Errors API Test	SSR_HM_ERR_IMPORT	Records and Enrollment Reporting > AUS Regulatory Reporting > TCSI > TCSI API Setup > Errors API Test	Retrieve a list of all available errors from TCSI.

Page Name	Definition Name	Navigation	Usage
Services	IB_SERVICEDEFN	PeopleTools > Integration Broker > Integration Setup > Service Definitions	Update test URLs to production URLs.

Configuring Campus Solutions to Connect to TCSI

Access the Organisation page (**Records and Enrollment > Enrollment Reporting > AUS Regulatory Reporting > TCSI > TCSI API Setup > Organisation**).

Field or Control	Description
Organization ID	Enter the ID you were assigned when you registered your organization in PRODA.
Organization Name	Enter the name your organization was assigned when you registered in PRODA.
Client ID	Enter the ID that Oracle provided to your organization. There will be different IDs for test and production.
Software Name	Enter the name that Oracle provided to your organization. Oracle may provide your organization its own production client ID to minimize potential impacts from the TCSI call rate limit.

Providing Device Registration Details

Access the Devices page (**Records and Enrollment > Enrollment Reporting > AUS Regulatory Reporting > TCSI > TCSI API Setup > Devices**).

Use the Devices page to enter the B2B device registration details. For information on registering a B2B device, go to the [PRODA website](#). Once your device is active, it stays active for six months. To renew your registration, generate a new code in PRODA.

Field or Control	Description
Device Name	Enter the name of the B2B device you registered in PRODA. You can use separate devices for each environment.

Field or Control	Description
Device Activation Code	<p>Enter the unique activation code that PRODA gave you. This code is valid for seven days, and you're responsible for remembering the code.</p> <p>If you misplace your code or it expires, you can generate a new one in PRODA.</p>
Auto-Refresh Keys n Days Before Expiry	<p>Enter a number that's used to determine when a new device key is automatically generated before the current key expires. If this date/time falls within the number of days from the current date, a new key is automatically generated. By default, this field is set to 3.</p> <p>When you run a TCSI process, it checks the TTL value. If it falls within the "Auto-Refresh Keys n Days Before Expiry" window, 3 days from expiry as shown in the screenshot, a new PRODA device key is generated.</p>
Activate Device	<hr/> <p>Note: This button is available only when you set up your B2B device in CS for the first time.</p> <hr/> <p>Click to switch on communication between CS and TCSI. This process establishes that the device and activation code are active. When you activate your device, PRODA sends a response with the expiry date and time of the device key. CS stores the expiry date and time, and uses this to determine when to automatically refresh your device key.</p>
Refresh Device Key	<p>Once you have activated your device, this button appears. When you renew registration, click to activate the new activation code you received from PRODA.</p> <hr/> <p>Note: When you specify a value in Auto-Refresh Keys n Days Before Expiry, CS automatically refreshes your device key for you. You would only use the Refresh Device Key process if you need to manually reactivate your device. In that event, you must get a new activation code from PRODA, enter the new activation code in Device Activation Code, and then click Refresh Device Key.</p> <hr/>
Authenticate Device	<p>Click to authenticate your device's connection with TCSI. This process establishes that you have a valid access token. When you run the TCSI Migration, Course/Campus, and Student Data processes, the processes will authenticate the device automatically as required.</p> <p>The Campuses API Test and Errors API Test pages show that your device is authenticated.</p>

Testing Your Connection

Access the Campuses API Test page (**Records and Enrollment > Enrollment Reporting > AUS Regulatory Reporting > TCSI > TCSI API Setup > Campus API Test**).

Use this page to test whether CS can connect to the TCSI System.

Once your device is authenticated, this page will show the authentication status, and you can click **Get All Campuses** to retrieve the list of campuses for your institution. In Response Message, the response from the TCSI system appears. To confirm whether the API call was successful, look in the second line for **“success”: true**.

Testing Your Connection to the Errors API

Access the Errors API Test page (**Records and Enrollment > Enrollment Reporting > AUS Regulatory Reporting > TCSI > TCSI API Setup > Errors API Test**).

When you run the TCSI Migration, Course/Campus, and Student Data processes, you may encounter a TCSI error. When this happens, the error ID is stored with the transaction ID in the `SSR_HM_TX_ERROR` table. If this is the first time you come across an error, the error message details are stored in the `SSR_HM__ERROR` table. Over time, TCSI may change the description, details, and resolution of errors. This page lets your institution refresh all error descriptions, details, and resolutions by calling the TCSI Error API endpoint. Once your device is authenticated on the [Devices](#) page, you can click **Import All Errors** to retrieve the list of TCSI errors.

Configuring the Integration Broker for TCSI/PRODA Endpoints

Access the Services page (**PeopleTools > Integration Broker > Integration Setup > Service Definitions**).

The PUM image is configured with the test URLs that point to the TCSI REST API endpoints. Once you're ready to move to your production environment, you must update the test URLs to production URLs.

To update the URLs in Integration Broker:

1. Navigate to the Services page.
2. In Service, enter **SSR_HEIMS**.
3. Select **REST Service**, then click **Search**.
4. From the list of services, click **SSR_HEIMS**. You should see all the service operations that correspond to TCSI endpoints.
5. In the list of existing operations, select a TCSI service operation.
6. On the General page, in REST Base URL, update the value with the production URL, then click **Save**.
7. Click **Return to Service**, then repeat steps 5-7 until you've updated all REST Base URLs.

Here's the list of endpoints, their corresponding service operations, and their test and production URLs.

Endpoint	Service Operations	Test URL	Production URL
aggregated-awards	AGGREGATED_AWARDS_DELETE AGGREGATED_AWARDS_GET AGGREGATED_AWARDS_PATCH AGGREGATED_AWARDS_POST	https://test.api.humanservices.gov.au/centrelink/ext-vend/tcsi/b2g/v1/aggregated-awards	https://api.humanservices.gov.au/centrelink/ext/tcsi/b2g/v1/aggregated-awards
campuses	CAMPUSES_DELETE CAMPUSES_GET CAMPUSES_PATCH CAMPUSES_POST	https://test.api.humanservices.gov.au/centrelink/ext-vend/tcsi/b2g/v1/campuses	https://api.humanservices.gov.au/centrelink/ext/tcsi/b2g/v1/campuses
courses	COURSES_DELETE COURSES_GET COURSES_PATCH COURSES_POST	https://test.api.humanservices.gov.au/centrelink/ext-vend/tcsi/b2g/v1/courses	https://api.humanservices.gov.au/centrelink/ext/tcsi/b2g/v1/courses
courses-of-study	COURSES_OF_STUDY_DELETE COURSES_OF_STUDY_GET COURSES_OF_STUDY_PATCH COURSES_OF_STUDY_POST	https://test.api.humanservices.gov.au/centrelink/ext-vend/tcsi/b2g/v1/courses-of-study	https://api.humanservices.gov.au/centrelink/ext/tcsi/b2g/v1/courses-of-study
courses-on-campus	COURSES_ON_CAMPUS_DELETE COURSES_ON_CAMPUS_GET COURSES_ON_CAMPUS_PATCH COURSES_ON_CAMPUS_POST	https://test.api.humanservices.gov.au/centrelink/ext-vend/tcsi/b2g/v1/courses-on-campus	https://api.humanservices.gov.au/centrelink/ext/tcsi/b2g/v1/courses-on-campus

Endpoint	Service Operations	Test URL	Production URL
course-admissions	COURSE_ADMISSIONS_DELETE COURSE_ADMISSIONS_GET COURSE_ADMISSIONS_PATCH COURSE_ADMISSIONS_POST	https://test.api.humanservices.gov.au/centrelink/ext-vend/tcsi/b2g/v1/course-admissions	https://api.humanservices.gov.au/centrelink/ext/tcsi/b2g/v1/courses-admissions
device activation	DEVICE_ACTIVATION_PUT	https://test.5.rsp.humanservices.gov.au/piaweb/api/b2b	https://5.rsp.humanservices.gov.au/piaweb/api/b2b
device authentication	DEVICE_AUTHENTICATION_POST	https://vnd.proda.humanservices.gov.au/mga/sps/oauth/oauth20/token	https://proda.humanservices.gov.au/mga/sps/oauth/oauth20/token
device key refresh	DEVICE_KEY_REFRESH_PUT	https://test.5.rsp.humanservices.gov.au/piaweb/api/b2b	https://5.rsp.humanservices.gov.au/piaweb/api/b2b
early-exit-awards	EARLY_EXIT_AWARDS_DELETE EARLY_EXIT_AWARDS_GET EARLY_EXIT_AWARDS_PATCH EARLY_EXIT_AWARDS_POST	https://test.api.humanservices.gov.au/centrelink/ext-vend/tcsi/b2g/v1/early-exit-awards	https://api.humanservices.gov.au/centrelink/ext/tcsi/b2g/v1/early-exit-awards
errors	ERRORS_GET	https://test.api.humanservices.gov.au/centrelink/ext-vend/tcsi/b2g/v1/errors	https://api.humanservices.gov.au/centrelink/ext/tcsi/b2g/v1/errors
help-balances	HELP_BALANCES_GET	https://test.api.humanservices.gov.au/centrelink/ext-vend/tcsi/b2g/v1/help-balances	https://api.humanservices.gov.au/centrelink/ext/tcsi/b2g/v1/help-balances

Endpoint	Service Operations	Test URL	Production URL
loans	LOANS_DELETE LOANS_GET LOANS_PATCH LOANS_POST	https://test.api.humanservices.gov.au/centrelink/ext-vend/tcsi/b2g/v1/loans	https://api.humanservices.gov.au/centrelink/ext/tcsi/b2g/v1/loans
notifications	NOTIFICATIONS_GET	https://test.api.humanservices.gov.au/centrelink/ext-vend/tcsi/b2g/v1/notifications	https://api.humanservices.gov.au/centrelink/ext/tcsi/b2g/v1/notifications
students	STUDENTS_DELETE STUDENTS_GET STUDENTS_PATCH STUDENTS_POST	https://test.api.humanservices.gov.au/centrelink/ext-vend/tcsi/b2g/v1/students	https://api.humanservices.gov.au/centrelink/ext/tcsi/b2g/v1/students
units-of-study	UNITS_OF_STUDY_GET	https://test.api.humanservices.gov.au/centrelink/ext-vend/tcsi/b2g/v1/units-of-study	https://api.humanservices.gov.au/centrelink/ext/tcsi/b2g/v1/units-of-study
unit-enrolments	UNIT_ENROLMENTS_DELETE UNIT_ENROLMENTS_GET UNIT_ENROLMENTS_PATCH UNIT_ENROLMENTS_POST	https://test.api.humanservices.gov.au/centrelink/ext-vend/tcsi/b2g/v1/unit-enrolments	https://api.humanservices.gov.au/centrelink/ext/tcsi/b2g/v1/unit-enrolments

Here are examples of updating Integration Broker URLs.

This example illustrates the fields and controls on the Service Operations page.

Service Operations

General
Routings

Service Operation AGGREGATED_AWARDS_DELETE

REST Method DELETE

***Operation Description**

Operation Comments

Aggregated Awards DELETE

Owner ID

Operation Alias Used with Think Time Methods

REST Resource Definition

REST Base URL

URI Template Format Example: weather/{state}/{city}?forecast={day}

URI	Personalize Find	First	1-2 of 2	Last
1 /:uid	Validate Build	Validate	Build	+ -
2 /:uid/course-specialisations/:course-specialisations-uid	Validate Build	Validate	Build	+ -

Document Template [View Message](#)

Default Service Operation Version

***Version** Default Active

Version Description

Version Comments

Runtime Schema Validation

Response Message

Message Instance

Type Response

Message.Version [View Message](#)

Content-Type [Optional Content-Types](#)

Status Code [Optional Status Codes](#)

Setting Up TCSI Reporting Codes

This section provides an overview of TCSI reporting codes and discusses how to:

- Set up institution codes.
- Set up country codes.
- Map country codes to country codes.
- Set up language codes.

- Map language codes to language codes.
- Set up citizenship and residency codes.
- Set up citizenship and residency mapping.
- Set up processing.
- Set up level of education codes.
- Set up program on campus.
- Identify CS locations for TCSI.
- Map types of impairment with disability codes.
- Map program actions and reasons to completion codes.

Understanding TCSI Reporting Codes

To comply with the TCSI reporting requirements, you use special TCSI codes when reporting data. You map these codes to the codes used in the PeopleSoft Campus Solutions system. In most cases, you need to set up the TCSI codes only once. If TCSI codes change, you must change the setup to reflect those changes.

In some cases, the TCSI codes are delivered as translate values for fields. It is important that you don't change these translate values unless there is a change in the TCSI code.

Pages Used to Set Up TCSI Reporting Codes

<i>Page Name</i>	<i>Definition Name</i>	<i>Navigation</i>	<i>Usage</i>
Institution Code	SSR_INST_DEST	Set Up SACR > Product Related > Student Records > Enrollment Reporting Codes > AUS Regulatory Report Setup > Institution Code > Institution Code	Define Higher Education Provider (HEP) codes for TCSI reporting.
Country Code Table	SSR_CNTRY_TB2_DEST	Set Up SACR > Product Related > Student Records > Enrollment Reporting Codes > AUS Regulatory Report Setup > Country Code Table > Country Code Table	Use the Standard Australian Classification of Countries (SACC) to define country codes. This is required for TCSI reporting.

Page Name	Definition Name	Navigation	Usage
Country Table	SSR_CNTRY_TBL_DEST	Set Up SACR > Product Related > Student Records > Enrollment Reporting Codes > AUS Regulatory Report Setup > Country Table > Country Table	Map PeopleSoft country codes to TCSI country codes for TCSI reporting.
Language Code Table	SSR_LANG2_DEST	Set Up SACR > Product Related > Student Records > Enrollment Reporting Codes > AUS Regulatory Report Setup > Language Code Table > Language Code Table	Define language codes for TCSI element 348.
Language Table	SSR_LANG_DEST	Set Up SACR > Product Related > Student Records > Enrollment Reporting Codes > AUS Regulatory Report Setup > Language Table > Language Table	Map PeopleSoft language codes to TCSI language codes defined for element 348.
Unit Status Indicator	SSR_DEST_ELEM_355	Set Up SACR > Product Related > Student Records > Enrollment Reporting Codes > AUS Regulatory Report Setup > Unit Status Indicator > Unit Status Indicator	Define unit of study completion status codes for TCSI element 355.
Unit Status Mapping	SSR_MAP_355	Set Up SACR > Product Related > Student Records > Enrollment Reporting Codes > AUS Regulatory Report Setup > Unit Status Mapping	Map grades to unit of study completion status codes.
Citizen/Res Indicator	SSR_DEST_ELEM_358	Set Up SACR > Product Related > Student Records > Enrollment Reporting Codes > AUS Regulatory Report Setup > Citizen/Res Indicator > Citizen/Res Indicator	Define the TCSI Citizen/Res Indicator codes for element 358. The system includes these codes in the Student Help files.

Page Name	Definition Name	Navigation	Usage
Citizen/Resident Mapping	SSR_MAP_358	Set Up SACR > Product Related > Student Records > Enrollment Reporting Codes > AUS Regulatory Report Setup > Citizen/Resident Mapping > Citizen/Resident Mapping	Map citizenship status codes to TCSI citizen/resident codes for element 358. The system assigns the mapped citizenship status codes to the imported person data.
Reporting Setup	SSR_DEST_SETUP	Set Up SACR > Product Related > Student Records > Enrollment Reporting Codes > AUS Regulatory Report Setup > Reporting Setup > Reporting Setup	Allocate address usages for reporting address elements to TCSI and assign reporting years to the institution for TCSI submissions. This allows the system to track the submission number for half-year reporting.
Level of Education VET	SSR_DEST_ELEM_563	Set Up SACR > Product Related > Student Records > Enrollment Reporting Codes > AUS Regulatory Report Setup > Level of Education VET > Level of Education VET	Define level of education codes.
Program on Campus	SSR_HEIMS_CRSE_CAM	Set Up SACR > Product Related > Student Records > Enrollment Reporting Codes > AUS Regulatory Report Setup > Program on Campus	Set up course fees for a program on campus that becomes active based on the Course Fee Effective From Date.
Campus Location	SSR_HM_CAMP_LOC	Set Up SACR > Product Related > Student Records > Enrollment Reporting Codes > AUS Regulatory Report Setup > Campus Location	Identify CS locations that should be considered a campus for TCSI and identify the provider type.
Disability Mapping	SSR_DISABILITY_MAP	Set Up SACR > Product Related > Student Records > Enrollment Reporting Codes > AUS Regulatory Report Setup > Disability Mapping	Map types of impairment with E615 disability codes.

Page Name	Definition Name	Navigation	Usage
E599 Completion Code Mapping	SSR_HEIMS_PCC_MAP	Set Up SACR > Product Related > Student Records > Enrollment Reporting Codes > AUS Regulatory Report Setup > E599 Completion Code Mapping	Map program actions and action reasons to E599 program completion codes.
E446 Remission Reason Mapping	SSR_HM_REMRSN_MAP	Set Up SACR > Product Related > Student Records > Enrollment Reporting Codes > AUS Regulatory Report Setup > E446 Remission Reason Mapping	Map enrollment action reasons to TCSI remission reason codes.
E329 Mode of Attendance Map	SSR_HM_MODEATT_MAP	Set Up SACR > Product Related > Student Records > Enrollment Reporting Codes > AUS Regulatory Report Setup > E329 Mode of Attendance Map	Map instruction modes to TCSI mode of attendance codes.

Setting Up Institution Codes

Access the Institution Code page (**Set Up SACR > Product Related > Student Records > Enrollment Reporting Codes > AUS Regulatory Report Setup > Institution Code > Institution Code**).

This example illustrates the fields and controls on the Institution Code page. You can find definitions for the fields and controls later on this page.

Institution Code

Undergraduate Institution Code: 1004

Find | View All
First 1 of 1 Last

*Effective Date:	<input type="text" value="01/01/1900"/>		*Status:	<input type="text" value="Active"/>	+ -
*Description:	<input type="text" value="University of Adelaide"/>				
Short Description:	<input type="text" value="University"/>	<input checked="" type="checkbox"/>	HEIMS HEP Code		
Credit Basis:	<input type="text"/>		Provider Type VET:	<input type="text"/>	

These codes are provided by TCSI. Set up codes for all your institutions, and for institutions from which you receive transfer students.

Field or Control	Description
Credit Basis	<p>Enter the value to be reported for TCSI Element 561 Credit-Basis, if the institution code is assigned to manual course credits processed for a student.</p> <p>This field appears only if the DEST, HECS, Centrelink, TAC check box is selected on the SA Features page.</p>
Provider Type VET	<p>Enter the value to be reported for TCSI Element 564 Provider Type, if the institution code is assigned to manual course credits processed for a student.</p> <p>This field is optional. If the institution does not offer VET related study, you do not have to enter a value.</p> <p>This field appears only if the DEST, HECS, Centrelink, TAC check box is selected on the SA Features page.</p>

Setting Up TCSI Country Codes

Access the Country Code Table page (**Set Up SACR > Product Related > Student Records > Enrollment Reporting Codes > AUS Regulatory Report Setup > Country Code Table > Country Code Table**).

Setting up the country codes for TCSI reporting requires that you enter the TCSI country codes into your system, then map each TCSI country code to the appropriate country code defined in the system. Map country codes to TCSI country codes on the Country Table page.

Mapping Country Codes to TCSI Country Codes

Access the Country Table page (**Set Up SACR > Product Related > Student Records > Enrollment Reporting Codes > AUS Regulatory Report Setup > Country Table > Country Table**).

This example illustrates the fields and controls on the Country Table page. You can find definitions for the fields and controls later on this page.

Country Table					
Effective Date:		01/01/2000			
Personalize Find View 100 First 1-20 of 223 Last					
Country		DEST Country Code			
ABW	Aruba	8403	Aruba	+	-
AFG	Afghanistan	7201	Afghanistan	+	-
AGO	Angola	9201	Angola	+	-
AIA	Anguilla	8401	Anguilla	+	-
ALB	Albania	3201	Albania	+	-
AND	Andorra	3101	Andorra	+	-
ANT	Netherlands Antilles	8418	Netherlands Antilles	+	-
ARE	United Arab Emirates	4216	United Arab Emirates	+	-
ARM	Armenia	7202	Armenia	+	-
ATA	Antarctica	1600	Antarctica, nfd	+	-
ATG	Antigua and Barbuda	8402	Antigua & Barbuda	+	-
AUS	Australia	1100	Australia	+	-
AUT	Austria	2301	Austria	+	-
AZE	Azerbaijan	7203	Azerbaijan	+	-

Note: Set up TCSI country code values on the Country Code Table page.

Field or Control	Description
Country	Select a PeopleSoft defined country code.
DEST Country Code	Enter the equivalent TCSI defined country code.

Setting Up TCSI Language Codes

Access the Language Code Table page (**Set Up SACR > Product Related > Student Records > Enrollment Reporting Codes > AUS Regulatory Report Setup > Language Code Table > Language Code Table**).

Setting up the language codes for TCSI reporting requires that you enter the TCSI language codes into your system, then map each TCSI language code with the appropriate language code in the system. Map language codes to TCSI language codes on the Language Table page.

Mapping Language Codes to TCSI Language Codes

Access the Language Table page (**Set Up SACR > Product Related > Student Records > Enrollment Reporting Codes > AUS Regulatory Report Setup > Language Table > Language Table**).

This example illustrates the fields and controls on the Language Table page. You can find definitions for the fields and controls later on this page.

Language Code	Language Code	Language Code		
BO	Bengali	5201	Bengali	+ -
CM	Chinese (Mandarin)	7104	Mandarin	+ -
EN	English	0001	English	+ -
FR	French	2101	French	+ -
KI	Kiswahili	0003	African languages nec	+ -
KO	Korean	7301	Korean	+ -
PO	Portuguese	0060	Portuguese	+ -
RU	Russian	3402	Russian	+ -
SI	Swahili	5202	Gujarati	+ -

Note: Set up TCSI language code values on the Language Code Table page.

Field or Control	Description
Language Code (on left.)	Select a PeopleSoft defined language code.
Language Code (on right.)	Enter the equivalent TCSI language code.

Setting Up TCSI Citizenship and Residency Codes

Access the Citizen/Res Indicator page (**Set Up SACR > Product Related > Student Records > Enrollment Reporting Codes > AUS Regulatory Report Setup > Citizen/Res Indicator > Citizen/Res Indicator**).

TCSI citizenship and residency codes are provided by TCSI. Map citizenship codes to TCSI citizen/resident codes on the Citizen/Resident Mapping page.

Setting Up TCSI Citizenship and Residency Mapping

Access the Citizen/Resident Mapping page (**Set Up SACR > Product Related > Student Records > Enrollment Reporting Codes > AUS Regulatory Report Setup > Citizen/Resident Mapping > Citizen/Resident Mapping**).

This example illustrates the fields and controls on the Citizen/Resident Mapping page. You can find definitions for the fields and controls later on this page.

Citizen/Resident Mapping

Effective Date: 02/10/2004

Citizenship Status	Citizen/Resident Code		+	-
Native	2	NZ Citizen	+	-
Alien Permanent	8	Permanent Humanitarian Visa	+	-
Alien Temporary	4	Temporary Resident	+	-
Citizen	1		+	-
Permanent Resident	3	Permanent Resident	+	-
Foreign ID Card Holder	5	Resident Outside Aus	+	-

Note: Set up TCSI citizenship and resident code values on the Citizen/Res Indicator page.

<i>Field or Control</i>	<i>Description</i>
Citizenship Status	Select a PeopleSoft defined citizenship status code.
Citizen/Resident Code	Enter the equivalent TCSI citizen/resident code.

Setting Up TCSI Processing

Access the Reporting Setup page (**Set Up SACR > Product Related > Student Records > Enrollment Reporting Codes > AUS Regulatory Report Setup > Reporting Setup > Reporting Setup**).

Note: For each new collection year, you must access this page and enter a new reference year row.

This example illustrates the fields and controls on the Reporting Setup page. You can find definitions for the fields and controls later on this page.

Reporting Setup

Academic Institution: PSAUS PeopleSoft Australia Uni

University Code:

*ID: Brown, Tamara T

Revisions File Reference: 2000004

Revisions Submission Number: 4

Address Usages

Postal Address: DEEWR Postal Location

Permanent Address: DEEWR Permanent Location

Term Address: DEEWR Postal Location

DEEWR Reference Year

[Find](#) | [View All](#) First 1 of 8 Last

*Reference year:

DEEWR Submission Counter

[Find](#) | [View All](#) First 1-2 of 2 Last

First Half Year	
Enrollment Submission Nbr:	2
Scholarship Submission Nbr:	2
OS - Help Submission Nbr:	2
Past Course Completion Nbr:	2
SA - HELP Submission Nbr:	6
Second Half Year	
Enrollment Submission Nbr:	1
Scholarship Submission Nbr:	1
OS - Help Submission Nbr:	1
SA - HELP Submission Nbr:	1

<i>Field or Control</i>	<i>Description</i>
University Code	Enter your institution's TCSI university code. This code is used in the file name for your submissions.
ID	Enter the ID for your institution's TCSI contact.

Address Usages

<i>Field or Control</i>	<i>Description</i>
Postal Address	Select a value to determine the data for address elements 406, 407, 409, 466, 467, 468, 728.
Permanent Address	Select a value to determine the data for address elements 320, 410, 411, 413, 469, 470 and 471.
Term Address	Select a value to determine the data for address element 319.

Setting Up Level of Education Codes

Access the Level of Education VET page (**Set Up SACR > Product Related > Student Records > Enrollment Reporting Codes > AUS Regulatory Report Setup > Level of Education VET > Level of Education VET**).

This example illustrates the fields and controls on the Level of Education VET page. You can find definitions for the fields and controls later on this page.

The screenshot shows the 'Level of Education VET' page with the following details:

- Level of Education Code:** 411
- Level of Education Code** header with navigation: Find | View All | First 1 of 1 Last
- Effective Date:** 07/01/2007 (with a calendar icon)
- Status:** Active (with a dropdown arrow and +/- buttons)
- *Description:** Advanced Diploma
- Short Description:** AdvDiploma

Use this page to enter values for TCSI Element 563 – Level of Education for Prior VET Study.

These values are then available in the **Level of Education** field on the Transfer Course Entry page, if the school type assigned to the credit has a TCSI Credit Basis of 0200 Credit Offered for Prior VET Study.

Setting Up Program on Campus

Access the Program on Campus page (**Set Up SACR > Product Related > Student Records > Enrollment Reporting Codes > AUS Regulatory Report Setup > Program on Campus**).

This example illustrates the fields and controls on the Program on Campus page. You can find definitions for the fields and controls later on this page.

Program on Campus

Academic Institution PSAUS	PeopleSoft Australia Uni	
Academic Program BECON	Bachelor of Economics	<input type="button" value="Copy"/>
Academic Plan BUSSTATS	Business Statistics	<input type="button" value="Import"/>
Location MELB	Melbourne	<input type="button" value="Import Course Fee"/>

Details Find | View All First 1 of 1 Last

*Effective Date

*Status

CRICOS Code E597

Type of Campus E569

Offshore Course Mode E570

Offshore Delivery Code E571

TAC Offers Find | 1-2 of 2

TAC Offer E557

<input type="text" value="QTAC"/> <input type="button" value="v"/>	<input type="button" value="+"/>	<input type="button" value="-"/>	
<input type="text" value="VTAC"/> <input type="button" value="v"/>	<input type="button" value="+"/>	<input type="button" value="-"/>	

Course Fees Find | View All First 1 of 1 Last

Course Fee Effective Date 01/01/2020

Course Fee Type E536 CSP and Domestic Fee-paying

Indicative CSP Amount E495

Indicative Tuition Fee E496

International Indicative Tuition Fee Last Admit Term

Course fees can change over time. Use this page to make sure new course fees take effect based on a predetermined date. The first Course Fee record should have a Course Fee Effective From Date that matches the Effective Date of the parent Course on Campus record.

The main Program on Campus record is effective-dated in CS, but only a single "effective from date" record is reported as a TCSI Course on Campus, so you won't be able to add new effective-dated rows here.

Field or Control	Description
Copy	<p>Click to add a new Program on Campus record. This allows you to select an existing record of a similar program and copy its details. After copying, you can edit the data before saving.</p> <p>You may need to correct the effective dates and ensure that the first Course Fee record has a Course Fee Effective Date that matches the Effective Date of the Course on Campus record.</p>

Field or Control	Description
Import	Click to import a complete Program on Campus record from a comma-separated file (CSV). The CSV file contains a header row and any number of comma-separated data rows. It should also include the first Course Fee record which is given the same effective date as the parent record. Import is enabled when viewing an existing record.
Import Course Fee	Click to import new course fees for existing Program on Campus records (as they change over time). Import Course Fee is enabled when viewing an existing record.

Course Fees

To change course fees over time, add a new row and specify a later date in **Course Fee Effective From Date**.

Identifying CS Locations for TCSI

Access the Campus Location page (**Set Up SACR > Product Related > Student Records > Enrollment Reporting Codes > AUS Regulatory Report Setup > Campus Location**).

This example illustrates the fields and controls on the Campus Location page.

Campus Location				
Academic Institution PSAUS PeopleSoft Australia University				
Locations		Personalize Find View All	First 1-5 of 15 Last	
	Location	Description	*Provider Type	Status
1	BALLARAT	Ballarat Campus	Higher Education Provider	Active
2	BALLARAT	Ballarat Campus	Vocational Education&Training	Active
3	BENDIGO	BENDIGO	Higher Education Provider	Active
4	CARLTON	CARLTON	Higher Education Provider	Inactive
5	GABALONG	GABALONG CAMPUS	Vocational Education&Training	Active

Use this page to identify which locations should be considered a campus for TCSI, and associate a provider type. If a location is both a HEP and VET campus, you should have two entries.

Map Types of Impairment With Disability Codes

Access the Disability Mapping page (**Set Up SACR > Product Related > Student Records > Enrollment Reporting Codes > AUS Regulatory Report Setup > Disability Mapping**).

This example illustrates the fields and controls on the Disability Mapping page.

Disability Mapping					
Effective Date 01/01/2010					
Mapping		Personalize Find		First 1-6 of 6 Last	
Type of Impairment		Disability Code E615			
20	Hearing Disability	11	Hard of hearing/Deaf	+	-
30	Learning Disability	14	Specific learning disability	+	-
40	Mobility Disability	12	Physical disability	+	-
50	Vision Disability	17	Low vision/blindness	+	-
60	Medical Disability	18	Medical condition	+	-
70	Other Disability	19	Other	+	-

Use this page to map the types of impairment with E615 disability codes.

The type of impairment should be unique for an effective date. You can map multiple types of impairment to a disability code.

Map Program Actions and Reasons to Program Completion Codes

Access the E599 Completion Code Mapping page (Set Up SACR > Product Related > Student Records > Enrollment Reporting Codes > AUS Regulatory Report Setup > E599 Completion Code Mapping).

This example illustrates the fields and controls on the E599 Completion Code Mapping page.

E599 Completion Code Mapping					
Academic Institution PSAUS PeopleSoft Australia Uni					
Mapping		Personalize Find		First 1-2 of 2 Last	
*Program Action	Description	Action Reason	Description	*Program Completion Code E599	Description
1 COMP	Completion of Program			1	Completed
2 WADM	Administrative Withdrawal			2	Withdrawn

Use this page to map program actions and action reasons to a program completion code. You can map multiple program action and action reason to the same completion code.

Setting Up for Collecting Applications and Offers Data

This section provides an overview of Applications and Offers Data Collection and discusses how to:

- Set up an Applications and Offers profile.
- Set up Applications and Offers element mapping.

- Set up Applications and Offers element defaults.
- Set up funding source codes.
- Set up Element 702 mapping.

Understanding Applications and Offers Data Collection

To meet the TCSI Applications and Offers Data Collection requirements, you use the Applications and Offers (SSR_DEEWR_AO) process.

The process generates three files— Applications Details, Preference Details, and Offer Details.

An applicant is included in the data collection only if an admissions application exists for the applicant. The Preference Details file includes a record for each program within collection scope for which an applicant has applied. The Offer Details file includes only those programs for which an applicant has been made an offer—it can therefore contain zero records.

The scope of Applications and Offers Collection Data requirements excludes certain categories of application, for example:

- Cancelled by an institution as duplicates, or because the applicant is known to be deceased or has falsified documentation, or for other administrative reasons.
- Registrations for non-commencing students following periods of lapsed enrollment, leave of absence, or deferment.

Pages Used to Set Up Applications and Offers Profile Parameters

<i>Page Name</i>	<i>Definition Name</i>	<i>Navigation</i>	<i>Usage</i>
Profile	SSR_DEEWR_AO_PRFL	Set Up SACR > Product Related > Student Records > Enrollment Reporting Codes > AUS Regulatory Report Setup > Applications & Offers Profile > Profile	Define key parameters to determine the selection of applicants to be included in the Applications & Offers data collection.

Page Name	Definition Name	Navigation	Usage
Applications and Offer Year	SSR_DEEWR_AOYR	Set Up SACR > Product Related > Student Records > Enrollment Reporting Codes > AUS Regulatory Report Setup > Applications and Offer Year	<p>Define TCSI reporting reference years with their associated reference date, current year 12 year, and a list of admit terms that belong to the reference year. This information was provided as parameters in the previous HEIMS process and early versions of the TCSI solution.</p> <p>This setup data is used by both the TCSI Applications, Offers, and Preferences process and the transaction page to ensure consistent results.</p>
Element Mapping	SSR_DEEWR_AO_ELEMP	Set Up SACR > Product Related > Student Records > Enrollment Reporting Codes > AUS Regulatory Report Setup > Applications & Offers Profile > Element Mapping	<p>Define program action and reason combinations to define the scope of each of the files in the Applications & Offers data collection and assist in determining the value to report for elements 723 and 701.</p> <p>Element 710 is reported by identifying the test ID and component that captures an International Baccalaureate score.</p>
Element Defaults	SSR_DEEWR_AO_ELEDF	Set Up SACR > Product Related > Student Records > Enrollment Reporting Codes > AUS Regulatory Report Setup > Applications & Offers Profile > Element Defaults	<p>Specify either a constant or default value for a subset of elements in the Applications and Offers data collection.</p> <p>Where applicable, a constant value is reported for all records in the file. A default value is reported if there is no data found.</p>
Funding Source	SSR_DEEWR_FUND_SRC	Set Up SACR > Product Related > Student Records > Enrollment Reporting Codes > AUS Regulatory Report Setup > Funding Source > Funding Source	<p>Define funding source codes that can be assigned to the applicant or student to record the type of place that the applicant is offered or for which the student is currently enrolled.</p>

Page Name	Definition Name	Navigation	Usage
Element 702 Mapping	SSR_DEEWR_E702_MAP	Set Up SACR > Product Related > Student Records > Enrollment Reporting Codes > AUS Regulatory Report Setup > Element 702 Map > Element 702 Mapping	Map the year 12 result type codes for Element 702 to the applicable state code.

Setting Up an Applications and Offers Profile

Access the Profile page (Set Up SACR > Product Related > Student Records > Enrollment Reporting Codes > AUS Regulatory Report Setup > Applications & Offers Profile > Profile).

This example illustrates the fields and controls on the Profile page. You can find definitions for the fields and controls later on this page.

Profile
Element Mapping
Element Defaults

Academic Institution: PSAUS PeopleSoft Australia Uni

Profile: AO_CD1

AO Profile

Find | View All
First 1 of 1 Last

Effective Date: 07/01/2009 B1 **Status:** Active + -

Description:

Description:

Application Center

Find | View All
First 1 of 1 Last

+ - Central Student Admissions

Admit Type

Find | View All
First 1 of 1 Last

+ -

Application Method

Find | View All
First 1 of 2 Last

+ - Web Application

Citizenship

Find | View All
First 1 of 4 Last

+ - Australian Citizen

Course Of Study Type Code

Find | View All
First 1 of 3 Last

+ - Bachelor's Graduate Entry

Use this page to define key selection parameters relevant to the data collection.

<i>Field or Control</i>	<i>Description</i>
Application Center, Admit Type, and Application Method	Select a value in these fields if applicants included within the scope of the data collection are identifiable by an application centre, admit type, or application method on the admissions application.
Citizenship and Course of Study Type Code	The Applications and Offers Data Collection requirements include specific citizenship and course of study type values within scope. You must select all the required values for TCSI Citizenship Element 358 and TCSI Course of Study Type Element 310 that are applicable to the scope of the collection.

Setting Up Applications and Offers Element Mapping

Access the Element Mapping page (**Set Up SACR > Product Related > Student Records > Enrollment Reporting Codes > AUS Regulatory Report Setup > Applications & Offers Profile > Element Mapping**).

This example illustrates the fields and controls on the Element Mapping page. You can find definitions for the fields and controls later on this page.

Profile
Element Mapping
Element Defaults

Academic Institution: PSAUS PeopleSoft Australia Uni

Profile: AO_CD1

Element Mapping
Find | View All First ◀ 1 of 1 ▶ Last

Effective Date: 07/01/2009

File Scope Mapping
Customize | Find | View 3 | First ◀ 1-4 of 4 ▶ Last

Program Action
Application Status
[...]

	*Program Action	Description	Action Reason	Description		
1	ADMT	Admit				
2	DISC	Discontinuation	DEAT	Deceased		
3	RECN	Reconsideration				
4	WADM	Administrative Withdrawal				

Element 723 Mapping
Customize | Find | View All | First ◀ 1-3 of 3 ▶ Last

Program Action
E723 Response Code
[...]

	*Program Action	Description	Action Reason	Description		
1	DEFR	Defer Enrollment				
2	DEIN	Intention to Matriculate				
3	WAPP	Applicant Withdrawal				

Element 701 Mapping
Customize | Find | View All | First ◀ 1 of 1 ▶ Last

Program Action
E701 Application Status
[...]

	*Program Action	Description	Action Reason	Description		
1	WAPP	Applicant Withdrawal				

International Baccalaureate Score
Customize | Find | View All | First ◀ 1 of 1 ▶ Last

	*Test ID	Description	*Test Component	Description		
1	IB	International Baccalaureate	COMP	Composite		

Use this page to determine the value of a number of elements that must be reported and to further refine the scope of the collection by excluding a subset of applicants and distinguishing between preferences and offers.

File Scope Mapping

Here are examples of the Program Action and Application Status tabs:

This example illustrates the fields and controls on the Element Mapping page: File Scope Mapping, Program Action tab. You can find definitions for the fields and controls later on this page.

File Scope Mapping					
Program Action		Application Status			
	*Program Action	Description	Action Reason	Description	
1	ADMT	Admit			+ -
2	DISC	Discontinuation	DEAT	Deceased	+ -
3	RECN	Reconsideration			+ -
4	WADM	Administrative Withdrawal			+ -

This example illustrates the fields and controls on the Element Mapping page: File Scope Mapping, Application Status tab. You can find definitions for the fields and controls later on this page.

File Scope Mapping					
Program Action		Application Status			
	*Application Status	Description			
1	OF	Offered			+ -
2	EX	Excluded			+ -
3	NO	Not Offered			+ -
4	EX	Excluded			+ -

Use these tabs to set up combinations of program action and reason(s) that affect:

- Whether the applicant is included in or excluded from the data collection.
- If included, whether the applicant is reported in Application Details and Preference Details file but not in the Offer Details file.

Enter an **Application Status** value only for program actions and (optional) reasons that are relevant to the collection scope.

An example of a program action that doesn't require a mapping is DATA (Data Change). A program action of DATA is typically used to change an attribute on the application or program that isn't relevant to the scope of the collection.

Element 723 Mapping

Here are examples of the Program Action and E723 Response Code tabs:

This example illustrates the fields and controls on the Element Mapping page: Element 723 Mapping, Program Action tab. You can find definitions for the fields and controls later on this page.

Element 723 Mapping					
Program Action		E723 Response Code			
	*Program Action	Description	Action Reason	Description	
1	DEFR	Defer Enrollment			+ -
2	DEIN	Intention to Matriculate			+ -
3	WAPP	Applicant Withdrawal			+ -

This example illustrates the fields and controls on the Element Mapping page: Element 723 Mapping, E723 Response Code tab. You can find definitions for the fields and controls later on this page.

Element 723 Mapping				Customize	Find	View All	First	1-3 of 3	Last
Program Action		E723 Response Code							
	*E723 Response Code	Description							
1	3	Deferred the offer		+	-				
2	1	Accepted the offer		+	-				
3	2	Rejected the offer		+	-				

That data that you set up here determines the value that is reported for Element 723 if the applicant is not enrolled in the reported program.

If the applicant is enrolled, a value of 1 (Accepted the offer) is reported regardless of the setup.

If no mapping is found, a value of 6 (Response unknown/not recorded) is reported.

If you do not enter an action reason for a program action, the process assumes all reasons for the program action.

Element 701 Mapping

Here are examples of the Program Action and the E701 Application Status tabs:

This example illustrates the fields and controls on the Element Mapping page: Element 701 Mapping, Program Action tab. You can find definitions for the fields and controls later on this page.

Element 701 Mapping						Customize	Find	View All	First	1 of 1	Last
Program Action		E701 Application Status									
	*Program Action	Description	Action Reason	Description							
1	WAPP	Applicant Withdrawal									

This example illustrates the fields and controls on the Element Mapping page: Element 701 Mapping, E701 Application Status tab. You can find definitions for the fields and controls later on this page.

Element 701 Mapping						Customize	Find	View All	First	1 of 1	Last
Program Action		E701 Application Status									
	*E701 Application Status	Description									
1	2	Application Withdrawn									

The data that you set up here determines the value that is reported for Element 701.

The minimum recommended setup is for 2 (Applicant Withdrawn), but you can identify values for every program action. If set up a status of 2 only, all other program actions assume the reporting value of 1 (Current Application).

Note: A distinction exists between an applicant withdrawn for the purpose of element 701 and applications that are excluded from data collection. Programs with an E701 status of application withdrawn must be reported. To exclude applicants from all 3 files, assign the relevant program action/reason combinations in the **File Scope Mapping** group box not in the **Element 701** group box.

International Baccalaureate Score

This mapping determines the test score and component relevant to the IB Aggregate score reported at Element 710.

Setting Up Applications and Offers Element Defaults

Access the Element Defaults page (**Set Up SACR > Product Related > Student Records > Enrollment Reporting Codes > AUS Regulatory Report Setup > Applications & Offers Profile > Element Defaults**).

This example illustrates the fields and controls on the Element Defaults page. You can find definitions for the fields and controls later on this page.

The screenshot shows the 'Element Defaults' page with the following details:

- Academic Institution:** PSAUS PeopleSoft Australia Uni
- Profile:** AO_CD1
- Effective Date:** 07/01/2009

*Element	Description	Constant Value	Default Value
1 314	Date Of Birth		19010101
2 316	ATSI Code		9
3 327	Basis Of Admission		
4 348	Language Spoken at Home		9999
5 493	Highest Educational Partic.		090000
6 702	Year 12 Result Type Code		10
7 724	Sector Code	1	

Defaults are used to assist in the value of some elements that are reported in the Applications and Offers Data Collection. Only a subset of elements can be assigned either a default or constant value, because the concept is not applicable to all elements in the collection.

If you assign a constant value, all records in the data extracts are reported with the same value. If you assign a default value, the value is reported only if no data is found for the student for that particular element. You can assign a default value of blank—a blank value is output to file, highlighting the missing data.

Note: The only element that acknowledges a constant value is E724 Sector Code. For all elements except Element 724, use the **Default Value** field to assign a default value to be reported if no data is sourced for the applicant.

This table lists the TCSI Equivalent values where relevant:

Element	TCSI Equivalent
314: Date of Birth	19010101
316: Aboriginal & Torres Strait Islander Code	9
348: Language Spoken at Home	9999
493: Highest Educational Participation Prior to Commencement	090000
702: Year 12 Result Type Code	10

Element 724

Customers can assign either a constant value or a default value if no funding source is assigned to the applicant with a mapping to Sector Code.

Setting Up Funding Source Codes

Access the Funding Source page (**Set Up SACR > Product Related > Student Records > Enrollment Reporting Codes > AUS Regulatory Report Setup > Funding Source > Funding Source**).

This example illustrates the fields and controls on the Funding Source page. You can find definitions for the fields and controls later on this page.

Funding Source

Funding Source: CSP

Funding Source Find | View All First 1 of 1 Last

Effective Date: 01/01/2009 **Effective Status:** Active + -

Description: Commonwealth Supported Place

Formal Description: Commonwealth Supported Place

Sector Code: 1 Commonwealth Supported

Use this page to define funding source codes that can be assigned to the applicant or student to record the type of place that the applicant is offered or for which the student is currently enrolled.

Field or Control	Description
Funding Source	<p>This user-defined code indicates the category of the place that the student is offered.</p> <p>The Funding Source field appears on the AUS Student Program, Application Regional, Program Addition, and Quick Admit-Program/Plan pages.</p>
Sector Code	<p>The sector code represents TCSI Element 724. If the funding source is relevant to the Applications and Offers data collection, enter a value in this field. If not, the field can be blank. You can map multiple funding source values to a single sector code for reporting purposes.</p>

Setting up Element 702 Mapping

Access the Element 702 page (**Set Up SACR > Product Related > Student Records > Enrollment Reporting Codes > AUS Regulatory Report Setup > Element 702 Map > Element 702 Mapping**).

This example illustrates the fields and controls on the Element 702 Mapping page. You can find definitions for the fields and controls later on this page.

Element 702 Mapping

Element 702 Mapping								Customize	Find	View All	First	1-8 of 8	Last
*Element 702 Code	Description	*Country	Description	*State	Description								
01	ACT Year 12 Certificate	AUS	Australia	ACT	Austl. Cap. Terr.								
02	New South Wales HSC	AUS	Australia	NSW	New South Wales								
03	QLD Certificate of Education	AUS	Australia	QLD	Queensland								
04	SA/NT Certificate of Education	AUS	Australia	SA	South Australia								
04	SA/NT Certificate of Education	AUS	Australia	NT	Northern Territory								
05	TAS Certificate of Education	AUS	Australia	TAS	Tasmania								
06	VIC Certificate of Education	AUS	Australia	VIC	Victoria								
07	WA Certificate of Education	AUS	Australia	WA	Western Australia								

Use this page to map the year 12 result type codes for Element 702 to the applicable state codes.

The Applications and Offers process uses this mapping to report the state in which a student completed or is completing year 12.

Field or Control	Description
Element 702 Code	<p>Enter the Australian Year 12 result type code values for TCSI Element 702 and map each value to the relevant state.</p> <p>You do not have to enter codes for values that are not directly attributable to a State, for example, International Baccalaureate.</p> <p>The Element 702 code that is reported to TCSI is based on the value in the State field on the CHESSN Year 12 page, if the student attended year 12 in the year that is designated as <i>current</i> for the TCSI Applications and Offers Data collection—the year immediately prior to the reference year for which you run the Applications and Offers process.</p>

Setting Up HECS Liability in Student Records

This section provides an overview of HECS liability in Student Records and discusses how to:

- Define cohort year.
- Set up HECS band IDs.
- Map liability status codes.
- Map work experience to HECS liability codes.
- Set up aggregated EFTSL values.

Understanding HECS Liability in Student Records

The HECS is an equitable way of ensuring that students contribute to the cost of their higher education. HECS provides a loan to students that is interest free, with deferred income contingent repayment. The purpose of HECS in the system is to determine how much of the tuition a student should pay, and then to collect the payments. To do this, HECS Band IDs must be associated with courses so that when students enroll, the system can calculate their contributions based on the HECS Band and their level/load (EFTSL). HECS Band IDs are associated with academic subjects, but you can override them at the course catalog level. All of the HECS processing (tuition calculation) occurs in the Student Financials application.

Pages Used to Set Up HECS Liability

<i>Page Name</i>	<i>Definition Name</i>	<i>Navigation</i>	<i>Usage</i>
Cohort Year	SSR_COHORT_YR_AUS	Set Up SACR > Product Related > Student Records > Enrollment Reporting Codes > AUS Regulatory Report Setup > Cohort Year > Cohort Year	Define the cohort years that your institution uses to create cohorts of students commencing a program in a specific year.
HECS Band ID Setup	SSR_HECS_BAND_AUS	Set Up SACR > Product Related > Student Records > Enrollment Reporting Codes > AUS Regulatory Report Setup > HECS Band ID Setup > HECS Band ID Setup	Set up the HECS Band IDs.
Map Liability Status	SSR_HECS_MAP_TO	Set Up SACR > Product Related > Student Records > Enrollment Reporting Codes > AUS Regulatory Report Setup > Map Liability Status > Map Liability Status	Map pre-2005 liability status codes to post -2005 student status codes. The system uses this mapping when you term-activate a student who was active before 2005.
Map Work Exp to Liability (map work experience to liability)	SSR_WORK_EXP_MAP	Set Up SACR > Product Related > Student Records > Enrollment Reporting Codes > AUS Regulatory Report Setup > Map Work Exp to Liability > Map Work Exp to Liability	Define liability status mappings for work experience in industry class enrollments.
Aggregated EFTSL AUS	SSR_EFTSU_AGG	Set Up SACR > Foundation Tables > Reporting Codes > Aggregated EFTSL AUS > Aggregated EFTSL AUS > Aggregated EFTSL AUS	Define the aggregated EFSTL values that are available on the Academic Program Australia page.

Defining Cohort Years

Access the Cohort Year page (**Set Up SACR > Product Related > Student Records > Enrollment Reporting Codes > AUS Regulatory Report Setup > Cohort Year > Cohort Year**).

This example illustrates the fields and controls on the Cohort Year page. You can find definitions for the fields and controls later on this page.

Cohort Year				
Customize Find View All First 1-3 of 3 Last				
*Cohort Year	*Description	Short Description		
2004	Cohort 2004	2004	+	-
2005	Cohort 2005	2005	+	-
2006	Cohort 2006	2006	+	-

A cohort year designates a group of students that all begin a particular course of study the same year.

Setting up cohort years enables your institution to specify the student contribution amounts and tuition fees for the student cohorts according to the guidelines in the Higher Education Support Act of 2003.

<i>Field or Control</i>	<i>Description</i>
Cohort Year	Enter the years in which your institution wants to group students.

Related Links

[\(AUS\) Entering Australia-Specific Student Program Information](#)

[\(AUS\) Entering HECS Data](#)

[Adding or Updating Quick Enrollment Requests](#)

Setting Up HECS Band IDs

Access the HECS Band ID Setup page (**Set Up SACR > Product Related > Student Records > Enrollment Reporting Codes > AUS Regulatory Report Setup > HECS Band ID Setup > HECS Band ID Setup**).

Note: Fixed HECS is used for students who enrolled before January 1, 1997, and are charged a single rate for all their subject areas.

The HECS Band ID determines the amount of tuition that an institution can charge per course.

The Department of Education sets up guidelines as to which band a subject should be placed. You associate HECS Band IDs with academic subjects. Courses that fall under that academic subject are automatically assigned the HECS Band ID of the academic subject; however, you can override the HECS Band ID for individual courses if required.

Related Links

[Defining Course Offerings](#)

[\(AUS\) Entering HECS Data](#)

Mapping Liability Status Codes

Access the Map Liability Status page (**Set Up SACR > Product Related > Student Records > Enrollment Reporting Codes > AUS Regulatory Report Setup > Map Liability Status > Map Liability Status**).

This example illustrates the fields and controls on the Map Liability Status page. You can find definitions for the fields and controls later on this page.

Map Liability Status					
Customize Find View All First 1-4 of 4 Last					
*Liability Status	Description	*Map to New Liability Status	Description		
10	Deferred all/part of liability	110	HECS-HELP Deferred pre2005	+	-
11	Paid full liability w discount	111	HECS-HELP Paid w/disc. pre2005	+	-
12	Paid full liability w/o discount	112	Paid full w/o discount pre2005	+	-
22	Fee-paying overseas student	311	Fee-paying overseas Sponsored	+	-

A liability status defines a student's payment options (for example, deferred or pay up front) and is assigned to each student in the term activation component.

The liability status codes are defined by the Department of Education. In 2005, the codes were changed from two-digit to three-digit codes. For historical purposes, your system must maintain the two-digit codes.

Field or Control	Description
Liability Status	Select the two-digit liability status code.
Map to New Liability Status	Select the equivalent three-digit liability status code.

Related Links

[\(AUS\) Setting Student Term Default Values](#)

[\(AUS\) Entering HECS Data](#)

[Adding or Updating Quick Enrollment Requests](#)

Mapping Work Experience to HECS Liability Codes

Access the Map Work Exp to Liability page (**Set Up SACR > Product Related > Student Records > Enrollment Reporting Codes > AUS Regulatory Report Setup > Map Work Exp to Liability > Map Work Exp to Liability**).

This example illustrates the fields and controls on the Map Work Exp to Liability page. You can find definitions for the fields and controls later on this page.

Map Work Exp to Liability					
Work Experience Indicator:		Wholly Work Exp - Exempt			
Customize Find View All First 1-3 of 3 Last					
*Liability Status	Description	*Map to New Liability Status	Description		
201	HECS-HELP Deferred.	262	Work Experience in Industry	+	-
202	Paid full liability w/discount	262	Work Experience in Industry	+	-
230	FEE-HELP Def Award/Enabling	271	WEI -- No charge for fees.	+	-

WEI is work that is done as a part of, or in connection with, a course of study undertaken with a higher education provider (HEP) and the purpose of which is to obtain work experience relevant to the course of study.

The work experience can be a unit of study that is directed or supported by your institution for which the student pays a contribution amount or tuition fees, or it can be work experience not directed or supported by an institution for which the student pays no contribution or fees.

Field or Control	Description
Work Experience Indicator	When setting up a new indicator, select the appropriate value. The work experience indicators are: <ul style="list-style-type: none"> <i>Not Wholly Work Experience:</i> The HEP directs the learning and performance of the student. The work experience is treated as a normal unit, and the student is charged appropriately. <i>Wholly Work Exp - Exempt:</i> The HEP does not provide direction or support for the work experience, and the unit of study is exempt from student contributions and tuition fees. <i>Wholly Work Exp with Charge:</i> The HEP supports the learning and performance of the student and may charge the student contribution amounts and tuition fees.
Liability Status	Select a liability status that your institution has entered as a default status for a course.
Map to New Liability Status	Select the equivalent liability status for students who have enrolled in the course for WEI.

Setting Up Aggregated EFTSL Values

This section provides an overview of EFTSL Calculation and discusses how to set up Aggregated EFTSL values.

Understanding EFTSL Calculation

EFTSL is a measure of the study load, for one year, of a student undertaking a course of study on a full time basis.

To enable TCSI to make accurate comparisons between institutions, student loads must be universally expressed in EFTSL values. One EFTSL is the amount of study that a full time student is expected to take in one year.

TCSI requires that institutions report EFTSL values for each student, each year. A student's total EFTSL for a year is equal to the sum of EFTSL values for each term for which the student is enrolled in that year. The student's total EFTSL value for each term is the sum of the EFTSL for each class in which the student is enrolled in that term. The EFTSL value for each class is determined by dividing the number of units for each class in which the student is enrolled that term by the total annual units for that program of study.

This example illustrates the calculation of EFTSL values for a student for two terms:

Example Class	Term	Units
Accounting 101	1	15
Economics 101	1	15
English 201	1	15
Music 105	1	15
		Total term units: 60
Engineering 201	2	30
Economics 102	2	15
Laws 201	2	15
		Total term units: 60
		Total annual units for program of study: 120

To calculate the EFTSL for each class, the number of units for each class is divided by the annual units for the program of study:

Accounting 101 EFTSL = [15 units for the class] / [120 units for the annual program of study] = 0.125

Engineering 501 EFTSL = [30 units for the class] / [120 units for the annual program of study] = 0.25

This table lists the EFTSL for each class in the example:

Class	EFTSL
Accounting 101	0.125
Economics 101	0.125
English 201	0.125
Music 105	0.125
Engineering 201	0.25
Economics 102	0.125
Laws 201	0.125
<i>Total Annual EFTSL</i>	<i>1.00</i>

Note: For classes that are offered on an annual basis, the EFTSL value must be split so that it represents the load attributed to the class in each term. For example, an annual class that is assigned 30 units might have an EFTSL of 0.25. The term EFTSL for the class would be 0.125 for a two-term year.

The term total units do not need to be equal for each term. For example, if the annual load is 120, you could have 75 units from the first term and 45 units for the second term.

Setting Up Aggregated EFTSL Values

Access the Aggregated EFTSL AUS page (**Set Up SACR > Foundation Tables > Reporting Codes > Aggregated EFTSL AUS > Aggregated EFTSL AUS > Aggregated EFTSL AUS**).

This example illustrates the fields and controls on the Aggregated EFTSL AUS page. You can find definitions for the fields and controls later on this page.

The screenshot shows a web interface titled "Aggregated EFTSL AUS". At the top left, it displays "Aggregated EFTSL: 30". Below this is a table with a dark blue header bar containing navigation options: "Find | View All | First 1 of 1 Last". The table has the following fields:

Effective Date:	<input type="text" value="01/01/1900"/>	Status:	<input type="text" value="Active"/>	
*Description:	<input type="text" value="3 Years"/>			
Short Description:	<input type="text" value="3 Years"/>			

TCSI requires that institutions report EFTSL values for each student, each year. A student's total EFTSL for a year is equal to the sum of EFTSL values for each term for which he or she is enrolled in that year. The student's total EFTSL value for each term is the sum of the EFTSL for each class in which the student is enrolled in that term. The EFTSL value for each class is determined by dividing the number of units for each class in which the student is enrolled that term by the total annual units for that program of study.

Aggregated EFTSL values are the total number of EFTSL values that a student accumulates while completing a program of study. This value is used to derive the element 350 Course of Study Load on the Course of Study file.

TCSI provides the codes for aggregated EFTSL. You must enter the codes (in tenths) into the system so that you can show the equivalent course of study load (program load). For example, the program value of 30 is equal to 3 years EFTSL.

You assign an aggregated EFTSL to each of your programs on the Academic Program AUS page.

Related Links

“(AUS) Setting Up Australian Academic Programs” (Campus Solutions Application Fundamentals)

(CAN) Setting Up Government Reporting

Understanding the Canadian Government Reporting Process

All postsecondary schools in Canada are required to report specific information to the federal and provincial governments. The Campus Solutions Canadian Government Reporting feature enables users to generate files in formats specified by the government. Using the Campus Solutions Canadian Government Reporting feature, you can extract reports in the following file formats:

- PSIS - Postsecondary Student Information System.
- USISE - University Student Information System Enrollment Reporting.
- CIS - Common Information System.
- MET - Ministry of Education and Training Financial Reporting.
- OUAC - Ontario Universities' Application Center Reporting.

You must complete a series of setup steps for each of the reports. Some of the steps include setting up very basic data (for example, country codes), and the system provides the data for you. Other steps are user defined, and you must closely follow the setup steps to ensure that your system is ready for reporting.

After you complete the setup steps, you can populate a table with students who are eligible for reporting.

The flat file generation process is a separate step that you can initiate after you run the extract program. You are then responsible for running the flat file through the government edits. If you find any errors and would like to make edits, you can do so without overwriting source data.

In addition, you can freeze a reporting period so that the system does not add students or modify them as of a specified date. The reporting extract process can be rerun as often as you require. When the data in the flat file is correct, you can archive the report extract tables.

Finally, all government elements are defined by element class and mapping classes. The element class determines what type of calculation or conversion needs to take place in order for the system to report the information in a code the government specifies. The five element classifications are listed in the following table:

<i>Element Classification Type</i>	<i>Description</i>
Classification Mapping (CM)	Use when there is a direct mapping of the data, but you would only report this element in certain circumstances. For example, you may have to report the student's maiden name. You would specify the mapping field of Maiden_Name on the Names table where the Name_type is equal to a particular value (in this case it would be 'MDN' for maiden). Note that the selection criteria field must be on the same record as the mapped field.
Direct Mapping (DM)	Use when there is a direct mapping of the data. Conversion from application values to government code is not required. The application record and field names are entered in the Direct Mapping table for these elements.
Master Mapping (MM)	Use when there is a direct mapping of the data, but you must convert the application value to the Government Reporting Value. You must enter conversion codes in the Master Mapping Table in order for the system to report the government values.
Separate Mapping (SM)	Similar to Master Mapping, except the number of values to be mapped is greater than 15. The application provides a separate conversion table that holds the converted values.
Rules Based Mapping (RB)	<p>This classification applies to elements that:</p> <ul style="list-style-type: none"> • Cannot be derived directly from the database. • Require a separate mapping for each government code value. • Require complex institution-specific calculations. <p>All rules based elements are identified by report type with a unique procedure number. The reports extract program uses this number to execute the associated logic. Each report type procedure number starts at 1, except MET reporting, which starts at 201. You cannot duplicate procedure numbers within a report type. Any changes to the rule based mapping procedure values require a modification of the reports.</p>

Note: If you decide that a mapping change is required, you must ensure that the key structure of the new table allows the retrieval of a unique record. If a key field is required, then you must provide the field name and value for every student on the Student List page.

Related Links

[Loading the Student ID Table](#)

Defining Canadian Reporting Business Units

To set up Canadian reporting business units, use the Business Unit Table component (BUS_UNIT_TBL_RP).

This section discusses how to:

- Define Canadian reporting business unit descriptions.
- Define Canadian reporting business unit defaults.
- Define Canadian reporting business unit career usage values.

Pages Used to Define Canadian Business Units

<i>Page Name</i>	<i>Definition Name</i>	<i>Navigation</i>	<i>Usage</i>
General	BUS_UNIT_TBL_RP	Records and Enrollment > Government Reporting Canada > Definitions > Business Unit Table > General	PSIS: Define business unit descriptions.
Unit Defaults	BUS_UNIT_TBL_RP2	Records and Enrollment > Government Reporting Canada > Definitions > Business Unit Table > Unit Defaults	PSIS: Define business unit defaults.
Career Usage	CAREER_USAGE_TBL	Records and Enrollment > Government Reporting Canada > Definitions > Business Unit Table > Career Usage	PSIS: Define career usage values.

Defining Canadian Reporting Business Unit Descriptions

Access the General page (**Records and Enrollment > Government Reporting Canada > Definitions > Business Unit Table > General**).

<i>Field or Control</i>	<i>Description</i>
Institution	Enter the institution for which you want to define the reporting business unit.
Institution Cd (institution code)	Enter the institution's reporting code.

Field or Control	Description
Province	Enter the province in which the reporting institution is located. This entry controls the view of the provincial codes on all of the pages (for this business unit) that are keyed by province.
Type of Student ID	Enter the type of ID that the reporting institution uses to identify students.
Sending Inst Type of Code (sending institution type of code)	Enter the sending institution's type of program or course code that it uses to identify transfer credits.
Receiving Inst Type of Code (receiving institution type of code)	Enter the receiving institution's type of program or course code that it uses to identify transfer credits.
Institution has Honour Roll	Select to indicate that the institution tracks academic excellence. You must select this check box in order for the extract program to generate a value other than the default value for Element 5140.

Defining Canadian Reporting Business Unit Defaults

Access the Unit Defaults page ((**Records and Enrollment** > **Government Reporting Canada** > **Definitions** > **Business Unit Table** > **Unit Defaults**).

This example illustrates the fields and controls on the Unit Defaults page. You can find definitions for the fields and controls later on this page.

General	Unit Defaults	Career Usage
Business Unit:	PSUNV	PeopleSoft University
Program Duration Units:	Weeks	
Program Credit Units:	Credits	
Man. Paid OJT Duration Units:	Weeks	
Opt. Paid OJT Duration Units:	Weeks	
Man. Unpaid OJT Duration Units:	Weeks	
Optional Unpaid OJT Dur Units:	Weeks	
Course Duration Units:	Hours	
Course Credit Units:	Contct Hrs	
Lab Duration Units:	Hours	
Course OJT Duration Units:	Hours	

Field or Control	Description
Program Duration Units	Enter the unit of measure that defines the normal time that a full-time student requires to complete the program.
Program Credit Units	Enter the unit of measure that defines the number of credits or units of academic achievement that a full-time student requires to graduate from or complete the program.
Man. Paid OJT Duration Units (mandatory paid on the job training duration units)	Enter the unit of measure that defines the duration of mandatory paid on-the-job training.
Opt. Paid OJT Duration Units (optional paid on the job training duration units)	Enter the unit of measure that defines the duration of optional paid on-the-job training.
Man. Unpaid OJT Duration Units (mandatory unpaid on the job training duration units)	Enter the unit of measure that defines the duration of mandatory unpaid on-the-job training.
Optional Unpaid OJT Dur Units (optional unpaid on the job training duration units)	Enter the unit of measure that defines the duration of optional unpaid on-the-job training.
Course Duration Units	Enter the unit of measure that defines the normal time a full-time student requires to complete the course by way of traditional course delivery.
Course Credit Units	Enter the unit of measure that defines the number of credits or units typically awarded for successful completion of the course.
Lab Duration Units	Enter the unit of measure that defines the number of credits or units a full-time student requires to complete the laboratory or shop training included in the course.
Course OJT Duration Units (course on the job training duration units)	Enter the unit of measure that defines the duration of on the job training activities that are a regular part of the course.

Defining Canadian Reporting Business Unit Career Usage Values

Access the Career Usage page (**Records and Enrollment > Government Reporting Canada > Definitions > Business Unit Table > Career Usage**).

Field or Control	Description
Career Order No (career order number)	Enter a career order number for the corresponding academic career. This number determines the order in which the system processes careers when it looks to report start and end dates on the Institution Description file. The Institution Description file is an PSIS report.

<i>Field or Control</i>	<i>Description</i>
Academic Career	Enter rows for all careers that you want to report.

Reviewing Delivered Report Types and Element Numbers

To set up report types, use the Define Report Type component (CAN_RPT_TYPE) and the Define Govt Element component (CAN_GOV_ELEM).

This section discusses how to:

- Review delivered government report types.
- Review delivered government elements.

Pages Used to Review Delivered Codes

<i>Page Name</i>	<i>Definition Name</i>	<i>Navigation</i>	<i>Usage</i>
Report Type	CAN_RPT_TYPE	Records and Enrollment > Government Reporting Canada > Definitions > Define Report Type > Report Type	All (Delivered by Campus Solutions): Review report type values.
Government Element	CAN_GOV_ELEMENT	Records and Enrollment > Government Reporting Canada > Definitions > Define Govt Element > Government Element	All (Delivered by Campus Solutions): Review government element values.

Reviewing Delivered Government Report Types

Access the Report Type page (**Records and Enrollment > Government Reporting Canada > Definitions > Define Report Type > Report Type**).

<i>Field or Control</i>	<i>Description</i>
Description	The report type description.
Short Description	The report type short description.

Reviewing Delivered Government Elements

Access the Government Element page (**Records and Enrollment > Government Reporting Canada > Definitions > Define Govt Element > Government Element**).

<i>Field or Control</i>	<i>Description</i>
Element Number	The element number specified in the government documentation.
Element Default	The element default value specified in the government documentation.

Defining Element Classifications

To set up element classifications, use the Define Element Class component (CAN_RPT_ELEM_CL).

This section discusses how to define element classification types.

Page Used to Define Element Classification Types

<i>Page Name</i>	<i>Definition Name</i>	<i>Navigation</i>	<i>Usage</i>
Element Class	CAN_RPT_ELEM_CLASS	Records and Enrollment > Government Reporting Canada > Definitions > Define Element Class > Element Class	All (Delivered by Campus Solutions for PSUNV): Define element classification types for your institution. Copy the values delivered with the Campus Solutions system.

Defining Element Classification Types

Access the Element Class page (**Records and Enrollment > Government Reporting Canada > Definitions > Define Element Class > Element Class**).

This example illustrates the fields and controls on the Element Class page. You can find definitions for the fields and controls later on this page.

Element Class

Institution: PSUNV PeopleSoft University

Report Type: PSIS Postsecondary Student Info Sys

Government Element: CITIZ Country of Citizenship

Find | View All First 1 of 1 Last

Element Number: 4280 + -

Effective Date: 01/01/1900 **Status:** Active

***Element Classification:** RB Rule Based **RB Procedure Nbr:** 57

Description:

Field or Control	Description
Element Classification	Copying the values delivered with <i>PSUNV</i> , enter the reporting classification for the element. Values are CM (classification mapping), DM (direct mapping), MM (master mapping), RB (rules based), and SM (separate mapping).
RB Procedure Nbr (rules based procedure number)	Copying the values delivered with <i>PSUNV</i> , for rules based elements only, enter a procedure number. This number defines the procedure number that the extract program executes. You cannot create duplicate procedure numbers within a report type. MET procedure numbers <i>must</i> be numbered in the 200 series. Changes and additions to the values delivered with <i>PSUNV</i> require modification.
Panel Navigation	Enter the panel navigation to define the location where users enter the data. This field is informational only and has no programming tied to it.

Defining Report Periods

To set up report periods, use the Define Report Period component (CAN_RPT_PERIOD).

This section discusses how to define report periods.

Page Used to Define Report Periods

<i>Page Name</i>	<i>Definition Name</i>	<i>Navigation</i>	<i>Usage</i>
Report Period	CAN_RPT_PERIOD	Records and Enrollment > Government Reporting Canada > Definitions > Define Report Period > Report Period	All: Define reporting periods.

Defining Report Periods

Access the Report Period page (**Records and Enrollment > Government Reporting Canada > Definitions > Define Report Period > Report Period**).

This example illustrates the fields and controls on the Report Period page. You can find definitions for the fields and controls later on this page.

Report Period

Institution: PSUNV PeopleSoft University

Report Type: PSIS Postsecondary Student Info Sys

Report Period: 200910 **Student ID Freeze Date:**

***Description:**

Short Description:

Report Due Date: 

PSIS Report Type: 

PSIS Start Year:

PSIS Period Start: 

PSIS Period End: 

<i>Field or Control</i>	<i>Description</i>
Institution	Enter the institution for which you will run the report.
Report Type	Enter the report type to which the reporting period pertains.
Report Period	Enter a unique reporting submission period for your report type.

Field or Control	Description
Report Due Date	Enter the date upon which you must report data. The system uses this date to perform effective date checking. This enables you to process data after the report date, and as long as the changes have an effective date, the system does not pick them up for reporting. If you need to make corrections to reporting data, you must ensure that the data has an effective date that is less than or equal to this report due date.
Student ID Freeze Date	The date that the student list, for the selected reporting period, is frozen.

The following fields are available for entry if you specify a report type of *PSIS*.

Field or Control	Description
PSIS Report Type	Enter the type of report to be run.
PSIS Start Year	Enter the year in which the current reporting period begins.
PSIS Period Start	Enter the start date of the reporting period.
PSIS Period End	Enter the end date of the report period.

The following fields are available for entry if you specify a report type of *USISE*.

Field or Control	Description
REPDAY (report day)	Enter a value for the report date.

The following fields are available for entry if you specify a report type of *CIS*.

Field or Control	Description
Submission Type	Enter the reporting submission type.
Academic Year	Enter the academic year for the reporting type.

The following fields are available for entry if you specify a report type of *MET*.

Field or Control	Description
REPDAY (report day)	Enter a value for the report date.

Field or Control	Description
Term Enroll Prd (term enrollment period)	<p>Select <i>Fall</i> to report the QUALIF value mapped from the plan mapping table or the program mapping table. If you select <i>Winter</i>, <i>Spring</i>, or <i>Summer</i>, the system reports the FIN_QUALIF value.</p> <hr/> <p>Note: For Ontario schools that report OUAC elements in the Fall, ensure that the Fall reporting period that you set up for MET reporting is <i>identical</i> to the reporting period for OUAC. If the reporting period for MET and OUAC differ, the flat file process cannot combine the reporting files.</p>

Reviewing Delivered Government Element Codes

To set up government element codes, use the Define Forpos Code component (CAN_RPT_FORPOS), Define Quacod Code component (CAN_RPT_QUACOD), Define Qualif Code component (CAN_RPT_QUALIF), Define Seshun Code component (CAN_RPT_SESHUN), and the Define Spemaj Code component (CAN_RPT_SPEMAJ).

This section lists the pages used to review delivered government element codes.

Pages Used to Review Delivered Government Element Codes

Page Name	Definition Name	Navigation	Usage
Forpos Code (formula program of study code)	CAN_RPT_FORPOS	Records and Enrollment > Government Reporting Canada > Definitions > Define Forpos Code > Forpos code	USISE, MET: Review delivered FORPOS codes.
Quacod Code (coded title of qualification code)	CAN_RPT_QUACOD	Records and Enrollment > Government Reporting Canada > Definitions > Define Quacod Code > Quacod Code	USISE, MET: Review delivered QUACOD codes.
Qualif Code (qualification code)	CAN_RPT_QUALIF	Records and Enrollment > Government Reporting Canada > Definitions > Define Qualif Code > Qualif Code	USISE, MET: Review delivered QUALIF codes.
Seshun Code (session code)	CAN_RPT_SESHUN	Records and Enrollment > Government Reporting Canada > Definitions > Define Seshun Code > Seshun Code	USISE, MET: Review delivered SESHUN codes.

Page Name	Definition Name	Navigation	Usage
Spemaj Code (specialization of major field of study code)	CAN_RPT_SPEMAJ	Records and Enrollment > Government Reporting Canada > Definitions > Define Spemaj Code > Spemaj Code	USISE, MET: Review delivered SPEMAJ codes.

Reviewing Delivered County and Country Codes

To set up county and country codes, use the Define Country Codes component (CAN_GOV_COUNTRY).

This section lists the pages used to review delivered county and country codes.

Pages Used to Review Delivered County and Country Codes

Page Name	Definition Name	Navigation	Usage
County Code	CAN_GOV_COUNTRY	Records and Enrollment > Government Reporting Canada > Definitions > Define County Codes > Country Code	PSIS, USISE, MET: Review delivered county codes.
Country Code	CAN_GOV_COUNTRY	Records and Enrollment > Government Reporting Canada > Definitions > Define Country Codes > Country Code	PSIS, USISE, MET: Review delivered country codes.

Reviewing Delivered Language, School, and CIS Language Codes

To set up language, school, and CIS language codes, use the Define Language Codes component (CAN_GOV_LANG), Define School Codes component (CAN_GOV_SCHOOL), and the Define CIS Language Code component (CAN_CIS_LANGUAGE).

This section lists the pages used to review delivered language, school, and CIS language codes.

Pages Used to Review Delivered Language, School, and CIS Language Codes

<i>Page Name</i>	<i>Definition Name</i>	<i>Navigation</i>	<i>Usage</i>
Language Code	CAN_GOV_LANG	Records and Enrollment > Government Reporting Canada > Definitions > Define Language Codes > Language Code	PSIS, USISE, MET: Review delivered language codes.
School Code	CAN_GOV_SCHOOL	Records and Enrollment > Government Reporting Canada > Definitions > Define School Codes > School Code	PSIS, CIS: Review delivered school codes.
CIS Language Code	CAN_CIS_LANGUAGE	Records and Enrollment > Government Reporting Canada > Definitions > Define CIS Language Code > CIS Language code	CIS: Review delivered CIS language codes.

Defining Provincial Codes

To set up provincial codes, use the Prov Approval Codes component (CAN_PROV_APPR_TBL), Prov Course Funding Codes component (CAN_PROV_FNDCRS), Prov Funding by Citizen component (CAN_PROV_CITZ), Prov Major Field of Study component (CAN_PROV_MAJOR), Prov Program Codes component (CAN_PROV_PROG), and the Prov Prog Funding Codes component (CAN_PROV_FUND).

This section discusses how to:

- Define program funding approval codes.
- Define provincial course funding codes.
- Define provincial citizen funding codes.
- Define provincial major field of study codes.
- Define provincial program codes.
- Define provincial program funding codes.
- Define provincial special initiative codes.

Pages Used to Define Provincial Codes

Page Name	Definition Name	Navigation	Usage
Prov Approval Codes (provincial approval codes)	CAN_PROV_APPR_TBL	Records and Enrollment > Government Reporting Canada > Definitions > Prov Approval Codes > Prov Approval Codes	PSIS: Populate this page if your institution reports this information to the Provincial Ministry. The Program and Plan Mapping tables prompt against the approval codes you define.
Prov Course Fund Code (provincial course funding code)	CAN_PROV_FNDCRS	Records and Enrollment > Government Reporting Canada > Definitions > Prov Course Funding Codes > Prov Course Fund Code	PSIS: Populate this page if your institution reports this information to the Provincial Ministry. The Cdn PSIS Course Data table prompts against the course funding codes you define.
Prov Citizenship Fund Class (provincial citizenship funding classification)	CAN_PROV_CITZ	Records and Enrollment > Government Reporting Canada > Definitions > Prov Funding by Citizen > Prov Citizenship Fund Class	PSIS: Populate this page if your institution reports this information to the Provincial Ministry. The PSIS Student Data table prompts against the classification funding codes you define.
Prov Major Code (provincial major code)	CAN_PROV_MAJOR	Records and Enrollment > Government Reporting Canada > Definitions > Prov Major Field of Study > Prov Major Code	PSIS: Populate this page if your institution reports this information to the Provincial Ministry. The program and plan mapping tables prompt against the major codes you define.
Prov Program Code (provincial program code)	CAN_PROV_PROG	Records and Enrollment > Government Reporting Canada > Definitions > Prov Program Codes > Prov Program Code	PSIS: Populate this page if your institution reports this information to the Provincial Ministry. The program and plan mapping tables prompt against the program codes you define.
Prov Prog Funding Code (provincial program funding code)	CAN_PROV_FUND	Records and Enrollment > Government Reporting Canada > Definitions > Prov Prog Funding Codes > Prov Prog Funding code	PSIS: Populate this page if your institution reports this information to the Provincial Ministry. The program and plan mapping tables prompt against the province program funding code.

Defining Program Funding Approval Codes

Access the Prov Approval Codes page (**Records and Enrollment > Government Reporting Canada > Definitions > Prov Approval Codes > Prov Approval Codes**).

<i>Field or Control</i>	<i>Description</i>
Province	The system populates the province field to the value defined for your business unit.
Approval Code	Enter the provincial code that defines whether the student is approved for funding in the program.
Description and Short Description	Enter the descriptions for the code.

Defining Provincial Course Funding Codes

Access the Prov Course Fund Code page (**Records and Enrollment > Government Reporting Canada > Definitions > Prov Course Funding Codes > Prov Course Fund Code**).

<i>Field or Control</i>	<i>Description</i>
Province	The system populates the province field by default to the value defined for your business unit.
Crse Fund Cd (course funding code)	Enter the provincial code that defines the course funding code.

Defining Provincial Citizen Funding Codes

Access the Prov Citizenship Fund Class page (**Records and Enrollment > Government Reporting Canada > Definitions > Prov Funding by Citizen > Prov Citizenship Fund Class**).

<i>Field or Control</i>	<i>Description</i>
Province	The system populates the province field by default to the value defined for your business unit.
Funding Class by Citz (funding classification by citizen)	Enter the provincial code that classifies the student for grant purposes.

Defining Provincial Major Field of Study Codes

Access the Prov Major Code page (**Records and Enrollment > Government Reporting Canada > Definitions > Prov Major Field of Study > Prov Major Code**).

<i>Field or Control</i>	<i>Description</i>
Province	The system populates the province field by default to the value defined for your business unit.
Prov Major (province major)	Enter the provincial code that classifies students' major field of study.

Defining Provincial Program Codes

Access the Prov Program Code page ((**Records and Enrollment > Government Reporting Canada > Definitions > Prov Program Codes > Prov Program Code**)).

<i>Field or Control</i>	<i>Description</i>
Province	The system populates the province field by default to the value defined for your business unit.
Prog Category (program category)	Enter the provincial code that defines the program category.

Defining Provincial Program Funding Codes

Access the Prov Prog Funding Code page (**Records and Enrollment > Government Reporting Canada > Definitions > Prov Prog Funding Codes > Prov Prog Funding code**).

<i>Field or Control</i>	<i>Description</i>
Province	The system populates the province field by default to the value defined for your business unit.
Prov Fund Cd (province funding code)	Enter the provincial code that classifies whether the student has been approved for funding in the program.

Defining Provincial Special Initiative Codes

Access the Prov Special Initiative Code page (**Records and Enrollment > Government Reporting Canada > Definitions > Prov Special Initiative Code**).

<i>Field or Control</i>	<i>Description</i>
Province	The system populates the province field by default to the value defined for your business unit.

<i>Field or Control</i>	<i>Description</i>
Special Init Cd (special initiative code page)	Enter the provincial special initiative code that associates with students in the program.

Defining General Mapping Tables

To set up general mapping tables, use the Language Mapping component (CAN_RPT_TONGUE), Province Mapping component (CAN_RPT_PROV), Reporting Sequence Mapping component (CAN_RPT_SEQ), Term Group Mapping component (CAN_RPT_TERM_GRP), OUAC Applno Mapping component (CAN_RPT_APPLNO), Classification Mapping component (CAN_RPT_CM), Direct Mapping component (CAN_RPT_DM), Master Mapping component (CAN_RPT_MM), and the Separate Mapping component (CAN_RPT_SM).

This section discusses how to:

- Define mapping language codes.
- Review delivered province codes.
- Map Canadian reporting sequence.
- Map terms and sessions to reporting periods.
- Review delivered OUAC application numbers.
- Define the classification mapping tables.
- Define the direct mapping table.
- Define the master mapping table.
- Define the separate mapping table.

Pages Used to Define General Mapping Tables

<i>Page Name</i>	<i>Definition Name</i>	<i>Navigation</i>	<i>Usage</i>
Language Mapping	CAN_RPT_TONGUE	Records and Enrollment > Government Reporting Canada > Mapping > Language Mapping > Language Mapping	CIS, PSIS, MET, USISE: Map language codes.
Province Mapping	CAN_RPT_PROV	Records and Enrollment > Government Reporting Canada > Mapping > Province Mapping > Province Mapping	CIS, MET, USISE: Review Campus Solutions delivered province codes.

Page Name	Definition Name	Navigation	Usage
Reporting Sequence Mapping	CAN_RPT_SEQ	Records and Enrollment > Government Reporting Canada > Mapping > Reporting Sequence Mapping > Reporting Sequence Mapping	USISE (Optional): Define a record and reporting sequence for the USISE report type. Populate this page to limit your USIS Enrollment file to only one record per student from the CAN_STDNT_LST table.
Term Group Mapping	CAN_RPT_TERM_GRP	Records and Enrollment > Government Reporting Canada > Mapping > Term Group Mapping > Term Group Mapping	ALL: For each report type, report period, and career, map the applicable terms and sessions that you want to report.
OUAC Applno Mapping (OUAC application number mapping)	CAN_RPT_APPLNO	Records and Enrollment > Government Reporting Canada > Mapping > OUAC Applno Mapping > OUAC Applno Mapping	OUAC: Review delivered OUAC application numbers.
Classification Mapping	CAN_RPT_CM	Records and Enrollment > Government Reporting Canada > Mapping > Classification Mapping Table > Classification Mapping	PSIS: Define classification mapping values.
Direct Mapping	CAN_RPT_DM	Records and Enrollment > Government Reporting Canada > Mapping > Direct Mapping Table > Direct Mapping	CIS, PSIS, USISE: Define direct mapping values.
Master Mapping	CAN_RPT_MM	Records and Enrollment > Government Reporting Canada > Mapping > Master Mapping Table > Master Mapping	CIS, PSIS, USISE, OUAC: Define master mapping values.
Separate Mapping	CAN_RPT_SM	Records and Enrollment > Government Reporting Canada > Mapping > Separate Mapping Table > Separate Mapping	CIS, PSIS, OUAC, USISE: Define separate mapping values.

Defining Mapping Language Codes

Access the Language Mapping page (**Records and Enrollment > Government Reporting Canada > Mapping > Language Mapping > Language Mapping**).

Field or Control	Description
Language Code	Enter the PeopleSoft language code that you want to map.
CIS Tongue	Enter the corresponding CIS value for the language code. Map this field if your institution performs CIS reporting. This field prompts against the CAN_CIS_LANG record.
Tongue	Enter the corresponding USISE value for the language code. Map this field if your institution performs USISE or MET reporting.
PSIS Language	Enter the corresponding PSIS value for the language code. Map this field if your institution performs PSIS reporting. This field prompts against the CAN_GOV_LANG record.

Reviewing Delivered Province Codes

Access the Province Mapping page (**Records and Enrollment > Government Reporting Canada > Mapping > Province Mapping > Province Mapping**).

Field or Control	Description
Province	The PeopleSoft province value that you want to map.
Province Number	The province code as defined by Statistics Canada.

Mapping Canadian Reporting Sequence

Access the Reporting Sequence Mapping page (**Records and Enrollment > Government Reporting Canada > Mapping > Reporting Sequence Mapping > Reporting Sequence Mapping**).

Field or Control	Description
Record	Enter the Campus Solutions record name that determines reporting sequence for this report type. For example, <i>STDNT_CAR_TERM</i> .
Field Name	Enter the Campus Solutions field name that determines reporting sequence for this report type. For example, <i>ACAD_CAREER</i> .

Field or Control	Description
Reporting Sequence	Enter the sequence or priority number that relates to the PeopleSoft value for the field you specify. At runtime, you specify which value that you want the system to select for processing in the event that the selection process finds multiple records for a student. For example, <i>05</i> .
PeopleSoft Value	Enter the codes for the field name you specify. For example, <i>GRAD</i> .

Mapping Terms and Sessions to Reporting Periods

Access the Term Group Mapping page (**Records and Enrollment > Government Reporting Canada > Mapping > Term Group Mapping > Term Group Mapping**).

This example illustrates the fields and controls on the Term Group Mapping page. You can find definitions for the fields and controls later on this page.

Term Group Mapping

Institution: PSUNV PeopleSoft University
Report Type: PSIS Postsecondary Student Info Sys
Report Period: 200910 PSIS Test Report
Academic Career: UGRD Undergraduate

Customize Find First 1 of 1 Last			
*Term	*Session	Report Type	Withdrawal Date
0630 2009 Fall	Regular Academic Session	Prelim Rpt	12/31/2009

Field or Control	Description
Institution	Enter the reporting institution.
Report Type	Enter the report type.
Report Period	Enter a reporting period for the report type.
Academic Career	Enter the academic career that you want to include for the reporting period.
Term	Enter the term for the career and report period.
Session	Enter the institution session for the term and report period.

The following fields are available for entry if you specify a report type of *CIS*.

Field or Control	Description
CIS Session	Enter the appropriate CIS session value for the term and session you specify.

The following fields are available for entry if you specify a report type of *PSIS*.

Field or Control	Description
Report Type	Select the report in which you want to include the term and session data. Values are: <i>Prelim Report (preliminary report)</i> : Select to include the term and session data in the Preliminary Report and the Final Report. <i>Final Report</i> : Select to include the term and session data in the Final Report only.
Withdrawal Date	Enter the last date in the term and session that a student can withdraw from a course without academic penalty.

The following fields are available for entry if you specify a report type of *USISE* or *MET*.

Field or Control	Description
Seshun Value (session value)	Enter the appropriate USIS Enrolment Seshun value for the term and session specified.

Reviewing Delivered OUAC Application Numbers

Access the OUAC Applno page (**Records and Enrollment > Government Reporting Canada > Mapping > OUAC Applno Mapping > OUAC Applno Mapping**).

Field or Control	Description
OUAC Appl Nbr (OUAC application number)	Enter the two-digit OUAC application number (APPLNO).
OUAC APPLN (OUAC application number)	Enter the converted one digit application number (CNVAPL).

Defining the Classification Mapping Table

Access the Classification Mapping page (**Records and Enrollment > Government Reporting Canada > Mapping > Classification Mapping Table > Classification Mapping**).

This example illustrates the fields and controls on the Classification Mapping page. You can find definitions for the fields and controls later on this page.

The screenshot shows the 'Classification Mapping' page. At the top, it displays the following information:

- Institution:** PSUNV (PeopleSoft University)
- Report Type:** PSIS (Postsecondary Student Info Sys)
- Can Govt Elem:** CLASSROOM (Classroom Instruction Course)

Below this is a search bar with 'Find | View All' and navigation buttons for 'First', '1 of 1', and 'Last'. The main form contains the following fields:

- Element Number:** 6110
- *Effective Date:** 01/01/1900
- *Status:** Active
- *Record:** CRSE_ATTENDANCE
- *Field Name:** INSTRUCTION_MODE
- *Selection Field:** INSTRUCTION_MODE

At the bottom, there is a section for 'Selection Field Value' with a search bar and navigation buttons for 'Find', 'First', '1 of 1', and 'Last'.

Values for the **Record**, **Field Name**, and **Selection Field** fields are delivered and defined for all applicable elements for PSUNV. Set up the same values for your institution if you perform PSIS reporting.

<i>Field or Control</i>	<i>Description</i>
Record	Enter the PeopleSoft record name that the system uses to report the specified element.
Field Name	Enter the PeopleSoft field name that the system uses to report the specified element. The system prompt table displays all valid fields for the record, but does not edit your input against the list. This enables you to enter a field name that is in a subrecord.
Selection Field	Enter the PeopleSoft selection field that applies to the element. This field must be on the record you specify. This field may be the same as or different from the Field Name value.
Selection Field Value	Enter the PeopleSoft selection field values that relate to the selection field that you want to report. You can enter more than one value.

Defining the Direct Mapping Table

Access the Direct Mapping page (**Records and Enrollment > Government Reporting Canada > Mapping > Direct Mapping Table > Direct Mapping**).

Values for the **Record**, **Field Name**, and **Selection Field** fields are delivered and defined for all applicable elements for PSUNV. Set up the same values for your institution if you perform PSIS reporting.

<i>Field or Control</i>	<i>Description</i>
Record	Enter the PeopleSoft record name that the system uses to report the specified element.
Field Name	Enter the PeopleSoft field name that the system uses to report the specified element. The prompt table displays all valid fields for the record, but does not edit your input against the list. This enables you to enter a field name that is in a subrecord.

Defining the Master Mapping Table

Access the Master Mapping page (**Records and Enrollment > Government Reporting Canada > Mapping > Master Mapping Table > Master Mapping**).

Values for the **Record**, **Field Name**, and **Selection Field** fields are delivered and defined for all applicable elements for PSUNV. Set up the same values for the report types that are applicable to your institution.

<i>Field or Control</i>	<i>Description</i>
Record	Enter the PeopleSoft record name that the system uses to report the specified element.
Field Name	Enter the PeopleSoft field name that the system uses to report the specified element. The prompt table displays all valid fields for the record, but does not edit your input against the list. This enables you to enter a field name that is in a subrecord.
PeopleSoft Value	Enter the delivered or user-defined values for the field name.
Government Value	Enter the government code that corresponds to the PeopleSoft value.

Defining the Separate Mapping Table

Access the Separate Mapping page (**Records and Enrollment > Government Reporting Canada > Mapping > Separate Mapping Table > Separate Mapping**).

Values for the **Record**, **Field Name**, and **Selection Field** fields are delivered and defined for all applicable elements for PSUNV. Set up the same values for the report types that are applicable to your institution.

Field or Control	Description
Record	Enter the PeopleSoft record name that the system uses to report the specified element.
Field Name	Enter the PeopleSoft field name that the system uses to report the specified element. The prompt table displays all valid fields for the record, but does not edit your input against the list. This enables you to enter a field name that is in a subrecord.
Gov't Record (government record)	Enter the PeopleSoft record that houses the translate codes.
Gov't Field Name (government field name)	Enter the Campus Solutions field that contains the government codes that correspond to the values in the field name.

Defining School Reporting Classifications

To set up school reporting classifications, use the School Type Table component (LS_SCHL_TYPE_TABLE).

Prerequisites

To see the **Canadian** field on the School Type table you must select the **Government Reporting** check box on the SA Features page.

Related Links

“Selecting Country-Specific Features and Enabling CRM for Higher Education Feature” (Campus Solutions Application Fundamentals)

Page Used to Define School Reporting Classifications

Page Name	Definition Name	Navigation	Usage
School Type Table	SCHOOL_TYPE_TABLE	Set Up SACR > Common Definitions > External Education > School Type Table > School Type Table	CIS, PSIS, MET, USISE: Define school reporting classifications. See “Setting Up School Types” (Recruiting and Admissions).

Defining Address and Phone Usage Values for Canadian Government Reporting

This section discusses how to:

- Define address usage values.
- Define email address usage values.
- Define phone usage values.

Related Links

“Establishing Address Usages” (Campus Community Fundamentals)

“Establishing Phone Usages” (Campus Community Fundamentals)

Pages Used to Define Address and Phone Usage Table Entries for Canadian Government Reporting

<i>Page Name</i>	<i>Definition Name</i>	<i>Navigation</i>	<i>Usage</i>
Address Usage	ADDR_USAGE_TABLE	Set Up SACR > Product Related > Campus Community > Establish People Processing > Setup > Address Usage Table > Address Usage	PSIS: Define Canadian reporting address usage values.
Phone Usage	PHONE_USAGE_TABLE	Set Up SACR > Product Related > Campus Community > Establish People Processing > Setup > Phone Usage Table > Phone Usage	PSIS: Define Canadian reporting phone usage values.

Defining Address Usage Values

Access the Address Usage page (**Set Up SACR > Product Related > Campus Community > Establish People Processing > Setup > Address Usage Table > Address Usage**).

To create an address usage for PSIS Current address reporting:

1. Access the Address Usage Table page.
2. Add an address usage of *RPT_ADDR*.
3. In the **Description** field, enter *Address Priority for Cdn Rpts*.
4. In the **Short Description** field, enter *Cdn Reports*.

5. Using the **Usage Order**, **Usage Type**, and **Address Type** fields, insert rows for all of your address types.

Defining Email Address Usage Values

Access the Address Usage page (**Set Up SACR > Product Related > Campus Community > Establish People Processing > Setup > Address Usage Table > Address Usage**).

To create an address usage for PSIS Current email address reporting:

1. Access the Address Usage Table page.
2. Add an address usage of *RPT_EMAIL*.
3. In the **Description** field, enter *E-mail Priority for Cdn Rpts*.
4. In the **Short Description** field, enter *Cdn Reports*.
5. Using the **Usage Order**, **Usage Type**, and **Email Type** fields, insert rows for all of your email address types.

Defining Phone Usage Values

Access the Phone Usage page (**Set Up SACR > Product Related > Campus Community > Establish People Processing > Setup > Phone Usage Table > Phone Usage**).

To create a phone usage for PSIS Current phone reporting:

1. Access the Phone Usage page.
2. Add a phone usage of *RPT_PHONE*.
3. In the **Description** field, enter *Phone Priority for Cdn Rpts*.
4. In the **Short Description** field, enter *Cdn Reports*.
5. Using the **Usage Order** and **Phone Type** fields, insert rows for all of your phone usage types.

Mapping Program Values for PSIS, USISE, MET, and OUAC

To set up program values for PSIS, USISE, MET, and OUAC, use the PSIS Program Table component (CAN_ESIS_PROG), and the Academic Program Table CDN component (CAN_RPT_PROG).

This section discusses how to:

- Define PSIS program mapping values.
- Define USISE program mapping values.
- Define MET and OUAC program mapping values.

Pages Used to Define PSIS, USISE, MET, and OUAC Program Mapping Values

<i>Page Name</i>	<i>Definition Name</i>	<i>Navigation</i>	<i>Usage</i>
PSIS Program Mapping 1	CAN_RPT_PROG3	Records and Enrollment > Government Reporting Canada > Academic Structure Tables > PSIS Program Table > PSIS Program Mapping 1	PSIS: Define PSIS program mapping values.
PSIS Program Mapping 2	CAN_RPT_PROG4	Records and Enrollment > Government Reporting Canada > Academic Structure Tables > PSIS Program Table > PSIS Program Mapping 2	PSIS: Define additional PSIS program mapping values.
PSIS Program Mapping 3	CAN_RPT_PROG5	Records and Enrollment > Government Reporting Canada > Academic Structure Tables > PSIS Program Table > PSIS Program Mapping 3	PSIS: Define additional PSIS program mapping values.
PSIS Program Mapping 4	CAN_RPT_PROG6	Records and Enrollment > Government Reporting Canada > Academic Structure Tables > PSIS Program Table > PSIS Program Mapping 4	PSIS: Define additional PSIS program mapping values.
USISE Program Mapping	CAN_RPT_PROG	Records and Enrollment > Government Reporting Canada > Academic Structure Tables > Academic Program Table CDN > USISE Program Mapping	USISE: Define USISE program mapping values.
MET/OUAC Program Mapping	CAN_RPT_PROG2	Records and Enrollment > Government Reporting Canada > Academic Structure Tables > Academic Program Table CDN > MET/OUAC Program Mapping	MET, OUAC: Define MET and OUAC program mapping values.

Defining PSIS Program Mapping 1 Values

Access the PSIS Program Mapping 1 page (**Records and Enrollment > Government Reporting Canada > Academic Structure Tables > PSIS Program Table > PSIS Program Mapping 1**).

This example illustrates the fields and controls on the PSIS Program Mapping 1 page. You can find definitions for the fields and controls later on this page.

PSIS Program Mapping 1		PSIS Program Mapping 2		PSIS Program Mapping 3		PSIS Program Mapping 4	
Academic Institution:	PSUNV	PeopleSoft University					
Academic Program:	LAU	Liberal Arts Undergraduate					
Find View All First 1 of 1 Last							
*Effective Date:	01/01/1900	*Status:	Active				
Credential Type:	Degree	Joint Credential Type:	N/A				
Program Type:	Bach Degr	Joint Program Type:	CollegeTsf				
Program Duration:	8.00	Duration Units:	Semesters				
Duration in Hrs:	200	Continuing Education:	No				
Prov Prog Cat:	PRVCT1	Alberta Prov Prog Cat 1					
Prov Fund Cd:	FNDCCD1	AB Funding Code 1					

Field or Control	Description
Credential Type	Enter the type of credential awarded to students for successful completion of the program.
Joint Credential Type	Enter the joint or second credential for joint program in which a student typically receives two credentials.
Program Type	Enter the program type.
Joint Program Type	Enter the type of joint credential awarded to students for successful completion of the program.
Prog Duration (program duration)	Enter the normal time to complete the program for a full-time student who takes courses through traditional delivery.
Duration Units	Enter the unit of measure for the program duration. The system populates this field by default from the Business Unit Table page.
Duration in Hrs (duration in hours)	Enter the sum of the hours of instruction to complete the program for a full-time student who takes courses through traditional delivery.
Prov Prog Cat (province program category)	Enter the program category as defined by the Provincial Ministry. This field prompts against the CAN_PROV_PROG record.

Field or Control	Description
Prov Fund Cd (province funding code)	Enter the provincial funding code as defined by the Provincial Ministry. This field prompts against the CAN_PROV_FUND record.

Defining PSIS Program Mapping 2 Values

Access the PSIS Program Mapping 2 page (**Records and Enrollment > Government Reporting Canada > Academic Structure Tables > PSIS Program Table > PSIS Program Mapping 2**).

This example illustrates the fields and controls on the PSIS Program Mapping 2 page. You can find definitions for the fields and controls later on this page.

The screenshot shows the 'PSIS Program Mapping 2' page with the following details:

- Academic Institution:** PSUNV PeopleSoft University
- Academic Program:** LAU Liberal Arts Undergraduate
- Effective Date:** 01/01/1900
- Credits Needed:** 100.00
- Full/Part Time:** FT/PT
- Enrollment Limit:** Instit Lim
- Entrance Rqmt:** No Ent Req
- Medical Rqmt:** N/A (A)
- Experience Rqmt:** No (A)
- Status:** Active
- Credit Units:** Credits
- Delivered Under Contract:** Yes
- Capacity:** 200
- Legal Rqmt:** No
- Aptitude Rqmt:** Yes (A)
- Other Rqmt:** No

Field or Control	Description
Credits Needed	Enter the number of credits or units of academic achievement required to complete the program.
Credit Units	Enter the type of units used in the Credits Needed field. The system populates this field by default from the Business Unit Table.
Full/Part Time	Indicate the way in which the program is offered.
Delivered Under Contract	Indicate whether the program is delivered under contract by the institution to an outside party. Values are <i>N/A</i> , <i>No</i> , <i>Unknown</i> , and <i>Yes</i> .
Enrollment Limit	Indicate whether the program is limited, either by an internally or externally imposed quota.

Field or Control	Description
Capacity	If the program has limited enrollment, enter the maximum number of new students that can be admitted to the program during a report period.
Entrance Rqmt (entrance requirement)	Enter the educational entrance requirements to begin the program.
Legal Rqmt (legal requirement)	Indicate whether any legal requirements exist for the program. Your choices are <i>N/A</i> , <i>No</i> , <i>Unknown</i> , and <i>Yes</i> .
Medical Rqmt (medical requirement)	Indicate whether any medical or psychological entrance requirements exist for the program. Values are <i>N/A</i> , <i>No</i> , <i>Unknown</i> , and <i>Yes</i> .
Aptitude Rqmt (aptitude requirement)	Indicate whether successful completion of an aptitude and proficiency test (or interview) is an entrance requirement for the program. Values are <i>N/A</i> , <i>No</i> , <i>Unknown</i> , and <i>Yes</i> .
Experience Rqmt (experience requirement)	Indicate whether previous related experience is an entrance requirement for the program. Values are <i>N/A</i> , <i>No</i> , <i>Unknown</i> , and <i>Yes</i> .
Other Rqmt (other requirement)	Indicate whether any other entrance requirements are required for entry into the program. Values are <i>N/A</i> , <i>No</i> , <i>Unknown</i> , and <i>Yes</i> .

Defining PSIS Program Mapping 3 Values

Access the PSIS Program Mapping 3 page ((**Records and Enrollment** > **Government Reporting Canada** > **Academic Structure Tables** > **PSIS Program Table** > **PSIS Program Mapping 3**).

This example illustrates the fields and controls on the PSIS Program Mapping 3 page. You can find definitions for the fields and controls later on this page.

PSIS Program Mapping 1	PSIS Program Mapping 2	PSIS Program Mapping 3	PSIS Program Mapping 4
Academic Institution:		PSUNV	PeopleSoft University
Academic Program:		LAU	Liberal Arts Undergraduate
Find View All First 1 of 1 Last			
Effective Date:	01/01/1900	Status:	Active
Mandatory Paid OJT Duration:	333.00	Man Paid Units:	Hours
Optional Paid OJT Duration:	222.00	Opt Paid Units:	Hours
Mandatory Unpaid OJT Duration:	555.00	Man Unpaid OJT Units:	Hours
Optional Unpaid OJT Duration:	444.00	Opt Unpaid OJT Units:	Hours
Prov Major Field of Study:	MAJOR1	AB Major Field of Study 1	
Prov Approval Code:	ABAPR1	AB Prov Approval Code	

Field or Control	Description
Mandatory Paid OJT Duration (mandatory paid on the job training duration)	Enter the duration of mandatory paid on the job training (OJT) activities that are a regular part of the program.
Man Paid Units (mandatory paid units)	Enter the unit type for the Man Paid OJT Duration field. The system populates this field by default from the Business Unit table. The system populates a value of <i>N/A</i> if you do not enter a duration value.
Optional Paid OJT Duration (optional paid on the job training duration)	Enter the duration of optional paid on the job training activities that are a regular part of the program.
Opt Paid Units (optional paid units)	Enter the unit type for the Optional Paid OJT Duration field. The system populates this field by default from the Business Unit table. The system populates a value of <i>N/A</i> if you do not enter a duration value.
Mandatory Unpaid OJT Duration (mandatory unpaid on the job training duration)	Enter the duration of mandatory unpaid on the job training activities that are a regular part of the program.
Man Unpaid OJT Units (mandatory unpaid on the job training units)	Enter the unit type for the Mandatory Unpaid OJT Duration field. The system populates this field by default from the Business Unit table. The system populates a value of <i>N/A</i> if you do not enter a duration value.
Optional Unpaid OJT Duration (optional unpaid on the job training duration)	Enter the duration of optional unpaid on the job training activities that are a regular part of the program.

Field or Control	Description
Opt Unpaid OJT Units (optional unpaid on the job training units)	Enter the unit type for the Optional Unpaid OJT Duration field. The system populates this field by default from the Business Unit table. The system populates a value of <i>N/A</i> if you do not enter a duration value.

Defining PSIS Program Mapping 4 Values

Access the PSIS Program Mapping 4 page ((**Records and Enrollment** > **Government Reporting Canada** > **Academic Structure Tables** > **PSIS Program Table** > **PSIS Program Mapping 4**).

This example illustrates the fields and controls on the PSIS Program Mapping 4 page. You can find definitions for the fields and controls later on this page.

The screenshot shows the 'PSIS Program Mapping 4' page. At the top, there are four tabs: 'PSIS Program Mapping 1', 'PSIS Program Mapping 2', 'PSIS Program Mapping 3', and 'PSIS Program Mapping 4'. Below the tabs, the page displays the following information:

- Academic Institution:** PSUNV PeopleSoft University
- Academic Program:** LAU Liberal Arts Undergraduate
- Effective Date:** 01/01/1900
- Status:** Active
- Program Defaults:**
 - Cost Recovery Program: Yes
 - Articulated Program: Yes
 - Co-op Program: Yes
 - Brokered Program: Sponsor
 - Collaborative Program: Yes

Field or Control	Description
Cost Recovery Program	Indicate whether the program is a cost recovery program.
Articulated Program	Indicate whether, on completion of the credits for the program, the student is entitled to advanced standing in a target program in another institution with which the reporting institution has an articulation agreement.
Co-op Program	Indicate whether this is a co-op program.
Brokered Program	Indicate whether this is a brokered program.
Collaborative Program	Indicate whether the program is offered under a collaborative agreement, whereby two or more institutions share ownership or responsibility for the program and each delivers part of the program.

Defining USISE Program Mapping Values

Access the USISE Program Mapping page ((Records and Enrollment > Government Reporting Canada > Academic Structure Tables > Academic Program Table CDN > USISE Program Mapping).

This example illustrates the fields and controls on the USISE Program Mapping page. You can find definitions for the fields and controls later on this page.

The screenshot shows the 'USISE Program Mapping' page with the following details:

- Academic Institution:** PSUNV PeopleSoft University
- Academic Program:** FAU Fine Arts Undergraduate
- *Effective Date:** 01/01/1900
- *Status:** Active
- *QUALIF:** 13 UG-BA Degr
- FIN QUALIF:** 23 UG-Upgrd
- AWABOD:** Degree
- *HONIND:** Single Hon
- *QUACOD:** 081 Agricultur
- SESTYP:** Semester
- SPEMAJ:** 50399 Othe Agric
- *SESTOT:** 08
- *NORMCR:** 0200

<i>Field or Control</i>	<i>Description</i>
QUALIF	Enter the government code for qualification being sought. This field prompts against the Can Report QUALIF table. The system reports this value in the Fall submission.
FIN QUALIF	Enter the government code for qualification being sought. This field prompts against the Can Report QUALIF table. FIN QUALIF values are reported in all submissions excluding the one in the Fall.
AWABOD	Enter the government code that represents the body awarding the diploma or certificate.
HONIND	Enter the government code that represents the honors program indicator.
QUACOD	Enter the government code for coded title of qualification. This field prompts against the Can Report QUACOD table.
SESTYP	Enter the government code that represents the type of session.

Field or Control	Description
SPEMAJ	Enter the government code for specialization or major field of study. This field prompts against the Can Report SPEMAJ table.
SESTOT	Enter the government code that represents the total number of sessions required to complete the program.
NORMCR	Enter the government code that represents the normal credit/course/unit requirements.

Defining MET and OUAC Program Mapping Values

Access the MET/OUAC Program Mapping page (**Records and Enrollment > Government Reporting Canada > Academic Structure Tables > Academic Program Table CDN > MET/OUAC Program Mapping**).

This example illustrates the fields and controls on the MET/OUAC Program Mapping page. You can find definitions for the fields and controls later on this page.

USISE Program Mapping
MET/OUAC Program Mapping

Academic Institution: PSUNV PeopleSoft University

Academic Program: FAU Fine Arts Undergraduate

[Find](#) | [View All](#) | First 1 of 1 [Last](#)

Effective Date: 01/01/1900 **Status:** Active + -

MET Reporting

OUAC Reporting

FORPOS: U-Agriculture

FT Load:

Term Weight:

Min BIU:

UPREG:

Annual Weight:

MET Form Fee:

Max BIU: **Ineligible BIU**

Field or Control	Description
FORPOS (formula program of study)	Enter the government code that represents the formula program of study.
UPREG (university and program registration)	Enter the government code that represent the university and program in which applicants register.
FT Load	Enter the full time load for an academic program and plan as the institution defines it.

Field or Control	Description
Annual Weight	Established by MET and based on the FORPOS code. Weight varies for diploma and degree programs. Weights also differ from one institution to another for institution specific FORPOS codes.
Term Weight	Enter a value that the system uses when calculating the annual business income unit (BIU) for graduate levels.
MET Form Fee	Established by MET, based on the FORPOS code.
Min BIU (minimum business income unit)	Enter the minimum BIU that a graduate student can generate for an institution. This is independent of the actual number of years that the individual requires to complete his or her program of study.
Max BIU (maximum business income unit)	Enter the maximum BIU that a graduate student can generate for an institution. This is independent of the actual number of years that the individual requires to complete his or her program of study.
Ineligible BIU (ineligible business income unit)	Select this check box to indicate the academic program and plan is ineligible and the system should therefore not include it in the calculation of FTE (full time equivalency).

Mapping Plan Values for PSIS, USISE, MET, and OUAC

To set up plan values for PSIS, USISE, MET, and OUAC, use the PSIS Plan Table component (CAN_ESIS_PLAN) and the Academic Plan Table CDN component (CAN_RPT_PLAN).

This section discusses how to:

- Define PSIS plan mapping values.
- Define USISE plan mapping values.
- Define MET/OUAC plan mapping values.

Pages Used to Map PSIS, USISE, MET, and OUAC Plan Values

Page Name	Definition Name	Navigation	Usage
PSIS Plan Mapping 1	CAN_RPT_PLAN3	Records and Enrollment > Government Reporting Canada > Academic Structure Tables > PSIS Plan Table > PSIS Plan Mapping 1	PSIS: Define PSIS plan mapping values.
PSIS Plan Mapping 2	CAN_RPT_PLAN4	Records and Enrollment > Government Reporting Canada > Academic Structure Tables > PSIS Plan Table > PSIS Plan Mapping 2	PSIS: Define additional PSIS plan mapping values.
PSIS Plan Mapping 3	CAN_RPT_PLAN5	Records and Enrollment > Government Reporting Canada > Academic Structure Tables > PSIS Plan Table > PSIS Plan Mapping 3	PSIS: Define additional PSIS plan mapping values.
PSIS Plan Mapping 4	CAN_RPT_PLAN6	Records and Enrollment > Government Reporting Canada > Academic Structure Tables > PSIS Plan Table > PSIS Plan Mapping 4	PSIS: Define additional PSIS plan mapping values.
USISE Plan Mapping	CAN_RPT_PLAN	Records and Enrollment > Government Reporting Canada > Academic Structure Tables > Academic Plan Table CDN > USISE Plan Mapping	USISE: Define USISE plan mapping values.
MET/OUAC Plan Mapping	CAN_RPT_PLAN2	Records and Enrollment > Government Reporting Canada > Academic Structure Tables > Academic Plan Table CDN > MET/OUAC Plan Mapping	MET/OUAC: Define MET and OUAC plan mapping values.

Defining PSIS Plan Mapping 1 Values

Access the PSIS Plan Mapping 1 page (**Records and Enrollment > Government Reporting Canada > Academic Structure Tables > PSIS Plan Table > PSIS Plan Mapping 1**).

This example illustrates the fields and controls on the PSIS Plan Mapping 1 page. You can find definitions for the fields and controls later on this page.

PSIS Plan Mapping 1		PSIS Plan Mapping 2		PSIS Plan Mapping 3		PSIS Plan Mapping 4	
Academic Institution:	PSUNV	PeopleSoft University					
Academic Plan:	PSYCH	Psychology					
Find View All First 1 of 1 Last							
*Effective Date:	01/01/1900	*Status:	Active				
Credential Type:	Degree	Joint Credential Type:	N/A				
Program Type:	Bach Degr	Joint Program Type:	(Invalid Val				
Program Duration:	6.00	Duration Units:	Semesters				
Duration in Hrs:	150	Continuing Education					
Prov Prog Cat:	PRVCT1	Alberta Prov Prog Cat 1					
Prov Fund Cd:	FND CD1	AB Funding Code 1					

Field or Control	Description
Credential Type	Enter the type of credential the institution awards for successful completion of the program.
Joint Credential Type	Enter the joint or second credential for joint programs in which a student typically receives two credentials.
Program Type	Enter the program type.
Joint Program Type	Enter the type of joint credential the institution awards for successful completion of the program.
Program Duration	Enter the normal time to complete the entire program for a full-time student through traditional program delivery.
Duration Units	Enter the type of time unit you used to calculate program duration. Values are <i>Acad Years</i> , <i>Half - Semes</i> , <i>Months</i> , <i>NA</i> , <i>Semesters</i> , <i>Weeks</i> , and <i>Years</i> .
Duration in Hrs (duration in hours)	Enter the sum of the hours of instruction of courses normally required to complete the entire program through traditional delivery.

Defining PSIS Plan Mapping 2 Values

Access the PSIS Plan Mapping 2 page (**Records and Enrollment > Government Reporting Canada > Academic Structure Tables > PSIS Plan Table > PSIS Plan Mapping 2**).

This example illustrates the fields and controls on the PSIS Plan Mapping 2 page. You can find definitions for the fields and controls later on this page.

The screenshot shows the 'PSIS Plan Mapping 2' page with the following data and controls:

- Academic Institution:** PSUNV (PeopleSoft University)
- Academic Plan:** PSYCH (Psychology)
- Effective Date:** 01/01/1900
- Status:** Active
- Credits Needed:** 75.00
- Credit Units:** Credits
- Full/Part Time:** Full Time
- Delivered Under Contract:** Yes
- Enrollment Limit:** Instit Lim
- Capacity:** 150
- Entrance Rqmt:** No Ent Req
- Legal Rqmt:** Yes
- Medical Rqmt:** No
- Aptitude Rqmt:** Yes
- Experience Rqmt:** No
- Other Rqmt:** No

Field or Control	Description
Credits Needed	Enter the number of credits or units of academic achievement required to complete the program.
Credit Units	Enter the type of units used in the Credits Needed field. The system populates this field by default from the Business Unit table.
Full/Part Time	Indicate whether the program is offered on a full-time basis (<i>FT</i>), part-time basis (<i>PT</i>), or at the student's option (<i>FT/PT</i>).
Delivered Under Contract	Indicate whether the program is delivered under contract by the institution to an outside party. Values are <i>N/A</i> , <i>No</i> , <i>Unknown</i> , and <i>Yes</i> .
Enrollment Limit	Indicate whether the program is limited, either by an internally or externally imposed quota. Values are <i>Govt Limit</i> , <i>Instit Lim</i> , <i>N/A</i> , <i>No</i> , <i>Prof Org</i> , and <i>Unknown</i> .
Capacity	If the program has limited enrollment, enter the maximum number of new students that can be admitted to the program during a report period.

Field or Control	Description
Entrance Rqmt (entrance requirement)	Enter the educational entrance requirements to begin the program. Values are <i>N/A</i> , <i>No</i> , <i>Unknown</i> , and <i>Yes</i> .
Legal Rqmt (legal requirement)	Indicate whether any legal requirements exist for the program. Values are <i>N/A</i> , <i>No</i> , <i>Unknown</i> , and <i>Yes</i> .
Medical Rqmt (medical requirement)	Indicate whether any medical or psychological entrance requirements exist for the program. Values are <i>N/A</i> , <i>No</i> , <i>Unknown</i> , and <i>Yes</i> .
Aptitude Rqmt (aptitude requirement)	Indicate whether successful completion of an aptitude and proficiency test (or interview) is an entrance requirement for the program. Values are <i>N/A</i> , <i>No</i> , <i>Unknown</i> , and <i>Yes</i> .
Experience Rqmt (experience requirement)	Indicate whether previous related experience is an entrance requirement for the program. Values are <i>N/A</i> , <i>No</i> , <i>Unknown</i> , and <i>Yes</i> .
Other Rqmt (other requirement)	Indicate whether any other entrance requirements are required for entry into the program. Values are <i>N/A</i> , <i>No</i> , <i>Unknown</i> , and <i>Yes</i> .

Defining PSIS Plan Mapping 3 Values

Access the PSIS Plan Mapping 3 page (**Records and Enrollment > Government Reporting Canada > Academic Structure Tables > PSIS Plan Table > PSIS Plan Mapping 3**).

This example illustrates the fields and controls on the PSIS Plan Mapping 3 page. You can find definitions for the fields and controls later on this page.

PSIS Plan Mapping 1		PSIS Plan Mapping 2		PSIS Plan Mapping 3		PSIS Plan Mapping 4	
Academic Institution:	PSUNV	PeopleSoft University					
Academic Plan:	PSYCH	Psychology					
Find View All First 1 of 1 Last							
Effective Date:	01/01/1900	Status:	Active				
Mandatory Paid OJT Duration:	<input type="text" value="100.00"/>	Man Paid Units:	<input type="text" value="Hours"/>				
Optional Paid OJT Duration:	<input type="text" value="110.00"/>	Opt Paid Units:	<input type="text" value="Hours"/>				
Mandatory Unpaid OJT Duration:	<input type="text" value="120.00"/>	Man Unpaid OJT Units:	<input type="text" value="Hours"/>				
Optional Unpaid OJT Duration:	<input type="text" value="130.00"/>	Opt Unpaid OJT Units:	<input type="text" value="Hours"/>				
Prov Major Field of Study:	<input type="text" value="MAJOR1"/>	AB Major Field of Study 1					
Prov Approval Code:	<input type="text" value="ABAPR1"/>	AB Prov Approval Code					

Field or Control	Description
Mandatory Paid OJT Duration (mandatory paid on the job training duration)	Enter the duration of mandatory paid on the job training (OJT) activities that are a regular part of the program.
Man Paid Units (mandatory paid units)	Enter the unit type for the Man Paid OJT Duration field. The system populates this field by default from the Business Unit table. The system populates a value of <i>N/A</i> if you do not enter a duration value.
Optional Paid OJT Duration (optional paid on the job training duration)	Enter the duration of optional paid on the job training (OJT) activities that are a regular part of the program.
Opt Paid Units (optional paid units)	Enter the unit type for the Optional Paid OJT Duration field. The system populates this field by default from the Business Unit table. The system populates a value of <i>N/A</i> if you do not enter a duration value.
Mandatory Unpaid OJT Duration (mandatory unpaid on the job training duration)	Enter the duration of mandatory unpaid on the job training (OJT) activities that are a regular part of the program.
Man Unpaid OJT Units (mandatory unpaid on the job training units)	Enter the unit type for the Mandatory Unpaid OJT Duration field. The system populates this field by default from the Business Unit table. The system populates a value of <i>N/A</i> if you do not enter a duration value.
Optional Unpaid OJT Duration (optional unpaid on the job training duration)	Enter the duration of optional unpaid on the job training (OJT) activities that are a regular part of the program.

<i>Field or Control</i>	<i>Description</i>
Opt Unpaid OJT Units (optional unpaid on the job training units)	Enter the unit type for the Optional Unpaid OJT Duration field. The system populates this field by default from the Business Unit table. The system populates a value of <i>N/A</i> if you do not enter a duration value.

Defining PSIS Plan Mapping 4 Values

Access the PSIS Plan Mapping 4 page (**Records and Enrollment > Government Reporting Canada > Academic Structure Tables > PSIS Plan Table > PSIS Plan Mapping 4**).

This example illustrates the fields and controls on the PSIS Plan Mapping 4 page. You can find definitions for the fields and controls later on this page.

<i>Field or Control</i>	<i>Description</i>
Cost Recovery Program	Indicate whether the program is a cost recovery program.
Articulated Program	Indicate whether, on completion of the credits for the program, the student is entitled to advanced standing in a target program in another institution with which the reporting institution has an articulation agreement.
Co-op Program	Indicate whether this is a co-op program.
Brokered Program	Indicate whether the program is a brokered program.
Collaborative Program	Indicate whether the program is offered under a collaborative agreement, whereby two or more institutions share ownership or responsibility for the program and each delivers part of the program.

Defining USISE Plan Mapping Values

Access the USISE Plan Mapping page (**Records and Enrollment > Government Reporting Canada > Academic Structure Tables > Academic Plan Table CDN > USISE Plan Mapping**).

This example illustrates the fields and controls on the USISE Plan Mapping page. You can find definitions for the fields and controls later on this page.

The screenshot shows the 'USISE Plan Mapping' page with the following details:

- Academic Institution:** PSUNV PeopleSoft University
- Academic Plan:** CNED-QTGR General CE Grad Quarter Cal
- Effective Date:** 01/01/1900
- *Status:** Active
- *QUALIF:** 03 UG-Prelim
- FIN QUALIF:** 03 UG-Prelim
- AWABOD:** Degree
- *HONIND:** Single Hon
- *QUACOD:** 081 Agricultur
- SESTYP:** Cal Year
- SPEMAJ:** 00000 Gen Arts&S
- *SESTOT:** 01
- *NORMCR:** 0002

<i>Field or Control</i>	<i>Description</i>
QUALIF	Enter the government code for qualification being sought. This field prompts against the Can Report QUALIF table. The system reports this value in the Fall submission.
FIN QUALIF	Enter the government code for qualification being sought. This field prompts against the Can Report QUALIF table. FIN QUALIF values are reported in all submissions excluding the one in the Fall.
AWABOD	Enter the government code that represents the body awarding diploma or certificate.
HONIND	Enter the government code that represents the honors program indicator.
QUACOD	Enter the government code for coded title of qualification. This field prompts against the Can Report QUACOD table.
SESTYP	Enter the government code that represents the type of session.
SPEMAJ	Enter the government code for specialization or major field of study. This field prompts against the Can Report SPEMAJ table.

Field or Control	Description
SESTOT	Enter the government code that represents the total number of sessions required to complete the program.
NORMCR	Enter the government code that represents the normal credit/course/unit requirements.

Defining MET/OUAC Plan Mapping Values

Access the MET/OUAC Plan Mapping page (**Records and Enrollment > Government Reporting Canada > Academic Structure Tables > Academic Plan Table CDN > MET/OUAC Plan Mapping**).

This example illustrates the fields and controls on the MET/OUAC Plan Mapping page. You can find definitions for the fields and controls later on this page.

USISE Plan Mapping
MET/OUAC Plan Mapping

Academic Institution: PSUNV PeopleSoft University
Academic Plan: CNED-QTGR General CE Grad Quarter Cal

Find | View All First 1 of 1 Last

Effective Date: 01/01/1900 **Status:** Active

MET Reporting
OUAC Reporting

FORPOS: U-Agriculture **UPREG:**

FT Load: **Annual Weight:**

Term Weight: **MET Form Fee:**

Min BIU: **Max BIU:** Ineligible BIU

Field or Control	Description
FORPOS (formula program of study)	Enter the government code that represents the formula program of study.
UPREG (university and program registration)	Enter the government code that represents the university and program in which the applicant registers.
FT Load	Enter the full time load for an academic program and plan as the institution defines it.

Field or Control	Description
Annual Weight	Established by MET and based on the FORPOS code. Weight varies for diploma and degree programs. Weights also differ from one institution to another for institution specific FORPOS codes.
Term Weight	Enter a value that the system uses when calculating the annual business income unit (BIU) for graduate levels.
Met Form Fee	Established by MET, based on the FORPOS code.
Min BIU (minimum business income unit)	Enter the minimum BIU that a graduate student can generate for an institution. This is independent of the actual number of years that the individual requires to complete his or her program of study.
Max BIU (maximum business income unit)	Enter the maximum BIU that a graduate student can generate for an institution. This is independent of the actual number of years that the individual requires to complete his or her program of study.
Ineligible BIU (ineligible business income unit)	Select this check box to indicate the academic program and plan is ineligible and the system should therefore not include it in the calculation of FTE (full time equivalency).

Defining CIS Program, Plan, and Subplan Tables

To set up CIS program, plan, and subplan tables, use the CIS Program Table component (CAN_CIS_PROG), CIS Plan Table component (CAN_CIS_PLAN), and the CIS Subplan Table component (CAN_CIS_SUBPLAN).

This section discusses how to:

- Define the CIS program table.
- Define the CIS plan table.
- Define the CIS subplan table.

Pages Used to Define CIS Program, Plan and Subplan Values

<i>Page Name</i>	<i>Definition Name</i>	<i>Navigation</i>	<i>Usage</i>
CIS Program Table	CAN_CIS_PROG	Records and Enrollment > Government Reporting Canada > Academic Structure Tables > CIS Program Table > CIS Program Table	CIS: Define the CIS program table.
CIS Plan Table	CAN_CIS_PLAN	Records and Enrollment > Government Reporting Canada > Academic Structure Tables > CIS Plan Table > CIS Plan Table	CIS: Define the CIS plan table.
CIS Subplan Table	CAN_CIS_SUBPLAN	Records and Enrollment > Government Reporting Canada > Academic Structure Tables > CIS Subplan Table > CIS Subplan Table	CIS: Define the CIS subplan table.

Defining the CIS Program Table

Access the CIS Program Table page (**Records and Enrollment > Government Reporting Canada > Academic Structure Tables > CIS Program Table > CIS Program Table**).

<i>Field or Control</i>	<i>Description</i>
CIS Program ID	Enter the nine-digit CIS program ID. This is a unique and permanent identifier for the specified institution and program.
Major Field 1	Enter the description of the major field of study.

Defining the CIS Plan Table

Access the CIS Plan Table page (**Records and Enrollment > Government Reporting Canada > Academic Structure Tables > CIS Plan Table > CIS Plan Table**).

<i>Field or Control</i>	<i>Description</i>
CIS Program ID	Enter the nine-digit CIS program ID. This is a unique and permanent identifier for the specified institution, program and plan.

<i>Field or Control</i>	<i>Description</i>
Major Field 1	Enter the description of the major field of study.

Defining the CIS Subplan Table

Access the CIS Subplan Table page (**Records and Enrollment > Government Reporting Canada > Academic Structure Tables > CIS Subplan Table > CIS Subplan Table**).

<i>Field or Control</i>	<i>Description</i>
CIS Program ID	Enter the nine-digit CIS Program ID. This is a unique and permanent identifier for the specified institution, program, plan, and subplan.
Major Field 2	Enter the description of the minor field of study.

Defining PSIS Course Data

To set up PSIS course data, use the PSIS Course Data component (CAN_RPT_CRSE).

This section discusses how to define PSIS course data.

Page Used to Define PSIS Course Data

<i>Page Name</i>	<i>Definition Name</i>	<i>Navigation</i>	<i>Usage</i>
PSIS Course Data	CAN_RPT_CRSE	Records and Enrollment > Government Reporting Canada > Academic Structure Tables > PSIS Course Data > PSIS Course Data	PSIS: Define PSIS course data.

Defining PSIS Course Data

Access the PSIS Course Data page (**Records and Enrollment > Government Reporting Canada > Academic Structure Tables > PSIS Course Data > PSIS Course Data**).

<i>Field or Control</i>	<i>Description</i>
Delivered Under Contract	Indicate whether the course is created and delivered under contract by the institution to an outside party. Values are <i>N/A</i> , <i>No</i> , <i>Unknown</i> , and <i>Yes</i> .
Brokered Course	Indicate whether the course is brokered.
Retraining/Skills Upgrade	Indicate whether the course is for workplace retraining or skills upgrade.
Cost Recovery	Indicate whether this is a cost recovery course.
Province	Enter the province that corresponds to the province course funding code. This field controls the view of the CAN_PROV_FNDCRS record.
Prov Fund Cd (province funding code)	Enter the provincial code that indicates the course funding code.

Mapping Canadian School Codes to External Organizations

To set up Canadian school code mapping, use the External School Table component (CAN_GOV_SCHOOL).

This section discusses how to map Canadian school codes to external organizations.

Page Used to Map Canadian School Codes to External Organizations

<i>Page Name</i>	<i>Definition Name</i>	<i>Navigation</i>	<i>Usage</i>
Canadian External School	CAN_EXT_SCHOOL	Records and Enrollment > Government Reporting Canada > Definitions > External School Table > Canadian External School	CIS, PSIS: Map Canadian school codes to external organizations. In add mode, specify an External Org ID and Report Type.

Mapping Canadian School Codes to External Organizations

Access the Canadian External School page (**Records and Enrollment > Government Reporting Canada > Definitions > External School Table > Canadian External School**).

<i>Field or Control</i>	<i>Description</i>
Institution Code	Enter the institution code to which you want to map the external organization ID and school type.

Defining PSIS Student Data

This section discusses how to:

- Define PSIS previous education external data.
- Define PSIS student program data.
- Define PSIS student enrollment data.

Related Links

“Adding or Updating Biographical Details Data” (Campus Community Fundamentals)

“Entering External Courses and Degrees ” (Recruiting and Admissions)

“(CAN) Entering Regional Data” (Recruiting and Admissions)

Pages Used to Define PSIS Data for Students

<i>Page Name</i>	<i>Definition Name</i>	<i>Navigation</i>	<i>Usage</i>
Regional	SCC_BIO_DEMO_REG	Campus Community > Personal Information > Add/Update a Person > Regional	PSIS: Define Canadian Bio/Demo data.
Courses and Degrees	SAD_EXT_EDUCATION2	Student Recruiting > Maintain Prospects > Academic Information > Education > Courses and Degrees	PSIS: Define transfer credit data.
Regional	SAD_EXT_EDUC_REG	Records and Enrollment > Transfer Credit Evaluation > External Education > Regional	PSIS: Specify previous educational activities and postsecondary credential information.
Cdn Student Program (Canadian student program)	CAN_RPT_STD_ENR	Records and Enrollment > Career and Program Information > Student Program/Plan > Cdn Student Program	PSIS: Define student program data.

<i>Page Name</i>	<i>Definition Name</i>	<i>Navigation</i>	<i>Usage</i>
Cdn Student Enrollment (Canadian student enrollment)	CAN_RPT_STDNT_CRSE	Records and Enrollment > Enroll Students > Enrollment > Cdn Student Enrollment	PSIS: Define student enrollment data.

Defining PSIS Student Program Data

Access the Cdn Student Program page (**Records and Enrollment > Career and Program Information > Student Program/Plan > Cdn Student Program**).

This example illustrates the fields and controls on the Cdn Student Program page. You can find definitions for the fields and controls later on this page.

<i>Field or Control</i>	<i>Description</i>
Cost Recovery Prog (cost recovery program)	Indicate whether the student is taking the program on a cost recovery basis.
Brokered Program	Indicate whether the student is taking the program under a brokering agreement or study agreement whereby the institution that owns the program contracts the delivery of all or part of the program to a host institution.
Co-op Program	Indicate whether the student is classified as a co-op student in this program.
Collaborative Program	Indicate whether the student is taking the program under a collaborative agreement, whereby two or more institutions share ownership or responsibility for the program and each delivers parts of the program.

Field or Control	Description
Articulated Program	Indicate whether, on completion of the credits for the program, the student is entitled to advanced standing in a target program in another institution with which the reporting institution has an articulated transfer agreement.
Comp. Opt. Paid OJT (completed optional paid on the job training)	Indicate whether the student has completed the optional paid OJT requirements for the program.
Comp. Man. Paid OJT (completed mandatory paid on the job training)	Indicate whether the student has completed the mandatory paid OJT requirements for the program.
Comp. Opt. Unpaid OJT (completed optional unpaid on the job training)	Indicate whether the student has completed the optional unpaid OJT requirements for the program.
Comp. Man. Unpaid OJT (completed mandatory unpaid on the job training)	Indicate whether the student has completed the mandatory unpaid OJT requirements for the program.
Met Norm Entrance Reqmt (met normal entrance requirement)	Indicate whether the student met the normal entrance requirements of the program.
Special Initiative Code	Indicate the special initiative code associated with the student in the program as specified by the provincial ministry, institution, or other agency. This field prompts against the CAN_PROV_SP_INT record.

Defining PSIS Student Enrollment Data

Access the Cdn Student Enrollment page (**Records and Enrollment > Enroll Students > Enrollment > Cdn Student Enrollment**).

This example illustrates the fields and controls on the Cdn Student Enrollment page. You can find definitions for the fields and controls later on this page.

The screenshot shows the 'Cdn Student Enrollment' page for Kimberly Adams. The student's term is 2003 Fall, career is Undergrad, and institution is PeopleSoft University. The page includes fields for Class Nbr, Subject, Catalog Nbr, Class Section, Academic Group, and Session. It also features dropdown menus for Cost Recovery Course (set to 'Unknown') and Brokered Course (set to 'Yes-Host'). A 'Delivery to Student' section contains dropdown menus for Dist. Ed., Internet, Video Conf., Class, Correspondence, Audio Conf., TV, Radio, and Other.

Field or Control	Description
Cost Recovery Course	Indicate whether the student took the course on a cost recovery basis. The system populates this field by default to the CAN_RPT_CRSE record.
Brokered Course	Indicate whether the student is taking the course under a brokering agreement, whereby the institution that owns the course contracts the delivery of the course to a host institution. The system populates this field by default to the CAN_RPT_CRSE record.
Dist. Ed. (distance education)	Indicate whether the student's course section or class is considered by the institution to be a distance education course. Mapping needs to be completed at this level only if the student received instruction for the course in a manner different from the course delivery mode.
Class	Indicate whether the student received instruction in this course in whole or in part by classroom instruction (including labs), in which the instructor was physically located in the same room or lecture hall as the student. Mapping needs to be completed at this level only if the student received instruction for the course in a manner different from the course delivery mode.
TV (television)	Indicate whether the student received instruction in this course in whole or in part by television. Mapping needs to be completed at this level only if the student received instruction for the course in a manner different from the course delivery mode.

Field or Control	Description
Internet	Indicate whether the student received instruction in this course in whole or in part on the internet, including email and internet conferencing. Mapping needs to be completed at this level only if the student received instruction for the course in a manner different from the course delivery mode.
Correspondence	Indicate whether the student received instruction in this course in whole or in part by postal correspondence, including tapes and CDs sent by mail. Mapping needs to be completed at this level only if the student received instruction for the course in a manner different from the course delivery mode.
Radio	Indicate whether the student received instruction in this course in whole or in part by radio. Mapping needs to be completed at this level only if the student received instruction for the course in a manner different from the course delivery mode.
Video Conf. (video conference)	Indicate whether the student received instruction in this course in whole or in part by video conferencing, excluding conferencing on the internet. Mapping needs to be completed at this level only if the student received instruction for the course in a manner different from the course delivery mode.
Audio Conf. (audio conference)	Indicate whether the student received instruction in this course in whole or in part by audio conferencing. Mapping needs to be completed at this level only if the student received instruction for the course in a manner different from the course delivery mode.
Other	Indicate whether the student received instruction in this course in whole or in part by some other method of instruction. Mapping needs to be completed at this level only if the student received instruction for the course in a manner different from the course delivery mode.

Loading the Student ID Table

This section discusses how to load the student data.

Page Used to Load the Student ID Table

Page Name	Definition Name	Navigation	Usage
Student List	CAN_STDNT_LST	Records and Enrollment > Government Reporting Canada > Suspense Tables > Student List > Student List	All: Load student data to prepare for the extract process.

Loading Student Data

Access the Student List page (**Records and Enrollment > Government Reporting Canada > Suspense Tables > Student List > Student List**).

This example illustrates the fields and controls on the Student List page. You can find definitions for the fields and controls later on this page.

Student List

Institution: PSUNV PeopleSoft University

Report Type: PSIS Postsecondary Student Info Sys

Report Period: 200910 PSIS Test Report **Freeze Date:**

Student ID: SRCR0009 Ruth Williams

Find | View All First 1 of 1 Last

*Acad Career: Undergraduate Select

*Acad Prog: Liberal Arts Undergraduate

*Acad Plan: Psychology

Find First 1-12 of 12 Last

*Field Name: Field Value:

*Field Name: Field Value:

*Field Name: Field Value:

*Field Name: Field Value:

*Field Name: Field Value:

*Field Name: Field Value:

Each institution's business practices and interpretation of the published government rules result in different criteria for selecting students for reporting. To initiate the reporting process, you must populate (either manually or through a user-defined process) the PeopleSoft provided Student List component with the eligible students you want to report. The Student List component contains the fields listed below. You

must populate each field for *every* row in this component; otherwise the reports extract process excludes the row and the process may fail.

Field or Control	Description
Institution	Enter the institution for which you want to report.
Report Type	Enter the report type you want to use.
Report Period	Enter the report period.
Student ID	Enter the student ID for the student you want to report.
Acad Career (academic career)	Enter the academic career you want to report for the student. You can insert an additional row to report multiple careers, programs, or plans.
Acad Program (academic program)	Enter the academic program you want to report for the student.
Acad Plan (academic plan)	Enter the academic plan you want to report for the student.
Select	Select this check box to identify a subset of students for whom you want to run the extract and flat file process. The extract process adds or replaces reporting data for these students. The system clears this check box after you run the extract process for this report. At runtime, you can specify to run the process for only those students who have the Select option selected.
Field Name	Enter a row for each field name that you need for this report. For example, STDNT_CAR_NBR. This is the key data referred to in the following Loading the Student Key Data subtopic.
Field Value	Enter a field value that corresponds to each field name value. The report extract process uses this data. For example, 0.

The system calculates elements for each row of the table. There is a one to one relationship between a row on the Student List page and a row on any one of the tables that enable you to view the information calculated by the extract program. If a student has more than one row on the Student List page, the system treats each row as if it is for a new student when retrieving the element values for the row.

Loading the Student Key Data

In addition to entering data in all of the header fields, different government reports require that you also enter various types of key data. Use the following table to determine which fields and corresponding field values you must populate before you run the extract process:

Field Name	Required by Report Type
ACAD_CAREER	ALL
ACAD_PROG	ALL
ACAD_PLAN	ALL
ACAD_SUB_PLAN	CIS
ADM_APPL_NBR	OUAC
AID_YEAR	CIS, PSIS
APPL_PROG_NBR	OUAC
EFFECTIVE_TERM	CIS, PSIS, MET, USISE
EFFSEQ	OUAC
SESSION_CODE	CIS, MET, OUAC, USISE
STDNT_CAR_NBR	ALL
STRM	ALL

Note: Enter the latest STRM value for the student for the applicable report type and report period. For example, if the report includes terms for Spring 99 and Fall 99, enter the term representing Fall 99 as the STRM value, assuming that the student was enrolled in both terms.

(NZL) Setting Up Government Reporting

Understanding New Zealand Government Reporting

This section discusses:

- SDR reporting.
- NZQA reporting.
- NZVCC reporting.

SDR Reporting

The SDR is a set of data elements that tertiary institutions in New Zealand must provide to the New Zealand Ministry of Education (MoE). The SDR includes all information that is required by the MoE for funding students and for statistical reporting.

The SDR business process flows like this:

1. You use the Campus Solutions system to enter and store the SDR data on students, courses, and course enrollments.
2. You use the SDR Extract component to extract the necessary data that is required by the MoE into five separate text files: student, course enrollment, web-based system register, qualifications, and course completion.
3. The MoE provides institutions with a program that validates the text files that you produced through the SDR Extract component.
4. After you send the validated text files to the MoE, the MoE processes the files and calculates the appropriate level of funding based on the files that your institution provides them.

A key part of the SDR reporting process is the reporting of data that is required by the EFTS (Equivalent Full Time Student) Funding System, through which the MoE provides funding grants for tertiary education providers. The funding, or bulk grant, that an institution receives is determined by a funding formula based on an EFTS unit, whereby 1.0 EFTS unit is defined as the student workload that would normally be carried by a full-time student in a single academic year.

To comply with the EFTS system requirements, institutions must assign an EFTS factor to all eligible courses. This factor identifies the proportion of a normal full-time year's study that the course is deemed to represent. The EFTS factor also depends on the type of course according to ministry guidelines. When students enroll in courses, they generate EFTS units that are equivalent to the factor that is defined for the course. These units, usually based on course characteristics, program characteristics, or both must also be coded using the New Zealand Standard Classification of Education for SDR reporting purposes.

NZQA Reporting

The NZQA is a government body that is responsible for the coordination of national examinations and the National Qualification Framework (NQF). Qualifications are registered at 10 levels, from year 11 of schooling or vocational entry to postgraduate. Educational institutions, primarily polytechnic colleges, need to equate their study offerings to the NQF unit standards. Progression in these unit standards must be recorded and institutions must award students grades not only in their course offerings, but also in these unit standards.

You set up unit standards in your system as milestones. Milestones are then linked to the courses that are offered by your institution. You can link more than one unit standard to a course or one unit standard to many courses. As students enroll in the courses that are linked to the milestones, they are simultaneously enrolled in the unit standard through the enrollment engine.

After enrollments are processed, you can run three different reports to send to the NZQA:

- **Hook-on Request report:** This report provides a listing of all students who have not previously been registered with NQF and have paid the hook-on fee.
- **Unit Standard Results report:** This report includes Unit Standard results (complete or not completed) for students who have paid the per credit fees.
- **NZ Diploma in Business Results report:** This report provides paid NZQA exam results for the NZ Diploma in Business and for advanced vocational awards.

NZVCC Reporting

The NZVCC was established by the Universities Act (1961), which replaced the Federal University of New Zealand with separate institutions. Today, the committee represents the interests of New Zealand's seven institutions: Auckland, Waikato, Massey, Victoria, Canterbury, Lincoln, and Otago.

The NZVCC requests the above seven institutions to provide a data file on destinations of those persons who became eligible to graduate from the New Zealand University system. This information is produced at the end of the year (31 December) or year-end for the institution and is used by the NZVCC in creating a University Graduate Destinations Survey. The University Graduate Destinations Survey includes names and details of all students who completed a qualification in the specified year at the institution. When a student has completed a degree, your institution manually inserts a row in the Student Degrees component.

Ethnicity information is included in the University Graduate Destinations Survey report. Ethnicity codes should already be set up and mapped in your system because this is required for the SDR report.

Before you can generate the University Graduate Destinations Survey report file, you must also enter a valid address type for a student's address and residency data. Valid address types are listed in the **Addresses** group box on the Campus Community Installation - Names/Addresses page.

Prerequisites

In addition to the setup that is described in these topics, your institution must also set up the following tables for New Zealand functionality:

- Academic Institution 6 page.
- Institution Table New Zealand page.

- Academic Prog (NZL) (academic program [New Zealand]) page.
- Acad Plan (NZL) (academic plan [New Zealand]) page.
- Degree Table page.
- Complete Grade Flag page.
- Grade Scheme Table page.
- Ethnicity NZL page.
- Ethnicity Map NZL page.

See “(AUS, CAN, GBR, NZL, NLD) Activating Other Student Administration Features” (Campus Solutions Application Fundamentals).

See “(NZL) Setting Up New Zealand Academic Programs” (Campus Solutions Application Fundamentals).

See “(NZL) Setting Up New Zealand Academic Plans” (Campus Solutions Application Fundamentals).

See [Defining Degrees](#).

See [Setting Up Your System for Grading](#).

See “(NZL) Setting Up Statistics New Zealand Ethnic Codes” (Campus Community Fundamentals).

See “(NZL) Mapping Statistics New Zealand Ethnic Codes to PeopleSoft Ethnic Groups” (Campus Community Fundamentals).

Preparing for SDR Reporting

This section discusses how to:

- Define funding categories.
- Define course classifications.
- Define MoE subject codes.
- Set up field of study codes.

Pages Used to Prepare for SDR Reporting

<i>Page Name</i>	<i>Definition Name</i>	<i>Navigation</i>	<i>Usage</i>
Funding Category NZL	SSR_FUND_CAT_NZL	Set Up SACR > Foundation Tables > Reporting Codes > Funding Category NZL > Funding Category NZL	Define funding category codes and their amounts.

Page Name	Definition Name	Navigation	Usage
Course Classification NZL	SSR_CRS_CLSF_FNDC	Set Up SACR > Foundation Tables > Reporting Codes > Course Classification NZL > Course Classification NZL	Define course and program classifications and associate them with funding categories.
MoE Subject NZL	SSR_MOE_SUBJECT	Set Up SACR > Foundation Tables > Reporting Codes > MoE Subject NZL > MoE Subject NZL	Define MoE subject codes.
NZSCED Field of Study	SSR_NZSCED_BRD	Set Up SACR > Product Related > Student Records > Curriculum Management > NZSCED Field of Study NZL > NZSCED Field of Study	Set up the NZSCED (New Zealand Standard Classification of Education) field of study codes by defining the broad, narrow, and detail codes that you attach to courses for use in SDR Course and Course Register files.

Defining Funding Categories

Access the Funding Category NZL page ((Set Up SACR > Foundation Tables > Reporting Codes > Funding Category NZL > Funding Category NZL).

This example illustrates the fields and controls on the Funding Category NZL page. You can find definitions for the fields and controls later on this page.

Funding Category NZL

Funding Category: A2

Find | View All First 1 of 1 Last

*Effective Date: 01/01/1900 *Status: Active

*Description: Arts & Soc Sci - Degree

Funding Amount: \$1,000.00

Field or Control	Description
Funding Category	<p>When setting up your funding categories, enter the two-digit alphanumeric code for the funding category.</p> <p>The first digit is the academic category (A-Z) and the second digit is the degree status (1-5). The degree status variations are:</p> <ul style="list-style-type: none"> • 1: Non-Degree • 2: Degree • 3: Post Graduate • 4: Research • 5: Foreign Research
Funding Amount	Enter the MoE funding amount for this funding category.

Related Links

“(NZL) Setting Up New Zealand Academic Programs” (Campus Solutions Application Fundamentals)

Defining Course Classifications

Access the Course Classification NZL page (**Set Up SACR > Foundation Tables > Reporting Codes > Course Classification NZL > Course Classification NZL**).

This example illustrates the fields and controls on the Course Classification NZL page. You can find definitions for the fields and controls later on this page.

Course Classification NZL

Course Classification: 02

Find | View All First ◀ 1 of 1 ▶ Last

*Effective Date: <input type="text" value="01/01/1900"/>	*Status: <input type="text" value="Active"/>
*Classification Type: <input type="text" value="Course"/>	
*Description: <input type="text" value="Architecture; Quantity Surveying"/>	
*Long Description: <input type="text" value="Architecture; Quantity Surveying"/>	

Find First ◀ 1-2 of 2 ▶ Last

*Funding Category: <input type="text" value="A1"/> Arts & Soc Sci - Non-Degree	
*Funding Category: <input type="text" value="B1"/> Science & Enginrg - Non-Degree	

Field or Control	Description
Course Classification	When setting up your classification codes, enter the MoE course classification code.
Classification Type	Select <i>Course</i> or <i>Programme</i> .
Funding Category	Enter the funding category for this course classification. You can enter as many funding categories as needed for each classification. <hr/> Note: You must assign at least one funding category to each course classification.

Related Links

“(NZL) Setting Up New Zealand Academic Programs” (Campus Solutions Application Fundamentals)

Defining MoE Subject Codes

Access the MoE Subject NZL page (**Set Up SACR > Foundation Tables > Reporting Codes > MoE Subject NZL > MoE Subject NZL**).

Link these subject codes to your institution's plan offerings on the Academic Plan page.

See “(NZL) Setting Up New Zealand Academic Plans” (Campus Solutions Application Fundamentals).

Setting Up Field of Study Codes

Access the NZSCED Field of Study page (**Set Up SACR > Product Related > Student Records > Curriculum Management > NZSCED Field of Study NZL > NZSCED Field of Study**).

Important! The NZSCED broad, narrow, and detail codes are defined by the MoE.

This example illustrates the fields and controls on the NZSCED Field of Study page. You can find definitions for the fields and controls later on this page.

NZSCED Field of Study

NZSCED Broad Code: 01

NZSCED Broad Code Find | View All First 1 of 1 Last

*Effective Date: 01/01/1900 31 Status: Active ▼

*Description: Natural and Physical Sciences

NZSCED Narrow Code Find | View All First 1 of 2 Last

*NZSCED Narrow Code: 01

*Description: Mathematical Sciences

		Customize Find			First 1-2 of 2 Last
	*Detail Code	*Description	Full Code		
1	01	Mathematical Sciences	010101	+	-
2	03	Statistics	010103	+	-

<i>Field or Control</i>	<i>Description</i>
NZSCED Broad Code	When setting up the field of study codes, enter the NZSCED broad code for this field of study.
NZSCED Narrow Code	Enter the NZSCED narrow codes for the broad code. Insert rows to enter all of the narrow codes for this broad code.
Detail Code	Enter the NZSCED detail codes for the narrow code. Insert rows in the grid to enter all of the detail codes for this narrow code.

Note: You attach the combination of broad, narrow, and detail code to a course at the catalog level. For example, the code 010103 is the NZSCED code for Statistics.

Related Links

[\(NZL\) Setting Up Government Reporting Data](#)

Preparing for NZQA Reporting

The NZQA (New Zealand Qualifications Authority) framework consists of fields, subfields, and domains. The codes identify a particular unit standard within the overall framework. You associate milestones with a unit standard using these codes.

This section discusses how to:

- Define NQF fields, subfields, and domains.
- Define unit standards.
- Link NQF codes to milestones.

Pages Used to Prepare for NZQA Reporting

<i>Page Name</i>	<i>Definition Name</i>	<i>Navigation</i>	<i>Usage</i>
NQF Field/Subfield Domain	SSR_NQF_FIELD	Set Up SACR > Product Related > Student Records > Curriculum Management > NQF Field/Subfield Domain NZL > NQF Field/Subfield Domain	Set up NZQA defined field codes, subfields, and domains in the system.
Milestone Table	MILESTONE_TBL	Set Up SACR > Product Related > Student Records > Enrollment > Milestone Table > Milestone Table	Define NQF unit standards as milestones using the milestone type of <i>U</i> and link NQF codes to milestones.

Defining NQF Fields, Subfields, and Domains

Access the NQF Field/Subfield Domain page (**Set Up SACR > Product Related > Student Records > Curriculum Management > NQF Field/Subfield Domain NZL > NQF Field/Subfield Domain**).

This example illustrates the fields and controls on the NQF Field/Subfield Domain page. You can find definitions for the fields and controls later on this page.

NQF Field/Subfield Domain

Field Code: BUS

Find | View All First ◀ 1 of 1 ▶ Last

***Effective Date:** 01/01/1900 31 ***Status:** Active + -

***Description:**

Find | View All First ◀ 1 of 2 ▶ Last

***Subfield Code:** + -

***Description:**

Customize | Find | View All First ◀ 1-2 of 2 ▶ Last

	*Domain Code	*Description		
1	<input type="text" value="ACG"/>	<input type="text" value="Accounting - Generic"/>	+	-
2	<input type="text" value="ACM"/>	<input type="text" value="Accounting - Mid-Level"/>	+	-

Field or Control	Description
Field Code	When setting up a new field, enter an NZQA defined field code.
Subfield Code	Enter an NZQA-defined subfield code. You can enter as many subfield codes as needed for this field.
Domain Code	Enter an NZQA-defined domain code. You can enter as many domain codes as needed for each subfield.

Defining Unit Standards

Access the Milestone Table page (**Set Up SACR > Product Related > Student Records > Enrollment > Milestone Table > Milestone Table**).

In the NQF Detail group box, enter the milestone type *U* (unit standard).

See [Defining Milestone Codes](#).

Linking NQF Codes to Milestones

Access the Milestone Table page (**Set Up SACR > Product Related > Student Records > Enrollment > Milestone Table > Milestone Table**).

NQF Detail

<i>Field or Control</i>	<i>Description</i>
Unit Standard Version	Enter the version as defined by the NZQA for this unit standard.
Unit Standard Field Code	Select the appropriate field code. Only the field codes that are entered on the Field/Subfield Domain page are available for selection.
Unit Standard Subfield Code	Select the appropriate subfield code. Only the subfield codes that are entered on the Field/Subfield Domain page are available for selection.
Unit Standard Domain Code	Select the appropriate domain code. Only the domain codes that are entered on the Field/Subfield Domain page are available for selection.
Unit Standard Language	Select the language in which the unit standard is taught.
NQF Credit	Enter the number of NQF credits for this unit standard as provided in the National Qualifications Framework.

Related Links

[\(NZL\) Setting Up Government Reporting Data](#)

Preparing for NZVCC Reporting

Enter subject and qualification codes defined by the NZVCC (New Zealand Vice Chancellors Committee) into your Campus Solutions system, and then link the subject codes to your academic plans and the qualification codes to degree codes.

This section discusses how to:

- Enter NZVCC subject codes.

- Enter NZVCC qualification codes.

Pages Used to Prepare for NZVCC Reporting

<i>Page Name</i>	<i>Definition Name</i>	<i>Navigation</i>	<i>Usage</i>
NZVCC Subject Codes NZL	SSR_NZVCC_SUBJECT	Set Up SACR > Foundation Tables > Reporting Codes > NZVCC Subject Codes NZL > NZVCC Subject Codes NZL	Define NZVCC Subject codes to attach to academic plans.
NZVCC Qualification Codes NZL	SSR_NZVCC_DEGREE	Set Up SACR > Foundation Tables > Reporting Codes > NZVCC Qualification Codes NZL > NZVCC Qualification Codes NZL	Define NZVCC qualification codes to attach to degrees.

Entering NZVCC Subject Codes

Access the NZVCC Subject Codes NZL page (**Set Up SACR > Foundation Tables > Reporting Codes > NZVCC Subject Codes NZL > NZVCC Subject Codes NZL**).

Enter the subject codes that are provided by the NZVCC. After you have set up all of the codes, you can link the codes to an academic plan on the Acad Plan NZL (academic plan New Zealand) page.

See “(NZL) Setting Up New Zealand Academic Plans” (Campus Solutions Application Fundamentals).

Entering NZVCC Qualification Codes

Access the NZVCC Qualification Codes NZL page (**Set Up SACR > Foundation Tables > Reporting Codes > NZVCC Qualification Codes NZL > NZVCC Qualification Codes NZL**).

Enter the qualification codes that are provided by the NZVCC. After you have set up all of the codes, you can link the codes to a degree on the Degree Table page.

See [Defining Degrees](#).

Chapter 22

(NLD) Managing the BRON-HO Interface

Understanding BRON-HO

Documentation for setting up and managing BRON-HO is not available in Online Help. For BRON-HO documentation, see PeopleSoft Campus Solutions Selected PeopleBook Chapters for the Netherlands (NLD) in My Oracle Support (Doc ID 2052493.1).

The documentation in My Oracle Support includes these topics:

- Setting up BRON-HO
- Managing BRON-HO student data
- Sending and receiving BRON-HO messages
- Reviewing BRON-HO transactions
- Managing approval and suspense processing

(NLD) Setting Up Test Administration

Understanding Test Administration Setup

The Test Administration functionality enables institutions to create a catalog of tests, similar to the course catalog. The test catalog consists of tests and calculated results. Calculated results either are the end result of a test or can be used to calculate the average result of multiple tests. Tests can be repeated and the repeat rules that are set for a calculated result tell the system which result to use for calculation. The calculation results can be run by individual student, by program, or by student group.

Common Elements Used to Set Up Test Administration

<i>Field or Control</i>	<i>Description</i>
Academic Career	<p>Enter the appropriate academic career for the test or calculated result offering, test list, or requisite.</p> <p>Define careers on the Academic Career Table.</p> <p>See “Defining Academic Careers” (Campus Solutions Application Fundamentals).</p>
Academic Institution	<p>Enter the appropriate academic institution for the test or calculated result offering, test tree, test list, or requisite.</p> <p>Define institutions on the Academic Institution Table.</p> <p>See “Defining Academic Institutions” (Campus Solutions Application Fundamentals).</p>
Academic Organization	<p>The system populates this field from the academic organization that is linked to the subject entered in the Subject Area field. You can override the value.</p> <p>See “Defining Academic Organizations” (Campus Solutions Application Fundamentals).</p>
Subject Area	<p>Enter the subject area of the test or calculated result offering, test list, or requisite. Subject area values are defined on the Academic Subject Table page.</p> <p>See “Defining Subject Areas” (Campus Solutions Application Fundamentals).</p>

Activating Test Administration

Using Test Administration is optional. Activate the functionality on the Installation table.

Page Used to Activate Test Administration

<i>Page Name</i>	<i>Definition Name</i>	<i>Navigation</i>	<i>Usage</i>
SA Features	SCC_INSTALL_SA2	Set Up SACR > Install > Student Admin Installation > SA Features	Activate the Test Administration functionality and enter the last test ID numbers used.

Activating Test Administration

Access the SA Features page (**Set Up SACR > Install > Student Admin Installation > SA Features**).

<i>Field or Control</i>	<i>Description</i>
Test Administration	Select to activate the Test Administration functionality.
Last Test ID Assigned, Last Test List ID Assigned, and Last Requirement ID Assigned	<p>These fields are visible only when the Test Administration check box is selected.</p> <p>When you activate Test Administration, enter the number prior to the number with which you want to begin the ID counting for these fields. For example, if you enter 99 in each of these fields, the system begins assigning the ID for each at 100.</p> <p>After activation, these fields display the last test, test list, and requirement ID numbers that are assigned by the system.</p> <hr/> <p>Note: If you leave these fields blank, the system begins counting for each of these IDs with 1.</p>

Related Links

“Selecting Student Administration Installation Options” (Campus Solutions Application Fundamentals)

Defining Tests and Calculated Results in the Catalog

In the test catalog, define all of the tests to be used in test programs. Also define calculated results, which link tests and other calculated results together with calculation rules for the system to use to calculate final test grades for students.

Calculated results can also be linked to the course catalog so that completed grades can be written to the student enrollment record.

This section discusses how to:

- Define tests.
- Define test offerings.
- Define a test set for calculated results.
- Link a course to the test.

Pages Used to Define Tests and Calculated Results in the Catalog

Page Name	Definition Name	Navigation	Usage
Test Catalog	SSR_TST_CAT_NLD	Records and Enrollment > Test Administration NLD > Set Up Test Administration > Test Catalog > Test Catalog	Create, view, or update tests or calculated results.
Test Catalog - Offering	SSR_TST_CAT_OF_NLD	Records and Enrollment > Test Administration NLD > Set Up Test Administration > Test Catalog > Offering	Define the academic institution, group, catalog number, career, and subject for the test or calculated result.
Test Catalog - Test Set	SSR_TST_CAL_NLD	Records and Enrollment > Test Administration NLD > Set Up Test Administration > Test Catalog > Test Set	This page appears when <i>Calculated Result</i> is entered in the Test Type field on the Test Catalog page. Link the calculated result to tests and other calculated results from which the grade is calculated, and enter information about the calculated result.
Course Link	SSR_TST_CRS_NLD	Records and Enrollment > Test Administration NLD > Set Up Test Administration > Test Catalog > Course Link	This page appears when <i>Calculated Result</i> is entered in the Test Type field on the Test Catalog page. Link the calculated result to a course.

Defining Tests

Access the Test Catalog page (**Records and Enrollment > Test Administration NLD > Set Up Test Administration > Test Catalog > Test Catalog**).

This example illustrates the fields and controls on the Test Catalog page. You can find definitions for the fields and controls later on this page.

Test Catalog	Offering	Test Set	Course Link
Test ID:	00000088		
Find View All First 1 of 1 Last			
*Effective Date:	01-08-2003	*Status:	Active
Test Type:	Calculated Result		
Exam Type:	Combination Grade		
*Description:	Combination Grade Havo Vavo		
Long Title:	Combination Grade Havo Vavo		
Grading Basis:	TSC		
Units 1:	<input type="text"/>		
Units 2:	<input type="text"/>		
Test Level:	A level		
*Grade Valid:	Years After Term End		
Years Valid:	10		

Field or Control	Description
Test Type	<p>When entering a new value in the catalog, select whether you are creating a <i>Test</i> or a <i>Calculated Result</i>.</p> <p>When you save the test or calculated result, this field becomes view only.</p>
Exam Type	<p>Select the exam type for this calculated result. Values are <i>Central End Exam</i>, <i>Combination Grade</i>, <i>End Exam</i>, <i>Partial Qualification</i>, <i>Qualification</i>, and <i>School Exam</i>.</p> <p>The exam type affects Test Administration grade calculation processing.</p> <p>If you select an Exam Type of <i>Combination Grade</i> for a calculated result, the grade calculation process looks for underlying student results where the Combination Grade check box on the Student VAVO Course Details page is selected. If the Combination Grade check box is selected, the underlying grade counts towards the overall Combination Grade. If the check box is cleared, the underlying result is managed in a way similar to a course exemption—the underlying results are exempted and the Student Grade table results Grade Attribute field is updated with the grade attribute <i>Exempt Combination Grade</i>.</p> <p>See Maintaining VAVO Course Options.</p>
Grading Basis	<p>Select the grading basis to be used with this test or calculated result.</p>

Field or Control	Description
Units 1 and Units 2	Enter the number of credited units the student gets after completing the test or calculated result. These fields are used in the evaluation process based on how each individual institution needs to use them.
Test Level	Select the level of difficulty of the test or calculated result. Values are <i>A level, B level, C level, and D level</i> . These levels are used for reporting purposes only and are not part of the calculation process.
Grade Valid	Select the period for which the grade is valid. Values are <i>Unlimited and Years After Term End</i> . If you select <i>Years After Term End</i> , the Years Valid field appears.
Years Valid	Enter the number of years that the grade assigned to a student for this test or calculated result is valid. This field appears if you select <i>Years After Term End</i> in the Grade Valid field.

Defining Test Offerings

Access the Test Catalog - Offering page (**Records and Enrollment > Test Administration NLD > Set Up Test Administration > Test Catalog > Offering**).

This example illustrates the fields and controls on the Test Catalog - Offering page. You can find definitions for the fields and controls later on this page.

Test Catalog
Offering
Test Set
Course Link

Test ID: 00000008

Find | View All
First
1 of 1
Last

Effective Date: 01/01/1900 **Status:** Active

Description: CAL02.1.3 Sports

***Academic Institution:** PSNLD PeopleSoft University - NLD ***Catalog Nbr:** 4330CAL021

***Academic Group:** 00001 Standard

***Subject Area:** ECONO Economics

***Academic Organization:** ECONOMCS Economics

***Academic Career:** BOL Vocational Training (NLD)

***Approved**

HEGIS Code:

Long Description: SP

Field or Control	Description
Catalog Nbr (catalog number)	<p>Enter the catalog number for this test or calculated result.</p> <p>This field is 10 digits. The system reserves the 4 left digits exclusively for numeric characters, and the right 6 digits for both alpha and numeric characters. A field edit enforces this programming.</p> <p>See Defining Course Offerings.</p>
Academic Group	<p>Enter the academic group to which this test or calculated result offering belongs. Academic group values are defined on the Academic Group Table page.</p> <p>See “Defining Academic Groups” (Campus Solutions Application Fundamentals).</p>
HEGIS Code	Enter the CREBO code that is associated with the test.
Approved	<p>Select the test or calculated result approved status. Values for this field are delivered with the system as translate values.</p> <p>Do not modify these values in any way. Any modifications to these values require a substantial programming effort. Select <i>Pending</i> or <i>Denied</i> to prevent anyone from scheduling the test or calculated result. Select <i>Approved</i> to enable scheduling of the test or calculated result offering.</p>
Long Description	Enter a long description of the test.

Defining a Test Set for Calculated Results

Access the Test Catalog - Test Set page (**Records and Enrollment > Test Administration NLD > Set Up Test Administration > Test Catalog > Test Set**).

This example illustrates the fields and controls on the Test Catalog - Test Set page. You can find definitions for the fields and controls later on this page.

Test Catalog	Offering	Test Set	Course Link						
Test ID:	00000008								
Find View All First ◀ 1 of 1 ▶ Last									
Effective Date:	01/01/1900	Status:	Active						
Description:	CAL02.1.3 Sports								
*Representation:	Truncate ▼								
*Decimals:	1 ▼								
*Handle Insufficient Grades:	Exclude from Calculation ▼								
<input type="checkbox"/> Use Only Grades within Term <input type="checkbox"/> Sum Grades									
Customize Find View All First ◀ 1-3 of 3 ▶ Last									
*Seq Nbr	Weight	*Child Test ID	Description	Test Type	Operators	Minimum Value	Repeat		
10	03	00000003	CAL02.1.3.3 Sports	Test	= ▼	89.00	Highest ▼	+	-
20	01	00000006	CAL02.1.3.2 Sports	Test	▼		Highest ▼	+	-
30	01	00000007	CAL02.1.3.1 Sports	Test	▼		Highest ▼	+	-

Field or Control	Description
Representation	Select whether to <i>Round</i> or <i>Truncate</i> the calculated result.
Decimals	Select the number of decimals to which the calculated result must be rounded or truncated. Values are 0, 1, and 2.
Handle Insufficient Grades	<p>Indicate how you want the calculation process to handle empty grades and grades that do not meet the minimal value. Values are:</p> <p><i>Conditional:</i> Only grades that satisfy the minimum value are used in the calculation process.</p> <p><i>Do Not Calculate:</i> If grades exist that do not meet the minimum value or if required grades do not exist, the result is not calculated.</p> <p><i>Exclude from Calculation:</i> If no grade exists, the grade is not used in the calculation process. If the grade is below the minimum value, the grade is used in the calculation process.</p> <p><i>Include in Calculation:</i> If no grade exists, the minimal value from the corresponding grade table is used in the calculation process.</p> <p>For all values except <i>Do Not Calculate</i>, if all requirements are met and all required grades exist, the grade is calculated with the status Complete, otherwise, with the status Incomplete.</p>

Field or Control	Description
Use Only Grades within Term	Select if only the tests taken within the same term will be included in the result.
Sum Grades	Select if the calculated result of all underlying tests will be a sum of the tests instead of an average. <hr/> Note: The calculation process calculates an average of all test grades if this check box is cleared. <hr/>
Seq Nbr (sequence number)	When you add a new row, the system increments this field by 10; however, you can change the value to any number to change the order of the rows.
Weight	Enter the weight of the test compared to the other tests in the grid.
Child Test ID	Enter the test ID or other calculated result ID that you want in the test set of the calculated result.
Operators	Select an operator to determine the minimum grade that a student must earn in a test for it to be used in the calculation process. Values are = (equal to), > (greater than), and >= (greater than or equal to).
Minimum Value	Enter the minimum grade that a student must earn in a test for it to be used in the calculation process.
Repeat	Indicate which test result must be considered if a student has repeated the test. Values are <i>Average</i> , <i>Highest</i> , and <i>Latest</i> .

Linking a Course to the Test

Access the Test Catalog - Course Link page (**Records and Enrollment > Test Administration NLD > Set Up Test Administration > Test Catalog > Course Link**).

Field or Control	Description
Course ID	Enter the course ID, from the Course Catalog, of the course to which this test or calculated result will be linked.
Course Offering Nbr (course offering number)	Enter the course offering number to which this test or calculated result will be linked.

Create/Update Student Enroll

<i>Field or Control</i>	<i>Description</i>
Create	Select to have the calculation process create a new row on the Student Enroll table.
Update Existing Only	Select to have the calculation process update the existing row on the Student Enrollment table.

Creating Test Trees in Tree Manager

The Create Test Tree process creates test trees based on the information that you enter in the Test Catalog. The system then uses the structure of a test tree to calculate test grades for students.

This section discusses how to:

- Create a test tree.
- Validate test trees.

See the product documentation for *PeopleTools: PeopleSoft Tree Manager*

Pages Used to Create Test Trees

<i>Page Name</i>	<i>Definition Name</i>	<i>Navigation</i>	<i>Usage</i>
Create Test Tree	SSR_CRE_TRE_NLD	Records and Enrollment > Test Administration NLD > Set Up Test Administration > Create Test Tree > Create Test Tree	Run the Create Test Tree SQR process (SRCRTRNL) to create a test tree. Note: Create and update test trees using only this process. Do not create new test trees or add nodes to existing test trees through Tree Manager.
Validate Test Tree	SSR_VALID_TRE_NLD	Records and Enrollment > Test Administration NLD > Set Up Test Administration > Validate Test Tree > Validate Test Tree	Run the Test Tree Validation SQR process (SRVALDNL) to validate the test tree. A test tree is valid when the structure of the tree in Tree Manager matches the structure of the tree in the Test Catalog.

<i>Page Name</i>	<i>Definition Name</i>	<i>Navigation</i>	<i>Usage</i>
View Tree Validation Results	SSR_TEST_TREE_NLD	Records and Enrollment > Test Administration NLD > Set Up Test Administration > View Tree Validation Results > View Tree Validation Results	View test tree validation results.

Creating a Test Tree

Access the Create Test Tree page (**Records and Enrollment > Test Administration NLD > Set Up Test Administration > Create Test Tree > Create Test Tree**).

<i>Field or Control</i>	<i>Description</i>
Test ID	Enter the calculated result that will be the root node of the tree. The system creates the tree using the tests and other calculated results that you linked to this calculated result on the Test Set page. Only those test IDs for which a user has access based on academic organization security are available.
Effective Date	Enter the effective date of the test tree. Assigning the test tree an effective date enables the user to record different versions of calculated results.
Tree Structure ID	The test structure TEST_ADMIN is delivered with the product. If you create additional tree structures, they must be set up exactly like the TEST_ADMIN structure.
Tree Name	Enter a name for the test tree.

Validating Test Trees

Access the Validate Test Tree page (**Records and Enrollment > Test Administration NLD > Set Up Test Administration > Validate Test Tree > Validate Test Tree**).

<i>Field or Control</i>	<i>Description</i>
Tree Name	Enter the name of the test tree for the system to validate.
Effective Date of Tree	Enter the effective date of the tree. Test trees can have multiple effective dates to accommodate several versions of the same test tree.

Linking Test Trees to Programs

Link test trees to programs to automate the process of linking students to test trees. When an applicant is matriculated, the system looks at the combination of institution, career, program, campus, load, and term for the individual and automatically links the student to the test tree with the same combination.

Page Used to Link Test Trees to Programs

Page Name	Definition Name	Navigation	Usage
Link Test Tree to Program	SSR_PROG_TREE_NLD	Records and Enrollment > Test Administration NLD > Set Up Test Administration > Link Test Tree to Program > Link Test Tree to Program	Link test trees to academic programs.

Linking the Test Tree to a Program

Access the Link Test Tree to Program page ((**Records and Enrollment > Test Administration NLD > Set Up Test Administration > Link Test Tree to Program > Link Test Tree to Program**)).

This example illustrates the fields and controls on the Link Test Tree to Program page. You can find definitions for the fields and controls later on this page.

Link Test Tree to Program

Academic Institution: PSNLD PeopleSoft University - NLD
Academic Career: BAC Bachelor (NLD)
Academic Program: H010 H010

Find | View All First 1 of 1 Last

*Campus: MAIN Main Campus + -

*Academic Load: Full-Time

*Term: 2040 Acad year 2004-2005

*Tree Name	*Tree EffDt	Default	
TA TEST	01/01/1900	CAL02.1.3 Sports	<input checked="" type="checkbox"/> + -

Field or Control	Description
Campus	Enter the campus for this test tree. See “Setting Up Campuses” (Campus Solutions Application Fundamentals).

Field or Control	Description
Academic Load	Select the academic load for this test tree. See “Defining Academic Level and Load Rules” (Campus Solutions Application Fundamentals).
Term	Enter the term for this test tree. Linking the test to a term enables the system to automatically link students to a test tree when they are matriculated. See “Defining Terms, Sessions, and Session Time Periods” (Campus Solutions Application Fundamentals)
Tree Name	Enter the test tree for this academic program, campus, academic load, and term combination.
Tree EffDt	Enter the effective date of the tree. Test trees can have multiple effective dates to accommodate several versions of the same tests.
Default	Select whether this test tree should be used as the default for this academic program.

Setting up Default VAVO Combination Grade Courses

This section discusses how to:

- Add Combination Grade Course defaults.
- Run the Combination Grade Process.

Pages Used to Set Up Default VAVO Combination Grade Courses

Page Name	Definition Name	Navigation	Usage
VAVO Combination Grade Courses	SSR_BR_VAVO_CTBL	Records and Enrollment > Test Administration NLD > Set Up Test Administration > VAVO Combination Grade Courses > VAVO Combination Grade Courses	Add one or more Combination Grade Test defaults per institution, career, term, tree name, and tree effective date.

Page Name	Definition Name	Navigation	Usage
VAVO Combination Grade Process	SSR_VAVO_COMB_GRD	Records and Enrollment > Test Administration NLD > Set Up Test Administration > VAVO Combination Grade Process > VAVO Combination Grd Process	Run this process to find default Combination Grade Courses set up for institution, career, term, tree and tree effective date and assign these to students linked to this same tree and tree effective date.

Adding Combination Grade Course Defaults

Access the VAVO Combination Grade Courses page (**Records and Enrollment > Test Administration NLD > Set Up Test Administration > VAVO Combination Grade Courses > VAVO Combination Grade Courses**).

This example illustrates the fields and controls on the VAVO Combination Grade Courses page. You can find definitions for the fields and controls later on this page.

VAVO Combination Grade Courses

Institution PSNLD PeopleSoft University - NLD

Career VAVO Advanced General Educ. (NLD)

Term 2070 Acad year 2007-2008

Required Combination Grades for Tree

Find | View All First ◀ 1 of 1 ▶ Last

***Tree Name** 🔍 + -

***Tree EffDt** 🔍

	Test ID	Description	HEGIS Code	Education Level	
1	<input style="width: 80px;" type="text" value="00002278"/> 🔍	Fa12	400323		+ -

Customize | Find | View All | First ◀ 1 of 2 ▶ Last

Field or Control	Description
Tree Name	Select a validated Test Administration Test Tree value.
Tree EffDt (tree effective date)	Select a validated Test Administration Tree effective date.
Test ID	Test ID values contain EN test level tests from the values that you select in the Tree Name and Tree EffDt fields.

Running the Combination Grade Process

Access the VAVO Combination Grd Process page (**Records and Enrollment > Test Administration NLD > Set Up Test Administration > VAVO Combination Grade Process > VAVO Combination Grd Process**).

<i>Field or Control</i>	<i>Description</i>
As Of Date	The system date appears by default each time that you access the page, whether or not a date value already exists in the field. You can enter a different date before you run the process.

Creating Test Lists

Test lists are used for two purposes:

- To enroll students in multiple tests at one time during the enrollment process.
- During the evaluation process.

This section discusses how to:

- Create a tree list.
- Add tests to a test list.

Pages Used to Create Test Lists

<i>Page Name</i>	<i>Definition Name</i>	<i>Navigation</i>	<i>Usage</i>
Test List Information	SSR_TST_LIST_NLD	Records and Enrollment > Test Administration NLD > Set Up Test Administration > Test Lists > Test List Information	Enter test list information, such as subject area, academic organization, and course ID.
Test List - Tests	SSR_TST_LISTLN_NLD	Records and Enrollment > Test Administration NLD > Test Lists > Tests	Add tests to the list, either individually or by test tree.
Copy Tests	SSR_SEL_COPY_TESTS	Click the Copy Tests button on the Test Lists - Tests page.	Select the test list that you want to copy for this test list.

Creating a Test List

Access the Test List Information page (**Records and Enrollment > Test Administration NLD > Set Up Test Administration > Test Lists > Test List Information**).

This example illustrates the fields and controls on the Test List Information page. You can find definitions for the fields and controls later on this page.

Test List Information		Tests	
Test List ID:	00000007		
Find View All First ◀ 1 of 1 ▶ Last			
*Effective Date:	<input type="text" value="02/10/2005"/>	*Status:	<input type="text" value="Active"/>
*Description:	<input type="text" value="TA Test List"/>		
Short Description:	<input type="text" value="TA List"/>		
*Academic Institution:	<input type="text" value="PSNLD"/>	PeopleSoft University - NLD	
*Academic Career:	<input type="text" value="BAC"/>	Bachelor (NLD)	
*Subject Area:	<input type="text" value="AGRIC"/>	Agriculture	
*Academic Organization:	<input type="text" value="AGRIC"/>	Agriculture	
*Test List Use:	<input type="text" value="Both"/>		
Course ID:	<input type="text"/>		

<i>Field or Control</i>	<i>Description</i>
Test List ID	When you create a new test list, this number is be all zeros. When you save the test list, the system assigns the next sequential number from the Next Test ID field on the Installation table.
Test List Use	A test list can be used to enroll students in tests or in the evaluation process. Values are: <i>Both:</i> Enables this test list to be used during the evaluation process and to enroll students into the tests on the list. <i>Evaluation:</i> Enables this test list to be used during the evaluation process only. <i>Place:</i> Enables this test list to be used to enroll students into the tests on the list only.
Course ID	Select a course ID to link this test list to a course.

Adding Tests to a Test List

Access the Test List - Tests page (**Records and Enrollment > Test Administration NLD > Test Lists > Tests**).

<i>Field or Control</i>	<i>Description</i>
Copy Tests	Click to add tests by copying the tests in another test list. The Copy Tests page appears, where you can select a test list ID.
Tree Name	Enter a test tree to add tests to the list by tree.
Tree EffDt (tree effective date)	Enter the effective date of the tree that you want to use to add tests to the list. Only valid effective dates for the tree that you select are available.
Fetch Data	Click to populate the grid with the tests and calculated results that make up the test tree.
Sequence	The system increments this number by 1 for each row. Change the order of the rows by changing the sequence number.
Test ID	Enter a test ID to add to this test list. This field is automatically populated when you click the Fetch Data button if you entered a test tree ID and effective date.

Defining Evaluation Rules

Before you can use the Evaluate Students process to determine whether students have passed all of the requirements for a course, a test or calculated result of a test, or for graduation, you must define the evaluation rules, or requisites. The requirements for the evaluation are linked to test trees.

When the system evaluates students, the Evaluate Students SQR process (SREVAENL) uses the evaluation requisites that are defined for a student's academic career, subject, academic organization, and academic program.

This section discusses how to:

- Define evaluation requisites.
- Define evaluation rule details.

Pages Used to Define Evaluation Rules

<i>Page Name</i>	<i>Definition Name</i>	<i>Navigation</i>	<i>Usage</i>
Requisites	SSR_REQUISITE_NLD	Records and Enrollment > Test Administration NLD > Set Up Test Administration > Requisites > Requisites	Define evaluation requirement by institution, career, program, subject area, academic organization, test tree, and test effective date.

Page Name	Definition Name	Navigation	Usage
Requisites Lines	SSR_REQUIS_LN_NLD	Records and Enrollment > Test Administration NLD > Set Up Test Administration > Requisites > Requisites Lines	Define the requisite lines for an evaluation requirement.
Copy Requisite Lines	SSR_SEL_COPY_REQ	Click the Copy Requisite Lines button on the Requisite Lines page.	Select a requisite ID from which to copy lines into this requisite.

Defining Evaluation Requisites

Access the Requisites page (**Records and Enrollment > Test Administration NLD > Set Up Test Administration > Requisites > Requisites**).

This example illustrates the fields and controls on the Requisites page. You can find definitions for the fields and controls later on this page.

Requisites
Requisites Lines

Requisite ID: 00000001

Find | View All
First
1 of 1
Last

*Effective Date:	08/01/2004	*Status:	Active
*Description:	Atheneum N&T		
*Academic Institution:	PSNLD	PeopleSoft University - NLD	
*Academic Career:	VAVO	Advanced General Educ. (NLD)	
Academic Program:	R004	Atheneum N&T	
*Subject Area:	EDU	Education	
*Academic Organization:	EDUCATN	Education	
Release Restriction:	Release		
Evaluation Type:	End		
Tree Name:	PROGRAM HAVO		
Tree EffDt:	08/01/2004		

Field or Control	Description
Academic Program	Enter the academic program to which this requirement applies.

Field or Control	Description
Release Restriction	<p>Indicate whether the grades that are used to satisfy this requisite and that are also restricted can be used in other requisites. Values are:</p> <p><i>Keep:</i> Grades used in this requisite that are restricted cannot be used in other requisites.</p> <p><i>Release:</i> Restrictions from this requisite are released, so grades used in this requisite can also be used in other requisites.</p>
Evaluation Type	<p>Select the evaluation type of this requisite. Values are:</p> <p><i>End:</i> The requisite applies to an end of term evaluation.</p> <p><i>In Between:</i> The requisite applies to evaluation milestones during the term.</p> <p>This field is informational only and is not used in any processing.</p>
Tree Name	<p>Enter the test tree for this requisite. Students who are linked to this test tree are evaluated based on the requisites defined here when you run the Evaluate Students process.</p>
Tree EffDt (tree effective date)	<p>Enter the effective date of the test tree for which you are defining evaluation requisites.</p>

Defining Evaluation Rule Details

Access the Requisites Lines page (**Records and Enrollment** > **Test Administration NLD** > **Set Up Test Administration** > **Requisites** > **Requisites Lines**).

This example illustrates the fields and controls on the Requisites Lines page. You can find definitions for the fields and controls later on this page.

Requisites		Requisites Lines																																																																																																																									
Requisite ID: 00000001																																																																																																																											
Effective Date: 08/01/2004		Status: Active																																																																																																																									
Description: Atheneum N&T		Copy Requisite Lines																																																																																																																									
Find View All First 1 of 1 Last																																																																																																																											
Customize Find View All First 1-9 of 9 Last																																																																																																																											
<table border="1"> <thead> <tr> <th>Seq Nbr</th> <th>Operators</th> <th>(</th> <th>Not</th> <th>Type</th> <th>*Item ID</th> <th>Show Tests</th> <th>Description</th> <th>Operators</th> <th>Value</th> <th></th> <th></th> </tr> </thead> <tbody> <tr> <td>10</td> <td></td> <td></td> <td><input type="checkbox"/></td> <td>Test List</td> <td>00000003</td> <td><input checked="" type="checkbox"/></td> <td>All courses Atheneum N&T</td> <td><=</td> <td>3.00</td> <td>+</td> <td>-</td> </tr> <tr> <td>20</td> <td>AND</td> <td></td> <td><input type="checkbox"/></td> <td>Test List</td> <td>00000003</td> <td><input checked="" type="checkbox"/></td> <td>All courses Atheneum N&T</td> <td><=</td> <td>4.00</td> <td>+</td> <td>-</td> </tr> <tr> <td>30</td> <td>AND</td> <td></td> <td><input type="checkbox"/></td> <td>Test List</td> <td>00000003</td> <td><input checked="" type="checkbox"/></td> <td>All courses Atheneum N&T</td> <td><=</td> <td>5.00</td> <td>+</td> <td>-</td> </tr> <tr> <td>40</td> <td>AND</td> <td></td> <td><input type="checkbox"/></td> <td>Test List</td> <td>00000004</td> <td><input checked="" type="checkbox"/></td> <td>Profile courses Ath N&T</td> <td><=</td> <td>5.00</td> <td>+</td> <td>-</td> </tr> <tr> <td>100</td> <td>AND</td> <td></td> <td><input type="checkbox"/></td> <td>Calc Res</td> <td>00000032</td> <td><input checked="" type="checkbox"/></td> <td>End Dutch</td> <td></td> <td></td> <td>+</td> <td>-</td> </tr> <tr> <td>110</td> <td>AND</td> <td></td> <td><input type="checkbox"/></td> <td>Test List</td> <td>00000005</td> <td><input checked="" type="checkbox"/></td> <td>Foreign Language 1</td> <td></td> <td></td> <td>+</td> <td>-</td> </tr> <tr> <td>300</td> <td>AND</td> <td></td> <td><input type="checkbox"/></td> <td>Calc Res</td> <td>00000079</td> <td><input checked="" type="checkbox"/></td> <td>End Mathematics B1,2</td> <td></td> <td></td> <td>+</td> <td>-</td> </tr> <tr> <td>310</td> <td>AND</td> <td></td> <td><input type="checkbox"/></td> <td>Calc Res</td> <td>00000064</td> <td><input checked="" type="checkbox"/></td> <td>End Science 1,2</td> <td></td> <td></td> <td>+</td> <td>-</td> </tr> <tr> <td>320</td> <td>AND</td> <td></td> <td><input type="checkbox"/></td> <td>Calc Res</td> <td>00000053</td> <td><input checked="" type="checkbox"/></td> <td>End Chemistry</td> <td></td> <td></td> <td>+</td> <td>-</td> </tr> </tbody> </table>				Seq Nbr	Operators	(Not	Type	*Item ID	Show Tests	Description	Operators	Value			10			<input type="checkbox"/>	Test List	00000003	<input checked="" type="checkbox"/>	All courses Atheneum N&T	<=	3.00	+	-	20	AND		<input type="checkbox"/>	Test List	00000003	<input checked="" type="checkbox"/>	All courses Atheneum N&T	<=	4.00	+	-	30	AND		<input type="checkbox"/>	Test List	00000003	<input checked="" type="checkbox"/>	All courses Atheneum N&T	<=	5.00	+	-	40	AND		<input type="checkbox"/>	Test List	00000004	<input checked="" type="checkbox"/>	Profile courses Ath N&T	<=	5.00	+	-	100	AND		<input type="checkbox"/>	Calc Res	00000032	<input checked="" type="checkbox"/>	End Dutch			+	-	110	AND		<input type="checkbox"/>	Test List	00000005	<input checked="" type="checkbox"/>	Foreign Language 1			+	-	300	AND		<input type="checkbox"/>	Calc Res	00000079	<input checked="" type="checkbox"/>	End Mathematics B1,2			+	-	310	AND		<input type="checkbox"/>	Calc Res	00000064	<input checked="" type="checkbox"/>	End Science 1,2			+	-	320	AND		<input type="checkbox"/>	Calc Res	00000053	<input checked="" type="checkbox"/>	End Chemistry			+	-
Seq Nbr	Operators	(Not	Type	*Item ID	Show Tests	Description	Operators	Value																																																																																																																		
10			<input type="checkbox"/>	Test List	00000003	<input checked="" type="checkbox"/>	All courses Atheneum N&T	<=	3.00	+	-																																																																																																																
20	AND		<input type="checkbox"/>	Test List	00000003	<input checked="" type="checkbox"/>	All courses Atheneum N&T	<=	4.00	+	-																																																																																																																
30	AND		<input type="checkbox"/>	Test List	00000003	<input checked="" type="checkbox"/>	All courses Atheneum N&T	<=	5.00	+	-																																																																																																																
40	AND		<input type="checkbox"/>	Test List	00000004	<input checked="" type="checkbox"/>	Profile courses Ath N&T	<=	5.00	+	-																																																																																																																
100	AND		<input type="checkbox"/>	Calc Res	00000032	<input checked="" type="checkbox"/>	End Dutch			+	-																																																																																																																
110	AND		<input type="checkbox"/>	Test List	00000005	<input checked="" type="checkbox"/>	Foreign Language 1			+	-																																																																																																																
300	AND		<input type="checkbox"/>	Calc Res	00000079	<input checked="" type="checkbox"/>	End Mathematics B1,2			+	-																																																																																																																
310	AND		<input type="checkbox"/>	Calc Res	00000064	<input checked="" type="checkbox"/>	End Science 1,2			+	-																																																																																																																
320	AND		<input type="checkbox"/>	Calc Res	00000053	<input checked="" type="checkbox"/>	End Chemistry			+	-																																																																																																																

Field or Control	Description
Copy Requisite Lines	Click to select an already-created requisite to copy. The Copy Requisite Lines page appears.

Requisite Lines Tab

Field or Control	Description
Seq Nbr (sequence number)	The system increments the sequence numbers by 10 for each line added. The Evaluate Students process evaluates the lines in this requisite in the order established by the sequence numbers. To change the order of the lines, change the sequence numbers.
Operators	If needed, select a Boolean operator to group requirements. The options are <i>AND</i> , <i>AND NOT</i> , <i>OR</i> , and <i>OR NOT</i> .
((open parenthesis)	Use parentheses to group requirements. You can use up to three levels.

Field or Control	Description
Not	Select if this line must <i>not</i> be true.
Type	Indicate whether this requisite line pertains to a <i>Calc Res</i> (calculated result), <i>Req</i> (requisite), <i>Test</i> , or <i>Test List</i> . You can create a line that pertains to another requisite because you can have nested requirements.
Item ID	Enter a calculated result, test ID, requisite ID, or test list ID, depending on what you selected in the Type field.
Description	The description of the calculated result, test, requisite, or test list.
Operators	<p>Operators enable the system to evaluate grades on a minimum or maximum condition to determine insufficient grades.</p> <p>For test lists, values are < (less than), <= (less than or equal to), = (equal to), >= (greater than or equal to), and > (greater than).</p> <p>For calculated results, requisites, and tests, values are > (greater than), = (equal to), and >= (greater than or equal to).</p>
Value	Enter the minimum or maximum value of a grade.

Details Tab

Access the Requisites Lines page: Details tab.

This example illustrates the fields and controls on the Requisites Lines page: Details tab. You can find definitions for the fields and controls later on this page.

Requisites
Requisites Lines

Requisite ID: 00000001 Find | View All First 1 of 3 Last

Effective Date: 08/01/2004 **Status:** Active

Description: Atheneum N&T Copy Requisite Lines

Customize | Find | View All First 1-9 of 9 Last

Requisite Lines

Details

Comments

Seq Nbr	Operators	(Not	Type	*Item ID	Function	Minimum Value	Maximum Value	Restrict	↓	↑	
10			<input type="checkbox"/>	Test List	00000003	In List						+ -
20	AND		<input type="checkbox"/>	Test List	00000003	In List		1.00				+ -
30	AND		<input type="checkbox"/>	Test List	00000003	In List		2.00				+ -
40	AND		<input type="checkbox"/>	Test List	00000004	In List		1.00				+ -
100	AND		<input type="checkbox"/>	Calc Res	00000032							+ -
110	AND		<input type="checkbox"/>	Test List	00000005	In List	1.00	2.00				+ -
300	AND		<input type="checkbox"/>	Calc Res	00000079							+ -
310	AND		<input type="checkbox"/>	Calc Res	00000064							+ -
320	AND		<input type="checkbox"/>	Calc Res	00000053							+ -

Field or Control	Description
Function	<p>Functions are used with test lists, and together with the minimum and maximum values enable you to link conditions to a group of courses, tests, or calculated results such as a minimum or maximum number of tests that a student must pass, or a minimum or maximum number with a specific calculated result.</p> <p>Values are:</p> <p><i>Average:</i> The average of the tests or courses in the list</p> <p><i>List:</i> The number of tests or courses that must be in the list.</p> <p><i>Sum 1:</i> The sum of Units 1.</p> <p><i>Sum 2:</i> The sum of Units 2.</p>
Minimum Value	Enter the minimum number for the selected function.
Maximum Value	Enter the maximum number for the selected function.

Field or Control	Description
Restrict	<p>Designate whether the grades that are used to satisfy this line can be used to satisfy other lines in other requisites. If the grades can be used to satisfy other lines in this requisite, leave the field blank.</p> <p>Select <i>All Result</i> if the grade used to satisfy this line cannot be used to satisfy other lines. The test or calculated result in this line is blocked for further evaluation within this requisite.</p> <p>Select <i>Restricted</i> if the grade used to satisfy this line cannot be used to satisfy other lines within this requisite, but can be used to satisfy lines in other requisites. The test or calculated result in this line is blocked for further evaluation within the requisite.</p>
) (close parenthesis)	Select to close group of lines.

Comments tab

Access the Comments tab.

This example illustrates the fields and controls on the Requisites Lines page: Comments tab. You can find definitions for the fields and controls later on this page.

The screenshot displays the 'Requisites Lines' page with the 'Comments' tab selected. At the top, the 'Requisite ID' is 00000001, the 'Effective Date' is 08/01/2004, and the 'Status' is Active. The 'Description' is 'Atheneum N&T'. Below this, there are navigation options like 'Find', 'View All', and 'Copy Requisite Lines'. The main table lists requisites with the following columns: Seq Nbr, Operators, (, Not, Type, *Item ID, and Comments. The table contains 10 rows of data:

Seq Nbr	Operators	(Not	Type	*Item ID	Comments
10			<input type="checkbox"/>	Test List	00000003	no grades under 4
20	AND		<input type="checkbox"/>	Test List	00000003	only 1 grade under 5
30	AND		<input type="checkbox"/>	Test List	00000003	only 2 grades under 6
40	AND		<input type="checkbox"/>	Test List	00000004	only 1 profile grade under 6
100	AND		<input type="checkbox"/>	Calc Res	00000032	
110	AND		<input type="checkbox"/>	Test List	00000005	at least one foreign language1
300	AND		<input type="checkbox"/>	Calc Res	00000079	
310	AND		<input type="checkbox"/>	Calc Res	00000064	
320	AND		<input type="checkbox"/>	Calc Res	00000053	

<i>Field or Control</i>	<i>Description</i>
Comments	Enter any text that you want to appear on the Student Evaluation page.

(NLD) Managing Student Higher Education Information

Tracking Student Higher Education Information

Institutions of higher education must supply information about enrollments and academic progress to Base Register Education (Basis Register Onderwijs or BRON). Use the Academic Prog Higher Education page and the Administer Student Higher Education page to register student data that are related to a program and academic year and are required by governmental regulations. You enter the data during the admissions process and during the students' enrollment for a program. Some information is populated automatically during the admissions process and by the matriculation process. Some data—such as form of study and funding applies—are part of the data exchange for BRON.

Pages Used to Manage Student Higher Education Information

<i>Page Name</i>	<i>Definition Name</i>	<i>Navigation</i>	<i>Usage</i>
Academic Prog Higher Education	SSR_STD_PRG_NLD	Records and Enrollment > Higher Education NLD > Student Records Higher Edu NLD > Academic Prog Higher Education	Enter academic program for higher education information for a student.
Administer Student Higher Education	SSR_STUDENT_NLD	Records and Enrollment > Higher Education NLD > Student Higher Education NLD > Administer Student Higher Education	Enter higher education information for a student.
Higher Education Inquiry	SSR_HE_PRG_ENQ_NLD	Records and Enrollment > Higher Education NLD > Higher Education Inquiry NLD > Higher Education Inquiry	View higher education information for a student.

Entering Academic Program Higher Education Information for a Student

Access the Academic Prog Higher Education page (**Records and Enrollment > Higher Education NLD > Student Records Higher Edu NLD > Academic Prog Higher Education**).

Field or Control	Description
Effective Sequence	Enter the sequence number for this effective-dated row.
Progr Action Higher Education (program action higher education)	The program action for higher education appears by default from the Application table during the matriculation process. A change to the program action higher education adds a new row with a new effective date or effective sequence.
Form of Study Higher Education	Enter the student's form of study. Options are <i>Auditor</i> , <i>Coop/Dual</i> , <i>Extraneous</i> , <i>Participant</i> , and <i>Student</i> .
Acad Level Higher Education (academic level higher education)	Enter the student's academic level.
Funding Applies	Select this check box if funding rules apply to this student. This is part of the data set for BRON.
Program Units Apply	Select this check box if program unit rules apply to this student. This is part of the data set for BRON.
Academic Year	Enter the academic year for which this information applies.
Form of Payment	Select the form of the payment, such as cash, check, or loan. This field becomes available when the Progr Action Higher Education field is <i>PAYM</i> .
Authorized for Payment	If students have authorized a third-party, such as a parent or guardian, to make their tuition payment for them, enter that person's name here.

Managing Student Higher Information

Access the Administer Student Higher Education page (**Records and Enrollment > Higher Education NLD > Student Higher Education NLD > Administer Student Higher Education**),

Student Details

Field or Control	Description
First Year Higher Education	Enter the year a student was enrolled for the first time for higher education in The Netherlands regardless of the institution.
First Year Financial Aid	Enter the first year the student began receiving financial aid.

Field or Control	Description
Regime	Enter the regulation that applies to this student. Your options are <i>T</i> (Tempo Scholarship) or <i>P</i> (Performance Scholarship).
GBA Status (Gemeentelijke Basis Administratie status)	Enter the student's current GBA status.
GBA Year of Birth	Enter the student's year of birth according to GBA.
GBA Month of Birth	Enter the student's month of birth according to GBA.

Student BRINcode

Field or Control	Description
BRINcode	Enter a BRINcode for the student.
First Year of BRINcode	Enter the first year that this BRINcode applied to the student.
First Year Funded	Enter the first year that the student received funding.

Progress Academic Year

Update this section every year to reflect the student's progress. Add a row for each academic career.

Field or Control	Description
Academic Year	Enter the current academic year.
Individual Norm Units	Enter the units a student has earned for a certain program in a specified academic year.
Total Number of Units	Enter the student's total number of registered units for this academic year.
Study Progress	Select this check box if these units are currently in progress.
Add/Update Person	Click this link to access this student's personal data. See "Adding an Individual to Your Database" (Campus Community Fundamentals)

Viewing Higher Education Information for a Student

Access the Higher Education Inquiry page (**Records and Enrollment > Higher Education NLD > Higher Education Inquiry NLD > Higher Education Inquiry**).

<i>Field or Control</i>	<i>Description</i>
Academic Year	Enter an academic year to populate data for that year.

(NLD) Managing Test Administration

Common Elements Used to Manage Test Administration

<i>Field or Control</i>	<i>Description</i>
Academic Career	Enter the appropriate academic career. See “Defining Academic Careers” (Campus Solutions Application Fundamentals).
Academic Institution	Enter the appropriate academic institution. See “Defining Academic Institutions” (Campus Solutions Application Fundamentals).
Campus	Enter the appropriate campus. See “Setting Up Campuses” (Campus Solutions Application Fundamentals).
Session	Select the type of academic session. See “Defining Sessions” (Campus Solutions Application Fundamentals).
Term	Enter the appropriate term. See “Defining Terms” (Campus Solutions Application Fundamentals).

Creating Test Sessions

With the Test Administration functionality, create the test sessions and enroll students in the tests with the same process. Create a test session with a test date, start time and end time, session, section, exam session, facility, and instructor.

This section discusses how to:

- Select test session criteria.
- Insert test sessions and students.

Pages Used to Create Test Sessions

Page Name	Definition Name	Navigation	Usage
Create Test Sessions - Selection	SSR_CRE_TST_NLD	Records and Enrollment > Test Administration NLD > Create Test Sessions > Selection	Define the test session and select the method for enrolling students.
Insert Test Sessions/Students	SSR_CRE_TST1_NLD	Records and Enrollment > Test Administration NLD > Create Test Sessions > Insert Test Sessions/Students	Enter tests and calculated results in the test session and select the students for enrollment.

Selecting Test Session Criteria

Access the Create Test Sessions - Selection page ((**Records and Enrollment > Test Administration NLD > Create Test Sessions > Selection**)).

This example illustrates the fields and controls on the Create Test Sessions - Selection page. You can find definitions for the fields and controls later on this page.

The screenshot displays the 'Selection' page with the following details:

- Run Control ID:** TATEST
- Navigation:** [Report Manager](#) [Process Monitor](#) **Run**
- *Academic Institution:** PSNLD PeopleSoft University - NLD
- *Academic Career:** BAC Bachelor (NLD)
- *Term:** 2040 Acad year 2004-2005
- *Session:** Regular Academic Session
- Curr Effdt:** 02/10/2005
- Basis:** Student Enrollment Blocks
- Course ID:** (empty field)
- Options:**
 - Report Only
 - Process Grade Attributes
 - Process Repeats
 - Minimum Value**
 - Maximum Repeats** 1
- Enrollment Basis Table:**

Block	Description
1 BAC	Student BAC block

The Create Test Session SQR process (SRCRESNL) creates the test sessions and enrolls the students based on the criteria that you select on the Create Test Sessions - Selection and Insert Test Sessions/Student pages.

Field or Control	Description
Basis	Select how the system enrolls students. Values are: <i>Enrollment in Classes</i> : Select to enroll students who are enrolled in the selected classes into the test sessions. <i>Student Enrollment Blocks</i> : Select to enroll students into test sessions from an enrollment block. <i>Student Groups</i> : Select to enroll students into test sessions from a student group.
Course ID	Enter a course ID to select classes by course. This field is available only when you select <i>Enrollment in Classes</i> in the Basis field.
Report Only	Select to do a test run to determine whether the enrollment will be successful. You are able to view and correct any errors that occur with the your defined criteria before processing the actual enrollment.
Process Grade Attributes	Select to process students that have an exempt grade for the test.
Process Repeats	Select to process repeated sessions.
Minimum Value	Enter the minimum grade value that is allowed for repeats.
Maximum Repeats	Enter the maximum number of repeats that are allowed.

Enrollment Basis

Field or Control	Description
Block	Enter the enrollment block from which to enroll students. You can insert as many rows as needed. This field is available only when you select <i>Student Enrollment Blocks</i> in the Basis field.
Class	Enter the class from which you want to enroll students. You can insert as many rows as needed. This field is available only when you select <i>Enrollment in Classes</i> in the Basis field.

Field or Control	Description
Group	<p>Enter the student group from which you want to enroll students. You can insert as many rows as needed.</p> <p>This field is available only when you select <i>Student Groups</i> in the Basis field.</p>

Inserting Test Sessions and Students

Access the Insert Test Sessions/Students page (**Records and Enrollment > Test Administration NLD > Create Test Sessions > Insert Test Sessions/Students**).

This example illustrates the fields and controls on the Insert Test Sessions/Students page. You can find definitions for the fields and controls later on this page.

Field or Control	Description
Select All	<p>Select to choose from all test lists that are created for the academic institution and career combination. If this check box is cleared, you can choose only from the test lists that are associated with the course ID entered on the Selection page.</p> <p>This check box is available only if you selected <i>Enrollment in Classes</i> as the enrollment basis on the Selection page.</p>
Test List ID	<p>Enter a test list to generate test sessions for the tests in the list. You can add more than one test list.</p> <p>You can enroll students into test lists if you selected <i>Place or Both</i> in the Test List Use field on the Test List Information page.</p>

Field or Control	Description
Keep Group Codes	Select to create test sessions for each test in the test list for every class, group, or block that you entered on the Create Test Sessions - Selection page. For example, if you entered two classes and the test list contains four tests, selecting this check box would generate eight test sessions. If you clear this check box, the system creates one test session for each test in the test list and calls the session <i>TOT</i> .
Insert Session	Click to insert test sessions from the test list that you selected.
Insert Students	Click to enroll students from the basis on the Selection page.
Test ID	Enter a test or calculated result ID.
Test Date	Enter a default test date for the test sessions.
Examination Session	Select a default examination session for the test sessions that you create. The values are <i>Central Examination 1</i> , <i>Central Examination 2</i> , <i>End Examination 1</i> , <i>End Examination 2</i> , and <i>School Examination</i> .

Enrollment Data

Select the Enrollment Data tab.

Field or Control	Description
Select	Select to include this row in the Create Test Sessions process.
Enroll	Select to have the Create Test Sessions process enroll students from this row.
Details	Click to view, add, or delete students from the session, and to view messages about the students' enrollment in the session. The Enroll Student in Tests page appears.
Test ID	When you click the Insert Tests button, the system loads the tests from the test list and supplies the test ID. You can add or delete tests by adding or deleting rows.
Description	The description of the test appears.

Field or Control	Description
Test Date	The test date that is entered in the Process Default Values group box appears. You can change this date here.
Section	This comes from the selection page and is based on the selection in the Enrollment Basis grid.
Test Section1	If the Keep Group Codes check box is selected, the system populates this field with the description of the enrollment basis. If the Keep Group Codes check box is cleared, the system names the section <i>TOT</i> ; however, you can change it. This value appears in the Test Session pages.
Examination Session	The examination session that is entered in the Process Default Values group box appears. You can change the session if needed. The values are <i>CE1</i> , <i>CE2</i> , <i>EN1</i> , <i>EN2</i> , and <i>SCE</i> .

Details

Select the Details tab.

Field or Control	Description
Instructor ID	Enter an instructor for the test session.
Facility ID	Enter a facility for the test session.
Meeting Start Time	Enter the time that the meeting is planned to start.
Meeting End Time	Enter the time that the meeting is planned to end.

Maintaining Test Sessions

When you run the Create Test Session process, the system populates the Test Session table. Use the pages in the Test Session component to make any necessary changes to the test sessions details, enroll additional students, and enter grades and comments.

You can also manually create test sessions using the pages in the Test Session component.

This section discusses how to:

- Maintain test session details.

- Enroll additional students.
- Enter grades.
- Enter grade comments.

Pages Used to Maintain Test Sessions

<i>Page Name</i>	<i>Definition Name</i>	<i>Navigation</i>	<i>Usage</i>
Test Session	SSR_TST_SES1_NLD	Records and Enrollment > Test Administration NLD > Test Sessions > Test Session	View test sessions, or create new sessions. To create a session, select a test ID from the search dialogue page.
Test Sessions - Enroll Students	SSR_TST_SES2_NLD	Records and Enrollment > Test Administration NLD > Test Sessions > Enroll Students	Add students to the test session.
Test Sessions - Grades	SSR_TST_SES3_NLD	Records and Enrollment > Test Administration NLD > Test Sessions > Grades	Enter student grade details.
Test Sessions - Comments	SSR_TST_SES4_NLD	Records and Enrollment > Test Administration NLD > Test Sessions > Comments	Enter comments about the student grades.

Maintaining Test Session Details

Access the Test Session page (**Records and Enrollment > Test Administration NLD > Test Sessions > Test Session**).

This example illustrates the fields and controls on the Test Session page. You can find definitions for the fields and controls later on this page.

Test Session	Enroll Students	Grades	Comments
Test ID:	00000001 Social Cultural Education		
Academic Institution:	PeopleSoft University - NLD		
Academic Career:	Bachelor (NLD)		
Term:	Acad year 2004-2005		
Find View All First 1 of 1 Last			
*Session:	Regular Academic Session		+ -
*Test Section:	01222		
*Test Date:	02/22/2005		
Examination Session:	Central Examination 1		
Meeting Start Time:	9:30AM		
Meeting End Time:	11:30AM		
Facility ID:	<input type="text"/>		
Instructor ID:	SR14031		

<i>Field or Control</i>	<i>Description</i>
Test Section	Enter the test section code. This field is alphanumeric and can be up to 5 characters long.
Test Date	Enter the date of the test session.
Examination Session	Select the examination type.
Meeting Start Time and Meeting End Time	Enter the start and end times for the test session.
Facility ID	Enter a facility ID. Facility IDs are defined on the Facility Table page. See Defining Buildings, Rooms, and Classroom Facilities .
Instructor ID	Enter the ID for the instructor facilitating the test session.

Enrolling Additional Students

Access the Test Sessions - Enroll Students page (**Records and Enrollment > Test Administration NLD > Test Sessions > Enroll Students**).

Field or Control	Description
Basis	Select how to enroll students. Values are <i>Enrollment in Classes</i> , <i>Student Enrollment Blocks</i> , and <i>Student Groups</i> .
Class, Block, or Group	Enter the enrollment block, class, or student group from which to enroll students for this session. The name of this field depends on the selection in the Basis field.
Add Students	Click to add students to the test section.
ID	Enter the ID of a student to enroll in the test session.
Grading Basis	Enter the grading basis for this student.

Entering Grades

Access the Test Sessions - Grades page (**Records and Enrollment** > **Test Administration NLD** > **Test Sessions** > **Grades**).

Field or Control	Description
Present	The system automatically selects this check box.
Official Grade	Enter the grade for the student. Grade values are defined for each grading basis on the Grading Scheme table. See Setting Up Your System for Grading
Grade Attribute	Select a grade attribute. Values are: <i>Diff Qual</i> (different qualification): This grade is received from another institution. <i>Ex Calc</i> (exclude from calculation): This is an exemption without a grade. This grade is not used in the calculation process. <i>Exemption</i> : This grade is based on an exemption. <i>Ex Com Grd</i> (exemption combination grade): Exemption with a specific distinction of Combination Grade. It is managed the same as a grade with an attribute type of <i>Exemption</i> .

Field or Control	Description
No Calculation	<p>Enter a reason for the grade not being used in the calculation process. Values are:</p> <ul style="list-style-type: none"> • <i>No Qual</i> (no qualification or diploma). • <i>Not Rel</i> (not relevant). • <i>Ref Term</i> (reference to other term). • <i>Withdrawn</i>.

Entering Grade Details

Access the Test Sessions - Grades page: Details tab.

Field or Control	Description
Test Score	Enter the score that the student received for the test.
Units 1 and Units 2	If the grade is sufficient for the student to earn credit, the system populates this field with the credit value that is entered in the course catalog.
Valid Through	If the grade is valid for only a limited amount of time, the system populates this field with the appropriate date based on what is entered in the Grade Valid and Years Valid fields in the test catalog.
School Type	Select whether the school is <i>Day</i> or <i>Night</i> .

Entering Grade Comments

Access the Test Sessions - Comments page (**Records and Enrollment** > **Test Administration NLD** > **Test Sessions** > **Comments**).

Field or Control	Description
Consolidated	This is selected if the student has completed the program. All grades that are linked to the program through the linked test tree are set to consolidated and you cannot delete or change anything on these grade records.

Field or Control	Description
Complete	This is automatically selected when a grade is entered, when a calculated result is manually entered with a grade attribute, and when a calculated result that satisfies all the requisites is entered by the calculation process. If a grade for a calculated result is entered without an attribute or if a calculated result that does not meet all of the requisites is entered by the calculation process, the check box is cleared.
Frozen	Select this check box if you do not want the calculated result to be removed during the calculation process.
Comments and Additional Comments	Free form text fields exist that can print on reports used by your institution.

Maintaining Test Sessions by Session

The pages in the Maintain Test Session per Sessions component (SSR_TST_PSES_NLD) are the same as in the Test Session component (SSR_TST_SES_NLD) except that the Maintain Test Session per Session component does not have the Session page.

This section discusses how to:

- Enroll students by test session.
- Enter grades.
- Enter comments.

Pages Used to Maintain Test Sessions by Session

Page Name	Definition Name	Navigation	Usage
Test Session per Session - Enroll Students	SSR_TST_PSES2_NLD	Records and Enrollment > Test Administration NLD > Test Sessions per Session > Enroll Students	Enroll additional students in the test session.
Test Session per Session - Grades	SSR_TST_PSES3_NLD	Records and Enrollment > Test Administration NLD > Test Sessions per Session > Grades	Enter grade details for each student.
Test Session per Session - Comments	SSR_TST_PSES4_NLD	Records and Enrollment > Test Administration NLD > Test Sessions per Session > Comments	Enter additional grade details and comments for each student.

Enrolling Students by Test Session

Access the Test Sessions per Session - Enroll Students page (**Records and Enrollment > Test Administration NLD > Test Sessions per Session > Enroll Students**).

The fields on this page are the same as those on the Test Sessions - Enroll Students page.

See [Enrolling Additional Students](#).

Entering Grades

Access the Test Sessions per Session - Grades page (**Records and Enrollment > Test Administration NLD > Test Sessions per Session > Grades**).

The fields on this page are the same as those on the Test Sessions - Grades page.

See [Enrolling Additional Students](#).

Entering Comments

Access the Test Sessions per Session - Comments page (**Records and Enrollment > Test Administration NLD > Test Sessions per Session > Comments**).

The fields on this page are the same as those on the Test Sessions - Comments page.

See [Entering Grade Comments](#).

Maintaining Test Sessions by Student

Grades for test sessions can also be entered and viewed by student.

This section discusses how to:

- Maintain test sessions by student.
- Maintain session grades per student.

Pages Used to Maintain Test Sessions by Student

<i>Page Name</i>	<i>Definition Name</i>	<i>Navigation</i>	<i>Usage</i>
Test Sessions per Student	SSR_ST_SES_ADD_NLD	Records and Enrollment > Test Administration NLD > Test Sessions Per Student > Test Sessions per Student	Add test session or enter test session grades for a student.

Page Name	Definition Name	Navigation	Usage
Student Grades - Test Session	SSR_STD_GRD1_NLD	Records and Enrollment > Test Administration NLD > Student Grades > Test Session	View session enrollment information for a student.
Student Grades - Grade	SSR_STD_GRD2_NLD	Records and Enrollment > Test Administration NLD > Student Grades > Grade	View, add, alter, or delete grades per student.
Student Grades - Comments	SSR_STD_GRD3_NLD	Records and Enrollment > Test Administration NLD > Student Grades > Comments	View, add, alter, or delete grade comments per student.

Maintaining Test Sessions by Student

Access the Test Sessions per Student page (**Records and Enrollment > Test Administration NLD > Test Sessions Per Student > Test Sessions per Student**).

This example illustrates the fields and controls on the Test Sessions per Student page. You can find definitions for the fields and controls later on this page.

Test Sessions per Student

ID: SRN015 ERIC HELMUS
Academic Institution: PeopleSoft University - NLD
Academic Career: Bachelor (NLD)
Term: Acad year 2004-2005

▼ Add Test Sessions

Test ID:	<input type="text" value="00000001"/> Social Cultural Education	Test Date:	<input type="text" value="05/10/2005"/> [31]	<input type="button" value="Search"/>
Session:	<input type="text" value="Regular Academic Session"/>	Test Section:	<input type="text" value="01222"/>	
Examination Session	<input type="text"/>	<input type="button" value="Add Test Sessions"/>		

Customize | Find | View All | First 1 of 1 Last

Enrollment Data	Details	Session/Date/Section						
Test ID	Description	Present	Grade Base	Grade	Grade Attribute	No Calculation	Grade Date	
00000001	Social Cultural Education	☑	GRD [Q]	[Q]	[v]	[v]	02/10/2005 [31]	[-]

Field or Control	Description
Test ID	Enter the test ID in which to enroll the student.
Examination Session	Select an exam session.

Field or Control	Description
Test Date	Enter a test date.
Test Section	Enter a test section.
Search	Click to search for valid test sessions based on any combination of criteria entered in the Add Test Session group box. The Search Test Session page appears.
Add Test Sessions	Click to add the selected test session to the student's list.

Enrollment Data Tab

Access the Test Sessions per Student page - Enrollment Data tab.

The fields on the Enrollment Data tab are the same as those on the Test Sessions - Grades page: Enrollment Data tab.

See [Entering Grades](#).

Details Tab

Access the Test Sessions per Student page: Details tab.

The fields on the Details tab are the same as those on the Test Sessions - Grades page: Details tab and the Test Sessions - Comments page.

See [Entering Grades](#).

See [Entering Grade Comments](#).

Maintaining Session Grades per Student

The pages in the Student Grades component (SSR_STD_GRD_NLD) are similar to the pages that are used to enter grades and comments in the Test Session component (SSR_TST_SES_NLD). The Student Grades component does not have the Enroll Student page, and the fields on the Test Session page are view only.

Linking Test Trees to Students

When an applicant is matriculated, the test trees that are linked to the program are assigned to the student. After a student has been matriculated, you can link additional test trees to the student.

Related Links

[Creating Test Trees in Tree Manager](#)

Page Used to Link Test Trees to Students

<i>Page Name</i>	<i>Definition Name</i>	<i>Navigation</i>	<i>Usage</i>
Student Test Tree	SSR_STPRG_TREE_NLD	Records and Enrollment > Test Administration NLD > Student Test Tree > Student Test Tree	Link test trees to students.

Linking Test Trees to Students

Access the Student Test Tree page (**Records and Enrollment > Test Administration NLD > Student Test Tree > Student Test Tree**).

<i>Field or Control</i>	<i>Description</i>
Tree Name	Select the tree ID to which the student will be linked.
Tree EffDt (tree effective date)	Enter the effective date of the tree.

Maintaining VAVO Course Options

Use the VAVO Course Per Student (SSR_TSTVAVO_NLD) component to specify whether VAVO courses are combination grades or taken at a higher level.

Combination grades are set up as a calculated result for which all possible underlying combination grades have been allocated. However, student exceptions can occur. Use the Student VAVO Course Details page to indicate which courses are part of the overall combination grade calculation for a particular student.

Administrators can also assign higher level course substitutions on this page. Higher level course substitutions offer students the possibility to achieve higher-level course results for specified courses, allowing these students to excel in particular course subjects.

Page Used to Maintain VAVO Course Options

<i>Page Name</i>	<i>Definition Name</i>	<i>Navigation</i>	<i>Usage</i>
Student VAVO Course Details	SSR_TSTVAVO_NLD	Records and Enrollment > Test Administration NLD > VAVO Course per Student > Student VAVO Course Details	Enter combination grade courses and/or substitution higher level courses.

Maintaining VAVO Course Options

Access the Student VAVO Course Details page (**Records and Enrollment > Test Administration NLD > VAVO Course per Student > Student VAVO Course Details**).

This example illustrates the fields and controls on the Student VAVO Course Details page: Combination Grade or Replaced TST ID tab. You can find definitions for the fields and controls later on this page.

Student VAVO Course Details

Higher Level Course substitution and indication for combination grades

Bert Wiegel SSRNL00005

Academic Institution: PSNLD PeopleSoft University - NLD
Academic Career: VAVO
Career Nbr: 0
Academic Program: R007 VAVO ATH NW no profile
Campus: MAIN Main Campus
Academic Load: Full-Time
Term: 2070

Test ID	HEGIS Code	Education Level	Description	Combination Grade
1 00002150	430071	VWO	Engelse taal	<input checked="" type="checkbox"/>
2 00002152	430052	VWO	French Lang 1,2	<input checked="" type="checkbox"/>
3 00002171	430051	VWO	French Lang 1	<input checked="" type="checkbox"/>
4 00002278	400323			<input checked="" type="checkbox"/>
5 00002283	420260	HA	Music	<input checked="" type="checkbox"/>
6 00002284	400341	HA	Science 1	<input checked="" type="checkbox"/>
7 00002287	420181	HA	Chemistry	<input checked="" type="checkbox"/>

Field or Control	Description
Test ID	Select a test ID for which you want to add a combination grade indication or a higher level substitution course.
Combination Grade	Select to indicate that the test ID should count towards an overall combination grade calculated result. If you select this check box, the Calculation process uses the combination grade test result and counts it towards the overall combination grade calculated result set up through the Test Catalog.
Education Level	Displays the course education level. Education level is set up for each HEGIS Code that is related to a course (Set up SACR , Foundation Tables, Reporting Codes, HEGIS Code Table).

Select the Enter Higher Level Substitution Courses here tab.

Field or Control	Description
Test ID Higher Level	Select a test ID to indicate the substitution course for the combination grade or the replaced test ID. If you select a test ID, the Calculation process uses the grade test result from this test ID and counts it towards the overall calculated result in which this test ID is included. This can be done whether or not the Combination Grade check box is selected for the course.

Calculating Grades and Evaluating Students

After all grades for tests have been entered, the system can calculate the results by student or by program. The calculation process uses a test tree to retrieve test grades, weight values, and attributes.

Evaluations are also run by student or program. Based on information in the Requisite table, the system determines whether the student has passed or not passed. All of the requisites that are linked to the student's assigned test tree are evaluated, and the results per requisite and per requisite line are written to the Results table.

This section provides an overview of the Calculation process and discusses how to:

- Calculate grades per student.
- Calculate grades per program.
- Evaluate results per student.
- Evaluate results per program.

Understanding the Calculation Process

The calculation process:

1. Selects students for whom to calculate grades.
2. Determines whether the student is active in a program.
3. Selects the test tree that is linked to the student and determines whether the tree is valid.
4. Starts the actual calculation process starting with the nodes at the lowest level of the test tree.
5. For each node on the test tree, selects the underlying tests and calculated results.
6. For each node, selects the information from the calculated results with the latest effective date.
7. Determines whether the calculated results already exist for the student. If the calculated result already exists, and *calculate within term only* is not selected, the existing calculated result is deleted.
8. Writes the results to the Results table.

Pages Used to Calculate Cumulative Grades and Evaluate Students

<i>Page Name</i>	<i>Definition Name</i>	<i>Navigation</i>	<i>Usage</i>
Cumulative Grades per Student	SSR_RUNTSTEMPL_NLD	Records and Enrollment > Test Administration NLD > Cumulative Grades per Student > Cumulative Grades per Student	Start the Cumulative Grades per Student SQR process (SRCEMPNL) for specific students.
Cumulative Grades per Program	SSR_RUN_CALTST_NLD	Records and Enrollment > Test Administration NLD > Cumulative Grades per Program > Cumulative Grades per Program	Start the Cumulative Grades per Program SQR process (SRCACDNL) for all students in an academic program.
Evaluation per Student	SSR_RUNTSTEMPL_NLD	Records and Enrollment > Test Administration NLD > Evaluation per Student > Evaluation per Student	Start the Student Evaluation SQR process (SREVANENL) for specific students.
Evaluation per Program	SSR_RUN_CALTST_NLD	Records and Enrollment > Test Administration NLD > Evaluation per Program > Evaluation per Program	Start the Program Evaluation SQR process (SREVAPNL) for all students in an academic program.

Calculating Grades per Student

Access the Cumulative Grades per Student page (**Records and Enrollment > Test Administration NLD > Cumulative Grades per Student > Cumulative Grades per Student**).

This example illustrates the fields and controls on the Cumulative Grades per Student page. You can find definitions for the fields and controls later on this page.

Cumulative Grades per Student

Run Control ID: TATest [Report Manager](#) [Process Monitor](#) Run

***Academic Institution:** PeopleSoft University - NLD

***Academic Career:** Bachelor (NLD)

Campus: Main Campus

***Term:** Acad year 2004-2005

Session:

***Current Effective Date:** Delete All Students

▼ Add Students

Basis: **Block:** Add Students

		Customize Find View All	First	1-3 of 3	Last
ID	Name	Calculate Inactive Student			
1	<input type="text" value="SRN013"/> GELDER,NICOLAAS J	<input type="checkbox"/>	+	-	
2	<input type="text" value="SRN023"/> AMSTERDAM,DANIEL J	<input type="checkbox"/>	+	-	
3	<input type="text" value="SRN033"/> MEGGELEN,ADRIANA N	<input type="checkbox"/>	+	-	

Field or Control	Description
Basis	Select how the system selects students for the calculation process. The values are <i>Enrollment in Classes</i> , <i>Student Enrollment Blocks</i> , and <i>Student Groups</i> .
Block, Class, and Group	Enter the enrollment block, class, or student group for the system to calculate grades.
Calculate Inactive Student	Select to have the system consider grades for students who are no longer active in the academic career in the calculation process.

Calculating Grades per Program

Access the Cumulative Grades per Program page (**Records and Enrollment > Test Administration NLD > Cumulative Grades per Program > Cumulative Grades per Program**).

Field or Control	Description
Academic Program	Enter the academic program for the system to calculate grades.

Evaluating Results per Student

Access the Evaluation per Student page (**Records and Enrollment > Test Administration NLD > Evaluation per Student > Evaluation per Student**).

<i>Field or Control</i>	<i>Description</i>
Delete All Students	Click to clear all student rows from this page.
Basis	Select how the system selects students for the evaluation process. The values are <i>Enrollment in Classes</i> , <i>Student Enrollment Blocks</i> , and <i>Student Groups</i> .
Block, Class, and Group	Enter the enrollment block, class, or student group for the system to run the evaluation process.
Add Students	Click to have the system list the students from the selected basis on this page.

Evaluating Results per Program

Access the Evaluation per Program page (**Records and Enrollment > Test Administration NLD > Evaluation per Program > Evaluation per Program**).

<i>Field or Control</i>	<i>Description</i>
Academic Program	Enter the academic program for the system to run the evaluation process.

Viewing and Adjusting Evaluation Results

When the evaluation process is run, the system populates the Adjust Evaluation Results component (SSR_STPRGTR_CR_NLD). Evaluation results can be corrected or changed in this component if necessary.

This section discusses how to:

- View additional details of student evaluation results.
- Approve adjustments.
- Adjust evaluation results.

Pages Used to View and Adjust Evaluation Results

<i>Page Name</i>	<i>Definition Name</i>	<i>Navigation</i>	<i>Usage</i>
Result Determination	SSR_STPRG_APPR_NLD	Records and Enrollment > Test Administration NLD > View Evaluation Results > Result Determination	View student evaluation results.
Details Determination	SSR_STDPRAPRST_NLD	Records and Enrollment > Test Administration NLD > View Evaluation Results > Details Determination	View additional details of student evaluation results.
Adjust Approval	SSR_STPRGAPCR_NLD	Records and Enrollment > Test Administration NLD > Adjust Evaluation Results > Adjust Approval	Manually override the outcome of the evaluation process.
Adjust Result	SSR_STDPRAPPCR_NLD	Records and Enrollment > Test Administration NLD > Adjust Evaluation Results > Adjust Result	Indicate whether a correction needs to be made to a requisite line.

Viewing Additional Details of Student Evaluation Results

Access the Details Determination page (**Records and Enrollment > Test Administration NLD > View Evaluation Results > Details Determination**).

<i>Field or Control</i>	<i>Description</i>
Test ID HigLvl (Test ID Higher Level)	Displays the higher level test ID if the lower level test ID has been substituted.
Education Level	Displays the education level from the HEGIS code linked to the test ID in the Test Catalog.

Approving Adjustments

Access the Adjust Approval page (**Records and Enrollment > Test Administration NLD > Adjust Evaluation Results > Adjust Approval**).

Field or Control	Description
Requisite ID	The requisite ID for which the student has been evaluated. Requisites are defined on the Requisites table. See Defining Evaluation Rules .
Approval Result	If necessary, change the result to either <i>Passed</i> or <i>Not Passed</i> .
Result Date	The system populates this field with the date on which the Evaluation process is run.

Adjusting Evaluation Results

Access the Adjust Result page (**Records and Enrollment > Test Administration NLD > Adjust Evaluation Results > Adjust Result**).

This example illustrates the fields and controls on the Adjust Result page. You can find definitions for the fields and controls later on this page.

Field or Control	Description
Order	Enter the requisite line number.
Correction Required	Select if the test ID, official grade, or test ID higher level on this line can be replaced by another test ID.

Reporting Evaluation Data

Evaluation data is used to print diplomas and grade lists. The data is also used as a basis for official reporting to the Dutch government.

This section discusses how to run the appraisal report process.

Page Used to Report Evaluation Data

<i>Page Name</i>	<i>Definition Name</i>	<i>Navigation</i>	<i>Usage</i>
Appraisal Reporting	SSR_RUNAPPRREP_NLD	Records and Enrollment > Test Administration NLD > Appraisal Reporting > Appraisal Reporting	Start the Evaluation Reporting SQR process (SREVRPNL).

Running the Appraisal Report Process

Access the Appraisal Reporting page (**Records and Enrollment > Test Administration NLD > Appraisal Reporting > Appraisal Reporting**).

<i>Field or Control</i>	<i>Description</i>
ID	Enter the ID for the student.
Academic Program	Enter the academic program.
Tree Name	Enter the name of the test tree name where the evaluation results are stored.
Tree EffDt (tree effective date)	Enter the effective date of the tree.
From Date and To Date	Enter the from and to dates for which the evaluation process was run.
Run Date	The system populates with the date on which the reporting process is run.

Loading and Viewing Grade Data in Test Trees

Load grade data in test trees either by student or by program, and then view the grades within the tree structure.

This section discusses how to:

- Load grade data into test trees by student.
- Load grade data into test trees by program.

Pages Used to Load and View Grade Data in Trees

<i>Page Name</i>	<i>Definition Name</i>	<i>Navigation</i>	<i>Usage</i>
Grades in Tree per Student	SSR_RUNTSTEMPL_NLD	Records and Enrollment > Test Administration NLD > Grades in Tree per Student > Grades in Tree per Student	Select students and run the Grades in Tree per Student SQR process (SRGITENL).
Grades in Tree per Program	SSR_RUN_CALTST_NLD	Records and Enrollment > Test Administration NLD > Grades in Tree per Program > Grades in Tree per Program	Select programs and run the Grades in Tree per Program SQR process (SRGITPNL).
Study Program - Test	SSR_STPRG_TREE_NLD	Records and Enrollment > Test Administration NLD > View Grades in Tree > Study Program - Test	View the test trees that are linked to the student.
Grades in Tree	SSR_STTRGRD_NLD	Records and Enrollment > Test Administration NLD > View Grades in Tree > Grades in Tree	View the individual test grades for the student.

Loading Grade Data into Test Trees by Student

Access the Grades in Tree per Student page (**Records and Enrollment > Test Administration NLD > Grades in Tree per Student > Grades in Tree per Student**).

The fields on this page are the same as the fields on the Cumulative Grades per Student page.

See [Calculating Grades per Student](#).

Loading Grade Data into Test Trees by Program

Access the Grades in Tree per Program page (**Records and Enrollment > Test Administration NLD > Grades in Tree per Program > Grades in Tree per Program**).

The fields on this page are the same as the fields on the Cumulative Grades per Program page.

See [Calculating Grades per Program](#).

Performing Repeat Checking

Understanding the Three Repeat Checking Methods

The Student Records Repeat Rule Checking process is flexible and robust. Much of repeat checking occurs automatically, without the user seeing it. However, Student Records also enables you to run the Repeat Rule Checking process in batch and manually.

Automatic Repeat Checking

Automatic repeat-checking processing occurs when you:

- Post enrollment requests.
- Post grades using the Enrollment Request page or the Quick Enrollment page.

Repeat checking does *not* occur when you post grades using the Student Enrollment page or the grade roster.

- Post transfer credit.

With automatic repeat-checking processing, you do not have to run a process through the process scheduler to check for repeats (although that is an option). After you perform a little setup, the system runs the process automatically.

Note the slight differences between the automatic repeat-checking processing through enrollment request grade posting and the automatic repeat-checking batch processing following grade posting and transfer credit posting.

When a student attempts to enroll in classes, the Repeat Rule Checking process scans the student's course history for a course ID or equivalent course ID that matches the requested course ID. If the process finds a matching pair, it can do one of three things: issue a warning that repeat codes might apply and that the enrollment might not count towards the student's degree, prevent the enrollment, or ignore the match. Note that the process does not assign repeat codes to the repeated course at this stage.

When you post grades (using the Enrollment Request page) and transfer credit, the Repeat Rule Checking process likewise scans the student's course history for a course ID or equivalent course ID that matches the ID of the course for which you are posting the grade or transfer credit. If the process finds a matching pair, it evaluates each course of the pair based on the repeat rules that you have created. Because the process can no longer prevent enrollment because the student has already taken the class, it assigns a repeat code. The process assigns a violation repeat code to the repeated course when the repeated course causes the student to exceed the total units allowed or total attempts allowed (as defined first on the Repeat Rule 2 page and later for each rule on the Repeat Rule Detail 1 page). Or the process assigns a repeat code to both courses in the matched pair when the repeated course is in violation of a particular repeat rule.

For example, you can set up a rule for the undergraduate career that allows students to repeat twice those courses in which they receive a failing grade. The Repeat Rule Checking process scans the student's

history to identify other instances of this particular course ID or equivalent course ID. When the process finds a repeat and establishes the matched pair, it evaluates the current course to see if it violates the repeat rule's total attempts allowed and total units allowed. If either maximum has been exceeded, the Repeat Rule Checking process assigns a violation repeat code to only the current course in the matched pair. However, if the process determines that the repeat violates any of the established rules, it assigns repeat codes to the matched pair of courses.

Because automatic repeat checking during peak enrollment and grade-posting periods can negatively impact the performance of your system, you can temporarily suspend automatic repeat checking for the entire academic institution on the Academic Institution 5 page, for an academic career on the Repeat Checking page (Academic Career Table component), and for academic programs on the Taxonomy/Campus page (Academic Program Table component).

Automatic repeat checking is optional when processing transfer credit. You set this repeat checking control on the Academic Institution 5 page.

Repeat Checking in Batch

Run the Repeat Rule Checking process in batch through the Repeat Checking page or set up the Process Scheduler to run the process automatically. After grades are posted, you can run repeat checking in batch whenever you want in the term. However, you should not run the batch process more than once per term because codes that have been set in the first run can be inadvertently changed in subsequent runs.

When you use the grade roster to post grades, you must run the batch process to check courses against your repeat rules. The automatic Repeat Rule Checking process runs only when grades are posted using the Enrollment Request page. Therefore, one way to use the repeat checking in batch functionality is to run the batch process after most of your grades have been posted on the grade roster. Then, you can run repeat checking on grade input for individual students whose grades are posted after the batch process has been run.

You can run repeat checking in batch for all students in an entire academic career, for an academic program within an academic career, or for individual students. Repeat checking in batch can also be term-driven, running from a specific term and moving back in time.

Assigning Repeat Codes Manually

You can manually assign repeat codes to a student's record. For special individual cases, you can go into the student's record through the Student Enrollment page, the Quick Enrollment page, or the Enrollment Request page, depending on your security access, and select a value for the **Repeat Code** field. You can also use this method to change the repeat codes that the automatic process assigned. Assigning repeat codes manually affects academic statistics just as it would if the repeat codes were assigned using the Repeat Rule Checking process.

In addition, repeat rules contain certain exemption conditions. You can set up exemption codes on the Repeat Rule 2 page and manually assign these codes to a specific class on the Student Enrollment 1, Enrollment Request, or Quick Enrollment page. When the Repeat Rule Checking process finds a repeat, and the repeat rule specifies that an exemption exists, the process looks to see whether the repeat code that is exempted is assigned to the student's record.

For example, a repeat rule might demand that a repeat be approved by petition. Thus, an *Approved via Petition* repeat code would be listed as an exemption so that when a student received the approval, you could assign the appropriate repeat code to the student's enrollment record. The Repeat Rule Checking process would identify the enrollment as a repeat, but when it found the exempted repeat code on the

current class, it would allow the enrollment. Exemption codes function for both front-end and back-end repeat check processing, allowing overrides to the total attempts allowed and total units allowed maximums that are established on the Repeat Rule 2 page.

Related Links

[Understanding Repeat Checking Functionality](#)

Running the Repeat Rule Checking Process in Batch

This section discusses how to run the Repeat Rule Checking process (SRPCERPT) in batch.

Page Used to Run the Repeat Rule Checking Process in Batch

Page Name	Definition Name	Navigation	Usage
Repeat Checking	RUNCTL_SR_RPTRULE	Records and Enrollment > Term Processing > End of Term Processing > Repeat Checking > Repeat Checking	Run the Repeat Rule Checking COBOL/SQL process (SRPCERPT) in batch, or set up the process scheduler to run the process automatically.

Running the Repeat Rule Checking Process in Batch

Access the Repeat Checking page (**Records and Enrollment > Term Processing > End of Term Processing > Repeat Checking > Repeat Checking**).

This example illustrates the fields and controls on the Repeat Checking page. You can find definitions for the fields and controls later on this page.

Repeat Checking

Run Control ID: 1 [Report Manager](#) [Process Monitor](#) Run

*Institution	*Career	Program	Term	ID	*Mode	*Check	*Scope		
PSUNV	UGRD	LAU		SR0400	A	A	E	+	-
PSUNV	UGRD	LAU	0550	SR0401	T	0	E	+	-
PSUNV	UGRD	LAU	0550	SR0402	T	0	E	+	-
PSUNV	UGRD	LAU	0550	SR0403	T	0	E	+	-
PSUNV	UGRD	LAU	0550	SR0404	T	0	E	+	-

Field or Control	Description
Institution	Select the academic institution for which you want to run the process.

Field or Control	Description
Career	Select the academic career within the academic institution, or the academic career for a particular student, for which you want to run the process. If you do not select an academic program and ID, the process checks for repeats for every student in this academic career (you can also narrow the search by term).
Program	Select the academic program for which you want to run the process. If you do not select an ID, the process checks for repeats for every student in this primary academic program (you can also narrow the search by term).
Term	Select the term for which you want to run the process. The system uses the start date of the term as the effective date and uses repeat rules that are valid for the term.
ID	If you want to check for repeats for particular students, select an ID. If you do not specify an ID, the process runs on all students in the academic career, primary academic program, and term that you selected.
Mode	<p>From the following choices, select the mode for the repeat process. The system uses the aspect of the student's record that you select.</p> <p><i>All/Entire Record:</i> The Repeat Rule Checking process starts at the beginning of the student's record and progresses forward to the current term, considering all courses within the student's record. This mode is ideal for processing over many terms that have never been processed for repeat checking, for example, after converting student data. You should not specify values for the Term field when you run the Repeat Rule Checking process in the <i>All/Entire Record</i> mode.</p> <p><i>Entire Term:</i> The Repeat Rule Checking process checks for repeats against <i>only</i> the student enrollment records within the term that you specify in the Term field. The process starts with the specified term and progresses back in time looking <i>only</i> for matches of classes that were taken within the specified term. The Term field is required when you are running the process in this mode. This is the standard mode to use when running repeat checking in batch at the end of each term.</p> <hr/> <p>Note: Keep in mind that when you run the process in the All/Entire Record mode, any previous set repeat codes are subject to be changed.</p> <hr/>

Field or Control	Description
Check	<p>From the following choices, select which aspects of the student's enrollment records (STDNT_ENRL) the process should check.</p> <p><i>All Courses:</i> The process analyzes all student enrollment records within the mode and scope that you select.</p> <p><i>Only Repeat Candidates:</i> The process analyzes only those courses in the selected process term for which the repeat candidate flag on the STDNT_ENRL table is set to <i>Y</i>. Courses in prior terms can contain either a <i>Y</i> or <i>N</i> value.</p>
Scope	<p>From the following choices, select the scope of the process.</p> <p><i>All Work for Term:</i> The process considers all of the course work on the student's enrollment records, including course transfer credit.</p> <p><i>Student Enrollments Only:</i> The process considers only courses for which the student enrolled through the internal academic institution. Credit received by transfer is not considered.</p> <p><i>Transfer/Test Credit:</i> The process considers only course transfer credit.</p> <p>If you select <i>All Work for Term</i> or <i>Transfer/Test Credit</i>, the Repeat Checking process assigns repeat codes to transfer credit, whether or not the Process on Transfer Credit check box on the Academic Institution 5 page is selected.</p>

Related Links

[Understanding Repeat Checking Functionality](#)

[Defining Repeat Rules](#)

Managing the Schedule of Classes

Understanding the Schedule of Classes

When you first set up your Student Records system, you schedule new courses for the first time. From then on, it is likely that you will roll classes from term to term, add any new courses to your schedule, and if necessary, revise classes that are already scheduled.

Note: After you set up your course schedule for the first time, you can set parameters along the way that command the system to roll, or copy, certain courses from term to term, and you can request that certain verifications are made against a student's record at enrollment request time. After you copy a prior term schedule to a new term, you can use the scheduling feature to move existing courses from time period to time period, to add sections, and so on.

The scheduling features in the Student Records application include the following four components:

1. Schedule of Classes
2. Schedule New Course
3. Schedule Class Meetings
4. Update Sections of a Class

The difference between these components is the view of the classes that you see:

- The Schedule of Classes component displays only those courses that have already been scheduled for a term.

Instead of having to search through the list of all available courses, you can use the schedule of classes component to view just those courses that you have already scheduled.

- The Schedule New Course component displays all courses available to schedule.
- The Schedule Class Meetings component displays individual class sections that have been scheduled.
- The Update Sections of a Class component displays a snapshot summary of section information for a class.

You can use this component to view and make changes to individual class sections so that when you save any changes to a section the system performs the save process faster.

Other features of the class schedule function that we discuss in this section include how you create class associations and student permissions for enrollment. We also move through the "combined sections" functionality so that you get an introduction of the power of the tools, and we review instructor schedules and class meeting patterns. Finally, we explore the facility search capabilities, producing the schedule of classes report, and copying classes from term to term.

Particular setup is required if you use the Classroom Scheduling Interface with a third party scheduling system. Refer to the PeopleSoft Student Records Classroom Scheduling Technical Notes in My Oracle Support (ID 704634.1).

Scheduling New Classes

This section provides an overview of new class scheduling, lists prerequisites, and discusses how to:

- Define basic data for class sections.
- Add class association attributes using the Schedule of Classes component.
- Enter class fee information.
- Define class meeting patterns.
- Define auto enroll options and capacity.
- Define class reserve capacity.
- Manage enrollment capacity.
- Link class notes to sections.
- Link exam times to classes.
- Define learning management system (LMS) data for classes.
- Define textbooks for classes.
- Interface class sections with the general ledger.

Understanding New Class Scheduling

Student Records possesses a great feature for easing your data entry in the schedule of classes. The four primary components are: Schedule New Course, Schedule of Classes, Schedule Class Meetings, and Update Sections of a Class. The components are identical, except that their search mechanisms differ.

In the Schedule New Course component you can view *all* courses from the course catalog that can be scheduled. In the Schedule of Classes component you can view *only* those courses that have been scheduled for a term. In the Schedule Class Meetings component you can view the Meetings page, the Enrollment Cntrl (enrollment control) page, and the Exam page, and make edits without accessing the entire class and all of its sections in the schedule of classes. In the Update Sections of a Class component you can view *only* individual class sections of a course that have been scheduled for a term.

We review the Schedule New Course component first, because it is where you begin.

To schedule a class:

1. Define sections, special class fees, topics, attributes, and course administrator information on the Basic Data page.
2. Enter class meeting times, days, facilities, instructors, and room characteristics on the Meetings page.

3. Define class status, capacity, auto enroll, and resection to section numbers on the Enrollment Cntrl page.
4. Define reserve capacity and enrollment requisites on the Reserve Cap (reserve capacity) page.
5. Link notes to class sections on the Notes page.
6. If you are manually scheduling exams for class sections, enter exam information on the Exam page.
7. Define textbook assignments for each class section on the Textbook page.
8. Assign classes (class item types) to specific general ledger accounts on the GL Interface page.

Prerequisites

Before you can schedule a new class, you must:

- Define your academic calendar, repeat rules, and course catalog.
- Define your facility IDs, topic IDs, and your instructor workload assignment types (if applicable).
- Define your reserve capacity enrollment requirement groups (if applicable).
- Define your note numbers (if applicable).
- Define your exam time codes and exam types (if applicable).
- Define your course material type values.
- Define your GL values.

Pages Used to Schedule a Class

<i>Page Name</i>	<i>Definition Name</i>	<i>Navigation</i>	<i>Usage</i>
Schedule of Classes - Basic Data	CLASS_ENTRY	<ul style="list-style-type: none"> • Curriculum Management > Schedule of Classes > Schedule New Course > Basic Data • Curriculum Management > Schedule of Classes > Maintain Schedule of Classes > Basic Data 	Define sections, add specific class fees, topics, attributes, and designate a course administrator.
Associated Class Attributes	SSR_ASSOC_CAF	Click the Associated Class Attributes link on the Basic Data page.	Add class association attributes.
Class Fees Modal	CLASS_FEE_TBL_MDL	Click the Add Fee button on the Schedule of Classes - Basic Data page.	Enter the charge method for the component of the class.

Page Name	Definition Name	Navigation	Usage
Class Sub Fees Modal	CLASS_SUBFEE_MDL	Click the Add Fee button on the Schedule of Classes - Basic Data page.	Enter the details of the course fee.
Schedule of Classes - Meetings	CLASS_MTG_PATTERN	<ul style="list-style-type: none"> • Curriculum Management > Schedule of Classes > Schedule New Course > Meetings • Curriculum Management > Schedule of Classes > Maintain Schedule of Classes > Meetings 	Define class meeting patterns and facilities, link instructors to classes, assign instructor workload values, specify room characteristics, and select academic shifts.
Instructor Contact Hours	CLASS_MTG_PAT_HRS	Click the Contact Hours link on the Meetings page.	Review total course contact hours, weeks of instruction, and other contact hours information.
Combined Section Detail	CLASS_CMBND_SEC	If available, click the Combined Sections link on the Meetings or Enrollment Cntrl page.	Review all of the classes in the combined section
Schedule of Classes - Enrollment Cntrl (enrollment control)	CLASS_ENRL_CNTL	<ul style="list-style-type: none"> • Curriculum Management > Schedule of Classes > Schedule New Course > Enrollment Cntrl • Curriculum Management > Schedule of Classes > Maintain Schedule of Classes > Enrollment Cntrl 	Set enrollment limits and capacity requirements, and identify sections for which you want the system to auto enroll students.

Page Name	Definition Name	Navigation	Usage
Reserve Cap (reserve capacity)	CLASS_RSRV_CAP	<ul style="list-style-type: none"> • Curriculum Management > Schedule of Classes > Schedule New Course > Reserve Cap • Curriculum Management > Schedule of Classes > Maintain Schedule of Classes > Reserve Cap 	Assign reserve capacities for class sections. You can define any number of reserve capacity groups for a class. Reserve capacities are defined through the Enrollment Requirement Group component. When a student enrollment request is processed, the system automatically searches through the reserve capacities in sequential order and places the student in the first group with an available spot for which the student qualifies based on the reserve capacity group rules.
Class Enrollment Capacity Sync	SSR_CLSMTGCAP_SYNC	Curriculum Management > Schedule of Classes > Class Enrollment Capacity Sync	Review and manage enrollment capacities against facility and requested room capacities.
Schedule of Classes - Notes	CLASS_NOTES	<ul style="list-style-type: none"> • Curriculum Management > Schedule of Classes > Schedule New Course > Notes • Curriculum Management > Schedule of Classes > Maintain Schedule of Classes > Notes 	Link existing class notes or free-form text notes to class sections.
Exam	CLASS_EXAM	<ul style="list-style-type: none"> • Curriculum Management > Schedule of Classes > Schedule New Course > Exam • Curriculum Management > Schedule of Classes > Maintain Schedule of Classes > Exam 	Manually schedule final exams for class sections.

Page Name	Definition Name	Navigation	Usage
Textbook	SSR_CLASS_TEXTBOOK	<ul style="list-style-type: none"> • Curriculum Management > Schedule of Classes > Schedule New Course > Textbook • Curriculum Management > Schedule of Classes > Maintain Schedule of Classes > Textbook 	Assign textbooks to class sections.
LMS Data	CLASS_LMS_SETUP	<ul style="list-style-type: none"> • Curriculum Management > Schedule of Classes > Schedule New Course > LMS Data • Curriculum Management > Schedule of Classes > Maintain Schedule of Classes > LMS Data 	Enter LMS information for this class.
GL Interface	CLASS_TBL_GL	<ul style="list-style-type: none"> • Curriculum Management > Schedule of Classes > Schedule New Course > GL Interface • Curriculum Management > Schedule of Classes > Maintain Schedule of Classes > GL Interface 	Map class section fees as item types to their proper General Ledger accounts. The system generates charges to the student's account based on the class and course code that you define in this component and offsets these charges based on the General Ledger that you define in this page. Your office needs to coordinate the information on this page with your controller's office.
Journal Set ChartFields	SSF_CF_WRKGRID_SEC	Click the Jrnl Set ChartFields link on the GL Interface page.	Continue to enter ChartField information that maps class section fees to their proper General Ledger accounts.

Defining Basic Data for Class Sections

Access the Schedule of Classes - Basic Data page (**Curriculum Management > Schedule of Classes > Schedule New Course > Basic Data**).

This example illustrates the fields and controls on the Schedule of Classes - Basic Data page. You can find definitions for the fields and controls later on this page.

Basic Data	Meetings	Enrollment Cntrl	Reserve Cap	Notes	Exam	LMS Data	Textbook	GL Interface	
Course ID:	007129	Course Offering Nbr:	1						
Academic Institution:	PeopleSoft University	Term:	2010 Spring	Undergrad					Auto Create Component
Subject Area:	HISTORY	Catalog Nbr:	100	History					
				Perspectives on the Present					
Class Sections Find View All First 1 of 3 Last									
*Session:	1	Regular Academic Session	Class Nbr:	2774					<input type="button" value="+"/> <input type="button" value="-"/>
*Class Section:	1		*Start/End Date:	24/01/2010	08/05/2010				
*Component:	LEC	Lecture	Event ID:	000021918					
*Class Type:	Enrollment								
*Associated Class:	1	Units:	3.00	Associated Class Attributes					
*Campus:	MAIN	Main	<input type="button" value="Add Fee"/>						
*Location:	PSCSHCDA	Hacienda	<input checked="" type="checkbox"/> Schedule Print						
Course Administrator:		<input type="checkbox"/> Student Specific Permissions							
*Academic Organization:	HISTORY	History	<input checked="" type="checkbox"/> Dynamic Date Calc Required						
Academic Group:	LBART	College of Liberal Arts	<input type="checkbox"/> Generate Class Mtg Attendance						
*Holiday Schedule:	PSS	Academic Holiday Schedule	<input checked="" type="checkbox"/> Sync Attendance with Class Mtg						
*Instruction Mode:	P	In Person	<input type="checkbox"/> GL Interface Required						
Primary Instr Section:	1								
Class Topic									
Course Topic ID:		<input type="checkbox"/> Print Topic in Schedule							
Equivalent Course Group									
Course Equivalent Course Group:		<input type="checkbox"/> Override Equivalent Course							
Class Equivalent Course Group:									
Class Attributes Personalize Find View All First 1 of 1 Last									
*Course Attribute		*Course Attribute Value							

Field or Control	Description
Auto Create Component	If you click this button, the system automatically creates one component for each of the components that you selected to auto create on the Course Catalog - Components page. The system populates the pages in the schedule of classes with the required data for each component. This saves you data entry and ensures that one section for each component is scheduled. If you have multiple class sections for each component type, you must still define the remaining class sections manually.

Field or Control	Description
Class Section	<p>For each component that the system creates automatically, enter the class section number. The system defaults into the Class Schedule Entry page the field values of the preexisting class section.</p> <hr/> <p>Note: If you have begun to schedule sections of a course and you then click the Auto Create Component button, the process only creates a section for those components that are set to <i>Auto Create</i> on the course catalog and have not yet been scheduled.</p>
Session	<p>Enter the type of session to which the class sections of this course offering belong. If you want to schedule open entry/exit class sections, you must define them within an <i>OEE</i> session. Session values are delivered with your system as translate values. You can modify the codes and descriptions of these values except for <i>OEE</i>, where you can modify the descriptions only. Any modification to this code requires a substantial programming effort. In order for students to enroll in the <i>OEE</i> class sections that you define, you must either define the <i>OEE</i> Dynamic Date rule for each class section on the Dynamic Class Dates page or the Course Catalog - Offerings page.</p>
Class Nbr (class number)	<p>The system creates a unique class number identifier that students can use when they enroll in a class. The class number appears on the Schedule of Classes report. The system increments this number automatically, based on the number that you specify on the Term Value page.</p>
Class Section	<p>Enter the class section. It must be unique within course offering and session.</p>
Start/End Date	<p>The system populates this field by default to the start and end dates of the session (as specified on the Session Table page). You can override the dates for an individual class. The schedule of classes start and end dates can extend beyond the boundaries of the session begin and end dates.</p>
Component	<p>The system populates this field by default to the graded component on the Catalog Data page (such as <i>Lecture</i>, <i>Laboratory</i>, <i>Discussion</i>, and so on) of the course. You can have multiple components and sections within a course offering.</p>

Field or Control	Description
Class Type	<p>The class type of <i>Enrollment</i> indicates which section is the primary section at enrollment time. The class type of <i>Non-Enrollment</i> is used to indicate that the section choice is the student's secondary enrollment option, or that the section is used in auto-enrollment. Within a class, only one component can possess the class type of <i>Enrollment</i>.</p> <p>For example, at PSUNV Microbiology 240 has <i>Lecture</i>, <i>Laboratory</i>, and <i>Discussion</i> components. There are 5 lecture, 10 laboratory, and 15 discussion sections. We might select the discussion sections as the <i>Enrollment</i> sections, the lecture sections as the <i>Non-Enrollment</i> section using auto-enrollment, and the laboratory sections as <i>Non-Enrollment</i> sections with a student choice of lab section at enrollment time.</p>
Associated Class	<p>Select an associated class number from the list box, or enter an associated class value of your own. By using associated class numbers, you link class sections that constitute a single course offering. For instance, in our previous example, we'd gather a certain number of lecture, lab, and discussion sections into one associated class number to indicate that the three components are related to one another. If you are scheduling a new section, the system populates the Associated Class field to <i>1</i> by default.</p> <p>When you schedule the first section of a course offering and use the prompt box, the system only displays this default value. You can use a prompt value, or you can manually enter any new one- to four-digit number into the field. Upon saving the page, the system extracts the necessary course data from the course catalog, creates a row in the Class Associations component for this class association number, and populates the row with the appropriate course catalog data. When a student enrolls in a class, the system verifies that the student has enrolled in a section with all required components of the course from within the same associated class number.</p> <p>If you add a new class associations value to a scheduled class, and you want to make changes to the class association data that the system extracts from the course catalog, you must make your changes on the Class Associations component.</p> <p>A special associated class number, <i>9999</i>, enables you to associate a section with any other section. However, you can only use this associated class number for nongraded components.</p>
Associated Class Attributes	<p>Click to access the Associated Class Attributes page and add class associations attributes.</p> <p>See Adding Class Association Attributes Using the Schedule of Classes Component</p> <p>See Defining Class Associations</p>

Field or Control	Description
Units	<p>The units value is a related display based on the unit range defined on Class Associations component. When first scheduling a course, the system populates the Associated Class field to 1 by default. Once the section is saved, the unit value is defaulted from the Course Catalog to the Associated Class and is displayed on the Schedule of Classes. If the class association unit range is modified, the assigned unit value is accurately reflected on the Schedule of Classes.</p> <p>On subsequent pages within the Schedule of Classes, the unit range is displayed within the Class Sections group box.</p>
Campus	<p>The system populates the Campus field by default from the Course Catalog - Offerings page, indicating the campus that offers the course. You cannot revise this default. If a specific campus was not identified in the course catalog and does not default, then you can, on a section-by-section basis, schedule classes at various campuses.</p> <hr/> <p>Note: Because you cannot revise the campus value if one was provided on the course catalog level, it is best if you do not identify a specific campus on the Course Catalog - Offerings page unless absolutely necessary.</p> <hr/>
Location	<p>Enter the location of the campus. Location values are linked to campuses on the Campus Table page. A campus must be specified before you select a location.</p>
Course Administrator	<p>Select the course administrator ID of the person in charge of the course (usually the primary instructor). This field is informational only.</p>
Academic Organization	<p>The system populates the academic organization by default from the Course Catalog - Offerings page. The academic organization refers to the organization that offers the class. You can override this value.</p>
Academic Group	<p>The system populates the academic group by default from the Course Catalog - Offerings page.</p> <hr/> <p>Note: You can define global notes by academic group, which can appear on the Schedule of Classes report. In addition, academic group controls the valid meeting pattern values and their corresponding normal class duration values.</p> <hr/>

Field or Control	Description
Instruction Mode	<p>The system populates this field by default to <i>In Person</i>, but you can override the value. The instruction mode indicates whether the class is taught <i>In Person</i> or using <i>Interactive TV</i>, <i>World Wide Web</i>, <i>Correspondence</i>, and so on. Instruction mode values are defined on the Instruction Mode page.</p> <hr/> <p>Important! You can generate attendance rosters for only those classes with an instruction mode value of <i>P</i>.</p> <hr/>
Primary Instr Section (primary instructional section)	<p>Enter the primary instructional section number if applicable. This field is specifically used for distance learning classes. You can use this field to indicate in which section the instructor resides. This field is for informational purposes only.</p>
Schedule Print	<p>The setting of this check box populates by default to the setting on the Course Catalog - Offerings page. Select this check box to display the class in the schedule of classes. If you clear this check box, the section does not display in student or visitor class search when accessed through PeopleSoft Campus Self Service. Students can enroll in these classes, but only if they enter the exact class number (without using the class search feature).</p>
Student Specific Permissions	<p>Select this check box to set up student-specific class permissions.</p> <p>Student-specific permissions enable instructors or administrators to control section enrollment by granting advance add permission to individual students.</p> <hr/> <p>Note: This applies only to add permissions. Drop permissions are always student specific, whether or not the check box is selected.</p> <hr/>

Field or Control	Description
<p>Include in Dynamic Date Calc (include in dynamic date calculation)</p>	<p>Select this check box to include this component of the class section in the Dynamic Class Dates process. The value that you select here populates by default from the corresponding field for the course offering component on the Course Catalog - Components page. For nonprimary components of a course offering, this check box is optional. You can override the default value on a section-by-section basis. For primary components, however, the system automatically selects and makes unavailable this check box because the Dynamic Class Dates process always uses the scheduled class section of the primary component to calculate the landmark dates on a dynamic academic calendar. The process uses for the primary component the value as defined on the Class Associations - Class Components page. If you decide to include additional components of the class section in the Dynamic Class Dates process calculations, the process includes in its calculations the meeting times that fall within the start date and end date range of the primary component.</p> <p>For example, the lecture section is the primary component. The start and end dates for the lecture are 10 weeks apart, with the lecture meeting every Monday. For the dynamic class date rule, you use a rule scheme for drop dates that is based on the number of class meetings, and that each subsequent class meeting defines the next level drop deadline. If you include only the lecture in the Dynamic Class Date process calculations, the first drop deadline would be the second lecture, the second drop deadline would be the third lecture, and so on. However, you may also have a discussion component that meets once every Thursday for 10 weeks, starting the same week as the lecture. If you select to also include the discussion in the calculations, the first drop deadline would be the first discussion because it is the second class meeting. The second drop deadline would be the second lecture, the third drop deadline the second discussion, and the final drop deadline the third lecture.</p>
<p>Dynamic Date Calc Required (dynamic date calculation required)</p>	<p>The system automatically selects this check box whenever you make a change to the class meeting pattern or class dates of a class section within a dynamically dated session because these changes can potentially impact the Dynamic Class Date process calculations. When you run the Dynamic Class Dates process using the Process Scheduler (Dynamic Class Dates page), you have the option to use this field as a parameter.</p> <p>You can thus, for example, recalculate the landmark academic calendar dates for only the classes in which the class meeting pattern has been changed.</p> <p>See“Understanding Dynamic Academic Calendars” (Campus Solutions Application Fundamentals)</p> <p>See“Creating Dynamic Class Date Rules” (Campus Solutions Application Fundamentals)</p> <p>See“Creating Dynamic Academic Calendars by Term” (Campus Solutions Application Fundamentals)</p>

<i>Field or Control</i>	<i>Description</i>
Generate Class Mtg Attendance (generate class meeting attendance)	Select this check box to indicate that you want the system to always generate attendance rosters for this class. This value defaults from the Course Catalog - Components page each time that you schedule a new course. By selecting this check box, you flag the class so that when you generate attendance rosters through the Attendance Roster Generator page and you select the Obey Generate Class Mtg Attendance check box, the generator creates attendance rosters only for classes that have this flag selected and that meet your processing criteria. If you clear this check box on the Attendance Roster Generator page, the system generates attendance rosters for all classes that meet your processing criteria, regardless of the check box setting on the Basic Data page. You can generate attendance rosters through the Class Attendance page regardless of this check box value.
GL Interface Required	Select this check box to include this class in the GL Interface process. If you select this check box, you must enter the necessary data into the GL Interface page of this component.

<i>Field or Control</i>	<i>Description</i>
Add Fee	To add a class section fee, you must click the Add Fee button for each new class section.

Class Topic

<i>Field or Control</i>	<i>Description</i>
Course Topic ID	Enter a course topic ID to link course topics to class sections. Select a topic ID for the section. Topic ID values are defined on the Catalog Data page. Additionally, you can also attach topics to specific class meeting patterns.
Print Topic in Schedule	<p>If you enter a topic ID, this check box becomes available for entry. The system selects this check box by default. You can change the setting.</p> <hr/> <p>Note: In order for the topic to appear on the transcript, you must select the Print Course Topic check box on the Transcript Type - Enrollment/Statistics page.</p> <hr/>

Equivalent Course Group

<i>Field or Control</i>	<i>Description</i>
Course Equivalent Course Group	If the course is linked to an equivalent course group on the Catalog Data page, the system displays that information in this field and the Override Equivalent Course check box becomes available for entry.
Override Equivalent Course	Select to override the Catalog Data setting for this class section.
Class Equivalent Course Group	Enter another equivalent course group for the class section in this field.

Class Attributes

<i>Field or Control</i>	<i>Description</i>
Course Attributes and Course Attribute Value	<p>Use the Course Attributes field to link attributes to class sections. The system populates this field and the related course attribute values from the course catalog. You can override or amend these values. Values for course attributes are defined on the Catalog Data page.</p> <hr/> <p>Note: Course attributes are used primarily for institutional research and reporting purposes and to print repetitive text in the course catalog and schedule of classes. Course attributes are not used by the Academic Advisement application.</p> <hr/>

Adding Class Association Attributes Using the Schedule of Classes Component

Access the Associated Class Attributes page (click the **Associated Class Attributes** link on the Basic Data page).

This example illustrates the fields and controls on the Associated Class Attributes page. You can find definitions for the fields and controls later on this page.

Associated Class Attributes

Course ID: 666880	Course Offering Nbr: 1
Academic Institution: PSUNV PeopleSoft University	Class Section: 2
Term: 0690 2012 Fall	Session: Regular
Subject Area: ECON Economics	Associated Class: 2
Catalog Nbr: 113 Latin America	

Find First 1-2 of 2 Last

+ -

***Attribute** Student Language

SP Spanish

+ -

***Attribute** Student Shift

1 First Shift

Use this page to add Class Association attributes as you add new class sections or maintain existing class sections.

Field or Control	Description
Attribute	The name of the attribute. This value comes from the description of the attribute on the Common Attribute component.
Value	This field changes depending on the type of attribute. This could be a numeric, date, time or text field. Alternatively, the field could prompt against a list of values if one has been defined for the attribute.

See [Defining Class Associations](#)

See “Defining a Common Attribute” (Campus Community Fundamentals)

Entering Class Fee Information

Access the Class Fees Modal page (click the **Add Fee** button on the Schedule of Classes - Basic Data page).

Enter the charge method for the component of the class. These values are set up in PeopleSoft Student Financials tables.

The check box options enable you to specify when the system charges fees.

Class Sub Fees Modal

Access the Class Sub Fees Modal page (click the **Add Fee** button on the Schedule of Classes - Basic Data page).

Enter the details of the course fee in this page. You are prompted from tables set up in the Student Financials application.

See “Defining Class Fees” (Student Financials).

Defining Class Meeting Patterns

Access the Schedule of Classes - Meetings page (**Curriculum Management > Schedule of Classes > Schedule New Course > Meetings**).

This example illustrates the fields and controls on the Schedule of Classes - Meetings page. You can find definitions for the fields and controls later on this page.

Basic Data		Meetings		Enrollment Cntrl		Reserve Cap		Notes		Exam		LMS Data		Textbook		GL Interface					
Course ID:	003300	Course Offering Nbr:	1																		
Academic Institution:	PeopleSoft University																				
Term:	2014 Spring	Undergrad																			
Subject Area:	ENGLLIT	English Literature																			
Catalog Nbr:	263	Lit and History																			
Class Sections																Find	View All	First	1 of 2	Last	
Session:	1	Regular Academic Session	Class Nbr:	1095																	
Class Section:	1	Component: Lecture	Event ID:																		
Associated Class:	1	Units: 3.00																			
Meeting Pattern																Find	View All	First	1 of 1	Last	
Facility ID	Capacity	Pat	Mtg Start	Mtg End	M	T	W	T	F	S	S	*Start/End Date									
KING100	50	TR	8:00AM	9:20AM	<input type="checkbox"/>	<input checked="" type="checkbox"/>	<input type="checkbox"/>	<input checked="" type="checkbox"/>	<input type="checkbox"/>	<input type="checkbox"/>	<input type="checkbox"/>	24/01/2014	08/05/2014								
King 100	Topic ID:	Free Format																			
	Topic:																				
<input type="checkbox"/> Print Topic On Transcript																Contact Hours					
Instructors For Meeting Pattern																Personalize	Find	View All	First	1 of 1	Last
Assignment		Workload																			
ID	Name	*Instructor Role	Print	Access	Contact	Empl Red#	Job Code														
SR12101	Litman,Edward	Prim Ins	<input checked="" type="checkbox"/>	Post		0	420025														
Room Characteristics																Personalize	Find	First	1 of 1	Last	
*Room Characteristic															*Quantity	1					
Academic Shift																Personalize	Find	First	1 of 1	Last	
Academic Shift																					
EVENING	Evening Shift																				

Note: For institutions that schedule large numbers of sections of a class and have facility conflict check activated, use the Schedule Class Meetings component to schedule facility and meeting pattern information. Because the system only performs edit checks on an individual class section (rather than for all the sections of the class), you benefit from faster performance. To use the Schedule Class Meetings component to schedule facility and meeting pattern information, enter all information for the class, except facility and meeting pattern in the Schedule of Classes or Schedule New Course components. Then go to the Schedule Class Meetings component, enter the subject and catalog number for the class, select the first section, and then update the facility/meeting pattern information one section at a time, using the **Next in List** button on the tool bar to scroll through all the sections for the course. Multiple views of this page are available by clicking the tabs in the scroll area. We document fields common to all views first.

Common Page Information

<i>Field or Control</i>	<i>Description</i>
Event ID	The system creates a unique event ID record in the Event table when you schedule a class with a meeting pattern and facility ID. The Event table is used to record class and non-class events for room scheduling.
Facility ID	Enter a facility ID for the class. Facility values are defined on the Facility Table page. To show warning or rejection messages when the schedule or enrollment capacity exceeds the requested facility or room capacity limit, see “Setting Academic Institution Defaults and Options” (Campus Solutions Application Fundamentals).
Capacity	The system populates this field by default to the setting on the Facility Table page.
Pat (pattern)	Enter the class meeting pattern. Meeting patterns associated with the academic group for the class are available. Meeting pattern values are defined on the Academic Group Table - Standard Meeting Pattern page. Note: It is important that you enter the most important meeting pattern first. In some places in the system when viewing classes you can only see the meeting pattern which was entered first. Also, the system assigns a final exam code based on the first class meeting pattern.
Mtg Start (meeting start) and Mtg End (meeting end)	Enter the class meeting start and end times. The system defaults an end time after you enter a start time, based on the default Normal Class Duration set on the Academic Group table - Standard Meeting Pattern page.

Field or Control	Description
<p>M (Monday), T (Tuesday), W (Wednesday), T (Thursday), F (Friday), S (Saturday), and S (Sunday)</p>	<p>The system populates the meetings days by default based on what you enter in the Pat field.</p>
<p>Start/End Date</p>	<p>For the first meeting, the system populates these fields to the start and end date from the Session table. For all subsequent meetings you add, the system populates this field to the start and end dates on the Basic Data page. The meeting start and end dates must be assigned within the start and end date range assigned to the class on the Basic Data page.</p>
<p>Topic ID</p>	<p>Select a class topic ID for this class meeting pattern. For example, at PSUNV, ENGLLIT 299 meets on MWF and TTH. The MWF class covers "The Mystery Genre," while the TTH class covers "British Influence on US Writers." You can also link class topics to entire classes on the Basic Data page. Topic IDs are defined on the Catalog Data page.</p>
<p>Free Format Topic</p>	<p>Enter a free format topic if a predefined topic ID is not suitable. For example, if a professor wants to teach ENGLLIT 299 as "19th Century Novelists," but the topic had not been set up as a topic ID, you could enter it as a free format topic. You can only link free format topics to class meeting patterns.</p> <hr/> <p>Note: You cannot assign class meeting pattern topic IDs to combined sections. This would cause data integrity problems. For this reason, after sections are combined, the system makes the Topic ID field unavailable on the Meetings page. Instead, only assign free format topics to combined sections. In addition, if you combine sections that already have class meeting pattern topic IDs assigned to them, the system deletes the topic IDs.</p> <hr/> <p>See Creating Combined Sections.</p>

Field or Control	Description
Print Topic On Transcript	<p>Select this check box to allow course topics to appear on the advisement report.</p> <p>Course topics defined at the class meeting pattern must have this check box selected, as well as the Display Topics in AA Reports check box on the Transcript Type - Basic Data page, for the class meeting topic to appear.</p> <p>See Designating Enrollment and Statistics Data.</p> <hr/> <p>Note: Selecting this check box allows the class meeting pattern topic to be printed on both transcripts and advisement reports. To allow the topic to print on only one of the reports, correctly set the option to print topics on the transcript type for each report type.</p> <hr/>
Contact Hours	<p>Click to access the Instructor Contact Hours page, where you can review total course contact hours, weeks of instruction, and other contact hours information.</p>
Course Contact Hours	<p>Derived from the course catalog.</p>
Weeks of Instruction	<p>Derived from the Session table.</p>
Total	<p>Equals the course contact hours multiplied by the weeks of instruction.</p>
Total Course Contact Hours (Actual)	<p>Calculated from the class meeting pattern. Equals the sum of the end time minus the start time for every meeting date, excluding holidays. The system only calculates this value for the graded component if a facility is booked for the class.</p>
Combined Section	<p>Click to access the Combined Section Detail page, where you can view all of the classes in the combined section. This link only appears for combined classes.</p> <hr/> <p>Note: After you combine classes, you must perform updates to meeting pattern and instructor information through the Schedule Class Meetings - Meetings page. Within the Schedule of Classes and Schedule New Course components, the facility/meeting pattern and instructor information is unavailable for entry for combined sections.</p> <hr/>

Assignments Tab

See the Meetings page exhibit for a view of this tab.

Field or Control	Description
ID	<p>Enter the ID of the instructor for the course. The system prompts you from the Personal Data view or one of seven Instructor/Advisor views. The prompt values depend on:</p> <ul style="list-style-type: none"> • The Edit Instructor Against option and the Assign Instructor By check box that your institution selects on the Academic Organization Table page for the academic organization to which this class belongs. • The Edit Instructor Against option and the Assign Instructor By check box that your institution selects on the Academic Organization Table page for the academic organization to which this class belongs. <p>You can associate one or more instructors with each meeting pattern. The system carries forward the instructor ID from the previous meeting pattern when you add a new meeting pattern. Override the instructor ID if necessary.</p> <hr/> <p>Note: In order to accommodate the Instructor Workload feature, a single instructor may be assigned to more than one row, although this may not be common practice. For example, you may want to assign instructor A to teach 50 percent load factor with an assignment type of Internet, and another 50 percent load factor with an assignment type of <i>In Class Lecture</i>.</p> <hr/> <p>See Walking Through Instructor Workload</p>
Instructor Role	<p>Enter the instructor role for the corresponding ID number. Values for this field are delivered with your system as translate values. You can modify these values. Insert rows to add multiple instructors and their corresponding instructor roles.</p> <hr/> <p>Note: For independent study courses for which the student can select one of several instructors, assign multiple instructors the <i>Primary</i> instructor role. If you select an Instructor Edit field value of <i>Class Instructor Edit</i> on the Class Associations page, only the primary instructors defined for the class on the Meetings page display on the Enrollment Request page during enrollment.</p>

Field or Control	Description
Print	Select to display the instructor's name on the Schedule of Classes report. The system populates this check box by default to the setting on the Course Catalog - Offerings page.
Access	<p>Enter the grade roster access for this instructor. Values for this field are delivered with your system as translate values. Do not modify these values in any way. Any modifications to these values require a substantial programming effort. The values work in hierarchical fashion:</p> <p><i>Approve:</i> Instructor can enter grades and approve the grade roster.</p> <p><i>Grade:</i> Instructor can only enter grades for the class.</p> <p><i>Post:</i> Instructor can enter grades, approve the roster, and post the grades.</p>
Contact	The values you enter in this field have no impact elsewhere in the system. The Contact field on this page has no programming tied to it, and does not relate to the delivered Instructor Workload feature in any way.
Empl Rcd# (employee record number)	Relates job information to instructors for reporting purposes. In addition, the system displays a warning message if the FULL_PART_TIME value on the job does not coincide with the same field value on the instructor assignment class record related to the instructor assignment class on the Term Workload page.
Job Code	Displays the value specified on the Accommodations page for a particular employee record.

Workload Tab

Select the Workload tab.

Field or Control	Description
Assign Type (assignment type)	Appears on this page if the Calculate Workload check box is selected on the Academic Institution 4 page. The system populates the field by default from the Academic Institution 4 page and can be overridden. Only those assignment types current as of the term begin date and with the View on Schedule of Classes check box selected are available.
App Load (apply load)	Appears on this page if the Calculate Workload check box is selected on the Academic Institution 4 page. The check box indicates whether the assignment counts toward an individual's total term full time equivalent (FTE) percentage. The field corresponds to the Include Assignment in Workload check box on the Assignment Type page and cannot be overridden. The only way to change the setting of this check box is to select a different assignment type.
Load Factor	If desired, you can use this field to divide one course component into multiple assignments across instructors. Inserting multiple rows per course component and assigning each one a load factor (percent) enables you to divide a component into different assignment types among instructors. For example, you can assign instructor A to teach 30 percent of the lecture component, and instructor B to teach 70 percent of the lecture component. It is your responsibility to set the load factor. The total load factor on one course component should equal 100 percent. The system displays a soft warning message if the total does not equal 100 percent.
Work Load	In order to provide maximum ease in assigning workload hours to individuals, the system auto calculates default workload hours when you schedule classes. The system bases calculations on the academic progress units or course component workload hours for the class (set up on the class association and class component pages), multipliers both per subject/component and per instructor, and load factor. The Work Load field stores the resultant workload hours. Manual modifications to work load hours are enabled and effect the Assigned FTE%. See Course Component Workload Hours Formula .

Field or Control	Description
<p>Auto Calc (automatic calculation)</p>	<p>Appears on this page if the Calculate Workload check box is selected on the Academic Institution 4 page. Select this check box if you want to have the workload value recalculated any time the user manually updates assignment type or load factor. The default is selected.</p> <hr/> <p>Note: Manually entering a value in the Work Load field clears the Auto Calc check box so that the manual entry is not overridden automatically if you change the assignment type or load factor. You can select the Auto Calc check box again; however, doing so recalculates workload.</p> <hr/>
<p>Assignment FTE% (assignment full time equivalency percentage)</p>	<p>Appears on this page if the Calculate Workload check box is selected on the Academic Institution 4 page. This value represents the particular assignment's weight based on the 100 percent weekly workload hours or the 100 percent OEE workload hours for the assignment type. For example, if the assignment type <i>Lecture</i> has 100% weekly workload hours set to 15, and you assign an instructor to teach a 3 hour lecture component with an assignment type of <i>Lecture</i>, the assignment FTE % is 20 (because 3 hours out of 15 makes 20%).</p> <p>It is calculated and cannot be modified by the user.</p>

Room Characteristics

Field or Control	Description
<p>Room Characteristic and Quantity</p>	<p>Use the Room Characteristic field to link room characteristics to classes. The system populates the Room Characteristic field and the Quantity field from the Course Catalog - Components page. You can override these values. The Room Characteristic field is used for interfacing to the Universal Algorithm's product, Schedule25. The maximum quantity of room characteristics for Schedule25 is 96. Therefore, be sure that you select values between 01 and 96.</p>

Academic Shift

Field or Control	Description
Academic Shift	Select an academic shift (for example, Evening Shift) for a class section. See Defining Class Search Result Options See “Defining Academic Shifts” (Campus Solutions Application Fundamentals) See “Setting Additional Institution Defaults and Options” (Campus Solutions Application Fundamentals) See Maintaining Student Academic Programs

Defining Auto Enroll Options and Capacity

Access the Schedule of Classes - Enrollment Cntrl page (**Curriculum Management > Schedule of Classes > Schedule New Course > Enrollment Cntrl**).

This example illustrates the fields and controls on the Schedule of Classes - Enrollment Cntrl page. You can find definitions for the fields and controls later on this page.

Basic Data	Meetings	Enrollment Cntrl	Reserve Cap	Notes	Exam	LMS Data	Textbook	GL Interface
Course ID:	007129	Course Offering Nbr:	1					
Academic Institution:	PeopleSoft University	Term:	2010 Spring	Undergrad				
Subject Area:	HISTORY	Catalog Nbr:	100	History				
				Perspectives on the Present				
Find View All First 1 of 3 Last								
Session:	1	Regular Academic Session	Class Nbr:	2774				
Class Section:	1	Component: Lecture	Event ID:	000021918				
Associated Class:	1	Units: 3.00						
Class Status:	Active		<input type="button" value="Cancel Class"/>					
Class Type:	Enrollment		Enrollment Status:	Open				
Add Consent:	No Consent		Requested Room Capacity:	35	Total			
Drop Consent:	No Consent		Enrollment Capacity:	35	0			
1st Auto Enroll Section:	<input type="text"/>		Wait List Capacity:	<input type="text"/>		0		
2nd Auto Enroll Section:	<input type="text"/>		Minimum Enrollment Nbr:	<input type="text"/>				
Resection to Section:	<input type="text"/>							
<input checked="" type="checkbox"/> Auto Enroll from Wait List <input type="checkbox"/> Cancel if Student Enrolled								

Field or Control	Description
Class Status	<p>The system populates this field to <i>Active</i> by default. Class status values are delivered with your system as translate values. You can override the status to indicate <i>Stop Further Enrollment</i>, <i>Cancelled Section</i>, or <i>Tentative Section</i>. The Schedule of Classes report enables you to select class status, so that you can print only <i>Active</i> classes, or only <i>Inactive</i> classes, and so on.</p> <hr/> <p>Note: When you select <i>Stop Further Enrollment</i>, <i>Cancelled Section</i>, or <i>Tentative Section</i>, the system sets enrollment status to closed. Classes with class statuses of <i>Stop Further Enrollment</i>, <i>Cancelled Section</i>, or <i>Tentative Section</i> do not appear in class search.</p> <p>The class status of <i>Active</i> has coding attached to it and should not be deleted from the translate table. You can add as many new class status values to the translate table as you want, but they will not have coding attached to them.</p>
Cancel Class	<p>Click to cancel the class in view. The class status must be <i>Canceled Section</i>. The button processes one section cancellation at a time. If you want to cancel multiple sections, you must post your request for each section that you want to cancel.</p> <hr/> <p>Warning! If you want to cancel the section regardless of whether students are enrolled, you must select the Cancel if Student Enrolled check box. Doing so, however, drops any students who are enrolled in the section and requires that you recalculate tuition for those students.</p>
Add Consent and Drop Consent	<p>Values default from the Catalog Data page and indicate the type of consent, if any, that is required to enroll in or drop the class. You can override these values.</p> <p>If you select <i>Instructor</i> or <i>Department</i>, consent is granted either by a permission number or a student specific permission. (Drop permissions are always student specific). The consent requirement can also be overridden during the enrollment process, by selecting the permission override.</p>

Field or Control	Description
Auto Enroll from Wait List	<p>This check box is unavailable for open entry - open exit (OEE) classes (classes tied to an OEE session). Select to enable the COBOL/SQL Wait List process (SRCPWAIT) to move students from the wait list to enrolled status when a space opens up in the section. Spaces become available through enrollment drops or an enrollment capacity increase. Generally, when spaces become available in a section, the class status opens, allowing students to enroll. However, selecting this check box keeps the status closed so that you have time to move students from the wait list into the class by running the wait list process (before other students enroll).</p> <p>If you do not select the Auto Enroll from Wait List check box and you have students on the wait list for the class, when the class status changes to open you cannot use the wait list process to move students from the wait list into the class.</p> <p>You have to move wait listed students into the class manually, and students that are not on the wait list can enroll in the class.</p> <p>See Moving Students from Wait Lists to Enrollment.</p> <hr/> <p>Note: "Enrollment" sections can only auto-enroll "non-enrollment" sections.</p> <hr/>
1st Auto Enroll Section and 2nd Auto Enroll Section	<p>Enter a section within the same associated class number in which the system should automatically enroll students into the 1st Auto Enroll Section and 2nd Auto Enroll section. The auto enroll section must have a different component from the parent section.</p>
Resection to Section	<p>Enter the alternative section in which the system automatically enrolls a student if the primary section is full.</p> <p>The component of the primary section and the resection to section class must be the same. For instance, when Section 1 Lecture is filled, the system enrolls students in Section 3 Lecture.</p>
Cancel if Student Enrolled	<p>Select for the system to process a request for a canceled class section regardless of whether students have already enrolled in the section. If you do not select this check box and you attempt to cancel a section in which students have enrolled, the system prevents you from posting the change, keeping the class status active. Thus, by leaving the box cleared you prevent inadvertently canceling a section in which students are enrolled.</p>

Field or Control	Description
Requested Room Capacity	<p>Enter the requested room capacity for the class. Your room capacity can be different than your enrollment capacity. Because the system stores two separate capacity values, this field enables you to manipulate the enrollment capacity without affecting room scheduling. The system populates the Requested Room Capacity field by default from the default section size on the Course Catalog - Components page. This field is useful for you especially if you use Universal Algorithm's Schedule25 software.</p> <p>For more information about the interface between Universal Algorithm's Schedule25 software and PeopleSoft Campus Solutions, see your Schedule25 documentation.</p>
Enrollment Capacity	The system populates the enrollment capacity by default from the default section size on the Course Catalog - Components page.
Wait List Capacity	Enter the wait list capacity for the section to indicate the maximum number of students you want to allow to wait list for the class.
Minimum Enrollment Nbr (minimum enrollment number)	Enter the minimum enrollment number in order for the section to be offered. If the minimum enrollment number is not realized you might decide to cancel the section. This field is for informational purposes only.
Total	The system displays the current total of students enrolled and on the wait list for the section.
Combined Section	<p>Click to access the Combined Section Detail page, where you can view all of the classes in the combined section. This link only appears for combined classes.</p> <hr/> <p>Note: After you combine classes, you must perform updates to meeting pattern and instructor information through the Schedule Class Meetings - Meetings page. Within the Schedule of Classes and Schedule New Course components, the facility/meeting pattern and instructor information is unavailable for entry for combined sections.</p> <hr/>

Defining Class Reserve Capacity

Access the Reserve Cap page (**Curriculum Management > Schedule of Classes > Schedule New Course > Reserve Cap**).

This example illustrates the fields and controls on the Schedule of Classes – Reserve Cap page. You can find definitions for the fields and controls later on this page.

Basic Data		Meetings		Enrollment Cntrl		Reserve Cap		Notes		Exam		LMS Data		Textbook		GL Interface			
Course ID:	007129			Course Offering Nbr:	1														
Academic Institution:	PeopleSoft University																		
Term:	2010 Spring			Undergrad															
Subject Area:	HISTORY			History															
Catalog Nbr:	100			Perspectives on the Present															
Class Sections																Find View All		First 1 of 3 Last	
Session:	1			Regular Academic Session				Class Nbr:	2774										
Class Section:	1			Component:	Lecture			Event ID:	000021918										
Associated Class:	1			Units:	3.00														
Reserve Capacity																Find View All		First 1 of 1 Last	
*Reserve Capacity Sequence:				<input type="text" value="1"/>		Enrollment Total:				<input type="text" value="0"/>									
Reserve Capacity Requirement Group																Customize Find		First 1 of 1 Last	
*Start Date	*Requirement Group			Cap Enrl															
<input type="text"/>	<input type="text"/>			<input type="text" value="0"/>															

Field or Control	Description
Reserve Capacity Sequence	The system creates the reserve capacity sequence number indicating the order in which it evaluates the sets of requirement groups during enrollment. You can change this number. If you want to set up more than one requirement group for more than one start date, you must set up each one under its own sequence number. This is important to note because the system does not combine total cap enrollment values within the same reserve capacity sequence. Instead, the system selects and uses only one requirement group per reserve capacity sequence—the one that has the most current effective date.
Enrollment Total	The total number of students enrolled as part of the reserve capacity sequence.

Field or Control	Description
<p>Start Date and Requirement Group</p>	<p>Enter the effective date for your reserve capacity. This date determines when the enrollment capacity requirement group becomes active. If you enter a subsequent row within the same reserve capacity sequence number, the system references the row with the current effective date and this row overrides all others within the sequence.</p> <p>Select the requirement group for the reserve capacity. Values for requirement groups are defined through the Enrollment Requirement Group component. Students who attempt to enroll in the class and who satisfy the reserve capacity requirement group that you specify can enroll in the class up to the Cap Enrl value, (as long as the enrollment does not exceed the total enrollment capacity that you specify on the Enrollment Control page).</p> <p>In order to set various enrollment capacities, or to discontinue the reserve capacity as of a certain date, you can add rows for the same requirement group with a later effective date. For example, if you want to change a reserve capacity for a class on a specific date, you can add a second row to the sequence with a Start Date value equal to the expiration date, and enter a new enrollment capacity for the row.</p> <p>You can also use this method to <i>expire</i> reserve capacities (instead of deleting the reserve capacity sequence and losing your historical data). Under the same reserve capacity sequence, insert a new effective-dated row with the date that you want the reserve capacity to expire, then enter the same requirement group number and set the enrollment capacity to 0.</p> <hr/> <p>Warning! If you expire (set to 0) the Cap Enrl field value for any reserve capacity sequence row within the section, the system inactivates all reserve capacity sequence values for the section.</p> <hr/>
<p>Cap Enrl (capacity enrollment)</p>	<p>The maximum number of seats that you want to reserve for students who satisfy the requirement group parameters. The system combines the values of the most recent row of each requirement group.</p> <p>The system does not combine this value with other capacity enrollment values within the same sequence number unless the requirement group is different. Otherwise, the system only combines the most current row for each reserve capacity sequence.</p>

Related Links

[Understanding Enrollment Requisite Setup and Maintenance](#)

[Defining Enrollment Requirement Groups](#)

Managing Enrollment Capacity

Access the Class Enrollment Capacity Sync page (**Curriculum Management > Schedule of Classes > Class Enrollment Capacity Sync**).

This example illustrates the fields and controls on the Class Enrollment Capacity Sync page. You can find definitions for the fields and controls later on this page.

Use this page to review the classes where the enrollment capacity is greater than the facility or requested room capacities. Search for the institution and the term, and then retrieve the list of classes.

Field or Control	Description
Enrollment Cap > Facility Cap	Select this option and the classes you want to update, and then click Set Enrollment Cap of Selected Classes to Facility Cap to modify the enrollment capacity so that it matches the facility capacity.
Enrollment Cap > Req Room Cap	Select this option and the classes you want to update, and then click Set Enrollment Cap of Selected Classes to Requested Room Cap to modify the enrollment capacity so that it matches the requested room capacity.

You can enable warning or rejection messages if you want to prevent class enrollments to exceed facility capacities. This applies to administrator overrides, or if students use a class permission number that causes the total class enrollment to exceed facility capacity.

See:

- “Setting Academic Institution Defaults and Options” (Campus Solutions Application Fundamentals)
- [Setting Up Repeat Checking for Academic Institutions](#)

Related Links

[Defining Auto Enroll Options and Capacity](#)

[Defining Facilities and Rooms](#)

Linking Class Notes to Sections

Access the Schedule of Classes - Notes page (**Curriculum Management > Schedule of Classes > Schedule New Course > Notes**).

Field or Control	Description
Sequence Number	The system creates a class notes sequence number. The number determines the display order of the class notes for a section if multiple notes exist. You can override this number.
Print Location	Enter the print location of the note, either <i>Before</i> the class listing, or <i>After</i> it.
Even if Class Not in Schedule	This check box has no programming tied to it.
Note Number	Enter a note number to reference a preexisting note. The note's description appears adjacent to the note number. Note number values are defined on the Class Notes Table page.
Free Format Text	Enter a free format text note.
Copy Note	Click to copy the note number text to the free format text. The note can then be modified to accommodate the class section. This eliminates the note number and note text.
Clear Note	Click to clear the free format text.

Related Links

[Defining Class Notes](#)

Linking Exam Times to Classes

Access the Exam page (**Curriculum Management > Schedule of Classes > Schedule New Course > Exam**).

This example illustrates the fields and controls on the Schedule of Classes – Exam page. You can find definitions for the fields and controls later on this page.

Field or Control	Description
Exam Seat Spacing	If you indicate that a final exam will occur on the Course Catalog - Components page, the system populates the Exam Seat Spacing field by default from that page. It indicates the number of seats between students during the final exam and is for informational purposes only. You can override this number.
Exam Time Code	By entering a predefined exam time code, you save yourself some data entry time for the exam date, time, and facility values. Exam time values are defined on the Exam Code Table page.
Combined Exam	Select to indicate that this exam can share a facility with another exam. Note: Time and facility conflicts with other events, such as regular class meetings, are not permitted—the system performs conflict checking for these. If you do not select the Combined Exam check box, the system verifies that no conflicts exist in room and time period scheduling. The stated room and time period is used for only one class exam.
Exam Date, Exam Start, Exam End, Class Exam Type, and Facility ID	If you do not select an exam time code, you can enter values in the Exam Date, Exam Start, Exam End, Class Exam Type, and Facility ID fields. The system performs facility conflict checking when you save the page.

Defining LMS Data for Classes

Access the LMS Data page ((Curriculum Management > Schedule of Classes > Schedule New Course > LMS Data).

This example illustrates the fields and controls on the Schedule of Classes – LMS Data page. You can find definitions for the fields and controls later on this page.

Basic Data	Meetings	Enrollment Cntrl	Reserve Cap	Notes	Exam	LMS Data	Textbook	GL Interface
Course ID:	007129	Course Offering Nbr:	1					
Academic Institution:	PeopleSoft University							
Term:	2010 Spring							
Subject Area:	HISTORY							
Catalog Nbr:	100							
		Undergrad						
		History						
		Perspectives on the Present						
Class Sections								Find View All
								First 1 of 3 Last
Session:	1	Regular Academic Session		Class Nbr:	2774			
Class Section:	1	Component:	Lecture	Event ID:	000021918			
Associated Class:	1	Units:	3.00					
Learning Management System								
Provider for Authentication	<input type="text"/>							
LMS Extract File Type:	<input type="text" value="XML V1.1 (req to authenticate)"/>							
LMS Extract Group ID:	<input type="text" value="PSUNV-HISTORY-100-SEC1"/>							
LMS URL:	<input type="text"/>							
Last LMS Class Extract Datetm:					Last LMS Enroll Extract Datetm:			

Field or Control	Description
Provider for Authentication	<p>If your institution utilizes the learning management systems feature with self-service user authentication, enter the LMS Authentication Provider. The provider for authentication appears by default according to the provider assigned on the Components page in the Course Catalog component. For instances in which the Components page has no Provider for Authentication, the system uses the setting on the Academic Institution 3 page. The LMS Authentication is designed to be used with the XML V1.1 LMS Extract File Type. Providers are defined on LMS Provider Setup page.</p> <p>PeopleSoft Campus Self Service provides a direct link for enrolled students and the instructor to the third-party web site for classes assigned an LMS Authentication Provider.</p>
LMS Extract File Type (learning management system file type)	<p>If your institution utilizes the learning management systems feature, enter the LMS file type that you use as your interface. The file type defaults according to the LMS file type on the Course Catalog - Components page. In instances where the Course Catalog - Components page has no LMS File Type, the system uses the setting on the Academic Institution 3 page. Values are <i>XML V1.1</i>, <i>Blackboard CourseInfo 4</i>, and <i>API Input Format</i>. WebCT Campus Edition and Vista both support XML V1.1.</p>

Field or Control	Description
LMS Extract Group ID (learning management system group ID)	When you select an LMS file type, the LMS Group ID field populates automatically to academic institution, subject area, catalog number, and section number. For the XML file type, values are separated by dashes, such as TERM-INSTITUTION-SUBJECT-CATALOG NBR-SEC#. For authentication to work as designed, do not edit this entry. For XML extracts, at runtime, the system always appends "term-" to the beginning of the string and "-class number" at the end of the string.
LMS URL (learning management system URL)	If you are using a provider for authentication, do not enter an LMS URL. If you do not want to use LMS authentication, but want to link students enrolled in a class to a designated URL such as an instructor's website, you can specify the website in the LMS URL field. The URL must be preceded by the http:// designation.
Last LMS Class Extract Datetm (class extract date/time)	This field is empty when you first schedule a class, and it automatically populates with a date and time when you extract class data. In addition, the LMS extract process uses this field to distinguish between <i>Snapshot</i> and <i>Update</i> data. Presence of this date means that a class is "ignored" by the extract process if run in update mode and the record is not new or no changes to the class have taken place. No date means that the class is extracted for the LMS update extract and the date is updated to the run date.
Last LMS Enrol Extract Datetm (enrollment extract date/time)	This field is empty when you first schedule a class, and it automatically populates with a date and time value when you extract membership data. In addition, the LMS extract process uses this field to distinguish between <i>Snapshot</i> and <i>Update</i> data. Presence of this date means that enrollment data is "ignored" by the extract process if run in update mode, and the record is not new or no changes have taken place to enrollment status, grading basis, or grade. No date means that enrollment data is extracted for the LMS update extract and the date is updated to the run date.

Note: Currently, the system passes all classes individually to the LMS at the component level, including those that comprise a combined section. Combined section data is provided within the XML extract.

Defining Textbooks for Classes

Access the Schedule of Classes – Textbook page (**Curriculum Management > Schedule of Classes > Schedule New Course > Textbook**).

This example illustrates the fields and controls on the Schedule of Classes – Textbook page. You can find definitions for the fields and controls later on this page.

Basic Data		Meetings		Enrollment Cntrl		Reserve Cap		Notes		Exam		LMS Data		Textbook		GL Interface																																	
Course ID:	007129			Course Offering Nbr:	1																																												
Academic Institution:	PeopleSoft University																																																
Term:	2010 Spring			Undergrad																																													
Subject Area:	HISTORY			History																																													
Catalog Nbr:	100			Perspectives on the Present																																													
Class Sections																Find View All		First		1 of 3		Last																											
Session:	1			Regular Academic Session			Class Nbr:	2774																																									
Class Section:	1			Component:	Lecture			Event ID:	000021918																																								
Associated Class:	1			Units:	3.00																																												
Textbook Assignment																																																	
Textbook Assignment Status																																																	
<input type="radio"/> Pending <input checked="" type="radio"/> Textbook entry complete																																																	
<input type="checkbox"/> No textbooks assigned to class <input type="button" value="Copy Textbooks"/>																																																	
Customize Find First 1-3 of 3 Last																																																	
Course Materials																																																	
<table border="1"> <thead> <tr> <th>Seq No</th> <th>*Course Material Type</th> <th>*Course Material Status</th> <th>Title</th> <th>ISBN</th> <th>Author</th> <th></th> <th></th> </tr> </thead> <tbody> <tr> <td>1</td> <td>Textbook</td> <td>Required</td> <td>The American Future: A History</td> <td>9870670044795</td> <td>Simon Schama</td> <td></td> <td>+ -</td> </tr> <tr> <td>2</td> <td>Textbook</td> <td>Required</td> <td>The World: A History, Volume 1</td> <td>9870131777644</td> <td>Felipe Fernandez-Armestc</td> <td></td> <td>+ -</td> </tr> <tr> <td>3</td> <td>Article</td> <td>Recomm</td> <td>The Nation magazine - Feb 2006</td> <td></td> <td></td> <td></td> <td>+ -</td> </tr> </tbody> </table>																		Seq No	*Course Material Type	*Course Material Status	Title	ISBN	Author			1	Textbook	Required	The American Future: A History	9870670044795	Simon Schama		+ -	2	Textbook	Required	The World: A History, Volume 1	9870131777644	Felipe Fernandez-Armestc		+ -	3	Article	Recomm	The Nation magazine - Feb 2006				+ -
Seq No	*Course Material Type	*Course Material Status	Title	ISBN	Author																																												
1	Textbook	Required	The American Future: A History	9870670044795	Simon Schama		+ -																																										
2	Textbook	Required	The World: A History, Volume 1	9870131777644	Felipe Fernandez-Armestc		+ -																																										
3	Article	Recomm	The Nation magazine - Feb 2006				+ -																																										
Special Instructions																																																	
Additional articles will be assigned throughout the term and will be available in the History dept office																																																	

Note: Course materials entered on this page appear on the Class Detail page and on the Faculty and Student Textbook Summary pages. When the **Textbook Assignment Status** is *Pending*, the data is available only on administrative, Instructor and Advisor pages. Students and visitors receive a message: *Textbooks to be determined*. When the **Textbook Assignment Status** is *Textbook entry complete*, the data is then available to students and visitors.

Field or Control	Description
Textbook Assignment Status	Select Pending to indicate that the textbook data that you are entering for the class is not final. The system displays pending textbook information to administrators, instructors and advisors only. Students and visitors cannot view pending textbook information. They receive a message: <i>Textbooks to be determined</i> . Pending is selected by default. Select Textbook entry complete after you complete entering textbook assignments. This option indicates that the textbook data is final. When you select this option, the textbook data is available to all users, including students and visitors.

Field or Control	Description
No textbooks assigned to class	Select this check box if no textbooks are to be assigned to the class section, for example, no textbooks are required for MUSIC 398, Individual Instruction. The Textbook Assignment Status must be set to Textbook entry complete , in order for students to view the message: <i>No textbooks required for this class.</i>
Copy Textbooks	Click this button to copy the textbook and special instructions from another class to the current class. The copied assignments replace any existing assignments and special instructions for the current class.

Course Materials

Select the Course Materials tab (view this tab in the previous example of the Textbook page).

Field or Control	Description
Course Material Type	For each course material assignment, enter the course material type. Valid values are defined on the Course Material Type table. Examples include textbook, article, and other course materials. See Defining Course Material Types .
Course Material Status	Enter the course material status. Values for this field are delivered with your system as translate values. The values are <i>Required</i> and <i>Recommended</i> . You can modify these values.
ISBN	No edits are performed on the ISBN field.

Details

Select the Details tab.

The values in the **Course Material Type**, **Course Material Status**, and **Title** fields are carried forward from the Course Materials tab.

Field or Control	Description
Year Published	Enter the year that the course material edition was published.
Price	Enter the recommended retail price.

<i>Field or Control</i>	<i>Description</i>
Currency Code	<p>Enter the currency code. The base currency code defined on the Installation Table (Setting Up Common Objects > Install > Installation Table > Settings and Defaults) is selected by default.</p> <p>See:</p> <ul style="list-style-type: none"> • “Understanding CS-to-HCM Integration” (Campus Solutions Application Fundamentals) • “Selecting General Installation Options” (Campus Solutions Application Fundamentals)

Notes

Select the Notes tab.

The values in the **Course Material Type**, **Course Material Status**, and **Title** fields are carried forward from the Course Materials tab.

Interfacing Class Sections with the General Ledger

Access the GL Interface page (**Curriculum Management > Schedule of Classes > Schedule New Course > GL Interface**).

This example illustrates the fields and controls on the Schedule of Classes - GL Interface page. You can find definitions for the fields and controls later on this page.

On this page, next to the **Jrnl Set** field, copy and paste icons are available. Use the copy icon to copy the setup for the row, which can then be pasted to the new, or any proceeding row.

Field or Control	Description
Revenue From Item Type	Select if you do not want to track revenue by class. The system allocates revenue based on the credit entry defined for the tuition item type. In this case, you do not populate ChartField information. The system automatically tracks receivables for a class based on the debit entry defined for the tuition item type (on the Item Types - GL Interface page). If you want to track revenue by class, you must select the GL Interface Required check box on Schedule of Classes - Basic Data page and then enter a credit entry for the class by completing the ChartFields on this page.
Jrnl Set ChartFields (journal set ChartFields)	Click the link to enter additional information on the Journal Set ChartFields page.

To input all areas for the ChartFields, abbreviated display fields have been added. The number of delimiters displayed is based on the number of ChartFields.

The abbreviated display fields are used to view the ChartField set up as a string, add or update the ChartField string. All ChartField edits set up on the SF Installation page are adhered to within the display field.

Related Links

“Understanding GL Interface Processing” (Student Financials)

“Mapping Item Types to General Ledger Accounts” (Student Financials)

Modifying Scheduled Classes

Use the Schedule of Classes component when you want to modify or maintain data for classes that have been scheduled. The functionality of the pages in this component are identical to the Schedule New Course component, but the view of classes offered to you is limited to scheduled classes only.

For institutions that schedule large numbers of sections of a class and have facility conflict check activated, use the Schedule Class Meetings component to edit facility and meeting pattern information for scheduled classes. Because the system performs edit checks only on an individual class section (rather than for all the sections of the class), you benefit from faster performance.

Note: To use the Schedule Class Meetings component to schedule facility and meeting pattern information, enter all information for the class, except facility and meeting pattern in the Schedule of Classes or Schedule New Course components. Then go to the Schedule Class Meetings component, enter the subject and catalog number for the class, select the first section, and update the facility/meeting pattern information one section at a time, using the **Next in List** button on the tool bar to scroll through all the sections for the course.

Modifying Scheduled Class Meetings

This section provides an overview of modifications to scheduled class meetings and discusses how to:

- Update meetings information.
- Update enrollment control information.
- Update exam information.

Understanding Modifications to Scheduled Class Meetings

Use the Schedule Class Meetings component when you want to modify or maintain data for an individual class section that has been scheduled. This component contains three pages—the Meetings page, the Enrollment Cntrl page, and the Exam page. These pages are the same as those in the Schedule New Course and Schedule of Classes component.

For example, if you have a course that has 20 scheduled sections for a term and you want to make changes to only two of those 20 sections, you can use the Schedule Class Meetings component to make the necessary changes to each of those two sections individually. Because the system has to run edit checks only on the individual class section rather than all 20 class sections, you benefit from the system's faster performance.

To modify a scheduled class meeting:

1. Update meeting times, facility reservations, and instructor assignments on the Schedule Class Meetings - Meetings page.
2. Update class size, wait list limits, class status, and consent on the Schedule Class Meetings - Enrollment Cntrl page.
3. Link exams and edit exam facility information on the Schedule Class Meetings - Exam page.

Pages Used to Modify Class Meeting Information

<i>Page Name</i>	<i>Definition Name</i>	<i>Navigation</i>	<i>Usage</i>
Schedule Class Meetings - Meetings	CLASS_MTG_PAT_SCTN	Curriculum Management > Schedule of Classes > Schedule Class Meetings > Meetings	Update meeting times, facilities, and instructors for one class section at a time.
Schedule Class Meetings - Enrollment Cntrl (enrollment control)	CLASS_ENRL_CN_SCTN	Curriculum Management > Schedule of Classes > Schedule Class Meetings > Enrollment Cntrl	Update class status values.
Schedule Class Meetings - Exam	CLASS_EXAM_SCTN	Curriculum Management > Schedule of Classes > Schedule Class Meetings > Exam	Link exams to one class section at a time and to edit facility information.

Updating Meetings Information

Use the Schedule Class Meetings - Meetings page to update meeting times, facilities, and instructors for one class section at a time.

<i>Field or Control</i>	<i>Description</i>
Associated Class Attributes	<p>Click this link to access the Associated Class Attributes page and add class association attributes.</p> <p>See Defining Class Associations</p> <p>See Adding Class Association Attributes Using the Schedule of Classes Component</p>

For information about other fields on this page:

Related Links

[Defining Class Meeting Patterns](#)

Updating Enrollment Control Information

Use the Schedule Class Meetings - Enrollment Cntrl page to easily update class status values. In particular, when you need to cancel a class that has multiple sections, it is more efficient to use this component than to cancel the section through the Schedule of Classes component. Most fields on this page are display only because the primary reason for accessing this class meeting is to update the class status value.

Related Links

[Defining Auto Enroll Options and Capacity](#)

Updating Exam Information

Use the Schedule Class Meetings - Exam page to link exams to one class section at a time and to edit facility information.

Related Links

[Linking Exam Times to Classes](#)

Viewing and Updating Class Sections

This section lists a prerequisite and discusses how to review class sections.

Review or update a class section as follows:

1. Access the Update Sections of a Class page.
2. Modify data for the specific class sections that you want to update.

Prerequisite

You must first schedule the class.

Related Links

[Scheduling New Classes](#)

Page Used to View and Update Class Sections

<i>Page Name</i>	<i>Definition Name</i>	<i>Navigation</i>	<i>Usage</i>
Update Sections of a Class	CLASS_CONTROL	Curriculum Management > Schedule of Classes > Update Sections of a Class > Update Sections of a Class	Review or modify a snapshot summary of section information for a class. The page displays one row for each section scheduled for a course offering during a term.

Reviewing Class Sections

Access the Update Sections of a Class page (**Curriculum Management > Schedule of Classes > Update Sections of a Class > Update Sections of a Class**).

This example illustrates the fields and controls on the Update Sections of a Class page. You can find definitions for the fields and controls later on this page.

Update Sections of a Class

Course ID:	001234	Course Offering Nbr:	1
Academic Institution:	PeopleSoft University	Term:	Undergrad
Subject Area:	ANTHRO	Catalog Nbr:	101
			Introduction to Anthropology

Class Sections													
Class Status											Class Enrollment Limits		
Customize Find View All [Grid Icon]											First 1-2 of 2 Last		
Session	Section	Class Nbr	Component	Enrollment Status	*Class Type	*Class Stat	*Assoc	Auto Enr 1	Auto Enr 2	Resection	*Add Consent	*Drop Consent	Schd Print
Regular	1	1023	Lecture	Closed	E	A	1				D	N	✓
Regular	100	1321	Lecture	Closed	E	A	1				N	I	✓

Note: Multiple views of this page are available by selecting the tabs in the scroll area.

Class Status Tab

<i>Field or Control</i>	<i>Description</i>
Class Type	The class type of <i>E</i> (enrollment) indicates which section is the primary section at enrollment time. The class type of <i>N</i> (non-enrollment) is used to indicate that the section choice is the student's secondary enrollment option, or that the section is used in auto-enrollment. Within a class, only one component can possess the class type of <i>E</i> .
Class Stat (class status)	The system populates the Class Stat field to <i>A</i> (active) by default. Class status values are delivered with your system as translate values. You can override the status to indicate <i>Stop Further Enrollment</i> , <i>Cancelled Section</i> , or <i>Tentative Section</i> . The Schedule of Classes report enables you to select on class status, so that you can print only <i>Active</i> classes, or only <i>Inactive</i> classes, and so on. Note: The class status of <i>Active</i> has coding attached to it and should not be deleted from the translate table. You can add as many new class status values to the translate table as you want, but these do not have coding attached to them.
Assoc (associated class number)	The system displays the associated class number. You can edit this field if no students have yet enrolled in the section.

Field or Control	Description
Auto Enrl 1 (auto enroll 1)	For classes that have associated auto enroll sections, you can view or edit the first auto enroll section.
Auto Enrl 2 (auto enroll 2)	For classes that have associated auto enroll sections, you can view or edit the second auto enroll section.
Resection	<p>Enter the alternative section in which the system automatically enrolls a student if the primary section is full.</p> <p>The component of the primary section and the resection to section class must be the same. For instance, when Section 1 Lecture is filled, the system enrolls students in Section 3 Lecture.</p>
Add Consent and Drop Consent	<p>Values default from the Enrollment Cntrl page and indicate the type of consent, if any, that is required to enroll in or drop the class. You can change these values.</p> <p>If you select <i>Instructor</i> or <i>Department</i>, consent is granted either by a permission number or student- specific permission. (For drop permissions, consent is granted on a student-specific basis only.) The consent requirement can also be overridden during the enrollment process, by using the permission override.</p>
Schd Print (schedule print)	<p>The system populates this check box by default from the Schedule Print check box on the Basic Data page. Select this check box to display the class in the schedule of classes.</p> <p>If you clear this check box, the section does not display in the Schedule of Classes - Class Search function if accessed through Campus Self Service. Similarly, if you clear this check box, students using the self-service enrollment feature do not see this class in their class search results. They can enroll in the class, but only if they enter the exact class number (without using the class search feature).</p>

Note: Section numbering is important because the system sorts by section number on this page and in the schedule of classes report.

Class Enrollment Limits Tab

Access the Class Enrollment Limits tab.

Use the Class Enrollment Limits tab to view summary enrollment information for a class. The page displays one row for each section scheduled for a course offering.

Field or Control	Description
Cap Enrol (capacity enrollment)	The system populates this field by default to the Enrollment Capacity field on the Enrollment Cntrl page.
Tot Enrl (total enrollment)	The system displays the current total of students enrolled in the class section.
Wait Cap (wait list capacity)	The system displays the current total of students wait listed for the class section.
Wait Tot (wait list total)	The system populates this field by default to the Wait List Total field as displayed on the Enrollment Cntrl page.
Min Enrl (minimum enrollment)	The system populates this field by default to the Minimum Enrollment Nbr field on the Enrollment Cntrl page.
Combined Section	<p>Click to access the Combined Section Detail page, where you can view all of the classes in the combined section. This link only appears for combined classes.</p> <hr/> <p>Note: After you combine classes, you must perform updates to meeting pattern and instructor information through the Schedule Class Meetings - Meetings page. Within the Schedule of Classes and Schedule New Course components, the facility/meeting pattern and instructor information is unavailable for entry for combined sections.</p> <hr/>

Rolling Data from the Course Catalog to the Schedule of Classes

This section discusses how to run the Course Roll process.

Update the schedule of classes with changes that you have made to a course offering in the course catalog after you have scheduled a class or enrolled students.

To copy data from the course catalog to the schedule of classes:

1. Access the Course Roll page and specify the course offering that has recent changes.
2. Compare the information on the top of the page with the information for each section.
3. If the information differs, click the **Course Roll** button to copy the catalog information down to the individual class sections.

Prerequisite

You must first create your catalog and schedule of classes.

Page Used to Roll Data from the Course Catalog to the Schedule of Classes

<i>Page Name</i>	<i>Definition Name</i>	<i>Navigation</i>	<i>Usage</i>
Course Roll	CRSE_ROLL	Curriculum Management > Roll Curriculum Data Forward > Course Roll > Course Roll	Upon entering the page, the system prompts you to select a course offering from a list of courses already in the schedule of classes for a given term and session.

Running the Course Roll Process

Access the Course Roll page (**Curriculum Management > Roll Curriculum Data Forward > Course Roll > Course Roll**).

The system displays the course offering information for the term and session in the upper portion of the page, and displays all of the related class sections that have been scheduled for that term and session of the course on each detail line in the Class Sections area.

On the lower portion of the page, compare the **Institution, Career, Term, Session, Academic Group, Class Nbr (class number), Subject, Catalog, Sect (section), and Description** (course title) values for the scheduled class sections with the values for the related course catalog offering (on the upper part of the page).

If these values are different, click the **Course Roll** button to synchronize the scheduled class sections with the latest course catalog offering information. The system rolls the course catalog data down to the schedule of classes for each class section that is scheduled for the course during the term and session you specify. The system processes the request and immediately displays the *prospective* changes to the schedule of classes results in the Class Sections area. This is your opportunity to review the results of the roll process. If you are not satisfied with the results, do not save the page. Exit the page, and no update to the schedule of classes occurs. Alternatively, if you are satisfied with the results of the roll process, save the page to confirm and update the schedule of classes.

Note: On the Course Catalog - Offerings page, if you have changed the institution where the course is scheduled and students are already enrolled in the class sections, the system does not process the rolling of the data to the schedule of classes for those class sections.

Related Links

[Creating Course Offerings](#)

Defining Class Associations

This section provides an overview of class associations, an overview of how to use the Common Attribute Framework to extend class associations, lists a prerequisite, and discusses how to:

- Adjust units.
- Modify class components.
- Modify requisites.

Understanding Class Associations

Class association numbers link all class sections that constitute a single offering. With a common association number, you can control not only the sections of classes in which a student must enroll, but you can also control elements of the sections including units, components, and requisites.

Use the class associations component when you have scheduled classes and an administrative or academic change dictates that you must add or modify class components, or adjust units within associated sections.

Regardless of how many components a course offering has (lecture, lab, discussion), always use a unique class association number to identify it. This includes offerings that have just a single component, such as a lecture. Because each section is in its own group, a student can be enrolled in one section and on the wait list for a second more desirable section.

In addition, if you assign a unique class association number, you can vary the units, requisites, and components of individual sections when you have a single component course.

Warning! If you do not indicate a unique association number for each section of a single component course, students cannot wait list for multiple sections.

A visual representation of the class association concept might look like the following image. The course has two lecture sections, four discussion sections, and four lab sections. Student in lecture section 1 can only be in discussion sections A or B, and students in lecture section 2 can only be in discussion sections C or D. All students must enroll in a lab section, but can choose any lab section.

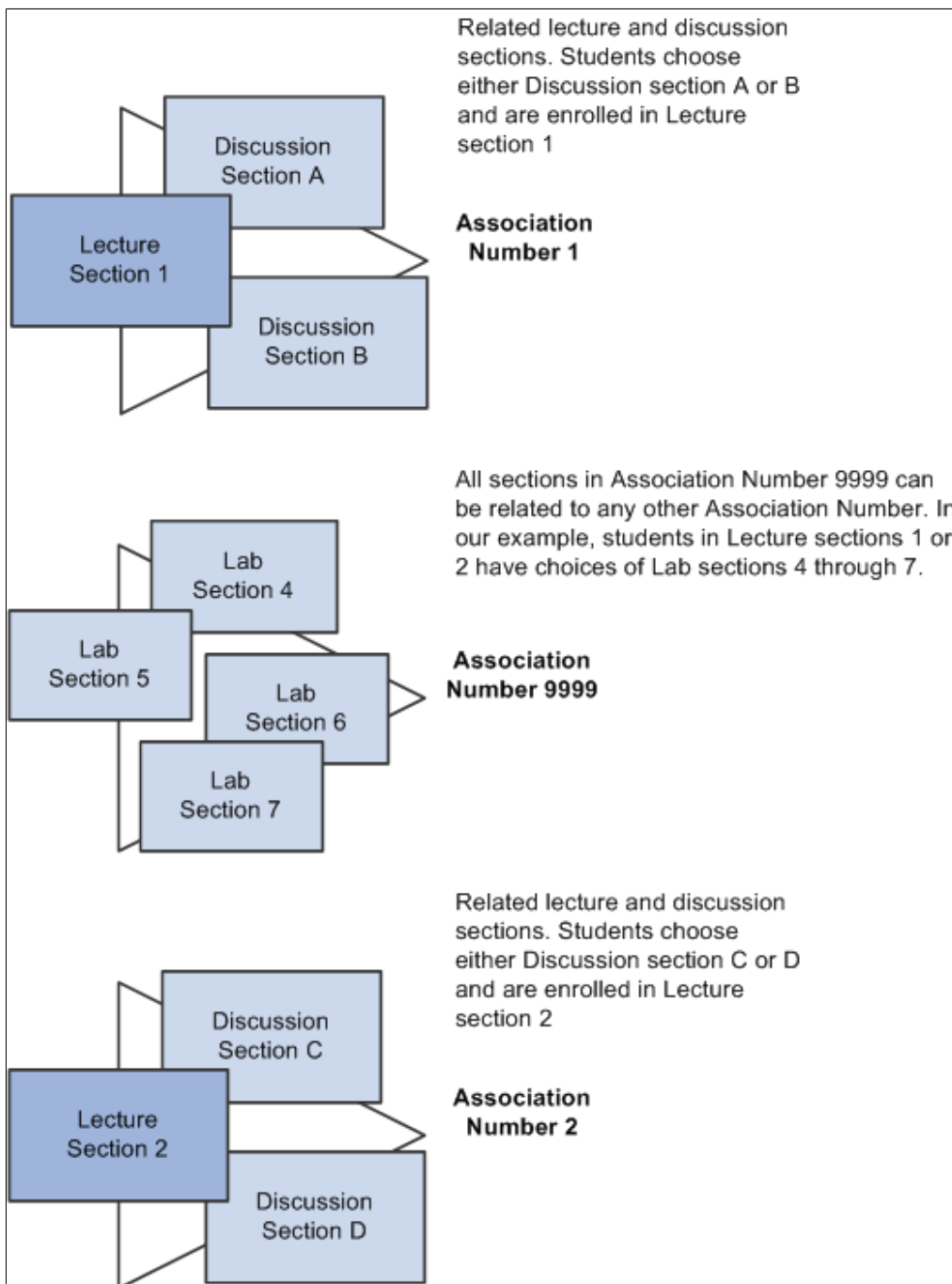

Discussion sections A, B, C, or D are set up with a class type of Enrollment in the Schedule of Classes. Students select to enroll in one of these sections. Lecture sections are set up with a class type of Non-Enrollment and the auto-enroll option selected. Students are automatically enrolled in a lecture section dependent upon the discussion section chosen. Lab sections are set up with association number 9999 because students have an option of enrolling in any of these.

Use the class associations component after you schedule your classes for a term. In this component you can maintain the data of a group of classes which form a single course offering.

The data in the class associations component is created after you schedule classes. Use this component only if you want to override defaults that are set in the course catalog.

Note: After you create the schedule of classes, if you amend the course catalog those changes are not reflected in the schedule of classes. Use the Class Associations component if you must make changes to classes already scheduled, such as adjusting units, modifying components, or modifying requisites. You can also use the Course Roll page to make changes to classes that are already scheduled.

Related Links

[Rolling Data from the Course Catalog to the Schedule of Classes](#)

Using the Common Attribute Framework to Extend Class Associations

This section provides an overview of how to extend the Class Associations structure by defining attributes for use with class associations using the Common Attribute Framework.

Attributes are associated with a functional area by a Record Context. Common Attributes have been enabled for Class Associations as follows:

- Record Context: CLASS_ASSOC
- Attribute Record: SSR_ASSOC_CAF

Attributes attached to this Record Context/Attribute Record combination are available for use with class associations and can be assigned on the Class Components page, or by linking to the Associated Class Attributes page from the Basic Data or the Schedule Class Meetings - Meetings pages.

Steps for Creating Common Attributes for Class Associations

To create common attributes for use with class associations:

1. Define the attribute using the Common Attribute component.
2. Attach that attribute to the Class Association (CLASS_ASSOC) Record Context.

Warning! The Record Context allows you to set certain properties for a particular attribute in that context, including whether an attribute is repeatable or required. However, we strongly recommend that you do not make CLASS_ASSOC attributes *required* because then that attribute is required for all sections of every class that you schedule.

Related Links

[“Defining a Common Attribute” \(Campus Community Fundamentals\)](#)

[“Associating a Common Attribute to a Record” \(Campus Community Fundamentals\)](#)

[Modifying Class Components](#)

[Adding Class Association Attributes Using the Schedule of Classes Component](#)

[Modifying Scheduled Class Meetings](#)

Prerequisite

You must first schedule the class.

Pages Used to Define Class Associations

<i>Page Name</i>	<i>Definition Name</i>	<i>Navigation</i>	<i>Usage</i>
Class Associations	CLASS_ASSOC	Curriculum Management > Schedule of Classes > Adjust Class Associations > Class Associations	Adjust units, change instructor edit views, and select the blind grading option after you schedule a class. All data on the page defaults from the Course Catalog component. All of the data elements can be changed for a class association.
Class Components	CLASS_ASSOC_CMPNT	Curriculum Management > Schedule of Classes > Adjust Class Associations > Class Components	Modify aspects of class components such as grading basis, course components, and requirement designations. Display all related sections for the class association. For convenience, the system also displays any class sections with class association 9999. Add class association attributes.
Class Requisites	CLASS_ASSOC_RQS	Curriculum Management > Schedule of Classes > Adjust Class Associations > Class Requisites	Modify, and, if appropriate, add more requisites to a class.

Adjusting Units

Access the Class Associations page (**Curriculum Management > Schedule of Classes > Adjust Class Associations > Class Associations**).

This example illustrates the fields and controls on the Class Associations page. You can find definitions for the fields and controls later on this page.

Class Associations		Class Components		Class Requisites	
Course ID:	003288	Course Offering Nbr:	1		
Academic Institution:	PeopleSoft University				
Term:	2013 Fall	Undergrad			
Subject Area:	ENGLIT	English Literature			
Catalog Nbr:	170	European Novel			
Session:	1	Regular Academic Session	Class Roll		

Class Associations		Find View All		First	1 of 1	Last
Associated Class:	1	Minimum Units:	<input type="text" value="3.00"/>	Maximum Units:	<input type="text" value="3.00"/>	
Academic Progress Units:	<input type="text" value="3.00"/>	FA Units:	<input type="text" value="3.00"/>	Course Contact Hours:	<input type="text" value="36.00"/>	
Course Count:	<input type="text" value="1.00"/>	*Instructor Edit:	<input type="text" value="No Choice"/> ▼			
Billing Factor:	<input type="text" value="1.000"/>	Tuition Group:	<input type="text"/>	<input type="checkbox"/> Use Blind Grading		

The system creates the record here when you enter and save the schedule of classes. The associated class number links all class sections that constitute a single course offering. For example, all lab and discussion sections plus the associated lecture sessions have the same associated class number. The system populates all of these fields by default from the course catalog.

Note: Association number 9999 can be associated with any other associated class number. When a student enrolls in a class, the system verifies that the student has enrolled in a section with all required components of the course (such as lecture, lab and discussion) from within the same associated class group (or from group 9999). You can only assign association number 9999 to nongraded components.

Field or Control	Description
Minimum Units and Maximum Units	The system populates the Minimum Units and Maximum Units fields by default from the course catalog. You can override these values.
Academic Progress Units and FA Units (financial aid units)	The system populates these fields by default from the course catalog. You can override these values. The fields are unavailable for entry for variable unit courses.
Course Count	The system populates this field by default from the course catalog. The course count indicates the worth, or count, of the course towards an advising requirement. Some institutions count courses, as well as units, towards degree requirements. You can override this value.

Field or Control	Description
Course Contact Hours	<p>The system populates this field by default from the course catalog. Course contact hours may be used for manual workload analysis. You can override this value, which you initially define on the Catalog Data page. Use this field only if you want to report contact hours manually.</p> <p>The Instructor Workload feature does not reference this free-form field.</p> <p>See Walking Through Instructor Workload</p> <p>If you track contact hours manually and therefore use the Course Contact Hours field, the course contact hours should equal the instructor contact hours. If you are overriding the value of the Course Contact Hours field, then to maintain consistency—and therefore increase clarity—you should update the instructor contact hours using the Meetings page. The system itself performs no cross-reference verification to ensure that the corresponding values match.</p>
Billing Factor	<p>The system populates this field to 1 by default. The billing factor regulates billing units, which the system uses to calculate per unit fees. When you establish fees for terms, courses, and classes, you can assess a per unit fee which is derived from the billing units on the student's enrollment record. Billing units are equal to the billing factor times academic progress units ($BU = BF \times APU$). So if billing factor is set to 1 and academic progress units is set to 3, billing units would be 3. Alternatively, if the billing factor is set to 2, and academic progress units is set to 3, billing units would be 6. Because billing factor defaults to 1, billing units are usually equal to academic progress units.</p> <p>The Student Enrollment 1 page is the only place where you can override billing units for an individual enrollment. The only time that billing units and academic progress units would differ is when the billing factor is set to anything other than 1, or if either of these values were changed on the Student Enrollment 1 page.</p>

Field or Control	Description
Instructor Edit	<p>Select how you want the system to prompt for instructor IDs during class scheduling and enrollment. This option determines the availability of the Instructor ID field during enrollment, for courses for which the student has the option to select the instructor, such as independent study courses. The system populates the value for the Instructor Edit field by default from the Catalog Data page. Values for this field are delivered with your system as translate values. Do not modify these values in any way. Any modifications to these values require a substantial programming effort. Values are:</p> <p><i>No Choice:</i> If you select this option, the Instructor ID field is unavailable on the Enrollment Request and Quick Enroll pages and is hidden on the Self Service Enrollment pages. The system automatically assigns the instructor who is scheduled to teach the class, as indicated on the Schedule of Classes - Meetings page: Assignment tab. Thus the student has no choice of instructor.</p> <p><i>Class Instructor Edit:</i> If you select this option, the system makes the Instructor ID field on the Enrollment Request, Quick Enroll, and Self Service Enrollment pages available and prompts the user with only the Primary Instructors for the class, as defined on the Meetings page.</p> <p>Use this option for independent study courses or the like, for which the student can select one of several primary instructors.</p> <p><i>Instructor/Advisor Edit:</i> If you select this option, the system makes the Instructor ID field available on the Enrollment Request, Quick Enroll, Enrollment and Self Service Enrollment pages. The system prompts the user with only the instructors available to teach this course, as defined on the Instructor/Advisor Table page.</p> <hr/> <p>Note: To activate the instructor/advisor edit your institution must first select, on the Academic Organization Table page, to edit instructors against instructor/advisor for the academic organization to which this class belongs. The <i>Instructor/Advisor Edit</i> option should be used only for courses that belong to academic organizations for which the Instructor Advisor option is selected (on the Academic Organization Table page). This ensures that instructor selection is controlled by the academic organization settings.</p> <hr/> <p>See Designating Approved Instructors and Advisors.</p> <p>See “Defining Academic Organizations” (Campus Solutions Application Fundamentals).</p>

Field or Control	Description
Tuition Group	<p>Regardless of the tuition group that you enter on this page, all students are charged tuition based on their own tuition group. Use this field to designate a specific group of students that you want to charge additional course fees for the course.</p> <p>This field is optional.</p> <p>See “Setting Up Tuition Groups” (Student Financials).</p>
Use Blind Grading	<p>Select this check box to enable grade rosters for blind grading. The system populates this field by default from the Course Catalog - Offerings page.</p> <p>When you generate grade rosters for a course that invokes blind grading, instead of student names on the roster, the system generates random numbers.</p>
Class Roll	<p>If the class is scheduled and students are enrolled, and you make changes to the fields in the Class Associations component, in most cases this affects student enrollment. You therefore need to update the enrollment records of each student in the class. To do so, click the Class Roll button for all rows on the page. The system creates enrollment maintenance transactions through a COBOL process and displays for you an enroll request ID related to these transactions. We suggest that you write down the enrollment request ID numbers for use on the Block Enrollment page.</p> <p>The COBOL process considers the following fields when updating student records:</p> <ul style="list-style-type: none"> • Minimum Units. • Academic Progress Units (when minimum and maximum units are the same). • Financial Aid Units (when minimum and maximum units are the same). • Course Count (if set to Course Count Enrollment on the Academic Program - Course page). • Billing Factor. • Tuition Group. • Grading Basis. • Requirement Designation.

Note: To update the students' records, you must navigate to the Block Enrollment page and run the block enrollment process using this enroll request ID. The system uses the enrollment maintenance transactions grouped within this enroll request ID to update the student enrollment records that your changes have affected.

Modifying Class Components

Access the Class Components page (**Curriculum Management > Schedule of Classes > Adjust Class Associations > Class Components.**).

This example illustrates the fields and controls on the Class Components page. You can find definitions for the fields and controls later on this page.

Class Associations
Class Components
Class Requisites

Course ID 000037 Course Offering Nbr 1

Academic Institution PeopleSoft Australia Uni

Term 2020 Semester 1 Undergrad

Subject Area ACCT Accounting

Catalog Nbr 101 Introduction to Accounting A

Session 1 Regular Academic Session

Class Association Components Find | View All First 1 of 1 Last

Associated Class 1

*Grading Basis Graded

Graded Component *Grade Roster Print

Requirement Designation Primary Component

Associated Class Attributes Find First 1 of 1 Last

*Attribute

Class Components Personalize | Find | View All | First 1-2 of 2 Last

*Course Component	Contact	Optional	Workload Hours	*Final Exam	Auto Create
<input type="text" value="Lecture"/>	<input type="text"/>	<input type="checkbox"/>	<input type="text"/>	<input type="text" value="Yes"/>	<input type="checkbox"/>
<input type="text" value="Tutorial"/>	<input type="text"/>	<input type="checkbox"/>	<input type="text"/>	<input type="text" value="No"/>	<input checked="" type="checkbox"/>

Class Sections Personalize | Find | View All | First 1 of 1 Last

Section	Class Nbr	Component	Class Type	Class Status
001	<input type="text" value="1002"/>	Lecture	Enrollment Section	Active

Class Association 9999 Personalize | Find | View All | First 1 of 1 Last

Section	Class Nbr	Component	Class Type	Class Status
1	<input type="text" value="9999"/>			

The system creates the record here when you enter and save the schedule of classes. The associated class number links all class sections that constitute a single course offering. For example, all lab and discussion sections plus the associated lecture sessions have the same associated class number.

The system populates all of these fields by default from the course catalog.

See [Creating Course Offerings](#).

Note: Association number 9999 can be associated with any other associated class number. When a student enrolls in a class, the system verifies that the student has enrolled in a section with all required components of the course (such as lecture, lab and discussion) from within the same associated class group (or from group 9999). You can only assign association number 9999 to nongraded components.

Field or Control	Description
Grading Basis	The system populates this field by default from the course catalog. Select the grading basis to use for the class. Grading basis values are linked to grading schemes on the Grading Scheme Table page.
Grade Roster Print	<p>Enter the type of grade roster that you want to print for this associated class (as processed through the Grade Roster Print page). Values for this field are delivered with your system as translate values. Do not modify these values in any way. Any modifications to these values require a substantial programming effort. Values for grade roster print are:</p> <p><i>By Student:</i> Grade rosters print for each student. Each student has a distinct grade roster, separated by a page break.</p> <p><i>Component:</i> Grade rosters print for the graded component of the class. The graded component is specified on the Course Catalog - Components page.</p> <p><i>Instructor:</i> Grade rosters print for the graded component of the class. The graded component is specified on the Course Catalog - Components page. A copy of the grade roster prints for each instructor, primary or otherwise. The number of copies that print is equal to the number of instructors for the class (primary or otherwise).</p> <p><i>None:</i> No grade roster prints for the class.</p>
Graded Component	<p>The system populates this field by default to the component on the Components page that has the Graded Component check box selected. You can override this value. Select the graded component, indicating the component with which the course grade is associated.</p> <p>After students enroll in a component within the class association, this field is unavailable for entry.</p>
Requirement Designation	<p>Enter a requirement designation for the class. A requirement designation can be extra work that has to be done for a course, such as Design Credit, or a requirement designation can specify a special type of a course to use in a course list for the Academic Advisement application. Requirement designation values are defined on the Requirement Designation Table page, and default from the Catalog Data page. Example requirement designation values are <i>Design Credit</i>, <i>Thesis Choice</i>, and so on.</p> <p>Requirement designations feed into the Academic Advisement application.</p> <p>See Defining Requirement Designations.</p>

Field or Control	Description
Primary Component	<p>If you are using the Dynamic Class Dates feature, it is mandatory that you enter a primary component for the class, even if you only have one component. The Dynamic Class Dates process uses the scheduled class section of the primary component to calculate the landmark dates on a dynamic academic calendar. The process uses the primary component value as defined in this field. You can select to include other components of the class in Dynamic Class Dates process calculations on the Schedule of Classes - Basic Data page.</p> <p>After students enroll in a component within the Class Association, this field is unavailable for entry.</p>

Associated Class Attributes

Use the Associated Class Attributes scroll area to insert rows for Attribute/Value combinations. If you insert a row and specify an attribute, you must also provide a value in order to save the component.

Field or Control	Description
Attribute	The name of the attribute. This value comes from the description of the attribute on the Common Attribute component.
Value	This field changes depending on the type of attribute. This could be a numeric, date, time or text field. Alternatively, the field could prompt against a list of values if one has been defined for the attribute.

See [Using the Common Attribute Framework to Extend Class Associations](#)

Class Components

Field or Control	Description
Course Component	Enter a course component for the class association. The system populates this field by default from the Course Catalog - Components page. Values for this field are delivered with your system as translate values. You can modify these values. The course component indicates the parts of the course offering (<i>lecture, laboratory, seminar</i> , and so on). One course offering can have multiple components.

Field or Control	Description
Contact	Enter the contact hours you want to record for the instructors teaching this component of the course. The Instructor Workload feature does <i>not</i> reference this free form field. Use this field only if you want to report contact hours manually.

Note: Modifying the course components and the contact hours for each component creates inconsistency between this page and the Meetings page. Although you can edit the corresponding fields on the Meetings page, with no impact elsewhere in the system, you should, for clarity, maintain consistency between these two pages. The system itself performs no cross-reference verification to ensure that the corresponding values match. Thus, to maintain consistency you should verify that the course component contact hours on this page equal the instructor contact hours on the Meetings page.

Field or Control	Description
Optional	If you select this check box, enrollment in the component is optional for this associated class.
Workload Hrs (workload hours) and OEE Workload Hrs (open entry/exit workload hours)	<p>If you select the Calculate Workload check box on the Academic Institution 4 page, thereby activating the automated Instructor Workload feature, the Workload Hrs field appears on the Class Components page. The Workload Hrs or OEE Workload Hrs field defaults to the workload hours specified on the Course Catalog - Components page. In other words, if you set the lecture to three workload hours on the Course Catalog - Component page, then whenever a lecture for this course is scheduled, the lecture component defaults to three workload hours on the Class Components page. Similarly, if you set the laboratory component to 1 workload hour on the Course Catalog - Components page, then whenever a laboratory for this course is scheduled, the laboratory component defaults to one workload hour on the Class Association - Class Components page. The user can modify the component values on the Class Association - Class Components page if necessary. This field is optional.</p> <p>The workload hours specified here can be used by the default workload hours formula as specified by the Course Component Workload Hours% field on the Academic Institution 4 page.</p>

Field or Control	Description
Final Exam	<p>Enter a value to indicate whether a final exam is given in the course. The value defaults from the Course Catalog - Components page. Final exam values are delivered with your system as translate values. Add as many values to the translate table for the final exam as needed. The only value that you must not remove from the translate table is <i>Yes</i>, which has coding attached to it. Values are:</p> <p><i>Yes</i>: The <i>Yes</i> value enables block final exam scheduling.</p> <p><i>No</i>: Indicates that this component has no final exam. Entering <i>No</i> eliminates this component from the block exam scheduling process.</p> <p><i>Last Class</i>: Indicates that a final exam is taken in the last regularly scheduled class (as opposed to during final examination week). Entering <i>Last Class</i> eliminates this component from the block exam scheduling process.</p>

Class Sections

Displays all related sections for the class association.

Class Association 9999

For convenience, displays any related class section with class association 9999.

Note: No class association records are created for 9999 sections.

Modifying Requisites

Access the Class Requisites page (**Curriculum Management > Schedule of Classes > Adjust Class Associations > Class Requisites**).

Field or Control	Description
Detail	Click to access the Requirement Group Summary page, where you can review the enrollment requisites for both the course and class.
Also Use Catalog Requisite	<p>Select to command the system to use the course catalog requisite as well as the class requisite in the enrollment process.</p> <hr/> <p>Note: If you have requisites in the course catalog and you do not want to use them for the class offering, clear the Also Use Catalog Requisite check box.</p> <hr/>

Field or Control	Description
Requirement Group	Enter the class requisite requirement group. Requirement group values are created through the Enrollment Requirement Group component.
Long Description	The system populates this field by default to the long description of the enrollment requirement group.

Defining Class Permissions

This section provides an overview of class permissions, lists prerequisites and common elements, and discusses how to:

- Create add permissions for classes.
- Create drop permissions for classes.
- Generate add permissions for a subject area.

Understanding Class Permissions

Class permissions are numbers or authorizations that you can associate with a class and assign to students to use at enrollment time. You can create *general* or *student-specific* add permissions. You can also generate add permission numbers for an entire subject area. You can create only *student-specific* drop permissions.

Class permissions can override conditions such as requisites and limits. Permissions allow a student to add or drop a class, as long as the student uses the permission by the expiration date and does not violate overall student limitation rules (such as maximum number of units).

Prerequisites

Before you can define class permissions, you must:

- Schedule a class.
- Select the **Student Specific Permissions** check box on the Basic Data page (for student-specific permissions).

This option applies to add permissions only.

- Clear the **Student Specific Permissions** check box on the Basic Data page (for general class permissions).

This option applies to add permissions only.

Common Elements Used in This Section

<i>Field or Control</i>	<i>Description</i>
Instructor	View class instructor data. Because there can be multiple instructors for a class, name data for each employee ID appears.
Expiration Date	<p>In the Defaults group box, this is the default expire date. You can change this date. When you create permissions for a class, the system populates the Expire Date column with the default date value. The system retrieves the value for the Default Date field from the SESS_TIME_PEROD table or the SESSION_TABLE based on the following criteria:</p> <p>If the value of the add/drop action for the TIME_PERIOD field on the SESS_TIME_PEROD table is 140 and an end date value exists for this field, the system retrieves this end date value as the default date.</p> <p>If the end date for the TIME_PERIOD field on the SESS_TIME_PEROD table does not exist, the system retrieves the end date for the term as the default date. The system retrieves this value from the SESSION_TBL_END_DT field on the SESSION_TABLE page.</p> <p>In the Class Permission Data group box, the expiration date defaults from the date in the Defaults group box. You can change this date.</p>
Sequence Number	The system generates a sequence number and assigns it to each permission based on the order you create the permissions.
Permission Use Date	The system populates this field with a value of <i>Not Used.</i> by default. When the student successfully uses the add or drop permission, this field is populated with the use date.
Comments	Add comments for individual permission rows.

Pages Used to Create Class Permissions

<i>Page Name</i>	<i>Definition Name</i>	<i>Navigation</i>	<i>Usage</i>
Permission to Add	CLASS_PERMISSION	Records and Enrollment > Term Processing > Class Permissions > Class Permissions > Permission to Add	Create student-specific permissions or general permission numbers for adding classes.

Page Name	Definition Name	Navigation	Usage
Permission to Drop	CLASS_PERMISSION2	Records and Enrollment > Term Processing > Class Permissions > Class Permissions > Permission to Drop	Create student-specific permission numbers for dropping classes.
Generate Add Permissions	RUNCTL_SRSPRMSN	Records and Enrollment > Term Processing > Class Permissions > Generate Add Permissions > Generate Add Permissions	Generate general add permission numbers for an entire term and subject area. Before you access the Generate Add Permissions page, the Consent field on the Enrollment Cntrl page for all classes within the subject you specify, must be set to <i>Department</i> or <i>Instructor</i> .

Creating Add Permissions for Classes

Access the Permission to Add page (**Records and Enrollment > Term Processing > Class Permissions > Class Permissions > Permission to Add**).

This example illustrates the fields and controls on the Permission to Add page. You can find definitions for the fields and controls later on this page.

Permission to Add
Permission to Drop

Course ID: 001239

Academic Institution: PeopleSoft University

Term: 2007 Fall

Subject Area: ECON

Catalog Nbr: 140

Course Offering Nbr: 1

Undergrad

Economics

Macroeconomics

Class Section Data Find | View All | First 1 of 4 Last

Session: 1 Regular Academic Session **Class Nbr:** 2428 **Class Status:** Active

Class Section: 001 **Class Type:** Enrollment Section

Component: Lecture **Instructor:**

Student Specific Permissions

Defaults

Expiration Date: 12/12/2007

Permission Valid For:

Closed Class	Requisites Not Met	Consent Required	Career Restriction	Permission Time Period
<input checked="" type="checkbox"/>	<input checked="" type="checkbox"/>	<input checked="" type="checkbox"/>	<input checked="" type="checkbox"/>	<input checked="" type="checkbox"/>

Assign More Permissions: Generate Set All Permissions to Issued

Class Permission Data Customize | Find | First 1-10 of 10 Last

General Info | Permission | Comments

Seq #	Number	ID	Issued	Issued By	Issued Date	Status	Permission Use Date	Expiration Date
1	256172	SR13435	<input type="checkbox"/>	Swift,Joshua		Used	06/13/2007	12/12/2007
2	724509	SR13592	<input type="checkbox"/>	Ochoa,Graciella		Used then Dropped	06/13/2007	12/12/2007
3	950865	SR13433	<input type="checkbox"/>	Carollan,Sian		Used but Waitlisted	06/13/2007	12/12/2007

<i>Field or Control</i>	<i>Description</i>
Student Specific Permissions	The status of this check box defaults from the Basic Data page.

<i>Field or Control</i>	<i>Description</i>
Permission Time Period	<p>Select this check box to allow a student to enroll in the class during the enroll with permission time period. This time period is determined by a user's enrollment security access ID and by the time period end dates that are defined in the Session Time Period table.</p> <p>See "Setting Up Enrollment Access IDs" (Campus Solutions Application Fundamentals).</p> <p>See "Defining Terms, Sessions, and Session Time Periods" (Campus Solutions Application Fundamentals)</p>

The **Permission Valid For** check boxes are used to specify the conditions that a class permission overrides:

978

Copyright © 1988, 2024, Oracle and/or its affiliates.

Field or Control	Description
Closed Class	Select to allow students to enroll in a class that is full. This type of permission also allows students to enroll in a closed combined section, or in a class where all available seats are subject to reserve capacity requirements that they might not meet.
Requisites Not Met	Select to allow students to enroll in a class for which they do not meet the prerequisites.
Consent Required	Select to allow students to enroll in a class that requires instructor or department consent to add, as indicated by the Add Consent field on the Enrollment Cntrl page.
Career Restriction	Select to allow students to enroll in a class that is outside their career.
Permission Time Period	Select to allow students to enroll in a class during the enroll with permission time period. This time period is determined by a user's enrollment security access ID and by the time period end dates that are defined in the Session Time Period table.

Field or Control	Description
Assign More Permissions	This field is available only if the Student Specific Permissions check box is not selected. Enter the number of permissions you want to create. When you click Generate , the requested number of rows appear in the Class Permission Data group box.
Set All Permissions to Issued	If you select this check box, all the cleared Issued check boxes in the Class Permission Data group box are selected. The Issued By and Issued Date fields are populated when you save the page.

Class Permission Data

The information that appears in this group box changes, depending on whether you create student-specific or general add permissions.

General Info

Select the General Info (general information) tab.

Field or Control	Description
Number	The value that appears is a random number generated for general class permissions.
ID	For student-specific permissions, enter the ID for which you want to create the permission. For general class permissions, this field is populated with the student's ID when the student successfully uses the add permission. When the permission is used, the field is display only.
Issued	Select this check box to indicate that a general permission has been issued to a student. Select the Set all Permissions to Issued check box to select the check boxes in all rows.
Issued By and Issued Date	If the Issued check box is selected, these fields are populated when you save the page. The system displays the operator's user ID in the Issued By field.
Status	View the status of the permission. Values include: <i>Used but Wait Listed:</i> Appears when a student is placed on the wait list for a class for which the student has a permission number or student specific permission. The wait list process can therefore use the permission number or student specific permission to allow the student to enroll, without meeting conditions such as requisites. <i>Used:</i> In the example of a student who is placed on the wait list for a class, this value appears when the student is moved from the wait list and enrolled in the class. <i>Used then Dropped:</i> Appears when a student uses a permission to add a class and subsequently drops the class.

Permission

Select the Permission tab.

The permission conditions, such as **Closed Class**, default to the values selected in the **Defaults** group box. You can select different values for each permission row. When the permission is used, the check boxes become unavailable.

Creating Drop Permissions for Classes

Access the Permission to Drop page (**Records and Enrollment > Term Processing > Class Permissions > Class Permissions > Permission to Drop**).

This example illustrates the fields and controls on the Permission to Drop page. You can find definitions for the fields and controls later on this page.

Permission to Add
Permission to Drop

Course ID: 003276 **Course Offering Nbr:** 1

Academic Institution: PeopleSoft University

Term: 2007 Fall Undergrad

Subject Area: ENGLIT English Literature

Catalog Nbr: 102 Survey of American Literature

Find | View All First 1 of 1 Last

Session: 1 Regular Academic Session **Class Nbr:** 1210 **Class Status:** Active

Class Section: 1 **Class Type:** Enrollment Section

Component: Lecture **Instructor:**

Defaults

Expiration Date: 12/12/2007

Permission Valid For:

Requisites Not Met	Consent Required	Permission Time Period
<input checked="" type="checkbox"/>	<input checked="" type="checkbox"/>	<input checked="" type="checkbox"/>

Generate From Student Enrollment

From Permission to Add

Customize | Find First 1 of 1 Last

General Info Permission Comments EE

Seq #	ID	Name	Status	Permission Use Date	Expiration Date		
1	SR0446	Benson, Tara	Not Used		12/12/2007	+	-

Drop permissions can be used even if the class does not use add permissions. Drop permissions are always student specific.

You can create drop permissions on a student-specific basis only.

The **Permission Valid For** check boxes are used to specify the conditions that a class permission overrides:

<i>Field or Control</i>	<i>Description</i>
Requisites Not Met	Select to allow students to drop a class even if it is being used as a corequisite for another class. For example, a student is enrolled in Class A and Class B. Class B requires concurrent enrollment in Class A. If the Requisites Not Met check box is selected, the student can drop Class A without also dropping Class B.
Consent Required	Select to allow students to drop a class where instructor or department consent is required to drop, as indicated by the Drop Consent field on the Enrollment Cntrl page.

Field or Control	Description
Permission Time Period	<p>Select to allow students to drop a class during the drop with permission session time period. This time period is determined by a user's enrollment security access ID and by the time period end dates that are defined in the Session Time Period table.</p> <hr/> <p>Note: The drop permission has no impact on the consequence of the drop, for example, drop without penalty. This is still determined by the academic calendar dates.</p> <hr/>

Field or Control	Description
From Student Enrollment	<p>Click this button, and then click Generate to create drop permissions for students who are enrolled in the class. You receive an error message if no eligible rows exist.</p>
From Permission to Add	<p>Click this button, and then click Generate to create drop permissions for students who have been granted add permissions on the Permission to Add page. You receive an error message if no eligible rows exist. Eligible rows only exist if add permissions were created on a student-specific basis. Rows are generated whether or not the student has enrolled in the class.</p>

Class Permission Data

View and update details and add comments for drop permissions.

General Info

Select the General Info tab.

Field or Control	Description
ID	<p>Enter the ID for which you want to create a drop permission. When the permission is used, the field becomes unavailable for edit.</p>
Status	<p>View the status of the permission. Values are <i>Used</i> and <i>Not Used</i>.</p>

Permission

Select the Permission tab.

This example illustrates the fields and controls on the Permission to Drop page: Permission tab. You can find definitions for the fields and controls later on this page.

Seq #	ID	Requisites Not Met	Consent Required	Permission Time Period		
1	SR0446	<input checked="" type="checkbox"/>	<input checked="" type="checkbox"/>	<input checked="" type="checkbox"/>	<input type="checkbox"/>	<input type="checkbox"/>

The permission conditions, such as **Requisites Not Met**, default to the values selected in the **Defaults** group box. You can select different values for each permission row. When the permission is used, the check boxes become unavailable.

Generating Add Permissions for a Subject Area

Access the Generate Add Permissions page (**Records and Enrollment > Term Processing > Class Permissions > Generate Add Permissions > Generate Add Permissions**).

This example illustrates the fields and controls on the Generate Add Permissions page. You can find definitions for the fields and controls later on this page.

Generate Add Permissions

Run Control ID: class_perm [Report Manager](#) [Process Monitor](#)

*Academic Institution: PSUNV PeopleSoft University

Academic Group: LBART College of Liberal Arts

*Term: 0570 2006 Fall

Subject Area: HISTORY History

Percent of Enrollment Capacity: 0.10

Minimum of Permission Assign: 10

Commit Frequency: 1

Permission Expire Date: 12/12/2006

Permission Valid For:

Closed Class	Requisites Not Met	Consent Required	Override Career	Permission Time Period
<input checked="" type="checkbox"/>	<input checked="" type="checkbox"/>	<input checked="" type="checkbox"/>	<input checked="" type="checkbox"/>	<input checked="" type="checkbox"/>

Generate add permissions for a subject area for a particular term.

Field or Control	Description
Academic Group	Enter the academic group for which you want to generate add permissions. Academic group values are defined on the Academic Group Table page.
Term	Enter the term for which you want to generate add permissions. Term values are defined on the Term Table page.

Field or Control	Description
Subject Area	Enter the subject area for which you want to generate add permissions. When you run the process based on subject, the system references the Add Consent field on the Enrollment Cntrl page. Subject area values are defined on the Academic Subject Table page.
Percent of Enrollment Capacity	Enter the percent of enrollment capacity the system should use to calculate the number of permissions to create. In the example shown in the page above, the system creates general permissions for 10 percent of the enrollment capacity for every class in the College of Liberal Arts for Fall 2006.
Minimum of Permission Assign	Enter the minimum number of general permissions that you want the system to assign for each class. In the example shown in the page above, the system would always assign a minimum of 10 permission numbers for each class, regardless of enrollment capacity.
Commit Frequency	Defaults to 1. The lower the commit frequency, the better concurrence of data. Even though a higher commit frequency enables faster processing of the job, the job could conflict with another one. You should leave the commit frequency at 1.
Permission Expire Date	<p>If a student does not use the permission before the expiration date, the student no longer has permission to enroll in the class. The system pulls the value of the Permission Expire Date field from the TERM_TABLE and SESS_TIME_PEROD tables for each section that exists based on the following criteria:</p> <p>If the value of the add/drop action for the TIME_PERIOD field on the SESS_TIME_PEROD table is 140 and an end date value exists for this field, the system retrieves this end date value as the default date.</p> <p>If the end date for the TIME_PERIOD field on the SESS_TIME_PEROD table does not exist, the system retrieves the end date for the term as the Default Date. The system retrieves this value from the TERM_TBL_END_DT field on the TERM_TABLE page.</p>
Permission Valid For	All check boxes default to selected. You can select particular check boxes for each academic group, term, and subject combination.

Creating Combined Sections

This section provides an overview of combined sections and discusses how to:

- Define a combined section ID.

- Link classes to a combined section ID.

Understanding Combined Sections

If you need to offer two or more separate classes as one class offering, you can combine sections. For example, you may have a course that is offered by the Economics Department (ECON 101) that is identical to a course that is offered by the Business School (BUSN 111). Perhaps you want to offer each class every semester (so students can pick and chose when they take the course), but there is only a maximum of 30 students total each semester who request the two classes, so it just is not economical. To offer both courses in the schedule of classes each semester, yet have the courses be taught as a single class (with one professor, one location, one meeting pattern, and so on), you can combine sections. Students who enroll in the Economics department version can use one class number to enroll, and students who enroll in the Business Department's version can use a different class number to enroll. Yet, all of the students participate in a single class environment. In this case, the combined sections share an event ID. If you want to combine classes that have different meeting patterns and/or instructor information, you can select the **Skip Meeting Pattern and Instructor Edit** check box, thereby disabling the edit and eliminating the propagation of data across the sections. You can combine sections permanently or for a single class occurrence. You can also combine sections within or across subjects. The enrollment and wait list capacities are controlled both at the section level and at the sections combined level.

To create combined sections:

1. Define a combined sections ID on the Combined Sections Table page.
2. Link classes to the combined sections ID and choose a combination type on the Combined Sections page.

Before you combine sections be sure that a facility ID (if one was entered) exists for only one of the classes you are combining.

Pages Used to Create Combined Sections

<i>Page Name</i>	<i>Definition Name</i>	<i>Navigation</i>	<i>Usage</i>
Combined Sections Table	SCTN_CMBND_TBL	Curriculum Management > Combined Sections > Combined Sections Table > Combined Sections Table	Create combined section IDs for each term and session at your institution.

Page Name	Definition Name	Navigation	Usage
Identify Combined Sections	SCTN_CMBND	Curriculum Management > Combined Sections > Identify Combined Sections > Identify Combined Sections	After you create a combined section ID, use this page to link classes to the ID, define the combination type, and indicate whether or not to enforce or skip the meeting pattern and instructor edit. If the edit is disabled (skipped), then meeting pattern and instructor data can be entered on any of the Schedule of Classes components. If the edit is enforced, then after you combine classes, you must perform all updates to the meeting pattern and instructor information through the Schedule Class Meetings - Meetings page. When you edit this information for a combined section, it is automatically propagated to all of the other combined sections within the same combined sections ID. Within the Schedule of Classes and Schedule New Course components, the facility/meeting pattern and instructor information is unavailable for combined sections.

Defining a Combined Section ID

Access the Combined Sections Table page (**Curriculum Management > Combined Sections > Combined Sections Table > Combined Sections Table**).

Field or Control	Description
Combined Sections ID	The system generates a combined sections ID, providing a unique identifier for each combined sections record.
Description and Short Description	Enter a description and a short description for the combined sections ID. We suggest that these names have some descriptive value to the administrator who assigns these IDs to classes. The descriptions are not visible by students.
View Combined Sections	Click to access the Combined Sections Table page, where you can view classes that are linked to a specific combined section ID.

Linking Classes to a Combined Section ID

Access the Identify Combined Sections page (**Curriculum Management > Combined Sections > Identify Combined Sections > Identify Combined Sections**).

This example illustrates the fields and controls on the Identify Combined Sections page. You can find definitions for the fields and controls later on this page.

Identify Combined Sections

Academic Institution: PSUNV PeopleSoft University
Term: 0505 2003 Fall
Session: 1 Regular Academic Session
Combined Sections ID: 0002 Statistics-Section 1
***Combination Type:** Cross Subject

Permanent Combination
 Skip Mtg Pattern & Instr Edit
Warning: Mtg Pattern & Instr information will not be shared within the combined section.

Combined Capacities

Requested Room Capacity: <input style="width: 50px;" type="text" value="30"/>	Enrollment Capacity: <input style="width: 50px;" type="text" value="30"/>	Total
	Wait List Capacity: <input style="width: 50px;" type="text" value="10"/>	0
		0

[Customize](#) | [Find](#) | [View All](#) | First 1-2 of 2 Last

*Class Hbr	Subject	Catalog Hbr	Section	Status	Reg Room Cap	Enrl Cap	Enrl Tot	Wait Cap	Wait Tot	Acad Group		
1681 <input type="text" value=""/>	PSYCH	235	1	Open	35	35	0	0	0	LBART	<input type="button" value="+"/>	<input type="button" value="-"/>
1682 <input type="text" value=""/>	STATS	115	1	Open	30	30	0	10	0	LBART	<input type="button" value="+"/>	<input type="button" value="-"/>

Note: Multiple views of this page are available by clicking the tabs in the scroll area. We document fields common to all views first.

Field or Control	Description
Combination Type	Enter the combination type. You combine sections <i>Within Subject</i> , <i>Cross Subject</i> , or <i>Both</i> . Values for this field are delivered with your system as translate values. There is no programming associated with this field.
Permanent Combination	Select this check box to command the system to roll the combination when you perform the prior term copy process. If you clear this check box, the system assumes that the combination is a temporary arrangement for the current term.
Skip Mtg Pattern & Instr Edit (skip meeting pattern and instructor edit)	Select this check box to combine sections with different meeting patterns and instructor information. In this case, you enter the meeting pattern and instructor information directly in the Schedule of Classes, but the updated data is <i>not</i> propagated across the sections. The system considers instructor workload for each of the sections, and does not combine hours. If necessary, instructor workload hours can be adjusted on the Meetings page.

Field or Control	Description
Requested Room Capacity	<p>Enter the requested room capacity for the combined section. The room capacity can be different than the enrollment capacity. The requested room capacity is used with Universal Algorithm's Schedule25 software.</p> <hr/> <p>Note: Requested room capacity of combined sections is used for informational purposes only. The system only enforces individual section requested room capacities.</p>
Enrollment Capacity and Wait List Capacity	<p>Enter the enrollment capacity and the wait list capacity for the combined section. The system updates the total as enrollments are processed. The system uses the lower of the individual section and combined section values. The system uses these values to determine the combined section's virtual status. See the Status field description for more information on virtual statuses.</p>
View Combined Sections Table	<p>Click to access the Combined Sections Table page, where you can view or edit the section combined IDs.</p>
Class Number	<p>Enter the class numbers of sections to combine. If the instructor, meeting pattern, session begin and end date, or weeks of instruction are not identical to previously selected class numbers, an error occurs (unless you select the Skip Mtg Ptrn & Instr Edit check box).</p> <hr/> <p>Note: If you combine sections that have class meeting pattern topic IDs assigned to them, the system deletes the topic IDs. This is to prevent possible data integrity problems. Combined sections share meeting pattern information and the sections within the combination may be different courses with their own topic IDs and descriptions. For the same reason, you cannot assign class meeting pattern topic IDs to combined sections. However, you can assign free format topics.</p> <hr/> <p>See Defining Class Meeting Patterns.</p> <hr/> <p>Note: When you remove a class from a combined section, the system deletes all meeting patterns and instructor data from the section that is removed, unless the Skip Meeting Pattern & Instr Edit check box is selected.</p>

Field or Control	Description
Status	<p>The combined section's virtual status appears here. If a class's enrollment status is closed the class's virtual status is closed.</p> <p>If the class's enrollment status is open, the system determines the virtual status by comparing the total number of students enrolled with the combined enrollment capacity. For example, if the combined enrollment capacity was set to 9 and there were 5 students enrolled in PSYCH 235 and 4 in STATS 115 the virtual status would be closed. Thus, when a person conducts a class search, PSYCH 235 and STATS 115 would appear as closed, even though in the schedule of classes (CLASS_TBL) the sections would show statuses of open.</p> <p>The system also displays the combined section's virtual status on the Combined Section Detail page.</p> <p>See Searching for Classes.</p>

Scheduling Examinations

This section provides an overview of exam scheduling, lists prerequisites, and discusses how to:

- Schedule exams for individual classes.
- Run the Exam Scheduling process.
- Troubleshoot the Exam Scheduling process.

Understanding Exam Scheduling

You can schedule exams on a class-by-class basis or in large blocks. The block exam scheduling process is useful if you want to schedule exams in the same facility as the primary meeting for the class.

To schedule an exam for a single class (in a facility other than the regular class for the primary meeting):

1. Access the Schedule Class Meetings - Exam page.
2. Enter your reservation.

To schedule exams in large blocks:

1. Access the Exam Scheduling page and specify your processing parameters.
2. Run the Exam Scheduling process.

Prerequisites

Before you run the Exam Scheduling process, you must:

- Set the **Final Exam** field on the Course Catalog - Components page to *Yes*.

- Define exam codes on the Exam Code Table page.

See [Defining Exam Codes](#).

Pages Used to Schedule Exams

Page Name	Definition Name	Navigation	Usage
Schedule Class Meetings - Exam	CLASS_EXAM	Curriculum Management > Schedule of Classes > Schedule Class Meetings > Exam	Link exams to one class section at a time and edit facility information.
Generate Exam Schedule	RUNCTL_SREXSCHD	Curriculum Management > Schedule of Classes > Generate Exam Schedule > Generate Exam Schedule	Run the Exam Scheduling process to schedule exams in batch, and reserve the regularly scheduled facility.

Scheduling Exams for Individual Classes

To schedule exams by individual section, use the Schedule Class Meetings component.

Related Links

[Modifying Scheduled Class Meetings](#)

Running the Exam Scheduling Process

Access the Generate Exam Schedule page (**Curriculum Management > Schedule of Classes > Generate Exam Schedule > Generate Exam Schedule**).

Field or Control	Description
Academic Institution	Enter the academic institution for which you want to schedule exams.
Term	Enter the term for which you want to schedule exams.
Academic Group and Session	Enter the academic group and session for which you want to schedule exams. Academic group values are defined on the Academic Group Table page. Session values are defined on the Session Table page.
Assign to Scheduled Facility	Select this check box to command the system to assign exams the same facilities in which the class is scheduled for the term. If you clear this check box, exams are scheduled without a facility.

Note: When scheduling exams for class sections with multiple meeting patterns, the Exam Scheduling process assigns final exam codes based on the class meeting pattern entered first on the Meetings page.

Troubleshooting the Exam Scheduling Process

Setup issues that can cause the Exam Scheduling SQR to not schedule exams include the following:

- Exam Code table not set up correctly to correspond with all possible class meeting patterns.
- Exam Code table not set up for the specified term and session.
- Exam Scheduling page must have the correct academic group.
- Exam Scheduling page must have the correct session code.
- Class must be set up on the Class Associations - Class Components page with a **Final Exam** value of *Yes*.
- Class meeting patterns are not set up for the class.
- Facility is not reserved if you run the process where the **Assign to Scheduled Facility** check box is not selected.
- Facility is not reserved if you run the process where the **Assign to Scheduled Facility** check box is selected, but the facility is already in use by another event during the exam time.

Modifying Course Events

This section lists a prerequisite and discusses how to define course events.

Prerequisite

You must first have an event ID record in your system.

Page Used to Modify Course Events

<i>Page Name</i>	<i>Definition Name</i>	<i>Navigation</i>	<i>Usage</i>
Class Event Table	COURSE_EVENT	Curriculum Management > Schedule of Classes > Class Event Table > Class Event Table	Review a class section's facility reservations, and modify or delete facility reservations by date.

Defining Class Events

Access the Class Event Table page (**Curriculum Management > Schedule of Classes > Class Event Table > Class Event Table**).

This example illustrates the fields and controls on the Class Event Table page. You can find definitions for the fields and controls later on this page.

Class Event Table

Event ID: 000021813
 *Description: Elem Chem
 Academic Institution: PeopleSoft University
 Event Type: Course

Class Sections				
Term	Subject	Catalog Nbr	Section	Class Nbr
0530	CHEM	102	1	1432

Campus Meetings							
Facility ID	Building	Room	Day of Week	Start Time	End Time	Contact Minutes	Date
ANGE102	Angel	102	Monday	9:00AM	9:50AM	50	08/30/2004
ANGE102	Angel	102	Wednesday	9:00AM	9:50AM	50	09/01/2004
ANGE102	Angel	102	Friday	9:00AM	9:50AM	50	09/03/2004
ANGE102	Angel	102	Monday	9:00AM	9:50AM	50	09/06/2004
ANGE102	Angel	102	Wednesday	9:00AM	9:50AM	50	09/08/2004
ANGE102	Angel	102	Friday	9:00AM	9:50AM	50	09/10/2004
ANGE102	Angel	102	Monday	9:00AM	9:50AM	50	09/13/2004

Field or Control	Description
Description	The description of the course event. This is the course description.
Contact Minutes	Modify contact minutes for individual classes if necessary. The system bases the contact minutes on the start and end time of the course as defined in the Schedule of Classes. Changing contact minutes for a class meeting has no impact on course contact hours or instructor contact hours. If you have a particular class meeting that you would like additional facility time (perhaps a day for group project presentations, where students need additional time to take down their presentation materials at the end of class), you can increment the contact minutes to your desired reservation time. In addition, you can delete a single meeting facility reservation to make the facility available for another event. Click the Save button to edit the facility reservation. If facility checking is active, the system verifies that your requested reservation is valid before saving the request.

Note: If you are using the PeopleSoft facility conflict checking logic, be sure when you are scheduling classes that you indicate a facility for at least one component of a course. The system does not populate the Class Event Table page unless a facility is booked for at least one component of a course. You indicate facilities for course components on the Meetings page.

Viewing Instructor Schedules

This section discusses how to view instructor schedules.

Page Used to View Instructor Schedules

<i>Page Name</i>	<i>Definition Name</i>	<i>Navigation</i>	<i>Usage</i>
Instructor Schedule	INSTR_CLASS	Curriculum Management > Instructor/Advisor Information > Instructor Schedule > Instructor Schedule	Review an instructor's class schedule for a term.

Viewing Instructor Schedules

Access the Instructor Schedule page (**Curriculum Management > Instructor/Advisor Information > Instructor Schedule > Instructor Schedule**).

The system displays all class meetings for an instructor within a term.

Instructor Schedule 2 Tab

Select the Instructor Schedule 2 tab.

The system displays additional detail information for all class meetings for an instructor within a term.

Viewing Instructor Schedules Through Self-Service Pages

If your institution has licensed PeopleSoft Campus Self Service, your instructors can view their class schedule and weekly schedules directly over the web.

Related Links

“Using the Self-Service Faculty Center” (Campus Self Service)

Viewing Class Facility Usage

This section discusses how to review class facility usage.

Prerequisites

You must first assign events or classes with meeting patterns to a facility.

Page Used to View Class Facility Usage

<i>Page Name</i>	<i>Definition Name</i>	<i>Navigation</i>	<i>Usage</i>
Class Facility Usage	CLASS_MTG_PAT_DSPL	Curriculum Management > Facility and Event Information > Class Facility Usage > Class Facility Usage	Review a summary of events for a term, session, and day within a facility.

Reviewing Class Facility Usage

Access the Class Facility Usage page (**Curriculum Management > Facility and Event Information > Class Facility Usage > Class Facility Usage**).

<i>Field or Control</i>	<i>Description</i>
Term, Session, and Day of the Week	Select a term, session, and day of the week for your facility search.
Fetch Class Meetings	Click to retrieve all existing event information for the parameters specified.

Searching for an Available Facility

This sections discusses how to:

- Create facility search criteria.
- View facility search results.

Use the Search for a Facility component to search for available facilities when scheduling classes and non-course events, such as faculty meetings.

To search for an available facility:

1. Access the Facility Search Criteria page, and enter search criteria as detailed as necessary.
2. Click the **Fetch Facilities** button to retrieve your results.
3. Review your results on the Facility Search Results page.

Pages Used to Search for a Facility

<i>Page Name</i>	<i>Definition Name</i>	<i>Navigation</i>	<i>Usage</i>
Facility Search Criteria	FACILITY_SRCH	Curriculum Management > Facility and Event Information > Search for a Facility > Facility Search Criteria	Initiate your search for an available facility.
Facility Search Results	FACILITY_SRCH_RSLT	Curriculum Management > Facility and Event Information > Search for a Facility > Facility Search Results	Review the results of your search.

Creating Facility Search Criteria

Access the Facility Search Criteria page (**Curriculum Management > Facility and Event Information > Search for a Facility > Facility Search Criteria**).

This example illustrates the fields and controls on the Facility Search Criteria page. You can find definitions for the fields and controls later on this page.

The screenshot shows the 'Facility Search Criteria' page with two tabs: 'Facility Search Criteria' (active) and 'Facility Search Results'. Below the tabs, the 'Academic Institution' is set to 'PeopleSoft University'. The 'Meeting Criteria' section includes:

- *From Date: 11/24/2010
- *End Date: 11/24/2010
- *Meeting Start Time: 8:00AM
- *Meeting End Time: 5:00PM
- Day selection: M (unselected), Tu (unselected), W (selected), Th (unselected), F (unselected), Sa (unselected), Su (unselected).

 The 'Facility Criteria' section includes:

- Facility Type: LCTR (Lecture Room)
- *General Assignment: Ignore Fld
- Room Capacity From: []
- Room Capacity To: 100
- Academic Organization: LIBARTS (College of Liberal Arts)
- Facility Partition: []
- Location Code: []
- Building: []
- A yellow 'Fetch Facilities' button is located at the bottom right of the form.

Enter the criteria for your meeting in the **Meeting Criteria** group box. Enter any specific facility requirements you have in the **Facility Criteria** group box.

Click the **Fetch Facilities** button to retrieve a list of facilities that match your request.

Viewing Facility Search Results

Access the Facility Search Results page (**Curriculum Management > Facility and Event Information > Search for a Facility > Facility Search Results**).

The system lists every facility that matches your criteria. Reserve the room through event scheduling.

Related Links

[“Tracking Event Attendance” \(Campus Community Fundamentals\)](#)

Searching for Classes

This section provides an overview of class search and lists the pages used to search for classes.

Related Links

[“Searching for Classes Using Classic Self-Service Pages” \(Campus Self Service \)](#)

[Setting Up Class Search Profiles](#)

Understanding Class Search

Use the Class Search feature to search or browse for classes within a specific institution and term. The Class Search feature is accessible through the core system and through PeopleSoft Campus Self Service.

Combined Section Statuses in Class Search

When you search for open classes, the system uses a virtual status to determine whether or not a combined section class appears on the Search for Classes - Search Results page. If the class has a virtual status of closed, the class does not appear on the Search for Classes - Search Results page for open classes.

The system calculates a virtual status for combined sections because combined section classes have combined enrollment capacities. A section with an enrollment capacity of 30 would appear in CLASS_TBL as open after only 15 students enroll, but if it is a combined section with a combined enrollment capacity of 30, and both classes have 15 students enrolled—which meets the combined enrollment capacity of 30—the combined section is closed, even though CLASS_TBL shows each section as open. The class search feature knows the combined section is closed because of the virtual status. The system determines the virtual status of the combined section on the Combined Sections page.

The system follows the following rules to determine the virtual status of a combined section class:

- If the enrollment status of a class is closed, the virtual status is closed.
- If the enrollment status of the class is open, the system evaluates whether or not seats are available within the combined section.

If seats are available, the virtual status is open. If no seats are available within the combined section, the virtual status is closed.

Pages Used to Search for Classes

<i>Page Name</i>	<i>Definition Name</i>	<i>Navigation</i>	<i>Usage</i>
Search for Classes	SSR_CLSRCH_ENTRY	Curriculum Management > Schedule of Classes > Class Search > Search for Classes	Search for classes offered during a specific term. Enter search criteria and retrieve your results.
Search for Classes - Search Results	SSR_CLSRCH_RSLT	Click the Search button on the Search for Classes page.	Review all classes that match your search criteria.
Search for Classes - Class Detail	SSR_CLSRCH_DTL	Click a class section on the Search for Classes - Search Results page.	Review detail for a specific class.

Printing the Schedule of Classes Report

Use the Schedule of Classes Report component to print the schedule of classes report for a term.

This section discusses how to:

- Set Schedule of Classes Report parameters.
- Set Schedule of Classes Report options.

Pages Used to Print the Schedule of Classes Report

<i>Page Name</i>	<i>Definition Name</i>	<i>Navigation</i>	<i>Usage</i>
Print Class Schedule	RUNCTL_SRYSDHD	Curriculum Management > Schedule of Classes > Print Class Schedule > Print Class Schedule	Specify reporting parameters for the Schedule of Classes.
Report Options	RUNCTL_SRYSDHD2	Curriculum Management > Schedule of Classes > Print Class Schedule > Report Options	Further specify your Schedule of Classes reporting options.

Setting Schedule of Classes Report Parameters

Access the Print Class Schedule page (**Curriculum Management > Schedule of Classes > Print Class Schedule > Print Class Schedule**).

Field or Control	Description
Academic Institution	Enter the academic institution for which you want to print the schedule of classes. The system populates the Academic Institution field by default from the User Defaults 1 page. You can change the value. This field is required.
Term	Enter the term for which you want to print the schedule of classes. The system populates the Term field by default from the User Defaults 1 page. You can change the value. This field is required.
Academic Organization Node	Enter the academic organization node for which you want to print the schedule of classes. The report selects all classes whose academic organization (as assigned on the Schedule of Classes - Basic Data page) falls under the academic organization node that you enter here. You can view the hierarchy of academic organizations on the academic organization tree. <i>See PeopleTools: Tree Manager</i>
Session	Enter the session for which you want to print the schedule of classes. If you do not enter a specific session, the system prints the schedule for the term you specify. Session values are defined on the Session Table page.
Schedule Print	Enter the schedule print value. Values for this field are delivered with your system as translate values. Do not modify these values in any way. Any modifications to these values require a substantial programming effort. Values are: <i>Yes:</i> All classes with the Schedule Print check box selected on the Basic Data page appear on the report. <i>No:</i> All classes with the Schedule Print check box cleared on the Basic Data page appear on the report. <i>All:</i> All classes appear on the report, regardless of the Schedule Print check box setting on the Basic Data page.
Print Instructor in Schedule	Enter a value to determine whether the instructor's name appears on the report. Values for this field are delivered with your system as translate values. Do not modify these values in any way. Any modifications to these values require a substantial programming effort. Values are: <i>Yes:</i> All instructors with the Print check box selected on the Meetings page appear on the report. <i>No:</i> All instructors with the Print check box cleared on the Meetings page appear on the report. <i>All:</i> All instructors appear on the report, regardless of the Print check box setting on the Meetings page.

Field or Control	Description
Class Status	Use the Class Status group box indicate what status of classes to print on the schedule of classes. Values are <i>Active</i> , <i>Cancelled</i> , <i>Stop Enrl</i> , and <i>Tentative</i> .
Print By Campus and Campus	Select to print the schedule of classes based on campus rather than by class section number. Select the campus to specify a single campus.
Print By Location and Location Code	Select to print the schedule of classes based on location within campus, rather than by class section number. Select the location code to specify a single location.

Setting Schedule of Classes Report Options

Access the Report Options page (**Curriculum Management > Schedule of Classes > Print Class Schedule > Report Options**).

Field or Control	Description
Report Options	Set the report options to print the information that you want to display on the schedule of classes report.
Report Only	Clear this check box to specify that you want to create a Schedule of Classes report and send the Schedule of Classes report to your file path location in csv format. Select this check box to create a Schedule of Classes report, without creating a csv file. If you select this check box, the File Path field becomes unavailable.
File Path	In addition to sending report output for this process to a file (through setting preferences in the PeopleSoft Process Monitor), you can also send any additional output files created by this process to a file directory. To send the extract output to a file directory, enter a valid directory path that maps to a folder with appropriate read/write permission. If you cannot locate such a folder, consult your system administrator.

Copying Classes from One Term to Another

This section lists prerequisites and discusses how to:

- Define criteria for the Prior Term Copy process.
- Select options for the Prior Term Copy process.

Use the Prior Term Copy component to copy the schedule of classes from term to term dependent upon criteria you submit and the roll down options you select.

To run the prior term copy process:

1. Access the Prior term Copy page.
2. Define your processing parameters.
Specifically, define the term from which you want to copy data, and define the term to which you want to copy data.
3. Define additional information such as the academic group and subject area that you want to copy (from and to).
4. Access the Prior Term Copy 2 page.
5. Define detailed options that specify the types of classes that you want to copy.
6. Click **Run** to run this request. PeopleSoft Process Scheduler runs the RUNCTL_SRROLL process at user-defined intervals.

Prerequisites

You must first define your academic institution and terms. In addition, you need to have a schedule of classes created in a prior term.

Pages Used to Copy Classes from Term to Term

<i>Page Name</i>	<i>Definition Name</i>	<i>Navigation</i>	<i>Usage</i>
Copy Prior Term's Schedule	RUNCTL_SRROLL	Curriculum Management > Roll Curriculum Data Forward > Copy Prior Term's Schedule > Copy Prior Term's Schedule	Define the criteria for copying the schedule of classes from term to term.
Copy Prior Term's Schedule2	RUNCTL_SRROLL2	Curriculum Management > Roll Curriculum Data Forward > Copy Prior Term's Schedule > Copy Prior Term's Schedule2	Define additional class status and roll options for the process.

Defining Criteria for the Prior Term Copy Process

Access the Copy Prior Term's Schedule page (**Curriculum Management > Roll Curriculum Data Forward > Copy Prior Term's Schedule > Copy Prior Term's Schedule**).

This example illustrates the fields and controls on the Copy Prior Term's Schedule page. You can find definitions for the fields and controls later on this page.

Copy Prior Term's Schedule
Copy Prior Term's Schedule2

Run Control ID: PS

[Report Manager](#)
[Process Monitor](#)
Run

'Institution:	<input type="text" value="PSUNV"/>	PeopleSoft University
'Roll From Term:	<input type="text" value="0640"/>	2010 Spring
'Roll To Term:	<input type="text" value="0660"/>	2011 Spring

Find | View All
First 1 of 1 Last

Sequence:	<input type="text" value="1"/>	
Academic Group:	<input type="text"/>	
Subject Area:	<input type="text" value="FREN"/>	French
Catalog Number From:	<input type="text" value="103"/>	Catalog Number To: <input type="text" value="103"/>
Campus:	<input type="text"/>	
Session:	<input type="text"/>	Commit Frequency: <input type="text" value="1"/>

<i>Field or Control</i>	<i>Description</i>
Academic Institution	Enter the academic institution for which you want to copy a schedule of classes data.
Roll From Term	The term from which you want to copy classes (the source term).
Roll To Term	The term to which you want to copy classes (the target term).
Sequence	The system populates this field to 1 by default, and increments by 1 for each row that you add. This value is for internal processing purposes only.
Academic Group	Enter an academic group for the classes that you want to copy.
Subject Area, Catalog Number From, and Catalog Number To	Enter a subject area for the classes that you want to copy. If you select a subject area, you have the option of specifying a range of catalog numbers. The system does not require you to select a subject area. If you do not select a subject area, the Catalog Number fields are unavailable for entry.
Campus	Enter a campus for the classes that you want to copy. This field is optional.
Session	Enter a session for the classes that you want to copy. This field is optional.

<i>Field or Control</i>	<i>Description</i>
Commit Frequency	The system populates this field to 1 by default. The lower the commit frequency, the better concurrence of data. While the higher the commit frequency enables faster processing of the job, the job could get tied up with another process. You should leave the commit frequency at 1.

Selecting Options for the Prior Term Copy Process

Access the Copy Prior Term's Schedule2 page ((**Curriculum Management > Roll Curriculum Data Forward > Copy Prior Term's Schedule > Copy Prior Term's Schedule2**)).

This example illustrates the fields and controls on the Copy Prior Term's Schedule2 page. You can find definitions for the fields and controls later on this page.

Class Status

Use the **Class Status** group box to indicate the status for classes that you want to copy. Values are *Active*, *Cancelled*, *Tentative*, and *Stop Enrl*. Each of these values corresponds to the class status value on the Enrollment Cntrl page.

Roll Options

Specify the type of information that you want to copy by selecting the appropriate roll options.

Field or Control	Description
Use Catalog Component	<p>Select this check box to validate against the course catalog and only roll those sections to the new term that are valid components of the course as defined in the course catalog. If you do not select this check box, the system copies all sections to the new term, regardless of the component designation.</p> <hr/> <p>Note: If a dynamic class date rule is associated with a class, you can still use the Prior Term Copy process by selecting the Use Catalog Component check box because the rule rolls from the course catalog. However, in order to calculate deadline dates, you must run the Dynamic Class Dates process within the copy to term.</p>
Roll Combined Sections	Select this check box to roll combined sections that are designated as a permanent combination (on the Combined Sections page) to the new term.
Roll Textbook Assignments	<p>Select this check box to roll textbook assignments. All data is carried forward except Textbook Assignment Status, which is set to Pending.</p> <p>See Defining Textbooks for Classes.</p>

The remaining options are self-evident.

Note: If your institution uses the Instructor Workload feature, you should follow the Prior Term Copy process with the Workload Copy/Update process using the same roll from and roll to terms. This final step ensures that the process creates term workload records for all copied Schedule of Classes data.

Clearing the Resource Queue Table

This section provides an overview of the resource queue table and discusses how to clear the resource queue table.

Understanding the Resource Queue Table

For organizations that schedule classes with facility conflict checking activated, the resource queue table is a useful feature that prevents users from double booking facilities. When a user begins the class scheduling process, the system inserts a row in the resource queue table (via a COBOL program). This row signifies that someone within the organization is currently scheduling facilities. If another user attempts to reserve a facility, the system presents them with a message that resources are currently being allocated to another process and they must wait.

For example, "The resource you are trying to schedule is currently in use. Try your save again. If after 3 attempts you still cannot save, contact your system administrator."

When the scheduling process finishes, the row is removed from the Resource Queue table.

On occasion, system-wide or local client workstation errors may cause the row to remain in the table, thereby preventing the scheduling of classes. The Resource Queue Cleanup page was designed with this in mind. It is a powerful page, to be used by individuals at the system administrator level. The system administrator can click the **Unlock Resource** button on the Resource Queue Cleanup page, confirm their selection on the secondary page, and free up the resource.

Page Used to Clear the Resource Queue Table

<i>Page Name</i>	<i>Definition Name</i>	<i>Navigation</i>	<i>Usage</i>
Resource Queue Cleanup	RESOURCE_QUEUE	Curriculum Management > Schedule of Classes > Resource Queue Cleanup > Resource Queue Cleanup	Unlock a facility resource.

Clearing the Resource Queue Table

Access the Resource Queue Cleanup page (**Curriculum Management > Schedule of Classes > Resource Queue Cleanup > Resource Queue Cleanup**).

<i>Field or Control</i>	<i>Description</i>
Unlock Resource	Click to unlock the resource.

Tracking Instructor Workload

Viewing and Updating Term Workload Data

Two primary ways are available to assign workload hours to an individual:

- Assign non-instructional hours (such as advising) on the Term Workload page.
- Assign an instructor to a class on the Meetings page (thereby attaching the class's workload hours to the instructor).

There is a third way of assigning workload to individuals, through the Workload Copy/Update process, where instructor workload assignments are copied in batch from one term to another. The Workload Copy/Update process is described in a later topic.

Related Links

[Understanding Instructor Workload](#)

Prerequisites

Before you can review and update term workload, you must:

- Define instructor assignment class values for your institution on the Instructor Assignment Class page.
- Set the default instructor assignment class value for your institution on the Academic Institution Table - Academic Institution 4 page.

Pages Used to View and Update Term Workload Data

<i>Page Name</i>	<i>Definition Name</i>	<i>Navigation</i>	<i>Usage</i>
Term Workload	INSTRUCTOR_TERM	Curriculum Management > Instructor/Advisor Information > Instructor Term Workload > Term Workload	Assign instructor values, view previously assigned term data, or manually update values.
Components	CLASS_ASSOC_CMPNT	Curriculum Management > Course Catalog > Course Catalog > Components	Modify aspects of class components, such as grading basis, course components, and requirement designations.

Page Name	Definition Name	Navigation	Usage
Meetings	CLASS_MTG_PATTERN	<ul style="list-style-type: none"> Curriculum Management > Schedule of Classes > Schedule New Course Curriculum Management > Schedule of Classes > Maintain Schedule of Classes Curriculum Management > Schedule of Classes > Schedule Class Meetings 	<p>Enter or view class specific workload data for instructors.</p> <p>If you assign an individual to a class meeting, and they are not assigned to an instructor assignment class on the Term Workload page for the term, the system uses the default instructor assignment class from the Academic Institution 4 page to create a term workload record.</p>

Viewing and Updating Individual Term Workload Data

Access the Term Workload page ((Curriculum Management > Instructor/Advisor Information > Instructor Term Workload > Term Workload).

This example illustrates the fields and controls on the Term Workload page: Workload Assignment tab. You can find definitions for the fields and controls later on this page.

Term Workload

Dabbs,Constancio ID: SR0405

Workload Definition Find | View All First 1 of 2 Last

Academic Institution: PSUNV PeopleSoft University **Total Term FTE%** [+ -]

Term: 0550 2005 Fall

Instructor Assignment Class: FULL Full-time

Calculate Workload: **Assigned FTE %:** 120.00

Limit Workload: **Instructor Multiplier %:** 100

Workload Assignment Job Code

*Description	Subject	Catalog Nbr	Section	Class Nbr	Comb Sects ID	*Assign Type	Work Load	App Load	Assignment FTE %		
Inorg Synthesis and Reactions	CHEM	128	010	1687		Lecture		<input checked="" type="checkbox"/>			[+ -]
Inorg Synthesis and Reactions	CHEM	128	011	1688		Lecture		<input checked="" type="checkbox"/>			[+ -]

If you want to view an individual's cumulative term full-time equivalent (FTE) percentage data, add non-course-based assignments (such as advising), or manually override a check box setting, you can reference the Term Workload page to do so.

Note: Multiple views of this page are available by selecting the tabs in the scroll area. Fields common to all views are documented here first.

Field or Control	Description
Academic Institution	Displays the institution to which this Term Workload record is attached. Individuals can have separate records for separate academic institutions.
Term	Use to enter new term workload data, or to review an existing term workload record.
Instructor Assignment Class	<p>When you access this page in Add mode and specify a term, this field displays the appropriate effective-dated setting that you specified on the Academic Institution 4 page.</p> <p>Enter an instructor assignment class value for this individual if different from the default. The Calculate Workload, Limit Workload, Assigned FTE %, and Instructor Multiplier % fields display the default settings from the Instructor Assignment Class page. You can change these settings.</p>
Calculate Workload	Select to activate the Instructor Workload feature for this instructor or advisor in the specified term. This selection determines if the system creates term detail records at all. This selection alone does <i>not</i> control whether the feature produces a limit warning. You must select the Limit Workload check box in conjunction with the Calculate Workload check box for warnings to appear. This check box is selected by default if the Calculate Workload check box on the Instructor Assignment Class page is also selected. You can change this setting on a term-by-term basis.
Limit Workload	Select to activate the workload limit for this instructor or advisor in the specified term. This selection determines if errors and warnings are produced when assignments are made that exceed either the individual's assigned FTE percentage or the academic institution warning limits. This selection is available only if the Calculate Workload check box is selected. This check box is selected by default if the Limit Workload check box on the Instructor Assignment Class page is also selected. You can change this setting on a term-by-term basis.

Field or Control	Description
Assigned FTE % (assigned full-time equivalency percentage)	Enter the assigned FTE percentage to indicate the percentage of the institution-wide standard (also known as the 100% Weekly Workload Hours field value on the Assignment Type page) to assign to this individual. By default, the system uses this field to display the same value as that set in the Assigned FTE% field on the Instructor Assignment Class page, but you can change it. For example, a value of <i>100.00</i> enables you to assign weekly workload hours to this instructor up to a total term FTE percent of 100. If you want to hold this instructor to only 80 percent of the institution-wide standard, then set the value to <i>80.00</i> . If you often overbook this instructor (perhaps only to ultimately drop the instructor from an assignment at the beginning of the term), then you could set this value to <i>120.00</i> . Total term FTE percent for an individual can never exceed the value specified in this field. You can change this setting on a term-by-term basis.
Instructor Multiplier %	Enter the instructor multiplier percentage to associate with this individual. By default, this field displays the same value as that set on the Instructor Assignment Class page and contributes to the default workload hours formula for courses assigned on the Meetings page. In most instances, you will probably set this field value to <i>100</i> . However, if you want to give a certain instructor double credit for the courses to which they are assigned, set this field value to <i>200</i> for the term. If you want students to receive only half credit for their course assignments, set this field value to <i>50</i> . In addition, you can always assign the instructor to a different instructor assignment class where this field is set to a default value of <i>50</i> . This multiplier does not apply to noncourse-based assignments made directly to the Term Workload page. You can change this setting on a term-by-term basis.
Total Term FTE % (total term full-time equivalency percentage)	Total term FTE percentage represents an individual's actual term assignment percentage. This number is the result of the assignment percentage calculation and decreases or increases automatically as you add, delete, or modify various assignments.
Description	This field has three uses: to enter assignment descriptions manually when new rows are inserted, to view a course title that is derived from assignments made on the Meetings page, or to view a combined section header description when a combined section is assigned to an instructor. <hr/> Note: You cannot add, delete, or modify assignments made on the Meetings page. <hr/>
Subject	Displays the academic subject for the course assigned (if applicable). A subject area is derived from the Course Catalog - Offerings page.

Field or Control	Description
Catalog Nbr (catalog number)	Displays the value associated with this class number, if applicable. A catalog number is derived from the Course Catalog - Offerings page.
Sect (section)	Displays the value associated with this class. Section is derived from the Schedule of Classes - Basic Data page.
Class Nbr (class number)	Displays the autogenerated value associated with the course assigned, if applicable. The class number is derived from the Meetings page.

Workload Assignment Tab

See the previous exhibit for a view of this tab.

Field or Control	Description
Comb Sects ID (combined sections ID)	<p>A combined sections ID appears only when those courses assigned to an instructor comprise combined sections. The combined sections value is created on the Sections Combined Table page. The combined ID description is visible in the table on the Term Workload page, except when the Skip Meeting Pattern & Instructor Edit is selected on the Combined Sections page. In this case, the system considers instructor workload for each of the sections and does not combine hours. If necessary, you can adjust instructor workload hours on the Schedule of Classes - Meetings page.</p> <p>See Creating Combined Sections.</p>
Assign Type (assignment type)	Use this field in one of two ways. Use it to enter assignment types manually when you insert new rows, or use it to view an assignment type that is derived from assignments made on the Meetings page. All assignment types that are effective as of the term begin date are available.
Work Load	Displays the actual workload hours. Use this field to enter workload hours manually when you insert new rows, or use it to view workload hours derived from assignments made on the Meetings page.

Field or Control	Description
App Load (apply load)	This check box determines whether the assignment counts toward an individual's overall assigned full-time equivalency percentage. The App Load check box setting corresponds to the Include Assignment in Workload check box setting on the related Schedule of Classes component and cannot be changed. For manually entered assignments, it can be changed.
Assignment FTE% (assignment full-time equivalency percentage)	The assignment FTE percentage represents the particular assignment's weight based on the 100 percent weekly workload hours value (or the 100 percent OEE weekly workload hours value) for the assignment type. For example, if the 100% Weekly Workload Hours field is set to 15 on the Assignment Type page, and you assign an instructor to teach a 3-hour lecture component with the same assignment type, the assignment FTE percent equals 20 (because 3 hours out of 15 makes 20 percent). The system calculates this number and the user can not modify it.

Job Code Tab

Select the Job Code tab.

This example illustrates the fields and controls on the Term Workload page: Job Code tab. You can find definitions for the fields and controls later on this page.

Term Workload

Dabbs,Constancio ID: SR0405

Workload Definition
Find | View All First 1 of 2 Last

Academic Institution: PSUNV	PeopleSoft University	Total Term FTE%	+ -
Term: 0550	2005 Fall		
Instructor Assignment Class: FULL	Full-time		
Calculate Workload: <input checked="" type="checkbox"/>	Assigned FTE %: 120.00		
Limit Workload: <input checked="" type="checkbox"/>	Instructor Multiplier %: 100		

Workload Assignment
Job Code

*Description	Subject	Catalog Nbr	Section	Class Nbr	Session	Empl Rcd#	Job Code		
Inorg Synthesis and Reactions	CHEM	128	010	1687	Regular Academic Session	0		+	-
Inorg Synthesis and Reactions	CHEM	128	011	1688	Regular Academic Session	0		+	-

Field or Control	Description
Session	Displays the session name (if applicable) and is derived from the Meetings page. Sessions are a simple way to divide a term into multiple periods for offering courses.
Empl Rcd# (employee record number)	Relates job information to instructors for reporting purposes. The system displays a warning message if the FULL_PART_TIME value on the job does not coincide with that same field value on the instructor assignment class record related to the instructor assignment class on the Term Workload page.
Job Code	Displays the value specified on the Accommodations page for a particular employee record.

Viewing and Updating Workload Values on the Meetings Page

Use the Instructors For Meeting Pattern group box on the Meetings page to enter or view workload data for instructors.

Related Links

[Defining Class Meeting Patterns](#)

Using the Workload Copy/Update Process

The Workload Copy/Update process generates a report that classifies instructors who fall into one of the following six categories:

1. Reporting full-time instructors with workload over the allowed assignment.
2. Reporting part-time instructors with workload over allowed assignment.
3. Reporting full-time instructors with workload over the warning limit.
4. Reporting part-time instructors with workload over the warning limit.
5. Reporting full-time instructors with workload under the allowed assignment.
6. Reporting part-time instructors with workload under the allowed assignment.

If you run the process with the **Report Only** check box selected, the process does not update any term workload values. It just produces a report for the target term.

If you run the process with the **Report Only** check box cleared, all schedule of classes data from one term rolls over to another term. However, the Term Copy process alone does not roll forward term workload values. Instead, you must run the Workload Copy/Update process immediately following the Term Copy

process to finish the task. This final step ensures that the process creates term workload records for all copied schedule of classes data.

Prerequisites

Term workload records must exist for the Roll From term.

Page Used to Report and Update Workload Values

<i>Page Name</i>	<i>Definition Name</i>	<i>Navigation</i>	<i>Usage</i>
Workload Copy/Update	RUNCTL_WORKLD	Curriculum Management > Roll Curriculum Data Forward > Copy/Update Workload Process > Workload Copy/Update	Enter report and process parameters.

Reporting and Updating Workload Values

Access the Workload Copy/Update page (**Curriculum Management > Roll Curriculum Data Forward > Copy/Update Workload Process > Workload Copy/Update**).

<i>Field or Control</i>	<i>Description</i>
Academic Institution	The institution for which you are running the process. Academic institution values are defined on the Academic Institution Table page. This field is required.
Report Only	Select to report on instructor workload and not update any values.
Report Term	Use to specify the term for which you want to report. When you select the Report Only check box, the Report Term field appears and all other fields disappear. When you do not select the Report Only check box, the process updates or creates term workload values, or it does both.
Roll From Term	Select the term to reference as the original or source term. This should match the Roll From Term field value on the Term Copy page for the Term Copy process that you run immediately prior to the Workload Copy/Update process. When this field appears, it is required.

Field or Control	Description
Roll To Term	<p>Select the term to reference as the new or target term. This should match the Roll To Term field value on the Term Copy page for the Term Copy process that you run immediately prior to the Workload Copy/Update process. When this field appears, it is required.</p> <p>For example, if your institution uses both the Term Copy and Instructor Workload features, you run the Term Copy process from term <i>X</i> to term <i>Y</i>. Then you run the Workload Copy/Update process from the same term <i>X</i> to the same term <i>Y</i>. At the conclusion of this process, you can view the report to identify any individuals who might need manual adjustments.</p> <p>In addition, you can run the Workload Copy/Update process both from and to the same term if needed. For example, you might originally run the Workload Copy/Update process from term <i>X</i> to term <i>Y</i>. Then, at a later date, you determine that you need to adjust some setup values that relate to the Instructor Workload feature for term <i>Y</i> (for example, assignment type, instructor class, or number of weeks in term or session.) You can change this data wherever necessary and then rerun the Workload Copy/Update process from term <i>Y</i> to term <i>Y</i>. This recalculates your term <i>Y</i> values (assignment FTE percent totals) with the newly adjusted setup values. As always, you have a newly generated report to view.</p> <hr/> <p>Note: The process of creating or updating To Term records references effective-dated information as of the report date (current date). In addition, the assignment FTE percent values are not copied but are dynamically calculated according to the To Term parameters.</p> <hr/> <p>See Copying Classes from One Term to Another.</p>
Copy Non-Course Assignments	<p>Select to include assignments made directly to the Term Workload page for the specified Roll From Term field value.</p>

Note: Should you need to run the Update Workload process more than once with the same value in the **Roll to Term** field, be aware of the **Copy Non-Course Assignments** check box and its usage. If left selected each time that the process is run to the same term, non-course-based assignments are copied. For example, if you run the Update Workload process from fall 1999 to fall 2000, and in fall 1999, instructor A was assigned, on the Term Workload page, to advise the math club for 3 hours and, on the Schedule of Classes - Meetings page, to teach Math 100 for 3 hours, then both the 3-hour non-course advising assignment and the Math 100 course assignment correctly roll forward to fall 2000 as 3 workload hours each. However, if you run the Update Workload process a second time from fall 1999 to fall 2000 (with the **Copy Non-Course Assignments** check box still selected), you add another 3-hour advising assignment to the individual's term workload record. This gives the individual a total of two advising assignments and one class assignment for a total of 9 workload hours. To prevent this type of noncourse assignment copying, during any postprimary runs of the process, clear the **Copy Non-Course Assignments** check box.

Field or Control	Description
Begin with ID and End with ID	To identify a subset of individuals to process, you might want to specify begin-with-ID and end-with-ID parameters. Both of these fields are optional. These fields are not available when you select the Report Only check box. The report always displays all applicable IDs (which might include more than the range of IDs processed).

Walking Through Instructor Workload

Now that you have familiarized yourself with all of the setup pages, walk through the following simple scenarios to help you visualize how everything is integrated. If possible, actually perform this walk through in a sample or test database. The exercise begins with references to the setup table located in the Implementing Instructor Workload Setup Tables documentation.

See [Implementing Instructor Workload Setup Tables](#)

Warning! Although the conclusion of this exercise includes data clean up, there is one Term Workload record that you cannot delete. If you do not have access to a sample or test database, then use the steps below as a reference when you finally implement the feature. Do not perform this walk through in your production database.

To track instructor workload:

Define Assignment Types

First, create assignment types for at least two types of assignments, beginning with lecture and advising.

1. Select **Curriculum Management** > **Instructor/Advisor Information** > **Assignment Type** > **Add a New Value**.
2. Enter an Assignment Type of *LEC* and then the code for your institution.
3. Click **Add**.
4. Enter the following effective date: *01/01/1900*.
5. Enter the following status: *Active*.
6. Enter the following description: *Lecture Assignment Type*.
7. Enter the following short description: *Lecture*.

This description appears in the grid on the Meetings and Term Workload pages.

8. Select the **View on Schedule of Classes** check box.

This causes the assignment type to be an available choice on all of the Meetings pages.

9. Select the **Include Assignment in Workload** check box.

10. Enter 9 in the **100% Weekly Workload Hours** field.

This causes a 3-hour assignment to be converted to 30 percent of an individual's term workload, or, this causes a 9-hour assignment to be converted to 100 percent of an individual's term workload.

11. Enter 0 in the **100% OEE Workload Hours** field.

12. Save.

13. Select **Curriculum Management > Instructor/Advisor Information > Assignment Type > Add a New Value.**

14. Enter an assignment type of *ADV*, and then the code for your institution.

15. Click **Add.**

16. Enter the following effective date: *01/01/1900*.

17. Enter the following status: *Active*.

18. Enter the following description: *Advising Assignment Type*.

19. Enter the following short description: *Advising*.

This appears in the grid *only* on the Term Workload page because you set the next field to *OFF*.)

20. Clear the **View on Schedule of Classes** check box.

This ensures that an assignment type of *ADV* can never be assigned on the Meetings page. Instead, you want to reserve this assignment type for association with assignments made directly on the Term Workload page.

21. Select the **Include Assignment in Workload** check box.

22. Enter 9 in the **100% Weekly Workload Hours** field.

This value means that if you want to give an instructor one course credit for advising, then give them 3 workload hours (or whatever the institution common course count is) for advising in a given term.

23. Enter 0 in the **100% OEE Workload Hours** field.

24. Save.

Define Instructor Assignment Classes

To create instructor assignment class values and their corresponding defaults for two types of employees (beginning with full time and part time):

1. Select **Curriculum Management > Instructor/Advisor Information > Instructor Assignment Class > Add a New Value.**

2. Enter an Instructor Assignment Class of *FT*, and then the code for your institution.

3. Click **Add.**

4. Enter the following effective date: *01/01/1900*.

5. Enter the following status: *Active*.
6. Enter the following description: *Full-Time*.
7. Select *Full Time* in the **Full/Part Time** field.
8. Select the **Calculate Workload** check box.
9. Select the **Limit Workload** check box.
10. Enter *120.00* in the **Assigned FTE %** field.
11. Enter *100* in the **Instructor Multiplier** field.
12. Save.
13. Select **Curriculum Management > Instructor/Advisor Information > Instructor Assignment Class > Add a New Value**.
14. Enter an Instructor Assignment Class of *PT*, and then the code for your institution.
15. Click **Add**.
16. Enter the following effective date: *01/01/1900*.
17. Enter the following status: *Active*.
18. Enter the following description: *Part-Time*.
19. Select *Part Time* in the **Full/Part Time** field.
20. Select the **Calculate Workload** check box.
21. Select the **Limit Workload** check box.
22. Enter *60.00* in the **Assigned FTE %** field.
23. Enter *100* in the **Instructor Multiplier** field.
24. Save.

Activate Workload Feature and Specify Defaults

To activate the workload feature for your institution:

1. Select **Set Up SACR > Foundation Tables > Academic Structure > Academic Institution Table**.
2. Specify your institution, select Correct History, and select Search.
3. Insert an effective-dated row with today's date.
4. Select the Academic Institution 4 tab.
5. Select the **Calculate Workload** check box.
6. Enter *100.00* in the **Full-Time Warning Limit %** field.

7. Enter *50.00* in the **Part-Time Warning Limit %** field.
8. Enter *100* in the **Course Component Workload Hours%** field.
9. Leave the **Academic Progress Units %** field blank.
10. Enter *120.00* in the **Full-Time Assigned FTE %** field.
11. Enter *60.00* in the **Part-Time Assigned FTE %** field.
12. Enter the following assignment type: *LEC*.
13. Enter the following instructor class: *FT*.
14. Save.

Define Academic Subject Component Percentages

Normally, you must enter only component percentages for academic subjects at your institution that you would like multiplied as other than 100. However, just to familiarize you with the page, update the subject of *MATH* with a lecture value of 100.

To define academic subject component percentages:

1. Select **Set Up SACR > Foundation Tables > Academic Structure > Academic Subject Table**.
2. Specify your academic institution and a subject area of *MATH*; select Correct History and then select Search.
3. Select the Subject/Workload tab.
4. Enter the following course component: *Lecture*.
5. Enter the following component multiplier: *100*.
6. Save.

Define Course Catalog Workload Hours Information

To specify workload hours for a course:

1. Select **Curriculum Management > Course Catalog > Course Catalog**.
2. Specify your academic institution and a subject area of *MATH* if possible, select Correct History, and select Search.
3. Select a course from the search results.
4. Select the Components tab.
5. Verify that a component of *lecture* exists and has a workload hours value of 3. If not, update appropriately and **Save**.

Note any changes that you make to this course for cleanup later.

6. Note the following data:

- Course ID _____.
 - Course Component _____.
7. View Class Component Workload Hours Information.
 8. Make sure that you have the course scheduled and that you have specified values correctly in the **Workload Hrs** (workload hours) field on the Class Components page.
 9. Select **Curriculum Management > Schedule of Classes > Adjust Class Associations**.
 10. Specify your academic institution, a future, or current term (if you are using a PeopleSoft sample data database, enter *0460*), and the Course ID noted above.
 11. Select Correct History and then select Search.
 12. Select the Class Components tab.
 13. Note the following data for the component:
 - Term _____.
 - Associated Class Nbr _____.
 14. Verify that the lecture component exist, and that the corresponding workload hours read.

With regularly scheduled classes, this defaults from the catalog. If this is not a newly scheduled class, enter a value of 3 in the **Workload Hours** field.
 15. Save the page.
 16. Now take a look at another place that you can go to view or update Workload Hours data.

Use the following optional menu path after a component has been scheduled for a term but later needs to be accessed for review or minor updates. The performance opening these pages is ideal because only the meeting that you need for viewing or updating is loaded.
 17. Select **Curriculum Management > Schedule of Classes > Schedule New Class > Meetings**.
 18. Enter your institution, term, and course ID.
 19. Click **Search**.
 20. Notice that this component is much smaller than that of the regular schedule of classes (only three pages).

Because you are loading less data, the pages open more quickly. Note that on this page, you can make changes to the workload hours for the meeting and the assignments themselves.
 21. Do not make any additional changes.

Define an Individual's Term Workload Information

To define an individual's term workload information:

1. Select **Curriculum Management > Instructor/Advisor Information > Instructor Term Workload**.
2. Enter an ID (*Instructor A*) and code for your institution.
3. Click **Search**.
4. Note the following data: ID_____.
5. Insert a row for the same term that you used previously for the class component.
6. Change the instructor assignment class to *PT* from Academic Institution Page 4 default of *FT* and exit the field.

Notice that all of the PT defaults autopopulate the check boxes and **Assigned FTE %** (assigned full-time equivalency percent) field. This is to show you how the check boxes and fields populate their default values. Now set your Instructor Assignment Class back to *FT*.

7. Select the **Calculate Workload** check box.
8. Accept the default of selected in the **Limit Workload** check box from the Instructor Assignment Class page.
9. Change the value in the **Assigned FTE %** field to *100.00*.

This ensures that you never assign the instructor to more than 100 percent of the full-time standard workload (9 workload hours in this example). If you wanted some slack, for give and take during scheduling, leave this at *120.00*, or even increase it.

10. Change the value in the **Instructor Multiplier** field to *200*.

Note that this does not double count assignments made directly to the Term Workload page.

11. Save.

Do *not* exit the page.

12. Assign Noncourse Based Assignments.
13. Manually assign a noncourse assignment of Advising to the previous ID (*Instructor A*).
14. Place cursor in Description field on the Workload Assignment tab and type "Advising the Math Club."
15. Enter the following assignment type: *Advising*.
16. Enter the following workload: 3.
17. Save.
18. Notice that the **Assignment FTE %** (assignment full-time equivalency percent) field on the Workload Assignment tab autogenerates a percentage value of 33.33 percent.

This is using the formula for instructor assignments made directly to the Term Workload page. Remember, our 100 percent weekly workload hours for this assignment type are 9; therefore, 3 workload hours make up 33.33 percent of the instructor's total term FTE. Also notice that this value

contributes to the overall Total Term FTE percent value for instructor A. Exit this page for now. You will return to it later.

Assign Course Based Assignments

To assign instructor A to a course using the Schedule of Classes - Meetings page:

1. Select **Curriculum Management** > **Schedule of Classes** > **Maintain Schedule of Classes**.
2. Enter the same term and course ID that you used in the steps above.
3. Click **Search**.
4. Select the Meetings tab.
5. On the Meetings - Assignment page, enter the ID for instructor A in the ID field, and exit the field.
6. Select the Workload tab.
7. Look at the **Assignment Type** field and notice that you do *not* see *ADV* as a choice. (because when setting up *ADV* as an assignment type, you cleared the view on **Schedule of Classes** check box).
8. Set the assignment type to *Lecture*.
9. Notice that workload hours read 6.

This is because you set the instructor multiplier to 200 percent, so every 3-hour assignment in this term counts as double workload hours. The 3 becomes a 6.

10. Notice that the **Assignment FTE %** (assignment full-time equivalency percent) field populates and represents that this course is worth double.
11. Save.

View an Instructor's Term Workload Summary

To return to Term Workload page to view instructor A's new workload information.

1. Select **Curriculum Management** > **Instructor/Advisor Information** > **Instructor Term Workload**.
2. Enter same ID for instructor A and code for your institution, and click Search.
3. Scroll to the term you used in steps above.
4. Looking at the page, you can now see both assignments: one made on the Term Workload page and another made on the Meetings page.

Notice that the course assigned on the Meetings page is actually counting double toward FTE. This is because you set the default Instructor Multiplier for this instructor to 200 percent.

Assign Workload for One Class Component to Two Instructors

To allow two instructors to share the responsibility of teaching the math class:

1. Return to the math class on the Schedule of Classes - Meetings page to update the assignments.

2. Select **Curriculum Management > Schedule of Classes > Maintain Schedule of Classes**.
3. Enter the same term, subject, and course you used in the previous steps, and click **Search**.
4. Select the Meetings tab.
5. Go to the **Instructors For Meeting Pattern** group box, select the Workload tab, and change the existing load factor for instructor A from *100.00* to *50.0*.

Notice changes in workload hours and assignment FTE percent.

6. Insert another row on the Workload tab and add another instructor.

Refer to this second instructor as *Instructor B*. Alter instructor B's load factor to *50*. Remember, it is the user's responsibility to set load factor, and it is also the user's responsibility to ensure that the combined load factor for a course component equals 100, if that is what you want. In some rare instances, you might want them to equal more than 100, but this is not recommended.

Therefore, in looking at the grid, you have now specified that instructor A shall teach 50 percent of the class, and instructor B shall teach the other 50 percent.

7. Save.

View an Instructor's Updated Term Workload Summary

Now return to the Term Workload page for instructor A. Because you have altered the instructor's load factor to 50 percent for the math course, you should notice an overall decrease in the total term FTE percent.

To view an instructor's updated term workload summary:

1. Select **Curriculum Management > Instructor/Advisor Information > Instructor Term Workload**.
2. Enter an ID for instructor A and a code for your institution, and click **Search**.
3. Scroll to the term that you used in the previous steps.
4. Notice that updates made to the Meetings page automatically update the Term Workload record.

In addition, notice on this page that you cannot edit anything created on the Meetings page. If you want to change anything associated with an assignment made on the Meetings page, you must return to the Meetings page and make the change. The only assignments that you can modify on the Term Workload page are the non-course-based assignments.

5. Do not cancel the page.

Review Warning Limits

On the Term Workload Page, let us try some of the soft and hard warnings that you created. You set up institution-wide soft warning limits and some default FTE percentage hard warning and error limits on the Academic Institution 4 page. Keep the Term Workload page open and open the Academic Institution 4 page in a new window to review your earlier work.

To test the warnings that you set up:

1. Select **Set Up SACR > Foundation Tables > Academic Structure > Academic Institution Table**.
2. Specify your institution, select Correct History, and select Search.
3. Select the Academic Institution 4 tab.
4. Verify the following values in the listed fields:
5. Select the Academic Institution 4 tab.

The page should have the following values in the listed fields:

- Institution Wide *Soft* Warnings (which apply to all individuals where their Term Workload page has the **Calculate Workload** check box selected): Full-Time Warning Limit %: *100.00*; Part-Time Warning Limit %: *50.00*.
- Default FTE % Values/*Hard* Warnings (which serve as defaults on the Instr Assign Class page): Full-Time Assigned FTE %: *120.00*; Part-Time Assigned FTE %: *60.00*.

You can change these each time that you create a new Instructor Assignment Class. However, in order to minimize this type of change, pay special attention to the values that you enter. Try to make them as accurate as possible so that you can take full advantage of the data entry benefit this default provides

6. Look back at instructor A's Term Workload record.

Notice that the instructor already has an assigned FTE percent value for the term. Because of this, the default full-time assigned FTE percent value on the Academic Institution 4 page can *not* be used because instructor A does not need to rely on default FTE percent values for this term. Instead, instructor A has an assigned FTE percent value of *100*. This means that instructor A can never be assigned to more than 100 percent of the full-time standard (set up as 9 hours on the Assignment Type page for both *ADV* and *LEC*).

Test the Workload Limits

Close the Academic Institution 4 page, leaving just the Term Workload page open.

To test workload limits:

1. In the same term that you have been using, manually assign instructor A to a second advising assignment worth 4 workload hours.

This takes instructor A over the assigned FTE percent of *100* (or 9 hours in this example). Exit the workload hours field, attempt to save the page, and notice the hard warning or error that appears.

2. If you want to override this and save the assignment, you must increase the assigned FTE percent.

Set the percentage to 120, and try the assignment again. On second attempt, you should receive only institution soft warnings.

3. Save the page.
4. Before you move on to the next test, delete the second advising row that you just inserted, and set the assigned FTE percent to *110*.

Instructor A should now have two rows on the Term Workload page for this term: one for advising the Math Club and another for the math course. The total term FTE percent should be 66.66 percent.

5. Save.

Limits Elicited by Using the Meetings Page

Select **Curriculum Management** > **Schedule of Classes** > **Maintain Schedule of Classes**.

1. Enter the same term, subject, and course that you used in the previous steps, and click Search.
2. Select the Meetings tab.
3. On the Meetings page Workload tab, go to the row in the grid for instructor A and manually enter a workload hour value of 6.5 for this math course, exit the field, and try to save.

You should get a soft warning that this creates a workload over the institution-wide preference, but you can save because you are not exceeding instructor A's individual assigned FTE percentage for the term.

4. Save but do not exit the page.
5. Return to the workload field and change the 6.5 to 7, exit the field, and try to save.

Notice that you get the hard warning and error that this exceeds instructor A's allowable assignment FTE percentage. The system does not permit you to save. The only way to override this and continue would be to navigate back to the Term Workload page for this individual and increase his or her assigned FTE percentage for the term.

6. Exit the page without saving.

Limits Viewed by Using the Workload Copy Report

Running the Workload Copy/Update process disregards error and warning limits so that the overall process runs successfully and completely. However, there is a follow-up report that tells you which individuals were assigned and whether either their individual assigned FTE percentages or institution-wide warning limits were exceeded.

Because you know that, in the previous example, instructor A has a total term FTE percentage in excess of the institution-wide warning standard, let's run the report and see how this instructor appears on the report.

1. Select **Curriculum Management** > **Roll Curriculum Data Forward** > **Workload Copy/Update**.
2. Enter a run control.
Select **Add a New value**.
3. Select the **Report Only** check box and enter the term that you have been using.
4. Save.
5. Click the **Run** button, select your process scheduler parameters, and click the **OK** button.
6. Allow the process to complete, then click the **Report Manager** link.

7. Enter a process type of *SQR Report*, then click the **Refresh** button.

The Workload Copy and Recalc (workload copy and recalculate) report should appear in the report list.

8. Click the **View** link to view the report.
9. Select the SRWRKLD.PDF file to view the report.

In viewing the report, you can see that the instructor A appears under the Reporting Full-Time Instructors with Workload over Warning Limit (100 percent) heading.

At this point, you wonder why you have sections entitled Reporting Instructors with Workload over Allowed Assignment.

If there is a hard warning in the system, how could individuals ever get in this predicament? Remember what happens when you run the Workload Copy/Update process from one term to another. The process can assign workload that exceeds limits if setup values differ between terms. This is why it is imperative that you always view this report after you run the Workload Copy/Update process. If you find that any individuals have exceeded their assigned FTE percentages for the term, you can easily identify them and modify their term workload records. You can also make adjustments on the Meetings page.

10. Because you will not run the Workload Copy/Update process at this time, close the report and exit the Update Workload page.

Walk Through Cleanup

Even though you are now in a test database, before you complete this exercise, you might want to clean up all of the data that you have just entered. To do so, follow these steps:

1. Remove Instructors A and B From the Math Course.
2. Select **Curriculum Management > Schedule of Classes > Maintain Schedule of Classes**.
3. Enter the same term, subject, and course that you used above.

Click **OK**.

4. On the Meetings page, delete both rows in the grid for instructors A and B, exit the field, and save.
5. Delete the Term Workload Records for Instructors A and B.
6. Select **Curriculum Management > Instructor/Advisor Information > Instructor Term Workload**.
7. Enter an ID for instructor A and a code for your institution, and click **OK**.
8. Delete appropriate term data.
9. Select **Curriculum Management > Instructor/Advisor Information > Instructor Term Workload**.
10. Enter an ID for instructor B and a code for your institution, and click **OK**.
11. Delete appropriate term data.

12. Remove Workload Hours for the math course.
13. Select **Curriculum Management > Schedule of Classes > Adjust Class Associations > Class Components.**
14. Enter the institution, term, and course that you have been using, and click OK.
15. Delete the workload hours of 3 for the lecture component and save.
16. Select **Curriculum Management > Course Catalog > Course Catalog > Correction.**
17. Enter the institution and course that you have been using, and click OK.
18. Delete the workload hours specified for the lecture component and save.
19. Remove Subject Component Multiplier for the Math Course.
20. Select **Set Up SACR > Foundation Tables > Academic Structure > Academic Subject Table > Subject Workload.**
21. Enter the code for your institution and the code for the math course, and click OK.
22. Delete the row for lecture and save.
23. Turn off the feature at the institution level.
24. Select **Set Up SACR > Foundation Tables > Academic Structure > Academic Institution Table > Academic Institution 4.**
25. Enter the code for your institution, and click OK.
26. Go to the row inserted with today's date, delete this row, and save.
27. Delete instructor assignment classes.
28. Select **Curriculum Management > Instructor/Advisor Information > Instructor Assignment Class > Correction.**
29. Enter the instructor assignment class of *PT*, and then click OK, Delete, and Save.
30. Select **Curriculum Management > Instructor/Advisor Information > Instructor Assignment Class > Correction.**
31. Enter the instructor assignment class of *FT*, and then click OK, Delete, and Save.
32. Delete assignment types.
33. Select **Set Up SACR > Foundation Tables > Academic Structure > Assignment Type > Correction.**
34. Enter an assignment type of *ADV* and the code for your institution, and then click OK, Delete, and Save.
35. Select **Set Up SACR > Foundation Tables > Academic Structure > Assignment Type > Correction.**

36. Enter an assignment type of *LEC* and the code for your institution, and then click OK, Delete, and Save.

Note: You cannot inactivate or delete the autogenerated *NON* assignment type. Leave this value as delivered.

Managing Student Programs, Plans, and Subplans

Understanding Academic Program and Plan Activation

A student must be active in an academic program and plan to later be activated into a term for that academic program and plan. You can activate students into academic programs and plans by either of the following methods:

- Transmit the student's academic program and plan data through the Activate Applications matriculation process (ABPCPPRC) in Recruiting and Admissions, this being the usual method.
- Enter the student's academic program and plan data manually in the Student Program/Plan component.

The system stores the student's academic program and plan data on rows in the academic program table (ACAD_PROG). Collectively, all of a student's rows in the ACAD_PROG table are called the student's *program stack*. Now the individual is active in an academic program and plan and qualifies for activation into a term.

Related Links

“Updating Applications” (Recruiting and Admissions)

Understanding Program Actions and Statuses

When you execute program actions to change a student's program data, the corresponding program action status often changes. For your reference, the program actions and program statuses relevant to Student Records are explained in the following table:

Program Action Selected	Explanation	System Updates Program Status To	Additional Steps Required
ACTV (Activate)	A student is ready either to enroll in a term or to be evaluated for transfer credit.	Active in Program	None
WADM (Administrative Withdrawal)	A student is withdrawn for administrative reasons.	Canceled	Post the withdrawal on the student Withdrawal page.

Program Action Selected	Explanation	System Updates Program Status To	Additional Steps Required
COMP (Completion of Program)	A student has completed the program.	Program Complete	If the student is ready for graduation processing, complete the graduate process on the Student Degrees page.
DEFR (Defer Enrollment)	A person has been admitted, and may be active for one admit term, but will actually enroll in a later admit term. This action lets you change the admit term for the applicant and record that they are deferring enrollment.	The last action's program status.	None
DATA (Data Change), PRGC (Program Change), PLNC (Plan Change)	Data relative to a student's program, plan, or career status was changed.	No status effect.	When you change a student's program with one of these program actions and the start date of the new program is after the effective date of the change, the system automatically resets the Form of Study field on the student's career term record to the default value of enrollment (<i>ENRL</i>). Use the Form of Study field on the Term Activation page to specify a value other than the default.
DISM (Dismissal)	A student is dismissed from the academic institution.	Dismissed	Post the withdrawal on the student Withdrawal page.
DISC (Discontinuation)	A student discontinues attendance.	Discontinued	Post the withdrawal on the student Withdrawal page.
LEAV (Leave of Absence)	A student takes a leave of absence from his program.	Leave of Absence	None

Program Action Selected	Explanation	System Updates Program Status To	Additional Steps Required
RADM (Readmit)	A person has applied to reenter a student career and academic program for which they already have a student record.	Active in Program	When you choose this action, the Career Number field on the Admissions Application Maintenance page becomes editable. On the Application Maintenance page, you must select which student record should be populated with the readmit information if the student enrolls again. Additionally, if you enter this action, the admit type that you enter on the Application Data page must be associated with readmit processing.
RLOA (Return from Leave of Absence)	A student returns from a leave of absence.	Active	Activate the student.
REVK (Revoke Degree)	Revoke a student's degree. The system automatically updates the student degree tables. Revoked degrees do not appear on the student transcript.	Active	Activate the student.
SPND (Suspension)	A student is suspended from your academic institution.	Suspended	Post a withdrawal on the student Withdrawal page.
TRAN (Transfer to Other Career)	A student makes an intercareer transfer.	Program Completed	Activate the student in the new academic career.
ADRV (Admission Revocation)	A person was admitted into an academic program, but it was later determined that the person did not qualify for admission.	Cancelled	None
MATR (Matriculation)	A person has completed all necessary steps to become an active student in an academic program.	Active	Activate the student into the academic program.

Related Links

“Understanding Admissions Program Actions and Statuses” (Recruiting and Admissions)

Understanding Program Actions Where Future Enrollments Exist

For certain program actions, if you enter the program action but the student is enrolled in classes where the start date of the term is after the effective date of that program action, the system displays a warning message because these are future enrollments. The program actions affected by future enrollments are the following:

Code	Description	Status
ADRV	Admissions Revocation	Cancelled
COMP	Completion of Program	Completed Program
DISC	Discontinuation	Discontinued
DISM	Dismissal	Dismissed
LEAV	Leave of Absence	Leave of Absence
SPND	Suspension	Suspended
TRAN	Transfer to Other Career	Completed Program
VDIS	Voluntarily Discontinued	Discontinued
WADM	Administrative Withdrawal	Cancelled

If you receive the warning message for one of these program actions, then perform the appropriate action on the student's future class enrollments. Because each academic institution has different policies, the warning message alerts so that you can take action based on your institution's policies.

For example, if you enter a program action of *DISM* (Dismissal) and the student has registered and paid tuition for classes in the following term, your institution might require that you drop the student from the courses and issue a full refund.

Or, if you enter a program action of *COMP* (Completion of Program) and the student has registered for classes in the following term, your institution might require that you activate the student in a nondegree-seeking program by changing the student career number to the new academic program on the Term Activation page. This enables the student to continue attending the academic institution.

Understanding Program Actions Where Future Active Terms with No Enrollment Exist

If you enter certain program actions and a student is active in a future term or terms, where the start date of the term is after the effective date of that program action, and the student has no enrollment in the term or terms, the system displays a warning message. The program actions affected by future active terms with no enrollment are:

Code	Description	Status
COMP	Completion of Program	Completed Program
DISC	Discontinuation	Discontinued
DISM	Dismissal	Dismissed
LEAV	Leave of Absence	Leave of Absence
SPND	Suspension	Suspended
TRAN	Transfer to Other Career	Completed Program
VDIS	Voluntarily Discontinued	Discontinued
WADM	Administrative Withdrawal	Cancelled

You can still save the program action change when you receive the warning message.

If you change the severity of the message (Message Catalog entry 14600, 870) to *Error*, you cannot save the change to the program action. To access the Message Catalog, select **PeopleTools** > **Utilities** > **Administration** > **Message Catalog**.

Maintaining Student Program Stacks

This section discusses how to:

- Maintain student academic programs.
- Select a student's career requirement terms.
- Maintain student academic plans.
- Maintain student academic subplans.
- Maintain student additional information.

- (AUS) Enter Australia-specific student program information.
- (CAN) Enter ESIS student program data.

Pages Used to Manage Student Program Stacks

Page Name	Definition Name	Navigation	Usage
Student Program	STDNT_PROG	Records and Enrollment > Career and Program Information > Student Program/Plan > Student Program	Add an academic program to a student's program stack, maintain the student's academic program record, or run program actions that update the student's academic program record.
Career Requirement Term	STDNT_CAREER_SP	Click the Career Requirement Term link on the Student Program page.	Select the student's career requirement term.
Student Plan	STDNT_PLAN	Records and Enrollment > Career and Program Information > Student Program/Plan > Student Plan	Add an academic plan to a student's academic program or modify a student's existing academic plan.
Student Sub-Plan	STDNT_SUB_PLAN	Records and Enrollment > Career and Program Information > Student Program/Plan > Student Sub-Plan	Add an academic subplan to a student's academic plan, or modify a student's existing academic subplan.
Additional Information	STDNT_PROG_CAF	Records and Enrollment > Career and Program Information > Student Program/Plan > Additional Information	Enter or update common attributes for student program, plan and subplan.
AUS Student Program	SSR_STD_PRG_AUS	Records and Enrollment > Career and Program Information > Student Program/Plan > AUS Student Program	Enter Australia specific information for the student. Note: The fields on this page are available only if the Australian DEST, HECS, Centrelink, TAC check box is selected on the Academic Institution 6 page.

Page Name	Definition Name	Navigation	Usage
Cdn Student Program (Canadian student program)	CAN_RPT_STD_ENR	Records and Enrollment > Career and Program Information > Student Program/Plan > Cdn Student Program	<p>Note: This page is available only if the Canadian Government Reporting check box is selected on the Academic Institution 6 page.</p> <hr/> <p>Define ESIS student program data.</p>

Related Links

[Tracking Student Attributes](#)

[Verifying and Updating Student Degree Data](#)

Maintaining Student Academic Programs

Access the Student Program page (**Records and Enrollment > Career and Program Information > Student Program/Plan > Student Program**).

This example illustrates the fields and controls on the Student Program page. You can find definitions for the fields and controls later on this page.

The screenshot shows the 'Student Program' page for student Anna Kirby (ADCAF0002). The page is divided into several sections:

- Header:** Student Program, Student Plan, Student Sub-Plan, Additional Information, Student Attributes, Student Degrees, AUS Student Program.
- Student Information:** Anna Kirby, ADCAF0002, Academic Career: Undergraduate, Career Requirement Term, Student Career Nbr: 0.
- Status and Dates:** Status: Active in Program, *Effective Date: 30/08/2013, Effective Sequence: 4, Action Date: 30/08/2013.
- Program Details:** *Program Action: MATR (Matriculation), Action Reason, *Academic Institution: PSUNV (PeopleSoft University), *Academic Program: LAU (Liberal Arts Undergraduate), *Admit Term: 0830 (2019 Fall), Requirement Term: 0830 (2019 Fall), Expected Grad Term.
- Admissions:** From Application (checked), Application Nbr: 00026464, Application Program Nbr: 0.
- Other Fields:** *Campus: WALCR (Walnut), *Academic Load: Full-Time, Academic Shift: day shift.
- Footer:** APT Instance, Cohort Tag: FALL-ADMIT, Last Updated On: 30/08/2013 8:36:19AM, By: SAD_APL_PRG - PS.

Field or Control	Description
Academic Career	The academic career to which the student's academic program belongs. Students can be active in multiple academic careers, either consecutively or concurrently.
Career Requirement Term	Click to access the Career Requirement Term page.
Student Career Number	Differentiates a student's multiple academic programs within the same academic career. The default value is zero. For students with multiple academic careers, you can keep the default value. For students with multiple academic programs within the same academic career, you must select a unique academic career number for each academic program that you add. The lowest career number designates the student's primary academic program within the academic career. A student's primary academic program controls the values of various fields on the student's career term record (STDNT_CAR_TERM).
Status	Indicates the high-level relationship that the student has with the academic program specified on a given row as of the effective date of the row.
Effective Date	Enter the date on which the program action and the other field values on the row becomes effective. If a term has begun and you must update a student's academic program so that a new academic program is the primary one, you must use an effective date that is prior to the maximum program effective date for that term.
Effective Sequence	Determines the sequencing of changes to a student's program. The system increments this number whenever you enter new effective-dated changes to a student's academic program data for a given academic career.
Program Action	<p>A change to a student's academic program data. Select the program action that you want to execute.</p> <p>If a student has future enrollments and you enter certain program actions, the system displays a warning message informing you that the student is enrolled in classes after the effective date of the program action.</p> <p>If the program change affects the student's primary academic program, the system resets the FA_ELIGIBILITY field on the STDNT_CAR_TERM table to the appropriate value of the newly assigned academic program, as defined in the Financial Aid Eligible field on the Academic Program page. Plus, the system selects the FA_STATS_CALC field on the STDNT_CAR_TERM table. This indicates to Financial Aid that a relevant change has been made to the student's career term record and that the FA Term Build process should be rerun for the student.</p>

Field or Control	Description
Action Date	The date that the program action was executed. It can be different from the effective date. The system records and displays the action date for tracking purposes.
Action Reason	Indicates why a particular program action was taken or offers a further description of the program action. For example, you can record that a student withdrew from an academic program. The reason that you enter could be <i>Medical Reasons</i> or <i>Change of Program</i> . Select the reason for the program action.
Academic Institution	The system automatically populates the academic institution, which refers to the academic institution that owns the student's academic program.
Academic Program	Select the student's academic program. To change this value as a student changes academic programs, insert a row, select a program action of <i>PRGC</i> , and select a new value for this field.
From Application, Program Number, and Admissions Application Number	If the student's information on the ACAD_PROG table was transmitted into the table through the Activate Applications matriculation process (ABPCPPRC), the From Application check box is selected and the system displays the admissions application number and program number.
Joint Program Approved	Select to track that a student is in a dual academic program. When you select this check box the system activates the Dual Academic Program field, where you must enter the other academic program in which the student is active for this academic career.
Admit Term	<p>Determines the earliest term in which you can activate a student into a term for this academic career. The field value appears by default according to the value transmitted onto the student's record in the ACAD_PROG table through the Activate Applications matriculation process (ABPCPPRC).</p> <p>If you have not run the matriculation process and are performing a quick activation for the student, enter the admit term for the academic program. The admit term you enter must be greater than or equal to the first term valid for the specified program (or plan or subplan). Also, the student's admit term must be less than or equal to the last admit term for the program (or plan or subplan). When you run the Term Activation process, it validates the term in which you are activating the student against the admit term. If the admit term occurs after the activation term, you cannot complete the term activation.</p>

Field or Control	Description
Requirement Term	<p>Indicates the term in which academic advisement degree progress requirements apply to the student for this academic program. The field value appears by default according to the value transmitted onto the student's record in the ACAD_PROG table through the Activate Applications matriculation process (ABPCPPRC).</p> <p>If you have not run the matriculation process and are performing a quick activation for the student, enter the admit term for the academic program.</p>
Campus	<p>Select the campus on which the student will be active in the specified academic program.</p>
Expected Graduation Term	<p>Select the term in which the student expects to graduate from the specified academic program. Expected graduation term is also used in financial aid need analysis.</p>
APT Instance, Year of Program and Cohort Tag	<p>These fields are used for Program Enrollment.</p> <p>See Setting Up Enrollment Cohorts</p> <p>See Linking an APT Instance to the Student Program</p>
Academic Load	<p>Select the academic load that the student will carry within the specified academic program.</p>
Academic Shift	<p>Indicates the attendance pattern under which a student record was created. The field appears if the Use Shift check box is selected on the Academic Institution 3 page.</p> <p>The value here is inherited from the Admissions application when the student is matriculated. If Admissions is bypassed, select a value when manually adding and activating a student.</p> <p>If only the Use Shift check box is selected on Academic Institution 3 page, the Academic Shift field is optional and the values available here are those defined on the Academic Shift page. If the Use Shift by Admit Term check box is also selected, then the values are those defined on the Academic Shift page and then mapped to an admit term on the Academic Shift Mapping page.</p> <p>See “Setting Additional Institution Defaults and Options” (Campus Solutions Application Fundamentals)</p> <p>See “Defining Academic Shifts” (Campus Solutions Application Fundamentals)</p> <p>See “Mapping Academic Shifts to Admit Terms” (Recruiting and Admissions)</p> <p>See “Entering Application Program Data” (Recruiting and Admissions)</p>

<i>Field or Control</i>	<i>Description</i>
Last Updated On and By	The date on which the page was last updated and the name of the user who updated the page.
(NZL) Funding Source	<p>Select the funding source for this student program.</p> <p>This is the funding source applicable to the student and reported to the Ministry of Education Single Data Return (SDR). It defaults to the enrollment record. The value is inherited from the Admissions application when the student is matriculated. If admissions is bypassed, select the value during the quick admit or manual program addition process. This field is mandatory.</p> <hr/> <p>Note: This field appears only for students in New Zealand institutions.</p> <hr/>

Related Links

[Understanding Program Actions and Statuses](#)

[Understanding Program Actions Where Future Enrollments Exist](#)

Selecting a Student's Career Requirements Terms

Access the Career Requirement Term page (click the **Career Requirement Term** link on the Student Program page).

<i>Field or Control</i>	<i>Description</i>
Academic Career	The academic career for which you are defining the student's career requirement term.
Career Requirement Term	Indicates the term in which academic advisement degree progress requirements apply to the student for this academic career. Select the student's career requirement term.

Maintaining Student Academic Plans

Access the Student Plan page (**Records and Enrollment > Career and Program Information > Student Program/Plan > Student Plan**).

This example illustrates the fields and controls on the Student Plan page. You can find definitions for the fields and controls later on this page.

Student Program		Student Plan		Student Sub-Plan		Student Attributes		Student Degrees	
Mark Dain				SR0404					
Academic Career:		Undergraduate		Student Career Nbr:		0		Car Req Term:	
Find View All First 1 of 1 Last									
Status:		Active in Program		Admit Term:		1998 Fall			
Effective Date:		07/25/1998		Effective Sequence:		0			
Program Action:		Activate		Action Date:		07/25/1998			
Action Reason:				Requirement Term:		1998 Fall			
Academic Program:		Lib Arts							
Find View All First 1 of 1 Last									
*Academic Plan:		CLSC-BA		Classics-BA		Major			
*Plan Sequence:		10		Degree:		B.A.			
*Declare Date:		07/25/1998		Degree Checkout Stat:					
*Requirement Term:		0330		1998 Fall		Student Degree Nbr:			
*Advisement Status:		Include		Completion Term:					

Field or Control	Description
Requirement Term	Indicates the term in which academic advisement degree progress requirements apply to the student for the given academic program.
Academic Plan	A valid academic plan is required to activate a student into a term. Select the academic plan for the student. A student can have any number of academic plans within an academic program.
Plan Sequence	The sequence in which degree progress evaluates a student's academic plans. The system increments the plan sequence number each time that you add an academic plan. You can override this value.
Degree	The degree associated with the academic plan.
Declare Date	The date that the student declares the academic plan. The system, by default, displays a date equal to the effective date of the latest program action with a status of <i>Active in Program</i> . You can override this value.
Requirement Term	Indicates the term in which academic advisement degree progress requirements apply to the student for this academic plan. Select the requirement term for the academic plan.
Degree Checkout Status	The degree checkout status when you graduate the student.

Field or Control	Description
Student Degree Number	The system displays this number sequentially after you complete the graduation process. This number also indicates the printing order if multiple degrees are conferred on the same date. The system prints degree information associated with the lowest number first.
Completion Term	The term that the degree requirements were met. The system displays the completion term after you complete the graduation process.
Advisement Status	<p>Determines how the advisement engine processes the academic requirements groups that you have linked to the student's program structure. Select an academic advisement status for the student from the following values:</p> <p><i>Include:</i> Ensures that all requirement groups that match this structure are pulled into an audit.</p> <p><i>Not Include:</i> Ensures that all requirement groups that match this structure are not pulled into an audit.</p> <p><i>Optional:</i> Pulls in requirement groups that match this structure, but does <i>not</i> prevent the overall audit from going complete if unsatisfied.</p>

Maintaining Student Academic Subplans

Access the Student Sub-Plan page (**Records and Enrollment > Career and Program Information > Student Program/Plan > Student Sub-Plan**).

Field or Control	Description
Academic Sub-Plan	Select the academic subplan for the student. A student can have any number of subplans within an academic plan. You can activate students into terms without the student having an academic subplan.
Academic Sub-Plan Type	When you select an academic subplan, the system displays its corresponding type.
Declare Date	The date that the student declares the academic subplan. The system, by default, displays a date equal to the effective date of the latest program action with a status of <i>Active in Program</i> . You can override this value.
Requirement Term	Indicates the term in which academic advisement degree progress requirements apply to the student for this academic subplan. Select the requirement term for the academic subplan.

Maintaining Student Additional Information

Access the Additional Information page (**Records and Enrollment > Career and Program Information > Student Program/Plan > Additional Information**).

This example illustrates the fields and controls on the Additional Information page. You can find definitions for the fields and controls later on this page.

The screenshot displays the 'Additional Information' page for a student. At the top, there are navigation tabs: Student Program, Student Plan, Student Sub-Plan, **Additional Information**, Student Attributes, and Student Degrees. The student's name is Anna Kirby and the ID is ADCAF0002. The Academic Career is 'Career Requirement Term' and the Student Career Nbr is 0. Below this, the 'Program Data' section shows 'Academic Program LAU Liberal Arts Undergraduate'. The 'Program Attributes' section contains three entries:

- *Attribute: StartDate (dropdown), value: 30/09/2013, checkbox: Show in Student SS
- *Attribute: Student Language (dropdown), value: AR, label: Arabic, checkbox: Show in Student SS
- *Attribute: Student Language (dropdown), value: CZ, label: Czech, checkbox: Show in Student SS

Refer to the documentation about the Admissions Additional Information page before you read the following documentation.

See “Entering or Updating Additional Information” (Recruiting and Admissions)

The following Record Contexts are delivered:

- ACAD_PROG (Attribute Record: SSR_PROG_CAF)
- ACAD_PLAN (Attribute Record: SSR_PLAN_CAF)
- ACAD_SUBPLAN (Attribute Record: SSR_SUBPLAN_CAF)

The Additional Information page is available only if you associate at least one attribute with one of the record contexts, using the Record Context page (Set UP SACR, Common Definitions, Common Attributes Setup, Record Context).

See “Defining a Common Attribute” (Campus Community Fundamentals)

See “Associating a Common Attribute to a Record” (Campus Community Fundamentals)

Defining Attributes for the Admissions/Student Records Program Stack

The Record Context allows you to set certain properties for a particular attribute in that context, including whether an attribute is repeatable or required.

Note: When an attribute is set to required, then *from that point forward*, a value must be entered to save the component. If a user inserts a new effective dated row (or makes a change in correction mode) to records which pre-date the implementation of the Common Attribute Framework attribute, *the user must enter a value on the current row as well as any historical or future dated rows in order to save the component. For this reason, we strongly recommend that careful consideration be given when determining whether an attribute should be required.*

Additionally if the required attribute is to be used in a web service, a value must be present in the request XML in order for the service to perform without error. For example, if an attribute field is defined as required on the ADM_APPL_PROG Record Context, then in AAWS that field would need to be required in the User Interface to collect a value allowing the SAD_SUBMITAPPL operation to complete successfully.

See “Understanding AAWS” (Recruiting and Admissions)

For further information about how to set attributes to required or repeatable,

See “Associating a Common Attribute to a Record” (Campus Community Fundamentals)

If the attributes set up for Admissions also exist on the Student Program/Plan stack, the values carry over during the Matriculation process.

See “Entering or Updating Additional Information” (Recruiting and Admissions)

(AUS) Entering Australia-Specific Student Program Information

Access the AUS Student Program page (**Records and Enrollment > Career and Program Information > Student Program/Plan > AUS Student Program**).

This example illustrates the fields and controls on the AUS Student Program page 1 of 2. You can find definitions for the fields and controls later on this page.

Student Program | Student Plan | Student Sub-Plan | Student Attributes | Student Degrees | **AUS Student Program**

Anna Goldsmith SFAUS001

Academic Career Undergraduate Student Career Nbr 2 Career Req. Term Semester 1 - Autumn 2005

AUS Student Program Detail Find | View All First 1 of 1 Last

Status Active in Program	Admit Term 2020 Sem2
Effective Date 17/09/2020	Effective Sequence 0
Program Action Activate	Action Date 17/09/2020
Action Reason	Requirement Term 2020 Sem2
Academic Program Bachelor of Commerce	PeopleSoft Australia Uni

*Mode of Attendance

Total previous RTS EFTSL

Separation Status Code

Cohort

Funding Source

Highest Attainment E620

ATAR E632

Selection Rank E605

VET Study Reason Code E575

VET Labour Force Status Code E576

VET Course Assurance Indicator E619

Exit Award

Exit Award Details

Source Award

Source Academic Career UGRD Undergraduate

Source Student Career Number 0

Source Academic Program BART T6 Bachelor of Arts

Source Academic Plan

This example illustrates the fields and controls on the AUS Student Program page 2 of 2. You can find definitions for the fields and controls later on this page.

Higher Degree by Research

HDR Commencement Date E534

HDR Completion Date E592

Thesis Submission Date E591

Primary field of research code E594

Secondary field of research code E595

Field or Control	Description
Mode of Attendance	<p>Assign a mode of attendance for reporting element 329 to TCSI in the Load Liability, Past Course Completions, Offer Details, and Preference Details Files.</p> <p>Values are:</p> <ul style="list-style-type: none"> • <i>Completed Course - OLAA</i> • <i>External Mode of Attendance</i> • <i>Internal Mode of Attendance</i> • <i>Multi-modal Mode of Attendance</i> • <i>Submission of Original Work</i>
Total previous RTS EFTSL (total previous research training scheme equivalent full-time student load)	<p>Enter any EFTSL amount for the student from a previous institution. This field is used only for research students who require a prior Research Training Scheme EFTSL to be reported to TCSI as element 460 in the student enrollment file.</p>
Separation Status Code	<p>Select the separation status code for higher degree research students.</p> <p>This code is reported in the TCSI Enrollment file as element 465. If the field is blank, element 465 is reported as 9.</p> <p>Values are:</p> <ul style="list-style-type: none"> • <i>Downgrade Doctorate to Masters</i> • <i>Other</i> • <i>Same level transfer</i> • <i>Upgrade Masters to Doctorate</i>
Cohort	<p>Select a cohort for the student that the system can use as the default value when you enroll the student. The system populates this value by default on the Australian regional enrollment data and the field is available to tuition calculation for HECS or tuition fees if the Australian Regional Installation Settings are selected.</p>
Funding Source	<p>Select a funding source for the applicant to indicate the type of place being offered. The funding source can be mapped to the code reportable as element 724 in the TCSI Applications & Offers Collection.</p>
Exit Award	<p>Select to indicate that you're using this student program/plan as an exit award.</p>

See [Defining Cohort Years](#).

Exit Award Details

This region appears when you select Exit Award.

Here, you can select the source student program/plan. The source student program/plan would have been previously reported to TCSI as a course admission together with its reported unit enrollment packets. This student program/plan is reported in the exit award packet. The exit award packet is used to report a higher education award course completion for students who have course admission records with the provider, but these records aren't for courses that were completed. This may be students who choose to exit early with a lesser qualification. For example, they originally attempt to earn a degree, but exit with a diploma.

Higher Degree by Research

<i>Field or Control</i>	<i>Description</i>
HDR Commencement Date E534	Enter the beginning date for a research student. This date works as an override for the Course of Study commencement date (element 534) in the TCSI Load Liability file. If this field is blank, the system determines the date from the admit term begin date.
Thesis Submission Date E591	Enter the date on which the research student submits the thesis (element 591). This date is based on a student's first recorded thesis submission. Leave the field blank for those who are not higher degree by research students.
HDR Research Completion Date E592	Enter the date by which the research student completes the research (element 592). Leave the field blank for those who are not higher degree by research students.

Related Links

[TCSI Reporting](#)

(CAN) Entering ESIS Student Program Data

Access the Cdn Student Program page (**Records and Enrollment > Career and Program Information > Student Program/Plan > Cdn Student Program**).

See [Defining PSIS Student Program Data](#).

Chapter 30

Managing Activities

Understanding Activity Management

Activity management enables your institution to define student requirements at the course level. The heart of activity management is the activity registry. You define learning content within the registry, in a hierarchical structure, where grading options and exam specifics are associated with content types. Registries can apply to a single course or multiple courses that share the same structure and grading and exam requirements.

When the activity registry is completed, it creates a content tree that is a visual representation of the learning content of a course. The major benefit of defining the course content in a tree structure is that it establishes a calculation structure. The overall course mark is calculated from the bottom up; that is, from the lowest level of the tree, or from the child up to the parent. No matter how many elements or levels you create within a content tree, all components listed under a course can combine to calculate the course mark.

Once this course structure is defined it is accessible on a term basis for scheduled class sections or in an academic period for scheduled course examinations. Within these time constructs, the course structure can be organized (Activity Generator), edited administratively (Activity Manager), and the exams can be scheduled (Section Manager).

As students enroll in classes or exam-only courses (EOCs) an Individual Activity Manager (IAM) is created. This record attaches the course activities to a student and allows results to be assigned to their completed coursework.

Users can use the Activity Roster component to access the list of students for a class or exam. The Activity Roster lists all students associated with a given activity and provides each student's academic information. The Result Roster allows users to manually enter activity results and calculate those results to an overall course result. Course results can then be synchronized to a student's Academic Progress Tracker (APT) and student enrollment record.

The following diagram illustrates Activity Management deliverables:

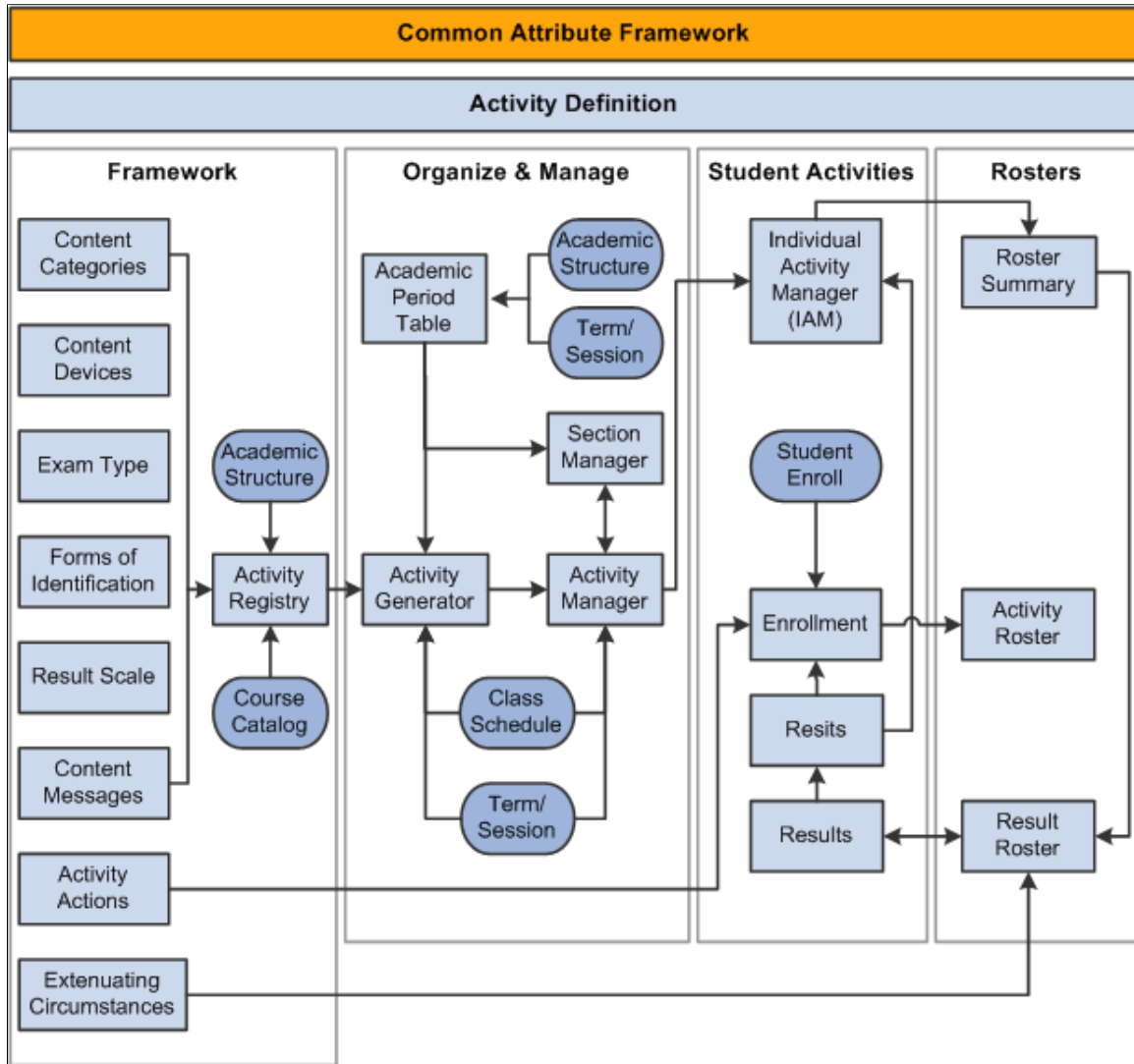

Understanding Results in Activity Management

With Activity Management you greatly enhance the grading capabilities available at the course level. Each activity can have multiple results allowing you to capture marks, grades, and outcomes for which you record a primary result up the course hierarchical content tree. This gives you the opportunity to capture additional result types, such as competency and midterm results.

A number of components are used to set up, control access to, enter, and calculate results. The two essential setup components are the Result Scale where you map any combination of scores, marks, grades and outcomes; and Result Types, where you define which outcomes to track. At least one result type must exist in Activity Management and be associated with the Academic Institution as the primary result. This is the result that is calculated up the content tree and is stored as the official result of the course. This result is calculated using the delivered primary course result rule. To calculate results you must utilize the **Mark** value in your result scale setup.

Additional grading criteria are defined in the Activity Registry for specific coursework items. General content items such as the weight of the item, the result scale, the mandatory pass flag — as well as late penalty criteria, assignment due dates, and extra credit — are defined in the Registry and have a significant impact on grading. The delivered AM Primary Course Result and the AM Late Penalty rules use the registry criteria in calculating the primary result for the overall course utilizing the institution's result scale setup.

Activity Management caters to three consumers – administrative staff, instructional staff, and students. Each group has unique needs and times in which to access result data. Four primary components exist to cater to these groups. Administrative users access the Result Roster secured by academic organization and have full grading and calculating capabilities. These users also have access to student results in the IAM.

Instructional users, including both faculty and exam staff, have access to the Result Roster through the AMWC. Instructional user access and capabilities are defined on several levels:

1. User must be associated with an Academic Organization on the Instructor/Advisor Table.
2. User must be assigned as an instructor on the Class Table or as exam staff in the Section Manager.
3. Define result access Result Dates to indicate when instructional staff can access result rosters to perform specific actions. Result access – to view, grade, calculate – is based on the roster access settings on the Class Table and Section Manager (see tables below).
4. Set **Allow Calculation** flag on the Institution Table.
5. Review Updateable Inclusions on the Activity Manager WorkCenter (AMWC) Settings tab of the Activity Registry component to define which coursework detail can be updated by instructional staff in the AMWC.

Result roster access in the AMWC is based on the roster access defined for Instructors on the Meeting page of the Schedule of Classes or assigned staff on the Section Details page of the Section Manager. Transactional access to the AMWC Result Roster includes the actions to view, grade, and calculate. The following example illustrates how class instructor and exam staff access translates to AMWC actions.

<i>Class Table Roster Access</i>	<i>AMWC Access</i>
Grade	Grade
Approve	Grade and Calculate
Post	Grade and Calculate

Because instructors are assigned at the class level (component in the Activity Management structure) the instructor assigned to the graded component has access to all noncomponent result rosters, meaning that instructor can view and calculate the rosters for the course root, all noncomponent children of the course root, and the exams and exam sections. This provides the instructor of the graded component with the ability to calculate the course primary result.

Section Mgr Roster Access	AMWC Access
View Only	View
Grade	Grade
Calculate	Calculate

Because exam staff are assigned at the exam section level, roster access to the parent exam (and course root if it is an exam-only course) is provided to exam staff with the maximum access that user is provided at the exam section. For instance, if an exam staffer has view access for one exam section and grade access for another exam section, the staffer has grade access at the parent exam.

For students, you must define when to display results. Define this on the Result Dates component for student self service. Activities must also be set up to be viewable in self service. This is a definable content option on all activities within the Activity Manager and its related components.

Results calculated in Activity Management are designed to post to a student's enrollment record (STDNT_ENRL) and the student's Academic Progress Tracker (APT). You define which results to post on the Institution Table and then run the IAM Result Posting batch process to sync results to the APT and the course grade to the graded component official grade on STDNT_ENRL.

Understanding the Delivered Rules in Activity Management

Three result calculations and one evaluation process are delivered for Activity Management. The calculations support standard result calculation when results are entered on the student's IAM, the administrative result roster, or the Activity Manager WorkCenter (AMWC). The calculations are constructed using a variety of methods: the Rules Engine, Activity Management Entities, and page and component editing. The delivered calculations are:

- late penalty processing
- resit result calculation
- overall calculation of the primary result type

The existence of the *Late Penalty Option Inclusion Record* on any Assessment Item, along with a submission date that is later than a due date, triggers the Rules Engine to run the AM Late Penalty Online Driver Rule. The rule may call additional expert-level rules for additional calculation. The system then inserts a late penalty result into the student's result record SSR_IAM_RESULT. Late penalty rows are used in the primary result type calculation. The late penalty inclusion data is setup on the following components: Activity Definition, Activity Registry, Activity Manager, and the Individual Activity Manager.

An evaluation process, kicked off on the IAM Resit Evaluation component, uses the Rules Engine to determine resit eligibility. The system evaluates whether a student is eligible for a resit attempt based on the student's earned mark. Setup values on the Result Scale and the Resit Options for the original attempt are analyzed and if deemed eligible, a new attempt is to be inserted on the student's IAM. When the resit is for an exam activity, the system also assigns the exam period for which the attempt should be taken.

The resit result calculation is called during the calculation of a re-assessed piece of coursework or when a result is entered. A resit result is calculated for the current attempt from the current and previous attempts based on the resit calculation setting in the Activity Manager. The process calculates and inserts a new result row for the current attempt on SSR_IAM_RESULT, and the earn credit flag is placed on the result to be used in the primary result calculation.

The primary result calculation adds coding to the Activity Management Entities and uses the AM Primary Course Result API to calculate hierarchical results based on multiple inclusion record settings that drive processing. The calculation analyzes result types, result scales, include in calculation settings, extra credit, due dates and extended due dates, mandatory pass settings, and insufficient mark options. The process calculates and inserts a new result row on SSR_IAM_RESULT. This calculation can be run on a student, an entire class, or in batch for an entire term, academic period, or subject.

Late Penalty Processing

The late penalty options defined on the Activity Registry include penalizing based on number of days or weeks late with a minimum limit, or subtracting a one-time penalized mark. Users can indicate that a late mark should be capped or fixed at a specific mark. You can also choose to not calculate a penalty. All penalties allow for a mark to be set to 0.0 after a specified amount of time.

The following diagrams outline the processing that generates the late penalty calculations.

Diagram 1 of 4 illustrating late penalty processing:

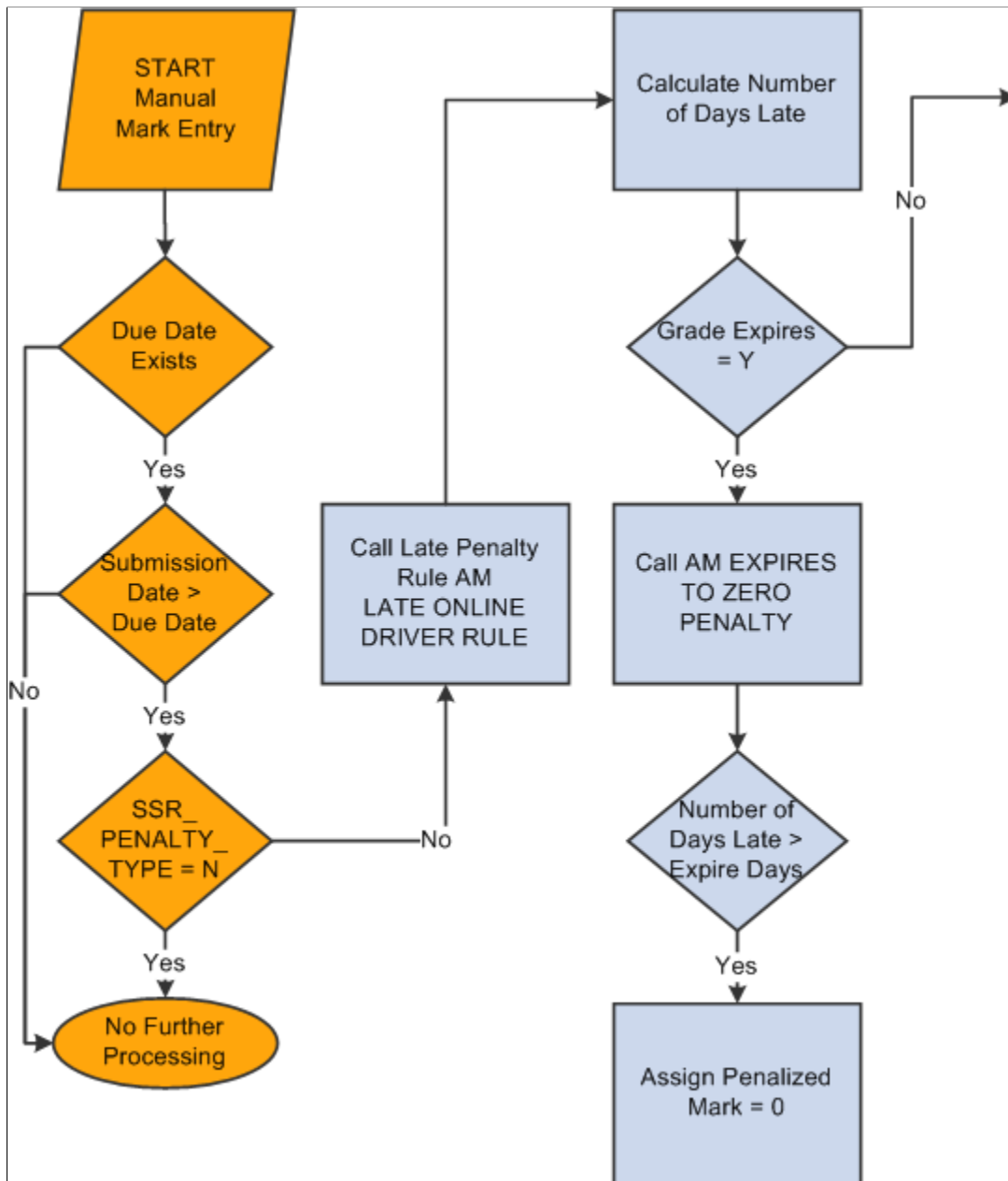

Diagram 2 of 4 illustrating late penalty processing:

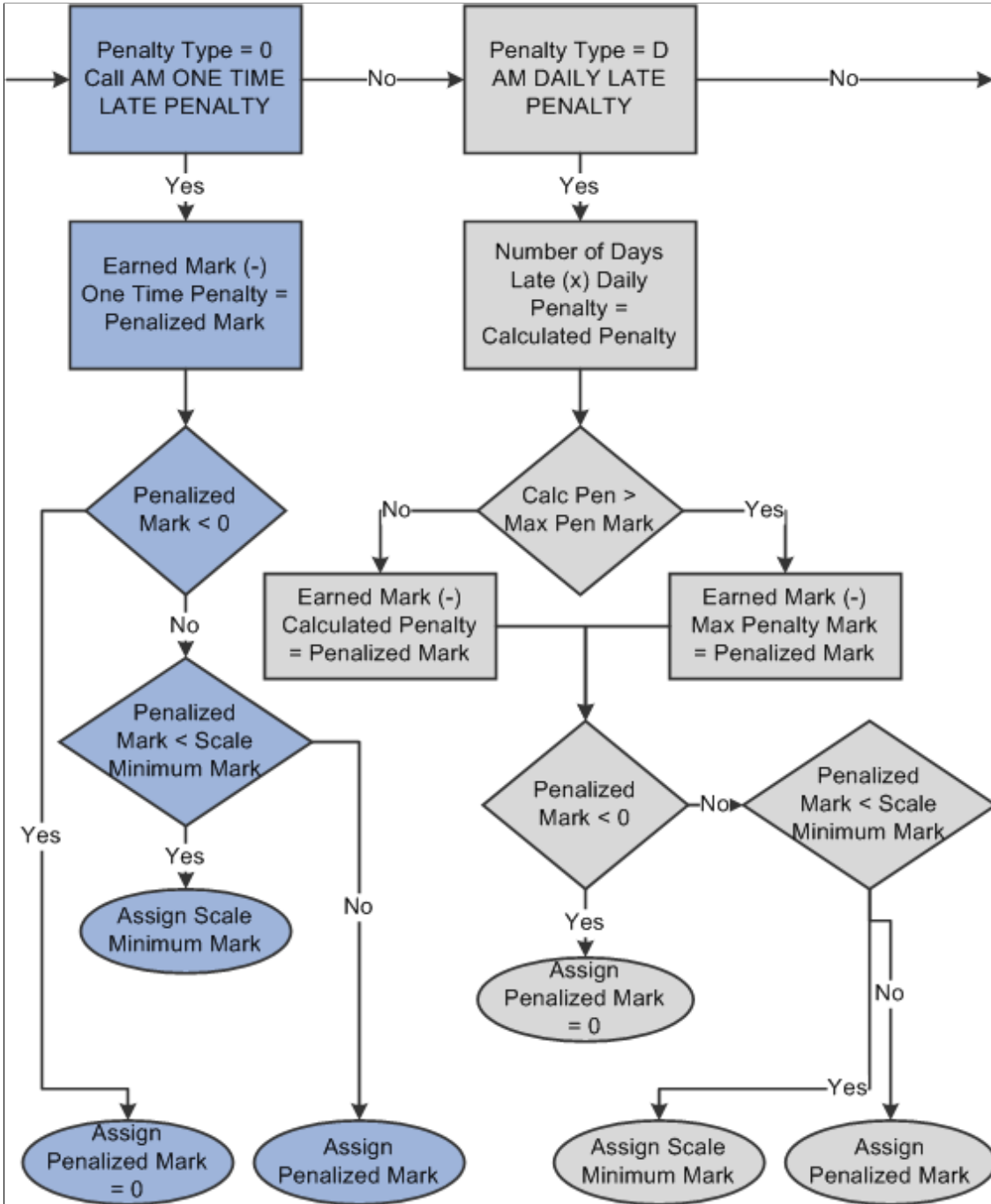

Diagram 3 of 4 illustrating late penalty processing:

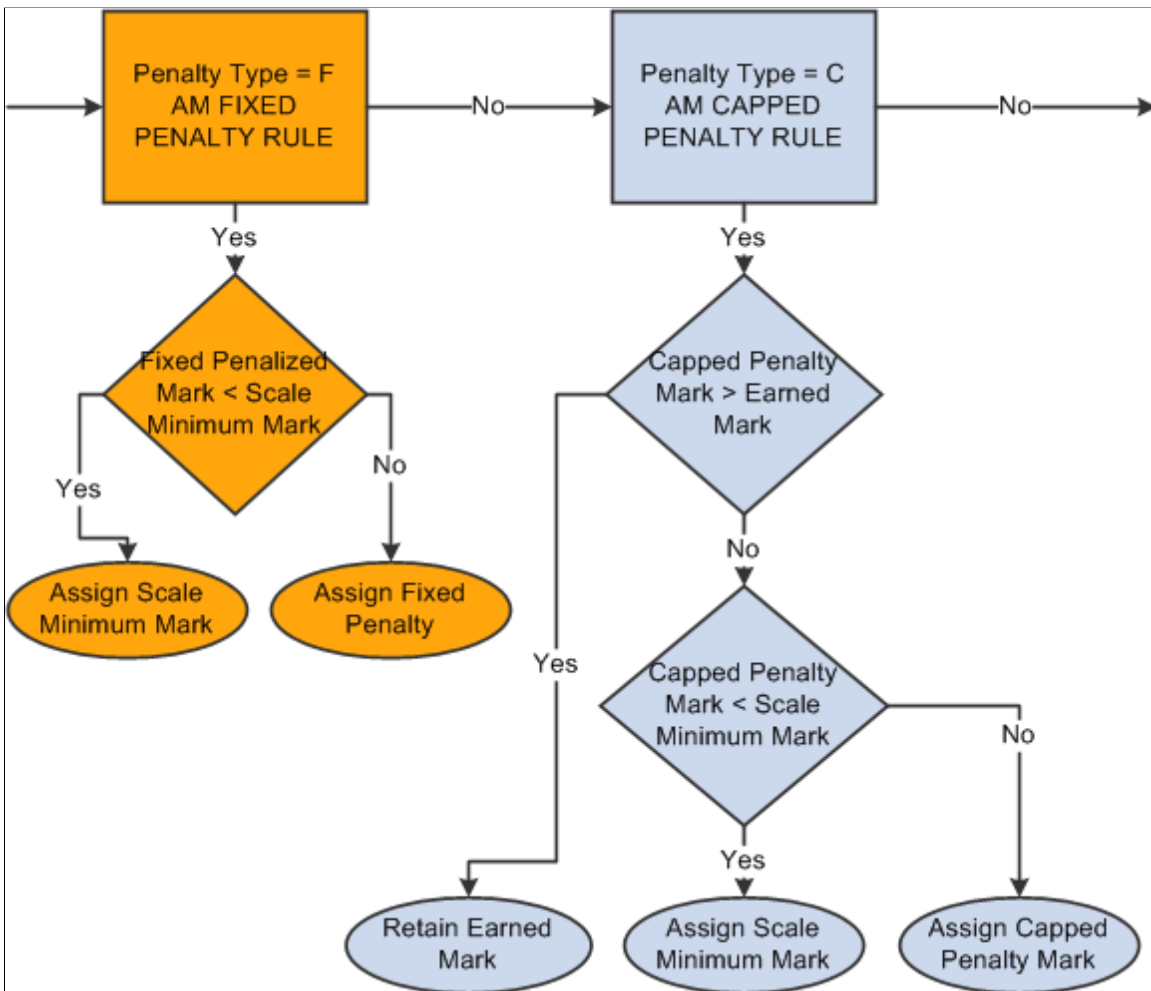
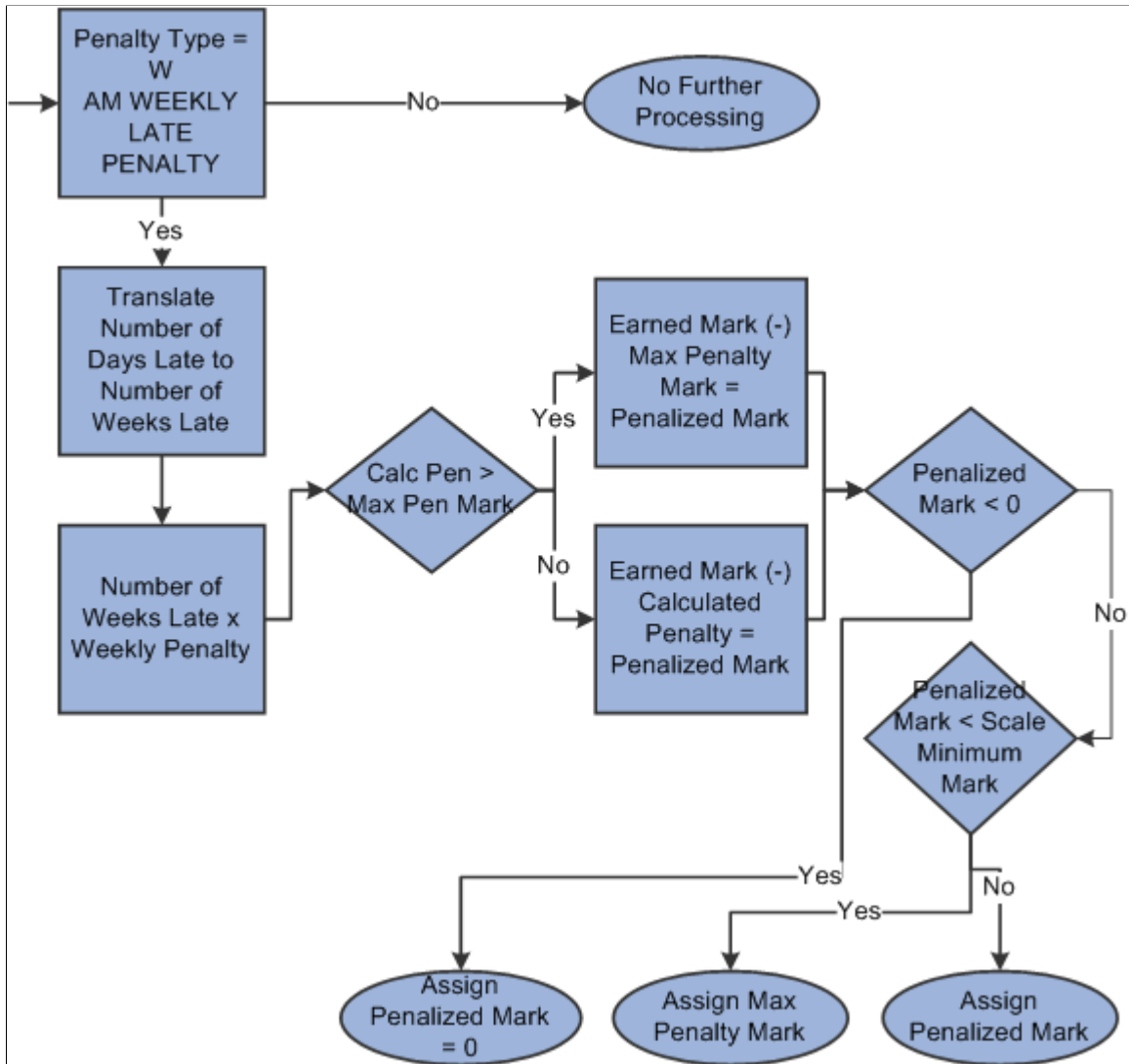

Diagram 4 of 4 illustrating late penalty processing:



The calculated late penalty mark is inserted on a new result row with a result subtype of Late Pen. The row is updated with the following data:

SSR_RSLT_SEQ = +1

SSR_RSLT_SUB_TYPE = L

SSR_INCL_IN_CALC = Y

SSR_IAM_RSLT_STAT = 10

SSR_IAM_MARK = Penalty Mark

During the process, the system removes the **Include in Calc** flag from the original row and inserts it on the new row.

Late Penalty Rules Engine Integration

Below are the triggers and rules defined for late penalties.

Note that to use the rules you must also:

1. Add role security to the Rule Category – AM Calculation Rules.
2. Build the rules (using the Build Rules component).
3. You may also need to run the Wipe and Sync Entity utility.

The delivered Rule Category is AM Calculation Rules - SCC_RULE_CAT_20130425123523.

The delivered Rule Trigger is AM Online Late Penalty Trigger - SCC_RTRIG_20130516132141.

The delivered rules are:

Rule Name	Rule ID
AM Late Penalty Online Driver Rule	SCC_RULE_ID_20130515130457
AM Capped Late Penalty	SCC_RULE_ID_20130521103202
AM Daily Late Penalty	SCC_RULE_ID_20130521095817
AM Expires to Zero Penalty	SCC_RULE_ID_20130516135412
AM Fixed Penalty Rule	SCC_RULE_ID_20130521094603
AM One Time Late Penalty	SCC_RULE_ID_20130508133749
AM Weekly Late Penalty	SCC_RULE_ID_20130515141726

Primary Result Processing

The primary result calculation analyzes result related setup from a variety of sources as well as calls the rules engine to calculate the overall weighted average mark. The data analyzed during the primary result calculation includes:

- Result Scale
 - Mark - grade - outcome mapping.
 - Identifies scales without marks, analyzes mandatory pass setting.
 - Identifies the insufficient mark setting.
 - Identifies resit result settings.
 - Identifies different result scales.

Activity Registry supports the ability to configure different result scales for each activity and the ability to convert the marks from different result scales (parent/child) in primary result calculation.

For detailed information, see *Calculation of Overall Course Results using Multiple Result Scales* on My Oracle Support (Doc ID 1400723.1).

- Result Type
 - Determines the Primary Result Type.
 - Checks result scale security.

- General & Inclusion Options
 - Content Options – result scale, weighting, assessed flag, include in calculation flag
 - Extra credit
 - Insufficient Mark option
 - Mandatory Pass field
 - Dates & Duration
 - Resits

The following diagrams outline the primary result calculation.

Diagram 1 of 3 illustrating primary result calculation:

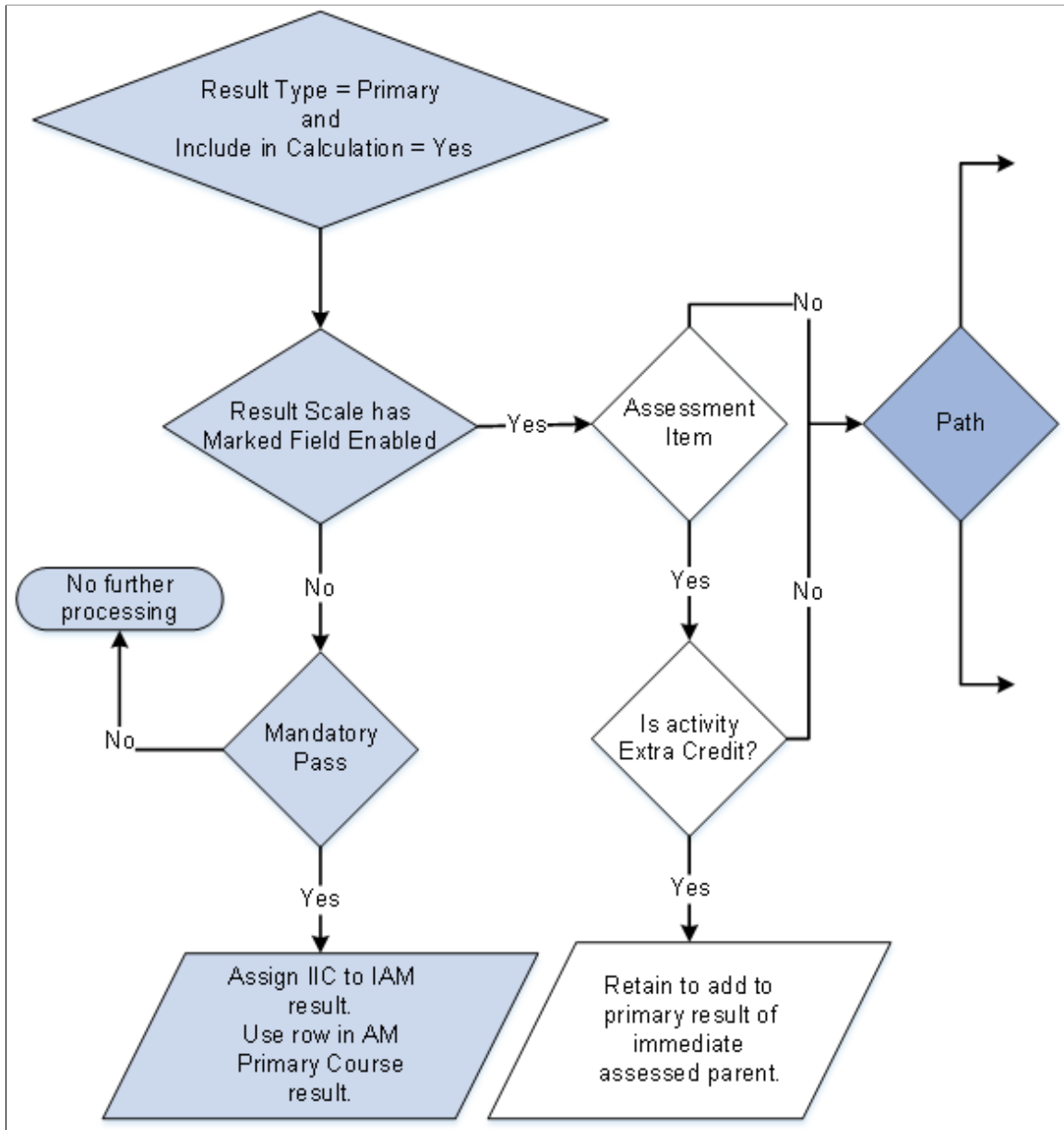

Diagram 2 of 3 illustrating primary result calculation:

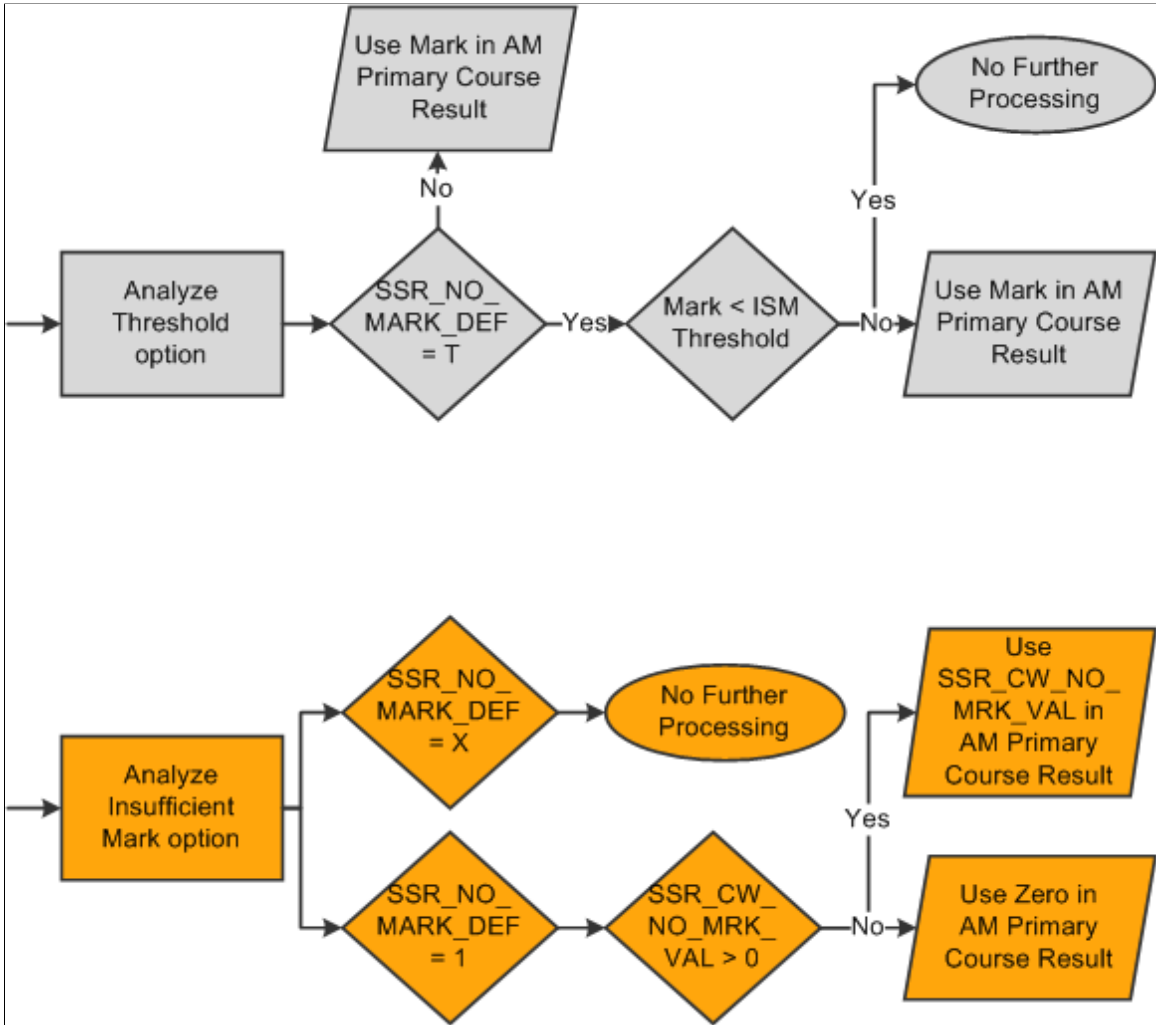
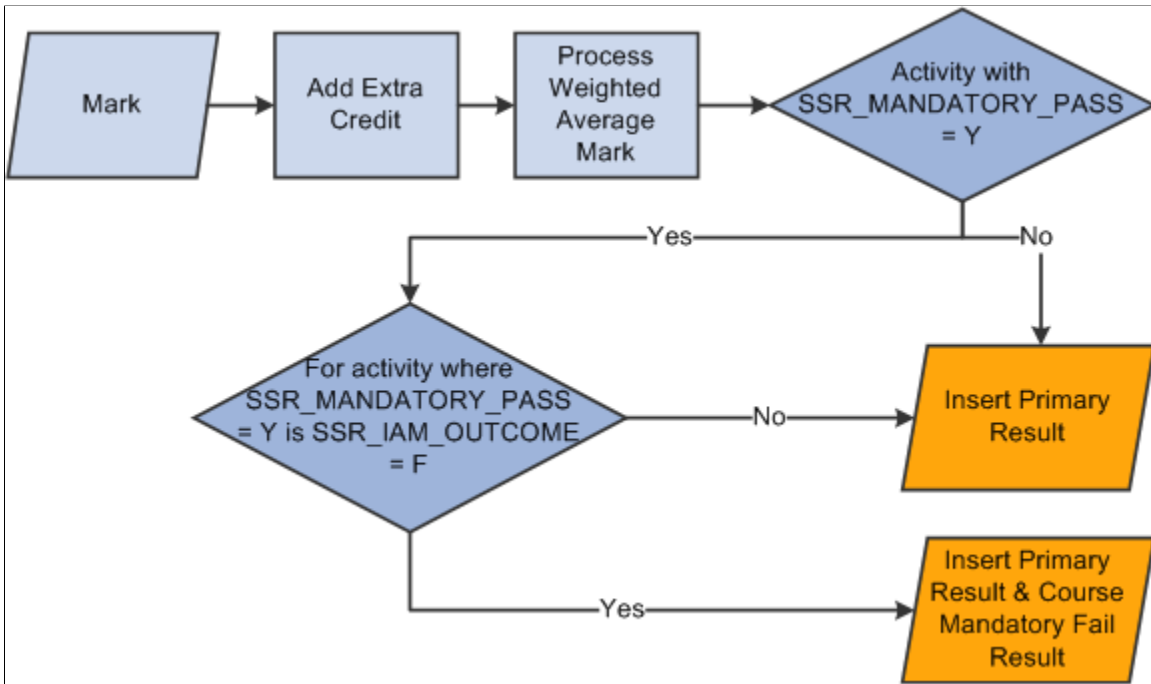

Diagram 3 of 3 illustrating primary result calculation:



Result Calculation:

Summary Page row selected for *Select for Calculation*.

and

Result Detail row has *Include in Calculation* selected

or

Result Detail has the expectation of an *Include in Calculation* row.

The calculation begins by analyzing the associated result type and result scale. It determines whether a result that does not utilize a mark should be included in the calculation in that it is noted as a Mandatory Pass activity (meaning it must be passed to pass the overall course). Then the activity is reviewed to determine if it is extra credit. Next the due or the extended due date is analyzed. From here the value to use in the calculation is determined after analyzing the Insufficient Mark settings. The weighted average marks are calculated and extra credit is added where credible. Lastly, the status is reviewed for any activities used in calculating the course result and if the mandatory fail result is entered for the course as applicable.

Primary Result Rules Engine Integration

The primary result calls the Rules Engine to generate the average weighted mark of an activity based on its child activities.

Highlights of the Activity Management Primary Result	
Rule Category: AM Calculation Rules	SCC_RULE_CAT_20130425123523
Rule: Resit Calculation	SCC_RULE_ID_20140812101105
Rule: Overall Calculation with Multiple Scales 1: Main Rule	SCC_RULE_ID_20160824092103

Understanding Resit Eligibility and Calculation

Activity Management supports the resit (reassessment) functionality. This feature evaluates if a student is eligible for a resit and, if so, performs a calculation to determine the resit result. Schools could set up a number of criteria to support their reassessment policy.

The rules designed to analyze resit eligibility and calculation of a resit result depend on the setup from a variety of sources, including the:

- Result Scale - Resit Eligible flag
- Resit Option - Resits Allowed flag
- Resit Option – Attempt Limits
- Resit Option – Resit Period Assignment
- Resit Calculation Option
- Academic Period
- Result entered on the student IAM

This diagram outlines the resit eligibility evaluation process.

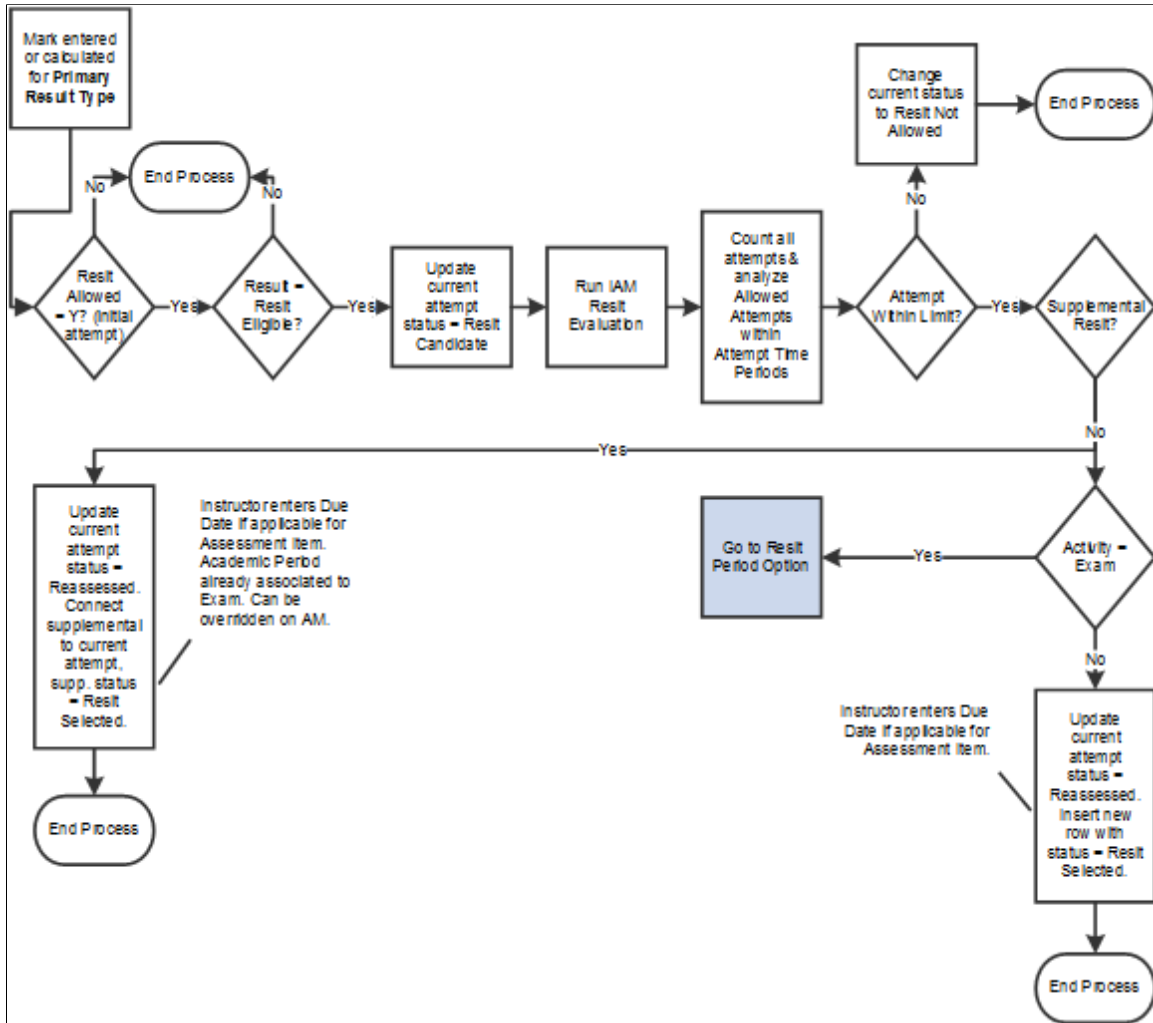

This diagram outlines the exam period assignment process.

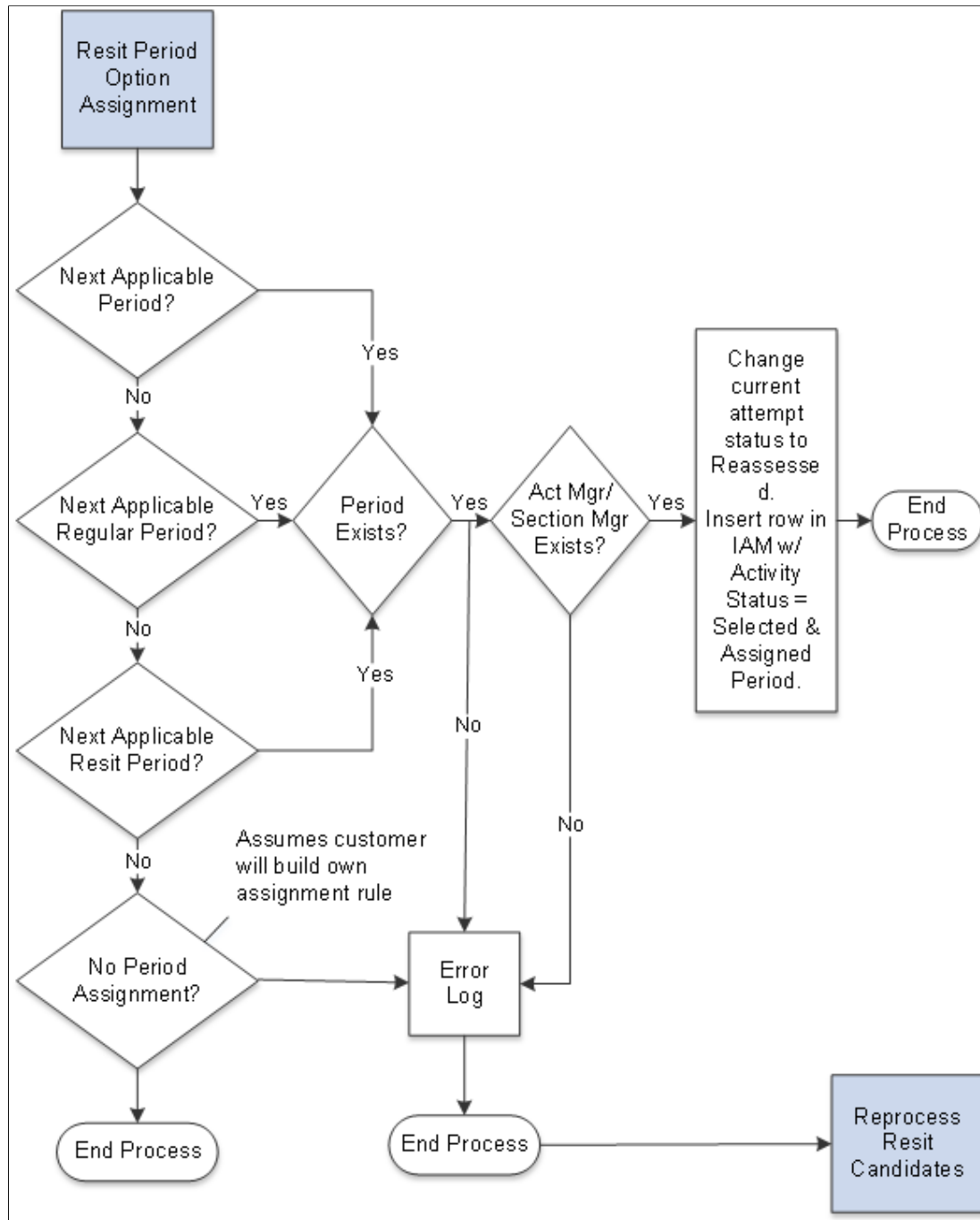

Resit Eligibility Rules Engine Integration

This section lists the entities and rules defined for resit eligibility and calculation. To use the rules, you must also:

1. Add role security to the Rule Category – AM Calculation Rules.
2. Build the rules (using the Build Rules component).

3. You should also run the Wipe and Sync Entity utility.

The delivered Rule Category is AM Calculation Rules - SCC_RULE_CAT_20130425123523.

Data Set Profile	Data Set Name
System Profile for Data Sets	AM Activity Data SCC_ENTITY_20140514045431
System Profile for Data Sets	AM IAM SCC_ENTITY_20140529091847
System Profile for Data Sets	AM Student Activity for List SCC_ENTITY_20140515013913
System Profile for Data Sets	AM Student Activity Data SCC_ENTITY_20140509134612
System Profile for Data Sets	AM Resit Calc Student Activity SCC_ENTITY_20140806031839
System Profile for Data Sets	AM Result Scale Setup SCC_ENTITY_20140807094017
System Profile for Data Sets	AM Exam Section SCC_ENTITY_20140609161001
System Profile for Data Sets	AM Results SCC_ENTITY_20130528134954
System Profile for Data Sets	AM ActivityData SCC_ENTITY_20140514045431

The following table lists delivered rules and functions.

Rule Name	Rule ID
AM Capped Late Penalty	SCC_RULE_ID_20130521103202
AM Daily Late Penalty	SCC_RULE_ID_20130521095817
AM Expires to Zero Penalty	SCC_RULE_ID_20130516135412
AM Fixed Penalty Rule	SCC_RULE_ID_20130521094603
AM Late Penalty Online Driver Rule	SCC_RULE_ID_20130515130457
AM One Time Late Penalty	SCC_RULE_ID_20130508133749
AM Primary Course Result	SCC_RULE_ID_20130425124530
AM Weekly Late Penalty	SCC_RULE_ID_20130515141726
Get Outcome for a Mark in Result Scale	SCC_RULE_ID_20140808043722
Get Result Scale Detail Setup	SCC_RULE_ID_20140807093640
Get Result Scale Option Setup	SCC_RULE_ID_20140807153130
IAM Resit Evaluation	SCC_RULE_ID_20140521131818
IAMGetNextExam	SCC_RULE_ID_20140508022130
Overall Calculation with Multiple Scales 1: Main Rule	SCC_RULE_ID_20160824092103
Overall Calculation with Multiple Scales 2: Mathematical conversion	SCC_RULE_ID_20160823074658
Resit Calculation	SCC_RULE_ID_20140812101105
Resit Calculation 1 Get Activity Setup (Calculation Option)	SCC_RULE_ID_20140806043742
Resit Calculation 2 Get Attempts and Results for Assessment Item	SCC_RULE_ID_20141028114928

Rule Name	Rule ID
Resit Calculation 2 Get Attempts and Results for Exam	SCC_RULE_ID_20141030022736
Resit Calculation 2 Get Attempts and Results for Category	SCC_RULE_ID_20161010085709
Resit Evaluation 1A Get Activities by Registry_id for Assessment item Entity	SCC_RULE_ID_20141103014315
Resit Evaluation 1A Get Activities by Registry_id for Exam Entity	SCC_RULE_ID_20141105073654
Resit Evaluation 1A Get Activities by Registry_id for Category	SCC_RULE_ID_20160926062235
Resit Evaluation 1A Get Activity Setup for Assessment item Entity	SCC_RULE_ID_20141030052857
Resit Evaluation 1A Get Activity Setup for Exam Entity	SCC_RULE_ID_20141030100416
Resit Evaluation 1A Get Activity Setup for Category Entity	SCC_RULE_ID_20160926074059
Resit Evaluation 2 Get Student, Activity Data	SCC_RULE_ID_20140512003813
Resit Evaluation 2B Get Academic Period Data	SCC_RULE_ID_20140603155223
Resit Evaluation 3 Get Number of PREVIOUS Attempts used for Assessment Item	SCC_RULE_ID_20141103024942
Resit Evaluation 3 Get Number of PREVIOUS Attempts used for Exam	SCC_RULE_ID_20141105054414
Resit Evaluation 3 Get Number of PREVIOUS Attempts used for Category	SCC_RULE_ID_20160926103714
Resit Evaluation 3 Get and Evaluate Number of Attempts used for Exam	SCC_RULE_ID_20141102023250
Resit Evaluation 3 Get and Evaluate Number of Attempts used for Category	SCC_RULE_ID_20160926065724

Rule Name	Rule ID
Resit Evaluation 3 Get and Evaluate Number of Attempts used for Assessment Item	SCC_RULE_ID_20141102022917
Resit Evaluation 4 Exam Resit Setup Next Period	SCC_RULE_ID_20140618045703

Prerequisites for Managing Activities

In order to get the highest value from this documentation, we suggest that readers be familiar with the following items:

- Basic Tree Structure, vocabulary, and components.
- Campus Solutions Academic Structure.
- Campus Solutions Course Catalog.
- Campus Solutions Schedule of Classes.
- Campus Solutions Instructor/Advisor Table.
- Campus Solutions Grading Setup.
- Basic Academic Structure Security.

Adding Courses to an Existing Activity Registry

This section provides an overview of how to add courses to an existing activity registry and discusses how to:

- Associate a single course with an activity registry.
- Review associated courses and topics.
- Associate multiple courses with an activity registry.

Understanding How to Add Courses to an Existing Activity Registry

If you want a course to utilize the features of Activity Management, you must associate it with an Activity Registry ID. The Activity Registry ID can be specific to one course or it can be associated with several courses that share the same content structure. A course can be added as the Course Control Record to the Registry ID, either directly in the Activity Registry Header or by copying content detail in Add mode. If the Activity Registry ID is to be associated with multiple courses, there are two additional methods in which you can relate a course to an existing Activity Registry ID – the Maintain Course Content Cross Reference (XRef) and Manage Content to Courses.

Consider the following when relating an Activity Registry ID to multiple courses:

- Courses should belong to the same academic organization.
Access into the majority of Coursework Activity Management components are based on the user's Academic Organization security.
- Courses should share the same administrative user(s) for grading purposes.
This feature supports administrative access for grading. The administrative graders should be the same across all the courses belonging to an Activity Registry ID. This concern relates to administrative access, not instructor access.
- Courses should share the same component structure (as defined in the Course Catalog) with the same graded component.
- Courses should contain the same content item hierarchy.*
- Courses should share the same content details.*

Note: *Courses can be associated with the same registry even if the content items vary slightly. The registry structure defaults to the class section level where slight differences between courses or sections could be overridden. For example, BIOLOGY 100 and BIOLOGY 102 basically share the same structure, but some instructors in BIOLOGY 102 require that students do an oral presentation on their reading assignments instead of writing a paper. That difference can be handled by editing the assessment items at the schedule level as opposed to creating a new Activity Registry ID for BIOLOGY 102.

Pages Used to Add Courses to an Existing Activity Registry

Page Name	Definition Name	Navigation	Usage
Maintain Course Content Xref	SSR_AC_CRSE_XREF	Curriculum Management > Activity Management > Activity Registry > Maintain Course Content Xref	Review a Course Activity Registry assignment or to associate a course to an Activity Registry ID. The page is keyed by Course ID.
Content Courses/Topics	SSR_AC_XREF_GRP	Curriculum Management > Activity Management > Activity Registry > Manage Content to Courses	View courses that are associated with an Activity Registry ID.
Update Content Courses/Topics	SSR_AC_XREF_GRPADD	Curriculum Management > Activity Management > Activity Registry > Manage Content to Courses > Update Content Courses/Topics	Add courses to, or delete courses from, the Activity Registry ID via the selected processing mode. You can search for courses, review the search results, and update staged courses to the Activity Registry ID.

Associating a Single Course with an Activity Registry

Access the Maintain Course Content Xref page (**Curriculum Management > Activity Management > Activity Registry > Maintain Course Content Xref**).

<i>Field or Control</i>	<i>Description</i>
Activity Registry ID	Indicate the Activity Registry ID of the course.

Note: All Activity Registry IDs associated with the course can be viewed within this component regardless of effective date and effective status of the activity registry.

Reviewing Associated Courses and Topics

Access the Content Courses/Topics page (**Curriculum Management > Activity Management > Activity Registry > Manage Content to Courses**).

This page displays the courses that are associated with the Activity Registry ID. Courses can be added or deleted using the Update Content Courses/Topic page. This same view also appears in the Activity Registry under the Related Courses link.

Associating Multiple Courses with an Activity Registry

Access the Update Content Courses/Topics page (**Curriculum Management > Activity Management > Activity Registry > Manage Content to Courses > Update Content Courses/Topics**).

This example illustrates the fields and controls on the Update Content Courses/Topics page (1 of 2). You can find definitions for the fields and controls later on this page.

Content Courses/Topics
Update Content Courses/Topics

Activity Registry ID: C-00000000020 Molecular Biology
 Academic Institution: PSUNV

Maintain Course/Topic to Content ID Associations

Processing Mode: Effective Date: Maximum Rows Returned:

Search Criteria

Institution: PeopleSoft University

Acad Org: Biology

AIR Program:

Subject Area:

Catalog Nbr:

Campus:

Course ID:

Offer Nbr:

Career:

Description:

Search Results

Select All

Institution	Subject	Catalog Nbr	Campus	Course ID	Offer Nbr	Topic ID	Description	Registry ID	
<input type="checkbox"/>	PSUNV	BIOLOGY	100		003700	1	0	General Biology I	C-00000000021
<input type="checkbox"/>	PSUNV	BIOLOGY	102		003702	1	0	General Biology II	C-00000000018
<input type="checkbox"/>	PSUNV	BIOLOGY	103		001031	1	0	General Biochemistry	C-00000000024
<input type="checkbox"/>	PSUNV	BIOLOGY	115		001030	1	0	History and Theory of Biology	
<input type="checkbox"/>	PSUNV	BIOLOGY	121		003704	1	0	Cell Devel Bio	

This example illustrates the fields and controls on the Update Content Courses/Topics page (2 of 2). You can find definitions for the fields and controls later on this page.

Staged Updates

Staged Updates

Institution	Subject	Catalog Nbr	Campus	Course ID	Offer Nbr	Topic ID	Effective Date	Registry ID
PSUNV	BIOLOGY	115		001030	1	0	<input type="text" value="11/28/2012"/>	C-00000000018
PSUNV	BIOLOGY	210		003712	1	0	<input type="text" value="11/28/2012"/>	C-00000000018

This component provides a mechanism to add an existing Activity Registry ID to multiple courses. The process involves accessing an Activity Registry ID, searching for courses to add, identifying courses to add and then adding the courses. This page is keyed by Activity Registry ID. Courses can also be deleted from an Activity Registry ID with this process.

Note: Only current or future dated Activity Registry IDs are accessible in this component.

See [Reviewing Associated Courses and Topics](#)

<i>Field or Control</i>	<i>Description</i>
Processing Mode	Select a value to either Add a course to or Delete a course from the Activity Registry ID.
New Eff Date	Enter the effective date that should be associated with the addition or deletion of the course(s).
Maximum Rows Returned	Enter the maximum number of courses to be displayed in the grid for a given search.

Search Criteria

Use this group box to narrow your search for courses to add to the registry. Those courses meeting the criteria appear in the grid below. When deleting, you do not need to enter any criteria; when you click the **Search** button, the current courses associated with the Activity Registry ID appear.

<i>Field or Control</i>	<i>Description</i>
Search	Click this button to populate the Search Results grid with courses that match the search criteria.
Clear Criteria	Click this button to clear the entered search criteria.

Search Results

This group box lists all courses that meet the search criteria.

<i>Field or Control</i>	<i>Description</i>
Select All	Select this check box to select all entries in the grid below. Alternately, select the check box(es) next to individual entry rows.
Clear Search Results	Click this button to depopulate the grid.

Field or Control	Description
Topic ID	<p>Indicate if a specific topic is applicable to the Activity Registry ID.</p> <p>Values appear in this field only if topics exist in the Course Catalog. Its Description appears to the right.</p> <p>If one Activity Registry ID is applicable to all topic IDs of the course, this field can be left blank and it gets applied to all topics of the course. However, if only certain topic IDs are to be associated with this Activity Registry ID enter the topic ID and add to the staging result grid one topic at a time.</p>
Registry ID	<p>Information that appears in this field indicates that the course is already related to an existing Activity Registry ID.</p>

Staged Updates

Courses selected appear in this group box for review prior to being related to the Activity Registry ID. Using the staged data allows you to preview intended updates before they are promoted to the Activity Registry.

Field or Control	Description
Stage Selected Courses/Topics	<p>Click this button to move the selected course(s) from the results grid to the staging grid.</p>
Process Staged Entries	<p>Click this button to process the courses in the staging grid. Depending on the process mode (Add or Delete), you receive one of two confirmation messages. The result of the process immediately appears in the display grid on the Content Courses/Topics page.</p>
Clear Staged Entries	<p>Click this button to remove courses from the staging grid.</p>
Effective Date	<p>Indicates the effective date to associate with the course for the Activity Registry ID. This field populates from the setting in the New Eff Date above, but can be overridden at this level.</p>

After the Staged course is processed it appears as a course associated with the Activity Registry ID on the Content Courses/Topics page.

Generating Activity IDs for a Course

This section provides an overview of the activity generation process and discusses how to:

- Use the Activity Generator
- Use the Activity Generator - Advanced
- Review class sections for a term

Understanding the Activity Generation Process

The Activity Management feature allows institutions to manage coursework at the course level and apply it to the section level. To do this, administrators must define course roots in a term for the course. A course root provides a view of the course with all its associated coursework (components, exams and other learning content). While Activity Management uses the CS class schedule, it also provides a method to fuse class sections within a course root to provide a view of coursework that makes sense for an institution.

For example, only one instructor teaches the three sections of Genetics in the spring term; using the features in the Activity Generator, the class sections can be organized so that the instructor can manage the coursework of all three class sections as one by organizing the three sections under one course root. Thus, instead of having to go into three separate sections to alter an attribute for a particular coursework item, the instructor can change it once and the system applies it to all three sections.

The activity generation process provides three options to create course roots: by session, by class associations within a session, and by graded section. It also provides a mechanism to establish exam offerings for the overall course. Exams for the course can be created by term, by session, or by course root. Exams require an association with an Academic Period ID. Academic periods are defined on the Academic Period Table. It should be noted that if there are multiple exams within the course, then each exam *must* have a different exam type if resit functionality is being used.

It is now possible for a student to resit for an examination during the same term and future terms. If resit functionality is being used for exams, the number of resit periods can be specified along with the resit description. Each resit period along with the initial exam can be assigned a specific academic period indicating when the examination will take place.

Once the course root structure is established and exams are defined, users generate an activity ID for each piece of coursework defined for the course root, including any resit activities identified.

The activity ID level is where administrators and faculty manage the course root and its coursework. Later, the activity IDs are utilized in activity rosters against which results are entered or calculated for individual student coursework. In the case of required exam enrollment, the activity IDs are part of the student's exam enrollment record.

The following components are used to generate activity IDs:

- Activity Generator
- Activity Generator – Advanced
- Batch Activity Generator

When you generate activities, make sure you use only one component: either the online Activity Generator or the Batch Activity Generator, *not* both. If you create activities using the Batch Activity Generator, you will not be able to manage them using the online Activity Generator and vice versa.

Note:

Although users can generate resits and other activities through the online Activity Generator (as well as batch), resits are not displayed on the page once the activities have been generated online. However, the resit activities and the IDs created on the online Activity Generator can be viewed in the Activity Manager. The ability to view generated resit activities on the online Activity Generator page is planned for a future release.

Use the Activity Generator to:

- Determine the number of course roots required for the term.
- Review the number of exam sittings that are defined in the Activity Registry and associate an exam with an academic period.
- Determine the number of resit periods required for an exam and associate an exam with a resit academic period.
- Generate activity IDs for course roots and the each course root's associated coursework (components, categories, exams, exam sections, assessment items, attendance, and conditions). This also includes any identified resit activities.

Although generated resit activities can be viewed in the Activity Manager, they are not immediately synced and displayed in the IAM. Resit activities are only added to IAM if a student is required to undertake a resit of an exam, is resit eligible and satisfies the resit evaluation process requirements.

Some institutions may choose to use the Activity Generator - Advanced component, which provides additional and more complex options.

Whether it is the Activity Generator or Activity Generator - Advanced component, users have the option to aggregate activity IDs when the delivered structures do not quite meet the needs of their institution. In the Activity Generator, courses can be aggregated at the course root level. In the Activity Generator - Advanced, activity IDs can be aggregated at the course root, component, or exam levels.

While the previous methods generate activity IDs for one course at a time, the Batch Activity Generator allows users to generate activity IDs for multiple courses. Within the batch process, users also have the option to either use the Activity Registry structure as the source to generate IDs, or they can point to an existing Activity Manager structure as the source. The latter operates similarly to the Class Copy Prior Term Schedule process, which rolls data from one term to another. See [Generating Activity IDs for Multiple Courses](#).

Pages Used to Generate Activity IDs for a Course

<i>Page Name</i>	<i>Definition Name</i>	<i>Navigation</i>	<i>Usage</i>
Activity Generator	SSR_ACO_CLASS	Curriculum Management > Activity Management > Organize and Manage > Activity Generator	Define the number of course roots required for a course.
Activity Generator -Advanced	SSR_ACO_CLASS	Curriculum Management > Activity Management > Organize and Manage > Activity Generator - Advanced	Use this page to manipulate components within the course root.
Class Sections	SSR_ACO_SECTIONS	Curriculum Management > Activity Management > Organize and Manage > Activity Generator > Class Sections	View data from the class table in a grid for a quick reference to the class sections scheduled for the term.

Using the Activity Generator

Access the Activity Generator page (**Curriculum Management > Activity Management > Organize and Manage > Activity Generator**).

This example illustrates the fields and controls on the Activity Generator page (1 of 4).

Activity Generator
Class Sections

Activity Generator

Course ID: 003702 **Course Offering Nbr:** 1
Institution: PeopleSoft University
Term: 2011 Fall Undergrad
Subject Area: BIOLOGY Biology
Catalog Nbr: 102 General Biology II

▼ Activity Generator
Activity Generation Status Complete

*Assign Root Activity by

Assign Exam Activity by

Apply to All Exam Types

Course Root
Find | View All First 1 of 2 Last

Activity Registry ID C-0000000018 General Biology II

Session Regular Academic Session **Class Association** 1

Collapse All

Expand / Collapse	Content Description	Academic Period ID	Resit Period	Section	Class NBR	Temporary ID	Aggregate To
<input type="checkbox"/>	Course					Course 1	Course 2 ▼
<input type="checkbox"/>	├- Lecture			1	1156	LEC 1	
	├├- Research Paper						
<input type="checkbox"/>	├- Lab			1A	1201	LAB 1	
	├├- Lab Assignments - Select 2						
	├├├- Lab Assignment 1						
	├├├- Or Lab Assignment 2						
	├├├- Or Lab Assignment 3						
	├├├- Or Lab Assignment 4						
<input type="checkbox"/>	├- Discussion			1C	1203	DIS 1	
	├├- Discussion Attendance						
<input type="checkbox"/>	├- Course Exam						Exam 1
	├├- Course Exam Section						

This example illustrates the fields and controls on the Activity Generator page (2 of 4). You can find definitions for the fields and controls later on this page.

Activity Generator
Class Sections

Activity Generator

Course ID: 003702 **Course Offering Nbr:** 1
Institution: PeopleSoft University
Term: 2011 Fall Undergrad
Subject Area: BIOLOGY Biology
Catalog Nbr: 102 General Biology II

▼ Activity Generator
Activity Generation Status Complete

Unlock Activity Options

*Assign Root Activity by Session & Class Association ▼

Assign Exam Activity by Term ▼

Refresh Activity Grid
Generate Activity

Course Root
Find | View All First 1 of 1 Last

Activity Registry ID C-00000000018 **General Biology II**
Session Regular Academic Session

Course Root Aggregates
First 1-2 of 2 Last

Session	Descr	Class Association
1	Regular Academic Session	1
1	Regular Academic Session	2

Collapse All

Content Tree Activities
First 1 of 1 Last

Expand / Collapse	Content Description				Section	Assoc	Class NBR	Activity ID	
<input type="checkbox"/>	Course							ACT00003248	
<input type="checkbox"/>	- Lecture	◀	1	of 2	▶	1	1	1156	ACT00003249
	- Research Paper								ACT00003250
<input type="checkbox"/>	- Lab	◀	1	of 3	▶	1A	1	1201	ACT00003251
<input type="checkbox"/>	- Lab Assignments - Select 2								ACT00003252
	- Lab Assignment 1								ACT00003253
	- Or Lab Assignment 2								ACT00003254
	- Or Lab Assignment 3								ACT00003255
	- Or Lab Assignment 4								ACT00003256
<input type="checkbox"/>	- Discussion	◀	1	of 2	▶	1C	1	1203	ACT00003257
	- Discussion Attendance								ACT00003258
<input type="checkbox"/>	- Course Exam								ACT00003259
	- Course Exam Section								ACT00003260

This example illustrates the fields and controls on the Activity Generator page (3 of 4). You can find definitions for the fields and controls later on this page.

Activity Generator
Class Sections

Activity Generator

Course ID: 003702

Institution: PeopleSoft University

Term: 2011 Fall

Subject Area: BIOLOGY

Catalog Nbr: 102

Course Offering Nbr: 1

Undergrad

Biology

General Biology II

▼ Activity Generator

Unlock Activity Options
Activity Generation Status Complete

*Assign Root Activity by

Assign Exam Activity by

Refresh Activity Grid
Generate Activity

Course Root
Find | View All
First 1 of 2 Last

Activity Registry ID C-00000000018 General Biology II

Session Regular Academic Session Class Association 1

Collapse All

Expand / Collapse	Content Description	Section	Class NBR	Activity ID
<input type="checkbox"/>	Course			ACT00003271
<input type="checkbox"/>	- Lecture	1	1156	ACT00003272
	- Research Paper			ACT00003273
<input type="checkbox"/>	- Lab	1A	1201	ACT00003274
<input type="checkbox"/>	- Lab Assignments - Select 2			ACT00003275
	- Lab Assignment 1			ACT00003276
	- Or Lab Assignment 2			ACT00003277
	- Or Lab Assignment 3			ACT00003278
	- Or Lab Assignment 4			ACT00003279
<input type="checkbox"/>	- Discussion	1C	1203	ACT00003280
	- Discussion Attendance			ACT00003281
<input type="checkbox"/>	- Course Exam			ACT00003282
	- Course Exam Section			ACT00003283

The Activity Generator allows users to define the number of course roots required for the course. A course root is equivalent to a course view. The course root is the level at which administrative and faculty users manage the coursework.

Field or Control	Description
Assign Root Activity by	<p>Select a value to define how to create Activity IDs for the course root. Options are:</p> <p><i>Session:</i> When selected, the system creates one course root for each session.</p> <p><i>Session & Class Association:</i> When selected, the system creates one course root for each class association within a session. This value is selected by default.</p> <p><i>Individual Graded Section:</i> When selected, the system creates a course root for every scheduled section indicated as the graded component. You can select this option even if there is no graded component built into the Activity Registry Content Tree for the course.</p> <p>This option does not appear if the course was created as an exam-only course (EOC) in the Activity Registry.</p>
Assign Exam Activity by	<p>This field is visible when an exam content type exists in the content tree for the course. Select a value to define how exam sittings are created for the course. It is assumed that for each unique exam activity ID generated an exam sitting is scheduled. Options are:</p> <p><i>Activity Root:</i> A unique exam activity is generated for each course root. Students enrolled in any of the course root class sections are associated with the exams of the corresponding course root.</p> <p><i>Session:</i> A unique exam activity is generated for each session which has class sections scheduled. Students enrolled in a class section of a specific session are associated with the exam of the corresponding session.</p> <p><i>Term:</i> One exam activity is generated for the entire term. All students enrolled in the course for the term are associated with this exam. Term is selected by default.</p> <p>In the instance of an EOC (defined as such in the Activity Registry), there is only one course root and exam option, so this option does not appear. You can associate an EOC with an academic period on the search page of the Activity Generator component.</p> <p>If it was noted in the Activity Registry that the exam should be scheduled for one or more instances, an Exam Section row is inserted into the Content Tree as a child to the exam content type. These exam sections have activity IDs generated and it is against these activity IDs that an exam's scheduled detail is built in the Section Manager.</p>

Field or Control	Description
Apply to all Exam Types	This check box is greyed out and checked unless there are multiple exams within the course, that have different exam types. If there are multiple exams and exam types, the user has the ability to use the same academic period for each exam by selecting Apply to all Exam Types . Deselecting the checkbox allows for a different academic period to be selected for each exam.
Apply to all Sessions	This field is only displayed if the Assign Exam Activity by is <i>Session</i> . If selected, this applies the same academic period for exams in all sessions.
Apply to all Activity Roots	This field is only displayed if the Assign Exam Activity by is <i>Activity Root</i> . If selected, this applies the same academic period for exams in all activity roots.
Refresh Activity Grid	This button becomes available when you make a change to any field in this group box. It controls the number of course root rows in the Root Content Tree group box below; the system generates Temporary IDs for the Registry Content items based upon the settings in this group box.
Generate Activity	<p>Click this button to generate Activity IDs based on the settings in this group box. The generated Activity ID replaces the Temporary ID previously established.</p> <p>The system displays generated course root results in the Course Root group box. There is a row for every root created. A more complete display of the root and all associated coursework appears for each course root in the Content Tree Activities section.</p>
Unlock Activity Options	<p>This button appears once Activity IDs are generated. It should be used if there is a need to regenerate the Activity IDs using a different assignment option.</p> <p>Once any student is associated with an activity ID for the course root, this option is no longer available.</p>
Activity Generation Status	This indicates the current status of activities for this course. The values include Pending and Complete.

Course Root

This group box indicates the results of the activity generator options. The course root rows are determined and displayed within the header of this section. The Content Tree Activities section displays the content as it associates to the course root. As you adjust the generator settings in the Activity Generator group box and refresh the grid, the system assigns a temporary ID so that users can review how Activity IDs would actually be generated. When you are satisfied with the settings and select the Generate Activities button, the temporary ID is replaced with an Activity ID.

<i>Field or Control</i>	<i>Description</i>
Activity Registry ID	This field displays the registry ID for which the course root is associated. The Activity Registry ID for this course was created when the content tree was built in the Activity Registry.
Session	This field displays the session for the particular course root. It appears in the class registry header when the Root Activity is generated.
Class Association	This field displays the class association for the particular course root. It appears in the class registry header when the Root Activity is created by either Session & Class Association or Individual Graded Section.
Section	This field displays the section number of the particular graded component. It appears in the class registry header when the Root Activity is created by Individual Graded Section.
Class Number	This field displays the class number of the particular graded component. It appears in the class registry header when the Root Activity is created by Individual Graded Section.
Content Description	This column displays the content tree that was defined for the course in the Activity Registry.
Academic Period ID	Enter the Academic Period ID for each exam in the course. Academic Period IDs are set up on the Academic Period Table. Only if the careers associated with the academic period and the course are matched, they appear in search results. If the course was designated as an EOC in the Activity Registry, the selection of the Academic Period ID occurs on the search page of the Activity Generator component and appears upon entering this page.

Field or Control	Description
Temporary ID	<p>This field displays the temporary ID of the course, exam, or scheduled component. This pregenerated ID assists users in determining the activity generator settings by placing temporary IDs where Activity IDs would appear after the Generate Activity button is selected. When the Temporary ID is the same across multiple content items, this means these content items share an Activity ID. For instance, if several lecture components are grouped under a specific course root and each Temporary ID is LEC1, they share an Activity ID. In this instance then, if this shared Activity ID is changed by an administrator or faculty member, the change is applied to all the lectures that share the Activity ID.</p>
Activity ID	<p>This ID replaces the temporary ID once the Generate Activity button is selected.</p>
Aggregate To	<p>This field is active when there are multiple course roots for the overall course and before activities are generated. When the delivered generate options do not meet the specific needs of an institution, schools can use this field to further refine the course root structure.</p> <p>This field is available for the content types of Course (on both the standard and advanced option pages), Component, and Exam (on the advanced option page only), when multiples of each are generated based upon the Generate Activity settings.</p> <p>For example, say two sections are scheduled in the Regular session and two sections are schedule in the OEE session and a school wants to manage the regular session sections as one course root but the OEE as separate roots. The school would select the Individual Graded Section option, so that four course roots are originally created in the temporary status, but then they would aggregate one of the regular session sections to the other. When the activities are generated, three course roots would be generated – one for the regular session (with both sections) and one each for the sections in the OEE session.</p>
Horizontal Scroll 	<p>This feature is enabled when two or more components or exams point to one course root. Users scroll to display the various Section, Session, Class Association, Class Number and Temporary or Activity IDs.</p>

Generating Resit Activities

If using resit functionality, and resit options have been configured for an exam activity in the Activity Registry, then resit exam activities can be created when generating IDs in the Activity Generator. The

number of resit periods can be specified along with the resit description. A different Academic Period needs to be added to each initial exam(s) and also to the resit period activity(ies).

This example illustrates the fields and controls on the Activity Generator page (4 of 4 —Part I). You can find definitions for the fields and controls later on this page.

The screenshot shows the 'Activity Generator' page. At the top, course details are listed: Course ID: 007329, Institution: PeopleSoft University, Term: 2016 Fall, Subject Area: ART, Catalog Nbr: 150, Course Offering Nbr: 1, Undergrad, Art, Visual Culture and Literature. Below this is a section titled 'Activity Generator' with a status of 'Pending'. It contains several controls: 'Assign Root Activity by' set to 'Session & Class Association', 'Assign Exam Activity by' set to 'Term', a checked checkbox for 'Apply to All Exam Types', 'Number of Resit Periods' set to '1', and an 'Add Resit Description' field with the value 'Resit'. At the bottom are 'Refresh Activity Grid' and 'Generate Activity' buttons.

Field or Control	Description
Apply to all Exam Types	This is greyed out and checked unless there are multiple exams within the course that have different exam types. If there are multiple exams and exam types, the user can select Apply to all exam types to use the same academic period for each exam. Deselecting the checkbox allows for a different academic period to be selected for each exam.
Number of Resit Periods	Enter the number of resit periods permitted for exams for this course. The number of resits selected is displayed in the grid.
Add Resit Description	Add a description for the resit activity or activities that are appended to the activities in the Activity Manager and subsequently in the IAM if the resit activity is utilized.

In the example above only one resit period is selected, and accordingly one resit activity for the exam is displayed. The Resit Activity is clearly identified and the resit academic period is also displayed as seen in the following image.

This example illustrates the fields and controls on the Activity Generator page (4 of 4 - Part II).

The screenshot shows the 'Course Root' page for 'Art 150'. It displays a 'Content Tree Activities' table with columns for Expand/Collapse, Content Description, Academic Period ID, Resit Period, Section, Session, Assoc, Class NBR, and Temporary ID. The tree includes 'Course', 'Paper 1', 'Course Exam' (with Academic Period ID 'FALL-2016'), 'Course Exam Section', 'Course Exam Resit*' (with Academic Period ID 'FALL-2016RS'), and 'Course Exam Section Resit'. A legend below the table indicates that '*' denotes a Resit Period.

Though activities generated on the online Activity Generator are not displayed on the page once the activities for resits are generated, the resit activities and IDs are displayed in the Activity Manager. The ability to view generated resit activities on the online Activity Generator page is planned for a future release.

Special Consideration for Topic IDs

This example illustrates the fields and controls on the Example of Course Root (1 of 4). You can find definitions for the fields and controls later on this page.

The screenshot shows the 'Course Root' page for 'Opera - Verdi & Wagner'. It displays the following information: Activity Registry ID C-00000000016, Session Regular Academic Session, and Topic ID 1. The Class Association is 1.

This example illustrates the fields and controls on the Example of Course Root (2 of 4). You can find definitions for the fields and controls later on this page.

The screenshot shows the 'Course Root' page for 'Opera - Verdi & Wagner'. It displays the following information: Activity Registry ID C-00000000016, Session Regular Academic Session, and Topic ID 2. The Class Association is 1.

This example illustrates the fields and controls on the Example of Course Root (3 of 4). You can find definitions for the fields and controls later on this page.

The screenshot shows the 'Course Root' page for 'Opera - Puccini & Mozart'. It displays the following information: Activity Registry ID C-00000000017, Session Regular Academic Session, and Topic ID 3. The Class Association is 1.

This example illustrates the fields and controls on the Example of Course Root (4 of 4). You can find definitions for the fields and controls later on this page.

Course Root				Find View All	First	4 of 4	Last
Activity Registry ID	C-00000000017	Opera - Puccini & Mozart	Topic ID			4	
Session	Regular Academic Session	Class Association	1				

If however, no topic IDs were associated with the Activity Registry for Music 265, then the above scenario would yield only one course root and no topic IDs would display.

Using the Advanced Activity Generator

Some schools may choose to use the Activity Generator - Advanced component, which provides additional (more complex) options to establish Activity IDs for a single course, most specifically for class components. Using the advanced page, users can further extend activity ID generation by:

- Choosing how to organize components (scheduled sections) for a course root.
- Selecting how to handle class associations defined as 9999. Class association numbers link all class sections that constitute a single offering. When a section is given a 9999 class association, it can be related to any other class association.

Access the Activity Generator - Advanced page (**Curriculum Management > Activity Management > Organize and Manage > Activity Generator - Advanced**).

This example illustrates the fields and controls on the Activity Generator - Advanced page. You can find definitions for the fields and controls later on this page.

Activity Generator
Class Sections

Activity Generator - Advanced

Course ID: 003702 **Course Offering Nbr:** 1
Institution: PeopleSoft University
Term: 2011 Fall Undergrad
Subject Area: BIOLOGY Biology
Catalog Nbr: 102 General Biology II

▼ Activity Generator
Activity Generation Status Complete

*Assign Root Activity by

*Assign Component Activity by

Assign Exam Activity by

Apply to All Exam Types

Refresh Activity Grid
Generate Activity

Course Root
End | View All First 1 of 1 Last

Activity Registry ID C-0000000018 General Biology II

Session Regular Academic Session

Collapse All

Content Tree Activities

Expand/Collapse	Content Description	Academic Period ID	Resit Period	Section	Assoc	Class NBR	Temporary ID	Aggregate To
<input type="checkbox"/>	Course							Course 1
<input type="checkbox"/>	- Lecture 1 of 2			1	1	1156	LEC 1	<input type="text"/>
	- Research Paper							
<input type="checkbox"/>	- Lab 1 of 3			1A	1	1201	LAB 1	<input type="text"/>
	- Lab Assignments - Select 2							
	- Lab Assignment 1							
	- Or Lab Assignment 2							
	- Or Lab Assignment 3							
	- Or Lab Assignment 4							
<input type="checkbox"/>	- Discussion 1 of 2			1C	1	1203	DIS 1	<input type="text"/>
	- Discussion Attendance							
<input type="checkbox"/>	- Course Exam FALL-2011							Exam 1
	- Course Exam Section							

The fields on this page are very similar to those in the Activity Generator component. The Class Sections pages are the same in each component.

Note: While an EOC can be accommodated in the Activity Generator - Advanced component, it does not provide additional options than what are available on the standard Activity Generator component.

Field or Control	Description
Assign Component Activity by	<p>Select a value to define how to create Activity IDs for the course root. Options are <i>Session</i> , <i>Session & Class Association</i>, and <i>Individual Class Section</i>.</p> <p>This field is not available if a component does not exist in the content tree for the course.</p> <p>When generating Activity IDs in the Activity Generator, the component option is automatic and the same as the course root option. In the Advanced component, users can select which method to use when generating Activity IDs for components. Using the component methods available here, six possible course root or component combinations are possible:</p> <ul style="list-style-type: none"> • Course Root by Session / Component by Session • Course Root by Session / Component by Session & Class Association • Course Root by Session / Component by Individual Class Section • Course Root by Session & Class Association / Component by Session & Class Association • Course Root by Session & Class Association / Component by Individual Class Section • Course Root by Individual Graded Section / Component by Individual Class Section
Aggregate 9999 Class Assoc (associations)	<p>This check box appears only when multiple 9999 sections exist. This check box is selected by default.</p> <p>When generating Activity IDs in the Activity Generator, the aggregation of 9999 class association sections is automatic. In the Advanced component, users can choose to aggregate these class associations or not. When you select this check box, the system aggregates all 9999 sections within a course root into one Activity ID. When you clear the check box, the system assigns all 9999 sections a unique Activity ID.</p>
Aggregate To	<p>In the Activity Generator, this field is only applicable to the course root. In the Advanced component, aggregating is applicable to course roots, components, and exams.</p> <p>This field appears when multiple course roots, components, or exams exist for the overall course.</p>

Reviewing Class Sections for a Term

Access the Class Sections page (**Curriculum Management > Activity Management > Organize and Manage > Activity Generator > Class Sections**).

This example illustrates the fields and controls on the Class Sections page: Class Status tab. You can find definitions for the fields and controls later on this page.

Activity Generator | Class Sections

Class Sections

Course ID: 003702 Course Offering Nbr: 1
 Institution: PeopleSoft University
 Term: 2011 Fall Undergrad
 Subject Area: BIOLOGY Biology
 Catalog Nbr: 102 General Biology II

Class Sections Personalize | Find | First 1-7 of 7 Last

Class Status | Class Enrollment Limits

Session	Section	Class Nbr	Component	Enroll Status	Class Type	Class Stat	Assoc	Auto Enrl 1	Auto Enrl 2	Resection	Add Consent	Drop Consent	Schd Print
Regular	1	1156	Lecture	Open	N	A	1				N	N	<input checked="" type="checkbox"/>
Regular	1A	1201	Laboratory	Open	E	A	1				N	N	<input checked="" type="checkbox"/>
Regular	1B	1202	Laboratory	Open	E	A	1				N	N	<input checked="" type="checkbox"/>
Regular	1C	1203	Discussion	Open	N	A	1				N	N	<input checked="" type="checkbox"/>
Regular	SR1	1509	Lecture	Open	E	A	2	SR1A	SR2A		N	N	<input checked="" type="checkbox"/>
Regular	SR1A	1514	Laboratory	Open	N	A	2				N	N	<input checked="" type="checkbox"/>
Regular	SR2A	1515	Discussion	Open	N	A	2				N	N	<input checked="" type="checkbox"/>

This example illustrates the fields and controls on the Class Sections page: Class Enrollment Limits tab. You can find definitions for the fields and controls later on this page.

Class Sections

Class Status | Class Enrollment Limits

Session	Section	Class Nbr	Component	Enroll Status	Class Type	Class Stat	Assoc
Regular	1	1156	Lecture	Open	N	A	1
Regular	1A	1201	Laboratory	Open	E	A	1
Regular	1B	1202	Laboratory	Open	E	A	1
Regular	1C	1203	Discussion	Open	N	A	1
Regular	SR1	1509	Lecture	Open	E	A	2
Regular	SR1A	1514	Laboratory	Open	N	A	2
Regular	SR2A	1515	Discussion	Open	N	A	2

There are two tabs: the Class Status tab provides the session, section and class numbers, the component, the enrollment status, the class type, the class status, the class association, auto enrollment and resection settings (if applicable), consent settings, and schedule of classes print options; the Class Enrollment Limits tab indicates the enrollment and waitlist capacity and totals, as well as the required minimum enrollment.

This tab does not appear for exam-only courses (EOCs).

Activity Generator Example

This example illustrates the fields and controls on the Content Tree Example. You can find definitions for the fields and controls later on this page.

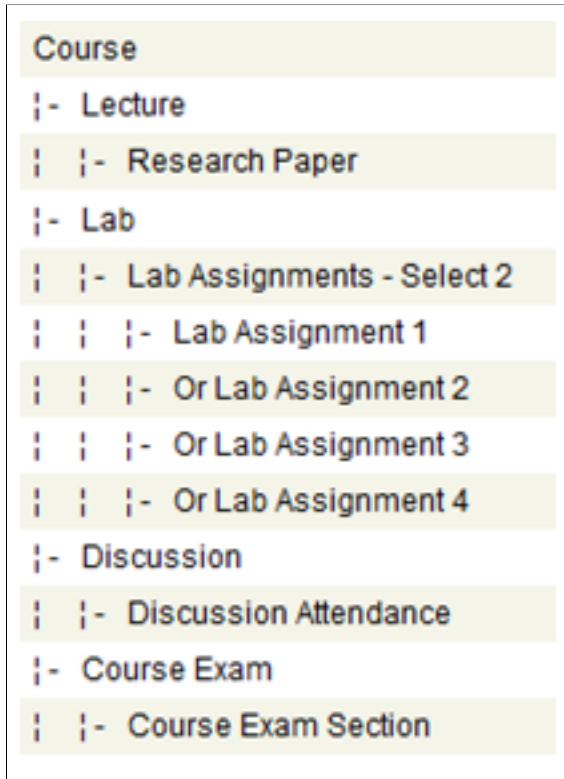

For the particular term the class section breakdown is as follows:

Session = One (Regular)

Class Association = Two (1 & 2)

Lectures = Two. This is the 'graded component'. One lecture is assigned to class association 1 and one lecture is assigned to class association 2.

Labs = Three. Two labs are assigned to class association 1 and one lab is assigned to class association 2.

Discussions = Two. One discussion is assigned to class association 1 and one discussion is assigned to class association 2.

This information is verified on the Class Sections page.

This example illustrates the fields and controls on the Class Sections page: Class Status tab. You can find definitions for the fields and controls later on this page.

Activity Generator | Class Sections

Class Sections

Course ID: 003702 Course Offering Nbr: 1
 Institution: PeopleSoft University
 Term: 2011 Fall Undergrad
 Subject Area: BIOLOGY Biology
 Catalog Nbr: 102 General Biology II

Class Sections Personalize | Find | First 1-7 of 7 Last

Class Status | Class Enrollment Limits

Session	Section	Class Nbr	Component	Enroll Status	Class Type	Class Stat	Assoc	Auto Enrl 1	Auto Enrl 2	Resection	Add Consent	Drop Consent	Schd Print
Regular	1	1156	Lecture	Open	N	A	1				N	N	<input checked="" type="checkbox"/>
Regular	1A	1201	Laboratory	Open	E	A	1				N	N	<input checked="" type="checkbox"/>
Regular	1B	1202	Laboratory	Open	E	A	1				N	N	<input checked="" type="checkbox"/>
Regular	1C	1203	Discussion	Open	N	A	1				N	N	<input checked="" type="checkbox"/>
Regular	SR1	1509	Lecture	Open	E	A	2	SR1A	SR2A		N	N	<input checked="" type="checkbox"/>
Regular	SR1A	1514	Laboratory	Open	N	A	2				N	N	<input checked="" type="checkbox"/>
Regular	SR2A	1515	Discussion	Open	N	A	2				N	N	<input checked="" type="checkbox"/>

Scenario 1

This example illustrates the fields and controls on the Example of activity setting for Session & Class Association. You can find definitions for the fields and controls later on this page.

Exam Activity Option: Activity Root

Activity Generator

Activity Generation Status Complete

*Assign Root Activity by: Session & Class Association

Assign Exam Activity by: Activity Root

Apply to All Exam Types

Apply to All Activity Roots

Refresh Activity Grid Generate Activity

Two course roots are generated in this scenario based upon Class Association 1 and Class Association 2.

Course Root for Class Association 1

This example illustrates the fields and controls on the Example of content tree activities for Class Association 1. You can find definitions for the fields and controls later on this page.

Course Root									
Activity Registry ID C-0000000018		General Biology II							
Session Regular Academic Session		Class Association 1							
<input type="checkbox"/> Collapse All									
Content Tree Activities									
Expand / Collapse	Content Description	Academic Period ID	Resit Period	Section	Class NBR	Temporary ID	Aggregate To		
<input type="checkbox"/>	Course					Course 1	▼		
<input type="checkbox"/>	├- Lecture			1	1156	LEC 1			
	├├- Research Paper								
<input type="checkbox"/>	├- Lab			1A	1201	LAB 1	<input type="checkbox"/> 1 of 2		
<input type="checkbox"/>	├├- Lab Assignments - Select 2								
	├├├- Lab Assignment 1								
	├├├- Or Lab Assignment 2								
	├├├- Or Lab Assignment 3								
	├├├- Or Lab Assignment 4								
<input type="checkbox"/>	├- Discussion			1C	1203	DIS 1			
	├├- Discussion Attendance								
<input type="checkbox"/>	├- Course Exam		FALL-2011			Exam 1	<input type="checkbox"/>		
	├├- Course Exam Section								

This example illustrates the fields and controls on the Example of Labs generated for Class Association 1. You can find definitions for the fields and controls later on this page.

<input type="checkbox"/>	├- Lab			1A	1201	LAB 1	<input type="checkbox"/> 1 of 2		
<input type="checkbox"/>	├- Lab			1B	1202	LAB 1	<input type="checkbox"/> 2 of 2		

Course Root for Class Association 2

This example illustrates the fields and controls on the Example of content tree activities for Class Association 2. You can find definitions for the fields and controls later on this page.

The screenshot shows a web interface titled 'Course Root' with a navigation bar at the top right containing 'Find | View All', 'First 2 of 2', and 'Last'. Below the title, the following information is displayed:

- Activity Registry ID: C-0000000018
- General Biology II
- Session: Regular Academic Session
- Class Association: 2

A 'Collapse All' button is located below the session information. The main section is titled 'Content Tree Activities' and contains a table with the following columns: 'Expand / Collapse', 'Content Description', 'Academic Period ID', 'Resit Period', 'Section', 'Class NBR', 'Temporary ID', and 'Aggregate To'. The table lists various activity types such as 'Course', 'Lecture', 'Research Paper', 'Lab', 'Lab Assignments', 'Discussion', and 'Course Exam' with their respective identifiers and a dropdown menu for 'Aggregate To'.

Scenario 2

This example illustrates the fields and controls on the Example of activity setting for Individual Graded Section. You can find definitions for the fields and controls later on this page.

Exam Activity Option: Session

The screenshot shows a form titled 'Activity Generator' with a status indicator 'Activity Generation Status Complete'. The form includes the following fields and controls:

- 'Assign Root Activity by' dropdown menu set to 'Individual Graded Section'.
- 'Assign Exam Activity by' dropdown menu set to 'Session'.
- Two checked checkboxes: 'Apply to All Exam Types' and 'Apply to All Sessions'.
- Buttons for 'Refresh Activity Grid' and 'Generate Activity'.

This option also generates two course roots but it is based on the graded component – the two scheduled Lectures (Section 1 and Section SR1). After setting the course roots based on the graded sections, the components are then grouped under these roots based on class association.

Course Root for Graded Section 1

This example illustrates the fields and controls on the Example of content tree activities for individual graded section. You can find definitions for the fields and controls later on this page.

Course Root									
Activity Registry ID C-00000000018		General Biology II							
Session Regular Academic Session		Class Association 1		Graded Section 1		Class Number 1156			
<input type="checkbox"/> Collapse All									
Content Tree Activities									
Expand / Collapse	Content Description	Academic Period ID	Resit Period	Section	Class NBR	Temporary ID	Aggregate To		
<input type="checkbox"/>	Course					Course 1	▼		
<input type="checkbox"/>	- Lecture			1	1156	LEC 1			
	- Research Paper								
<input type="checkbox"/>	- Lab			1A	1201	LAB 1			
<input type="checkbox"/>	- Lab Assignments - Select 2								
	- Lab Assignment 1								
	- Or Lab Assignment 2								
	- Or Lab Assignment 3								
	- Or Lab Assignment 4								
<input type="checkbox"/>	- Discussion			1C	1203	DIS 1			
	- Discussion Attendance								
<input type="checkbox"/>	- Course Exam		FALL-2011			Exam 1			
	- Course Exam Section								

However, this time because the option is section based, the lab sections point to unique activity IDs. Thus a change to section 1A only applies to that section.

This example illustrates the fields and controls on the Example of labs for individual graded section setting. You can find definitions for the fields and controls later on this page.

<input type="checkbox"/>	- Lab			1A	1201	LAB 1			
<input type="checkbox"/>	- Lab			1B	1202	LAB 1			

Course Root for Graded Section SR1

This example illustrates the fields and controls on the Example of content tree activities for individual graded section. You can find definitions for the fields and controls later on this page.

Course Root Find | View All First 2 of 2 Last

Activity Registry ID C-0000000018 General Biology II
 Session Regular Academic Session Class Association 2 Graded Section SR1 Class Number 1509

Collapse All

Expand / Collapse	Content Description	Academic Period ID	Resit Period	Section	Class NBR	Temporary ID	Aggregate To
<input type="checkbox"/>	Course					Course 2	<input type="text" value="Course 2"/>
<input type="checkbox"/>	- Lecture			SR1	1509	LEC 2	
	- Research Paper						
<input type="checkbox"/>	- Lab			SR1A	1514	LAB 3	
<input type="checkbox"/>	- Lab Assignments - Select 2						
	- Lab Assignment 1						
	- Or Lab Assignment 2						
	- Or Lab Assignment 3						
	- Or Lab Assignment 4						
<input type="checkbox"/>	- Discussion			SR2A	1515	DIS 2	
	- Discussion Attendance						
<input type="checkbox"/>	- Course Exam		<input type="checkbox"/>			Exam 1	
	- Course Exam Section						

Note that the Exam was generated by Session, thus each course root points to the same exam activity for the academic period 2011.

Scenario 3

This example illustrates the fields and controls on the Example of activity setting for Session. You can find definitions for the fields and controls later on this page.

Exam Activity Option: Term

Activity Generator Activity Generation Status Complete

*Assign Root Activity by

Assign Exam Activity by

Apply to All Exam Types

Course Root by Session

This example illustrates the fields and controls on the Example of content tree activities for session. You can find definitions for the fields and controls later on this page.

Course Root									
Activity Registry ID C-0000000018		General Biology II							
Session Regular Academic Session									
Collapse All									
Content Tree Activities									
Expand / Collapse	Content Description	Academic Period ID	Resit Period	Section	Assoc	Class NBR	Temporary ID		
[-]	Course						Course 1		
[-]	[-] Lecture			1	1	1156	LEC 1	1 of 2	
	[-] [-] Research Paper								
[-]	[-] Lab			1A	1	1201	LAB 1	1 of 3	
	[-] [-] Lab Assignments - Select 2								
	[-] [-] [-] Lab Assignment 1								
	[-] [-] [-] Or Lab Assignment 2								
	[-] [-] [-] Or Lab Assignment 3								
	[-] [-] [-] Or Lab Assignment 4								
[-]	[-] Discussion			1C	1	1203	DIS 1	1 of 2	
	[-] [-] Discussion Attendance								
[-]	[-] Course Exam		FALL-2011				Exam 1		
	[-] [-] Course Exam Section								

Each of the sections for each component type point to the same activity ID.

This example illustrates the fields and controls on the Example of lectures for session setting. You can find definitions for the fields and controls later on this page.

[-]	[-] Lecture	1	1	1156	LEC 1	1 of 2
[-]	[-] Lecture	SR1	2	1509	LEC 1	2 of 2

This example illustrates the fields and controls on the Example of labs for session setting. You can find definitions for the fields and controls later on this page.

[-]	[-] Lab	1A	1	1201	LAB 1	1 of 3
[-]	[-] Lab	1B	1	1202	LAB 1	2 of 3
[-]	[-] Lab	SR1A	2	1514	LAB 1	3 of 3

This example illustrates the fields and controls on the Example of discussion for session setting. You can find definitions for the fields and controls later on this page.

[-]	[-] Discussion	1C	1	1203	DIS 1	1 of 2
[-]	[-] Discussion	SR2A	2	1515	DIS 1	2 of 2

Note that the Exam was generated by Term, thus only one exam activity ID is generated for the academic period 2011.

For generating resit activities, see the section *Generating Resit Activities*.

Generating Activity IDs for Multiple Courses

This section discusses how to use the Batch Activity Generator to generate activity IDs for multiple courses.

You can use the following sources of data to batch generate IDs; these sources are available on the run control.

- Activity Registry template
- Activity Manager

Page Used to Generate Activity IDs for Multiple Courses

<i>Page Name</i>	<i>Definition Name</i>	<i>Navigation</i>	<i>Usage</i>
Batch Activity Generator	SSR_ACO_GEN	Curriculum Management > Activity Management > Organize and Manage > Batch Activity Generator	Batch generate Activity IDs using the Activity Registry as the source of data.

Generating Activity IDs Using Batch Activity Generator

Access the Batch Activity Generator (**Curriculum Management > Activity Management > Organize and Manage > Batch Activity Generator**).

This example illustrates the fields and controls on the Batch Activity Generator - Activity Registry as source page. You can find definitions for the fields and controls later on this page.

Run Mode Option

*Run Mode Generate Remove
 Overlay if Activity Already Exists

▼ Select using these options

*Institution PeopleSoft University

*Source Activity Registry Activity Manager

*Exam Only Option Include Exam Only Exclude in selection

This example illustrates the fields and controls on the Batch Activity Generator - Activity Manager as source page. You can find definitions for the fields and controls later on this page.

The batch generation process matches course roots based on matching Course IDs, Offer Nbr, and Topic ID and previous generation settings, as applicable. Various fields may or may not appear depending on the data source you select.

Field or Control	Description
Run Mode	Select the option for the run process. Options include <i>Generate</i> or <i>Remove</i> . Generate creates a new course root and generates Activity IDs for the assigned term/period while Remove deletes existing activity IDs for the selected population.
Overlay if Activity Already Exists	Available when the Run Mode is <i>Generate</i> . Indicates to replace any existing activity IDs with newly generated activity IDs.
Source	Indicate the source from which to generate IDs: <i>Activity Registry</i> (course template) or <i>Activity Manager</i> (term or period specific).

Field or Control	Description
Use Activity Registry if not in Activity Manager	<p>This check box appears when you select Activity Manager as the source. During the process, if an Activity Manager has not been created for the given section, selecting this field still generates activity IDs but the Activity Registry is used as the data source.</p> <p>If this field is not selected <i>and</i> an Activity Manager record does not exist, the section is skipped.</p>
Previous Term	<p>This field appears when you select Activity Manager as the source.</p> <p>Select the term from which to copy Activity Manager data.</p>
Use the most recent available term is not in previous term	<p>This check box appears when you select Activity Manager as the source.</p> <p>Select to copy data from the most recent term to the previous term selected <i>if</i> the previously listed term does not have Activity Manager data.</p>
Activity Root Status	<p>This field appears when you select Activity Manager as the source.</p> <p>Select one or more of the following statuses that are to be copied: <i>Complete</i>, <i>Locked</i>, and <i>Pending</i>. If a match does not exist for the status you selected, the record is not copied.</p>
Existing Aggregate	<p>This field appears when you select Activity Manager as the source.</p> <p>Indicate how aggregated records should be handled by the batch process: <i>Carry existing aggregates</i> to newly generated IDs, <i>Error</i> any aggregated records, or <i>Exclude in selection</i> any aggregated records from the process.</p>
Root & Component Mismatch	<p>This field appears when you select Activity Manager as the source.</p> <p>It is possible that as new sections are added, an Activity Manager record that matches might not exist for use as the source to generate IDs. Use one of the following options to indicate how to handle the situation. Select:</p> <ul style="list-style-type: none"> • <i>Revert to Activity Registry</i> to generate IDs for any sections without a source record. • <i>Error</i> for sections without a source record. • <i>Exclude in selection</i> any sections without a source.

Field or Control	Description
Exam Only Option	Indicates how to process Exam Only Courses. Options are: <i>Include</i> which indicates that exam only courses are processed along with regular courses; <i>Exam Only</i> indicates that solely exam only courses are processed; and <i>Exclude in selection</i> ignores all exam only courses and does not generate IDs.
Previous Period ID	This field appears when you select Activity Manager as the source. Enter the period ID from which to source the Exam activity.
Assign Root Activity by	This field appears when you select Activity Registry as the source. Select a value to define how to create Activity IDs for the course root. Options are: <i>Session</i> : When selected, the system creates one course root for each session. <i>Session & Class Association</i> : When selected, the system creates one course root for each class association within a session. This value is selected by default. <i>Individual Graded Section</i> : When selected, the system creates a course root for every scheduled section indicated as the graded component. You can select this option even if there is no graded component built into the Activity Registry Content Tree for the course. This option does not appear if the Exam Only Option is <i>Exam Only</i> .

Field or Control	Description
<p>Assign Component Activity by</p>	<p>This field appears when you select Activity Registry as the source.</p> <p>This option is also found in the Advanced Activity Generator component for individual courses. Here users can select which method to use when generating Activity IDs for components. Using the component methods available here, the following course root and component combinations are possible:</p> <ul style="list-style-type: none"> • Course Root by Session / Component by Session. • Course Root by Session / Component by Session & Class Association. • Course Root by Session / Component by Individual Class Section. • Course Root by Session & Class Association / Component by Session & Class Association. • Course Root by Session & Class Association / Component by Individual Class Section. • Course Root by Individual Graded Section / Component by Individual Class Section.
<p>Aggregate 9999 Class Assoc</p>	<p>This field appears when you select Activity Registry as the source.</p> <p>This check box appears only when multiple 9999 sections exist. This check box is selected by default.</p> <p>When generating Activity IDs in the Activity Generator, the aggregation of 9999 class association sections is automatic. In the Advanced component, users can choose to aggregate these class associations or not. When you select this check box, the system aggregates all 9999 sections within a course root into one Activity ID. When you clear the check box, the system assigns all 9999 sections a unique Activity ID.</p>

Field or Control	Description
Assign Exam Activity by	<p>This field appears when you select Activity Registry as the source.</p> <p>This field is visible when an exam content type exists in the content tree for the course. Select a value to define how exam sittings are created for the course. It is assumed that for each unique exam activity ID generated, an exam sitting is scheduled. Options are:</p> <p><i>Activity Root:</i> A unique exam activity is generated for each course root. Students enrolled in any of the course root class sections are associated with the exam(s) of the corresponding course root.</p> <p><i>Session:</i> A unique exam activity is generated for each session which has class sections scheduled. Students enrolled in a class section of a specific session are associated with the exam of the corresponding session.</p> <p><i>Term:</i> One exam activity is generated for the entire term. All students enrolled in the course for the term are associated with this exam. Term is selected by default. In the instance of an EOC (defined as such in the Activity Registry), there is only one course root and exam option, so this option does not appear.</p>
New Term	<p>This field appears when you select Activity Registry as the source.</p> <p>Select the term for which the course is associated.</p>
Add Resit Description	<p>Enter a description for the resit activity appearing in the Activity Manager and subsequently in the IAM, if the resit activity is used.</p>
Apply to all Exam Types	<p>By default, the checkbox is selected and the academic period applies to all exam types. Deselecting the checkbox allows a different exam type to be chosen for each academic period.</p>
Apply to all Sessions	<p>This field only appears if the Assign Exam Activity by is <i>Session</i>. If selected, the academic period is applied to all sessions. If deselected, a session can be defined for a specific Academic Period.</p>
Apply to all Activity Roots	<p>This field is only displayed when the Assign Exam Activity by is 'Activity Root'. If selected the academic period is applied to all Activity Roots. If deselected an Activity Root can be associated with a specific Academic Period.</p>

Field or Control	Description
Academic Period	<p>If an exam exists in the course, this field appears regardless of the selected source.</p> <p>Enter the Academic Period ID for each exam in the course. Academic Period IDs are set up on the Academic Period Table. The career associated with the academic period must match the career associated with the course to appear in the search results. If the course was designated as an EOC in the Activity Registry, the selection of the Academic Period ID occurs on the search page of the Activity Generator component, and is displayed on this page.</p>
Resit Period	<p>If the Academic Period has an exam period type attribute of Resit Period then this field appears checked, to indicate that this is a resit period.</p>
Log Reporting	<p>For future use.</p>
Population Selection	<p>Population selection is a method for selecting the IDs to process for a specific transaction. The Population Selection group box is a standard group box that appears on run control pages when the Population Selection process is available or required for the transaction. Selection tools are available based on the selection tools that your institution selected in the setup of the Population Selection process for the application process and on your user security. Fields in the group box appear based on the selection tool that you select. The fields behave the same way from within the group box on all run control pages and application processes. If your institution uses a specific delivered selection tool (such as PS Query) to identify IDs for a specific transaction, you must use it.</p> <p>The delivered queries include: SSR_ACO_GEN_BY_COURSE - prompts users to enter the institution, course ID and offering number; SSR_ACO_GEN_BY_INST - - prompts users to enter the institution; and SSR_ACO_GEN_BY_SUBJECT - prompts users for a subject code.</p> <p>You can create additional queries as needed.</p> <p>See “Using the Population Selection Process” (Campus Community Fundamentals)</p>

Generating Anonymous IDs

This process generates random IDs that are assigned to students per activity. You can specify the minimum and maximum number of digits for your anonymous ID. See “Setting Up Student Administration Options” (Campus Solutions Application Fundamentals).

Related Links

[Setting Up Anonymous Grading](#)

Pages Used to Generate Anonymous IDs

<i>Page Name</i>	<i>Definition Name</i>	<i>Navigation</i>	<i>Usage</i>
Generate Anonymous ID	SSR_ANID_GEN_RNCTL	Records and Enrollment > Individual Activity Manager > Generate Anonymous ID	Generate anonymous IDs.
Generate AnonID Exam Only	SSR_ANID_GEN_RNCTL	Records and Enrollment > Individual Activity Manager > Generate AnonID Exam Only	Generate anonymous IDs for exam-only courses.

Generating Anonymous IDs

Access the Generate Anonymous ID page (**Records and Enrollment > Individual Activity Manager > Generate Anonymous ID**).

This example illustrates the fields and controls on the Generate Anonymous ID page. You can find definitions for the fields and controls later on this page.

<i>Field or Control</i>	<i>Description</i>
Process Monitor	Click to access the Process List page. This page lists the anonymous ID generation process you submitted. Click the Refresh button to update the Run Status and Distribution Status columns. When anonymous ID generation is successful, these columns will display Success and Posted respectively.
Institution	Select the institution for which you want to generate anonymous IDs.
Term	Select the term for which you want to generate anonymous IDs for the student’s activity.

Manual Selection

This region appears when the **Population Selection** check box is not selected.

In this grid, you can manually select the students for whom to generate anonymous IDs. The results appear in the Preview Selection region.

Field or Control	Description
Empl ID (Employee ID)	Select the ID of the student for whom you want to generate anonymous IDs.

Population Selection

Field or Control	Description
Population Selection	Select this check box to generate multiple anonymous IDs for the population you select. By default, this check box is selected.
Selection Tool	Select PS Query .
Query Name	Select one of the following delivered queries: <ul style="list-style-type: none"> • <i>SSR_IAM_ANONID_BY_INST_TERM</i> to generate anonymous IDs for students by academic institution and term. • <i>SSR_IAM_ANONID_BY_CAR_TERM</i> to generate anonymous IDs for students by academic career and term. • <i>SSR_IAM_ANONID_BY_ORG_TERM</i> to generate anonymous IDs for students by academic organization and term.

For information on population selection, see “Using the Population Selection Process” (Campus Community Fundamentals).

Generating Anonymous IDs for Exam-Only Courses

Access the Generate AnonID Exam Only page (**Records and Enrollment > Individual Activity Manager > Generate AnonID Exam Only**).

The fields on this page are similar to the fields on the Generate Anonymous ID page except for the ones discussed in this section.

Field or Control	Description
Academic Period ID	Select the academic period for which you want to generate anonymous IDs for the student's activity. This is for exam-only courses.

Population Selection

Field or Control	Description
Population Selection	Select this check box to generate multiple anonymous IDs for the population you select. By default, this check box is selected.
Selection Tool	Select PS Query .
Query Name	Select one of the following delivered queries: <ul style="list-style-type: none"> • <i>SSR_IAM_ANONID_EO_BY_INST_PRD</i> to generate anonymous IDs for exam-only courses by academic institution and academic period. • <i>SSR_IAM_ANONID_EO_BY_CAR_PRD</i> to generate anonymous IDs for exam-only courses by academic career and academic period. • <i>SSR_IAM_ANONID_EO_BY_ORG_PRD</i> to generate anonymous IDs for exam-only courses by academic organization and academic period.

For information on population selection, see “Using the Population Selection Process” (Campus Community Fundamentals).

Managing Course Root Activities

This section provides an overview of the Activity Manager and discusses how to:

- Manage content tree activities.
- Redirect class or exam references to Activity IDs.
- Add sibling or child activities.
- Add system references.
- Manage activity details.

- Establish Activity Manager common attributes.

Understanding the Activity Manager

The Activity Manager is the administrative component to access the coursework for a course via the course roots created within the Activity Generator. The course root structure is combined with the detail from each content type defined in the Activity Registry. The Activity Manager page displays the content tree for a course root and the associated Activity IDs. It also displays any resit activities that were generated by the Online or Batch Activity Generator.

Administrators, depending on their access, can alter the content tree structure, and edit content item details that were established in the Activity Registry. Administrators must have the same academic organization access as the course. The ability to edit the content tree structure of a course is tied to settings on the Activity Definition and Activity Registry pages. The ability to change content item details is based on standard PeopleTools page security.

For courses that have class offerings, users can access the component searching by a term. If a course was created as an EOC, users can access the component searching by an academic period ID.

Note: Faculty and exam staff can access the activity manager structure in self service via the Activity Management WorkCenter.

Pages Used to Manage Course Root Activities

<i>Page Name</i>	<i>Definition Name</i>	<i>Navigation</i>	<i>Usage</i>
Activity Manager	SSR_ACM_MAIN	Curriculum Management > Activity Management > Organize and Manage > Activity Manager	View and manipulate the content tree structure for a single course root.
Registry Content Tree	SSR_ACM_REG_SBP	Click the View Registry Tree link on the Activity Manager page.	View the content tree as it was defined in the Activity Registry.
Redirect Cross-Reference	SSR_ACM_XREFMOVE	Click the Update References icon on the Activity Manager page.	Move a class or exam associated with a specific Activity ID to another Activity ID within the same content type or create a new Activity ID and associate the class or exam with the new activity.
Create Activity	SSR_AC_ACTYADDSEC	Click the Add Sibling Activity or Add Child Activity icons on the Activity Manager page.	Create a new Activity ID in the system that is associated with a parent ID.

Page Name	Definition Name	Navigation	Usage
Add System References	SSR_ACM_XREFADD	Click the Information icon on the Activity Manager page.	Generate a new Activity ID for the structure and move an existing content item to the new Activity ID.
Activity Detail	SSR_ACM_ACTYDTL	Click an Activity ID link on the Activity Manager page.	Access and edit the content item detail that was created in the Activity Registry.
Attributes	SCC_CAF_DYN_SEC	Click the Attributes link on the Activity Detail page.	Select to access common attribute fields that were defined on the Record Context page for the Activity Manager

Managing Content Tree Activities

Access the Activity Manager page (**Curriculum Management > Activity Management > Organize and Manage > Activity Manager**).

This example illustrates the fields and controls on the Activity Manager page (1 of 5): Common fields. You can find definitions for the fields and controls later on this page.

Activity Manager

Course ID: 003702	Course Offering Nbr: 1
Academic Institution: PeopleSoft University	
Term: 2010 Fall	Undergrad
Subject Area: BIOLOGY	Biology
Catalog Nbr: 102	<input type="checkbox"/> Exam Only Course

Course Root

Activity ID: ACT00000387 Course	Activity Manager Status: Complete
Registry ID: C-00000000018 General Biology II	Eff Date: 01/01/1990
View Registry Tree	<input checked="" type="checkbox"/> Enrollments Exist
Session: Regular Academic Session	Class Association: 1

Collapse All

This example illustrates the fields and controls on the Activity Manager page (2 of 5): Activity Management View tab. You can find definitions for the fields and controls later on this page.

Content Tree Activities Personalize | Find |

Activity Management View | Activity Detail | Activity ID Detail |

Expand / Collapse	Content Description	Section	Session	Assoc	Class Nbr	Activity ID	Insert Child	Insert Sibling Activity	Copy Activity	Delete
	Course					ACT00000793				
	- Exam					ACT00000794				
	- Exam Section					ACT00000795				
	- Exam Resit *					ACT00000796				
	- Exam Section Resit					ACT00000797				

LEGEND

* Resit Period

This example illustrates the fields and controls on the Activity Manager page (3 of 5): Activity Detail tab. You can find definitions for the fields and controls later on this page.

Description	Content Type	Parent Activity ID	Code	Result Scale	Passing Mark	Passing Grade	Weight	Anonymous Grading	Show in SS	Assessed	Include in Calc
Course	Course		CRS	100 PT	60.000 D		1.00	<input checked="" type="checkbox"/>	<input checked="" type="checkbox"/>	<input checked="" type="checkbox"/>	<input checked="" type="checkbox"/>
[-] Exam	Exam	ACT00000793	EX	100 PT	60.000 D		1.00	<input checked="" type="checkbox"/>	<input checked="" type="checkbox"/>	<input checked="" type="checkbox"/>	<input checked="" type="checkbox"/>
[-] [-] Exam Section	Exam Section	ACT00000794	EX	100 PT	60.000 D		1.00	<input checked="" type="checkbox"/>	<input checked="" type="checkbox"/>	<input checked="" type="checkbox"/>	<input checked="" type="checkbox"/>
[-] Exam Resit *	Exam	ACT00000793	EX	100 PT	60.000 D		1.00	<input checked="" type="checkbox"/>	<input checked="" type="checkbox"/>	<input checked="" type="checkbox"/>	<input checked="" type="checkbox"/>
[-] [-] Exam Section Resit	Exam Section	ACT00000796	EX	100 PT	60.000 D		1.00	<input checked="" type="checkbox"/>	<input checked="" type="checkbox"/>	<input checked="" type="checkbox"/>	<input checked="" type="checkbox"/>

This example illustrates the fields and controls on the Activity Manager page (4 of 5): Activity ID Detail tab. You can find definitions for the fields and controls later on this page.

Expand / Collapse	Activity ID	Content Type	Parent Activity ID	Code	Sort Sequence	Result Scale	Passing Mark	Passing Grade	Weight	Anonymous Grading	Show in SS	Assessed	Include in Calculation
<input type="checkbox"/>	ACT00000793	Course		CRS	0100	100 PT	60.000 D		1.00	<input checked="" type="checkbox"/>	<input checked="" type="checkbox"/>	<input checked="" type="checkbox"/>	<input checked="" type="checkbox"/>
<input type="checkbox"/>	[-] ACT00000794	Exam	ACT00000793	EX	0100	100 PT	60.000 D		1.00	<input checked="" type="checkbox"/>	<input checked="" type="checkbox"/>	<input checked="" type="checkbox"/>	<input checked="" type="checkbox"/>
<input type="checkbox"/>	[-] [-] ACT00000795	Exam Section	ACT00000794	EX	0100	100 PT	60.000 D		1.00	<input checked="" type="checkbox"/>	<input checked="" type="checkbox"/>	<input checked="" type="checkbox"/>	<input checked="" type="checkbox"/>
<input type="checkbox"/>	[-] ACT00000796	Exam	ACT00000793	EX	9000	100 PT	60.000 D		1.00	<input checked="" type="checkbox"/>	<input checked="" type="checkbox"/>	<input checked="" type="checkbox"/>	<input checked="" type="checkbox"/>
<input type="checkbox"/>	[-] [-] ACT00000797	Exam Section	ACT00000796	EX	9000	100 PT	60.000 D		1.00	<input checked="" type="checkbox"/>	<input checked="" type="checkbox"/>	<input checked="" type="checkbox"/>	<input checked="" type="checkbox"/>

If resit activities have been generated using the online or batch activity generator they are displayed in the Activity Manager.

This example illustrates the fields and controls on the Activity Manager page (5 of 5): Resit Activities. You can find definitions for the fields and controls later on this page.

Expand / Collapse	Content Description	Section	Session	Assoc	Class Nbr	Activity ID	Update References	Insert Child	Insert Sibling Activity	Move Activity	Copy Activity	Delete
<input type="checkbox"/>	Course					ACT00003348						
<input type="checkbox"/>	[-] Paper 1					ACT00003349						
<input type="checkbox"/>	[-] Paper 2					ACT00003350						
<input type="checkbox"/>	[-] Paper 3					ACT00003351						
<input type="checkbox"/>	[-] Paper 4					ACT00003352						
<input type="checkbox"/>	[-] Paper 5					ACT00003353						
<input type="checkbox"/>	[-] Paper 6					ACT00003354						
<input type="checkbox"/>	[-] Course Exam					ACT00003355						
<input type="checkbox"/>	[-] [-] Course Exam Section					ACT00003356						
<input type="checkbox"/>	[-] Course Exam Resit *					ACT00003357						
<input type="checkbox"/>	[-] [-] Course Exam Section Resit					ACT00003358						

Note: Although generated resit activities can be viewed in the Activity Manager, they are not immediately synced or displayed in the IAM. If a student is required to undertake a resit of an exam, is resit eligible, and satisfies the resit evaluation process requirements, then resit activities are added to the student’s IAM.

You can configure the settings for anonymous grading in Activity Manager. You can enable or disable anonymous grading for each content type as well as set up the default display settings for Individual Activity Manager, Workcenter, or Activity Roster. For example, within the same activity you may disable anonymous grading for oral recitation, but enable anonymous grading for exams. However, once you’ve

created the Individual Activity Manager for an activity, you won't be able to update the settings for anonymous grading in Activity Manager.



Course Root





<i>Field or Control</i>	<i>Description</i>
Exam Only Course	This flag appears if the course was created as an EOC.
Activity ID	The activity ID that was generated in the Activity Generator for this course root.
Activity Manager Status	Delivered values are <i>Complete</i> and <i>Pending</i> .
Registry ID	The registry ID that was created in the Activity Registry for this course.
IAM Exists , Enrollments Exist, or Results Exist	<p>This display-only field indicates to the user the status of the course root activity:</p> <ul style="list-style-type: none"> • No students have an IAM for the course root activity (IAM Exists = No) • Students have an IAM, but no result yet exists for the course root activity (Enrollments Exist = Y), and • Students have an IAM and a result exists for the course root activity (Results Exist = Y). <p>Each activity also carries one of these statuses. These can be viewed by selecting the Activity ID in the Content Tree Activities grid. When changes are made to the Activity Manager after students are enrolled and an IAM exists, the system syncs most of these changes to the IAM. For instance, a user may discover the no late penalty was defined for an assessment item. The user can make the add a late penalty in the Activity Manager (or the WorkCenter) and the system then syncs a late penalty to all the enrolled students' IAMs.</p> <p>However, some structural restrictions to editing the AM do exist. For instance, when the status is IAM Exists, a user is restricted from moving activities within the structure. When the status is Enrollments Exist, a user is unable to delete a component from the structure. When the status is Results Exist, users are unable to delete the activity.</p>
View Registry Tree	Click this link to access the Registry Content Tree page and view the content tree that was defined in the Activity Registry.

<i>Field or Control</i>	<i>Description</i>
Session	The session that is associated with this course root.
Class Association	The class association appears if course root was generated using the Session and Class Association option.
Class Section	The class section appears if the course root was generated using the Individual Graded Section option.
Class Number	The class number appears if the course root was generated using the Individual Graded Section option.
Topic ID	The topic ID appears if the course root has an associated topic ID.
Course Root Aggregates	This grid appears when the Aggregate feature was used in the Activity Generator. It indicates which courses were aggregated together.

Content Tree Activities – Activity Management View

<i>Field or Control</i>	<i>Description</i>
Activity ID	<p>This ID is generated by the Activity Generator for the given content types. Click an ID link to view and update content details for the activity on the Activity Details page.</p> <hr/> <p>Note: You can introduce new activities into the structure using the Add Child, Add Sibling, and Copy icons on this page. When using any of these features, the system generates a new Activity ID. Additional resit activities can be added in the Activity Manager but they are not automatically synced to the IAM, unless a student is eligible to retake the exam.</p> <hr/>
Update References 	<p>Click this icon to access the Redirect Cross-Reference page, where you can manage system references (class references or exam reference records) for the particular activity. You can create a new activity to associate the class/exam or you can associate the class/exam to an existing activity for the content type. This icon is not available when either the Enrollments Exist or Results Exist fields appear.</p>

Field or Control	Description
<p>Add Child Activity </p>	<p>Click this icon to access the Create Activity page, where you can add child values to the content item, and then add the details on the Activity Detail page.</p> <p>This icon appears if the Allow Structural Update check box for this content type is selected in the Activity Registry for this course. If that check box is cleared, the icon also appears when any potential child items of the content item are set to <i>Yes</i>.</p> <p>For example, a Component content type may not be flagged for allowance to update, but because the content assessment item is updateable and can be a child to a component, the system displays the Add Child icon for the component.</p> <p>Note that the only valid content types that can be added as children are those for which the Allow Structural Update check box is selected, and the content type being added is valid for the structure.</p>
<p>Add Sibling Activity </p>	<p>Click this icon to access the Create Activity page, where you can add sibling values to the content item, and then add the details on the Activity Detail page.</p> <p>This icon appears if the Allow Structural Update check box for this content type is selected in the Activity Registry for this course.</p> <p>Note that the only valid content types that can be added as siblings are those for which the Allow Structural Update check box is selected, and the content type being added is valid for the structure.</p>
<p>Move Activity </p>	<p>Click this icon to move an Activity ID within the content tree structure for this course root.</p> <p>This icon appears if the Allow Structural Update check box for this content type is selected in the Activity Registry for this course.</p> <p>For example, an Attendance activity is associated with the course as a whole, but for this course root it only needs to be associated with the Lecture component. Use this feature to move the activity from the course to the lecture.</p> <p>When you select this icon, the Paste to as Child icon appears.</p>

Field or Control	Description
<p>Paste to as Child </p>	<p>This icon appears in conjunction with the Move Activity and Copy icons. After you select an item to move or copy, this icon appears on all rows that can accept the activity as a child. Click this icon to move the activity from its original location in the tree to the selected location.</p>
<p>Copy </p>	<p>Click this icon to copy the content item activity detail and add a new activity to the content tree for this course root.</p> <p>This icon appears if the Allow Structural Update check box for this content type is selected in the Activity Registry for this course.</p> <p>When you select this icon, the Paste to as Child icon appears.</p>
<p>Delete </p>	<p>Click this icon to delete the content item activity from the content tree for this course root.</p> <p>This icon appears if the Allow Structural Update check box for this content type is selected in the Activity Registry for this course.</p> <p>A delete action is not allowed when the item was set to <i>Required By Institution</i> in the Activity Registry.</p>
<p>New References Available </p>	<p>This icon appears on any Component row where a scheduled section exists but is not associated with a course root. Click this icon to access the Add System References page and select an available class section to associate with the existing course root. The system then adds an Activity ID for the component to the course root.</p>

Content Tree Activities – Activity Detail tab

This tab provides a different view of the content tree activities with general information about each activity/content item.

Each content type has its own default settings for anonymous grading as you specified on the Activity Definitions page. See [Defining Activity Definitions](#). On this tab you can select or deselect the anonymous grading setting for the content type. If you’ve disabled anonymous grading at a higher level (for example, at the Academic Institution level), then the anonymous grading fields won’t appear in Activity Manager.

Content Tree Activities – Activity ID Detail tab

This tab provides the same information as the Activity Detail View tab, but is organized by Activity ID.

Redirecting Class or Exam References to Activity IDs

Access the Redirect Cross-Reference page (click the **Update References** icon on the Activity Manager page).

This example illustrates the fields and controls on the Redirect Cross-Reference page.

Redirect Cross-Reference

Activity ID: ACT00000157 Lab

Activity Class References								
	Course ID	Offer Nbr	Term	Session	Assoc	Topic ID	Section	Class Nbr
<input type="checkbox"/>	003702	1 0650	1		1		1A	1401
<input type="checkbox"/>	003702	1 0650	1		1		1B	1403

Available Target Activities and Actions										
	Activity ID		Course ID	Offer Nbr	Term	Session	Assoc	Topic ID	Section	Class Nbr
<input type="checkbox"/>	XXX00000001	Create a New Activity								
<input type="checkbox"/>		Delete Selected References								

For example, the Lab content item for Course Root ACT00000157 has two class sections that point to the same Activity ID.

Both Sections 1A and 1B point to Activity ID ACT00000157.

Lab	◀	1 of 2	▶	1A	1	1	1401	ACT00000157
Lab	◀	2 of 2	▶	1B	1	1	1403	ACT00000157

Perhaps for this particular Course Root the school wishes to manage these two sections separately rather than under one Activity ID. The Update References icon can be selected for section 1B and within the Redirect Cross-Reference page, the section can be redirected to a new Activity ID as follows:

This example illustrates the Update References page as explained above.

Redirect Cross-Reference

Activity ID: ACT00000157 Lab

Activity Class References								
	Course ID	Offer Nbr	Term	Session	Assoc	Topic ID	Section	Class Nbr
<input type="checkbox"/>	003702	1 0650	1		1		1A	1401
<input checked="" type="checkbox"/>	003702	1 0650	1		1		1B	1403

Available Target Activities and Actions										
	Activity ID		Course ID	Offer Nbr	Term	Session	Assoc	Topic ID	Section	Class Nbr
<input checked="" type="checkbox"/>	XXX00000002	Create a New Activity								
<input type="checkbox"/>		Delete Selected References								

Select OK, and you are taken to the Activity Detail page for the new Activity ID. Appropriate details should be entered and saved.

Return to the main page and Section 1B becomes pointed to a new Activity ID.

Lab	◀	2 of 2	▶	1B	1	1	1403	ACT00000209
-----	---	--------	---	----	---	---	------	-----------------------------

Adding Sibling or Child Activities

Access the Create Activity page (click the **Add Sibling Activity** or **Add Child Activity** icons on the Activity Manager page).

This example illustrates the fields and controls on the Create Activity page.

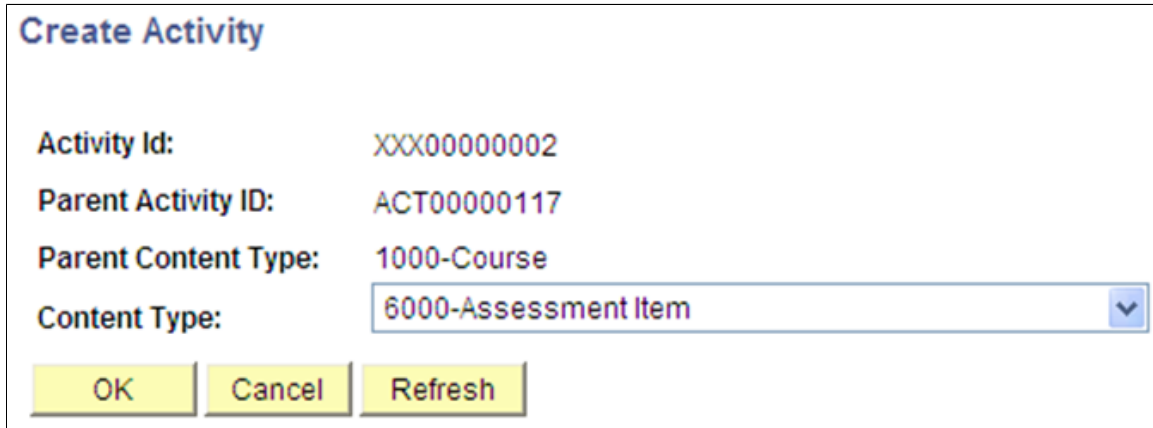

The screenshot shows a form titled "Create Activity" with the following fields and controls:

Activity Id:	XXX00000002
Parent Activity ID:	ACT00000117
Parent Content Type:	1000-Course
Content Type:	6000-Assessment Item

At the bottom of the form are three buttons: **OK**, **Cancel**, and **Refresh**.

Once you click **OK** you are transferred to the Activity Details page where you can enter details about the new activity. Add activity detail and save the component to generate a new Activity ID. With the exception of the description and content code, the details for 4500 – Exam Section must be entered on the Section Manager component.

Special Consideration for Combined Sections

Combined sections can be setup to be displayed together under the same course root. If a combined section exists, the following page appears when the sibling icon is selected for a component content type.

This example illustrates the fields and controls on the Create Activity for Combined Sections page.

Create Activity

Activity Id: XXX00000002
 Parent Activity ID: ACT00000345
 Parent Content Type: 1000-Course
 Content Type: 2000-Component

Activity Creation Options

Create a New Activity
 Associate Combined Sections

Available Activities

Course ID: 001011
 Offer Nbr: 1
 Term: 0650
 Component:

Available Combined Section Activities									
	Course ID	Offer Nbr	Session	Assoc	Topic ID	Section	Activity ID	Component	Class Nbr
1	003852	1	1	1	1	1	ACT00000340	LEC	2075

The available combined section(s) are displayed. When you select the appropriate class section it is then displayed with its corresponding combined section under the course root. This action should be performed for each course root.

Adding System References

Access the Add System References page (click the **Information** icon on the Activity Manager page).

This example illustrates the fields and controls on the Add System References page. You can find definitions for the fields and controls later on this page.

Add System References

Activity ID: ACT00000013 Lab

Available System References									
	Course ID	Offer Nbr	Term	Session	Assoc	Topic ID	Section	Class Nbr	Activity ID
<input type="checkbox"/>	002101	1	0650	1	1		9	6650	

If any class sections were scheduled after activities were generated in the Activity Generator, the **Information** icon appears. Identify against which activity you want to add the class and select the information icon. Once selected, the system transfers you to the Add System References page to see the class(es) that require an Activity ID. Select the appropriate class section(s) and click **OK**. The class section(s) now reference the existing Activity ID. If it needs to reference its own Activity ID, use the Update Reference icon to create a new Activity ID.

Managing Activity Details

Access the Activity Detail page (click an **Activity ID** link on the Activity Manager page).

This example illustrates the fields and controls on the Activity Detail page. You can find definitions for the fields and controls later on this page.

Activity Detail

Course ID 001199 Basic Studio in Art Course Offering Nbr 1

Academic Institution: PeopleSoft University

Term: 2018 Fall Undergrad

Subject Area ART Art

Catalog Nbr 100 Exam Only Course

Course Root

Activity ID ACT00000777 Course combo override n NO Return

Content Detail

Activity ID ACT00000777 Results Exist Root Sort Seq 0100

Content Type 1000-Course Content Notes Attachments

Registry ID C-000000000096

Content Item ID ITX-000010

*Description Course combo override n NO *Content Code CRS

System References

Course ID	Term	Session	Period ID	Section	Aesoc	Topic	Reference Type	Component	Class Nbr
1 001199	0810	1			1		Course		
2 001199	0810	1		1			Component	Laboratory	1252
3 001199	0810	1		TR1	1		Component	Laboratory	1791
4 001199	0810	1		TR2	1		Component	Laboratory	1838

Content Options

*Result Scale 100 PT

Passing Mark/Grade 60.00/ D

Workload (hours) (minutes) Service Impact

Show in Student SS Anonymous Grading Use Anonymous ID

Calculate Mark Average Activity Roster Display Anonymous ID only

Calculate Mark Rank AM Workcenter Display Anonymous ID

Calculate Standardized Units Individual Activity Manager Display Anonymous, Student ID and Name

Insufficient Mark Options

Mark Option Blank Mark - Include Minimum Mark Value 0.00

Content Devices

Device ID	Description	Required
<input type="text"/>	<input type="text"/>	<input type="checkbox"/>

Return

The fields on this page are very similar to those in the Activity Registry component. The sections and fields that appear here are dependent on the content type of the item and the detail that was entered in the Activity Registry component. The system populates this page with content item attributes from the Activity Registry page, but you can update, add, or delete them here for a particular Activity ID. Any updates to a course root in the Activity Manager are reflected in downstream processing, meaning that any updates to an Exam or Exam Section made here are used by the Section Manager. When student enrollment exists or results exist for a student in the system, some edits for the given term or academic period may be restricted.

In the Content Options group box, you can set up Activity Roster, AM Workcenter, and Individual Activity Manager to display only anonymous IDs, Student ID and Name only, or both.

See:

- [Setting Up Anonymous Grading](#)
- [Generating Anonymous IDs](#)

Note: In the Content Options group box, you cannot edit standardized units defined in the Activity Registry. Any item identified as Required by Institution in the General Options group box cannot be deleted from the structure.

See [Setting Up the Activity Registry](#)

Individualized Content

When adding a new content item to the structure, the system displays an additional field in the Content Options group box on. Select the Individualized Content field if this content item is specific to a student or subset of students enrolled in the class. This activity must be assigned to the specified students either manually in the Student IAM or by using the IAM Block Generator.

This example illustrates the Content Options group box as explained above.

Image: Example of Content Options group box

The screenshot shows a 'Content Options' group box with the following fields and values:

- Result Scale: 100 PT Override
- Weighting Multiplier: 0.00 Assessed
- Passing Mark/Grade: 60.00 / D Include in Calculation
- Workload (hours): (minutes):
- Service Impact: Override
- Individualized Content

Dates and Durations

When an assessment item exists for multiple class sections and class start date is the date trigger for that assessment item, the following section appears, indicating the dates and duration for each class number. The dates can be overridden as necessary for each class.

This example illustrates the Dates and Durations group box as explained above.



The screenshot shows a 'Dates and Durations' group box with the following fields and values:

- Date Trigger:**
 - Term Start Date
 - Session Start Date
 - Class Start Date
- Term: UGRD 0650 Term Begin Date: 08/30/2010
- Session: 1 Session Begin Date: 08/30/2010
- Class Nbr: 2377 Class Start Date: 08/30/2010
- Start Date:
- Due Date: 10/28/2010
- Grading Date: 11/05/2010 [Review Dates](#)

Establishing Activity Manager Common Attributes

Access the Attributes page (click the **Attributes** link on the Activity Detail page).

The following screenshot provides an example of common attributes set up for the course content item in the Activity Manager:

Attributes			
Institution:	PSUNV	PeopleSoft University	
Activity:	ACT00000491	Course	
Language of Instruction:	<input type="text" value="SPANISH"/>	 Spanish	
Course Level:	<input type="text" value="LEVEL 1"/>	 Level 1	

The fields that appear on the Attributes page are customer-specific and are defined on the Common Attributes and Record Context pages. The record context used for the Activity Manager is the Activity Attributes (SSR_ACMCONT_ITM) record. The entity names used for the Activity Manager are prefixed by 'ACM'.

See “Understanding Common Attribute Framework” (Campus Community Fundamentals)

See “Defining a Common Attribute” (Campus Community Fundamentals)

See “Associating a Common Attribute to a Record” (Campus Community Fundamentals)

Managing Section Activities

This section provides an overview of the Section Manager and discusses how to:

- Manage activity sections.
- Manage section details.
- Manage staff instructions.
- Secure scheduled activities.

Understanding the Section Manager

The Section Manager is the administrative component to manage the scheduling of activities. It is accessed by an Academic Period ID if the associated course is an EOC and by term if the course has scheduled class sections. In its initial release it is designed to support course exam activities. Resit activities also need to be scheduled.

Pages Used to Manage Section Activities

<i>Page Name</i>	<i>Definition Name</i>	<i>Navigation</i>	<i>Usage</i>
Section Manager	SSR_ACM_SCTNMAIN	Curriculum Management > Activity Management > Organize and Manage > Section Manager	Review content items that have scheduled instances created for a course root.
Section Detail	SSR_ACM_SCTNDTL	Click an Activity ID link on the Section Manager page.	View and edit scheduling detail for the exam section.
Staff Instructions – Meeting	SSR_ACMSCTN_MSGS	Click the Staff Instructions - Meeting link on the Section Detail page.	View and edit staff instructional notes.
Scheduled Activity Security	SSR_SCRTY_EXAM	Set Up SACR > Security > Secure Student Administration > User ID > Scheduled Activity Security	Associate the academic organization for which a user can access course exams.

Managing Activity Sections

Access the Section Manager page (**Curriculum Management > Activity Management > Organize and Manage > Section Manager**).

This example illustrates the fields and controls on the Section Manager page: Activity Management View tab. You can find definitions for the fields and controls later on this page.

Section Manager

Course ID: 003702	Course Offering Nbr: 1
Academic Institution: PeopleSoft University	Undergrad
Term: 2010 Fall	Biology
Subject Area: BIOLOGY	<input type="checkbox"/> Exam Only Course
Catalog Nbr: 102	

Section Root

Activity ID: ACT00000346	Course Exam	Exam Type: COURSE EXAM	Period ID: 2011 EP 1
--------------------------	-------------	------------------------	----------------------

Scheduled Sections Personalize | Find |

Activity Management View | Section Detail View |

Content Description	Section Nbr	Facility ID	Start Date	Start Time	End Date	End Time	Activity ID	
Course Exam							ACT00000346	
Course Exam Section	16	ROSE101	01/10/2011	8:30AM	01/10/2011	11:30AM	ACT00000347	

This example illustrates the fields and controls on the Section Manager page: Section Detail View tab. You can find definitions for the fields and controls later on this page.

Description	Section Status	Current Enrollment	Enrollment Cap	Auto Enrollment	Code	Activity ID
Course Exam					EX	ACT00000346
- Course Exam Section	Scheduled		75	<input type="checkbox"/>	EX	ACT00000347

The Section Manager page displays the content item that has scheduled instances created for a course root. Initially, only exam content items selected as Scheduled in the scheduling option section of the Activity Manager appears. Exam section rows are inserted as child items to the exam based upon the Number of Sections to Schedule entered in the scheduling option section of Activity Manager.

Note: The icons on the Activity Management View tab are the same as those used on the Activity Manager page. For their descriptions and usage, see the "Managing Content Tree Activities" section.

Field or Control	Description
Exam Only Course	This check box is selected to indicate that the exam and its schedulable sections are part of an EOC.
Activity ID	This Activity ID represents the content item that has scheduled instances. It also appears as the parent item in the Scheduled Section grid below.
Exam Type	Indicates the exam type that was associated with this exam content item in the Activity Manager.
Period ID	Indicates the academic period that the exam content item was associated with in the Activity Generator.
Content Description	This section of the grid displays the original content item to be scheduled and any scheduled instances that were previously defined in the Activity Registry or Activity Manager.
Content Options	This section identifies some of the fundamental grading elements for the exam section.
Section Nbr (number)	The system generates this number when the scheduled section activity ID is generated. It is generated for each section and is ultimately used for enrollment. The Last Section Nbr generated is tracked on the Academic Period Table.
Facility ID	Displays the facility in which the scheduled section is to be held. This value is updated when Facility ID is entered on the Section Manager Section Detail page.

<i>Field or Control</i>	<i>Description</i>
Start/End Date	Displays the start and end date of the scheduled section. This value is updated when the Start Date and End Date are entered on the Section Manager Section Detail page.
Start/End Time	Displays the start and end time of the scheduled section. This value is updated when the Start Time and End Time are entered on the Section Manager Section Detail page.
Section Status	Displays the status of the scheduled section. This value is updated when the Section Status is entered on the Section Manager Section Detail page.
Current Enrollment	Displays the current enrollment in the scheduled section.
Enrollment Cap	Displays the enrollment capacity of the scheduled section. This value is updated when the Enrollment Cap is entered on the Section Manager Section Detail page.

Managing Section Details

Access the Section Detail page (click an **Activity ID** link on the Section Manager page).

This example illustrates the fields and controls on the Section Detail page (1 of 3). You can find definitions for the fields and controls later on this page.

Image: Section Detail page (1 of 3)

Section Detail

Course ID:	003702 General Biology II	Course Offering Nbr:	1
Academic Institution:	PeopleSoft University		
Term:	2010 Fall	Undergrad	
Subject Area:	BIOLOGY	Biology	
Catalog Nbr:	102	<input type="checkbox"/> Exam Only Course	

Section Root

Activity ID:	ACT00000398	Course Exam	Return
Exam Type:	COURSE EXAM	Period ID:	2010 FALL EP

Content Detail

Activity ID:	ACT00000399	<input checked="" type="checkbox"/> Enrollments Exist	Sort Seq:	<input type="text" value="0100"/>
Parent Activity ID:	ACT00000398			
Content Type:	4500-Exam Section		Content Notes	Attachments
Registry ID:	C-00000000018			
Content Item ID:	ITX-000050			
*Description:	<input type="text" value="Course Exam Section"/>	Content Code:	<input type="text" value="EX"/>	

Content Options

Result Scale:	<input type="text" value="100 PT"/>	<input type="checkbox"/> Override	Weighting Multiplier:	<input type="text" value="1.00"/>	<input checked="" type="checkbox"/> Assessed
Passing Mark/Grade:	<input type="text" value="60.00"/> <input type="text" value=""/>	<input type="checkbox"/>			<input checked="" type="checkbox"/> Include in Calculation
Workload (hours):	<input type="text" value=""/>	(minutes): <input type="text" value=""/>	Service Impact:	GRADE	<input type="checkbox"/> Override
			<input type="checkbox"/> Individualized Content		
<input checked="" type="checkbox"/> Show in Student SS			<input checked="" type="checkbox"/> Mandatory Pass Required		
<input checked="" type="checkbox"/> Calculate Mark Average			<input checked="" type="checkbox"/> Anonymous Grading		
<input checked="" type="checkbox"/> Calculate Mark Rank			<input type="checkbox"/> Calculate Standardized Units		

This example illustrates the fields and controls on the Section Detail page (2 of 3). You can find definitions for the fields and controls later on this page.

Scheduled Section Options			
Section Nbr:	11	Event ID:	000021959
Status:	Unsched		
<input checked="" type="checkbox"/> Confirmation Required	Exam Duration (hours : mins):	0 : 0	
<input type="checkbox"/> Restrict Enrollment to Group	Enrollment Cap / Enrollment:	0 / 2	
	Required Rooms:	1	
Time Slotting Options			
<input type="checkbox"/> Enable Time Slotting	Students Per Slot:	0	Slot Duration (hours : mins): 0 : 0
Room Characteristics			
*Room Characteristic	*Quantity		
1			
Meeting Detail			
Meeting Status:	Requested	Find View All First 1 of 1 Last	
Facility ID:	ANGE101	Facility Type:	Lecture Rm
		Capacity:	50
Schedule Detail			
*Start/End Date:	01/10/2011 / 01/10/2011	Pat:	MON
Room Start / End Time:	8:00AM / 10:00AM	Facility Type:	
Meeting Start / End Time:	8:30AM / 9:30AM	Seat Spacing:	0
		Requested Cap:	
		Student Cap:	0

This example illustrates the fields and controls on the Section Detail page (3 of 3). You can find definitions for the fields and controls later on this page.

Staffing

Staffing Requirements (from Section Root)

Staff Type	Minimum Required	Student/Staff Ratio
Chief Examiner	1	0
Proctor	2	30

Staff Instructions - Meeting

Staff Assignments Personalize | Find | | First 1-6 of 6 Last

*Staff Type	*Empl ID	Name	+	-
Chief Examiner	SR0490	Donna Shalinger	+	-
Proctor	SR0491	Jacob Markins	+	-
Proctor	SR0494	Lucinda O'Donnell	+	-
Proctor	SR0451	Leopold Saar	+	-
Proctor	SR0450	Oscar Saenz	+	-
Proctor	SR0496	Lucia Baci	+	-

Content Devices

Device ID	Description	Required	+	-
S CALCULATOR	Scientific Calculator	<input checked="" type="checkbox"/>	+	-

Forms of Identification

Form of Identification	Description	Required	+	-
UNIVERSITYID		<input checked="" type="checkbox"/>	+	-

Field or Control	Description
Description	Enter the scheduled activity description.
Content Code	Enter the content code for the scheduled activity. The content code serves as the header on the activity roster.
Content Options	Alter any grading element specific to the section.
Section Status	Select the status of the scheduled section. The delivered values are <i>Scheduled</i> and <i>Unsched</i> (Unscheduled). The default is <i>Unsched</i> .
Exam Duration (hours; mins)	Indicate the exam length in hours and minutes. If this value was set on the Activity Manager, it defaults here and can be overridden if necessary.
Confirmation Required	Select this flag to indicate that students enrolled in this activity must confirm their attendance.

Field or Control	Description
Enrollment Cap	Set the capacity for enrollment into this scheduled activity.
Enrollment	This field populates with the current enrollment into this scheduled activity. (Future)
Restrict Enrollment	Select a student group if this section is restricted to only students assigned to that student group.
Required Rooms	Indicate the number of rooms needed for this scheduled activity. This field is delivered to interface with a third party scheduling system. There is no internal programming for this field.
Enable Time Slotting	Indicate if this section is subject to time slotting. Time slotting is used to support intervals in assigning students to this section. This field is delivered to interface with a third party scheduling system. There is no internal programming for this field.
Students Per Slot	If utilizing time slotting indicate the number of students per time slot. This field is delivered to interface with a third party scheduling system. There is no internal programming for this field.
Slot Duration (hours; mins)	If utilizing time slotting indicate the number of hours and/or minutes per scheduled slot. This field is delivered to interface with a third party scheduling system. There is no internal programming for this field.
Room Characteristics	Indicate the required room characteristics for this scheduled activity. Room characteristics are defined on the Room Characteristics Table. This field is delivered to interface with a third party scheduling system. There is no internal programming for this field.
Quantity	Used in conjunction with the Room Characteristics field, indicate the quantity of the stated room characteristics. This field is delivered to interface with a third party scheduling system. There is no internal programming for this field.
Meeting Status	The status of the requested facility. The delivered values are <i>Final</i> , <i>Pending</i> , and <i>3rd Party</i> . The default is <i>Pending</i> . This field is delivered to interface with a third party scheduling system. There is no internal programming for this field.
Event ID	The system creates a unique event ID record in the Event table when you schedule a class with a meeting pattern and facility ID. The Event table is used to record class and non-class events for room scheduling.

Field or Control	Description
Facility ID	Enter a facility ID for the class. Facility values are defined on the Facility Table page. This field can be updated manually or by a third-party scheduling system.
Facility Type	This value defaults from the Facility Table based on the Facility ID entered.
Capacity	This value defaults from the Facility Table based on the Facility ID entered.
Start/End Date	Indicate the start and end dates of the scheduled activity.
Pat	Indicate the meeting pattern for the scheduled activity.
Room Start/End Time	Indicate the start and end times needed for the facility if the time differs from the actual scheduled activity time.
Facility Type	Indicated the needed facility type. This field is delivered to interface with a third party scheduling system. There is no internal programming for this field.
Requested Cap	Indicate the requested capacity of the facility for this scheduled activity. This field is delivered to interface with a third party scheduling system. There is no internal programming for this field.
Meeting Start/End Time	Indicate the start and end times of the scheduled activity. After entering the start time, the end time is defaulted based on the activity (exam) duration. Adjust as needed.
Seat Spacing	Indicate the number of seats that should separate students in the facility for the scheduled activity. This field is delivered to interface with a third party scheduling system. There is no internal programming for this field.
Student Cap	Enter the capacity for seating within the facility if it differs from the enrollment capacity for the scheduled activity. This field is delivered to interface with a third party scheduling system. There is no internal programming for this field.
Staffing Requirement from Section Root	This grid displays the staffing requirements for the course root. This information is provided for informational purposes only.
Staff Type	Enter the staff type required for the scheduled activity.

Field or Control	Description
EmplID	Enter the EmplID of the person who fulfills the staff type role. This field edits against the Instructor/Advisor Table. The academic organization of the course should be entered for the individual staff member on the Approved Courses page of the Instructor/Advisor Table.
Content Devices	This information displays the content devices for the course root. This information can be overridden as needed for individual scheduled sections.
Forms of Identification	This information displays the forms of identification for the course root. This information can be overridden as needed for individual scheduled sections.

Managing Staff Instructions

Access the Staff Instructions – Meeting page (click the **Staff Instructions - Meeting** link on the Section Detail page).

This example illustrates the fields and controls on the Staff Instructions – Meeting page. You can find definitions for the fields and controls later on this page.

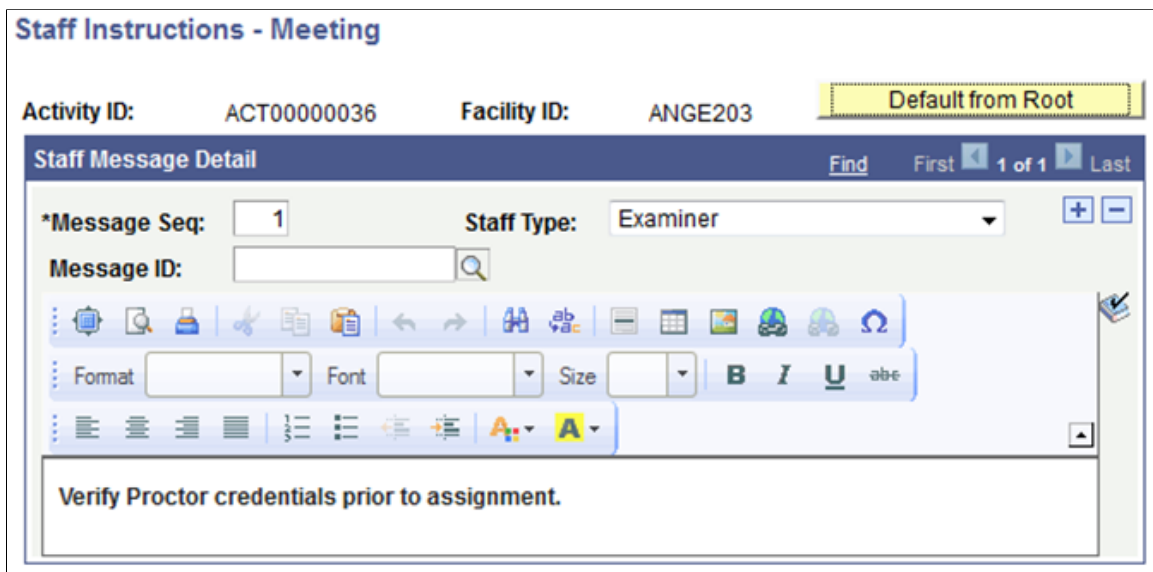

Field or Control	Description
Default from Root	Select this button to default staff instructions from the course root. Other options here include entering a Message ID to convey a previously defined message set up on the Content Messages component or enter free form text. Messages should be associated with a specific staff type.

Securing Scheduled Activities

Access the Scheduled Activity Security page (**Set Up SACR > Security > Secure Student Administration > User ID > Scheduled Activity Security**).

This example illustrates the fields and controls on the Scheduled Activity Security page. You can find definitions for the fields and controls later on this page.

The screenshot shows the 'Scheduled Activity Security' page. At the top, it displays 'User ID: PS' and 'Name: Locherty, Betty'. Below this is a table with two columns: '*Acad Org' and '*Access Code'. The '*Acad Org' column contains a search box with 'BIOLOGY' and a magnifying glass icon, followed by the text 'Biology'. The '*Access Code' column contains a dropdown menu with 'Read/Write' selected, and plus/minus icons to its right.

Access into the Section Manager to create/maintain scheduled activities is based on a user's academic organization (Academic Org Security). To add/update the scheduled activity, the user must possess the same academic organization that is associated with the Course Offering that owns the activity.

Field or Control	Description
Academic Organization	<p>Enter the highest academic organization in the hierarchy that the user ID should be able to access course scheduled activities. Insert rows to add academic organizations or to restrict access to a particular academic organization lower in the hierarchy.</p> <p>Scheduled activity security is based on the hierarchy in the academic organization security tree. The academic organization that you identify here must be a node on the academic organization security tree. Granting access to one node of the academic organization tree also provides access to all child nodes for that organization. To restrict access to a child node, select the academic organization that you want to secure and set the access code to No Access.</p>

Managing Student Activities

This section discusses the IAM where the activities for a course are assigned to a student. There are three methods by which an IAM can be created: adding the record manually, creating it in a batch process, or having student enrollment create it automatically. There is also a batch process to assign optional activities to a student when the IAM already exists. This section specifically discusses how to:

- Add an IAM for an individual student.
- Review activity status.
- Review activity detail.
- Establish IAM common attributes for activity details.

- Enter activity results for an individual student.
- Establish IAM common attributes for activity results.
- Understand reassessment.
- Create IAMs automatically.
- Create IAMs in batch using student enrollment.
- Create IAMs in batch using Academic Progress Tracker (APT).
- Create an IAM student block.
- Generate an IAM activity block.
- Use the IAM batch generator.
- Review IAM requests.
- Review the IAM activity request log.

Understanding IAM Creation in Batch

You can create IAMs for groups of students in batch. Two components are delivered to support this creation. The IAM Batch Generator using Student Enrollment page creates IAMs for students based on their enrollment in classes. The IAM Batch Generator using APT (EOC) page creates IAMs for students taking EOCs. Each method provides users multiple mechanisms for generation: population selection, filtered selection, or manual selection.

See [Creating IAMs in Batch Using Student Enrollment](#)

See [Creating IAMs in Batch Using APT](#)

Understanding IAM Block Generation

The IAM Block Generator allows users to mass assign optional activities to multiple students. Three components make up this feature: the IAM Students Block, the IAM Activities Block, and the IAM Batch Generator Using Block Process. The block process is designed to assign optional nonmandatory activities to students who are already assigned to a course root. Nonmandatory activities include optional activities where students have a choice between activities, extra credit activities, and individual content activities.

See [Generating an IAM Student Block](#)

See [Generating an IAM Activity Block](#)

See [Using the IAM Batch Generator](#)

Pages Used to Manage Student Activities

<i>Page Name</i>	<i>Definition Name</i>	<i>Navigation</i>	<i>Usage</i>
Individual Activity Manager	SSR_IAM_ACT_PAGE1	Records and Enrollment > Individual Activity Manager > Individual Activity Manager	Create, review, and update details of a student's enrollment in a course and the associated activities of that course.
Individual Activity Manager - Activity Detail	SSR_IAM_ACT_DTL	Click the Activity ID on the Individual Activity Manager page.	View and edit activity detail populated from the Activity Manager for an individual student.
Attributes	SCC_CAF_DYN_SEC	Click the Attributes link on the Individual Activity Manager - Activity Detail page or the Individual Activity Manager - Activity Result page.	Review common attributes set up in the IAM for either activity details or activity results.
Individual Activity Manager - Activity Result	SSR_IAM_ACT_RESULT	Click the Add Activity Result icon or the Show Activity Results icon on the Individual Activity Manager page.	Manually enter activity results for an individual student.
Result Scale Table	SSR_IAM_SCALE_SP	Click the Show Result Scale link on the Individual Activity Manager - Activity Result page.	Review the result scale being used for an activity result.
IAM Batch Generator using Student Enrollment	SSR_IAM_ENR_GEN	Records and Enrollment > Individual Activity Manager > IAM Gen using Student Enroll	Generate IAMs for students based on their class enrollment.
IAM Batch Generator using APT (EOC)	SSR_IAM_APT_GEN	Records and Enrollment > Individual Activity Manager > IAM Gen using APT (EOC)	Generate IAMs for students enrolled in EOCs.
IAM Students Block	SSR_IAM_STDBLK_ID	Records and Enrollment > Individual Activity Manager > IAM Block Generator > IAM Students Block	Create a block of students to whom activities are assigned.

Page Name	Definition Name	Navigation	Usage
IAM Activities Block	SSR_IAM_ACTBLK_CRG	Records and Enrollment > Individual Activity Manager > IAM Block Generator > IAM Activities Block	Create a block of course roots against which activities are selected.
IAM Batch Generator using Block Process	SSR_IAM_BLK_GEN	Records and Enrollment > Individual Activity Manager > IAM Block Generator > IAM Gen using Block Process	Merge the student and activities blocks and assign the selected activities to students.
IAM Activity Request	SSR_IAM_REQUEST	Records and Enrollment > Individual Activity Manager > IAM Activity Request	Review IAM processing requests generated from the IAM Enrollment Event, the batch IAM jobs, and the AM-to-IAM sync.
IAM Request Message Log	SSR_IAM_REQ_MSGLOG	Click the Messages link on the IAM Activity Request page.	Review any generated messages.
IAM Resit Evaluation	SSR_IAM_RESIT_EVAL	Records and Enrollment > Individual Activity Manager > IAM Resit Evaluation	Select the resit candidate population to evaluate for resit eligibility.

Adding an IAM for an Individual Student

Access the Individual Activity Manager page (**Records and Enrollment > Individual Activity Manager > Individual Activity Manager**).

This example illustrates the fields and controls on the Individual Activity Manager page – Activity tab. You can find definitions for the fields and controls later on this page.

Individual Activity Manager

Sharon Katz ID SR12200 Calculate

Institution PSUNV PeopleSoft University **Career** Undergraduate

Course Root ACT00000172 BIOLOGY 102 - General Biology II ***Root Status** Complete

Term 0650 2010 Fall **Session** 1 Regular Academic Session

Period ID 2013 FALL EP 2013 Fall Exam Period

Collapse All Create Initial Result Row Display Maximum Mark

Activity	Class & Exam Info	Credit Info	Most Recent Result							
Expand / Collapse	Content Description	Activity ID	Activity Status	Select	Extenuating Circumstances	Results	Lock	Select for Calculation		
<input type="checkbox"/>	Course	ACT00000172	Enrolled		<input type="text"/>	<input type="text"/>	<input type="text"/>	<input type="checkbox"/>		
<input type="checkbox"/>	- Lecture	ACT00000173	Enrolled		<input type="text"/>	<input type="text"/>	<input type="text"/>	<input type="checkbox"/>		
	- Research Paper	ACT00000174	Assigned		<input type="text"/>	<input type="text"/>	<input type="text"/>	<input type="checkbox"/>		
<input type="checkbox"/>	- Lab	ACT00000175	Enrolled		<input type="text"/>	<input type="text"/>	<input type="text"/>	<input type="checkbox"/>		
<input type="checkbox"/>	- Lab Assignments - Select 2	ACT00000176	Assigned		<input type="text"/>	<input type="text"/>	<input type="text"/>	<input type="checkbox"/>		
	- Lab Assignment 1	ACT00000177			<input type="text"/>	<input type="text"/>	<input type="text"/>	<input type="checkbox"/>		
	- Or Lab Assignment 2	ACT00000178	Selected	<input checked="" type="checkbox"/>	<input type="text"/>	<input type="text"/>	<input type="text"/>	<input type="checkbox"/>		
	- Or Lab Assignment 3	ACT00000179	Selected	<input checked="" type="checkbox"/>	<input type="text"/>	<input type="text"/>	<input type="text"/>	<input type="checkbox"/>		
	- Or Lab Assignment 4	ACT00000180			<input type="text"/>	<input type="text"/>	<input type="text"/>	<input type="checkbox"/>		
<input type="checkbox"/>	- Discussion	ACT00000181	Enrolled		<input type="text"/>	<input type="text"/>	<input type="text"/>	<input type="checkbox"/>		
	- Discussion Attendance	ACT00000182	Assigned		<input type="text"/>	<input type="text"/>	<input type="text"/>	<input type="checkbox"/>		
	- Topic Paper ±	ACT00000183		<input type="checkbox"/>	<input type="text"/>	<input type="text"/>	<input type="text"/>	<input type="checkbox"/>		
<input type="checkbox"/>	- Course Exam	ACT00000184	Assigned		<input type="text"/>	<input type="text"/>	<input type="text"/>	<input type="checkbox"/>		
	- Course Exam Section	ACT00000185	Enrolled	<input checked="" type="checkbox"/>	<input type="text"/>	<input type="text"/>	<input type="text"/>	<input type="checkbox"/>		

This example illustrates the fields and controls on the Individual Activity Manager page – Class & Exam Info tab. You can find definitions for the fields and controls later on this page.

Individual Activity Manager

Sharon Katz ID SR12200 Calculate

Institution PSUNV PeopleSoft University **Career** Undergraduate

Course Root ACT00001524 BIOLOGY 102 - General Biology II ***Root Status** Complete

Term 0650 2010 Fall **Session** 1 Regular Academic Session

Period ID 2010 FALL EP Fall 2010 Exam Period

Collapse All Create Initial Result Row Display Maximum Mark

Activity	Class & Exam Info	Credit Info	Most Recent Result							
Expand / Collapse	Content Description	Activity ID	Activity Status	Section	Assoc	Class NBR	Academic Period ID	Exam Type	Description	Meeting Information
<input type="checkbox"/>	Course	ACT00001524	Enrolled							
<input type="checkbox"/>	- Lecture	ACT00001525	Enrolled	1	1	1311				
	- Research Paper	ACT00001526	Assigned							
<input type="checkbox"/>	- Lab	ACT00001527	Enrolled	1A	1	1401				
<input type="checkbox"/>	- Lab Assignments - Select 2	ACT00001528	Assigned							
	- Lab Assignment 1	ACT00001529								
	- Or Lab Assignment 2	ACT00001530	Selected							
	- Or Lab Assignment 3	ACT00001531	Selected							
	- Or Lab Assignment 4	ACT00001532								
<input type="checkbox"/>	- Discussion	ACT00001533	Enrolled	1C	1	1405				
	- Discussion Attendance	ACT00001534	Assigned							
	- Topic Paper ±	ACT00001548								
<input type="checkbox"/>	- Course Exam	ACT00001535	Assigned				2010 FALL EP	COURSE EXAM	Course Exam	
	- Course Exam Section	ACT00001536	Enrolled							

This example illustrates the fields and controls on the Individual Activity Manager page – Credit Info tab. You can find definitions for the fields and controls later on this page.

Individual Activity Manager

Sharon Katz ID SR12200 Calculate

Institution PSUNV PeopleSoft University Career Undergraduate

Course Root ACT00001524 BIOLOGY 102 - General Biology II *Root Status Complete

Term 0650 2010 Fall Session 1 Regular Academic Session

Period ID 2010 FALL EP Fall 2010 Exam Period

Collapse All Create Initial Result Row Display Maximum Mark

Activity	Class & Exam Info	Credit Info	Most Recent Result			
Expand / Collapse	Content Description	Activity ID	Activity Status	Course Units	Units Taken	Standardized Units
<input type="checkbox"/>	Course	ACT00001524	Enrolled	3.50	4.00	
<input type="checkbox"/>	- Lecture	ACT00001525	Enrolled			0.75
<input type="checkbox"/>	- Research Paper	ACT00001526	Assigned			
<input type="checkbox"/>	- Lab	ACT00001527	Enrolled			0.75
<input type="checkbox"/>	- Lab Assignments - Select 2	ACT00001528	Assigned			
<input type="checkbox"/>	- Lab Assignment 1	ACT00001529				
<input type="checkbox"/>	- Or Lab Assignment 2	ACT00001530	Selected			
<input type="checkbox"/>	- Or Lab Assignment 3	ACT00001531	Selected			
<input type="checkbox"/>	- Or Lab Assignment 4	ACT00001532				
<input type="checkbox"/>	- Discussion	ACT00001533	Enrolled			0.75
<input type="checkbox"/>	- Discussion Attendance	ACT00001534	Assigned			
<input type="checkbox"/>	- Topic Paper ±	ACT00001548				
<input type="checkbox"/>	- Course Exam	ACT00001535	Assigned			1.25
<input type="checkbox"/>	- Course Exam Section	ACT00001536	Enrolled			

This example illustrates the fields and controls on the Individual Activity Manager page – Most Recent Result tab. You can find definitions for the fields and controls later on this page.

Individual Activity Manager

Sharon Katz ID SR12200 Calculate

Institution PSUNV PeopleSoft University Career Undergraduate

Course Root ACT00001524 BIOLOGY 102 - General Biology II *Root Status Complete

Term 0650 2010 Fall Session 1 Regular Academic Session

Period ID 2010 FALL EP Fall 2010 Exam Period



Collapse All Create Initial Result Row Display Maximum Mark

Activity	Class & Exam Info	Credit Info	Most Recent Result											
Expand / Collapse	Content Description	Activity ID	Activity Status	Result Nbr	Result Type	Result Sub-Type	Result Scale	Result Status	Include in Calc	Mark	Maximum Mark	Grade	Outcome	Results
<input type="checkbox"/>	Course	ACT00001524	Enrolled	1 of 1	AM RESULT		100 PT	00-Undetermined						
<input type="checkbox"/>	- Lecture	ACT00001525	Enrolled											
<input type="checkbox"/>	- Research Paper	ACT00001526	Assigned	1 of 1	AM RESULT		100 PT	00-Undetermined						
<input type="checkbox"/>	- Lab	ACT00001527	Enrolled											
<input type="checkbox"/>	- Lab Assignments - Select 2	ACT00001528	Assigned											
<input type="checkbox"/>	- Lab Assignment 1	ACT00001529												
<input type="checkbox"/>	- Or Lab Assignment 2	ACT00001530	Selected	1 of 1	AM RESULT		100 PT	05-Manual	<input checked="" type="checkbox"/>	84.00	100.00	B	Pass	+
<input type="checkbox"/>	- Or Lab Assignment 3	ACT00001531	Selected	1 of 1	AM RESULT		100 PT	05-Manual	<input checked="" type="checkbox"/>	92.00	100.00	A	Pass	+
<input type="checkbox"/>	- Or Lab Assignment 4	ACT00001532												
<input type="checkbox"/>	- Discussion	ACT00001533	Enrolled											
<input type="checkbox"/>	- Discussion Attendance	ACT00001534	Assigned											
<input type="checkbox"/>	- Topic Paper ±	ACT00001548												
<input type="checkbox"/>	- Course Exam	ACT00001535	Assigned	1 of 1	AM RESULT		100 PT	00-Undetermined						+
<input type="checkbox"/>	- Course Exam Section	ACT00001536	Enrolled	1 of 1	AM RESULT		100 PT	00-Undetermined						+

The IAM component captures a student's enrollment in a course and the associated activities of that course. This method of creating the IAM is to add the student and select the appropriate root activity based upon the student's class enrollment (STDNT_ENRL) or select from a list of courses designated as an EOC. When the record is added, a status is populated for each mandatory activity. These statuses are based upon a student's enrollment and upon settings defined in the Activity Registry and organized in the Activity Manager.

Field or Control	Description
Root Status	<p>This status concerns the assignment of the activities to the student. The delivered statuses are <i>Action Required</i>, <i>Completed</i>, and <i>Incomplete</i>. The status remains <i>Action Required</i> until all activities achieve an activity status which indicates all activities have been assigned. Once all eligible activities are associated with the student, the status changes to <i>Completed</i>. If a student drops or withdraws from the course the status changes to <i>Inactive</i>. Once the status is <i>Inactive</i>, you can no longer update results for the student.</p>
Calculate	<p>Select this button to calculate the primary result for the activities selected in the grid below. This button calls the IAM Result Entity coding and the rules engine for processing.</p> <p>At this time, using the calculation process to calculate an exam result does not allow users to manipulate the exam row for resits.</p> <p>See Understanding the Delivered Rules in Activity Management</p> <hr/> <p>Note: After you select Calculate and the calculation completes, the Previous and Next buttons aren't displayed. Oracle recommends you enter marks and calculate the results for the course activities using Activity Roster for multiple students in a batch and then verify the results in IAM.</p>
 <p>Lock</p>	<p>This icon locks the IAM record from further updates.</p>
Display All Attempts	<p>This check box appears when reassessment rows exist in the structure. Reassessment rows normally display within the horizontal scroll. Selecting this check box displays all rows individually.</p>
Create Initial Result Row	<p>This check box appears by default from the Student Admin Installation setup page. If selected, a result row with an undetermined status is automatically inserted for each assessed activity ID assigned to a student. This creates a result row prior to a result being entered or calculated. This row is visible in the IAM.</p> <p>If not selected, a result row is not created until a result is entered or calculated.</p> <p>The field can be overridden in the IAM prior to the page being saved.</p>
Activity tab	<p>This tab indicates the status of the activity assignment and is used to select and confirm activities, assign resits, and link to activity and result details.</p>

Field or Control	Description
Valid Attempt	Appears only on reassessed rows; this field is inserted and selected by default. Manually clear it to indicate that the attempt should not be considered a valid attempt.
Anonymous ID	This appears only when you generate an anonymous ID for the student, and depends on the settings in Activity Manager. See: <ul style="list-style-type: none"> • Setting Up Anonymous Grading • Generating Anonymous IDs
Activity ID	The activity assigned to the student links to the Activity Detail page.
Activity Status	When a student is enrolled in a class or an EOC, the system automatically sets a status or an action for the activities in the tree. It sets a status of <i>Enrolled</i> or <i>Assigned</i> for those activities that do not require any additional action by a student. For those activities that do require action by the student, the system leaves them blank. Once the required action (selection or confirmation) is completed, the system updates the status. The delivered statuses include: <i>Assigned</i> , <i>Assigned – confirmed</i> , <i>Assigned – requires confirmatn</i> , <i>Dropped</i> , <i>Enrolled</i> , <i>Enrolled – Confirmed</i> , <i>Enrolled – confirmation req'd</i> , <i>Resit Allowed</i> , <i>Resit Candidate</i> , <i>Resit Not Allowed</i> , <i>Reassessed</i> , <i>Selected</i> , <i>Selected – confirmed</i> , <i>Selected by Default</i> , <i>Selected as Resit</i> , <i>Withdrawn</i> , and <i>Waitlisted</i> .
Select	This check box appears when the user is required to select an optional activity. Users have the selection option when an activity is not mandatory or is associated with a condition. An exam section that requires selection aside from the class or EOC enrollment can also be selected. When you select the check box, the activity status changes to <i>Selected</i> .
Confirm	The confirm check box is available for those schedulable activities (exam sections) where the Confirmation Required check box was selected in the Activity Manager or the Section Manager. An activity requiring confirmation has an <i>Enrolled – Confirmation – Req'd</i> status. Once confirmed, the status changes to <i>Enrolled – Confirmed</i> .
Activity Extenuating Circumstance	Select a institutionally-defined Extenuating Circumstance against this activity. These are defined on the Extenuating Circumstances Table. An example of an extenuating circumstance may be a student illness, which indicates why the student was given an extended due date for the activity.

Field or Control	Description
Add Activity Result 	Select this icon to add results to the Activity Result page for the given activity.
Show Activity Results 	This icon appears when results exist for a given activity. Selecting it transfers the user to the Activity Result page.
Resits Allowed	<p>This field is populated for those activities which have had resit options created. It indicates the maximum number of resits allowed based on the Maximum Resit Limits setup in the Resit Options. If only one Resit Time Period is indicated, the field is listed as <i>Max [Nbr]</i>.</p> <p>If multiple Resit Time Periods are defined, the link field displays as <i>Limit Grid</i>.</p> <p>If no Maximum Resit Limit is defined the link field displays <i>No Limit</i>.</p> <p>Regardless of the link that appears, select the link to access the Individual Activity Manager – Resit Limit secondary page.</p>
Select for Calculation	<p>This check box indicates at which level you want the primary result calculation to occur.</p> <p>The check box appears at the parent activity level. When you select the check box, all child items that are eligible to be used in the calculation are also selected. Eligibility for assessment items is based on the due date or the extended due date, whichever is later. Clear any check box for an item that you do not want to use in the calculation.</p> <p>Consider an example in which all marks are entered for a course except the exam, which has not yet occurred. If you select the Select for Calculation check box for the course activity, all child items are also selected. To exclude the exam, clear the exam activity check box.</p> <p>After making all your selections, click the Calculate button at the top of the page to begin the calculation process.</p> <p>See Understanding the Delivered Rules in Activity Management</p>
Lock 	This icon locks the activity from further updates.

Field or Control	Description
Legend	<p>This box appears when any of the items in the content tree are designated as <i>Extra Credit</i>, <i>Individualized Content</i>, or a <i>Supplemental Resit</i>.</p> <p><i>Individualized Activity</i> (*) – This symbol appears for an activity when the activity was set up as individualized content in the Activity Manager.</p> <p><i>Extra Credit</i> (±) – This symbol appears for an activity when the activity was set up as an extra credit activity.</p> <p><i>Supplemental Resit</i> (^) – This symbol appears for an activity when the activity was set up as a supplemental resit.</p>
Class & Exam Info tab	<p>This tab displays the class section, class association, class number of any classes in the content tree, and the academic period and the exam type for any exam.</p>
Credit Info tab	<p>This tab displays the course units and the standardized units of an activity.</p>
Result Info tab	<p>This tab displays the current result row for the activity including the Result Number, Result Type, Result Source, Result Scale, Mark, Grade, and Outcome. Detail result information is available under the Show Activity Results icon. Click the Add Activity Result icon to add new results.</p> <p>The system displays results on the Result Info tab based on the following order:</p> <ol style="list-style-type: none"> 1. Displays the row if only one Result row is listed. 2. Displays the row for the Primary Result Type where Include in Calc = Y. 3. Displays the row with the highest Result Nbr with Include in Calc = Y when no row exists for the Primary Result Type. 4. Displays the row for the Primary Result Type with the highest Result Nbr when no Include in Calc = Y row exists. 5. Displays the row with the highest Result Nbr when no row exists for the Primary Result Type and no Include in Calc = Y row exists. <hr/> <p>Note: The Primary Result Type is set on the Academic Institution 9 page.</p> <hr/> <p>See “Defining Academic Institutions” (Campus Solutions Application Fundamentals)</p>

Reviewing Activity Status

When the IAM is added to the student, based on either class or EOC enrollment, the following occurs:

- Class components and course root activities status are set to *Enrolled*. No further action is required.
- All non component/course activities not requiring a selection or confirmation have a status set to *Assigned*. No further action is required.

Those activities requiring selection or confirmation may not have a status set automatically, but require further action as follows:

- Any activity requiring selection has a check box displayed in the Select column. Once selected, the status is set to *Selected* or *Enrolled* (for exam sections).
- Those activities requiring confirmation have a check box displayed in the Confirm column and the status is set to *Enrolled – Confirmation Req'd*. Once confirmed, the status is set to *Enrolled - Confirmed*.

While administrative and instructional users can select optional activities or confirm exam attendance for students at any point in time, students making the selection for themselves in self service can be restricted to a certain point in time. Define student access on the Action Dates component.

The logic utilized to set the statuses, actions, and restrictions when the IAM is first created is as follows:

Scenario	Initial Status	Action	Restrictions
1. All component activities (based on STDNT_ENRL) and their course root and related component activities 2. Exam Section where only one section exists (or multiple sections with "AND" connector type) under a mandatory parent and Confirmation not required	Enrolled	Not applicable (NA)	Not applicable (NA)
3. All non-course/non-component/non-exam section activities where Mandatory = Yes 4. All child activities of (1 & 3) where no enrollment rule exists	Assigned	NA	NA
5. Conditional activities when there exists an established default	Assigned	Remove/Select	Action Dates control student access
6. Conditional activities (could include exam sections)	[Blank]	Select/Remove	Action Dates control student access

Scenario	Initial Status	Action	Restrictions
7. Confirmable activities where no selection required	Enrolled – Confirmation Req'd	Confirm/UnConfirm	Action Dates control student access
8. Any activity defined as Individualized Content 9. Any activity defined as Extra Credit	[Blank]	Select/Remove	Selection is restricted to the IAM, Activity Roster, and the AMWC components

This table lists specific statuses that are inserted during the reassessment evaluation.

Status	Description
Reassessed	The status inserted on the attempt being reassessed.
Resit Allowed	A status that can be manually assigned to insert a resit row.
Resit Candidate	The status inserted on the current attempt row when the result entered was resit eligible and the coursework item was identified as a resitable item. This is the status that is picked up and analyzed by the resit evaluation rule.
Resit Not Allowed	This status is automatically inserted by the evaluation rule when the student is no longer eligible for an attempt.
Selected as Resit	This status is automatically inserted by the evaluation rule when the student is eligible for an additional attempt.

Reviewing Activity Detail

Access the Individual Activity Manager - Activity Detail page (click the **Activity ID** on the Individual Activity Manager page).

Note: Values here are inherited from the Activity Manager. Only those items that can be overridden for an individual student are editable on this page.

This example illustrates the Individual Activity Manager - Activity Detail page (Content Type = Assessment Item Detail).

Activity Detail [Find | View All](#) [First](#) 4 of 11 [Last](#)

Activity ID: ACT00000065
 Activity Status: Assigned
 Content Type: 6000 Assessment Item
 Content Item ID: ITX-000023 Silk and Fabric Painting [Return](#)
[Show Activity Results](#)

Content Options

Result Scale: 100 PT Override Weighting Multiplier: 1.00 Assessed
 Passing Mark/Grade: 60.000 / D Include in Calculation
 Calculate Standardized Units

Assignment Options

Extra Credit

General Options

Mandatory Allow Override or Substitution Topic Approval Required

Insufficient Mark Options

No Mark Option: Blank Mark - Include Minimum Mark Value: 0.000

Late Penalty Options

Penalty Type: Daily Penalty Grade Expires to Zero in: 5 Days
 Late Penalty: 5.000 Penalty Max: 20.000

Dates and Duration

Start Date: 01/03/2013 Grading Date: 06/03/2013
 Due Date: 04/03/2013 Extended Due Date:

<i>Field or Control</i>	<i>Description</i>
Extended Due Date	This field is available only at the student level. Its' purpose is to override a due date for an individual student. When an extended due date exists, the system displays it to the student and uses it in late penalty processing.

Establishing IAM Common Attributes for Activity Details

Access the Attributes page (click the **Attributes** link on the Activity Detail page).

This example illustrates the fields and controls on the Attributes page (for Activity Details).

Attributes

Empl ID:	SR0431	Edward Nolan
Academic Activity ID:	ACT00000422	Exam

Student Language: German

The screenshot above provides an example of common attributes set up for the course content item in the IAM. The fields that appear on the Attributes page are customer-specific and are defined on the Common Attributes and Record Context pages. The record context used for the IAM is the Individual Activities (SSR_IAM_CONTITM) record. The entity names used for the IAM have an “IAM” prefix.

See “Defining a Common Attribute” (Campus Community Fundamentals)

See “Associating a Common Attribute to a Record” (Campus Community Fundamentals)

Entering Activity Results for an Individual Student

Access the Individual Activity Manager - Activity Result page (click the **Add Activity Result** icon or the **Show Activity Results** icon on the Individual Activity Manager page).

This example illustrates the fields and controls on the Individual Activity Manager – Activity Result page. You can find definitions for the fields and controls later on this page.

See “Managing Course Rosters” to apply results to all students for an activity.

Field or Control	Description
Select	This column appears after an initial result has been saved. To insert a new value against an existing Result Type, select the check box and then select the Update Selected Result button. This inserts a new row for the Result Type where values can be updated.
Delete	Use this icon to delete an individual result row. Additional setup information is available on the Academic Institution table, tab 9, to control whether the Delete icon is available on the IAM.
Result Nbr (number)	This number is incremented for each result entered for the activity.
Result Type	This value defaults from the Primary Result Type on the Academic Institution Table. It can be overridden as necessary. See “Defining Academic Institutions” (Campus Solutions Application Fundamentals)

Field or Control	Description
Result Sub-Type	<p>This value reflects the type of mark:</p> <p><i>Insuff Mark</i> (insufficient mark) – this value is inserted on a calculated row automatically during the primary result calculation when the insufficient rule is invoked. This requires setup of the of insufficient mark option.</p> <p><i>Late Pen</i> (late penalty) – this value is inserted on a calculated row automatically when the late penalty rule is invoked. This requires setup of the of late penalty option.</p> <p><i>Mand Fail</i> (mandatory fail) – this value is inserted on a calculated row automatically when the mandatory pass rule is invoked. This requires flagging the Mandatory Pass flag and setting up a Mandatory Fail result on the Result scale.</p> <p><i>Resit Calc</i> (resit calculation) – this value should be manually inserted on a row that is entered as a resit result. This value is automatically inserted via the rules engine in a future release.</p>
Result Scale	<p>The result scale defaults from the Activity Manager as long as the result scale is represented on the Result Type table. It can be overridden as necessary.</p> <hr/> <p>Note: When grades are used in the result scale, the grading basis must match the grading basis associated with the student's enrollment record.</p> <hr/>
Show Result Scale	<p>Click this link to access the Result Scale Table, which displays the result scale being used for the row.</p>
Result Status	<p>When the Create Initial Result Row is selected, the Result Status defaults to <i>00-Undetermined</i>. When the status is changed to a different value the Include in Calc, Earned Mark, Grade, and Outcome fields appear as applicable.</p> <p>When the Create Initial Result Row option is cleared, the Result Status defaults to <i>05-Manual</i>.</p> <p>The delivered translate (SSR_IAM_RSLT_STAT) values are:</p> <p><i>00-Undetermined</i></p> <p><i>05-Manual</i></p> <p><i>07-Imported</i></p> <p><i>10-Calculated</i></p> <p><i>20-Awaiting Approval</i></p> <p><i>30-Approved</i></p> <p><i>40-Overridden</i></p> <p><i>50-Final</i></p>

Field or Control	Description
Submission Date	<p>For assessment items, the due date appears by default, but you can override it as needed. If the submission date is later than the due date and late penalty criteria is defined on the Activity Manager, then the system automatically calculates and inserts a row with a penalty mark.</p> <p>See Understanding the Delivered Rules in Activity Management</p>
Include in Calc	<p>The system automatically inserts this field value based on the scenario:</p> <ol style="list-style-type: none"> 1. When using Create Initial Row, on the initial Undetermined row Include in Calc = <i>No</i>. 2. The scale uses the Mark field, on an insert Include in Calc = <i>Yes</i>. 3. The scale does not use the Mark field, but the mandatory pass flag = <i>Yes</i> then Include in Calc = <i>Yes</i>. 4. The scale does not use the Mark field and the mandatory pass flag = <i>No</i> then Include in Calc = <i>No</i>. No override. 5. When a new result row is entered following steps 2 through 4, the previous row Include in Calc = <i>No</i>.
Earned Mark	Enter the student earned mark for this activity. This mark should be in the range of the minimum and maximum mark defined on the Result Scale.
Maximum Mark	This column appears if the Display Maximum Mark is selected on the Student Admin Installation page. The maximum value defined on the Result Scale is displayed.
Grade	Enter the student grade for this activity. This value is populated automatically based on the Earned Mark (result scale mapping), but can be overridden.
Outcome	Enter the student outcome for this activity. This value is populated automatically based on the Earned Mark (result scale mapping), but can be overridden.
Result Extenuating Circumstance	Enter or update a Result Extenuating Circumstance as needed.
Result Notes	Enter any comments applicable to the activity result.
Add New Result Type	This button inserts a new result row for users to enter a new Result Type.

Field or Control	Description
Update Selected Result	This button inserts a new result row for a selected Result Type. Additional setup information is available on the Academic Institution table— tab 9, to control whether the Update Selected button/link is available on the IAM, Result Roster and the Activity Workcenter.

Establishing IAM Common Attributes for Activity Results

Access the Attributes page (click the **Attributes** link on the Activity Results page).

This example illustrates the fields and controls on the Attributes page (for Activity Results). You can find definitions for the fields and controls later on this page.

Attributes

Empl ID:	SR0431	Edward Nolan
Academic Activity ID:	ACT00000422	Exam
Activity ID Sequence Number:	1	
Result Sequence Nbr:	1	

Student Shift: ST - Shift 3 - rate + factor

Formal Description:

The screenshot above provides an example of common attributes set up for the activity result in the IAM. The fields that appear on the Attributes page are customer-specific and are defined on the Common Attributes and Record Context pages. The record context used for the IAM is the Activity Results (SSR_IAM_RESULT) record. The entity names used for the IAM have an “IAM” prefix.

See “Defining a Common Attribute” (Campus Community Fundamentals) “Associating a Common Attribute to a Record” (Campus Community Fundamentals)

Understanding Reassessment

Reassessment, or resits, are supported in Activity Management. Resits are defined in the Resit Option inclusion record for content items in the Activity Registry and carried forward to the Activity Manager, where they can be overridden as necessary. Users define the number of times a piece of coursework can be attempted during a specific time period and how it is reassessed. Users also define on the result scale which result rows are eligible for a resit.

Coursework can be reassessed in one of two ways. Students can be reassessed in the same piece of coursework or they may be required to undertake a supplemental piece of coursework. Regardless of the method of reassessment, the characteristics of the resit defined in the Activity Manager are associated with the student who enrolls in the course root. Student progress in these reassessed activities is tracked in the IAM. Students are allowed to resit an exam in the same term as well as the next existing term.

The determination of a student's resit eligibility and the calculation of a resit result are done using integration with the Rules Engine.

A result that is entered is deemed resit eligible when the result row on the Result Scale is identified as resit eligible. The activity itself must also be identified with the Resit Allowed flag on the Resit Option. When both these conditions are met, the activity status for the attempt is automatically updated to Resit Candidate. This status change can also be performed manually if a student is given permission to resit even with a result that is not indicated as resit eligible.

Once the activity status is set to *Resit Candidate* users run the IAM Resit Evaluation. This process uses a Population Selection process to identify specific resit candidate populations and calls the Rules Engine where a number of evaluations are performed to determine whether the student meets the attempt allowed criteria defined for the specific activity. If a student meets the criteria, the current attempt row is changed to Reassessed and a new row is inserted (for supplemental resits, this row already exists. The inserted row is assigned the status *Selected as Resit*. If the student does not meet the eligibility criteria, the initial attempt row is set to *Resit Not Allowed*). It is essential that resit activities for exams are created with a future exam academic period.

However, if the Resit Option is set to Student Selection and the student is deemed eligible for a resit, only the current attempt row is set to Resit Allowed.

Note: Resit activities are not initially displayed within the IAM course root of the student. The resit activities only become available when a student is resit eligible and satisfies the resit evaluation requirements.

See [Understanding the Delivered Rules in Activity Management](#).

Evaluating Reassessment Eligibility

Access the IAM Resit Evaluation page (**Records and Enrollment > Individual Activity Manager > IAM Resit Evaluation**).

This example illustrates the fields and controls on the IAM Resit Evaluation page. You can find definitions for the fields and controls later on this page.

The screenshot displays the 'IAM Resit Evaluation' page. At the top, there is a 'Run Control ID' section with 'AD' and two links: 'Report Manager' and 'Process Monitor'. A yellow 'Run' button is located to the right. Below this, the '*Institution' field is set to 'PSUNV' with a search icon, and the text 'PeopleSoft University' is displayed. The main section is titled 'Population Selection' and contains a checked checkbox for 'Population Selection'. Underneath, the 'Selection Tool' is set to 'PS Query' and the 'Query Name' is 'SSR_IAM_RESIT_EVAL_BY_INST'. There are three links: 'Edit Prompts', 'Launch Query Manager', and 'Preview Selection Results'.

Running the process calls the Rules Engine where attempts allowed are analyzed and resit rows and resit statuses are inserted.

Field or Control	Description
Population Selection	<p>Population Selection is a method for selecting the IDs to process for a specific transaction. The Population Selection group box is a standard group box that appears on run control pages when the Population Selection process is available or required for the transaction. Selection tools are available based on the selection tools that your institution selected in the setup of the Population Selection process for the application process and on your user security. Fields in the group box appear based on the selection tool that you select. The fields behave the same way from within the group box on all run control pages and application processes. If your institution uses a specific delivered selection tool (such as PS Query) to identify IDs for a specific transaction, you must use it.</p> <p>The delivered queries include the following:</p> <p>SSR_IAM_RESIT_EVAL_BY_INST evaluates all resit candidates for the institution. Prompts users to enter the institution.</p> <p>SSR_IAM_RESIT_EVAL_BY_PERIOD evaluates all resit candidates for a given academic period. Prompts users to enter the institution and the academic period.</p> <p>SSR_IAM_RESIT_EVAL_BY_STUDENT evaluates a specific student. Prompts users to enter the institution and ID.</p> <p>SSR_IAM_RESIT_EVAL_BY_TERM evaluates all resit candidates for a given term. Prompts users to enter the institution and the term.</p> <p>You can create additional queries as needed.</p> <p>See “Using the Population Selection Process” (Campus Community Fundamentals)</p>

Resit Example 1 – Exam Resit

The exam activity is identified as resit allowed and the student is allowed two attempts to pass the exam.

This example illustrates a course exam with two attempts allowed. Note the **Limit 2** link displayed in the Attempts Allowed column.

Expand / Collapse	Content Description	Activity ID	Activity Status	Select	Extenuating Circumstances	Results	Attempts Allowed	Lock	Select for Calculation
[-]	Course	ACT00000845	Enrolled			+			<input type="checkbox"/>
[-]	[-] Lecture	ACT00000846	Enrolled						
	[-] [-] Research Paper	ACT00000847	Assigned	<input type="checkbox"/>	<input type="text"/>	+			
[-]	[-] Lab	ACT00000848	Enrolled						
[-]	[-] Lab Assignments - Select 2	ACT00000849	Assigned						
	[-] [-] [-] Lab Assignment 1	ACT00000850		<input type="checkbox"/>					
	[-] [-] [-] Or Lab Assignment 2	ACT00000851		<input type="checkbox"/>					
	[-] [-] [-] Or Lab Assignment 3	ACT00000852		<input type="checkbox"/>					
	[-] [-] [-] Or Lab Assignment 4	ACT00000853		<input type="checkbox"/>					
[-]	[-] Discussion	ACT00000854	Enrolled						
	[-] [-] Discussion Attendance	ACT00000855	Assigned	<input type="checkbox"/>	<input type="text"/>				
[-]	[-] Course Exam	ACT00000856	Assigned	<input type="checkbox"/>	<input type="text"/>	+	Limit 2		<input type="checkbox"/>
	[-] [-] Course Exam Section	ACT00000857	Enrolled	<input type="checkbox"/>	<input type="text"/>	+			

The attempts allowed link displays the resit limits defined for the activity. The attempts limit section indicates the student is allowed two attempts while enrolled in their academic program. Depending on setup, this may be the next regular exam period, or the next regular resit exam period.

Individual Activity Manager - Resit Limit

Activity ID: ACT00000398

Content Type: 4000 Exam

Content Item ID: ITX-000050 Course Exam

Resit Options

Resits Allowed **Calculation Option:**

Supplemental Resit **Supplemental Activity:**

Resit Period Options

Resit Period Assignment:

Student Can Refuse

Attempt Limits

Attempt Time Period	Allowed Attempts
<input type="text" value="Academic Program"/>	<input type="text" value="2"/>

Once the exam is graded and the mark entered is indicated as resit eligible, the activity status is updated to Resit Candidate.

[-]	[-] Course Exam	ACT00000398	Resit Candidate	<input checked="" type="checkbox"/>	<input type="text"/>	+	Limit 2		<input type="checkbox"/>
	[-] [-] Course Exam Section	ACT00000399	Enrolled	<input type="checkbox"/>	<input type="text"/>	+			

Users can use the IAM Resit Evaluation process to evaluate the students' attempts against the Attempt Time Period. As indicated on the Resit Limit page indicated above, the student can attempt the exam twice during their enrollment in their academic program.

The result of the evaluation indicates the student is eligible to attempt the exam again. The Rules Engine triggers an action to generate an IAM Resit request that changes the status of initial activity to *Reassessed* and insert a new attempt. The new attempt is assigned the status of *Selected as Resit*. As part of the evaluation, it was determined that the student should be assigned to the next available exam period. Once the new exam period is assigned, a horizontal scroll appears to allow navigation between the multiple attempts. Users can select the **Display All Attempts** flag in the IAM header to display both attempts in the content tree. Record 1 of 2 is the initial attempt with a status of *Reassessed*, while the second attempt (2 of 2) has been selected as a resit but has not yet had results assigned.

[-] Course Exam	1 of 2	<input checked="" type="checkbox"/>	ACT00000398	Reassessed	<input checked="" type="checkbox"/>		Limit 2	
[-] Course Exam Section			ACT00000399	Enrolled	<input checked="" type="checkbox"/>			
[-] Course Exam	2 of 2	<input checked="" type="checkbox"/>	ACT00000494	Selected as Res	<input checked="" type="checkbox"/>		Limit 2	
[-] Course Exam Section			ACT00000495	Enrolled	<input checked="" type="checkbox"/>			

This example illustrates the exam period assigned. This data is visible on the Class & Exam Info tab of the IAM.

[-] Course Exam	1 of 2	<input checked="" type="checkbox"/>	ACT00000494	Reassessed	FALL 2012	COURSE EXAM	Course Exam
[-] Course Exam Section			ACT00000495	Enrolled			
[-] Course Exam	2 of 2	<input checked="" type="checkbox"/>	ACT00000182	Selected as Res	2013 FALL EP	COURSE EXAM	Course Exam
[-] Course Exam Section			ACT00000183	Enrolled			

Note: A standard resit can also be applied to non-exam assessment items. The difference for non-exam assessment items is that an exam period is not assigned. While an exam period is not assigned for an assessment item resit, users can define an extended due date on the Activity Detail page.

Once a result is entered for the resit, the Resit Calculation process is called. Resit calculation is determined by the Calculation Option that is defined in the Activity Manager. The following example indicates that the calculation option is set as Average All Marks.

In the example, the result is the average of the first (55.00) (not shown) and second attempt (65.00). The calculation process inserts a row on the current attempt with a message, the **Result Sub-Type** is set to *Resit Calc*, and the **Include in Calc** is set on the calculated result. Adding this row allows the calculation to use the correct result value.

Delete	Result Nbr	Process Status	*Result Type	Result Sub-Type	*Result Scale	Show Result Scale	*Result Status	Include in Calc	Earned Mark	Maximum Mark	Grade	Outcome	SE Post Status	PE Post Status	Result Notes
	2	Resit Calculated Mark	AM RESULT	Resit Calc	100 PT		10-Calculated	<input checked="" type="checkbox"/>	60.00000	100.00000	D	Pass			
	1		AM RESULT		100 PT		05-Manual	<input type="checkbox"/>	65.00000	100.00000	D	Pass			

Resit Example 2 – Supplemental Resit

The following example walks a user through a supplemental resit option.

Supplemental Resits can be created for exams, assessment items and category content items. A student cannot resit a supplemental item. As displayed in the **Attempts Allowed** column, the maximum attempts allowed are 2 — the original attempt and one supplemental attempt. The ^ symbol indicates a supplemental resit. It cannot be assigned until the original attempt is denoted as failed.

A supplemental resit and a nonsupplemental resit work identically in that, statuses are assigned the same way and an exam period is assigned for exams. The only difference is that the supplemental is created in the tree initially (unlike standard resits) and when it is selected as a resit, the supplemental activity is physically moved into the tree display right under the previous attempt.

This example illustrates a supplemental resit activity.

Individual Activity Manager

David Beckett ID SR0401 PE Student Calculate

Institution PSUNV PeopleSoft University Career Undergraduate

Course Root ACT00003547 ART 9200 - Individual Supplemental Resit *Root Status Completed

Term 0750 2015 Fall Session 1 Regular Academic Session

Period ID FALL-2016RS Fall 2016 Fall Resit Period

Collapse All Display All Attempts Create Initial Result Row Display Maximum Mark

Activity	Class & Exam Info	Credit Info	Most Recent Result	Attachments	Valid Attempt	Activity ID	Activity Status	Select	Extemuating Circumstances	Results	Attempts Allowed	Lock	Select for Calculation
[-] Course					<input checked="" type="checkbox"/>	ACT00003547	Enrolled	<input checked="" type="checkbox"/>		+		<input type="checkbox"/>	<input type="checkbox"/>
[-] Assessment 1			1 of 2		<input checked="" type="checkbox"/>	ACT00003548	Reassessed	<input checked="" type="checkbox"/>			Limit 2	<input type="checkbox"/>	<input type="checkbox"/>
[-] Supp Exam for Assessment 1 ^			2 of 2		<input checked="" type="checkbox"/>	ACT00003552	Resit Not Allow	<input checked="" type="checkbox"/>				<input type="checkbox"/>	<input type="checkbox"/>
[-] Supp Exam for Assessment 1 Section					<input checked="" type="checkbox"/>	ACT00003553	Enrolled	<input checked="" type="checkbox"/>		+		<input type="checkbox"/>	<input type="checkbox"/>
[-] Assessment 2					<input checked="" type="checkbox"/>	ACT00003549	Assigned	<input checked="" type="checkbox"/>		+		<input type="checkbox"/>	<input type="checkbox"/>
[-] Exam			1 of 2		<input checked="" type="checkbox"/>	ACT00003550	Reassessed	<input checked="" type="checkbox"/>			Limit 2	<input type="checkbox"/>	<input type="checkbox"/>
[-] Exam Section					<input checked="" type="checkbox"/>	ACT00003551	Enrolled	<input checked="" type="checkbox"/>		+		<input type="checkbox"/>	<input type="checkbox"/>
[-] Supp Exam for Exam ^			2 of 2		<input checked="" type="checkbox"/>	ACT00003554	Resit Not Allow	<input checked="" type="checkbox"/>				<input type="checkbox"/>	<input type="checkbox"/>
[-] Supp Exam for Exam Section					<input checked="" type="checkbox"/>	ACT00003555	Enrolled	<input checked="" type="checkbox"/>		+		<input type="checkbox"/>	<input type="checkbox"/>

LEGEND

^ Supplemental Resit

Note: During the resit calculation process, the attempts (and all the child item attempts) replaced with the Resit Calc row have the Include in Calc flag set to *No*. For detailed information, see *Setting Up Supplemental Exams* on My Oracle Support (Doc ID 1400723.1).

Creating IAMs Automatically

You can trigger IAM creation automatically on the Academic Institution 9 page. The fields in the Create/Remote Individual Activity Manager group box enable you to choose IAM trigger options.

See “Defining Academic Institutions” (Campus Solutions Application Fundamentals)

Creating IAMs in Batch Using Student Enrollment

Access the IAM Batch Generator using Student Enrollment page (**Records and Enrollment > Individual Activity Manager > IAM Gen using Student Enroll**).

This example illustrates the fields and controls on the IAM Batch Generator using Student Enrollment page (Population Selection).

IAM Batch Generator using Student Enrollment

Run Control ID: MP [Report Manager](#) [Process Monitor](#) [Run](#)

*Institution PeopleSoft University

Population Selection

Population Selection

Selection Tool: [Edit Prompts](#)

Query Name: [Launch Query Manager](#) [Preview Selection Results](#)

Filtered Selection

Use Filtered Selection

Transaction

[Get/Refresh Last Request](#)

IAM Enrollment Request ID	0000000026	Number of Transactions	8
Process Instance	2512	Transactions in Pending	0
Date/Time Stamp	06/03/13 11:33:05AM	Transactions in Success	8
		Transactions with Message	0
		Transactions in Error	0

Seq #	ID	Name	Academic Career	Course Activity ID	Subject	Catalog Nbr	Activity Id	Request Action	Status
1	FAPF166	FARI FAYAMA	Undergraduate	ACT00001319	ENGLCOMP	100	ACT00001319	Create	Success
2	FAPF169	IARI IAYAMA	Undergraduate	ACT00001319	ENGLCOMP	100	ACT00001319	Create	Success
3	FAPF170	JARI JAYAMA	Undergraduate	ACT00001319	ENGLCOMP	100	ACT00001319	Create	Success
4	SR0434	Barry Pollock	Undergraduate	ACT00001319	ENGLCOMP	100	ACT00001319	Create	Success
5	SR0430	Chong No	Undergraduate	ACT00001319	ENGLCOMP	100	ACT00001319	Create	Success
6	SR0433	Alejandro Noriega	Undergraduate	ACT00001319	ENGLCOMP	100	ACT00001319	Create	Success
7	SR0432	Marian Norfleet	Undergraduate	ACT00001319	ENGLCOMP	100	ACT00001319	Create	Success
8	SR0431	Edward Nolan	Undergraduate	ACT00001319	ENGLCOMP	100	ACT00001319	Create	Success

This example illustrates the fields and controls on the IAM Batch Generator using Student Enrollment page (a filtered selection).

IAM Batch Generator using Student Enrollment

Run Control ID: MP [Report Manager](#) [Process Monitor](#) [Run](#)

*Institution PeopleSoft University

Population Selection

Population Selection

Filtered Selection

Use Filtered Selection [Clear Filtering](#) [Preview Results](#) [Clear Preview](#)

Term 2010 Fall

filter by

Empl ID	Session	Academic Career	Academic Organization	Subject	Academic Item ID	Description	Course Activity ID	Request Action
<input type="text"/>	<input type="text"/>	<input type="text"/>	<input type="text"/>	<input type="text"/>	<input type="text"/>	<input type="text"/>	<input type="text"/>	<input type="text"/>

Preview

ID	Name	Session	Academic Career	Academic Organization	Class Nbr	Subject	Catalog Nbr	Course Activity ID	Enrollment Status	Request Action	
1	ADCRM1004	Alexandria Thomas	Regular	Undergrad	BIOLOGY	1311	BIOLOGY	102	ACT00001524	Enrolled	Create
2	ADCRM1004	Alexandria Thomas	Regular	Undergrad	ECONOMICS	2431	ECON	140	ACT00000008	Enrolled	Create
3	SR0401	David Beckett	Regular	Undergrad	ART	1019	ART	121	ACT00001556	Enrolled	Create
4	SR12200	Sharon Katz	Regular	Undergrad	BIOLOGY	1311	BIOLOGY	102	ACT00001524	Enrolled	Create
5	SRGR0010	Peter Hirst	Regular	Undergrad	MUSIC	1167	MUSIC	170	ACT00001429	Enrolled	Create
6	SRGR0014	Callum Frain	Regular	Undergrad	MUSIC	1167	MUSIC	170	ACT00001429	Enrolled	Create
7	SRGR0020	Hans King	Regular	Undergrad	MUSIC	1167	MUSIC	170	ACT00001429	Enrolled	Create
8	SRGR0022	Guy Neill	Regular	Undergrad	MUSIC	1167	MUSIC	170	ACT00001429	Enrolled	Create

Transaction

This page changes depending on the batch generation method you select. This component enables you to generate IAMs for students based on their class enrollment. The process identifies the student population and creates and processes the request to create the student IAM. The component offers two methods to identify the student population.

Population Selection

Population selection is a method for selecting the IDs to process for a specific transaction. The Population Selection group box is a standard group box that appears on run control pages when the Population Selection process is available or required for the transaction. Selection tools are available based on the selection tools that your institution selected in the setup of the Population Selection process for the application process and on your user security. Fields in the group box appear based on the selection tool that you select. The fields behave the same way from within the group box on all run control pages and application processes. If your institution uses a specific delivered selection tool (such as PS Query) to identify IDs for a specific transaction, you must use it.

The delivered query, `SSR_IAM_ENR_BY_INST_TERM`, prompts users to enter the institution and the term. You can create additional queries as needed.

See “Using the Population Selection Process” (Campus Community Fundamentals)

Filtered Selection

A second method of generation is the Filtered Selection. Here you can filter the selection within the **Institution** and **Term** boundaries by **EmplID**, **Session**, **Academic Career**, **Academic Organization**, **Subject**, **Academic Item ID** (if Program Enrollment is enabled), and **Course Activity ID**. Select the appropriate **Request Status**, *Create* (to create the IAM) or *Delete* (to delete the IAM). Once again, you can preview results before actually running the process.

Transaction

Regardless of method, you can view data from the last transaction by clicking the **Get/Refresh Last Request** button.

Creating IAMs in Batch Using APT

Access the IAM Batch Generator using APT (EOC) page (**Records and Enrollment > Individual Activity Manager > IAM Gen using APT (EOC)**).

This example illustrates the fields and controls on the IAM Batch Generator using APT (EOC) page. You can find definitions for the fields and controls later on this page.

This component enables you to generate IAMs in batch for students enrolled in EOCs. This process is based on courses that are identified as *Exam Only* on the student's Academic Progress Tracker (APT). The process identifies the student population and creates and processes the request to create the student IAM. Adding EOCs not defined on an APT must be done manually in the IAM component.

Because the **Academic Period** is not required on the APT for an EOC, you should associate a term with an academic period on the Academic Period setup table. In this way the system can tie together the term with which the course is associated on the APT to the appropriate academic period. The term used from the APT is the term associated with the individual student on the Academic Item Attempt Schedule or the term extrapolated from the study period based on the enrollment cohort. However, if a term is associated with multiple academic periods and course roots for the EOC exist in multiple academic periods, the system will not be able to determine the academic period. In this instance, the batch process generates an error on those students. We recommend that you add those students manually to the batch process or add the academic period directly onto the student's APT for the course.

When creating IAMs in batch for EOC students, the Academic Period Start Date is considered as the maximum date when IAM records are created. The Max EOC Program Date provides the ability to override the Start Date to a later date for the creation of IAM records.

Note: To add non-Program Enrollment students to an EOC you must manually add an IAM record on the Individual Activity Manager component.

Population Selection

Population selection is a method for selecting the IDs to process for a specific transaction. The Population Selection group box is a standard group box that appears on run control pages when the Population Selection process is available or required for the transaction. Selection tools are available based on the selection tools that your institution selected in the setup of the Population Selection process for the application process and on your user security. Fields in the group box appear based on the selection tool that you select. The fields behave the same way from within the group box on all run control pages and application processes. If your institution uses a specific delivered selection tool (such as PS Query) to identify IDs for a specific transaction, you must use it.

The delivered Population Selection query, SS_IAM_ENR_BY_INST_PERIOD, prompts users to enter the institution and the academic period into which the students are assigned. You can create additional queries as needed.

See “Using the Population Selection Process” (Campus Community Fundamentals)

Filtered Selection

In this group box, you can filter the selection within the Institution boundary with **Term, Session, Academic Period ID, Academic Career, Academic Organization, Academic Program, Academic Item ID, Subject, Enrollment Category, Advisor Approval Status, Year of Program, Academic Year,** and **Progress Level**. The latter five filters are specific to Program Enrollment.

Manual entry by Student & Course

The final method of generation is by manually entering individual students.

Generating an IAM Student Block

Access the IAM Students Block page (**Records and Enrollment > Individual Activity Manager > IAM Block Generation > IAM Students Block**).

This example illustrates the fields and controls on the IAM Students Block page. You can find definitions for the fields and controls later on this page.

IAM Students Block

Academic Institution PSUNV PeopleSoft University

Student Block ID BIO_102_0650 Description

Personalize | Find | View All | | First 1-3 of 3 Last

ID	Academic Career	Name			
1	SR13037	UGRD	Grace Dublin	<input type="button" value="+"/>	<input type="button" value="-"/>
2	SR13038	UGRD	Nigel Beaque	<input type="button" value="+"/>	<input type="button" value="-"/>
3	SR12200	UGRD	Sharon Katz	<input type="button" value="+"/>	<input type="button" value="-"/>

Population Selection

Population Selection

Selection Tool: [Edit Prompts](#)

Query Name: [Launch Query Manager](#) [Preview Selection Results](#)

This component enables you to create a block of students to whom activities are assigned. Two methods are delivered: student manual entry or population selection.

<i>Field or Control</i>	<i>Description</i>
Student Block ID	Displays the unique identifier of the student block.

Field or Control	Description
Description	Enter a description of the student block.
ID	Enter the EmplID of the student.
Academic Career	Enter the student's academic career.

Population Selection

Population selection is a method for selecting the IDs to process for a specific transaction. The Population Selection group box is a standard group box that appears on run control pages when the Population Selection process is available or required for the transaction. Selection tools are available based on the selection tools that your institution selected in the setup of the Population Selection process for the application process and on your user security. Fields in the group box appear based on the selection tool that you select. The fields behave the same way from within the group box on all run control pages and application processes. If your institution uses a specific delivered selection tool (such as PS Query) to identify IDs for a specific transaction, you must use it.

The delivered Population Selection query, `SSR_IAM_STD_CAREER_PROG`, prompts users to enter the institution, career, and academic program. You can create additional queries as needed.

See “Using the Population Selection Process” (Campus Community Fundamentals)

Generating an IAM Activity Block

Access the IAM Activities Block page (**Records and Enrollment > Individual Activity Manager > IAM Block Generation > IAM Activities Block**).

This example illustrates the fields and controls on the IAM Activities Block page. You can find definitions for the fields and controls later on this page.

IAM Activities Block

Academic Institution: PSUNV PeopleSoft University
 Activity Block ID: BIO_102_0650 Description:
 Display Exam Activities Only

Course Root End | View All First 1 of 1 Last

Course Root: BIOLOGY 102 | General Biology II | 003702-1
 0650 - 2010 Fall | Regular Academic Session | Undergraduate
 2010 Fall Wxan Period
 Course Root Information: Class Association 1
 Collapse All

Content Tree Activities

Expand / Collapse	Description	Activity ID	Class Section	Class Assoc	Class Nbr	Required	Select	Remove
<input type="checkbox"/>	Course	ACT00000181				<input checked="" type="checkbox"/>		
<input type="checkbox"/>	↳ Lecture	ACT00000182	1	1	1311	<input checked="" type="checkbox"/>		
	↳ Research Paper	ACT00000183				<input checked="" type="checkbox"/>		
	↳ Lab	ACT00000184	1A	1	1401	<input checked="" type="checkbox"/>		
	↳ Lab Options - Select 2	ACT00000185				<input checked="" type="checkbox"/>		
	↳ Lab Assignment 1	ACT00000186					<input type="checkbox"/>	<input type="button" value="X"/>
	↳ Or Lab Assignment 2	ACT00000187				<input checked="" type="checkbox"/>	<input checked="" type="checkbox"/>	<input type="button" value="X"/>
	↳ Or Lab Assignment 3	ACT00000188				<input checked="" type="checkbox"/>	<input checked="" type="checkbox"/>	<input type="button" value="X"/>
	↳ Or Lab Assignment 4	ACT00000189					<input type="checkbox"/>	<input type="button" value="X"/>
<input type="checkbox"/>	↳ Discussion	ACT00000190	1C	1	1405	<input checked="" type="checkbox"/>		
	↳ Discussion Attendance	ACT00000191				<input checked="" type="checkbox"/>		
	↳ Topic Paper ±	ACT00000205					<input type="checkbox"/>	<input type="button" value="X"/>
<input type="checkbox"/>	↳ Course Exam	ACT00000192				<input checked="" type="checkbox"/>		
	↳ Course Exam Section	ACT00000193				<input checked="" type="checkbox"/>		

LEGEND

± Extra Credit

Population Selection

Population Selection

Selection Tool:
 Query Name:

This component enables you to create a block of course roots against which you can select optional activities. The system displays course roots and their associated coursework. Users can enter individual course roots or use Population Selection to identify a group of course roots.

Field or Control	Description
Activity Block ID	Displays the unique identifier of the activity block.
Description	Enter a description of the activity block.
Display Exam Activities Only	Select this check box to display only the course roots' exams and exam sections.
Course Root	Enter the Activity ID for the course root to display the specific content tree.

Population Selection

Population selection is a method for selecting the IDs to process for a specific transaction. The Population Selection group box is a standard group box that appears on run control pages when the Population Selection process is available or required for the transaction. Selection tools are available based on the selection tools that your institution selected in the setup of the Population Selection process for the application process and on your user security. Fields in the group box appear based on the selection tool that you select. The fields behave the same way from within the group box on all run control pages and application processes. If your institution uses a specific delivered selection tool (such as PS Query) to identify IDs for a specific transaction, you must use it.

The delivered Population Selection query, SSR_IAM_BLK_BY_INST_SUBJECT, prompts users to enter the institution, term, and subject. You can create additional queries as needed.

See “Using the Population Selection Process” (Campus Community Fundamentals)

Using the IAM Batch Generator

Access the IAM Batch Generator using Block Process page (**Records and Enrollment > Individual Activity Manager > IAM Block Generation > IAM Gen Using Block Process**).

This example illustrates the fields and controls on the IAM Batch Generator using Block Process page. You can find definitions for the fields and controls later on this page.

This component enables you to merge the student and activities blocks and assign the selected activities to the students. Users can opt to not set up a student block and use Population Selection on this page instead.

Field or Control	Description
Activity Block ID	Select the activity block ID.

Field or Control	Description
Transaction Violation Action	Indicate how the system should handle overrides of previous selections. If a student already meets the selection requirement (for example, they have already had two of four lab assignments selected), decide whether the system should Remove previous selections and replace them with the process results or generate an Error for the given student.
Student Block Selection	If you choose not to use Population Selection, select the Student Block ID.
Student Block ID	Select the student block ID.

Population Selection

Population selection is a method for selecting the IDs to process for a specific transaction. The Population Selection group box is a standard group box that appears on run control pages when the Population Selection process is available or required for the transaction. Selection tools are available based on the selection tools that your institution selected in the setup of the Population Selection process for the application process and on your user security. Fields in the group box appear based on the selection tool that you select. The fields behave the same way from within the group box on all run control pages and application processes. If your institution uses a specific delivered selection tool (such as PS Query) to identify IDs for a specific transaction, you must use it.

The delivered Population Selection query, `SSR_IAM_BLK_BY_CAR_AND_PROG`, prompts users to enter the institution, career, and academic program. You can create additional queries as needed.

See “Using the Population Selection Process” (Campus Community Fundamentals)

Reviewing IAM Requests

Access the IAM Activity Request page (**Records and Enrollment > Individual Activity Manager > IAM Activity Request**).

This example illustrates the fields and controls on the IAM Activity Request page.

IAM Activity Request										
Request ID		0000000063								
Total Transactions		1		Pending (0)		Error (0)		Message (1)		Success (0)
Personalize Find View All First 1 of 1 Last										
Detail Audit (1)										
Seq #	ID	Name	Institution	Career	Request Action	Activity ID	Activity Seq#	Root ID	Request Status	Source
1	SRAM0002	Chris Walker	PSUNV		Delete	ACT00000541	1	ACT00000541	Message	Stdnt Enrl

Use this component to troubleshoot IAM requests generated from the creation of the IAM from the Enrollment Event, from the IAM batch processes, and from the AM-to-IAM sync process.

The page is accessed using the **Request ID** from the above processes. Users can view transaction statuses and view any messages generated.

Reviewing the IAM Activity Request Log

Access the IAM Request Message Log page (click the **Messages** link on the IAM Activity Request page).

This example illustrates the fields and controls on the IAM Request Message Log page.

The screenshot displays the 'IAM Request Message Log' interface. At the top, the title 'IAM Request Message Log' is shown in blue. Below the title, request details are listed in a table-like format:

Request ID	0000000063	Seq #	1
ID	SRAM0002	Walker,Chris Robert	
Career			
Institution	PSUNV	PeopleSoft University	

Below the details is a 'Messages' section with a dark blue header. The header includes a 'Find' button and navigation controls: 'First', '1 of 1', and 'Last'. The message list contains one entry:

1	Message Set/Number	14740 / 732	Severity	Cancel
Message Text		Results exist for this Activity. Course Root Status set to Inactive.		
Explanation				

Managing Course Rosters

This section discusses how to:

- Manage the roster summary.
- Manage the activity roster.
- View activity roster student details.
- Manage the result roster.
- View overall activity results.
- View activity root roster student details.
- Post student results.
- Calculate the primary result in batch.
- Calculating the primary result by student.

Pages Used to Manage Course Rosters

<i>Page Name</i>	<i>Definition Name</i>	<i>Navigation</i>	<i>Usage</i>
Activity Roster Summary	SSR_ACR_SUMM_PG	Curriculum Management > Activity Management > Activity Roster > Activity Roster	Access the activity roster and the result roster and review enrollment and result counts.
Activity Roster	SSR_ACR_ROSTER	Click the Activity Roster icon on the Activity Roster Summary page.	Review academic information for students associated with the specific activity (administrative).
Activity Roster – Students Detail	SSR_ACR_IAM_TREE	Click the Assign Student Activities icon on the Activity Roster page.	Review an individual student's IAM and review and select activities.
Results Roster	SSR_ACR_RESULT	Click the Results Roster icon on the Activity Roster Summary page.	Manually enter activity results for students associated with a specific activity (administrative).
Activity Root Roster	SSR_ACR_MASTR	Curriculum Management > Activity Management > Activity Roster > Activity Root Roster	Review assigned and calculated results for all students in a course root. Drill down to individual student results.
Activity Root Roster – View Student Detail	SSR_ACR_STDNT_TREE	Click any mark for a specific student on the Activity Root Roster page.	Review an individual student's result record for a particular result type.
IAM Result Posting	SSR_IAM_RSLT_POST	Records and Enrollment > Individual Activity Manager > IAM Result Posting	Set up result run controls to post AM results to a student's enrollment and APT records.
IAM Result Calculation	SSR_IAM_RSLT_CALC	Records and Enrollment > Individual Activity Manager > IAM Result Calculation	Use a batch process to calculate primary results.
IAM Result Calculation by Student	SSR_IAM_CALC_STDNT	Records and Enrollment > Individual Activity Manager > IAM Result Calculation by Student	Limit the calculation to a Student ID and Course Activity ID pairings.

Managing the Roster Summary

Access the Activity Roster Summary page (**Curriculum Management > Activity Management > Activity Roster > Activity Roster**).

This example illustrates the fields and controls on the Activity Roster Summary page. You can find definitions for the fields and controls later on this page.

Activity Roster Summary

2010 Fall | Regular Academic Session | PeopleSoft University | Undergraduate
 2010 Fall Exam Period

Course Information: BIOLOGY 102 | General Biology II | 003702-1
 Course Root Information: Class Assoc 1
 Primary Result Type: AM RESULT Activity Management Primary Result

[Activity Root Roster](#) [calculate](#)

[Collapse All](#)

Select to Print	Expand / Collapse	Content Description	Activity ID	Class Section	Assoc	Class Nbr	Activity Roster	Active Student Count	Result Roster	Active Students Without Result	Select for Calculation	Anonymous ID
<input type="checkbox"/>	<input type="checkbox"/>	Course	ACT00000387					3			<input type="checkbox"/>	<input checked="" type="checkbox"/>
<input type="checkbox"/>	<input type="checkbox"/>	- Lecture	ACT00000388	1	1	1311		3			<input type="checkbox"/>	
<input type="checkbox"/>	<input type="checkbox"/>	- Research Paper	ACT00000389					3			<input type="checkbox"/>	
<input type="checkbox"/>	<input type="checkbox"/>	- Lab	ACT00000390	1A	1	1401		3			<input type="checkbox"/>	
<input type="checkbox"/>	<input type="checkbox"/>	- Lab Assignments - Select 2	ACT00000391					3				
<input type="checkbox"/>	<input type="checkbox"/>	- Lab Assignment 1	ACT00000392					1		1		
<input type="checkbox"/>	<input type="checkbox"/>	- Or Lab Assignment 2	ACT00000393					3				
<input type="checkbox"/>	<input type="checkbox"/>	- Or Lab Assignment 3	ACT00000394					2				
<input type="checkbox"/>	<input type="checkbox"/>	- Or Lab Assignment 4	ACT00000395									
<input type="checkbox"/>	<input type="checkbox"/>	- Discussion	ACT00000396	1C	1	1405		3			<input type="checkbox"/>	
<input type="checkbox"/>	<input type="checkbox"/>	- Topic Paper *	ACT00000411					2		1		
<input type="checkbox"/>	<input type="checkbox"/>	- Discussion Attendance	ACT00000397					3				
<input type="checkbox"/>	<input type="checkbox"/>	- Course Exam	ACT00000398					2			<input type="checkbox"/>	<input checked="" type="checkbox"/>
<input type="checkbox"/>	<input type="checkbox"/>	- Course Exam Section	ACT00000399					3			<input type="checkbox"/>	<input checked="" type="checkbox"/>

[Print Option](#)

LEGEND
 * Individualized Activity



Administrative users have access to both Activity Rosters and Result Rosters for a specific course root. The Activity Roster is similar to a class roster – showing students’ academic information and enrollment status – but is available for each activity of a course root. Use the Result Roster to enter or view student results for each activity of a specific course root.

Accessing the Roster Summary

The roster summary component is available as soon as the class or EOC has activity IDs generated in the Activity Generator. Rosters for classes are accessed by the term while exam-only rosters are accessed by an academic period. Access into the component is controlled by Academic Organization security. You must also have access to the SSR_ACR_ROSTER and SSR_ACR_RESULT pages to gain access to the specific rosters.

The **Activity Roster** and **Activity Result** icons become visible to the user once students are associated with an activity. In addition, an activity must have been identified as *Assessed* on the detail page of the Activity Manager before the **Activity Result** icon can appear.

Field or Control	Description
Header Information	The system displays the following information related to the course root: Term, Session, Institution, Career, and Academic Period.
Course Information	Indicates the Activity ID assigned to the course root as well as the Subject, Catalog Number, Description, and the Course ID/Course Offer Number.
Primary Activity Result Type	This is the result type that was defined as the primary on the Academic Institution 9 page. The count for the Active Students Without Result is based upon the results assigned for this result type.
Activity Root Roster	Select this link to access the Activity Root Roster for this course root.
Calculate	<p>Once activities have been marked, you can run the primary result calculation process on all the students in the course. The Calculate button calls the IAM Result Entity coding and the rules engine for processing.</p> <p>Select the appropriate Select for Calculation flags in the grid, and then click the Calculate button. Results for students are inserted in the IAM record, but can be viewed here via the Result Roster.</p> <p>See Understanding the Delivered Rules in Activity Management.</p>
Select to Print	Select which activity or result rosters to print. (Future)
Expand/Collapse	Select to open or close levels of the activity tree.
Content Description	Description of the activity.
Activity ID	Unique identifier of the activity. Select the Activity ID to see a display-only view of the activity detail.

Field or Control	Description
Active Student Count	<p>The count of students with an active status for the activity. Active statuses include:</p> <p><i>Assigned</i></p> <p><i>Enrolled</i></p> <p><i>Enrolled – confirmation req’d</i></p> <p><i>Enrolled – Confirmed</i></p> <p><i>Resit Allowed</i></p> <p><i>Resit Candidate</i></p> <p><i>Resit Not Allowed</i></p> <p><i>Selected</i></p> <p><i>Selected as Resit</i></p> <p><i>Selected by Default</i></p>
Activity Roster 	Click this icon to access the Activity Roster page.
Result Roster 	Click this icon to access the Result Roster page.
Active Students Without Result	Displays the count of students who lack a result (of the primary result type) for the activity.

Field or Control	Description
Select for Calculation	<p>This check box indicates at which level you want the primary result calculation to occur.</p> <p>The check box appears at the parent activity level. When you select the check box, all child items that are eligible to be used in the calculation are also selected. Eligibility for assessment items is based on the due date or the extended due date, whichever is later. Clear any check box for an item that you do not want to use in the calculation.</p> <p>Consider an example in which all marks are entered for a course except the exam, which has not yet occurred. If you select the Include at Calculation check box for the course activity, all child items are also selected. To exclude the exam, clear the exam activity check box.</p> <p>After making all your selections, click the Calculate button at the top of the page to begin the calculation process.</p> <p>See Understanding the Delivered Rules in Activity Management.</p>
Anonymous ID	Indicates when the activity is selected to be marked using anonymous grading. (Future)
Select All	Select this link to set the Select to Print to <i>Yes</i> for every activity. (Future)
Clear All	Select this link to set the Select to Print to <i>No</i> for every activity. (Future)
Activity Roster	Select to print the activity roster for the selected activities. (Future)
Result Roster	Select to print the result roster for the selected activities. (Future)
Display in Print Format	Select to generate the roster in print format. (Future)
Legend	This section indicates when an activity is: 1) an extra-credit activity, 2) an individualized content activity, or 3) a supplemental resit activity.

Managing the Activity Roster

Access the Activity Roster page (click the **Activity Roster** icon on the Activity Roster Summary page).

This example illustrates the fields and controls on the Activity Roster page. You can find definitions for the fields and controls later on this page.

Activity Roster
 2010 Fall | Regular Academic Session | PeopleSoft University | Undergraduate
 2010 Fall Exam Period

Summary Page Result Roster

Course Information ACT00000387 BIOLOGY 102 | General Biology II | 003702-1

Activity ID	Description	Active Student Count
ACT00000384	Lab Assignment 3	3

Group Box

PE Students Not PE Students All

Active (3) Inactive (0) Unassigned (0) Restricted (0)

[Filter](#)

Select	Lock	ID	Name	Activity Status	Activity Extenuating Circumstance	Assign	Assign Students Activities	Result Scale	Program and Plan	Attachments
<input type="checkbox"/>		SR13038	Nigel Beaque	Selected	ILLNESS-C	<input checked="" type="checkbox"/>		100 PT	- Undeclared Undergraduate	Attachments
<input type="checkbox"/>		SR13037	Grace Dublin	Selected	ABSENT	<input checked="" type="checkbox"/>		100 PT	- Undeclared Undergraduate	Attachments
<input type="checkbox"/>		SR12200	Sharon Katz	Selected		<input checked="" type="checkbox"/>		100 PT	- Undeclared Undergraduate	Attachments

[Select All](#) [Clear All](#)

Group Box

Notify Selected Students

This roster enables administrative users to view students assigned to the course root and their status for the related activity. Users can edit optional activity statuses for individual students and drill down to the students' IAM.

Field or Control	Description
Display All Exam Sections	This check box appears when you access an exam section activity and multiple sections exist for a single exam. Select this check box to group all students enrolled in the exam sections on one roster. Clear the check box to display only students enrolled in the specific exam section activity.

Field or Control	Description
Activity Status	<p>You can filter by activity status. Options are <i>Active</i>, <i>Inactive</i>, <i>Unassigned</i>, and <i>Restricted</i>. The count for each is displayed by the status label.</p> <ul style="list-style-type: none"> • Active statuses include: <ul style="list-style-type: none"> <i>Assigned (A)</i> <i>Enrolled (E)</i> <i>Enrolled – Confirmation Req'd (EX)</i> <i>Enrolled – Confirmed (EC)</i> <i>Resit Allowed (RA)</i> <i>Resit Candidate (RC)</i> <i>Resit Not Allowed (RN)</i> <i>Selected (S)</i> <i>Selected as Resit (SR)</i> <i>Selected by Default (SD)</i> • Inactive statuses Include: <ul style="list-style-type: none"> <i>Dropped (D)</i> <i>Withdrawn (WD)</i> <i>Waitlisted (WL)</i> • <i>Unassigned</i> – student has eligible selections to make. • <i>Restricted</i> – student has met the condition requirement and this activity is not eligible for selection.
Resit Status	<p>This filter option is available for activities that include the Resit Inclusion (set in the Activity Registry or Activity Manager). Users can filter for students with non-resit activities, resit activities or both. The count for each is displayed by the status label.</p>
Attempt	<p>This column appears only when there are students who have resit attempts.</p>
Select	<p>Select to identify students for whom the activity should be selected or deleted (using the Mass Update) or to whom you want to send a notification (using Notify Selected Students).</p>
Student Roster	<p>Listing of students associated with the Activity ID. Includes student ID, Name, Activity Status, the Result Scale for the activity, and the student primary Program and Plan.</p>

Field or Control	Description
Assign	This field is available for selection when the student still has conditional activities to be assigned.
Assign Students Activities 	Click this icon to drill down to the student's IAM, where you can manage activities assignments for a specific student.
Mass Update	This setting allows you to set a status — assign, remove, confirm or unconfirm — to selected students.
notify selected students	Select the button to open a notification window. All selected students with a stored email address are listed in the To field.
display in print format	Select the button to format a print version of the roster. (Future)

Reviewing Activity Roster Student Details

Access the Activity Roster – Students Detail page (click the **Assign Student Activities** icon on the Activity Roster page).

This example illustrates the fields and controls on the Activity Roster – Students Detail page.

Activity Roster - Student Detail

2010 Fall | Regular Academic Session | Peoplesoft University | Undergraduate
2010 Fall Exam Period

Name Nigel BeaqueNigel Beaque ID SR13038

Root Status Completed

Course BIOLOGY 102 | General Biology II | 003702-1

Collapse All Return

Expand / Collapse	Content Description	Activity ID	Activity Status	Activity Extenuating Circumstance	Assign	Session	Section	Assoc	Class Nbr
<input type="checkbox"/>	Course	ACT00000387	Enrolled						
<input type="checkbox"/>	- Lecture	ACT00000388	Enrolled				1	1	1311
<input type="checkbox"/>	- Research Paper	ACT00000389	Assigned	<input type="text" value=""/>					
<input type="checkbox"/>	- Lab	ACT00000390	Enrolled				1	1A	1401
<input type="checkbox"/>	- Lab Assignments - Select 2	ACT00000391	Assigned						
<input type="checkbox"/>	- Lab Assignment 1	ACT00000392							
<input type="checkbox"/>	- Or Lab Assignment 2	ACT00000393	Selected	<input type="text" value=""/>	<input checked="" type="checkbox"/>				
<input type="checkbox"/>	- Or Lab Assignment 3	ACT00000394	Selected	ILLNESS-C <input type="text" value=""/>	<input type="checkbox"/>				
<input type="checkbox"/>	- Or Lab Assignment 4	ACT00000395							
<input type="checkbox"/>	- Discussion	ACT00000396	Enrolled				1	1C	1405
<input type="checkbox"/>	- Topic Paper * ±	ACT00000411	Selected	<input type="text" value=""/>	<input checked="" type="checkbox"/>				
<input type="checkbox"/>	- Discussion Attendance	ACT00000397	Assigned	<input type="text" value=""/>					
<input type="checkbox"/>	- Course Exam	ACT00000398	Assigned	<input type="text" value=""/>					
<input type="checkbox"/>	- Course Exam Section	ACT00000399	Enrolled	<input type="text" value=""/>					

LEGEND

* Individualized Activity & Extra Credit

This limited view of the student IAM allows users to review class information and edit any optional activities. Once an activity has a result, users can no longer edit optional activities.

In the example above, a user could deselect Lab Assignment 1 and select either Lab Assignment 3 or 4, but Lab Assignment 2 already has a result so it is not editable. The user could also assign the **Topic Paper**, which was set up as an Individualized Activity item.

Managing the Result Roster

Access the Result Roster page (click the **Result Roster** icon on the Activity Roster Summary page).

This example illustrates the fields and controls on the Activity Result Roster page. You can find definitions for the fields and controls later on this page.

The screenshot displays the 'Activity Result Roster' interface. At the top, it shows course information for 'ACT00000387 BIOLOGY 102 | General Biology II | 003702-1'. Below this is a table of 'Activity Information' with columns for Activity ID, Description, Active Student Count, Active Students Without Result, Weight, Minimum Passing Mark/Grade, and Mandatory Pass. A 'FILTER BY' section allows users to filter by Program Enroll (PE, Not PE, All), Activity Status (Active, Inactive, Unassigned, Restricted), and Activity Result (Students with Result, Students without Result, All). There are also fields for Result Type, Result Sub-Type, Result Scale, and Result Status. A 'Display Maximum Mark' checkbox is checked. The main table lists student results with columns for Select, Lock, ID, Name, Activity Status, Activity Extenuating Circumstance, Result Nbr, Result Sub-Type, Result Scale, Show Result Scale, Result Status, Include in Calc, Mark, Maximum Mark Allowed, Grade, Outcome, and Result History. Below the table are controls for 'Update Selected Result' and 'Update Multiple Student Result Status'.

This roster enables administrative users to manually enter activity results for students associated with a specific activity. The page is also used to view results entered by faculty or calculated results updated by the Rules Engine. For the icon to appear, at least one student must be assigned to/enrolled in the activity and the activity must be flagged as an *Accessible* item on the Activity Detail page of the Activity Manager.

Field or Control	Description
<p>Activity Information</p>	<p>The following information is provided for the Activity: Activity ID, Description, Active Student Count, Active Students Without Results, Weight, Minimum Passing Mark/Grade, and Mandatory Pass. Due Date appears for assessment items.</p>

Field or Control	Description
Display All Exam Sections	<p>This check box appears when you access an exam section activity and multiple sections exist for a single exam. Select this check box to group all students enrolled in the exam sections on one roster. Clear the check box to display only students enrolled in the specific exam section activity.</p>
Activity Status	<p>You can filter by activity status. Options are <i>Active</i>, <i>Inactive</i>, <i>Unassigned</i>, and <i>Restricted</i>. The count for each is displayed by the status label.</p> <ul style="list-style-type: none"> • Active statuses include: <ul style="list-style-type: none"> <i>Assigned (A)</i> <i>Enrolled (E)</i> <i>Enrolled – Confirmed (EC)</i> <i>Enrolled – Confirmation Req'd (EX)</i> <i>Resit Allowed (RA)</i> <i>Resit Candidate (RC)</i> <i>Resit Not Allowed (RN)</i> <i>Selected (S)</i> <i>Selected as Resit (SR)</i> <i>Selected by Default (SD)</i> • Inactive statuses Include: <ul style="list-style-type: none"> <i>Dropped (D)</i> <i>Withdrawn (WD)</i> <i>Waitlisted (WL)</i> • <i>Unassigned</i> – student has eligible selections to make. • <i>Restricted</i> – student has met the condition requirement and this activity is not eligible for selection.
Resit Status	<p>This filter option is available for activities that include the Resit Inclusion (set in the Activity Registry or Activity Manager). Users can filter for Non-Resit activities, resit activities or both. The count for each is displayed by the status label.</p>
Activity Result	<p>You can filter for students with results, students without results or both. The count for each is displayed by the status label. Students with results are those where a value exists (score, mark, grade, or outcome) from the associated result scale.</p>

Field or Control	Description
Result Type	You can filter using any result type that exists for the given content type as defined on the Result Type setup. The default when entering the page is the primary result type that was defined on the Academic Institution Table.
Result Sub-Type	Users can filter using a subtype. Subtypes include <i>Capped</i> , <i>Insuff Mrk</i> , <i>Late Pen</i> , <i>Mand Fail</i> , and <i>Mid Term</i> . Rows for insufficient mark, late penalty, and mandatory fail are inserted automatically based on Rules Engine calculation.
Result Scale	You can filter using any result scale that exists for the given content type as defined on the Result Type setup page. When assigning grades, the grading basis associated with the student's enrollment must match an existing grading scheme/basis on the corresponding result scale.
Result Status	This filter option looks at the result status of each student. Those statuses include: <i>Undetermined (00)</i> , <i>Manual (05)</i> , <i>Imported (07)</i> , <i>Calculated (10)</i> , <i>Awaiting Approval (20)</i> , <i>Approved (30)</i> , <i>Overriden (40)</i> , and <i>Final (50)</i> . A blank row here returns all result statuses.
Display Maximum Mark	Select this check box to add the Maximum Mark column to the Student Results group box. The default value is set on the Installation Student Admin page.
Display Student ID and Name	Select to display the student's student ID and name alongside the student's anonymous ID. This check box appears only when you set up the Activity Roster to access anonymous IDs. See Configuring Access to Anonymous IDs .
Default Submission Date To Due Date / This Date	This group of fields appear for assessment items. You can pre-populate the Submission Date field for the entire grid by selecting Due Date , where the due date for the activity is populated or This Date , which allows the user to define the Submission Date . When using Due Date , if an Extended Due Date exists for a particular student then the system populates the field with that date.
Accept Late Penalty Without Warning	This field appears for assessment items. Clear this check box to turn off the system warning that the late penalty rule will be applied to any activities submitted after the due date or extended due date, if one exists.
Select	Use this check box to insert a new value against an existing Result Type. Select the check box and then select the Update Selected Result button. The system inserts a new row for the Result Type in which values can be updated.

Field or Control	Description
Anonymous ID	This value appears if you've generated an anonymous ID for the student. See Generating Anonymous IDs .
Extended Due Date	This column only appears if any student has had an extended due date entered on their IAM.
Result Nbr	Indicates the number of the result.
Result Type	This column only appears when no result type is entered in the filter above. If a result type is entered in the filter section above, the system displays only the rows for that result type and does not display them in the grid.
Result Sub-Type	Subtypes include <i>Capped</i> , <i>Insuff Mrk</i> , <i>Late Pen</i> , <i>Mand Fail</i> , and <i>Mid Term</i> . Rows for insufficient mark, late penalty, and mandatory fail are inserted automatically based on component processing that triggers the primary result calculation. See Understanding the Delivered Rules in Activity Management
Result Scale	The result scale, associated with each activity, defines the scores, mark, grade, outcome combination that can be used as a result for the given activity. The Result Scale defaults from the Activity Manager as long as the result scale is represented on the Result Type table. It can be overridden as necessary.
Show Result Scale 	Select the icon to view the result scale mapping for the specific result scale.

Field or Control	Description
Result Status	<p>When you select Create Initial Result Row, the Result Status defaults to <i>00-Undetermined</i>. When the status is changed to a different value the Include in Calc, Earned Mark, Grade, and Outcome fields are displayed as applicable. When the Create Initial Result Row option is cleared, the Result Status defaults to <i>05-Manual</i>. The delivered translate (SSR_IAM_RSLT_STAT) values for result status are:</p> <p><i>00-Undetermined</i></p> <p><i>05-Manual</i></p> <p><i>07-Imported</i></p> <p><i>10-Calculated</i></p> <p><i>20-Awaiting Approval</i></p> <p><i>30-Approved</i></p> <p><i>40-Overridden</i></p> <p><i>50-Final</i></p>
Submission Date	<p>This column appears for assessment item activities. The default value is based on the setting for the Default Submission Date To above, either the due date or a date entered. Regardless of default setting, you can override the value as needed.</p> <p>If the date entered here is later than the due date for the activity or the extended due date of a specific student, and a late penalty rule exists, then the entry of the mark triggers the Rules Engine and the system inserts a row with the subtype <i>Late Pen</i> in addition to the calculated late penalty mark.</p>
Include in Calc	The system automatically calculates this value, but you can clear the check box to exclude the mark from a calculation.
Mark	Enter the student-earned mark for this activity. This mark should be in the range of the minimum and maximum mark defined on the Result Scale.
Maximum Mark	This column appears if the Display Maximum Mark is invoked and selected on the Installation Student Admin page. The maximum value defined on the Result Scale appears.
Grade	When you enter a mark, the system populates a grade based on the result scale mapping. You can override the populated grade as necessary. When you enter a grade instead of a mark (and the mark field exists) the system populates the mark field with the minimum mark of the grade range. Students must possess the grading basis for the grade being assigned on the student enrollment record.

Field or Control	Description
Outcome	Enter the student outcome for this activity. The system populates this value automatically based on the Earned Mark (result scale mapping), but you can override it with any other outcome that is applicable to the mark range for the selected scale. Delivered values available on the result scale include: <i>Audit (A)</i> , <i>Fail (F)</i> , <i>Incomplete (I)</i> , <i>Pass (P)</i> , and <i>Withdrawn (W)</i> . The values entered here (SSR_IAM_OUTCOME) should match the values on SSR_RESULTS_STATUS.
Result History 	Select this icon to transfer to the Activity Result History page where you can review a student's entire result history for the activity. Common Attributes defined for a result are accessible through the Result History icon. The initial result row must be saved for this icon to appear.
Result Extenuating Circumstance	Institutionally defined value where users can associate an action reason with the given result. This value prompts from the Extenuating Circumstance table.
Result Notes	Enter any comments applicable to the given result.
Created By	Displays the User ID of the original result entry.
Created	Displays the Date/Time Stamp of the original result entry.
Updated By	Displays the User ID of the last result entry.
Last Update Date/Time	Displays the Date/Time Stamp of the last result entry.
notify selected students	Click this button to open a notification window. All selected students with a stored email address are listed in the To field.
display in print format	Click this button to format a print version of the roster. (Future)

Update Multiple Student Result Status

Use this group box to update the result status for multiple students. You can update the result status only if the student already has an existing result. If the student you select has no existing result and you try to update the Result Status, a Process Status of "Status not updated" is assigned to the student. However, if the result status is successfully updated, the Result Status is correctly reflected in the table, and the Result Number is incremented by 1. The student's Process Status becomes "Status Updated".

Make sure you click **Save** to save your changes.

Viewing Overall Activity Results

Access the Activity Root Roster page (**Curriculum Management > Activity Management > Activity Roster > Activity Root Roster**).

This example illustrates the fields and controls on the Activity Root Roster page. You can find definitions for the fields and controls later on this page.

The screenshot shows the 'Activity Root Roster' interface. At the top, it displays '2010 Fall | Regular Academic Session | PeopleSoft University | Undergraduate' and '2010 Fall Exam Period'. Course information includes 'BIOLOGY 102 | General Biology II | 003702-1'. Activity root information shows 'Activity Id ACT00000387' and 'Assoc 1'. There are 13 total coursework items. A 'FILTER BY' section includes 'Coursework Item Filtering' with options for 'Result Type' (AM RESULT), 'Number of Coursework Items' (From 1 to 12 of 12), 'Include Non-Assessed Items', 'Show Marked Items Only', 'Content Type' (All, Course, Component, Exam, Exam Section, Assessment), and 'Student Filtering' (Root Status: Completed (3), Action Req'd, Inactive). Below the filters is a table with columns: Select, Name, ID, Root Status, Course Mark, Grade, Outcome, LEC, RP, LAB, LA1, LA2, LA3, LA4, DIS, TP *, DATT, EX, EX-S1. Three students are listed: Nigel Beaque (SR13038, Completed, 83.50 B, Pass), Grace Dublin (SR13037, Completed, 82.00 B, Pass), and Sharon Katz (SR12200, Completed, 0.00 F, Fail). A 'LEGEND' section at the bottom indicates '* Individualized Activity'.

The activity root roster provides a view of all results for all students in a course root. Users can filter result views and drill down on individual students to access their IAM record.

Field or Control	Description
Course Information	Click this link to access an Activity Manager view of the course root.
Return to Activity Roster Summary	This link appears when you access the component from the Activity Roster Summary page. Click the link to return to the Activity Roster Summary page.
Coursework Item Filtering	The fields in this section enable users to filter the results that appear in the grid below.
Result Type	Enter the result type for the view.
Include Non-Assessed Items	Select this check box to only view coursework items created as nonassessed.
Show Marked Items Only	Select this check box to only view coursework items that were previously marked.

Field or Control	Description
Number of Coursework Items	This field allows you to filter the results to a certain number of coursework items.
Content Type	Select any combination of content types to display.
Root Status	Select options to narrow the display by student status. The values include <i>Complete</i> , <i>Action Required</i> , and <i>Inactive</i> .
Mark links	Select a mark to drill down to that result and the underlying student IAM.

Viewing Activity Root Roster Student Details

Access the Activity Root Roster – View Student Detail page (click any mark for a specific student on the Activity Root Roster page).

This example illustrates the fields and controls on the Activity Root Roster – View Student Detail page: Most Recent Result tab.

Activity Root Roster - View Student Detail

2010 Fall | Regular Academic Session | PeopleSoft University | Undergraduate Nigel Beaque - SR13038

2010 Fall Exam Period

Name: Nigel Beaque ID: SR13038

Root Status: Completed Include Non-Assessed Items

Result Type: AM RESULT Activity Management Primary Result Display Any Result Type

Course: BIOLOGY 102 | General Biology II | 003702-1 [Return](#)

Collapse All

Content Tree Activities

Most Recent Result | Add Result Info | Audits | Class & Exam Info

Expand / Collapse	Content Description	Content Code	Activity ID	Activity Status	Weight	Mandatory Pass	Result Nbr	Result Scale	Show Result Scale	Result Status	Include in Calc	Mark	Grade	Outcome	Result History
[-]	Course	CRSE	ACT00000387	Enrolled	1.00		2 of 2	100 PT		10-Calculated	<input checked="" type="checkbox"/>	83.50	B	Pass	
[-]	[-] Lecture	LEC	ACT00000388	Enrolled	1.00		2 of 2	100 PT		10-Calculated	<input checked="" type="checkbox"/>	79.00	C	Pass	
[-]	[-] Research Paper	RP	ACT00000389	Assigned	1.00	<input checked="" type="checkbox"/>	1 of 1	100 PT		05-Manual	<input checked="" type="checkbox"/>	79.00	C	Pass	
[-]	[-] Lab	LAB	ACT00000390	Enrolled	1.00		2 of 2	100 PT		10-Calculated	<input checked="" type="checkbox"/>	87.00	B	Pass	
[-]	[-] Lab Assignment 1	LA1	ACT00000392												
[-]	[-] Or Lab Assignment 2	LA2	ACT00000393	Selected	1.00		1 of 1	100 PT		05-Manual	<input checked="" type="checkbox"/>	82.00	B	Pass	
[-]	[-] Or Lab Assignment 3	LA3	ACT00000394	Selected	1.00		1 of 1	100 PT		05-Manual	<input checked="" type="checkbox"/>	92.00	A	Pass	
[-]	[-] Or Lab Assignment 4	LA4	ACT00000395												
[-]	[-] Discussion	DIS	ACT00000396	Enrolled	1.00		3 of 3	100 PT		10-Calculated	<input checked="" type="checkbox"/>	80.00	B	Pass	
[-]	[-] Topic Paper *	TP *	ACT00000411	Selected	1.00		1 of 1	100 PT		05-Manual	<input checked="" type="checkbox"/>	80.00	B	Pass	
[-]	[-] Discussion Attendance	DATT	ACT00000397	Assigned	1.00	<input checked="" type="checkbox"/>	1 of 1	P/F OUTCOME		05-Manual	<input checked="" type="checkbox"/>			Pass	
[-]	[-] Course Exam	EX	ACT00000398	Assigned	1.00	<input checked="" type="checkbox"/>	2 of 2	100 PT		10-Calculated	<input checked="" type="checkbox"/>	88.00	B	Pass	
[-]	[-] Course Exam Section	EX-S1	ACT00000399	Enrolled	1.00	<input checked="" type="checkbox"/>	1 of 1	100 PT		05-Manual	<input checked="" type="checkbox"/>	88.00	B	Pass	

LEGEND

* Individualized Activity

This example illustrates the fields and controls on the Activity Root Roster – View Student Detail page: Add'l Result Info tab.

Activity Root Roster - View Student Detail

2010 Fall | Regular Academic Session | PeopleSoft University | Undergraduate Nigel Beaque - SR13038

2010 Fall Exam Period

Name: Nigel Beaque **ID:** SR13038

Root Status: Completed Include Non-Assessed Items

Result Type: AM RESULT Activity Management Primary Result Display Any Result Type

Course: BIOLOGY 102 | General Biology II | 003702-1 [Return](#)

Collapse All

Content Tree Activities

Most Recent Result | **Add'l Result Info** | Audits | Class & Exam Info

Expand / Collapse	Content Description	Content Code	Activity ID	Activity Status	Penalty Type	Insufficient Mark Options
<input type="checkbox"/>	Course	CRSE	ACT00000387	Enrolled		Blank Mark - Include
<input type="checkbox"/>	- Lecture	LEC	ACT00000388	Enrolled		Blank Mark - Include
<input type="checkbox"/>	- Research Paper	RP	ACT00000389	Assigned	Daily	Blank Mark - Include
<input type="checkbox"/>	- Lab	LAB	ACT00000390	Enrolled		Blank Mark - Include
<input type="checkbox"/>	- Lab Assignment 1	LA1	ACT00000392			
<input type="checkbox"/>	- Or Lab Assignment 2	LA2	ACT00000393	Selected	Daily	Blank Mark - Include
<input type="checkbox"/>	- Or Lab Assignment 3	LA3	ACT00000394	Selected	Daily	Blank Mark - Include
<input type="checkbox"/>	- Or Lab Assignment 4	LA4	ACT00000395			
<input type="checkbox"/>	- Discussion	DIS	ACT00000396	Enrolled		Blank Mark - Include
<input type="checkbox"/>	- Topic Paper *	TP *	ACT00000411	Selected		Blank Mark - Include
<input type="checkbox"/>	- Discussion Attendance	DATT	ACT00000397	Assigned		Blank Mark - Include
<input type="checkbox"/>	- Course Exam	EX	ACT00000398	Assigned		Blank Mark - Include
<input type="checkbox"/>	- Course Exam Section	EX-S1	ACT00000399	Enrolled		

LEGEND

* Individualized Activity

This example illustrates the fields and controls on the Activity Root Roster – View Student Detail page: Audits tab.

Activity Root Roster - View Student Detail

2010 Fall | Regular Academic Session | PeopleSoft University | Undergraduate Nigel Beaque - SR13038

2010 Fall Exam Period

Name: Nigel Beaque **ID:** SR13038

Root Status: Completed Include Non-Assessed Items

Result Type: AM RESULT Activity Management Primary Result Display Any Result Type

Course: BIOLOGY 102 | General Biology II | 003702-1 [Return](#)

Collapse All

Content Tree Activities

Most Recent Result | Add'l Result Info | **Audits** | Class & Exam Info

Expand / Collapse	Content Description	Content Code	Activity ID	Activity Status	Created By	Created on	Updated By	Last Update Date/Time
<input type="checkbox"/>	Course	CRSE	ACT00000387	Enrolled	PS	10/10/2013 11:53:44AM	PS	10/10/2013 11:53:44AM
<input type="checkbox"/>	- Lecture	LEC	ACT00000388	Enrolled	PS	10/10/2013 11:53:44AM	PS	10/10/2013 11:53:44AM
<input type="checkbox"/>	- Research Paper	RP	ACT00000389	Assigned	SAMPLE	06/14/2013 8:28:02AM	PS	10/10/2013 11:48:33AM
<input type="checkbox"/>	- Lab	LAB	ACT00000390	Enrolled	PS	10/10/2013 11:53:44AM	PS	10/10/2013 11:53:44AM
<input type="checkbox"/>	- Lab Assignment 1	LA1	ACT00000392					
<input type="checkbox"/>	- Or Lab Assignment 2	LA2	ACT00000393	Selected	SAMPLE	06/14/2013 8:28:02AM	PS	10/10/2013 11:48:14AM
<input type="checkbox"/>	- Or Lab Assignment 3	LA3	ACT00000394	Selected	SAMPLE	06/14/2013 8:28:02AM	PS	10/10/2013 11:48:03AM
<input type="checkbox"/>	- Or Lab Assignment 4	LA4	ACT00000395					
<input type="checkbox"/>	- Discussion	DIS	ACT00000396	Enrolled	PS	10/10/2013 11:53:44AM	PS	10/10/2013 11:53:44AM
<input type="checkbox"/>	- Topic Paper *	TP *	ACT00000411	Selected	SAMPLE	06/14/2013 8:28:02AM	PS	10/10/2013 11:47:46AM
<input type="checkbox"/>	- Discussion Attendance	DATT	ACT00000397	Assigned	PS	10/10/2013 11:47:05AM	PS	10/10/2013 11:47:05AM
<input type="checkbox"/>	- Course Exam	EX	ACT00000398	Assigned	PS	10/10/2013 11:53:44AM	PS	10/10/2013 11:53:44AM
<input type="checkbox"/>	- Course Exam Section	EX-S1	ACT00000399	Enrolled	SAMPLE	06/14/2013 8:28:02AM	PS	10/10/2013 11:46:49AM

LEGEND

* Individualized Activity

This example illustrates the fields and controls on the Activity Root Roster – View Student Detail page: Class & Exam Info tab.

Activity Root Roster - View Student Detail

2010 Fall | Regular Academic Session | PeopleSoft University | Undergraduate Nigel Beaque - SR13038

2010 Fall Exam Period

Name: Nigel Beaque ID: SR13038

Root Status: Completed Include Non-Assessed Items

Result Type: AM RESULT Activity Management Primary Result Display Any Result Type

Course: BIOLOGY 102 | General Biology II | 003702-1 [Return](#)

[Collapse All](#)

Content Tree Activities

Most Recent Result | [Add'l Result Info](#) | [Audits](#) | **[Class & Exam Info](#)** | [Help](#)

Expand / Collapse	Content Description	Content Code	Activity ID	Activity Status	Session	Section	Assoc	Class Nbr
[-]	Course	CRSE	ACT00000387	Enrolled				
[-]	[-] Lecture	LEC	ACT00000388	Enrolled	1	1	1	1311
	[-] [-] Research Paper	RP	ACT00000389	Assigned				
[-]	[-] Lab	LAB	ACT00000390	Enrolled	1	1A	1	1401
	[-] [-] Lab Assignment 1	LA1	ACT00000392					
	[-] [-] Or Lab Assignment 2	LA2	ACT00000393	Selected				
	[-] [-] Or Lab Assignment 3	LA3	ACT00000394	Selected				
	[-] [-] Or Lab Assignment 4	LA4	ACT00000395					
[-]	[-] Discussion	DIS	ACT00000396	Enrolled	1	1C	1	1405
	[-] [-] Topic Paper * #	TP * #	ACT00000411	Selected				
	[-] [-] Discussion Attendance	DATT	ACT00000397	Assigned				
[-]	[-] Course Exam	EX	ACT00000398	Assigned				
	[-] [-] Course Exam Section	EX-S1	ACT00000399	Enrolled				

LEGEND

- * Individualized Activity
- # Extra Credit

The tabs of this page provide an overall view of an individual student's result record for a particular result type. It provides grading data used to calculate the student's most recent result, each result's history, the last date/time updated, and the class and exam enrollment information.

Posting Student Results

Access the IAM Result Posting page (**Records and Enrollment > Individual Activity Manager > IAM Result Posting**).

This example illustrates the fields and controls on the IAM Result Posting page. You can find definitions for the fields and controls later on this page.

IAM Result Posting

Run Control ID: PS [Report Manager](#) [Process Monitor](#) [Run](#)

*Institution: PeopleSoft University

Posting Option: Student & Program Enroll

*When Grade Exists in Stdnt Enr:

Population Selection

Population Selection

Selection Tool: [Edit Prompts](#)

Query Name: [Launch Query Manager](#) [Preview Selection Results](#)

Field or Control	Description
Institution	Enter the Institution for which you wish to run the posting process.
Posting Option	Defaults from the Institution setting. This setting controls if the result is posted to student enrollment and/or the student's APT record.
When Grade Exists in Stdnt Enr	Select the option to update the student's enrollment record if a result already exists. The options include: <i>Apply Grade Change</i> (replaces the existing grade), and <i>Keep Current Grade</i> (keeps existing grade and disregards the posting update).

Population Selection

Population selection is a method for selecting the IDs to process for a specific transaction. The Population Selection group box is a standard group box that appears on run control pages when the Population Selection process is available or required for the transaction. Selection tools are available based on the selection tools that your institution selected in the setup of the Population Selection process for the application process and on your user security. Fields in the group box appear based on the selection tool that you select. The fields behave the same way from within the group box on all run control pages and application processes. If your institution uses a specific delivered selection tool (such as PS Query) to identify IDs for a specific transaction, you must use it.

There are two delivered Population Selection queries, `SSR_IAM_RSLT_PST_BY_TERM`, and `SSR_IAM_RSLT_PST_EXAM_ONLY` which prompt users to enter the institution, and term or academic period. You can create additional queries as needed.

See “Using the Population Selection Process” (Campus Community Fundamentals).

Calculating the Primary Result in Batch

Access the IAM Result Calculation page (**Records and Enrollment > Individual Activity Manager > IAM Result Calculation**).

This example illustrates the fields and controls on the IAM Result Calculation page. You can find definitions for the fields and controls later on this page.

Use the IAM Result Calculation page to initiate a primary result calculation for a group of students within a specific term, or a specific subject area within a term. All students enrolled in Exam-Only Courses (EOC) can also be calculated based on a specific academic period.

Field or Control	Description
Institution	Select the institution for which the calculation should be run.
Calculate only when there is new result to process	<p>Select this option if you only want to calculate when there is a new result to process.</p> <ul style="list-style-type: none"> Example 1: If 45 out of 50 students in a class have completed their results, you can calculate just those 45 students. When the remaining 5 students results have been completed, running the calculation again only calculates for the remaining 5 students. Example 2: All 50 students has been calculated. Changing the marks of 2 students and running the calculation again only calculates the 2 students with updated marks.
Prevent calculation if result is unqualified	<p>Select this option to prevent calculation if a result is unqualified.</p> <p>Example: A course has 3 assessment items, and the student has only been marked for the first 2 assessments. The third assessment is considered an activity with an unqualified result for either having a blank mark or mark with undetermined status.</p>

Include Content Types

Select the content types for which to run the calculation process.

Warning! You must be familiar with the content types used for the courses in which the run the process. If you deselect content types that have results but should be used in the calculation, you may get unexpected results.

Population Selection

Population selection is a method for selecting the IDs to process for a specific transaction. The Population Selection group box is a standard group box that appears on run control pages when the Population Selection process is available or required for the transaction. Selection tools are available based on the selection tools that your institution selected in the setup of the Population Selection process for the application process and on your user security. Fields in the group box appear based on the selection tool that you select. The fields behave the same way from within the group box on all run control pages and application processes. If your institution uses a specific delivered selection tool (such as PS Query) to identify IDs for a specific transaction, you must use it.

The following queries are available; you can create additional queries as needed.

- SSR_IAM_CALC_RSLT_BY_PERIOD
- SSR_IAM_CALC_RSLT_BY_SUBJECT
- SSR_IAM_CALC_RSLT_BY_TERM

See “Using the Population Selection Process” (Campus Community Fundamentals).

Calculating the Primary Result by Student

Access the IAM Result Calculation by Student page (**Records and Enrollment > Individual Activity Manager > IAM Result Calculation by Student**).

This example illustrates the fields and controls on the IAM Result Calculation by Student page. You can find definitions for the fields and controls later on this page.

The screenshot displays the 'IAM Result Calculation by Student' interface. At the top, there is a 'Run Control ID' field containing 'test' and a 'Run' button. Below this, there are several checkboxes: 'Calculate only when there is new result to process' and 'Prevent calculation if result is unqualified', both of which are checked. A section titled 'Include Content Types' contains a list of content types with checkboxes: Course, Component, Category, Exam, Exam Section, Attendance, Assessment, and Condition, all of which are checked. Below this, there is a 'Population Selection' section with a 'Population Selection' checkbox that is unchecked. Underneath, there is a 'Manual Selection' section with a 'Manual Selection' checkbox that is checked and a 'Clear Selection' button. At the bottom, there is a table with the following columns: *Student ID, Name, *Course Activity ID, Term, Term Description, Period ID, Subject, Catalog Number, and Course Description. The table has one row with a search icon in the *Student ID column. The table also includes a 'Filter By' section and a 'Personalize | Find | View All | First | 1 of 1 | Last' navigation bar.

The fields and controls for this page are the same as the IAM Result Calculation page, but with the addition of the Manual Selection option. Use this option to limit the calculation to a Student ID and Course Activity ID pairings.

<i>Field or Control</i>	<i>Description</i>
Manual Selection	Select to manually identify one or more Student ID and Course Activity ID pairings for which you want to calculate IAM Results.

Population Selection

Population selection is a method for selecting the IDs to process for a specific transaction. The Population Selection group box is a standard group box that appears on run control pages when the Population Selection process is available or required for the transaction. Selection tools are available based on the selection tools that your institution selected in the setup of the Population Selection process for the application process and on your user security. Fields in the group box appear based on the selection tool that you select. The fields behave the same way from within the group box on all run control pages and application processes. If your institution uses a specific delivered selection tool (such as PS Query) to identify IDs for a specific transaction, you must use it.

The following queries are available; you can create additional queries as needed.

- SSR_IAMCALC_NO_RSLTS – Students without any result in the course
- SSR_IAMCALC_WITH_RESITS – Students with resits

See “Using the Population Selection Process” (Campus Community Fundamentals).

Chapter 31

Performing Batch Term Activation

Understanding Term Activation

This section lists prerequisites and discusses term activation.

Prerequisites

Before you can activate students into a term, you must activate students into academic programs and plans for that term.

Related Links

[Understanding Program Actions and Statuses](#)

[Maintaining Student Program Stacks](#)

Term Activation

Each term, activating students is a prerequisite process for enrolling students, posting transfer credit, and calculating tuition. To successfully activate a student into a term for a specific academic program, the term activation request must meet the following three criteria:

- The maximum program effective date for the activation term must be later than or equal to the effective date of the student's academic program record.
- The term must be later than or equal to the student's admit term into the academic program.
- The term must have an academic calendar defined in the system.

You can activate the students after they have a valid academic program and plan. Term activation is the process by which you inform the system that admitted and matriculated students are eligible for enrollment, transfer credit posting to their records, and tuition calculation.

Before each enrollment period, you activate students into terms by one of the following three methods:

- Use the batch Term Activation process (SRTRMAC.SQR) to activate groups of students into terms with Process Scheduler, something that you would typically do only once per term.
- Perform a quick term activation, activating students individually into academic programs and terms, using the Student Program/Plan component and the Term Activation page.

You should use this method on an exception basis.

See [Processing a Quick Activation](#)

- Use the Quick Admit component to create a program stack row and term activate an individual student into a term.

See [Processing Enrollment Transactions Through the Quick Enrollment Component](#).

Related Links

[Using the Term Activation Component](#)

Running Batch Term Activation

This section provides an overview of batch term activation and discusses how to:

- Define global exclusions.
- Define degree status rules.
- Enter required and high-level criteria for processing.
- Enter detailed criteria for processing.
- Enter enrollment lapse rules for processing.
- Enter process control options.
- Create custom populations for processing.

Understanding Batch Term Activation

You can activate individual students and also groups of students. You can use the Term Activation process (SRTRMAC.SQR) to target and activate specific groups of students.

Through the Term Activation setup and process components, you specify selection criteria that enable you to include and exclude students for term activation. For example, you can create rules that prevent or require activation for students with specific program actions, academic standing actions, service indicators, and degree checkout status. You can also prevent or allow activation based, for example, on student groups or academic programs. If you still need more options, you can define custom populations of students. Regardless of the options that you select, the process looks at the student's program stack to ensure that the student is active in an academic program, then it creates a row for the student in the student term table (STDNT_CAR_TERM).

After you have begun the Term Activation process (SRTRMAC.SQR) you can monitor the process, especially to see if any errors occurred. The process logs all messages to log files, which it writes to a directory on the computer (generally an application server) where the process is run. The process determines the exact location to write the log files by the FILEPREFIX variable, which is set in the SETENV.SQC. If this variable is not set, the process writes the log files to the same directory that houses the SRTRMAC.SQR program.

After you activate students into terms, you can modify certain aspects of a student's term record, including enrollment limits and terms in residence. You do so through the Term Activation component.

Global Exclusion and Degree Status Rules

The Term Activation setup component enables you to specify predefined rules, called *global exclusion rules*, that you can subsequently attach to an instance of the Term Activation process (SRTRMAC.SQR). Global exclusion rules control which students can be activated in a term through the application process. Global exclusion rules comprise global exclusions and degree status rules. You can define multiple global exclusion rules for an academic institution, assigning each rule within an academic institution a unique identification code. Because you define your rules for an academic institution, you also have the added flexibility to create rules specific to each academic institution of a multi-institution college.

For example, your academic institution might have different term activation policies for summer terms as opposed to regular terms. In such a case, your academic institution could set up one global exclusion rule for the summer term and another for the regular term.

When you later run the Term Activation process, you can choose to include the rule in the run parameters. The Term Activation process connects the global exclusions and degree status rules of a global exclusion rule with an implied *or* between each part. Thus, as illustrated on the Global Exclusions and Degree Status Rules pages shown in this section, a global exclusion rule might read as such:

```
(UGRD/PRB2 or UGRD/PRB3) or (RADM/PET or RADM/AMN) or (RG1 or SF1/NOPAY) or ((Degree
e Checkout Status = APPLIED) and (Activation Term < Expected Graduation Term))
```

Important! Global restrictions override any corresponding selections on the Term Activation process run control pages. If you attach a global exclusion rule to a run of the Term Activation process, the rule overrides any conflicting run control parameters.

Technical Aspects of the Term Activation SQR Process

Before the Term Activation process (SRTRMAC.SQR) begins, the program loads all of the selection criteria on the run control pages into memory, including the details of any global exclusion rule that you attached. If the program finds multiple rows of data from scrollable frames, it loads these values into arrays. The program enforces limits on the amount of selection criteria that you can enter on the run control pages during data entry. For example, if you insert too many rows in the **Program Action Selection** group box on the Selection 2 page, the program ignores any rows beyond the allowable limit and generates a message to the process log indicating that you have exceeded the allowable limit. Most of the selection criteria in the program allow up to 100 rows (arrays). You can run the Term Activation process in either the *Insert* run mode or *Update* run mode, which you specify on the Selection 1 page. The run mode determines the execution path of the program.

When you set the run mode to insert, the main program routine (or initial SELECT statement) selects against the ACAD_PROG table to identify the target population for the process run. For all of the fields on the first page except **Student Group**, **Global Exception Rules**, and **Student Type**, the process determines whether a student is eligible for term activation based on the values it finds for the student on the ACAD_PROG table. The process evaluates each field and constructs a dynamic WHERE clause so that only students that meet the basic criteria can even be considered for term activation.

When you set the run mode to update, the main program routine (or initial SELECT statement) selects against the STDNT_CAR_TERM table instead of the ACAD_PROG table to identify the target population of the process run. Because we are only interested in students who have an existing term row in the STDNT_CAR_TERM table, this enables the process to be much more efficient in accomplishing its task.

In both the Insert and Update run modes, the initial SELECT statement accommodates only some of the possible selection criteria that you provide. After the primary SELECT statement identifies the students eligible for term activation, the process performs various filters on these student records to determine whether each student in this target population meets all of the specified selection criteria and global exclusions.

First, the Term Activation process (SRTRMAC.SQR) writes into memory all academic programs for which a student is *active* for the activation term. For each of a student's active programs, the Term Activation process then takes three passes at the page selection criteria, comparing this selection criteria to the values on ACAD_PROG and STDNT_CAR_TERM records for each student on a program-by-program basis to see if the student is eligible for term activation. If the student does not meet just one of the selection criteria at any point in the compare process, then the process marks the student as ineligible to enroll for that academic program, writes a message to the process log, and moves to the student's next program. For example, if the student is ineligible due to an academic standing restriction, then the process writes a message about this to the process log and moves on to the student's next program. After the process finds one reason for the student being ineligible for term activation for the given program, it does not check for remaining inclusion and exclusion criteria. This methodology dramatically enhances the performance of the process. After the process runs all of the edits against all of a student's active programs, it checks to see if any of these programs are still eligible for term activation. The Term Activation process can only activate a student for one program—her or his primary academic program. When a student has multiple eligible programs, the process selects the primary academic program by taking the program with the lowest STDNT_CAR_NBR and the highest EFFSEQ.

When you set the **Selection Criteria** field on the Selection 1 page to *Custom*, the Term Activation process executes its task through an entirely different path. In this case, the process combines the selection criteria in the component with the list of students found in the PS_TRMAC_CUST_PPLT table. We deliver this table with the application. You can populate this table by devising an SQR script or through the Custom Population page found in the Term Activation component. However you populate the table, the Term Activation process activates students for all rows in this table, provided that the student passes the referential integrity check and meets the additional page selection criteria that you selected. A key feature of the *Custom* option is that you can activate students for multiple terms in the same run, whereas the *Panel* option (the alternative option) restricts you to one term per process run.

Pages Used to Run Batch Term Activation

Page Name	Definition Name	Navigation	Usage
Global Exclusions	TRMAC_SETUP1	Records and Enrollment > Term Processing > Term Activation > Term Activation Batch Setup > Global Exclusions	Define the academic standing and program action exclusions for an academic institution's global exclusion rule.
Degree Status Rules	TRMAC_SETUP2	Records and Enrollment > Term Processing > Term Activation > Term Activation Batch Setup > Degree Status Rules	Define the service indicator and degree status exclusions for an academic institution's global exclusion rule.

Page Name	Definition Name	Navigation	Usage
Term Activation - Selection 1	RUNCNTL_TRMAC_1	Records and Enrollment > Term Processing > Term Activation > Term Activation Batch Process > Selection 1	Enter values for the required fields of the Term Activation process (SRTRMAC), and enter additional high-level selection criteria to narrow the population of students who qualify for term activation.
Term Activation - Selection 2	RUNCNTL_TRMAC_2	Records and Enrollment > Term Processing > Term Activation > Term Activation Batch Process > Selection 2	Enter further the students that the Term Activation process should consider as eligible for term activation for the process run.
Term Activation - Selection 3	RUNCNTL_TRMAC_3	Records and Enrollment > Term Processing > Term Activation > Term Activation Batch Process > Selection 3	Enter required enrollment terms or enrollment lapse rules for a single run of the Term Activation process.
Term Activation - Process Control	RUNCNTL_TRMAC_4	Records and Enrollment > Term Processing > Term Activation > Term Activation Batch Process > Process Control	Enter how the Term Activation process initializes or sets various values in your Campus Solutions system.
Custom Population	RUNCNTL_TRMAC_5	Records and Enrollment > Term Processing > Term Activation > Term Activation Batch Process > Custom Population	Create a custom list of students to activate into terms. Or, retrieve, view, and edit an existing custom list of students.

Defining Global Exclusions

Access the Global Exclusions page (**Records and Enrollment > Term Processing > Term Activation > Term Activation Batch Setup > Global Exclusions**).

This example illustrates the fields and controls on the Global Exclusions page. You can find definitions for the fields and controls later on this page.

Global Exclusions
Degree Status Rules

Academic Institution: PSUNV PeopleSoft University

Global Exclusion Rule: UGEXCL1 ***Descr:**

Academic Standing Exclusions Find | View All | First ◀ 1-2 of 2 ▶ Last

*Career	*Academic Standing Action	+ -
<input type="text" value="UGRD"/> Undergraduate	<input type="text" value="PRB2"/> Probation 2 Subj Dism	+ -
<input type="text" value="UGRD"/> Undergraduate	<input type="text" value="PRB3"/> Probation 3 Subj Dism	+ -

Program Action Exclusions Find | View All | First ◀ 1 of 1 ▶ Last

*Program Action	Action Reason	+ -
<input type="text" value="RADM"/> Readmit	<input type="text"/>	+ -

Service Indicator Exclusions Find | View All | First ◀ 1 of 1 ▶ Last

Service Indicator Cd	Service Ind Reason Code	+ -
<input type="text"/>	<input type="text"/>	+ -

<i>Field or Control</i>	<i>Description</i>
Academic Institution	The academic institution for which the global exclusion rule applies.
Global Exclusion Rule	A rule that you can define to prevent the Term Activation process from term-activating students that have certain parameters on their student career term records (STNDT_CAR_TERM table).

Academic Standing Exclusions

<i>Field or Control</i>	<i>Description</i>
Career	Select the academic career for which you want to exclude an academic standing action from the Term Activation process (SRTRMAC).

Field or Control	Description
Academic Standing Action	<p>Select the actions (within the academic career) to exclude from the Term Activation process.</p> <p>The Term Activation process connects each academic standing exclusion using an implied <i>Or</i> statement. For example, in the page above, PSUNV can use the rule to prevent undergraduates that are subject to dismissal (academic standing action equals PRB2 <i>or</i> PRB3) from being activated in regular terms.</p>

Program Action Exclusions

Field or Control	Description
Program Action	<p>Select the program action to exclude from the Term Activation process. This field prompts you with program actions only relevant to term activation.</p>
Action Reason	<p>To exclude a program action only when a particular reason is attached to that action, select a reason. The system prompts you with only the program action reasons related to the program action. When you specify reasons, you must list all of the reasons within that program action that you want the Term Activation process to exclude.</p> <p>If you want to exclude a program action regardless of the reason, leave this field blank. The Term Activation process excludes all students that have that program action and meet the other run criteria.</p> <p>The Term Activation process evaluates each academic program-action/action-reason exclusion using an implied <i>Or</i> statement. Therefore, never indicate a program action and reason combination and then, for the same program action, leave this field blank. In such a case, the process excludes all actions regardless of the reason you specified. For example, if you list a program action of <i>RADM</i> with an action reason of <i>PET</i>, then add another row with an action of <i>RADM</i> and the reason left blank, the Term Activation process ignores the first entry and assume that any student with the program action of <i>RADM</i>, independent of the reason, must be prevented from term activation.</p>

Service Indicator Exclusions

<i>Field or Control</i>	<i>Description</i>
Service Indicator Cd (service indicator code)	Select the service indicator code to exclude from the Term Activation process.
Service Indicator Reason Cd (service indicator reason code)	<p>To exclude a service indicator code only when a particular reason is attached to that code, select a reason. The system prompts you with only the service indicator reasons related to the service indicator you select. When you specify a reason, you must list all of the reasons within that service indicator that you want the Term Activation process to exclude.</p> <p>To exclude a service indicator regardless of the reason, leave this field blank. The Term Activation process excludes all students that have that service indicator and meet the other run criteria.</p> <p>The Term Activation process evaluates each service indicator/reason exclusion using an implied <i>Or</i> statement. Therefore, never indicate a service indicator/reason combination and then, for the same service indicator, leave the reason blank. In such a case, the process excludes all reasons regardless of the one specified. For example, if you list a service indicator of <i>ALL</i> with a service indicator reason of <i>BILL</i>, then add another row with a service indicator of <i>ALL</i> and the reason left blank, the Term Activation process ignores the first entry and assumes that any student with the service indicator of <i>ALL</i>, independent of the reason, must be prevented from term activation.</p>

Defining Degree Status Rules

Access the Degree Status Rules page (**Records and Enrollment > Term Processing > Term Activation > Term Activation Batch Setup > Degree Status Rules**).

This example illustrates the fields and controls on the Degree Status Rules page. You can find definitions for the fields and controls later on this page.

The screenshot shows the 'Degree Status Rules' page with the following details:

- Global Exclusions** / **Degree Status Rules** (active tab)
- Academic Institution:** PSUNV (PeopleSoft University)
- Global Exclusion Rule:** UGEXCL1 (UG Exclusion Rule 1)
- Navigation: Find | View All | First | 1 of 1 | Last
- *Degree Checkout Status:** Applied
- *Term Activate:** Compare
- If Activation Term is...:** < Expected Graduation Term

This page enables you to define the students who *can* be term-activated based on their degree checkout status. You also have the option to further define the students who can be term-activated by comparing the activation term to students' expected graduation term. This page works in conjunction with the **Degree Checkout Status** field on the Student Degrees page in the Student Program/Plan component. If your institution maintains the **Degree Checkout Status** field, you can then use this functionality. If your institution does not maintain the **Degree Checkout Status** field, the student will always pass the degree checkout status inclusion when you run the Term Activation process (SRTRMAC).

In the example on the page above, any student who has a degree checkout status of *Applied* qualifies for term activation so long as their activation term is less than their expected graduation term.

Field or Control	Description
Degree Checkout Status	<p>Select the degree checkout status that you want the Term Activation process to either exclude or evaluate for exclusion: <i>Applied, Approved, Awarded, Denied, In Review, and Pending</i>.</p> <p>Values for this field are delivered with your system as translate values. Do not modify these values in any way. Any modifications to these values require a substantial programming effort.</p>
Term Activate	<p>Select from the following choices how you want the Term Activation process to evaluate the degree checkout status of students.</p> <p><i>Never</i>: Indicates that you want the Term Activation process to never term-activate students that have the degree checkout status you specified. The If Activation Term is... field becomes unavailable to edit.</p> <p><i>Compare</i>: Indicates that you want the Term Activation process to determine the students that it excludes from term activation by comparing the student's activation term to the expected graduation term for students who have the degree checkout status that you specified. The If Activation Term is field becomes available to edit.</p> <p>For example, if a student has an expected graduation term of spring 2000, you might want to term-activate the student for the spring 2000 term but not the fall 2000 term. You can use the Compare option and the other Degree Status Exclusion fields to set up a run parameter to meet this need.</p>
If Activation Term is...	<p>If you select the <i>Compare</i> option in the Term Activate field, this field becomes available and required. Select how you want the Term Activation process to compare the student's activation term to the expected graduation term. For example, by setting the Degree Checkout Status field to <i>Applied</i> and this field to <i>< Expected Graduation Term</i>, you can exclude all students from term activation that <i>do not</i> match these two criteria. Values for this field are delivered with your system as translate values. Do not modify these values in any way. Any modifications to these values require a substantial programming effort.</p>

Related Links

[Verifying and Updating Student Degree Data](#)

Entering Required and High-Level Criteria for Processing

Access the Term Activation - Selection 1 page (**Records and Enrollment > Term Processing > Term Activation > Term Activation Batch Process > Selection 1**).

This example illustrates the fields and controls on the Term Activation - Selection 1 page. You can find definitions for the fields and controls later on this page.

The screenshot shows the 'Selection 1' tab in a web application. At the top, there are navigation tabs: 'Selection 1', 'Selection 2', 'Selection 3', 'Process Control', and 'Custom Population'. Below the tabs, the 'Run Control ID' is set to 'PS'. There are links for 'Report Manager' and 'Process Monitor', and a yellow 'Run' button. A 'Required Fields' section contains the following fields:

- Institution:** PSUNV (PeopleSoft University)
- Acad Career:** UGRD (Undergraduate)
- Actvtn Term:** 0570 (2006 Fall)
- *Commit Freq:** 1000
- *Run Mode:** Insert
- *Selection Criteria:** Panel
- *Student Type:** Both

Below the 'Required Fields' section, there are more fields:

- Acad Group:** LBART (College of Liberal Arts)
- Acad Prog:** LAU (Liberal Arts Undergraduate)
- Acad Plan:** (empty)
- Student Group:** (empty)
- Global Exclusion Rule:** UGEXCL1

On the right side, there is a 'Program Action Date Range' section with 'Start Date' and 'End Date' fields, both with calendar icons.

The Term Activation process (SRTRMAC.SQR) provides extensive selection functionality for activating specific student populations into terms by academic career. On the Term Activation setup component you predefine rules of exclusion and inclusion, whereas on the Term Activation process component you define characteristics for the population of students that you want to include in batch term activation. You can also attach a global exclusion rule to a given process instance. All of the selection criteria in this component are additive and meant for you to broaden or narrow the scope of your target population for batch term activation. If you want to perform a basic run of the Term Activation process without specifying inclusions and exclusions, you can select values for all of the fields found in the **Required Fields** group box on the first page. After you enter values for these fields, you can run the process at any time, ignoring the other fields in the component.

Note: You can only run the Term Activation process for one academic career at a time. If you want to activate students in terms across academic careers, you must run the process for each academic career.

Required Fields

This group box contains all the fields necessary to run the Term Activation process (SRTRMAC). The remaining fields on this page and the other pages in the component are optional. Use them to further restrict who is eligible for term activation on a specific run.

Field or Control	Description
Institution	Select an academic institution. The Term Activation process considers only students active in that academic institution as eligible for term activation.
Run Mode	<p>Select from the following choices the mode in which you want the Term Activation process to run. To ensure optimal performance, the process only allows you run in one mode at a time.</p> <p><i>Insert:</i> The Term Activation process considers for term activation only the students not yet activated in the activation term. If eligible, the process adds a new row of term data to the student's career term record (STDNT_CAR_TERM table).</p> <p><i>Update:</i> The Term Activation process considers for record modification only the students who already have been activated in the activation term. If eligible, the process updates the student's existing career term data (found in the STDNT_CAR_TERM table). Use other fields in this component to further control how the update function operates.</p>
Acad Career (academic career)	Select an academic career. The Term Activation process only considers students who are active in that academic career as eligible for term activation. The Term Activation process enables you to activate students in only one academic career per process run. To activate students for multiple academic careers, you must run the process for each academic career.

Field or Control	Description
Selection Criteria	<p>Select from the following choices the type of selection criteria that you want the Term Activation process to use for the run.</p> <p><i>Panel:</i> Use the fields available in the component to specify the criteria that determines the students who are eligible for term activation. (Default)</p> <p><i>Custom:</i> Activate a custom population of students, or large batches of students, for one term or across multiple terms. For example, use this option when you need criteria beyond what the component provides, or when you want to perform a student records conversion.</p> <p>By selecting this option, you direct the Term Activation process to look at the delivered PS_TRMAC_CUST_PPLT table to determine who should be term-activated. If desired, you can create your own SQR to populate this table.</p> <p>The Term Activation process, when run with the <i>Custom</i> option, selects custom populations from the PS_TRMAC_CUST_PPLT table based on run control ID and user ID. If you select the <i>Custom</i> option, you can edit or enter, on the Custom Population page (which is found in this component), the students and the terms for which you want to activate them. Otherwise, the Custom Population page is unavailable to edit.</p>
Actvtn Term (activation term)	<p>Select the term for which you are running the process, known as the activation term. Students that meet all run criteria are activated for this term. If you select a value of <i>Panel</i> in the Selection Criteria field, then this field is required. If you select a value of <i>Custom</i> in the Selection Criteria field, the Term Activation process uses the term for the student on the PS_TRMAC_CUST_PPLT table or on the Custom Population page in this component.</p>

Field or Control	Description
Student Type	<p>Select from the following choices the type of student to activate. Values for this field are delivered with your system as translate values. Do not modify these values in any way. Any modifications to these values require a substantial programming effort.</p> <p><i>New:</i> Activate only students newly admitted to your academic institution.</p> <p><i>Continuing:</i> Activate only continuing students.</p> <p><i>Both:</i> Activate both new and continuing students simultaneously in a single run. (Default)</p> <hr/> <p>Note: The Term Activation process defines new and continuing students by comparing the activation term against the admit term. Students that have the same activation term and admit term are new. Students with an admit term prior to the activation term are continuing.</p>
Commit Freq (commit frequency)	<p>Select how many table rows of information (students) you want to process before committing changes to the database. The default is 1,000. Consult your institution's database administrator for the appropriate setting for your institution. If you set the commit value to higher than the number of rows the program processes, then the program commits data only once at the end of the run. The commit logic for this field is platform independent.</p>

Optional Fields

The use of the **Acad Prog** (academic program), **Acad Plan** (academic plan), **Acad Group** (academic group), and the **Program Action Date Range** group box fields can improve the performance of the Term Activation process. However, excessive use of global exclusions and other selection criteria, such as academic standing actions, service indicator codes, and required enrollment terms might slow the process.

Field or Control	Description
Acad Group (academic group)	Select an academic group to narrow the population of students to term-activate.
Acad Prog (academic program)	Select an academic program to narrow the population of students to term-activate.

Field or Control	Description
Acad Plan (academic plan)	<p>Select an academic plan to narrow the population of the students to term-activate. You can specify an academic plan independently of an academic program. For example, if you specify both an academic program and plan, then only students active in both the academic program <i>and</i> plan are eligible for term activation. However, if you specify an academic plan alone, then only students active in that academic plan regardless of their academic program are eligible for term activation.</p>
Start Date and End Date	<p>The beginning and end of the program action date range.</p> <p>Use these fields to narrow the population of students to term-activate to a specific range of program action dates. For example, you can use this date range to limit term activation to only the students that have been activated or matriculated into an academic program since the last run of the Term Activation process. The Term Activation process compares this date range to the Action Date field on the Student Program page. The action date is the transaction date on which the student gets activated into an academic program, <i>not</i> the effective date.</p> <p>If the action date is greater than or equal to the start date and less than or equal to the end date, the student qualifies for term activation.</p> <p>To use these fields you must enter values for both. By default, the end date equals the start date.</p>
Student Group	<p>Select a student group to narrow the population of students to term-activate. The process only activates students within that student group who also meet the other selection criteria of the component.</p>
Global Exclusion Rule	<p>If you want to use a global exclusion rule on this run to further narrow the population of students to term-activate, use this field's prompt to select a rule. If you do not want to use global exclusions, leave this field blank. You can specify a different global exclusion rule for each run of the process.</p>

Related Links

[Defining Global Exclusions](#)

[Creating Custom Populations for Processing](#)

[Creating Custom Populations for Processing](#)

Entering Detailed Criteria for Processing

Access the Term Activation - Selection 2 page (**Records and Enrollment > Term Processing > Term Activation > Term Activation Batch Process > Selection 2**).

This example illustrates the fields and controls on the Term Activation - Selection 2 page. You can find definitions for the fields and controls later on this page.

The screenshot shows the 'Selection 2' tab in a web application. At the top, there are tabs for 'Selection 1', 'Selection 2' (active), 'Selection 3', 'Process Control', and 'Custom Population'. Below the tabs, the 'Run Control ID' is 'PS'. There are links for 'Report Manager' and 'Process Monitor', and a yellow 'Run' button. The main area contains three selection panels:

- Program Action Selection:** Includes a search field with 'ACTV' and 'Activate', and an 'Action Reason' field.
- Academic Standing Selection:** Includes a search field with 'GOOD' and 'Good Stand', and an 'Academic Standing Action' field.
- Service Indicator Selection:** Includes a search field and a 'Service Ind Reason Code' field.

This page enables you to narrow your target population for term activation by selecting the program action, action reason, academic standing action, and service indicator data that you want to include.

Note: The Term Activation process (SRTRMAC) connects academic standing, program action, and service indicator selections with an implied *and* between each selection type. The process connects the criteria with an implied *or* within each selection type.

Program Action Selection

Field or Control	Description
Program Action	Select the program action that you want to include for the Term Activation process. In Insert run mode, the system prompts you only with the actions that are eligible for term activation. In Update run mode, the system prompts you with all available actions. You can enter a program action that conflicts with a global exclusion. However, the global exclusion always takes precedence over the selection criteria.

Field or Control	Description
Action Reason	<p>If you want to include a program action only when a particular reason is attached to that action, select a reason in this field.</p> <p>The system prompts you with only the program action reasons related to the program action you specify. When you specify a reason, list all of the reasons within that program action that you want the Term Activation process to include.</p> <p>If you leave this field blank, the Term Activation process includes all students that have that program action and meet the other run criteria, regardless of the program action reason.</p> <p>The Term Activation process evaluates each program action and reason combination using an implied <i>Or</i> statement. Therefore, never indicate a program action and reason combination and then for the same program action leave the action reason blank. In such a case, the process include all actions regardless of the reason you specified. For example, if you list a program action of <i>MATR</i> with an action reason of <i>FDEP</i>, then add another row with an action of <i>MATR</i> and the reason left blank, the Term Activation process ignores the first entry and assumes that any student with the program action of <i>MATR</i>, independent of the reason, is eligible for term activation.</p>

Important! The values you enter in this group box must exist on the student's most current effective-dated academic program row in order for the student to be selected.

Academic Standing Selection

Field or Control	Description
Academic Standing Action	<p>Select the academic standing action that you want the Term Activation process to include.</p> <p>The Term Activation process connects each academic standing using an implied <i>Or</i> statement. For example, PSUNV might want to make eligible for term activation only students with <i>GOOD</i> or <i>GREA</i> (great) academic standing that also meet the other run criteria.</p>

Service Indicator Selection

Field or Control	Description
Service Indicator Cd (service indicator code)	Select the service indicator code that you want to include in the Term Activation process.
Service Indicator Reason Cd (service indicator reason code)	<p>If you want to include a service indicator code only when a particular reason is attached to that code, select a reason. The system prompts you with only the service indicator reasons related to the service indicator you specify. When you specify a reason, you must list all of the reasons within that service indicator that you want the Term Activation process to include.</p> <p>If you select a service indicator code and leave this field blank, the Term Activation process includes all students that have that service indicator code and meet the other run criteria, regardless of the service indicator reason.</p> <p>The Term Activation process evaluates each service indicator/reason combination using an implied <i>Or</i> statement. You should therefore never indicate a service indicator/reason combination and then, for the same service indicator, leave the action reason blank. In such a case, the process includes all reasons. For example, if you list a service indicator of <i>ALL</i> with a service indicator reason of <i>BILL</i>, then add another row with a service indicator of <i>ALL</i> and the reason left blank, the Term Activation process ignores the first entry and assumes that any student with the service indicator of <i>ALL</i>, independent of the reason, must be eligible for term activation.</p>

Entering Enrollment Lapse Rules for Processing

Access the Term Activation - Selection 3 page ((**Records and Enrollment** > **Term Processing** > **Term Activation** > **Term Activation Batch Process** > **Selection 3**).

This example illustrates the fields and controls on the Term Activation - Selection 3 page. You can find definitions for the fields and controls later on this page.

Required Enrollment Terms				Customize	Find	View All	First	1-4 of 4	Last
Connector	*Line	*Enrollment Term							
	20	0530	2004 Fall						
AND	30	0522	2004 Summer						
OR	40	0530	2004 Fall						
AND	50	0518	2004 Spring						

If you use this page, a student *must* be enrolled in a term or terms according to the rules you specify to be eligible for term activation in the term specified on the Selection 1 page of this component. You can use the Selection 3 page, for example, to prevent the term activation of students who lack enrollment records for the previous term.

Campus Solutions defines a class enrollment as the existence of a row in the STDNT_ENRL table. The procedure that calculates what is and is not a class enrollment is a program file named SRENRLCK.SQC. The SQC is separate from the Term Activation process (SRTRMAC) so that your institution can modify the code that determines what is a class enrollment based on your institution's business needs without concern about future changes to the Term Activation process that might affect the modification. The SQC contains only one procedure, named SELECT-ENROLLMENT. The procedure description describes how the user should proceed with making modifications.

Important! Although we provide this feature with significant flexibility, it is always best to keep the rules simple. Enforcing these rules requires complex rule evaluation and possible increased database activity for each student. Too many rules might result in performance issues.

Connector Type

Use the **Connector Type** group box to specify how the Term Activation process should group individual enrollment requirement lines for evaluation to determine if students qualify for term activation. By choosing a connector type (AND, OR) and either saving the page or clicking the **Set Parentheses** button, the system displays parentheses so that you can visualize how the Term Activation process interprets the rules.

Field or Control	Description
AND and OR	<p>Connector types indicating the main (default) Boolean operator to be used in the equation that contains the detail lines.</p> <p>Select the main connector type (AND, OR) for this term activation criteria. Detail lines joined by the opposite of the main connector type are grouped into one partition. Detail lines joined by the main connector are considered as individual components (or partitions) of the equation. A partition is each detail line in the equation or each set of detail lines grouped by parentheses. For example, if the connector type is AND, and the detail lines are A OR B AND C OR D AND E, then the detail appears on the page as (A OR B) AND (C OR D) AND E. The first partition is (A OR B), the second partition is (C OR D), and the third partition is E. The main connector (that is, the connector that joins the partitions) is AND. The connector joining components within a partition is always the opposite of the main connector type. In another example, if the main connector is OR and the detail lines are A OR B AND C OR D, then the detail appears on the page as A OR (B AND C) OR D. The first partition is A, the second partition is (B AND C), and the third partition is D.</p>
Set Parentheses	<p>Click to parse the individual lines based upon the connector type and the visible parentheses on the page. The parentheses serve as a visual cue to describe how the process evaluates the criteria. You can also save the page to have the system automatically recalculate the parentheses. You might need to reset the parentheses when you add additional lines, change the line order, or change the connector type.</p> <p>Parentheses cannot be explicitly set to group detail rows.</p> <p>If the main connector type is AND, then the system automatically creates partitions where AND is the main connector. For example, if A OR B AND C OR D is entered, then the implied statement is (A OR B) AND (C OR D).</p> <p>If the main connector type is OR, then the system creates partitions where OR is the main connector. For example, if A OR B AND C OR D is entered, then the implied statement is A OR (B AND C) OR D.</p>

Required Enrollment Terms

Use this grid to specify rules about the terms that students must be enrolled in to qualify for term activation.

Field or Control	Description
Connector	Select a connector to indicate how this detail line is connected with the prior detail line. Values are <i>AND</i> or <i>OR</i> .
Line	This field displays a sequential line number, which the system automatically generates in increments of 10. It determines the order in which the process evaluates the line arguments. Use the Line column to manually reorder the criteria. After manually changing the line numbers, save the page or click the Set Parentheses button to visibly reorder the lines and recalculate the parentheses.
Enrollment Term	Select the term in which students must be enrolled to qualify for term activation. The Term Activation process determines class enrollment by locating a row for students in the STDNT_ENRL table for the specified term. In the example depicted in the page above, the rule specified requires that the student have at least one class enrollment in the STDNT_ENRL table for one of the two concurrent terms. Specifically, a student could satisfy this rule and thereby be included in the term activation selection by being enrolled in (fall 2004 AND summer 2004) OR by being enrolled in (fall 2004 AND spring 2004). This structure supports any combination of requirements.

Entering Process Control Options

Access the Term Activation - Process Control page (**Records and Enrollment > Term Processing > Term Activation > Term Activation Batch Process > Process Control**).

The upper frame of this page enables you to control how the Term Activation process (SRTRMAC) populates certain values on the student's career term record. The lower frame of the page enables you to specify the type and detail of information for the Term Activation process to write to the log files on any given run of the process. This page is available in both the Insert and Update run modes.

Term Value Control

Use the fields in this group box to define how the Term Activation process interacts with various fields in the STDNT_CAR_TERM table. In Insert run mode, you can define how the process initializes various fields in the table. In Update run mode, you can define how the process updates various fields in the table.

Field or Control	Description
Tuition Calc Required (tuition calculation required)	<p>Student Financials uses this field to determine if tuition must be calculated or recalculated for students. The option that you select determines the value of the TUIT_CAL_REQ field on the STDNT_CAR_TERM table, setting the value to either <i>Y</i> or <i>N</i> on the student's career term record. When your institution calculates tuition, the tuition calculation process references this field to determine if a student's tuition needs to be recalculated. Select from the following choices.</p> <p><i>Busn Unit:</i> Tells the Term Activation process to use the corresponding field on the Business Unit SF Table to determine the value of the corresponding flag on the student's career term record. When you are in Insert run mode, the system automatically populates this field with the business unit and it is unavailable to edit.</p> <p><i>No Change:</i> When you are in Update run mode this is the default value. If you run the Term Activation process with this value set, the process leaves the corresponding field on the STDNT_CAR_TERM table unchanged.</p> <p><i>No:</i> Select this option to have the Term Activation process set the TUIT_CAL_REQ field on the STDNT_CAR_TERM table to <i>N</i> on each affected student's career term record. When your institution calculates tuition, the tuition calculation process does not recalculate this student's tuition.</p> <p><i>Yes:</i> This option is available in Update run mode only. Select this option to have the Term Activation process set the TUIT_CAL_REQ field on the STDNT_CAR_TERM table to <i>Y</i> for all students whose career term records it has updated. When your institution calculates tuition, the tuition calculation process will recalculate tuition for these students.</p>

Field or Control	Description
Form of Study	<p>Select how you want to set the form of study for the student's career term record. Values for this field are <i>Default</i>, <i>No Change</i>, and all of the other delivered translate values for form of study. The <i>Default</i> and <i>No Change</i> translate values have coding attached to them and should not be modified. You can, however, add other values to the translate table.</p> <p>In Insert run mode, if the activated student has an activation row for a previous term within the same academic career and you select either the <i>Default</i> or <i>No Change</i> options, the system carries forward the value from the previous term. If, however, you select <i>Default</i> and the student has never been term-activated for the same academic career, the value of this field gets set by default to <i>Enrollment</i> (ENRL).</p> <p>In Update run mode, if you select either the <i>Default</i> or <i>No Change</i> options, the Term Activation process leaves the Form of Study field unchanged. If you set the field value to anything else while in the Update run mode, the Term Activation process changes the STDNT_CAR_TERM value to the value that you select from the list of translate values.</p> <hr/> <p>Note: If you select any value besides <i>Default</i>, <i>No Change</i>, or <i>Enrollment</i> the Academic Load field becomes available and required.</p> <hr/>

Field or Control	Description
<p>FA Stats Calc Required (financial aid statistics calculation required)</p>	<p>Select from the following choices how you want the Term Activation process to set the FA_STATS_CALC_REQ flag on the STDNT_CAR_TERM table. The Financial Aid Term Build process uses the value of the FA_STATS_CALC_REQ flag to determine if a STDNT_CAR_TERM record should be built or rebuilt for the student term. If the FA_STATS_CALC_REQ flag is set to <i>Y</i>, then the Financial Aid Term Build process builds or rebuilds the Financial Aid Term record for the student term. If the FA_STATS_CALC_REQ flag is set to <i>N</i>, then the Financial Aid Term Build process assumes no significant changes have been made and skips the student.</p> <p><i>Yes:</i> Sets the FA_STATS_CALC_REQ flag to <i>Y</i> on each student's STDNT_CAR_TERM record.</p> <p><i>No:</i> Sets the FA_STATS_CALC_REQ flag to <i>N</i> on each student's STDNT_CAR_TERM record.</p> <p><i>Default:</i> Sets the FA_STATS_CALC_REQ flag to <i>Y</i> on each student's STDNT_CAR_TERM record.</p> <p><i>No Change:</i> Leaves the value of the FA_STATS_CALC_REQ flag unchanged.</p>
<p>Academic Load</p>	<p>In the Update run mode, this value becomes available and required when the Form of Study field value is set to a value other than <i>Enrollment</i>, <i>No Change</i>, or <i>Default</i>. Select the academic load for the student's updated career term record.</p>

Field or Control	Description
Eligible to Enroll	<p>Select from the following choices whether students activated in a term through this process are then eligible to enroll in that term. This field is available in both Insert and Update run modes.</p> <p><i>Yes:</i> Select this value to set the Eligible to Enroll flag on the STDNT_CAR_TERM record to <i>Y</i>, making students activated in a term through this process eligible to enroll in that term.</p> <p><i>No:</i> Select this value to set the Eligible to Enroll flag on the STDNT_CAR_TERM record to <i>N</i>, thus making students activated in a term through this process ineligible to enroll in that term.</p> <p><i>Default:</i> Select this value to have the process look at the value of the student's Eligible to Enroll flag on her or his STDNT_CAR_TERM record for a prior term within the same academic career. In Insert run mode, if the student does not have a term activation row for a prior term within the same academic career, the process sets the flag on the student's career term record for the current term to <i>Yes</i>, making the student eligible to enroll. If the student does have a term activation row for a prior term within the same academic career, the process carries forward the value of the Eligible to Enroll flag to the current term activation row.</p> <p><i>No Change:</i> In Update run mode, select this option to have the Term Activation process leave the value of the Eligible to Enroll flag on the STDNT_CAR_TERM record unchanged.</p>

Field or Control	Description
<p>Refresh Term Cntrl Dates (refresh term control dates)</p>	<p>Controls how the Term Activation process carries down certain term control dates from the academic calendar (ACAD_CALTRM_TBL) to the individual student career term record. The process refreshes the dates in the following fields on the student career term record: Fully Enrolled Date, Show Enrollment on Transcript Date, Show Statistics on Transcript Date, and Fully Graded Date. Values are <i>Yes</i> and <i>No</i>.</p> <p>In Insert run mode, the system populates this field with <i>Yes</i> because the Term Activation process always carries down the term control dates from the academic calendar. In this mode the field is unavailable to edit.</p> <p>In Update run mode, the system populates this field with <i>No</i> to indicate that the process should leave the term control dates unchanged. However, you can change this value to <i>Yes</i>, which is especially useful if students have already been activated in a term and you need to change any of the control dates for that term.</p>

Process Log Control

Use the fields in this group box to select how you want the Term Activation process to log statistics by selecting the type and level of detail information that you need. The selected system defaults are *Activated Students, Excluded Students, and Run Criteria*. The system assigns a unique process number to the log file srrtmac.dat that you generate so that you can retain and track online versions of the log files. The log includes processing totals on students activated, students updated, and students ineligible. You can view the log by accessing the Report/Log Viewer page and clicking the **Trace File** link. Access the Report/Log Viewer page either by clicking the **Report Manager** link on the run control page then the appropriate **View** link on the Report List page, or by clicking the **Process Monitor** link on the run control page, the appropriate **Details** link on the Process Requests page, then the **View Log/Trace** link. If you only want a count of the students included or excluded from term activation, clear all check boxes.

Field or Control	Description
<p>Activated Students</p>	<p>Select to log students who are included in term activation. The log file provides employee ID, activation term, action taken by the process, academic institution, academic career, and primary academic program.</p>
<p>Excluded Students</p>	<p>Select to log students who are excluded from term activation. The log file provides employee ID, activation term, action taken by the process, academic institution, academic career, and primary academic program.</p>

Field or Control	Description
Activated Students Detail	Select to log students who are included in term activation in greater detail. The log file provides employee ID, academic career, career number, activation term, academic group, academic program, academic plan, program action, program action reason, admit term, effective date, term activation action, and term activation exclusion reason.
Excluded Students Detail	Select to log students who are excluded from term activation in greater detail. The log file provides employee ID, academic career, career number, activation term, academic group, academic program, academic plan, program action, program action reason, admit term, effective date, term activation action, and term activation exclusion reason.
Run Criteria	Select to log all page selection criteria and run control options, including the global exclusion rule, for the process instance.

Creating Custom Populations for Processing

Access the Custom Population page (**Records and Enrollment > Term Processing > Term Activation > Term Activation Batch Process > Custom Population**).

The system transfers this data to and from the PS_TRMAC_CUST_PPLT table by OPRID (operator ID) and run control ID. Rather than manually entering students into the table, you can populate the table using a specialized SQR script that your institution develops to accomplish the task.

When you run the Term Activation process (SRTRMAC) for a custom population, the process knows which students to run from the PS_TRMAC_CUST_PPLT table by looking at the OPRID and run control ID. It processes all valid rows of data it finds in the PS_TRMAC_CUST_PPLT table, provided that you have set the **Selection Criteria** field on the Selection 1 page to *Custom*. Otherwise, the system makes this page unavailable and the process disregards the data in the table.

A key feature of the *Custom* option is that you can activate students for multiple terms in the same run, whereas the *Panel* option (which is the alternative option) restricts you to one term per process run. In addition, the *Custom* option enables you to use other selection criteria fields in the component (except the **Term** field on the Selection 1 page) to narrow your population selection. Please note, however, that the process supports only one academic institution and one academic career at a time. You specify the academic institution and academic career on the Selection 1 page, which is the first page in this component. If you load the table with an SQR script (thus bypassing the page edits) and subsequently try to run the process for more than one academic institution and academic career at a time, the process halts and writes an error message to the process log.

Note: The Term Activation process functions independently of the rows visible for viewing in the page grid. You do not need to retrieve and load the data into the page before running the process.

Warning! Loading a large amount of data into the page can adversely affect performance.

Field or Control	Description
Term	Select the term for which you want to retrieve rows of data from the PS_TRMAC_CUST_PPLT table. If you want to search on all terms for an academic institution and academic career (as specified on the Selection 1 page), then leave this field blank.
ID (employee ID)	Select an student identification number to retrieve, from the PS_TRMAC_CUST_PPLT table, rows of data on a specific person. The system prompts against the PS_TRMAC_CUST_PPLT table and displays all applicable student IDs in that table according to user ID, run control ID, term for which you are searching, and academic institution and academic career (as specified on the Selection 1 page).
Refresh	Click to retrieve rows of data from the PS_TRMAC_CUST_PPLT table that match the criteria you entered in the Term and ID fields. This feature is optional, letting you view and edit your custom population before running the Term Activation process.
ID (employee ID)	<p>The grid displays data rows retrieved from the PS_TRMAC_CUST_PPLT table according to your search criteria in the Term and ID fields above the grid. The system displays the employee identification number of the person to which the row of data pertains.</p> <p>To add to the list of retrieved data or to make a new custom list, select a student ID. The system prompts against a view of the ACAD_PROG table (STDNT_PROG_VW), which lists all student IDs with a program row (active or inactive).</p>
Name	The system displays the name of the person to which this row of data pertains, as retrieved from the PS_TRMAC_CUST_PPLT table. If you are inserting an additional row or creating a custom list, the system displays the person's name when you exit the ID field.
Term	Select the term for which you want to activate the student. If you have searched for and retrieved the data row from the PS_TRMAC_CUST_PPLT table, the system displays the term for which you searched. You can change the term.

Performing Quick Activation

Processing a Quick Activation

Frequently, you might have to activate a student quickly, bypassing the Activate Applications matriculation process (ABPCPPRC) in Recruiting and Admissions and moving the student rapidly into Student Records, assuming that the student's name and address are in the system.

To process a quick activation:

1. Activate the student into an academic program and plan through the Student Program/Plan component by updating the program action code on the Student Program page to *ACTV* (active).

The student must have an active academic program and plan for you to activate the student into a term. Select **Records and Enrollment > Career and Program Information > Student Program/Plan**.

2. Activate the student into a term through the Term Activation page.

Select **Records and Enrollment > Student Term Information > Term Activate a Student**.

When you save the information on this page, you have completed the quick activation process. The student is now ready to enroll in classes for the term.

Related Links

[Maintaining Student Program Stacks](#)

[Running Batch Term Activation](#)

[Using the Term Activation Component](#)

“Updating Applications” (Recruiting and Admissions)

“Managing Names Data” (Campus Community Fundamentals)

“Managing Addresses and Phone Data” (Campus Community Fundamentals)

Creating Student Blocks

Understanding Student Blocks

Important! Mass Change is a deprecated product. It is strongly recommended that you use Application Engine instead. For more information on Application Engine, see *PeopleTools: Application Engine*.

A student block is a grouping of student information into blocks based on a number of common academic characteristics. Student blocks can be essential during enrollment because they enable you to mass enroll groups of students into blocks of courses.

You can create student blocks on the Create Student Block Page (STDNT_BLOCK) by manually entering student IDs into a student block, but this becomes inefficient when dealing with large groups of students. For example, you may want to enroll hundreds of first year computer science students into a common, core curriculum based on their academic level and academic plan.

To meet this need for mass enrolling large student blocks, your system includes a mass change type and mass change template called Create Student Block. With these mass change tools, you can create and run mass change definitions that will generate SQL for large student blocks based on your criteria and defaults.

After you create your student block through a mass change definition, you can use the Mass Enrollment process to create a course enrollment block, associate the student block with the course block, and then post the enrollment transactions.

Mass Change

Mass change is a SQL generator that you can use to develop and perform custom applications. Using mass change, a developer can set up a series of INSERT, UPDATE, or DELETE SQL statements that the end user can run to perform business functions.

When you use mass change, you are essentially running SQL statements to manipulate the data in the application. The overall structure of mass change is similar to that of Query, except that Query retrieves data from the database, while mass change actually updates the database.

Updating Mass Change Operator Security

Important! Mass Change is a deprecated product. It is strongly recommended that you use Application Engine instead. For more information on Application Engine, see *PeopleTools: Application Engine*.

In order for end users to be able to select the Create Student Block template when creating a mass change definition, the template must be added to the user security for the user or class profile to which the end users belong.

This section discusses how to update operator security.

Page Used to Update User Security

<i>Page Name</i>	<i>Definition Name</i>	<i>Navigation</i>	<i>Usage</i>
Security	MC_OPER_SECURITY	PeopleTools > Security > Mass Change Operator Security > Security	Grant access to the Create Student Block mass change template to permission lists so that users can run the Create Student Block mass change process.

Updating Operator Security

Access the Security page (**PeopleTools > Security > Mass Change Operator Security > Security**).

This example illustrates the fields and controls on the Security page. You can find definitions for the fields and controls later on this page.

Security

Permission List: HCCPCSSA1000

Description: CS Administration - All Pages OK To Execute Online

Mass Change

[Customize](#) | [Find](#) | First ◀ 1-84 of 84 ▶ Last

Mass Change Template ID		
Application Prog Update Select	🔍	+ -
CR-Intv-Delete	🔍	+ -
CR-Intv-Delete-Org	🔍	+ -
CR-Intv-Insert 3CEngine	🔍	+ -
CR-Intv-Insert 3CEngine-Org	🔍	+ -
CR-Mbrshp-Delete	🔍	+ -
CR-Mbrshp-Delete-Org	🔍	+ -
CR-Mbrshp-Insert 3CEngine	🔍	+ -
CR-Mbrshp-Insert 3CEngine-Org	🔍	+ -
CampDir_Alumni	🔍	+ -
CampDir_Staff	🔍	+ -
CampDir_Student	🔍	+ -
Checklist - Admin Function	🔍	+ -
Checklist - Delete Temp	🔍	+ -
Communication - Admin Function	🔍	+ -
Communication - Delete Temp	🔍	+ -
Create Student Block	🔍	+ -

<i>Field or Control</i>	<i>Description</i>
Mass Change Template ID	Select the <i>Create Student Block</i> template ID.

Creating a Student Block Mass Change Definition

Important! Mass Change is a deprecated product. It is strongly recommended that you use Application Engine instead. For more information on Application Engine, see *PeopleTools: Application Engine*.

This section provides an overview of mass change definitions and discusses how to:

- Create mass change definitions.
- Specify Student Administration parameters.
- Specify student block criteria and defaults.
- Generate mass change SQL text for student blocks.
- View mass change execution history.

Understanding Mass Change Definitions

Mass change definitions are built using mass change templates and are generally created and run by end users. Mass change definitions are used to specify the values and operators for each field in the WHERE clause of the SQL statement, to specify the values for default fields, and to generate the actual SQL statements. When you create a definition, all information defaults from the associated mass change type and template, except for the criteria and default field values and operators.

If any changes occur to the mass change template, the system requires that you create a new mass change definition because existing mass change definitions will not recognize the changes.

Pages Used to Create a Student Block Mass Change Definition

<i>Page Name</i>	<i>Definition Name</i>	<i>Navigation</i>	<i>Usage</i>
Description	MC_DEFN_00	Records and Enrollment > Enroll Students > Block Enrollment > Mass Change Definition > Description	Select the template with which you will create the mass change definition.
Student Administration	MC_DEFN_SA	Records and Enrollment > Enroll Students > Block Enrollment > Mass Change Definition > Student Administration	Set parameters such as aid year, academic career, and institution for the mass change definition.
Criteria and Defaults	MC_DEFN_01	Records and Enrollment > Enroll Students > Block Enrollment > Mass Change Definition > Criteria and Defaults	Specify the operators and values for the criteria and default fields so that the mass change properly runs the SQL statements.
Generate SQL	MC_DEFN_02	Records and Enrollment > Enroll Students > Block Enrollment > Mass Change Definition > Generate SQL	Generate and view the SQL statements, based on the Create Student Block type, template, and definition, before actually running the mass change. Select the option of running the SQL when you save the page.

Page Name	Definition Name	Navigation	Usage
Execution History	MC_DEFN_03	Records and Enrollment > Enroll Students > Block Enrollment > Mass Change Definition > Execution History	View the history of all of your SQL runs for this definition.

Creating Mass Change Definitions

Access the Description page (**Records and Enrollment > Enroll Students > Block Enrollment > Mass Change Definition > Description**).

Field or Control	Description
Mass Change Definition	Select the <i>Create Student Block</i> template. The system enters the description of the template in the Description field.

Specifying Student Administration Parameters

Access the Student Administration page (**Records and Enrollment > Enroll Students > Block Enrollment > Mass Change Definition > Student Administration**).

Field or Control	Description
Mass Change Default Status	Select the status that the system will assign to the records created when you generate this mass change.
As Of Date and As Of Date/Time	Enter the date and time for the default status.
Aid Year, Academic Career, SetID, Institution, and Stdnt Fin Business Unit (student financials business unit)	Enter values as needed for the SQL to filter the data that the process retrieves.

Specifying Student Block Criteria and Defaults

Access the Criteria and Defaults page (**Records and Enrollment > Enroll Students > Block Enrollment > Mass Change Definition > Criteria and Defaults**).

This example illustrates the fields and controls on the Criteria and Defaults page. You can find definitions for the fields and controls later on this page.

Mass Change Definition: Create Student Block

SQL Statement Find | View All First 1 of 1 Last

Execution Seq: 1 **Description:** Create Student Block

Criteria Find | View All First 1-2 of 6 Last

Field	Field Value
Academic Plan Equal To	BA-SO
Academic Program Equal To	BA

Defaults Customize | Find | View All First 1-2 of 4 Last

Field Label	Mass Change Field Value
1 Academic Career	RSCH
2 Academic Institution	PSANZ

The Criteria and Defaults page is the heart of a Mass Change definition and is the key to running effective SQL statements and creating a student block. The Create Student Block mass change runs two SQL statements to create a student block, inserting these statements into the STDNT_BLOCK_HDR record and the STDNT_BLOCK_DTL record so that you can select to use your student block during the Mass Enrollment process.

Important! To properly run the mass change and generate the student block that you want, it is essential that you know the exact values of the criteria and default fields. For example, if you want to create a student block for all students with the academic plan equal to BA-SO, an academic program equal to BA, and a projected academic level equal to 20 (sophomore), then you must enter these values in the respective criteria fields and leave the remaining criteria fields blank.

Criteria

<i>Field or Control</i>	<i>Description</i>
Field and Field Value	<p>Specify the operators and values of each field as necessary to restrict and unrestrict the data set that mass change selects to generate the student block you want.</p> <p>Mass change will add this criteria to the end of the insert SQL statements that it generates.</p> <p>The following criteria fields are delivered with the Create Student Block template:</p> <ul style="list-style-type: none"> • Academic Program • Academic Plan • Term • Academic Level - Projected • Academic Load • Total Grade Points

Defaults

<i>Field or Control</i>	<i>Description</i>
<p>Mass Change Field Value</p>	<p>Specify values for each default field. Mass change uses the default values in the insert statements.</p> <p>For example, you must input a value for the Student Enrollment Block code and description in order for your student block to appear as a choice during mass enrollment.</p> <p>Following are the default fields that the application delivers with the Create Student Block template:</p> <ul style="list-style-type: none"> • Academic Career: Mass change inserts this value in the STDNT_BLOCK_DTL record. • Academic Institution: Mass change inserts this value in the STDNT_BLOCK_DTL record. • Student Enrollment Block Code: This is the unique identifier for the student enrollment block. <p>Mass change inserts this value in the STDNT_BLOCK_DTL record. During mass enrollment, this value appears as a choice from the prompt box for the Student Enrollment Block field on the Mass Enrollment page.</p> <ul style="list-style-type: none"> • Student Enrollment Block Description: Mass change inserts this value in the STDNT_BLOCK_HDR record. <p>During mass enrollment, this value appears as a choice from the prompt box for the Student Enrollment Block field on the Mass Enrollment page.</p> <hr/> <p>Warning! Do not delete Default rows from your definition. This prevents the mass change definition from running properly.</p> <hr/>

Generating Mass Change SQL Text for Student Blocks

Access the Generate SQL page (**Records and Enrollment > Enroll Students > Block Enrollment > Mass Change Definition > Generate SQL**).

This example illustrates the fields and controls on the Generate SQL page. You can find definitions for the fields and controls later on this page.

The screenshot shows the 'Generate SQL' page with the following elements:

- Mass Change Definition:** Create Student Block
- Buttons:** Generate, Clear Sw
- Checkbox:** Execute SQL Upon Saving
- SQL Statement:**

```

INSERT INTO PS_STDNT_BLOCK_HDR (DESCR, INSTITUTION, STDNT_ENRL_BLOCK) SELECT DISTINCT 'Research
Students - AI', 'PSANZ', 'RSCH' FROM PS_MC_DEFN MC_DEFN, PS_MC_DEFN_MC_DEFN_, PS_ACAD_PROG ACAD_PROG,
PS_ACAD_PLAN ACAD_PLAN, PS_STDNT_CAR_TERM STDNT_CAR_TERM WHERE MC_DEFN.MC_DEFN_ID = 'Create
Student Block' AND MC_DEFN.MC_DEFN_ID = MC_DEFN_MC_DEFN_ID AND ACAD_PROG.ACAD_CAREER =
ACAD_PLAN.ACAD_CAREER AND ACAD_PROG.ACAD_CAREER = STDNT_CAR_TERM.ACAD_CAREER AND
ACAD_PROG.EMPLID = ACAD_PLAN.EMPLID AND ACAD_PROG.EMPLID = STDNT_CAR_TERM.EMPLID AND
ACAD_PROG.INSTITUTION = STDNT_CAR_TERM.INSTITUTION AND ACAD_PROG.STDNT_CAR_NBR =
ACAD_PLAN.STDNT_CAR_NBR AND ACAD_PROG.STDNT_CAR_NBR = STDNT_CAR_TERM.STDNT_CAR_NBR AND
ACAD_PLAN.ACAD_PLAN = 'BA-SO' AND ACAD_PROG.ACAD_PROG = 'BA'

```
- Count:** Total rows to be 0

The mass change user ID (shown on the Description page) must be the same as the ID of the person running the mass change. Thus, if you created the mass change definition, then only you can run the mass change. Otherwise, you must create a new mass change definition using the appropriate template and save the newly created definition with your ID.

After you run the SQL, the system populates the STDNT_BLOCK_HDR record and the STDNT_BLOCK_DTL record with the student block values that you created. You can then select to use the student block that you create in the Mass Enrollment process. Your student block will appear as a choice in the prompt box for the **Student Enrollment Block** field on the Mass Enrollment page. You can also view your student block on the Mass Enrollment Student Block page.

Field or Control	Description
Clear Sw (mass change clear switch)	Click when you first open the page and want to generate a new SQL. Also click this button if you are unhappy with the SQL that the mass change generates and need to rewrite the definition to better fulfill your needs.
Execute SQL Upon Saving	Select if you are positive that you want to run the SQL. If you select this option and then click the Generate SQL button, mass change runs the SQL as soon as you click the Save button. If you do not select this check box, you can save the mass change definition, then run it in the background using a run control.
Generate SQL	Click to have mass change generate the SQL statements based on the mass change type, template, and definition.

Field or Control	Description
SQL Statement	Displays the SQL statement text for you to review. Verify that any FROM and WHERE clauses reference the proper tables, fields, and values.
Count	Click to display the total number of rows affected by each statement. If the totals are what you expect, select the Execute SQL Upon Saving check box and save the definition. If the count is not what you expected, redefine the definition.

After you run the SQL statements for your Create Student Block mass change definition, you should look at the STDNT_BLOCK_HDR and STDNT_BLOCK_DTL tables to make sure that the inserts have successfully created the records. You can also view this from the Mass Enrollment Student Block page. If you have successfully run the SQL statements, you can use the Mass Enrollment process to create a course enrollment block, attach the course enrollment block to this student block, and post the enrollment transactions.

Viewing Mass Change Execution History

Access the Execution History page (**Records and Enrollment > Enroll Students > Block Enrollment > Mass Change Definition > Execution History**).

The fields on this page are the same as the fields on the Criteria and Defaults page.

Maintaining Student Career Term Records

Prerequisites for Maintaining Student Career Term Records

Before you can use all of the elements in the Term Activation component, you must:

- Activate the student in an academic program.
- Set up default enrollment limits on the Term Enrollment Limits page of the Academic Program Table component.
- Define term control date default values on the academic calendar.

Using the Term Activation Component

This section discusses how to:

- Maintain a student's career term record.
- Maintain a student's term enrollment limits.
- Maintain a student's session data.
- Maintain a student's terms in residence.
- Maintain a student's term control dates.
- Track and maintain a student's external study agreements.
- (AUS) Set student term default values.
- (NZL) Maintain single data return (SDR) reporting data for a student.

Pages Used to Maintain Student Career Term Records

<i>Page Name</i>	<i>Definition Name</i>	<i>Navigation</i>	<i>Usage</i>
Term Activation	STDNT_ACTIVATION	Records and Enrollment > Student Term Information > Term Activate a Student > Term Activation	Maintain a student's career term record or activate a student into a term.

Page Name	Definition Name	Navigation	Usage
Loan Election	SSR_LOAN_ELEC_AUS	Records and Enrollment > Student Term Information > Term Activate a Student > Loan Election	<p>Note: This page is for Australian institutions only. To activate the page, select the Australia DEST, HECS, Centrelink, TAC check box on the Academic Institution 6 page.</p> <hr/> <p>Set default values for the student's career number and liability status for course enrollments.</p>
SDR (single data return)	SSR_STD_CRTRM_NZL	Records and Enrollment > Student Term Information > Term Activate a Student > SDR	<p>Note: This page is for New Zealand institutions only. To activate the page, select the New Zealand Catalog, SDR, EFTS, StudyLink check box on the Academic Institution 6 page.</p> <hr/> <p>Enter fee information for the student's program for SDR reporting.</p>
Enrollment Limit	STDNT_ENRL_LIM	Records and Enrollment > Student Term Information > Term Activate a Student > Enrollment Limit	Maintain a student's term enrollment limits.
Student Session	STDNT_SESSION	Records and Enrollment > Student Term Information > Term Activate a Student > Student Session	Maintain a student's session data within the student's career term record.
Terms In Residence	STDNT_CAREER_RES	Records and Enrollment > Student Term Information > Term Activate a Student > Terms In Residence	Maintain a student's terms in residence or adjust a student's transfer credit values.
Term Control Dates	STDNT_TERMCNTRL_DT	Records and Enrollment > Student Term Information > Term Activate a Student > Term Control Dates	Maintain a student's term control dates, including the fully enrolled date, fully graded date, and dates for showing enrollment and statistics on transcripts.

Page Name	Definition Name	Navigation	Usage
External Study	STDNT_EXT_STUDY	Records and Enrollment > Student Term Information > Term Activate a Student > External Study	Track and maintain external study programs, such as study abroad, that apply towards a student's career term record.

Maintaining a Student's Career Term Record

Access the Term Activation page (**Records and Enrollment > Student Term Information > Term Activate a Student > Term Activation**).

This example illustrates the fields and controls on the Term Activation page. You can find definitions for the fields and controls later on this page.

The screenshot shows the 'Term Activation' page for student Ana Beck (SR0400). The page has several tabs: Term Activation, Enrollment Limit, Student Session, Terms In Residence, Term Control Dates, and External Study. The main content area displays the following fields and values:

- Academic Career:** Undergraduate
- *Academic Institution:** PSUNV (PeopleSoft University)
- *Term:** 0505 (2003 Fall Semester)
- Student Career Nbr:** 0 (Liberal Arts Undergraduate)
- Academic Year:** 2004
- Override All Academic Levels:**
- Override Projected Level:**
- Academic Level - Projected:** Freshman
- Academic Level - Term Start:** Freshman
- Academic Level - Term End:** Freshman
- Level Determination:** Units
- Activation Date:** 01/20/2003
- Load Determination:** Units
- *Form of Study:** Enrollment
- Academic Load:** No Units
- *Billing Career:** UGRD
- Eligible To Enroll:**

Field or Control	Description
Academic Career	This field displays all of a student's career term records by academic career.
Academic Institution	The system supplies an academic institution from the User Defaults component. You can specify any valid academic institution here, but you can add a record only if the student is active in an academic program at that academic institution as of the start date of the specified term.
Term	The system displays all active terms for a student. If you are performing a quick activation, enter the term in which to activate the student.

Field or Control	Description
Student Career Nbr (student career number)	<p>By default, the system sets the student career number to zero, which is the first academic program in the student's program stack and identifies the student's primary academic program.</p> <p>The system uses the student career number to perform various calculations, including the calculation of the student's academic level and load. You can override the student career number, for instance, for students in dual programs. After you override the student career number in one term, it rolls from term to term.</p>
Override All Academic Levels	<p>Select to modify all academic level fields on this page. This selection carries over to the next term, so when you add a new row to activate the student in the next term, this check box is selected by default. Also, when you override all academic levels, the system sets all academic levels for the next term to the end of term level for the prior term row. You should select this check box sparingly, because doing so prevents the system from automatically determining the student's academic levels.</p> <p>If you clear this check box, the system uses the academic level defaults that are established on the Academic Level Table page.</p>
Override Projected Level	<p>Select to modify the student's projected academic level. When you select this check box the Academic Level - Projected field becomes available to edit. If you clear this check box, the system recalculates the academic level projected if the level rule uses units or term progression.</p>
Academic Level - Projected	<p>The system displays the student's projected academic level at the start of the term, which is the student's actual academic level, provided that the student passes all in-progress units from previous terms. The system uses this field for enrollment restriction checking and tuition calculation, among other things.</p> <p>You can override this field value if you select either the Override Projected Level check box or the Override All Academic Levels check box. You might override a student's projected academic level when you know that your academic institution will be receiving the student's transfer credit, but the credit has not yet been entered into the student's official record. When you override all academic levels, the system sets by default the academic levels for the next term to the value that is in the Academic Level - Term End field for the prior term row.</p> <hr/> <p>Note: When a student is activated for a term, either through the batch Term Activation (SRTRMAC.SQR) process or in the Term Activate a Student (STDNT_ACTIVATION) component, the Override Projected Level check box is cleared and the Academic Level - Projected field becomes unavailable for edit.</p> <hr/>

Field or Control	Description
Level Determination	By default, the system displays the level determination value from the Level/Load Rules Table component, based on the level load rule that is attached to the student's primary academic program for the current career and term row
Load Determination	By default, the system displays the load determination value from the Level/Load Rules Table component, based on the level load rule that is attached to the student's primary academic program for the current career and term row.
Academic Level - Term Start	By default, the system displays the student's academic level at the beginning of the term, based on cumulative completed units from previous terms or transfer units. You can override this field value if you select the Override All Academic Levels check box. When you override all academic levels, the system sets by default the academic levels for the next term to the value that is in the Academic Level - Term End field for the prior term row.
Academic Level - Term End	By default, the system displays the student's academic level at the end of the term, based on cumulative completed units, including work completed in this term and transfer units. You can override this field value if you select the Override All Academic Levels check box. When you override all academic levels, the system sets by default the academic levels for the next term to the value that is in the Academic Level - Term End field for the prior term row.
Academic Year	By default, the system displays the academic year, based upon the term that you enter.
Academic Load	The system displays the student's academic load, which is calculated in units enrolled if the level load rule is set to determine load based on units. Alternatively, the rule could determine load using a default value—assigned on the level load rule itself—or the load could be determined manually.
Form of Study	The system, by default, sets the student's form of study to <i>Enrollment</i> , but you can override this default value. The value of <i>Enrollment</i> tells the system that this form of study is unit-based. You can modify these translate values, with the exception of the <i>Enrollment</i> value.

Field or Control	Description
Eligible To Enroll	<p>The system, by default, selects this check box, which informs the enrollment engine that the student is eligible to enroll in classes for the specified term. Clear this check box to prevent the student from enrolling in classes for the specified term.</p> <p>You might clear this check box when posting transfer credit to a student's career term record in which the student will not be eligible to enroll until a later date. The transfer credit posting process requires that a student is active in the term to which you are posting transfer credit.</p>
Billing Career	<p>The system, by default, sets the student's billing career to the academic career in the student's career term record. The tuition calculation process uses the student's billing career to calculate the student's tuition.</p> <p>If the student is active in more than one academic career in the same term, you might want to consolidate tuition calculation and billing under a single academic career. If so, then point the billing career for all of the student's career term records to the same academic career. For example, a student might be enrolled in a term as both a graduate student and an undergraduate student. If you want to consolidate tuition calculation to just the undergraduate career, you would select undergraduate as the billing career for both the student's undergraduate term record and graduate term record.</p> <p>If you decide to use a single billing career for all of a student's academic careers within a term, note that to perform a term or session withdrawal, the student must be enrolled in at least one class within the academic career that you select as the student's billing career. Otherwise, the term withdrawal and session withdrawal processes halt processing and instruct you to change the student's billing career to an academic career in which the student has enrollments for the term.</p>
Calculate Tuition	<p>Click to go to the Tuition Calc (tuition calculation) page so that you can calculate tuition and fees for this student.</p>

Related Links

[Understanding Transfer Credit Processing](#)

[Processing Withdrawals and Cancellations](#)

“Calculating Tuition for Multiple Students” (Student Financials)

(AUS) Setting Student Term Default Values

Access the Loan Election page (**Records and Enrollment > Student Term Information > Term Activate a Student > Loan Election**).

This example illustrates the fields and controls on the Loan Election page. You can find definitions for the fields and controls later on this page.

Field or Control	Description
Student Career Nbr (student career number)	Select a career number for the student. You can enter multiple rows when the student has multiple programs/career numbers.
Liability Status	Enter a liability status. This value defaults to the enrollment pages.
Eligible to defer HECS	Select if the student is eligible to defer HECS-HELP payments when they have nominated to pay up-front and have not paid their fees in full.
Subject to Fixed HECS	Select if the student qualifies to pay the fixed HECS fee for class enrollment.
Scholarship Type	Select the appropriate scholarship type for this student. When you generate the TCSI Commonwealth Learning Scholarship file, the system includes all students who have a scholarship type of 3, 4, or 5. Type 5 scholarships have two records, one for CECS and one for CAS.
Overseas Fee	Enter any overseas fees for the student.
Research End-User Codes	Select a code for each of the five fields. Each code indicates the type of research end-user engagement undertaken by a Higher Degree by Research student (element 593).

(NZL) Maintaining SDR Reporting Data for a Student

Access the SDR page (**Records and Enrollment > Student Term Information > Term Activate a Student > SDR**).

<i>Field or Control</i>	<i>Description</i>
Student Career Nbr (student career number)	Select a career number for the student.
Foreign Fee	Enter any foreign fee for the student.
MAX Exempt Fee	Enter the sum of all non-maxima fees charged to this student.

Maintaining a Student's Term Enrollment Limits

Access the Enrollment Limit page (**Records and Enrollment > Student Term Information > Term Activate a Student > Enrollment Limit**).

This example illustrates the fields and controls on the Enrollment Limit page. You can find definitions for the fields and controls later on this page.

The screenshot shows the 'Enrollment Limit' page for student Ana Beck (SR0400). The page has several tabs: Term Activation, Enrollment Limit (selected), Student Session, Terms In Residence, Term Control Dates, and External Study. The student's name 'Ana Beck' and ID 'SR0400' are displayed at the top. Below this, there are several sections with fields and controls:

- Academic Career:** Undergraduate
- Academic Institution:** PeopleSoft University
- Term:** 2003 Fall Semester
- Primary Academic Program:** Liberal Arts Undergraduate
- Academic Group of Advisor:** LBART
- Approved Academic Load:** Full-Time (dropdown menu)
- Override Unit Limits:**
- Max Total Units:** 18.00
- Max Audit Units:** 3.00
- Max No GPA Units:** 6.00
- Max Wait List Units:** 12.00
- Min Total Units:** 8
- Max Total Courses:** (empty field)

<i>Field or Control</i>	<i>Description</i>
Approved Academic Load	<p>The system, by default, displays the student's approved academic load for their primary academic program for the term. You can override this value.</p> <p>The student's approved academic program is set on the Student Program page (Records and Enrollment > Career and Program Information > Student Program/Plan > Student Program).</p>

Field or Control	Description
Override Unit Limits	<p>Select to override the student's term enrollment limits for the approved academic load that you selected. The unit limit fields become available for entry. When processing enrollment requests with this override, the enrollment engine uses the term enrollment limits that you define on this page rather than the ones that are defined on the Enrollment page of the Academic Program Table component. When using this override, the enrollment engine <i>does not</i> include the wait list units in the maximum total unit limit. For example, assume that you limit the student to 18 maximum total units, 3 maximum no GPA units, 3 maximum audit units, and 9 maximum wait list units. The student can enroll in a maximum of 18 units for the term. Of these 18 units, the student can take 9 no GPA units (including 3 audit units). In addition to the 18 maximum total units, the student can take an additional 9 wait list units.</p> <p>Clear this check box to have the enrollment engine use the term enrollment limits that are set on the Enrollment page of the Academic Program Table component.</p>
Max Total Units (maximum total units)	Enter the maximum number of units that the student can enroll in for the term.
Max Audit Units (maximum audit units)	Enter the maximum number of units that the student can take with an audit-grading basis for the term.
Max No GPA Units (maximum no GPA units)	Enter the maximum number of units that the student can enroll in with a non-GPA-grading basis for the term.
Max Wait List Units (maximum wait list units)	Enter the maximum number of wait list units that the student can have for enrollment for the term.
Min Total Units (minimum total units)	Enter the minimum number of units that the student must enroll in for the term. The enrollment engine references this value only when a student attempts to drop a class or make a units adjustment for a class.
Max Total Courses (maximum total courses)	The system displays by default the maximum number of courses in which a student can enroll for the term according to the value set on the Course Count Limits page.

Related Links

“Setting Up Term Enrollment Limits for Academic Programs” (Campus Solutions Application Fundamentals)

Maintaining a Student's Session Data

Access the Student Session page (**Records and Enrollment > Student Term Information > Term Activate a Student > Student Session**).

This example illustrates the fields and controls on the Student Session page. You can find definitions for the fields and controls later on this page.

This page displays all of a student's academic careers, terms, and sessions.

Field or Control	Description
Session	Select the type of session in which the student will enroll into classes for the specified academic program and term.
Academic Load	By default, the system displays the student's academic load for the term. You can change the value for an individual session within the term. The system calculates academic load based on the number of units for which the student is enrolled. This field is unavailable for edit if the form of study for the session is <i>Enrollment</i> .
Form of Study	<p>By default, the system displays the same form of study as defined for the term on the Term Activation page of this component. You can change the form of study for sessions that differ from the term value. For example, a student's form of study for the term is <i>Enrollment</i>, but the student is studying abroad for one session of that term. Values are <i>Abroad</i>, <i>Candidacy</i>, <i>Detached</i>, and <i>Enrollment</i>. You can modify these translate values with the exception of the <i>Enrollment</i> value.</p> <p>By default, the system displays the student's approved academic load according to the value that is set on the Term Enrollment Limits page of the Academic Program Table component. You can override this field for an individual session within the term.</p>

Field or Control	Description
Fully Enrolled Date	<p>The date that the system considers the student fully enrolled for financial aid load calculations and billing purposes. The system, by default, sets the student's fully enrolled date to the corresponding date for the session, as defined in the academic calendar. You can override this date.</p> <p>If you override the fully enrolled date because the student's account is due a refund, you must recalculate the student's tuition. You can calculate a student's tuition through the Tuition Calculation page in Student Financials.</p>
Approved Academic Load	Enter the student's approved academic load, such as <i>Full-Time</i> or <i>Part-Time</i> .
Override Billing Units	Select if want to calculate the student's tuition bill with criteria other than the number of units in which the student enrolls. If you set billing units as a part of tuition calculation, the system displays the number of the student's projected billing units.

Related Links

“Calculating Tuition for a Single Student” (Student Financials)

Maintaining a Student's Terms in Residence

Access the Terms In Residence page (**Records and Enrollment > Student Term Information > Term Activate a Student > Terms In Residence**).

Use terms in residence to track to the number of terms in which a student is activated. Course work can be completed and easily tracked in terms. In addition, work that is accomplished outside the classroom—such as fieldwork and dissertation preparation—is also tracked by term even if the student is not enrolled in formal classes. For students affected by level load rules that are not based on terms, one term row equals one term in residence. For students affected by term-based level load rules, a term row can be greater than, equal to, or less than one term depending on the resident terms adjustment factor of the level load rule.

Academic Advisement does not use the term value that is stored here to calculate derived list terms in residence. Instead, the Advisement engine creates one term in residence for every term in which a student was enrolled at the academic institution.

Field or Control	Description
Current in Residence Terms	<p>The system, by default, displays the current number of terms in which the student is in residence within his or her primary academic program and term. If the level load rule that applies to the student has a resident terms adjustment factor, the system uses the student's approved academic load and the resident terms adjustment factor to determine the default value. Otherwise, the system displays <i>1</i> as the default value. You can override the value in this field.</p>

Field or Control	Description
Transfer in Residence Terms	Enter the number of terms that the student has transferred from another organization.
Cumulative in Residence Terms	The system displays the student's total number of current, past, and transfer terms. The value is the cumulative total of residency terms.
TC Units Adjustment (transfer credit units adjustment)	<p>When you save this component, the system assigns the student to an academic level by adding up the student's transfer credit—for careers in which academic level is determined by units—and subtracting the value that is entered here. This enables you to decrease a student's transfer credit for the purposes of assigning the student to a lower academic level. This calculation does not affect the student's term or cumulative statistics, and the recalculated unit total is not displayed or stored in the system. The calculated sum affects only this student's academic level.</p> <p>For example, you might allow a student to transfer in a total of 75 units for degree progress purposes, even though the student must remain a sophomore, which means she cannot have more than 59 units based on your level rule setup. To adjust the student's transfer credit units and assign the student to the appropriate academic level, enter 16 in this field. You can view the student's projected academic level, academic level at term start, and academic level at term end, on the Term Activation page. The system uses the value in the TC Units Adjustment field to calculate all of these levels.</p> <p>Additionally, a field edit prevents you from entering more units in this field than the student has transfer units. So if the student has 10 transfer units, you cannot enter 11 in this field. Therefore, the TC Units Adjustment field subtracts only from transfer units.</p>

Field or Control	Description
<p>Copy TC Units (copy transfer credit units)</p>	<p>Click to complete the transfer credit posting process. When you try to post transfer credit statistics for a student in a particular academic program and for a particular articulation term, the system checks whether the student is active in the term and academic program that you select. If the student is not active in either the academic program or the articulation term, the system sets the status to <i>Complete</i>. This enables you to evaluate transfer credit and store the statistical information for a student prior to the completion of the Activate Applications matriculation process (ABCPPRC) in Recruiting and Admissions.</p> <p>After you activate a student in the appropriate academic program and in the articulation term that you selected, you <i>must</i> click this button to transfer the student's transfer credit to the STDNT_CAR_TERM table in Student Records, thereby completing the transfer credit posting process. If you do not copy transfer credit units after term activation, the student's career term record will not reflect the student's transfer credit units for the term. Remember to save your changes after you click this button. The system does not update the STDNT_CAR_TERM table until the save is performed.</p> <p>If you select a term without a transfer credit model status of <i>Complete</i>, the system displays a message informing you that there is nothing to update.</p>

Related Links

[Viewing Student Statistics](#)

[Understanding Transfer Credit Processing](#)

“Creating a Requirement Line Item” (Academic Advisement)

Maintaining a Student's Term Control Dates

Access the Term Control Dates page ((**Records and Enrollment** > **Student Term Information** > **Term Activate a Student** > **Term Control Dates**).

Field or Control	Description
<p>Fully Enrolled Date</p>	<p>Enter the date on which this student is considered fully enrolled in the specified term. As of this date, the student's coursework appears on the student's transcripts. This date is also used for financial aid load calculations and billing purposes. The system, by default, displays the corresponding value from the Term Calendar 3 page for the specified term based on the student's primary academic program for the term.</p>
<p>Show Enrollment On Transcript</p>	<p>Enter the date on which the system displays the student's work in progress on the transcript.</p>

<i>Field or Control</i>	<i>Description</i>
Show Statistics On Transcript	Enter the date on which the system displays the student's academic statistics on the transcript.
Fully Graded Date	Enter the date on which the system considers this student's enrollment record for the specified term as fully graded. This value comes from the academic calendar by default. When you define transcript types, you can indicate whether the transcript processes should use this date and display grade information.

Related Links

“Defining Traditional Academic Calendars” (Campus Solutions Application Fundamentals)

Tracking and Maintaining a Student's External Study Agreements

Access the External Study page (**Records and Enrollment > Student Term Information > Term Activate a Student > External Study**).

<i>Field or Control</i>	<i>Description</i>
External Org ID (external organization ID)	Select the identification number of the external organization that is sponsoring the student's external study program.
Country	Select the country in which the external organization resides.
Study Agreement	Select the study agreement that describes the student's external study program.
Start Date and End Date	Enter the dates on which the student's external study program begins and ends.

Querying for Academic Level Differentials

Use the delivered public query `STDENT_TERM_ADMIT_LEVEL` to identify individuals with differences between their academic level on the admissions application, as defined on the Application Data page, and their academic level at term start, as seen on the Term Activation page. This query, which you can access through Query Manager, compares an individual's academic level in the Recruiting and Admissions table `ADM_APPL_DATA` to that same individual's academic level in the Student Records table `ACAD_PROG` through a view. If the values are different, the query captures these rows and displays them for you in Query Manager.

If the individual's academic level in the `ACAD_PROG` table is lower than the academic level in the `ADM_APPL_DATA` table and you want to increase the `ACAD_PROG` academic level, you must complete one of the following actions:

- Grant the student additional other credit units for a special course through the transfer credit process, provided that the student's academic program bases level and load determination on units.
- Grant the student additional terms in residence credit through the **Transfer In Residence Terms** field on the Terms In Residence page of the Term Activation component, provided that the student's academic program bases level and load determination on terms.

If the individual's academic level in the ACAD_PROG table is higher than the academic level in the ADM_APPL_DATA table and you want to decrease the ACAD_PROG academic level, you must complete one of the following actions:

- Enter a negative credit amount in the **TC Units Adjustment** field on the Terms in Residence page of the Term Activation component, provided that the student's academic program bases level and load determination on units.
- Enter a negative terms in residence amount in the **Transfer In Residence Terms** field on the Terms In Residence page of the Term Activation component, provided that the student's academic program bases level and load determination on terms.

Managing Enrollment and Validation Appointments

Understanding Enrollment and Validation Appointments

Enrollment appointments enable you to manage and prioritize class enrollment processing for your students. Student Records offers you the flexibility to assign enrollment appointments in mass through a process that you can run multiple times within the same term or to assign enrollment appointments on a student-by-student basis.

Validation appointments function similarly to enrollment appointments. If your institution has licensed Campus Self Service, your students can use the self-service enrollment and academic planning functionality to store the classes in which they plan to enroll in a staging area, before they are allowed to enroll. They can then validate their selection against a subset of Enrollment Engine edits. So in essence, students can plan their schedules before they can enroll by choosing several combinations of classes and checking to see if the enrollments will be successful. When students validate their schedules, the system calls the Enrollment Engine. Therefore, it might be necessary to assign students appointments during which they can validate their schedules to prevent a prohibitively large number of students from accessing the system at the same time. The process for assigning validation appointments is the same as for assigning enrollment appointments.

To create enrollment or validation appointments:

1. If you want to assign validation appointments, you must select the **Allow Validation** check box and at least one edit option on the Enrollment page when you set up Student Records Self Service (Set Up SACR, Common Definitions, Self Service, Student Records, Enrollment).
2. (Optional) Define on the Appointment Limits Table page all of the possible appointment limit IDs and their corresponding part-time and full-time maximum unit limits for each session of a term at your academic institution.

When using appointment limits you must also indicate the Appointment Control Unit Limit on the Academic Career Table.

See “Defining Academic Careers” (Campus Solutions Application Fundamentals)

3. Define student appointment blocks on the Student Appointment Blocks page.
4. Define appointment blocks for enrollment appointments on the Enrollment Appointment page in the Appointment Table component.

An appointment block is a block of appointment numbers.

5. Define appointment blocks for validation appointments on the Validation Appointment page in the Appointment Table component.

6. Assign validation or enrollment appointments to students in batch by merging an appointment block, a student appointment block, and appointment limits on the Assign Appointments page, or assign a single student an enrollment or validation appointment on the Student Enrollment Appointment page.
7. Review and update the enrollment or validation appointments for individuals as necessary through the Student Enrollment Appointment page.

You can run the Assign Students Appointment process as many times as needed within the same term and session, either adding new appointments or deleting existing appointments. Each time you run the process, it produces a hardcopy report for you. When the **Create Communications** check box is selected, the process also populates the communication table, providing you with the option to generate enrollment appointment notification mailers for your students.

Note: Each time you run the process with the check box selected, the system puts a new entry in the communication table. Only use this option when you are sure your appointments are final.

Setting Up Enrollment and Validation Appointments

This section provides an overview of enrollment and validation appointment setup and discusses how to define enrollment appointment limits.

Understanding Enrollment and Validation Appointment Setup

This section discusses:

- The Validation feature.
- The Appointment Limit table.

The Validation Feature

To have access to the Validation feature, your institution must have:

- Licensed Campus Self Service.
- Enabled the Validation feature on the Enrollment page when you set up Student Records Self Service.

See “Defining Student Records Setup” (Campus Self Service).

The Appointment Limit Table

Set up the Appointment Limit table if you want to be able to reuse appointment limits across terms and sessions. You do not need to set up the Appointment Limit table if:

- You want to define appointment limits each time you assign individual appointments.
- You want the Enrollment Engine to only enforce academic program term and session enrollment limits—set up on the Enrollment page in the Academic Program Table component—and you do not want to define limits specifically for the appointment.

When checking enrollment unit limits, the enrollment engine first checks the academic program's term limits. If the student meets the enrollment unit limits for the term, the enrollment engine checks the enrollment limits for the session, as defined on the Enrollment page of the Academic Program Table component, if units limits have been defined for the session. If the student meets the enrollment limit requirements for the session—or if no limits were defined for the session—the enrollment engine checks the enrollment unit limits for the appointment, if the open enrollment date has not been reached. Appointment enrollment unit limits only apply prior to the open enrollment period.

Page Used to Set Up Enrollment and Validation Appointments

Page Name	Definition Name	Navigation	Usage
Appointment Limits Table	SSR_APPT_LIMIT	Records and Enrollment > Term Processing > Appointments > Appointment Limits Table > Appointment Limits Table	Define appointment limit IDs and the full-time and part-time maximum unit limits for each session of a term at your academic institution. You are not required to use appointment limit IDs, but if you do use them, you should define a separate appointment limit ID for each group at your academic institution that has varied enrollment unit restrictions.

Defining Enrollment Appointment Limits

Access the Appointment Limits Table page (**Records and Enrollment > Term Processing > Appointments > Appointment Limits Table > Appointment Limits Table**).

This example illustrates the fields and controls on the Appointment Limits Table page. You can find definitions for the fields and controls later on this page.

Appointment Limits Table

Academic Institution: PSUNV PeopleSoft University

Academic Career: UGRD Undergraduate

[Find](#) | [View All](#) First 8 of 11 Last

Appointment Limit ID	STND	+	-	
*Description	<input type="text" value="STND"/>			
Full Time Max Total Units:	<input type="text" value="18.00"/>	Part Time Max Total Units:	<input type="text" value="9.00"/>	
Full Time Max No GPA Units:	<input type="text" value="12.00"/>	Part Time Max No GPA Units:	<input type="text" value="6.00"/>	
Full Time Max Audit Units:	<input type="text" value="6.00"/>	Part Time Max Audit Units:	<input type="text" value="3.00"/>	
Full Time Max Wait List Units:	<input type="text" value="12.00"/>	Part Time Max Wait List Units:	<input type="text" value="6.00"/>	
Include Wait List in Total:	<input checked="" type="checkbox"/>			

Note: When using enrollment appointment limits, you must also set the Appointment Control Unit Limit on the Academic Career Table, to indicate whether the limits are restricted to a specific session or apply to a student's enrollment across all sessions of a term.
See “Defining Academic Careers” (Campus Solutions Application Fundamentals)

Field or Control	Description
Appointment Limit ID	Enter an appointment limit ID for every group at your academic institution that has varied enrollment unit restrictions. For example, each appointment limit ID that you define might have different full-time and part-time maximum and minimum units.
Full Time Max Total Units and Part Time Max Total Units	Enter the maximum number of units that a full-time and part-time student can enroll in during the specified enrollment appointment.
Full Time Max No GPA Units (full time maximum number grade point average units) and Part Time Max No GPA Units (part time maximum number grade point average units)	Enter the maximum number of units that a full-time and part-time student can enroll in with a non-GPA grading basis during the specified enrollment appointment.
Full Time Max Audit Units and Part Time Max Audit Units	Enter the maximum number of units that a full-time and part-time student can audit during the specified enrollment appointment.
Full Time Max Wait List Units and Part Time Max Wait List Units	Enter the maximum number of wait-list units that a full-time and part-time student can take during the specified enrollment appointment.
Include Wait List in Total	<p>If you select this check box, the enrollment engine includes wait listed units towards the appointment maximum.</p> <p>For example: A student has an appointment maximum unit limit of 18 and a maximum wait list unit limit of 12. The student is enrolled in 6 units and wait listed in 6 units. If the check box is selected, the student can enroll and/or wait list in an additional 6 units only, because the 6 wait listed units are applied to the overall limit of 18.</p>

Example

For example, the registrar at PSUNV wants to create enrollment appointments on a ranking basis: seniors with a higher GPA enroll first, then seniors with a lower GPA. This same pattern works down to the freshman level. Graduate students can enroll any time. In addition, PSUNV limits the number of units in which a freshman can enroll. All other undergraduates require the same unit limit.

At least two appointment limit codes are required to represent the variable maximum units. In our example, it is not necessary to create an appointment code for graduate students because they can enroll at any time *and* because we have set the open enrollment date early enough on the Session Table page for the graduate academic career. Thus, we would create one appointment limit ID for freshman that specifies the appropriate unit limits, and a second appointment limit ID for all other undergraduates that specifies the appropriate unit limits. The mass enrollment appointment process handles the GPA ranking.

Creating Student Appointment Blocks

This section provides an overview of student appointment blocks and discusses how to

- Define student appointment blocks.
- Define processing priorities for student appointment blocks.

Understanding Student Appointment Blocks

When you define a student appointment block you are selecting criteria—such as academic career, academic program, cumulative GPA, and academic level—that will constitute a particular population of your student body for whom you want to assign enrollment or validation appointments. For example, you might want to assign appointments based solely on academic level, so your freshmen, sophomore, junior, and seniors have different appointments, or you might want to assign particular appointments to all senior undergraduate honors students with a cumulative GPA of 3.5 or better. You can define as many appointment blocks as you want on the Student Appointment Block page and reuse them term after term.

You can also create a custom student appointment block by selecting specific student IDs for the block.

You use student appointment blocks when assigning appointments in batch on the Assign Appointments page. On this page, you select an appointment block—created on the Enrollment Appointment or Validation Appointment pages—and then you select a student appointment block. The Assign Students Appointment process assigns the appointment numbers from the appointment block to the students who fit the criteria of the student appointment block. The processing priorities that you define on the Processing Priorities page for the student appointment block determine the order in which the system assigns students appointment numbers.

Pages Used to Create Student Appointment Blocks

<i>Page Name</i>	<i>Definition Name</i>	<i>Navigation</i>	<i>Usage</i>
Student Appointment Block	SSR_APPT_STDT_BLACK	Records and Enrollment > Term Processing > Appointments > Student Appointment Block > Student Appointment Block	Define a student appointment block to be used when assigning appointments to students using the Assign Students Appointment process on the Assign Appointments page.
Add Programs	SSR_APPT_STDT_SEC	Click the Add Programs link on the Student Appointment Block page.	Add additional academic programs to the student appointment block.

Page Name	Definition Name	Navigation	Usage
Processing Priorities	SSR_APPT_STDT_PRIO	Records and Enrollment > Term Processing > Appointments > Student Appointment Block > Processing Priorities	Define ranking priorities for the student appointment block. The Assign Appointment process obeys these rankings when assigning enrollment appointments to students.

Defining Student Appointment Blocks

Access the Student Appointment Block page (**Records and Enrollment > Term Processing > Appointments > Student Appointment Block > Student Appointment Block**).

This example illustrates the fields and controls on the Student Appointment Block page. You can find definitions for the fields and controls later on this page.

Student Appointment Block
Processing Priorities

Academic Institution: PSUNV PeopleSoft University

Academic Career: UGRD Undergraduate

[Find](#) | [View All](#) | [First](#) ◀ 2 of 2 ▶ [Last](#)

***Student Appointment Block:** + -

***Description:**

Use Custom Selection

Academic Program: 🔍 Liberal Arts Undergraduate [Add Programs](#)

Academic Level - Projected:

Academic Level - Term Start: 🔍 Freshman

Academic Level - Term End:

Student Group: 🔍

Cumulative GPA From:

Cumulative GPA To:

Cumulative Units From:

Cumulative Units To:

Include in Progress Units

Term: 🔍 2001 Fall

Get # Students in Block **Students in Block for Term** 18

Field or Control	Description
Student Appointment Block and Description	Enter a name, up to six characters, and a description for this student appointment block.
Use Custom Selection	Select this check box if you want to create this student appointment block by selecting individual student IDs. The ID field appears.
ID	Add individual students, by ID, to this student appointment block. All students within this academic career are available.
Academic Program	Select an academic program to limit this student appointment block to students who are active in this academic program. If you do not select an academic program, the available options in the academic level fields includes all levels for all programs in this career. This enables you to select all freshman in this career, for instance, regardless of their academic programs.
Add Programs	Select to choose particular programs for this student appointment block. The Add Programs page appears. When you add programs, the academic level fields will include all of the levels for every program that you select. <hr/> Note: All academic programs might not contain all the same academic levels. When selecting multiple programs and levels for an appointment block, be sure to validate that the expected population was included in your block. <hr/>
Academic Level - Projected	Select a projected academic level to limit this student appointment block to students with this projected academic level. Only the levels for the academic program that you selected are available. If no academic program is selected, then all levels for all programs within this career are available. If multiple academic programs are selected, all levels for all of the selected programs are available.
Academic Level - Term Start	Select a value to limit this student appointment block to students who are assigned this academic level at the start of the term. Only the levels for the academic program that you selected are available. If no academic program is selected, then all levels for all programs within this career are available. If multiple academic programs are selected, all levels for all of the selected programs are available.
Academic Level - Term End	Select a value to limit this student appointment block to students who are assigned this academic level at the end of the term. Only the levels for the academic program that you selected are available. If no academic program is selected, then all levels for all programs within this career are available. If multiple academic programs are selected, all levels for all of the selected programs are available.

Field or Control	Description
Student Group	Select a student group to limit this student appointment block to students who are assigned to this student group. Assign students to student groups on the Student Group page.
Cumulative GPA From	Enter a value to limit this student appointment block to students who have at least this cumulative GPA on the CUM_GPA table.
Cumulative GPA To	Enter a value to limit this student appointment block to students who have up to this cumulative GPA on the CUM_GPA table.
Cumulative Units From	Enter a value to limit this student appointment block to students who have at least this amount of cumulative units on the TOT_CUMULATIVE table. When you navigate out of this field the Include in Progress Units check box appears.
Cumulative Units To	Enter a value to limit this student appointment block to students who have up to this amount of cumulative units on the TOT_CUMULATIVE table. When you navigate out of this field the Include in Progress Units check box appears.
Include in Progress Units	Select to include in progress units in the cumulative unit totals. Selecting this check box adds the TOT_INPROG_GPA and TOT_INPROG_NOGPA records to the calculation.
Term	Select a term to determine how many students fit this student appointment block criteria for a specific term.
Get # Students in Block	Click to run an ad hoc query to determine how many students fit this student appointment block for the selected term. This functionality is available to assist you in assigning appointments appropriately.

Defining Processing Priorities for Student Appointment Blocks

Access the Processing Priorities page (**Records and Enrollment > Term Processing > Appointments > Student Appointment Block > Processing Priorities**).

This example illustrates the fields and controls on the Processing Priorities page. You can find definitions for the fields and controls later on this page.

Student Appointment Block		Processing Priorities	
Academic Institution:	PSUNV	PeopleSoft University	
Academic Career:	UGRD	Undergraduate	
Find View All First 1 of 1 Last			
Student Appointment Block:	FRESHM	Freshmen	
Priority Ranking 1:	Cumulative GPA		
Priority Ranking 2:	Units Completed		
Priority Ranking 3:	Academic Level - Projected		

Field or Control	Description
<p>Priority Ranking 1, Priority Ranking 2, and Priority Ranking 3</p>	<p>Define ranking priorities for this student appointment block. The Assign Appointment process obeys these rankings when assigning enrollment appointments to students. You can override these values on the Assign Appointments page. Select from:</p> <p><i>Units Completed:</i> The Assign Students Appointment process uses a student's total cumulative units (TOT_CUMULATIVE) as found on the student's career term record (STDNT_CAR_TERM). This includes a student's total transfer credit (TOT_TRNSFR), total other credit (TOT_OTHER), and total test score credit (TOT_TEST_CREDIT).</p> <p><i>Cumulative GPA:</i> The Assign Students Appointment process uses a student's total cumulative GPA (CUM_GPA) as found on the student's career term record. Inclusion of transfer credit, test credit, and other credit depend on how your institution sets up these various types of credit.</p> <p><i>Academic Level - Projected:</i> The Assign Students Appointment process uses a student's projected academic level as found on the student's career term record.</p> <p><i>Academic Level - Term End:</i> The Assign Students Appointment process uses a student's academic level at term end as found on the student's career term record.</p> <p><i>Academic Level - Term Start:</i> The Assign Students Appointment process uses a student's academic level at term start as found on the student's career term record.</p>

If you leave these fields empty, or when multiple students are ranked the same, such as when multiple students have the same cumulative GPA, the system sorts those students by ID. A simple randomization feature loads the students into a temporary table and randomly assigns them a sequential number. Then, the system assigns the students appointments based on their number. This prevents a student from receiving an undesirable appointment every term based on his or her ID.

Creating Enrollment and Validation Appointments

This section provides an overview of enrollment and validation appointments and discusses how to:

- Select an appointment control session.
- Create enrollment appointment blocks.
- Create validation appointments.

Understanding Enrollment and Validation Appointments

An appointment consists of an appointment number, a start and end date, and a start and end time. In Student Records, appointments are organized into appointment blocks. An appointment block is a group of appointments. Because you can define multiple appointment blocks you can set up a variety of appointment types. For example, you can create one block with many appointments in 15 minute increments, and another with appointments in hourly increments. And you can create another block that contains appointments with varying lengths of time. You can also create multiple appointment blocks to allow some or all of the same students to have more than one appointment.

To create an appointment block you can manually enter appointment numbers, dates, and times, or you can use a variety of criteria to generate appointments in batch. We provide functionality that enables you an immense amount of flexibility and control in defining when appointments will begin and end, and how long they will last. Additionally, you can easily define the maximum number of students in each appointment and you can see how many students are actually assigned to a particular appointment. The system updates the number of students actually assigned to an appointment when the Assign Students Appointment process assigns an appointment to a student, when you assign an appointment to an individual student on the Student Enrollment Appointment page, or when you delete a student appointment.

You create validation appointments the same way that you create enrollment appointments. Like enrollment appointments, validation appointments use appointment blocks, and you can create appointments in batch using the flexible start, end, and number of students per appointment criteria, or manually. The Validation Appointment page only appears if you have enabled the Validation feature on the Self Service Options page in the Academic Career Table component.

You create appointment blocks by session. You can reuse the appointment blocks that you created for one session for another session by selecting the first session as the appointment control session. When you select an appointment control session, the Enrollment Appointment and Validation Appointment pages become unavailable for that session.

Pages Used to Create Enrollment and Validation Appointments

<i>Page Name</i>	<i>Definition Name</i>	<i>Navigation</i>	<i>Usage</i>
Appointment Table	SSR_APPT_TBL_HDR	Records and Enrollment > Term Processing > Appointments > Appointment Table > Appointment Table	Set an appointment control session, if applicable, and indicate if you want to display enrollment and validation appointments in self service.

<i>Page Name</i>	<i>Definition Name</i>	<i>Navigation</i>	<i>Usage</i>
Enrollment Appointments	APPOINTMENT_TBL	Records and Enrollment > Term Processing > Appointments > Appointment Table > Enrollment Appointments	Define enrollment appointments, by appointment block, for the session. For each enrollment appointment, define the valid date and time ranges, length of appointments, and the number of students allowed per appointment. Regardless of whether you decide to assign appointments manually or through the Assign Students Appointment process, you must create the parameters of each appointment ID on this page.
Validation Appointments	SSR_VALIDAT_TBL	Records and Enrollment > Term Processing > Appointments > Appointment Table > Validation Appointments	Define validation appointments, by appointment block, for the session. For each validation appointment, define the valid date and time ranges, length of appointments, and the number of students allowed per appointment. This page is available if you selected the Enable Validation Feature check box on the Self Service Options page for this academic career.

Selecting an Appointment Control Session

Access the Appointment Table page (**Records and Enrollment > Term Processing > Appointments > Appointment Table > Appointment Table**).

Field or Control	Description
Appointment Control Session	<p>Enter a session to which you want to point this session's appointment information. This enables a student to register in both sessions with a single appointment. For example, by pointing the appointment control session for a 12-week session and a 6-week session to a regular session, the appointment information defined for the regular session becomes valid for both the 12-week and 6-week sessions. When you select an appointment control session, the Enrollment Appointment and Validation Appointment pages for this session becomes unavailable for edit.</p> <hr/> <p>Note: This field is only available for entry if this session has no students assigned to it. If no students are assigned to the session for which you are setting an appointment control session value, the appointments from the session are deleted.</p>
Enrollment Appointments	<p>Select this check box if you want the system to display the enrollment appointments for this session in self-service pages. Clear this check box if you want to add and delete appointments and test the results of different enrollment appointment criteria before enrollment appointments are visible in self-service pages.</p>
Validation Appointments	<p>Select this check box if you want the system to display the validation appointments for this session in self service. Clear this check box if you want to add and delete appointments and test the results of different validation appointment criteria before enrollment appointments are visible in self service.</p> <p>This field is available if you selected the Enable Validation Feature check box on the Self Service Options page for this academic career.</p>

Session Dates

These dates appear as defaults from the Session Table page. They appear here to assist you when assigning appointment date ranges on the Enrollment Appointments page.

Note: Appointment start and end dates must be within the first day and last day to enroll date range set up on the Session Table page.

Creating Enrollment Appointment Blocks

Access the Enrollment Appointments page (**Records and Enrollment > Term Processing > Appointments > Appointment Table > Enrollment Appointments**).

Appointment Blocks

<i>Field or Control</i>	<i>Description</i>
Appointment Block	<p>Enter a name or code for this appointment block. An appointment block is a group of appointments. You can define one or several appointment blocks for a session. For example, you can define one appointment block for all student appointments in a session, or you can define one appointment block that contains appointments in 15 minute increments, while another might have appointments in hourly increments. Then, you can create one appointment block that has varying lengths of time. You can also set up multiple appointment blocks to allow the same block of students to have more than one appointment. Appointment block is now a key on the Appointment table.</p> <p>When you run the Assign Students Appointment process (SRAPPT.sqr), you merge a student appointment block with this appointment block. Also, when you assign individual students to appointments on the Student Enrollment Appointment page, you can select appointments by appointment block.</p>

Create Appointments

<i>Field or Control</i>	<i>Description</i>
Start with Appointment Nbr (start with appointment number)	<p>Indicate to the system where you want to start the appointment numbers in this appointment block. You can enter any numerical value. This enables you to segment appointment numbers if you want to leave gaps that can be filled later. If no value is entered, the system starts the appointment numbers with the next available number.</p>

Appointments Start - Date/Time Range

<i>Field or Control</i>	<i>Description</i>
Appointment Start Date and Appointment End Date	<p>Enter a range of dates in which your appointments can start. For example, if you enter 08/01/2005 in the Appointment Start Date field and 09/01/2005 in the Appointment End Date field, the first appointment in the block will start on 08/01/200, and the last appointment in the block will start on 09/01/2005. Appointments might end on a later date than 09/01/2005, but they will not start later than that date.</p> <p>The appointment start and end dates will be edited against the first date and last date to enroll for the session. If the date being added is not within the range, an error message will appear.</p>
Appointment Start Time and Appointment End Time	<p>Enter a range of times at which you want your appointments to start. For example, if you enter a start of 8:00 a.m. and an end time 5:30 p.m., the first appointment of the day will start at 8:00 a.m., and the last appointment of the day will start no later than 5:30 p.m. Appointments might end later than 5:30 p.m., but they will not start later than that time.</p>

Appointments Start Every

<i>Field or Control</i>	<i>Description</i>
Length, Minutes, Hours, and Days	<p>Enter the length of time between the start time for each appointment. For example, if you enter 30 minutes, then appointments will start in 30 minute increments.</p>

Appointments End

<i>Field or Control</i>	<i>Description</i>
When The Next Appt Starts (when the next appointment starts)	<p>Select to have the system schedule appointments immediately following one another. For example, if one appointment ends at 9:25 a.m., the next appointment would start at 9:25 a.m.</p>
All Last Same Length of Time	<p>Select to manually enter the length of time that you want each appointment to last.</p>

<i>Field or Control</i>	<i>Description</i>
Length, Minutes, Hours, and Days	These fields become available when you select the All Last Same Length of Time option. Enter the length of time that you want appointments to last.
All End at the Same Time	Select to indicate a specific date and time that you want all appointments in this appointment block to end. The End Date and End Time fields appear.
End Date	This field becomes available when you select the All End at the Same Time option. Enter the date on which you want all appointments in this appointment block to end.
End Time	This field becomes available when you select the All End at the Same Time option. Enter the time at which you want all appointments in this appointment block to end.

Additional Elements

<i>Field or Control</i>	<i>Description</i>
Number of Students per Appt (number of students per appointment)	Enter how many students you want assigned to each appointment. You can change this for individual appointments in the Number of Students per Appt field.
Create Appointments	Click to create enrollment appointments in batch based on the criteria you defined.

Appointments

The system populates this grid when you click the **Create Appointments** button. You can also manually add and delete appointments here.

Note: You cannot delete an appointment in which students are already assigned.

Field or Control	Description
Appt Nbr (appointment number)	<p>The system starts the appointment numbers with the value you entered in the Start with Appointment Nbr field. You can override this value. If no value is entered in the Start with Appointment Nbr field, the system will start the appointment numbers with the next available number.</p> <p>The system assumes appointments are assigned in numerical order. Therefore, appointment 0002 begins after appointment 0001. Through the Assign Appointments and Student Enrollment Appointment pages, you can assign appointment numbers to students.</p>
Number of Students per Appt (number of students per appointment)	<p>When you create appointments in batch, The system populates this value based on the value you entered in the Number of Students per Appt field in the Create Appointments group box. You can change this value here.</p>
Number of Student Assigned	<p>The number of students actually assigned to this appointment ID appears here. The system updates this number when a student appointment is deleted or when a student is assigned an appointment in batch on the Assign Appointments page or individually on the Student Enrollment Appointment page.</p>

Creating Validation Appointments

Access the Validation Appointments page (**Records and Enrollment > Term Processing > Appointments > Appointment Table > Validation Appointments**).

Create validation appointments the same way that you create enrollment appointments. This page is available if you selected the **Enable Validation Feature** check box on the Self Service Options page for this academic career.

Related Links

[Creating Enrollment Appointment Blocks](#)

Assigning Enrollment and Validation Appointments in Batch

This section provides an overview of assigning appointments in batch, lists prerequisites, and discusses how to assign appointments in batch.

Understanding Assigning Appointments in Batch

The Assign Students Appointment process (SRAPPT.sqr) assigns or deletes enrollment or validation appointments in batch for a career, term, and session. The process:

1. Identifies the students that fit the criteria of the student appointment block.
2. Ranks the students according to the priority rankings set up on the student appointment block, or, based on the override rankings selected on the Assign Appointments page.
3. Ranks the students further, if necessary, based on a simple randomization feature that loads the student IDs into a temporary table and then randomly assigns them a number.
4. Assigns the students, based on their ranking, an appointment number and unit limit information.

The process stores this data on the Student Appointment table (STDNT_ENRL_APPT).

If your institution has licensed Campus Solutions Self Service, students can view their appointments online as soon as you assign them, so long as you have enabled appointments to be displayed in Campus Self Service on the Appointment Table page for this session.

Assigning or deleting appointments using the Assign Students Appointment process updates the Number of Students Assigned field for the assigned appointments on the Enrollment Appointments or Validation Appointments pages.

Prerequisites

The Assign Students Appointment process can create communications giving you the option to generate enrollment appointment notification mailers for your students. Each time you run the Assign Students Appointment process, with the **Create Communications** check box selected, it creates a new communication. for the affected students. Before you run the Assign Students Appointment process, you must define enrollment appointment mailers on the communications tables. We deliver an example enrollment appointment mailer that you can use as a model.

Note: Select the **Create Communications** check box only if you are ready to create communications.

To set up an enrollment appointment mailer:

Note: The system uses the STRM Administrative function and the APPTMR communication key. You must define an appointment communication key in the STRM Administrative Function for your institutions.

1. In the Build Community - Communications menu, use the Standard Letters page to create a standard letter for the enrollment appointment mailer, such as an *APP* letter.
2. Use the Communication Context page to define a communication context for the enrollment appointment mailer, such as *APPTI*.

In the **Communication Context Method** group box, select in the **Letter Code** field the standard letter that you have defined for the enrollment appointment mailer, which in this example is *APP*.

3. Use the Communication Categories page to set up a communication category for Student Records, such as *SREC*.

In the **Communication Context** group box, insert a row for the communication context that you have defined for the enrollment appointment mailer, which in this example is *APPTI*.

- Use the Communication Speed Keys page to set up the administrative function for the enrollment appointment mailer, such as *STRM*.

In this example, you would set the **Category** field to *SREC*, the **Context** field to *APPTI*, and the **Letter Code** field to *APP*. Alternatively, you can create appointment communications in batch by institution career and term after you have assigned all of your appointments through the Appointment Communications page.

Related Links

“Understanding Communication Management” (Campus Community Fundamentals)

Pages Used to Assign Enrollment and Validation Appointments in Batch

<i>Page Name</i>	<i>Definition Name</i>	<i>Navigation</i>	<i>Usage</i>
Assign Appointments	SSR_RUNCTL_APPT	Records and Enrollment > Term Processing > Appointments > Assign Appointments > Assign Appointments	Define parameters for and run the Assign Students Appointment process to assign students to appointments in batch.
Assign Appointments - Search for an Appointment	SSR_RUNC_APPT_SEC	Click the Find Appointment From or Find Appointment To link on the Assign Appointments page.	Search for appointment IDs within the selected appointment block by start date, end date, start time, or end time.

Assigning Appointments in Batch

Access the Assign Appointments page (**Records and Enrollment > Term Processing > Appointments > Assign Appointments > Assign Appointments**).

<i>Field or Control</i>	<i>Description</i>
Academic Institution, Academic Career, and Term	Enter the academic institution, academic career, and term for which you want to assign enrollment appointments to students.
Process Mode	Select <i>Add Appointments</i> to have the Assign Students Appointment process find students based on the criteria that you specify and assign them the selected appointments. Select <i>Delete Appointments</i> to have the Assign Students Appointment process find students based on the criteria that you specify and delete those students' appointments. Added and deleted appointments will be correctly reflected in the Number of Student Assigned field on the Enrollment Appointments page. Note: Because the Process Mode field is on level one, deleting appointments deletes all appointments for all rows on this page. If you want to delete just one student appointment block, add that student appointment block to a new run control.

Field or Control	Description
Create Communication	<p>Select this check box to record appointment information to be able to later generate enrollment appointment notifications for students. When you select this check box, the Assign Students Appointments process populates the communication table with an administrative function of APP and records for each affected student the action of add or delete, the appointment type of enrollment or validation appointment, and the student block and appointment block.</p> <p>See Creating Appointment Communications in Batch.</p>
Session	Select the session for which you want to assign enrollment appointments to students.
Do not Allow Multiple Appts (do not allow multiple appointments)	<p>Select this check box to prevent the system from assigning multiple appointments to a student who meets the criteria of multiple student appointment blocks.</p> <hr/> <p>Note: To ensure students receive the best appointment possible, organize your run control so that the most favorable student appointment block runs first.</p> <hr/>
Student Appointment Block	Select the student appointment block for which you want to create appointments. Define student appointment blocks on the Student Appointment Block page.
Override Block Priorities	Select this check box to override the priority ranking set up for the student appointment block on the Processing Priorities page.

Field or Control	Description
<p>Priority Ranking 1, Priority Ranking 2, and Priority Ranking 3</p>	<p>These fields become available when you select the Override Block Priorities check box. Use these fields to override the priority ranking set up for the student appointment block on the Processing Priorities page. The Assign Appointment process obeys these rankings when assigning enrollment appointments to students. Select from:</p> <p><i>Units Completed:</i> The Assign Students Appointment process uses a student's total cumulative units (TOT_CUMULATIVE) as found on the student's career term record (STDNT_CAR_TERM). This includes a student's total transfer credit (TOT_TRNSFR), total other credit (TOT_OTHER), and total test score credit (TOT_TEST_CREDIT).</p> <p><i>Cumulative GPA:</i> The Assign Students Appointment process uses a student's total cumulative GPA (CUM_GPA) as found on the student's career term record. Inclusion of transfer credit, test credit, and other credit depend on how your institution sets up these various types of credit.</p> <p><i>Academic Level - Projected:</i> The Assign Students Appointment process uses a student's projected academic level as found on the student's career term record.</p> <p><i>Academic Level - Term End:</i> The Assign Students Appointment process uses a student's academic level at term end as found on the student's career term record.</p> <p><i>Academic Level - Term Start:</i> The Assign Students Appointment process uses a student's academic level at term start as found on the student's career term record.</p>
<p>Appointment Type</p>	<p>Indicate whether the appointments you are assigning are enrollment or validation appointments.</p>
<p>Use Program Term/Session Limit</p>	<p>Select this check box if you want the Enrollment Engine to enforce term/session limits for the students you are assigning appointments based on the limits of the students' academic programs. You must select this check box or enter an appointment limit ID.</p>

Field or Control	Description
Appointment Limit ID	<p>Assign an appointment limit ID to the students to whom you are assigning appointments. The Enrollment Engine enforces appointment limits set up for the appointment limit ID. Only those appointment limit IDs for this academic career appear in the search dialog.</p> <p>You must select the Use Program Term/Session Limit check box or enter an appointment limit ID.</p> <p>Based on the Appointment Control Unit Limit option selected on the Academic Career Table 2 page, the unit limit defined on the Appointment Limit ID applies to either each individual session for which a student's appointment is valid or applies across all the sessions covered by the appointment.</p> <p>See "Defining Academic Careers" (Campus Solutions Application Fundamentals)</p>
Appointment Block	Select the appointment block to which you want to assign students. Use the Appointment Table to create appointment blocks.
Appointment Number From	Select the appointment number within the specified range of appointment numbers to further narrow where you want the process to <i>begin</i> its assignment of appointments for students that meet the processing parameters of this row of the request.
Appointment Number To	Select the appointment number within the specified range of appointment numbers to further narrow where you want the process to <i>end</i> its assignment of appointments for students that meet the processing parameters of this row of the request.
Find Appointment From and Find Appointment To	Click to search for appointments. The Assign Appointments - Search for an Appointment page appears.

Run the Assign Students Appointment process as needed. The process produces a hard-copy report for you that displays each student's appointment number, the time and date range of each appointment, the student's name, and the student's ID. The process also populates the communication table with students for whom you have generated appointments so that you have the option to generate enrollment appointment notification mailers to inform your students. The mailer contains the date, student's name and address, salutation, enrollment appointment information, and instruction about how the student can enroll in classes during appointment time. You can make changes to the mailer.

Assigning and Maintaining Appointments for Individual Students

This section discusses how to assign and maintain appointments for individual students.

Pages Used to Assign and Maintain Appointments for Individual Students

<i>Page Name</i>	<i>Definition Name</i>	<i>Navigation</i>	<i>Usage</i>
Student Enrollment Appointment	STDNT_ENRL_APPT	Records and Enrollment > Term Processing > Appointments > Student Enrollment Appointment > Student Enrollment Appointment	Assign enrollment appointments on a student-by-student basis. You can also use this page after you've run the Assign Students Appointment process to verify that a student's appointments has indeed been scheduled and to edit a student's appointment as necessary.
Student Enrollment Appointment - Search for an Appointment	SSR_ENRL_APPT_SEC	Click the Find Appointment link on the Student Enrollment Appointment page.	Search for appointment IDs by start date, end date, start time, or end time and appointment block.

Assigning and Maintaining Appointments for Individual Students

Access the Student Enrollment Appointment page (**Records and Enrollment > Term Processing > Appointments > Student Enrollment Appointment > Student Enrollment Appointment**).

This example illustrates the fields and controls on the Student Enrollment Appointment page. You can find definitions for the fields and controls later on this page.

Student Enrollment Appointment

Maria Del Rosario
SR13437

Academic Career: Undergraduate
PeopleSoft University

Term: 2011 Spring

Session Limits
Find | View All First 1 of 1 Last

Session: 1 Regular Academic Session + -

Only Use Term Limits

Override Maximum Units

Max Total Units: Max No GPA Units:

Max Audit Units: Max Wait List Units:

Max Total Courses:

Enrollment Appointments
Find | View All First 1 of 1 Last

*Appt Block	*Appt Nbr	Start Date	Start Time	End Date	End Time	Find Appointment	+ -
DS001	0001	11/01/2010	12:00AM	11/13/2010	11:59PM		

Select Limits for Appointment

Use Program Term/Session Limit

Use Appointment Limit ID Limit ID:

Set Maximum Units

Max Total Units: Max No GPA Units:

Max Audit Units: Max Wait List Units:

Include Wait List in Total:

Validation Appointments
Find | View All First 1 of 1 Last

*Appt Block	*Appt Nbr	Start Date	Start Time	End Date	End Time	Find Appointment	+ -
<input type="text"/>	<input type="text"/>						

Session Limits

<i>Field or Control</i>	<i>Description</i>
Session	Select the session for which you want to assign enrollment appointments to the student.
Only Use Term Limits	Select if you want the enrollment engine to use term unit limits (defined on the Enrollment page of the Academic Program Table component), rather than session unit limits (defined on the Session page of the Academic Program Table component). The enrollment engine still checks appointment limits, even if this check box is selected.

Field or Control	Description
Override Maximum Units	<p>Select to override the session unit limits set for the student's primary academic program of the enrollment term. When you select this check box, the system makes available the Max Total Units, Max Audit Units, Max No GPA Units, and Max Wait List Units fields and displays the values set on the Session page of the Academic Program Table component. You can then override the values for this student's enrollment appointment. If you are assigning a new enrollment appointment to the student and you want to use this override, you must first select this check box and save the page. Clear this check box to use the previously defined session unit limits set for the student's primary academic program of the enrollment term.</p> <hr/> <p>Note: Selecting this check box does not override a student's term unit limits for the student's primary academic program within the enrollment term, as set on the Enrollment page of the Academic Program Table component.</p>
Max Total Units	Enter the maximum number of units that the student can enroll in for all of the enrollment appointments within the specified session.
Max No GPA Units (maximum number grade point average units)	Enter the maximum number of units that the student can enroll in with a non-GPA grading basis for all of the enrollment appointments within the specified session.
Max Audit Units	Enter the maximum number of units that the student can take in audit status for all of the enrollment appointments within the specified session.
Max Wait List Units	Enter the maximum number of wait-list units that the student can take for all of the enrollment appointments within the specified session.
Include Wait List in Total	<p>If you select this check box, the enrollment engine includes wait listed units towards the appointment maximum.</p> <p>For example: A student has an appointment maximum unit limit of 15 and a maximum wait list unit limit of 9. The student is enrolled in 6 units and wait listed in 6 units. If the check box is selected, the student can enroll and/or wait list in an additional 3 units only, because the 6 wait listed units are applied to the overall limit of 15.</p>

Field or Control	Description
Max Total Courses	<p>By default, the system displays the maximum number of courses that this student can take for the specified session.</p> <p>The system determines this value according to the maximum courses that a student can take for the specified session <i>and</i> the term category of the specified term, as defined for the student's primary academic program for the specified term. Set total maximum course values by academic load for term category and session combinations within an academic program on the Course page in the Academic Program Table component. If you have cleared the Only Use Term Limits check box for the specified session on the Session Enrollment Limits page, this field is unavailable.</p>

Enrollment Appointments

Field or Control	Description
Appt Block (appointment block)	Enter an appointment block from which you want to assign an appointment. You can also search for an appointment by clicking the Find Appointment link.
Appt Nbr (appointment number)	<p>Enter the appointment number that you want to assign to the student. You must enter a valid appointment number for the appointment block that you entered. You can also search for an appointment number by clicking the Find Appointment link.</p> <p>Define appointments on the Enrollment Appointments page in the Appointment Table component. The system displays the start and end dates and the start time of the enrollment appointment that you select.</p>
Find Appointment	Click to search for an appointment by appointment block or by date and time. The Student Enrollment Appointment - Search for an Appointment page appears.

Select Limits for Appointment

Indicate how you want to enforce appointment limits for this individual.

Field or Control	Description
Use Program Term/Session Limit	Select this option if you want the Enrollment Engine to enforce the enrollment limits of the term and session—set up on the Enrollment page in the Academic Program Table component—for the appointment limits.
Use Appointment Limit ID	Select this option if you want the Enrollment Engine to enforce the appointment limits set up for the appointment limit ID. When you select this option, the Limit ID field appears.
Limit ID	<p>The field appears when you select the Use Appointment Limit ID option. Enter the appointment limit ID that you want to use to enforce appointment limits. Define appointment limit IDs on the Appointment Limit ID page.</p> <p>Based on the Appointment Control Unit Limit option selected on the Academic Career Table 2 page, the unit limit defined on the Appointment Limit ID applies to either each individual session in which a student is enrolled or applies to all the sessions in which a student is enrolled.</p> <p>See “Defining Academic Careers” (Campus Solutions Application Fundamentals)</p>
Set Maximum Units	Select this option if you want to define appointment limits here. Although you can enter higher limits than those defined for the session and term, the Enrollment Engine still enforces the session and term limits. For example, if the maximum total units for the session is 18, and you enter 20 in the Max Total Units field on this page, the Enrollment Engine does not let this student enroll in more than 18 units.
Max Total Units	Enter the maximum number of units that the student can enroll in during this enrollment appointment.
Max No GPA Units	Enter the maximum number of units that the student can enroll in with a non-GPA grading basis during this enrollment appointment.
Max Audit Units	Enter the maximum number of units that the student can audit during this enrollment appointment.
Max Wait List Units	Enter the maximum number of wait-list units that the student can take during this enrollment appointment.

Validation Appointments

This group box appears if you select the Enable Validation Feature on the Self Service Options page for this academic career.

<i>Field or Control</i>	<i>Description</i>
Appt Block (appointment block)	Enter an appointment block from which you want to assign an appointment. You can also search for an appointment by clicking the Find Appointment link.
Appt Nbr (appointment number)	Enter the appointment number that you want to assign to the student. You must enter a valid appointment number for the appointment block that you entered. You can also search for an appointment number by clicking the Find Appointment link. Define appointments on the Validation Appointments page in the Appointment Table component. The system displays the start and end dates and the start time of the validation appointment that you select.
Find Appointment	Click to search for an appointment by appointment block or by date and time. The Student Enrollment Appointment - Search for an Appointment page appears.

Creating Appointment Communications in Batch

This section lists prerequisites and discusses how to create appointment communications in batch.

Prerequisites

The Create Appts Communications process populates the communications tables, providing you with the option to generate enrollment appointment notification mailers for your students. Each time you run the Create Appts Communications process, it repopulates the communication tables with the newest enrollment appointment information for the affected students. Before you run this process, you must define enrollment appointment mailers on the communications tables. We deliver an example enrollment appointment mailer that you can use as a model.

Page Used to Create Appointment Communications in Batch

<i>Page Name</i>	<i>Definition Name</i>	<i>Navigation</i>	<i>Usage</i>
Appointment Communications	SSR_RNCTL_COM_APPT	Records and Enrollment > Term Processing > Appointments > Appointment Communications > Appointment Communications	Run the Create Appts Communications (SRAPCOMM.sqr) process to create appointment communications in batch.

Creating Appointment Communications in Batch

Access the Appointment Communications page (**Records and Enrollment > Term Processing > Appointments > Appointment Communications > Appointment Communications**).

When you run the Create Appts Communications process, the process uses the administrative function STRM and populates the communication tables with the letter code APP for every student within the selected institution, career, and term who has been assigned an appointment. In addition to the letter code of APP, the process records for each affected student the action of add or delete, the appointment type of enrollment or validation appointment, and the student block and appointment block.

After you populate the communication tables, you can generate enrollment appointment notification mailers for students.

Viewing Appointments Through Self Service

If your institution has licensed Campus Self Service, your students can view their enrollment and validation appointments directly over the web. Advisors can also view enrollment and validation appointment information over the web.

Related Links

“Viewing an Advisement Report” (Campus Self Service)

“Viewing Advisee Information Through Self-Service Pages” (Campus Self Service)

Processing Class Enrollment Transactions

Understanding Class Enrollment Processing

After you schedule classes for a term, activate students into that term, and assign enrollment appointments, you are ready to enroll students into classes. Student Records has flexible and robust enrollment processing where all the rules that you have set up in your schedule of classes and course catalog come to fruition.

This section discusses:

- Class enrollment processing.
- Enrollment request processing for drops.
- Date and time stamps on student enrollment records.

Important! Numerous common page elements are shared between the various enrollment components. We explain all page elements for the Quick Enroll component. For other enrollment components, however, we refer you back to the discussion of the Quick Enroll component for descriptions of these common elements. Therefore, a knowledge of the page elements in the Quick Enroll component is essential to understanding the functionality of the page elements in all enrollment components.

Class Enrollment Processing

The class enrollment processing tools in Student Records provides maximum flexibility when dealing with enrollment transactions and other enrollment-related activities. Five components and one self-service application, all of which post enrollment records to the same table (STDNT_ENRL), are available for you to process enrollment transactions.

You can process enrollment requests on a student-by-student basis through the Quick Enroll and Enrollment Request components. You can process enrollment requests for blocks of students and classes through the Block Enrollment component. Through the Mass Enrollment component, you can post a range of enrollment requests. Enrollment requests from all of these components go through the powerful enrollment engine during the posting process. The enrollment engine verifies that for every class requested, the student meets all rules for requisites, deadlines, permissions, and so on. Optionally, the enrollment engine also warns of potential repeats.

The Enrollment component, in contrast, bypasses the enrollment engine and all of its checkpoints, posting enrollment transactions directly to a student's enrollment record as soon as you save the data in the component. The Enrollment component is intended for use by only a select few power users at your academic institution and should not be made available to a wide user population.

If your academic institution has licensed Campus Self Service, your students can also submit enrollment requests over the internet during their scheduled enrollment appointment times. These requests function

the same as all other enrollment requests in your Student Administration system, writing data directly to your application tables.

When a user submits an enrollment request for an open entry/exit (OEE) class, the enrollment engine evaluates the student's primary academic program to verify that the academic program permits OEE enrollment. If the academic program does not permit OEE enrollment, the system returns an error message notifying the user that enrollment is not allowed in the chosen class. If the academic program does permit OEE enrollment, the enrollment engine then performs all of the existing edits as usual (such as class limits and requisite checks).

If the request successfully passes these edits, the enrollment process uses the OEE dynamic date rule assigned to the class to calculate a class end date and all the other dynamic calendar dates for the student. If no OEE dynamic date rule has been defined for the class, the enrollment process uses the rule established for the course offering. If no rule exists for the course offering, the request fails and the process returns an error message.

If the request is successful, you can view the dates calculated by the process using the academic calendar link on the Study List or by accessing the Student OEE Enroll Data page.

To submit an enrollment transaction for a student, the student must have a personal data record, have been activated in an academic program within the academic career to which the classes belong, and have been activated in the necessary term for that same academic career.

Diagram of Enrollment Engine Logic

The following diagrams show a high-level process flow of the enrollment engine:

Diagram 1 of 3 showing enrollment engine logic:

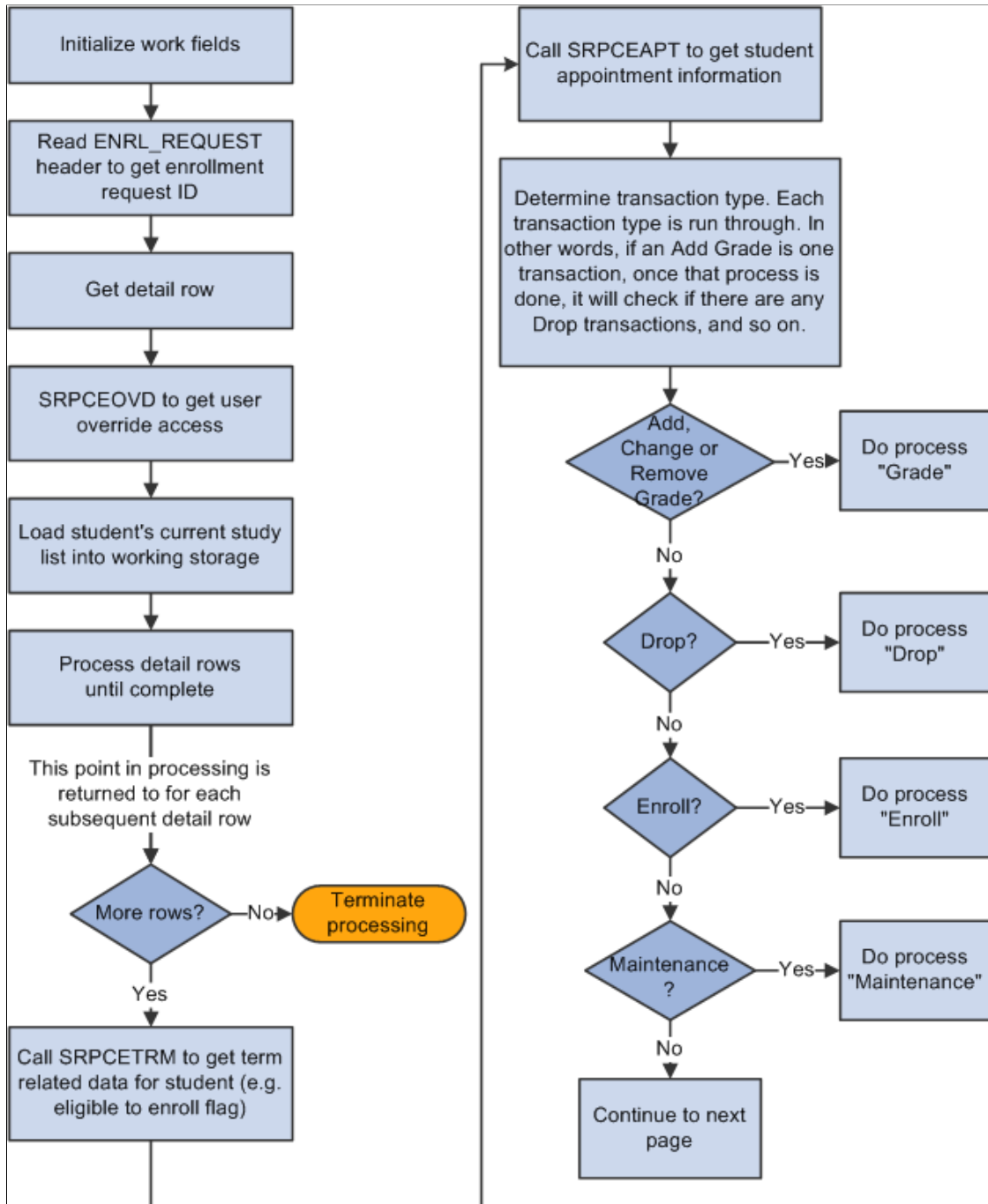

Diagram 2 of 3 showing enrollment engine logic:

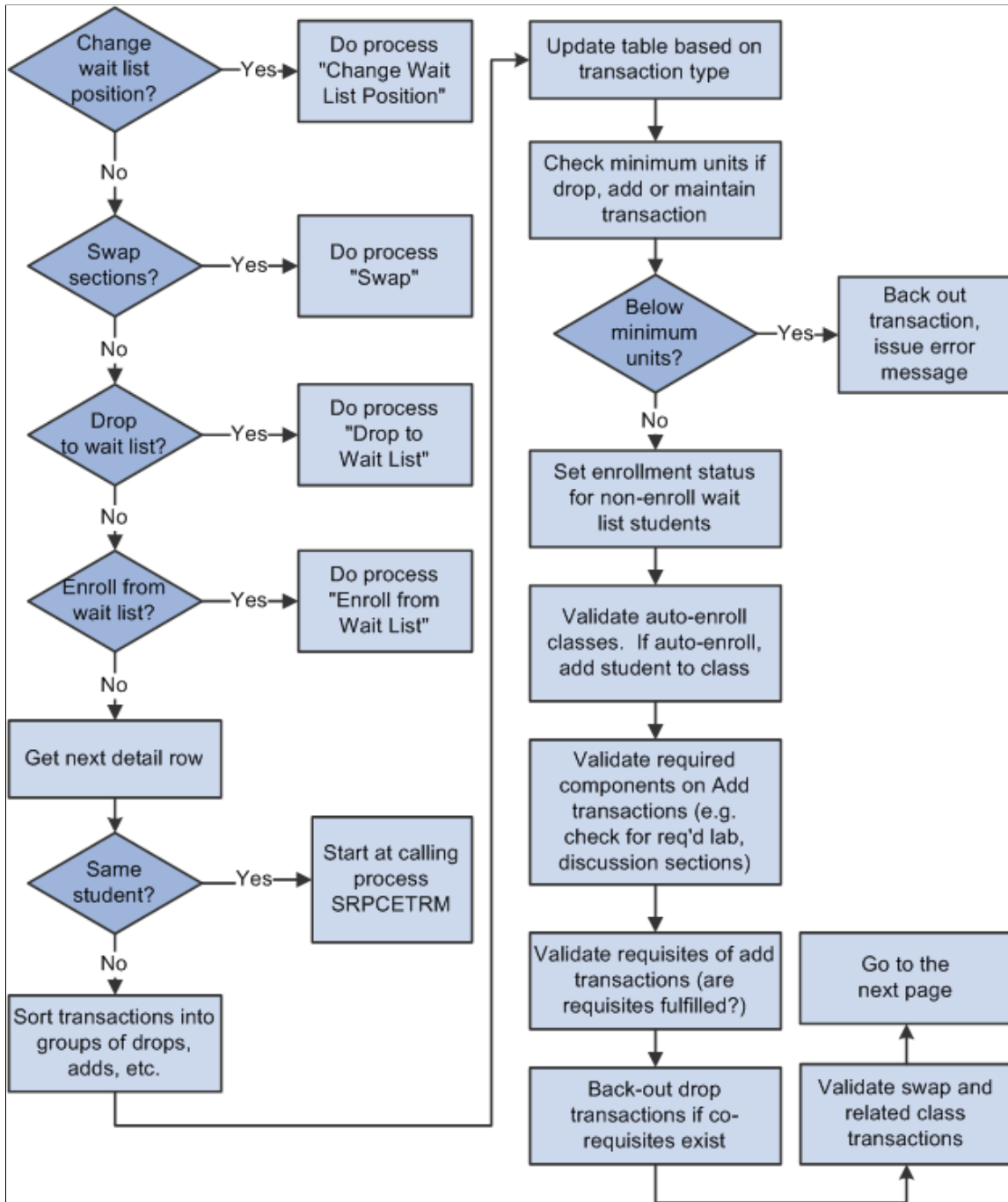
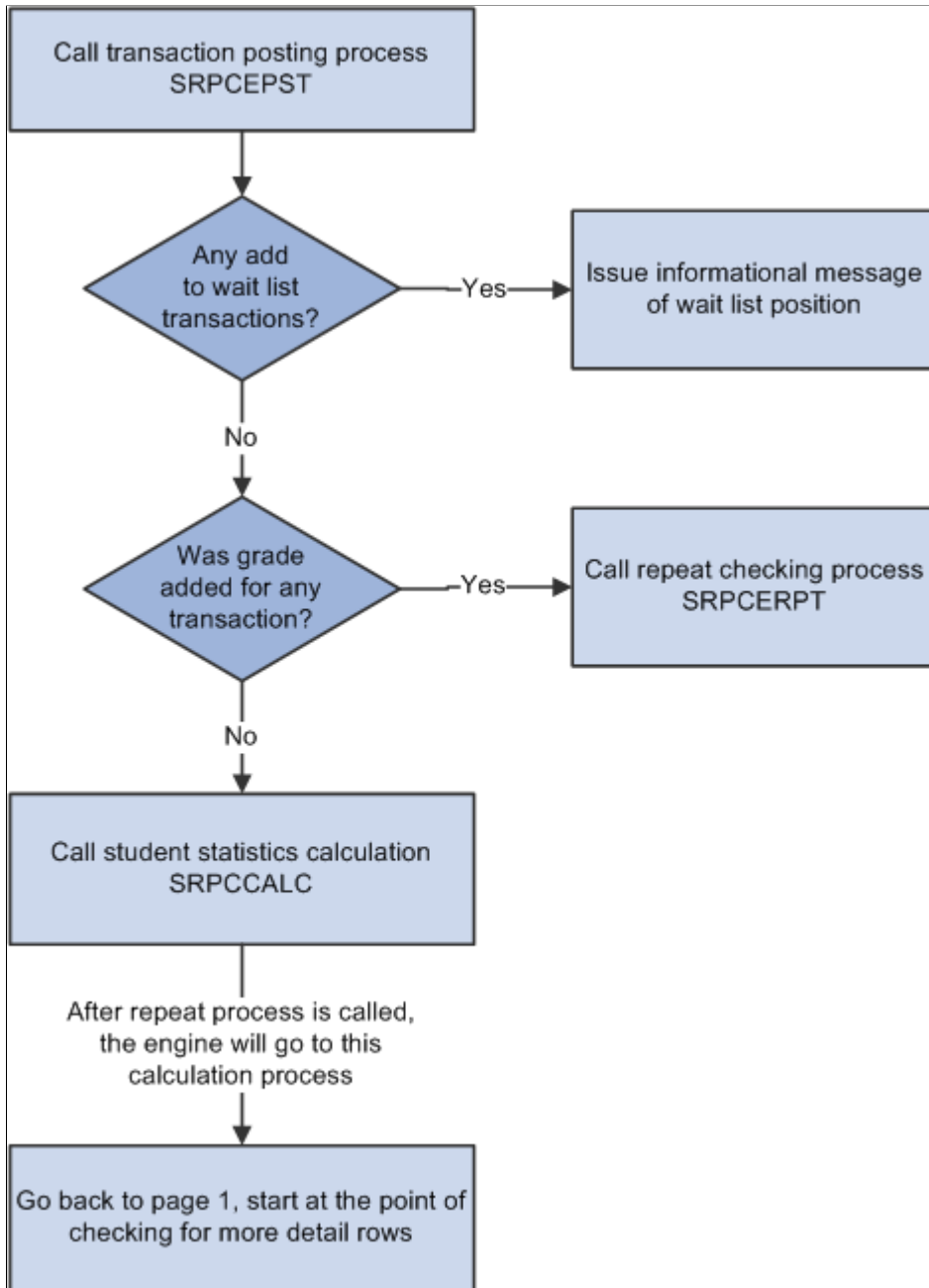

Diagram 3 of 3 showing enrollment engine logic:



Related Links

“Understanding Dynamic Academic Calendars” (Campus Solutions Application Fundamentals)

Enrollment Request Processing for Drops

When processing enrollment requests with an enrollment action of drop through the Quick Enroll, Enrollment Request, and Block Enroll components or self-service enrollment, the enrollment engine must determine the drop deadlines, reasons, grading bases, and grades with which to update the impacted student enrollment records (STDNT_ENRL).

The enrollment engine determines drop deadlines, grading bases, and grades differently depending on the class enrollment type (traditional, dynamic date, OEE).

When requesting to drop a traditional class enrollment, the enrollment engine:

- Determines the deadlines according to the values set on the Academic Calendar 2 page.
- Determines if a drop or withdrawal grade has been defined for the grading basis (based on the student's grading basis in the class) on the Grading Scheme Table page.

If there is no grade set on that page, the enrollment engine uses the grading schemes and grades set on the Session Calendar 2 page.

See [Defining Grading Schemes](#).

When requesting to drop a dynamic date class enrollment, the enrollment engine:

- Determines the deadlines according to the values that the Dynamic Class Dates process calculates and displays on the Dynamic Class Data page.

If you have not calculated the academic calendar dates for the class, the enrollment engine determines the deadlines according to the values set on the Academic Calendar 2 page.

- Determines if a drop or withdrawal grade has been defined for the grading basis (based on the student's grading basis in the class) on the Grading Scheme Table page.
 - If there is no grade set on that page and you *have* calculated the academic calendar dates for this class, the enrollment engine uses the grading schemes and grades set on the Dynamic Date page of the Academic Program Table component.

If there is no grading scheme and grade set on that page, the enrollment engine uses the grading scheme and grades set on the Session Calendar 2 page.

- If there is no grade set on the Grading Scheme Table page and you *have not* calculated the academic calendar dates for this class, the enrollment engine uses the grading scheme and grades set on the Session Calendar 2 page.

When requesting to drop an OEE class enrollment, the enrollment engine:

- Determines the deadline according to the values it calculates upon enrollment and displays on the Student Enroll OEE page.

If the deadlines have not been calculated, the request fails.

- Determines the grading scheme and grade, if applicable, according to the value set on the Grading Scheme Table page.

If there is no grade set on that page, the enrollment engine uses the grading schemes and grades set on the Dynamic Date page of the Academic Program Table component. If there is no grading scheme and grade set on that page, the request fails.

Regardless of the class enrollment type, the enrollment engine determines the reason according to the enrollment action reason that you enter on the enrollment processing page. If you do not enter a value on the enrollment processing page, then, for drop transactions during the drop retain record period only, the

enrollment engine uses the reason set on the Session Calendar 2 page. Otherwise, the engine assigns no reason.

If your institution wants to retain student enrollment records during the drop delete period, you can add an enrollment action reason to the drop and it will be retained subject to the time period associated with the enrollment action reason.

Note: The enrollment engine does not prevent enrollment request transactions after the drop deadlines. If you submit a request to drop after the latest drop deadline, the enrollment engine processes the request and generates a message that says that the drop was processed after the deadline.

Related Links

“Setting Up Session Drop Dates” (Campus Solutions Application Fundamentals)

“Defining Enrollment Action Reasons” (Campus Solutions Application Fundamentals)

Date and Time Stamps on Student Enrollment Records

Whenever you post an enrollment transaction that adds, drops, or updates a student enrollment record (STDNT_ENRL), the system populates the appropriate, enrolled, dropped, or updated row with date and time stamps based on the system date. These values are not viewable on any application pages. Student Financials uses these date and time stamps to correctly calculate adjustments in situations where your academic institution charges by term and adjusts by session. Classes are associated with sessions. The date and time stamp fields are as follows:

<i>Field</i>	<i>Description</i>
LAST_ENRL_DT_STMP	The date of the last enroll action or equivalent action.
LAST_ENRL_TM_STMP	The time of the last enroll action or equivalent action.
LAST_DROP_DT_STMP	The date of the last drop action or equivalent action.
LAST_DROP_TM_STMP	The time of the last drop action or equivalent action.
LAST_UPD_DT_STMP	The date of the last action.
LAST_UPD_TM_STMP	The time of the last action.

Related Links

“Setting Up Adjustment Calendars” (Student Financials)

Processing Enrollment Transactions Through the Quick Enrollment Component

This section provides an overview of the Quick Enroll component and discusses how to:

- Add or update quick class enrollment requests.
- Inquire about enrollment request messages.

Understanding Quick Enroll

The Quick Admit component, Quick Enroll component, and Quick Admit process component are a variation on the fuller processes of admitting students and enrolling them into classes. Typically, you'll use these components in conjunction with each other to accelerate admissions and enrollment procedures where immediate formal processing is not required or is unavailable for students. In addition, collecting admissions information on students who have been quick enrolled might be useful for various funnel reports.

The Quick Admit component and Quick Enroll component, when used together, enable you to rapidly add or update a student's personal data in your system; activate the student in an academic career, academic program, or term; and enroll the student in classes—all in a matter of minutes.

Important! The Recruiting and Admissions documentation for the Quick Admit use component and Quick Admit process component is essential reading for understanding how to quickly admit and enroll students. You should read that documentation to fully grasp the potential of the Quick Enroll component.

The Quick Enroll component enables you to enter, update, and post class enrollment requests for both new and continuing students on a student-by-student basis. The Quick Enroll component has the exact same functionality as the Enrollment Request component, using the same enrollment engine processing and performing the same edit checks. Transactions entered into the Quick Enroll component can be accessed through the Enrollment Request component and vice versa, giving you more flexibility and control over your enrollment requests.

Note that you cannot use the Quick Enroll component to view enrollment transactions processed through the Enrollment page because those transactions do not generate an enrollment request, nor can you view enrollment transaction processed through the Block Enrollment component because those transactions have more than one ID associated with the enrollment request. You can view the latter two enrollment sources only through their respective components.

When you access the Quick Enroll component, a dialog box prompts you to enter the key values of the transaction. The key values are:

<i>Term</i>	<i>Definition</i>
ID	Select from a list of existing student IDs.

Term	Definition
Academic Career	Select the academic career to which you want to add or update enrollment requests for the specified student. The system prompts you with only the academic careers in which the student is active. You can activate students in academic careers through either the Quick Admit component or the Student Program/Plan component.
Academic Institution	Select the academic institution in which you want to add or update enrollment requests for the specified student.
Term	Select the term for which you want to add or update enrollment requests for the specified student. The system displays only the terms in which the student is active for the academic career that you selected.
Enrollment Request ID	This identifies the enrollment request as unique from other enrollment requests. The Quick Enroll component uses enrollment request as a key to access transactions. In Add mode, this field is unavailable for edit because the system generates a unique enrollment request ID for you when you save the data in the Quick Enroll component. In other modes, select the enrollment request ID that you want to access.
OK	Click to open the component with the specified key values.

Related Links

“Adding New Prospects and Applications with Quick Admit” (Recruiting and Admissions)

“Viewing, Assigning, or Removing Service Indicators” (Campus Community Fundamentals)

Pages Used to Process Enrollment Transactions Through the Quick Enroll Component

Page Name	Definition Name	Navigation	Usage
Quick Enrollment	QUICK_ENROLL3	Records and Enrollment > Enroll Students > Quick Enroll a Student > Quick Enrollment	Add or update enrollment request transactions for both new and continuing students. The Quick Enroll component has the exact same functionality as the Enrollment Request component. Transactions that you process through the Quick Enroll component can also be accessed through the Enrollment Request component and vice versa.

<i>Page Name</i>	<i>Definition Name</i>	<i>Navigation</i>	<i>Usage</i>
Enrollment Message Log	ENRLREQ_MSGLOG_SBP	Click the Errors link or Messages link in the Status field on the Quick Enrollment page.	View error message text for a specific row in the enrollment request.

Adding or Updating Quick Enrollment Requests

Access the Quick Enrollment page (**Records and Enrollment > Enroll Students > Quick Enroll a Student > Quick Enrollment**).

When you use this page for continuing students and a student has a positive or negative service indicator assigned to his or her record, the system displays the corresponding **Service Indicator** button at the top of the page. Click the button that appears to view the details of specific service indicators.

General Page Elements

<i>Field or Control</i>	<i>Description</i>
Request ID	Identifies the enrollment request as unique from other enrollment requests. The Enrollment Request component uses an enrollment request as a key to access transactions. In Add mode, this field is unavailable for edit because the system generates a unique enrollment request ID for you when you save the data in the Enrollment Request component. In other modes, select the enrollment request ID upon accessing the component.
ID	The ID of the student for whom you are submitting the enrollment request.
Career	The academic career of the student for whom you are submitting the enrollment request.
Institution	The academic institution for which you are submitting the enrollment request.
Term	The term for which you are submitting the enrollment request.
	Click the Show All Columns button to display all of the fields at the bottom of the page in a single, scrollable grid rather than in separate tabs.

Field or Control	Description
	<p>Click the Show Tabs button to display all of the fields at the bottom of the page in separate tabs rather than a single, scrollable grid.</p>
<p>Submit</p>	<p>Click to process all nonposted rows of the enrollment request for the student. The enrollment engine performs validations as necessary at this time. If the enrollment engine encounters any errors, the system displays an enrollment request status of <i>Errors</i> on the corresponding row of the request. You can view the error messages in the appropriate row's Error Messages group box.</p> <hr/> <p>Note: You can also save the enrollment request and post groups of them on the Mass Enrollment page.</p> <hr/>

Class Enrollment Tab

Field or Control	Description
Action	<p>An enrollment action is the action performed on the enrollment record. The system by default sets the enrollment action for the request to <i>Enroll</i>, but you can override this default value. Values for this field are delivered with your system as translate values. Do not modify these values in any way. Any modifications to these values require a substantial programming effort. Select from the following choices.</p> <p><i>Add Grd</i> (add grade): Select to add a grade to the student's enrollment record for the corresponding class.</p> <p><i>Change Grd</i> (change grade): Select to change a grade on the student's enrollment record for the corresponding class.</p> <p><i>Chg WL Pos</i> (change wait list position): Select to change the student's wait list position for the corresponding class.</p> <p><i>Drop</i>: Select to drop the student from the corresponding class.</p> <p><i>Drop to WL</i> (drop to wait list): Select to drop the student from the corresponding class and move the student to the wait list for that class.</p> <p><i>Enroll</i>: Select to enroll the student into the corresponding class.</p> <hr/> <p>Warning! Enrollment request transactions with an action value of <i>Add Grade</i> or <i>Change Grade</i>, are the only types of transactions that create Student Incomplete rows when you assign an Incomplete grade (as defined on the Academic Program Table—Incomplete page). If you use an action of <i>Enroll</i> and populate the grade with an incomplete grade, the system does not create a Student Incomplete row.</p> <hr/> <p><i>Norm Maint</i> (normal maintenance): Select to update the student's enrollment record for the corresponding class in normal maintenance mode. Items available for update include grading basis, units, permission, course count, notes, requirement designation, repeat code, and instructor ID. You can use the normal maintenance action to update these items, rather than dropping the class and re-adding it with the new information.</p> <p><i>Remove Grd</i> (remove grade): Select to remove a grade from the student's enrollment record for the corresponding class.</p> <p><i>Swap</i>: Select to enable the student to swap the corresponding class in which he or she is enrolled for a different class. The Change To field becomes available for you to enter the new</p>

Field or Control	Description
	<p>class section in which the student wants to enroll. You can also use this option to swap a student's enrollment from one related class section to another related class section. List the enrollment class section in both the Class Nbr (class number) and Change To fields, select a different related class, then post the enrollment transaction.</p> <p>You cannot use the swap option to add or drop optional nonenrollment component sections. For example, if a student enrolls in a class section without designating the optional nonenrollment component section as a related class, then you cannot use the swap option to add the optional nonenrollment component section to the student's enrollment record.</p> <p>Instead, you must drop the student from the enrollment section, then process another enrollment request to add the student back into the enrollment section and also the optional nonenrollment component section. Likewise, if a student initially enrolls in both the enrollment section and the optional nonenrollment component section but wants to drop the optional nonenrollment component section altogether, you must drop the student from both sections and process another enrollment request to add the student back into the enrollment section only.</p>
Class Nbr (class number)	If you are submitting a new enrollment transaction, enter the number of the class for the term. The system generates a class number when you schedule classes for a term. The class number also appears on the schedule of classes.
	If you do not know the class number from the schedule of classes, click the Search button to view the Basic Class Search page, where you can search the schedule of classes for the class that you want to use for the enrollment transaction.
Change To	This field becomes available when you select an enrollment action of swap. Enter the number of the new class in which the student wants to be enrolled.
Class Description	The Class Description link becomes available after you enter a class number. The text for this link changes according to the title of the class that you selected. Click this link to access the Class Detail page, where you can view detail about the selected class.
Sect (section)	The system displays the section of the class that you selected.

Field or Control	Description
Start Date	When a student attempts to enroll in a class scheduled within an OEE session, the system prompts you to enter a class start date. The date that a student starts an OEE class drives the open entry/open exit processing. A class start date is required for enrollment in OEE classes.
Status (unlabeled)	<p>The system displays the status of the enrollment request.</p> <p><i>Errors:</i> The enrollment engine was unable to post the submitted enrollment request due to errors. Click this link to view the errors on the Enrollment Message Log page.</p> <p><i>Pending:</i> The enrollment request is pending submission for enrollment processing.</p> <p><i>Messages:</i> The enrollment engine was able to successfully post the enrollment request and has returned an informational message, such as the student's wait list position. Click this link to view the messages on the Enrollment Message Log page.</p> <p><i>Success:</i> The enrollment engine was able to successfully post the enrollment request.</p>
Academic Program	<p>Enter the student's academic program for this enrollment.</p> <p>This field appears if you select the Select Acad Prog During Enroll check box on the Academic Institution 5 page. This field is editable only if the student is active in more than one academic program for this term. In this case, the student's primary academic program for this term appears by default. You can change this value.</p>
Related 1	If you have select an enrollment action of <i>Enroll</i> or <i>Swap</i> , the Related 1 and Related 2 fields become available for edit. If the class has a related class that is not an auto-enroll class, select that class number in this field. The values that appear are those associated sections that are scheduled for the class in the schedule of classes.
Related 2	If the class has another related class that is not an auto-enroll class, select that class number in this field.

Units and Grade Tab

Select the Units and Grade tab.

Field or Control	Description
Unit Taken	<p>The system uses units taken to calculate the transcript GPA and the enrollment load. The enrollment engine uses units taken to calculate the number of units a student can take in a term. Units taken appear by default from minimum units on the Class Associations page. If minimum units and maximum units are different on the Class Associations page, then the class is defined as having variable units. This field becomes active, and you must enter the number of units the student selects in this field.</p>
Course Count	<p>Indicates the value of the course towards a degree. Some institutions count courses towards a degree as well as units towards a degree. This field indicates the value of the course towards degree progress. This field appears by default from the Course Count field on the Class Associations page.</p>
Grade Base	<p>The system displays the grading basis for the class according to the value set in the corresponding field on the Class Components page of the Class Associations component. If your institution has set the grading basis of the class to <i>student option</i> on the Class Components page, then this field becomes available for edit and students can select their own grading basis. The system determines the prompt values according to the grading scheme for the academic career to which the course belongs, as defined on the Academic Career Table page. However, if your institution has mapped the grading basis from one academic career to another through a grading basis mapping rule (on the Career Pointer Exception Rule page), then the system determines the prompt values according to the grading basis attached to the mapping rule.</p>
Grade Input	<p>This is the final grade given to the student for the class. You can enter the grade here, or you can use the grade roster generator. When a grade is entered and posted, the system displays the grade here.</p> <hr/> <p>Note: Posting grades through the Quick Enroll, Enrollment Request, and Block Enrollment components automatically runs the repeat checking process if the Repeat Grade Check option is set to <i>all crse</i> (all courses) for the student's academic program.</p> <hr/>

Field or Control	Description
Repeat Code	<p>Select a repeat code for the enrollment transaction, if applicable.</p> <p>Repeat codes work in conjunction with repeat rules to determine whether a repeated class violates your repeat policies. When the repeat checking process runs, it searches the student's enrollment history to find class enrollments with matching course IDs. When it finds a match, it determines whether the repeat is legal based on the repeat rules that you define.</p> <p>As part of your repeat rule criteria, you can specify that any class enrollment into a course with a particular repeat code should be ignored by the repeat checking process. So, even if the class enrollment violates the total attempts criteria (for example) as defined in the repeat rule, the process does not consider it in violation of the rule, as long as the class enrollment contains the required repeat code.</p> <p>For example, a repeat rule could specify that courses can be repeated only three times. However, you could stipulate that students can repeat the course more than three times if they have permission from the instructor. Thus, you could define a <i>PERM</i> (permission) repeat code and assign it to the class enrollment here. When the repeat checking process identifies this class enrollment as a repeat course, it looks to see if the <i>PERM</i> repeat code is assigned. If <i>PERM</i> is assigned, the repeat checking process does not consider this class enrollment in violation of the repeat rule.</p> <p>You can also define your repeat rules so that the repeat checking process <i>requires</i> that a particular repeat code be assigned to a class enrollment for the repeated course to be evaluated in a particular repeat rule. For example, you could specify that any class enrollment with the <i>ILGL</i> repeat code assigned to it is in violation of the rule.</p> <p>When the repeat checking process identifies a course that violates a repeat rule, the process assigns the class enrollment a repeat code. This repeat code determines how the class enrollment is treated in the student's academic statistics, such as whether the grade is used to calculate the student's grade point average. The repeat code that the repeat checking process assigns appears here.</p>
Requirement Designation	Use this field to select a requirement designation for the class enrollment.

Field or Control	Description
Requirement Designation Option	If there is a requirement designation specified for the corresponding row of the enrollment transaction <i>and</i> that requirement designation is at the student's option, select whether the student elects to take the requirement designation.
RD Grade (requirement designation grade)	You can enter the student requirement designation grade for the class enrollment on this page or through the grade roster. Usually, it is more convenient for you to enter grades for groups of students and classes through the grade roster. Values are <i>Satisfied</i> or <i>Not Satisfied</i> .

Other Class Info Tab

Select the Other Class Info tab.

Field or Control	Description
Permission	If the student has a general permission for enrollment, enter the number in this field. The system reserves the permission number for the student.
Drop if Enroll	The system displays this field only when the Action field is set to <i>Enroll</i> . Enter the class section that the student wants to drop. The system drops the student from this class section only if the student is successfully enrolled in the class section that the student is currently requesting. The system does not drop the student if he or she is put on a wait list. So if you select the Wait List Okay check box and the student is put on the wait list, the system will not drop the student. When you later run the Wait List process (SRPCWAIT) for the requested class section and the process successfully enrolls the student in that section, the Wait List process then drops the student from the class section that you specify in this field.
Ind Study Instructor (independent study instructor)	If the Instructor Edit field on the Class Associations page is set to anything but <i>No Choice</i> , then this field becomes available for edit. Select the instructor ID responsible for the class if the class is an independent study.

Field or Control	Description
Action Reason	Select the enrollment action reason for the enrollment action. If you select a reason, the enrollment engine automatically retains the student enrollment record even if you are dropping a student from a class during the drop delete period. If you do not select a reason and you are dropping a student from a class during the drop retain record period, the enrollment engine uses the default reason set on the Session Calendar 2 page subject to the time period associated with that reason.
Create Transcript Note	Click to access the Transcript Note page, where you can enter a free-form text that prints on the student's transcript for the class enrollment.

General Overrides Tab

Select the General Overrides tab.

Note: Only overrides that you are authorized to access are available.

Field or Control	Description
Appointment	Select to override the student's enrollment appointment date, time, and maximum enrollment units. This enables you to enroll the student in the class on the corresponding row of the enrollment request, regardless of the student's enrollment appointment.
Unit Load	Select to have the enrollment engine skip all unit limit checks, including the unit load for the student's enrollment appointment, the term and session unit load, the term and session course count load, the term and session no grade point average (GPA) units, the term and session audit units, and the minimum unit enrollment check.
Time Conflict	Select to disable time conflict checking for class sections when you process the enrollment request.
Action Date	Select to override the action date. The Action Date field becomes available to edit.

Field or Control	Description
Action Date	Select the date that you want to use as the action date for processing this enrollment transaction. The action date is the date that you process the corresponding row of the enrollment transaction. The system records the action date to track the date that you process information. By default, the system uses the current system date. When you are processing an enrollment request and you select to override the action date, this field becomes available for edit.
Requirement Designation	Select to override the requirement designation for the corresponding row of an enrollment request. The Requirement Designation field becomes available to edit.
Career	Select to override academic career pointers and career pointer exception rules for the student's academic career.
Service Indicator	Select to override service holds that have been placed on the student's record.
Requisites	Select to have the enrollment engine bypass requisite checking when you submit the corresponding row of an enrollment request for processing.

Class Overrides Tab

Select the Class Overrides tab.

Note: Only overrides that you are authorized to access are available.

Field or Control	Description
Closed Class	Select to indicate that the class is closed due to capacity size.
Class Links	Select to allow students to add and drop class sections without having to do likewise for the required related component sections in a class association group, to allow students to enroll in a nonenrollment type section, and to allow multiple student enrollment in a course.
Class Units	Select to override the <i>Units Taken</i> field value for both fixed and variable unit classes.

Field or Control	Description
Grading Basis	<p>Select to allow students to enroll into a class with a grading basis other than the one established for the class. The Grading Basis field becomes available for edit so that you can select a different grading basis for the class enrollment.</p> <hr/> <p>Note: If you select the Grading Basis check box on the Class Overrides tab when you add or change a grade using the Enrollment Request or Quick Enroll components, the STDNT_ENRL.OVRD_GRADING_BASIS is set to Y if the request posts successfully.</p> <p>If you perform an enrollment action on an existing STDNT_ENRL row (that is, the action is not Enroll or Swap), the Grading Basis check box on the Class Overrides tab is automatically selected (ENRL_REQ_DETAIL.OVRD_GRADING_BASIS is set to Y), if the class has an overridden grading basis (STDNT_ENRL.OVRD_GRADING_BASIS = Y).</p> <p>If the enrollment action is <i>Remove Grade</i>, the Grading Basis check box is not available for edit, regardless of a user's enrollment override security, to prevent a grade override being reversed.</p> <p>For actions other than <i>Remove Grade</i>, if you clear the Grading Basis check box on the Class Overrides tab for a class that has an overridden grading basis, the STDNT_ENRL.OVRD_GRADING_BASIS is updated to N.</p>
Class Permission	<p>Select to override general permission and student-specific permission requirements, academic career pointers, and career pointer exception rules.</p> <hr/> <p>Note: A student with a valid class permission can override course consent, academic career pointers, career pointer exception rules, class capacity size, and prerequisite checking.</p>
Wait List Okay	<p>Select to allow the student to wait list into a class section even if the class section, combined section, and reserve capacity are full provided that space is available on the wait list and the last date to wait list has not passed.</p>
Wait List Pos (wait list position)	<p>Click this link to access the Wait List Position page, where you can view the student's position on the wait list. This link is available only for enrollment requests in which the student is already on the wait list for the specified class section.</p>

(AUS) Australian Data Tab

Select the Australian Data tab.

Note: This tab is available only if you select the Australia **DEST, HECS, Centrelink, TAC** check box on Academic Institution 6 page.

Field or Control	Description
Student Career Nbr (student career number)	Select the student's career number.
Liability Status	If the student has a liability status on the Term Activation - Loan Election page, the system enters that value here. You can override that value for this course enrollment.
Cohort Year	If the student has a cohort year on the Student Program/Plan - AUS Student Program page, the system enters that value here.

New Zealand Data Tab

Select the New Zealand Data Tab.

Note: This tab is available only if you select the New Zealand **Catalog, SDR, EFTS, StudyLink** check box on the Academic Institution 6 page.

Field or Control	Description
Funding Source	The system enters this value from the student's program. Enter the funding source for the student's program on the Student Program page.
Course Classification	The system enters this value from the Acad Prog NZL (academic program New Zealand) page for course classifications defined with the type <i>Program</i> . For course classifications defined with the type <i>Course</i> , the system enters the value from the course catalog. Set up course classifications on the Course Classifications page. See Defining Course Classifications .

Field or Control	Description
Funding Category	If the student's program has a course classification type of <i>Program</i> , the first character on the Academic Program table is concatenated with the second character of the course catalog value, otherwise the course catalog value is used.
EFTS Factor	The system enters this value from the course catalog.

Go To Links

Field or Control	Description
View Enrollment Access	If your enrollment security is by enrollment access ID, click this link to access the Access to Enrollment Functions page, where you can view your security status for each enrollment function possibility.
Calculate Tuition	<p>Click to access the Tuition Calculation page, where you can calculate tuition for the student.</p> <p>Tuition calculation is located within the Quick Enroll component because when you have changes to a student's academic status that can affect their charges for tuition and fees, you can perform the tuition calculation immediately without having to defer the task. However, tuition calculation is most likely performed by your Student Financials department and should be done by other users only if it concurs with your business rules.</p> <p>The student must be active in at least one career and at least one term before you can use this page, but the student does not necessarily have to be enrolled in any classes. It is possible to calculate tuition for a student if your term fees are set up to use anticipated (projected) billing units. Also, you must have defined appropriate term fees and at least one tuition group.</p>
Study List	Click to access the Student Study List page, where you can view the student's class schedule for the specified term.
Enrollment Appointments	Click to access the Student Enrollment Appointment page, where you can view the student's enrollment appointments for the specified term.

Field or Control	Description
Term/Session Withdrawal	Click to access the Term History component, where you can view all of a student's term statistics for each term of the student's academic career, withdraw the student from the specified term or session, and more.

Related Links

[Adding Transcript Notes to Enrollment Requests](#)

“Setting Up Enrollment Security for Self-Service Enrollment” (Campus Solutions Application Fundamentals)

[Assigning and Maintaining Appointments for Individual Students](#)

[Processing Withdrawals and Cancellations](#)

“Understanding Self-Service Enrollment” (Campus Self Service)

[Acting on Enrollment Request Messages](#)

[Understanding the Three Repeat Checking Methods](#)

“Calculating Tuition for a Single Student” (Student Financials)

[Entering Grades Online](#)

[Posting the Grade Roster](#)

[Searching for Classes](#)

[Understanding Class Permissions](#)

[Defining Auto Enroll Options and Capacity](#)

“Understanding Student Records Security” (Campus Solutions Application Fundamentals)

“Understanding Dynamic Academic Calendars” (Campus Solutions Application Fundamentals)

[Understanding Australian Government TCSI Reporting](#)

[Understanding New Zealand Government Reporting](#)

Inquiring About Enrollment Request Messages

Access the Enrollment Message Log page (click the **Errors** link or **Messages** link in the **Status** field on the Quick Enrollment page).

Field or Control	Description
Message Severity	The posting process displays the severity of each message that it writes to the message log for the corresponding request. For example, if the posting process is unable to post a request due to errors, it displays a severity value of <i>Error</i> .
Message Text	The posting process displays the message text and a detailed explanation of each message that it writes to the message log for the corresponding request. You can view and update messages in the Message Catalog within the appropriate message set.

Requisite Checking for Adds

When a student fails to satisfy either a catalog requisite or class association requisite while enrolling in a class, the system returns not only a "requisites not met" error but also the **Requirement Group** long description for both on the Enrollment Message Log page. If a class has a course catalog level requisite and a class association level requisite, the system returns the requirement group description for both, even if the student has met one or the other. Catalog and class association requisites are set up on the Class Requisites page.

For example, a student has failed to satisfy either a catalog or a class association requisite. Depending on how class requisites are set up, the system displays both descriptions if the student satisfies the catalog requisite but not the class association requisite.

Requisite Checking for Drops

When a student attempts to drop a class, the Requisite Checking process runs if one or more of the student's other enrolled classes has a **Requirement Group** with a requisite type of *Co-Requisite*. If the dropped class is required as a co-requisite for another enrolled class, the system returns an error message. The system now returns the description for the Requirement Groups with the Co-Requisite requisite type. Catalog and class association requirement groups are set up on the Class Requisites page.

For example, a student is trying to drop class A and class A is a co-requisite for enrolled classes B and C. The system returns the enrollment requirement group description for both of those classes.

Requisite Checking for Self Service

The system displays the long description of the requirement group in error messages not only for administrative but also for student self-service enrollment pages. The Campus Self Service documentation provides details about how to set up self service to enable this functionality.

See "Setting Up Self-Service Features for Student Records" (Campus Self Service)

Processing Enrollment Transactions Through the Enrollment Component

The Enrollment component is similar to the Enrollment Request and Quick Enroll components but has some unique features that make it the most powerful component in which to process enrollment transactions. The Enrollment component enables you to:

- Bypass all requisite, requirement, deadline, and other rules.
- Post enrollment immediately when you save the transaction.

It does this quickly because the system does not check the enrollment against all the rules that you set up.

- Skip the enrollment request process and post enrollment immediately.

To keep the powerful capability of this component secure and avoid complications in your enrollment business practices, grant access for this component only to a limited number of users, and these select few should use the component infrequently.

This section discusses how to:

- Enter class enrollment information.
- View enrollment transaction information.
- Add transcript notes and text.
- Indicate requirement designation options and independent study instructors.
- View last enrollment action information.
- (AUS) Enter HECS data.
- (CAN) Enter ESIS student data.
- (NZL) Enter funding information.
- (NLD) Indicate student paper information.

Pages Used to Process Enrollment Transactions Through the Enrollment Component

<i>Page Name</i>	<i>Definition Name</i>	<i>Navigation</i>	<i>Usage</i>
Student Enrollment 1	STDNT_ENRL1	Records and Enrollment > Enroll Students > Enrollment > Student Enrollment 1	Enter class enrollment information by student, bypassing all enrollment rules and requirements. Saving this page posts the enrollment transaction to the student's enrollment record.
Student Enrollment 2	STDNT_ENRL2	Records and Enrollment > Enroll Students > Enrollment > Student Enrollment 2	View information about adds, drops, and other items for enrollment transactions processed through the Enrollment component.
Student Enrollment 3	STDNT_ENRL3	Records and Enrollment > Enroll Students > Enrollment > Student Enrollment 3	Add transcript notes and text to a student's enrollment record for an enrollment transaction processed through the Enrollment component.
Student Enrollment 4	STDNT_ENRL4	Records and Enrollment > Enroll Students > Enrollment > Student Enrollment 4	Indicate options for requirement designations and assign an independent study instructor to enrollment transactions processed through the Enrollment component.

Page Name	Definition Name	Navigation	Usage
Last Enrollment Action	STDNT_ENRL_LAST	Records and Enrollment > Enroll Students > Enrollment > Last Enrollment Action	View information about the last enrollment action processed on a student's enrollment record through the Enrollment component. The page provides a basic audit trail of information about the most recent enrollment action.
AUS Student Enroll (Australian student enrollment)	SSR_STDNT_ENRL_AUS	Records and Enrollment > Enroll Students > Enrollment > AUS Student Enroll	Enter HECS data for a student. <hr/> Note: This page appears only if you select the Australia DEST, HECS, Centrelink, TAC check box on the Academic Institution 6 page.
Cdn Student Enrollment (Canadian student enrollment)	CAN_RPT_STDNT_CRSE	Records and Enrollment > Enroll Students > Enrollment > Cdn Student Enrollment	Define ESIS student enrollment data. <hr/> Note: This page appears only if you select the Canadian Government Reporting check box on the Academic Institution 6 page.
NZL Student Enroll (New Zealand student enrollment)	SSR_STDNT_ENRL_NZL	Records and Enrollment > Enroll Students > Enrollment > NZL Student Enroll	Enter funding information for the student. <hr/> Note: This page appears only if you select the New Zealand Catalog, SDR, EFTS, StudyLink and NZQA check boxes on the Academic Institution 6 page.
NLD Student Paper (Dutch student paper)	SAD_BR_SPAP_NLD	Records and Enrollment > Enroll Students > Enrollment > NLD Student Paper	This page appears if you select the Use Dutch Functionality check box on the Student Admin Installation page. Use this page to record the student's end thesis for BRON reporting purposes. This information is used in the exam result data set for VAVO, which is the 331 file sent to BRON.

Entering Class Enrollment Information

Access the Student Enrollment 1 page (**Records and Enrollment > Enroll Students > Enrollment > Student Enrollment 1**).

This example illustrates the fields and controls on the Student Enrollment 1 page. You can find definitions for the fields and controls later on this page.

The screenshot shows the 'Student Enrollment 1' page for student Ana Beck. The student's information includes Term: 2003 Spr, Career: Undergrad, Institution: SR0400, and PeopleSoft University. The class details are: *Class Nbr: 1003, Description: Advanced Sculpture, Component: Seminar, Subject: Art, Catalog Nbr: 145, Class Section: 1, Academic Group: College of Fine Arts, Career: Undergrad, Session: Regular, Status: Enrolled, Reason: Enrolled, Status Date: 11/19/2004, Action: Manual Add, and Program: LAU. The Grading section includes an 'Override Grading Basis' checkbox, a *Grading Basis of GRD (Graded), and fields for Grade In/Official and Repeat Code. The Units section shows Units Taken: 3.00, Units Earned: 3.00, Course Count: 1.00, Progress: 3.00, Billing Units: 3.00, and FA Progress: 3.00. Navigation links for Term History and Enrollment Summary are at the bottom.

Field or Control	Description
Calculate End Date	This button becomes available when you select to add a class section within an OEE session and you enter a value in the Start Date field. Click this button to have the system calculate the end date of the OEE class section based on the start date that you enter.
Class Nbr (class number)	Select the class in which you want to add or drop the student. Class values for other fields appear according to the schedule of classes and class associations.
Status	The system displays the student's current enrollment status in the class section. The system sets the student's status based on the enrollment action that you process. If you have added or are adding the student to the specified class section through this component, the system displays the status as <i>Enrolled</i> . If you have dropped the student from the specified class section through this component, the system displays the status as <i>Dropped</i> up through the drop retain record period. After this period has passed, the system displays the status as <i>Enrolled</i> and assigns the corresponding penalty grade to the student enrollment record. Statuses are: <i>Enrolled</i> , <i>Waiting</i> , and <i>Dropped</i> .

Field or Control	Description
Reason	The system displays the reason associated with the student's current enrollment status in the class section. If you have added or are adding the student to the specified class section through this component, the system displays the reason as <i>Enrolled</i> . If you have dropped the student from the specified class section through this component, the system displays the reason as <i>Dropped (was enrolled)</i> .
Status Date	The date that you process the enrollment transaction for the corresponding row of the request. The system records the status date to track the date that you process information. The system uses the current system date for new enrollment transactions.
Action	Select from the following choices the action to perform on the enrollment record. Values for this field are delivered with your system as translate values. Do not modify these values in any way. Any modifications to these values require a substantial programming effort. Choices are as follows: <i>Drop</i> : Select to drop the student from the corresponding class section. <i>Manual Add</i> : Select to manually enroll the student into the corresponding class section, bypassing all enrollment rules and requirements.
Reason	If you are dropping the student from the specified class section, select the reason for the enrollment action, such as whether the student is dropping the class or the class has been canceled. A reason value is not required.
Program	Enter the student's academic program for this enrollment. This field appears if you selected the Select Acad Prog During Enroll check box on the Academic Institution 5 page. This field is editable only if the student is active in more than one academic program for this term. If this is the case, the student's primary academic program for this term appears by default. You can change this value.

Field or Control	Description
Grade In / Official	<p>The grade in is the final grade given to the student for the class. You can enter the grade here, or you can use the grade roster generator. When a grade is entered and posted, the system displays the grade here.</p> <hr/> <p>Note: Posting grades on the Student Enrollment 1 page <i>does not</i> automatically run the repeat checking process.</p> <hr/> <p>The grade lapse process does not include incomplete grades entered on the Student Enrollment 1 page.</p> <p>The grade official is the official grade for calculation and transcript purposes. The Grading Basis automatically translates the grade In to another value in this field, if appropriate.</p>
Units Earned	<p>The system uses units earned to determine academic level, as well as to grant actual credit to the student. This field is separate from units taken to accommodate the granting of partial credit for a class while continuing to have the class count fully towards GPA, academic load, or billing. Units earned default from units taken. When you add an enrollment for a student using another enrollment component, the units earned also defaults to the same value as units taken. Regardless of the enrollment component, you must adjust units earned on the Student Enrollment 1 page.</p> <hr/> <p>Note: Units earned can be entered at any time, although they do not apply to a student's transcript until the class is graded.</p>
Progress	<p>Indicates the number of units the system uses, in conjunction with the billing factor, to calculate billing units. The system also uses progress units to calculate academic load. The system by default sets the value of this field to the academic progress units value on the Class Associations page.</p>
Billing Units	<p>In Student Financials, all per unit term fees, per unit course fees, and per unit class fees are driven off of the billing units. Billing units are calculated for an enrollment record by multiplying the billing factor, which is set on the Class Associations page, and the academic progress units for the selected class. Because the system by default sets the billing factor 1, billing units are usually equal to academic progress units. The Student Enrollment 1 page is the only place where you can override billing units for an individual enrollment. For example, if you set the billing factor to 2 and the academic progress units to 3, the billing units would be 6. This would be multiplied by whatever amount per billing unit you establish in Student Financials. But if you want to discount the class for a specific student, you could change the billing units here on the Student Enrollment 1 page back to 3.</p>
FA Progress (financial aid progress)	<p>Indicates units towards financial aid progress.</p>

Field or Control	Description
Term History link	Click to access the Term History component, where you can view all of a student's term statistics for each term of the student's academic career, withdraw the student from the specified term or session, and more.
Enrollment Summary link	Click to access the Enrollment Summary component, where you can view a summary of a student's enrollment information and term statistics.
Save	Click to post enrollment immediately to the student's enrollment record.

Warning! The system performs no checks against your enrollment rules.

Related Links

[Processing Enrollment Transactions Through the Quick Enrollment Component](#)

[Viewing Student Statistics](#)

[Understanding the Three Repeat Checking Methods](#)

[Understanding Grading](#)

[Posting the Grade Roster](#)

[Defining Course Catalog Data](#)

[Adjusting Units](#)

Viewing Enrollment Transaction Information

Access the Student Enrollment 2 page (**Records and Enrollment > Enroll Students > Enrollment > Student Enrollment 2**).

This example illustrates the fields and controls on the Student Enrollment 2 page. You can find definitions for the fields and controls later on this page.

Student Enrollment 1		Student Enrollment 2		Student Enrollment 3		Student Enrollment 4		Last Enrollment Action	
Ana Beck		SR0400							
Term:	2003 Spr	Career:	Undergrad	Institution:	PeopleSoft University				
Find View All First 1 of 1 Last									
Class Nbr:	1003	Advanced Sculpture		Seminar					
Subject:	Art	Catalog Nbr:	145	Class Section:		1			
Academic Group:	College of Fine Arts		Undergrad	Session:		Regular			
Status / Reason:	Enrolled	Enrolled	Status Date:		11/19/2004				
Enrollment Add Date:	11/19/2004	Enrollment Drop Date:							
Grade Date:		Primary Program:		Liberal Arts Undergraduate					
Grading Basis Date:	11/19/2004	Repeat Date:				<input checked="" type="checkbox"/> Include in GPA <input type="checkbox"/> Audit Grading Basis <input checked="" type="checkbox"/> Earn Credit <input type="checkbox"/> Mandatory Grading Basis			
Grade Points Per Unit:	0.000		Repeat Scheme:		Undergraduate				
Grade Points:	0.000		Units Attempted:		In Progress				
Grading Scheme:	Undergraduate Grading Scheme								

Note: The system bases tuition calculation on the following dates. These dates are critical for initial billing as well as refunds.

<i>Field or Control</i>	<i>Description</i>
Enrollment Add Date	The date that you added the class section to the student's enrollment record.
Enrollment Drop Date	If you have dropped the student from the class section, the system displays the date that you processed the drop.
Grade Date	The date that you graded the student.
Primary Program	The student's primary academic program for the specified career and term combination.
Grading Basis Date	<p>The date that you last changed the grading basis on the Student Enrollment 1 page. If you have not changed the grading basis, the system sets this field to the date that you added the class section to the student's enrollment record. To avoid potential repeat checking problems, this date must always be greater than or equal to the session first date to enroll value. The repeat checking process uses this value to determine which effective-dated grading basis row to use for the student. This value is also available as a Student Financials fee calculation variable on the Equation Detail page.</p> <p>Note: The grade posting process does <i>not</i> reference this field to determine which grading basis row to use for grading. Instead, the grade posting process uses the term begin date.</p>

Field or Control	Description
Repeat Date	The date that you last changed the repeat code on the Student Enrollment 1 page.
Grade Points Per Unit	The system bases this value on the grade definition that corresponds to the grading basis and grade for this enrollment row. The system sets the value of this field to 0 until the student receives a grade for the class.
Repeat Scheme	The repeat scheme for the student's academic career, as defined on the Academic Career Table component. The repeat scheme controls how the system evaluates this course for repeat checking.
Grade Points	The system bases this value on the grade definition that corresponds to the grading basis and grade for this enrollment row. The value of this field equals the grade points per unit multiplied by the units taken.
Units Attempted	The status of the student's progress in the class. The units attempted value remains <i>In Progress</i> until the student receives a grade for the class, in which case the value updates to <i>Yes</i> .
Grading Scheme	The system displays the value of this field according to the grading scheme of the student's primary academic program for the specified academic career and term, as defined on the Academic Program Table component.
Include in GPA	The system displays the value of this field according to the grading basis on the Student Enrollment 1 page, as defined on the Grading Scheme Table page.
Audit Grading Basis	The system displays the value of this field according to the grading basis on the Student Enrollment 1 page, as defined on the Grading Scheme Table page.
Earn Credit	The system displays the value of this field according to the grading basis on the Student Enrollment 1 page, as defined on the Grading Scheme Table page.
Mandatory Grading Basis	The system selects this check box if the grading basis for the class is mandatory. The system clears this check box if the grading basis for the class is elective.

Adding Transcript Notes and Text

Access the Student Enrollment 3 page (**Records and Enrollment > Enroll Students > Enrollment > Student Enrollment 3**).

This example illustrates the fields and controls on the Student Enrollment 3 page. You can find definitions for the fields and controls later on this page.

The screenshot shows the 'Student Enrollment 3' page for student Ana Beck (SR0400) at PeopleSoft University. The student is enrolled in Class 1003 (Advanced Sculpture Seminar) in the 2003 Spring term. The enrollment status is 'Enrolled' with a reason of 'Enrolled' and a status date of 11/19/2004. The student's position is 'LAST' and the note ID is 'LAST' with the description 'Last Course Multi Term Sequenc'. The page also shows a transcript note section with a sequence number of 1 and a checkbox for 'Note From Incomplete Process'.

Field or Control	Description
Student Position	The student's enrollment position in the class section, which it uses for wait list processing.
Tuition Group	The tuition group to which this class section is tied. A tuition group is the shared characteristics among students. When you register students, the system automatically assigns them to the appropriate tuition groups. When you run the tuition calculation process, it sees that this class section is associated with the tuition group that you specify, and thus charges all students in the tuition group the fees for this class section of the course offering. You can tie all class sections of a course offering to a tuition group on the Course Catalog - Offerings page. You can tie specific class sections of a course offering to a tuition group on the Class Associations page.
Note ID	Select a standard transcript note for the class, if applicable.
Transcript Note	Enter additional free-form text about the specified transcript note. The system prints the text that you enter onto the student's transcript.
Transcript Note Sequence Nbr (transcript note sequence number)	Enter the sequence number of the transcript note. The sequence number indicates the printing order of the transcript notes that you specify.
Note From Incomplete Process	The system automatically selects this check box when the note is added during the incomplete/grade lapse process.

Related Links

[Running the Grade Lapse Process](#)

“Calculating Tuition for a Single Student” (Student Financials)

“Calculating Tuition for Multiple Students” (Student Financials)

Indicating Requirement Designation Options and Independent Study Instructors

Access the Student Enrollment 4 page (**Records and Enrollment > Enroll Students > Enrollment > Student Enrollment 4**).

This example illustrates the fields and controls on the Student Enrollment 4 page. You can find definitions for the fields and controls later on this page.

Student Enrollment 1		Student Enrollment 2		Student Enrollment 3		Student Enrollment 4		Last Enrollment Action	
Ana Beck				SR0400					
Term:	2003 Spr	Career:	Undergrad	Institution:	PeopleSoft University				
Find View All First 1 of 1 Last									
Class Nbr:	1003	Advanced Sculpture			Seminar				
Subject:	Art	Catalog Nbr:	145	Class Section:	1				
Academic Group:	College of Fine Arts		Undergrad	Session:	Regular				
Status:	Enrolled		Reason:	Enrolled		Status Date:	11/19/2004		
Grade Input:			Official Grade:						
Requirement Designation									
Designation:	<input type="text" value="HON"/>	<input type="button" value="🔍"/>	Honors			RD Option:	<input type="text" value="No"/>		
					RD Grade:	<input type="text"/>			
Independent Studies									
Instructor ID:	<input type="text"/>								

Related Links

[Processing Enrollment Transactions Through the Quick Enrollment Component](#)

Viewing Last Enrollment Action Information

Access the Last Enrollment Action page (**Records and Enrollment > Enroll Students > Enrollment > Last Enrollment Action**).

This example illustrates the fields and controls on the Last Enrollment Action page. You can find definitions for the fields and controls later on this page.

Student Enrollment 1		Student Enrollment 2		Student Enrollment 3		Student Enrollment 4		Last Enrollment Action	
Ana Beck		SR0400							
Term:	2003 Spr	Career:	Undergrad	Institution:	PeopleSoft University				
								Find View All First 1 of 1 Last	
Class Nbr:	1003	Advanced Sculpture		Seminar				+ -	
Subject:	Art	Catalog Nbr:	145	Class Section:		1			
Academic Group:	College of Fine Arts		Undergrad	Session:	Regular				
Status:	Enrolled		Reason:	Enrolled		Status Date:		11/19/2004	
Last Enrollment									
Action:									
Process:	Enrollment								
User ID:	PS								
ID:	KU0007	Locherty,Betty							

Field or Control	Description
Action	The last enrollment action taken for this student through the Enrollment component.
Process	The process used for the last enrollment action. The possible values for this field are <i>Enrollment</i> , which refers to this page; <i>Enrollment Request</i> , which refers to the enrollment engine; <i>Grade Post</i> , which refers to the grade posting process; and <i>Class Cancelled</i> .
User ID	The user ID of the user who performed the last enrollment action for this class enrollment.
ID	The individual ID of the user who performed the last enrollment action for this class enrollment.

(AUS) Entering HECS Data

Access the AUS Student Enroll page (**Records and Enrollment > Enroll Students > Enrollment > AUS Student Enroll**).

This example illustrates the fields and controls on the AUS Student Enroll page. You can find definitions for the fields and controls later on this page.

The screenshot shows the 'AUS Student Enroll' page for student Amali Peterson (SRAUS001) in the Spring 2005 term. The page is divided into several sections:

- Class Details:** Displays Class Nbr 1040, Subject Econ, Catalog Nbr 104, and Class Section 001. It also shows the Academic Group as Faculty of Economics and the Session as Regular Academic Session.
- Status:** The student's status is 'Enrolled'.
- Aus Enrollment Details:** This section contains several input fields:
 - HECS Band ID: 2 (Band 2)
 - HECS Band Charge: 300.00
 - HECS Load Factor: 0.12500
 - EFTSL Load: 0.12500
 - Student Career Nbr: 0
 - Cohort: 0000
 - Liability Status: 202
 - HECS Up-Front Discount
 - CAN Print Date
 - VET Course Assurance Indicator E619
 - VET Recognition of Prior Learning Code E577

Field or Control	Description
HECS Band ID	The system enters this value from the course catalog.
HECS Band Charge	The system enter the HECS band charge for the band ID.
HECS Load Factor	Enter the HECS load factor for this enrollment.
EFTSL Load	Enter the equivalent full-time student load for this enrollment.
Student Career Number	The system enters the value from the Student Term Activation page.
Cohort Year	The system enters this value from the Student Term Activation page.
Liability Status	The system enters this value from the Student Term Activation page.
CAN Print Date (Commonwealth Assistance Notice print date)	The date the CAN was printed for this student.
VET Course Assurance Indicator E619	Select to indicate whether the student’s enrollment in the unity of study is partially or fully covered by an approved course assurance arrangement.

Field or Control	Description
VET Recognition of Prior Learning Code E577 (RPL)	Select: <ul style="list-style-type: none"> • 1 to indicate the unit of study consists entirely of RPL. • 2 to indicate the unity of study has a component of RPL.

(CAN) Entering ESIS Student Data

Access the Cdn Student Enrollment page ((**Records and Enrollment > Enroll Students > Enrollment > Cdn Student Enrollment**)).

See [Defining PSIS Student Enrollment Data](#).

(NZL) Entering Funding Information

Access the NZL Student Enroll page (**Records and Enrollment > Enroll Students > Enrollment > NZL Student Enroll**).

This example illustrates the fields and controls on the NZL Student Enroll page. You can find definitions for the fields and controls later on this page.

The screenshot shows the 'NZL Student Enroll' page for student Ronald Bradley (SRNZL2001) at Silver Fern University. The page displays the following information:

- Term:** Aut 2005
- Career:** Undergrad
- Institution:** Silver Fern University
- Class Nbr:** 1002 (Intro to Financial Accounting) - Lecture
- Subject:** Acct
- Catalog Nbr:** 100
- Class Section:** 001
- Academic Group:** Faculty of Business
- Session:** Regular
- Status:** Enrolled
- Funding Source:** 03 (Full Fee Domestic Student)
- EFTS Factor:** 0.1250
- Course Classification:** 03 (Arts; Humanities; Social Sciences)
- Funding Category:** A2 (Arts & Soc Sci - Degree)

Field or Control	Description
Funding Source	The system enters this value from the student's program. Enter the funding source for the student's program on the Student Program page.
EFTS Factor	The system enters this value from the course catalog.

Field or Control	Description
Course Classification	<p>The system enters this value from the Acad Prog NZL (academic program New Zealand) page for course classifications defined with the type <i>Program</i>. For course classifications defined with the type <i>Course</i>, the system enters the value from the course catalog.</p> <p>Set up course classifications on the Course Classifications page.</p> <p>See Defining Course Classifications.</p>
Funding Category	<p>If the student's program has a course classification type of <i>Program</i>, the first character from the Academic Program table is concatenated with the second character of the course catalog value, otherwise the course catalog value is used.</p>

(NLD) Indicating Student Paper Information

Access the NLD Student Paper page (**Records and Enrollment > Enroll Students > Enrollment > NLD Student Paper**).

This example illustrates the fields and controls on the NLD Student Paper page. You can find definitions for the fields and controls later on this page.

Field or Control	Description
BRON Course ID	Select a BRON course ID to link to the student's end thesis.
Title Paper	Enter the title of the student's end thesis.
Result Paper	Select the result of the student's end paper. Values are <i>Adequate</i> , <i>Good</i> , and <i>Insufficient</i> .

Field or Control	Description
Grade Date	Enter the date the student received the grade for the end paper.
Application Paper	Enter whether the student completed the paper <i>In exam Year</i> , or, if not, whether the reason was <i>Dispensation</i> —meaning the student was excused from completing the paper— <i>Exchanged for Diploma</i> , or <i>Passed without Grade</i> .

Related Links

“Understanding BRON” (Recruiting and Admissions)

Processing Enrollment Transactions Through the Block Enrollment Feature

Important! Mass Change is a deprecated product. It is strongly recommended that you use Application Engine instead. For more information on Application Engine, see *PeopleTools: Application Engine*.

This section provides an overview of the Block Enrollment feature and discusses how to:

- Predefine student enrollment blocks.
- Predefine class enrollment blocks.
- Set class enrollment block defaults.
- Merge, retrieve, and post data for block enrollment requests.
- Create custom student enrollment blocks.
- Create custom class enrollment blocks.
- View block enrollment request details.
- Maintain detail for a student's block enrollment request.

Understanding the Block Enrollment Feature

Student Records provides robust functionality to process groups of enrollment requests at one time. These groups of enrollment requests are known as block enrollment requests. Through the Block Enrollment feature, you can merge a block of students with a block of classes and post these merged blocks as enrollment requests all in one procedure.

After merging student blocks with course blocks, you can opt to use the Block Enrollment component to retrieve and review this data before posting the block enrollment request.

Student and Class Enrollment Blocks

This section discusses how to predefine blocks of classes and blocks of students for use in the block enrollment request processing. You can predefine student blocks on the Block Enrollment Students page (add students one by one or use Population Selection), or you can predefine student blocks based on specified criteria using the Mass Change feature.

Later when you process a block enrollment request, you can merge blocks of classes with blocks of students and submit a single enrollment transaction. Because you store predefined blocks in your database when you save them, you can reuse the blocks for any later block enrollment request. This is especially useful in professional schools where all students enroll in the same classes year to year, or in certain undergraduate curricula where multiple classes are clustered as first year corequisites.

If you need to use the block of students or the block of classes only one time *and* you will not be editing the blocks at a later time, then as an alternative you can create custom blocks during processing.

Block Enrollment Requests

This section also discusses how to process block enrollment requests, which is done through the Block Enrollment component. The Block Enrollment component is the core of the block enrollment functionality. You can merge predefined student blocks with predefined course blocks, create and merge custom blocks of students and custom blocks of classes, or any combination of the two. When you run the Structured Query Report (SQR) process to perform the merge, the process combines the students in the student block with the courses in the course block, thus creating an enrollment request that contains all of the merged records. This enrollment request is keyed by an enrollment request ID.

When you are ready, you can, with the click of a button, process all of the individual enrollment requests included in the block enrollment request. Alternatively, you can note the enrollment request ID and run the enrollment posting process using the Mass Enrollment page. The button enables you to process block enrollment requests directly through the Block Enrollment component by Remote Call, while the Mass Enrollment component enables you to process block enrollment requests through Process Scheduler.

After running the posting process, use the Block Enrollment component to review the processing results to see whether each student got enrolled into the requested classes or whether the enrollment engine encountered errors. To correct errors, adjust each affected student's enrollment request or term record as necessary, save your changes, then post the block enrollment request again—either through the Block Enrollment component or the Mass Enrollment page.

Note: The Block Enrollment feature is *not* intended as a vehicle for converting historical enrollment records, nor should it be used as a vehicle to convert these records.

Mass Change and Enrollment Blocks

Note: You can create student blocks using Population Selection on the Block Enrollment Students page.

Using the Mass Change feature, you can create enrollment blocks based on specified criteria. Campus Solutions delivers the Create Student Block mass change type and Create Student Block mass change template, which you use to create a mass change definition. The Create Student Block mass change template contains the following fields:

- Academic plan
- Academic program

- Academic load
- Academic level - projected
- Term
- Total grade points

Using these fields you can select specific criteria by which to create a student enrollment block. For example, you can specify that the academic plan equals English, the academic program equals Liberal Arts Undergraduate, and the term equals 0550. When you run the mass change the system creates an enrollment block with every student active in program Liberal Arts Undergraduate, plan English, and term 0550. You also select default values for academic institution, academic career, student enrollment block, and definition. These are the key values for the enrollment block that you are creating.

Related Links

“Processing Mass Changes” (Campus Solutions Application Fundamentals)

Pages Used to Process Enrollment Transactions Through the Block Enrollment Feature

<i>Page Name</i>	<i>Definition Name</i>	<i>Navigation</i>	<i>Usage</i>
Block Enrollment Students	STDNT_BLOCK	Records and Enrollment > Enroll Students > Block Enrollment > Create Student Block > Block Enrollment Students	Define groups of students for block enrollment purposes. You can then merge blocks of students with blocks of classes by using the Block Enrollment component.
Block Enrollment Classes	CRSE_BLOCK	Records and Enrollment > Enroll Students > Block Enrollment > Create Class Block > Block Enrollment Classes	Define groups of classes for block enrollment purposes. You can then merge blocks of classes with blocks of students by using the Block Enrollment component.
Class Block Defaults	CRSE_BLOCK_DEFAULT	Click the Class Block Defaults link on the Block Enrollment Classes page.	Set defaults for each class that you add to the course block. You can set up defaults for the enrollment action, action reason, and enrollment overrides. Enrollment security is enforced so that you cannot override anything to which you do not have access.

Page Name	Definition Name	Navigation	Usage
Block Enroll Merge	BLOCK_ENROLL_MERGE	Records and Enrollment > Enroll Students > Block Enrollment > Block Enroll Merge > Block Enroll Merge	Create custom student blocks and course blocks, merge predefined or custom student blocks with predefined or custom course blocks, post block enrollment requests, and retrieve data and process results about merged blocks and posted blocks.
Create Custom Student Block	BLK_ENRL_STDNT_SEC	Click the Detail/Create link under the Student Block field on the Block Enroll Merge page.	Create a custom block of students to use for block enrollment. This feature enables you to enroll one or more students into a class or block of classes without having to predefine a student enrollment block on the Block Enrollment Students page, thus simplifying the block enrollment process. You can also use this feature to perform class maintenance where only a few students need changes to their enrollment records.
Create Customized Class Block	BLK_ENRL_CRSE_SEC	Click the Detail/Create link under the Class Block field on the Block Enroll Merge page.	Create a custom block of classes to use for block enrollment. This feature enables you to enroll students into one or more classes without having to predefine a class enrollment block on the Block Enrollment Classes page, thus simplifying the block enrollment process. You can also use this feature to perform class maintenance where only a few students need changes to their enrollment records.
Block Enroll Detail	BLOCK_ENRL_DETAIL	Records and Enrollment > Enroll Students > Block Enrollment > Block Enroll Merge > Block Enroll Detail	View, for a specific block enrollment request, a list of the student and class combinations that have been merged or that have been posted to the students' records. The list appears in grid format with a row for each student and class combination. These student and class combinations are term specific.

Page Name	Definition Name	Navigation	Usage
Block Enrl Detail1 (block enroll detail 1)	BLOCK_ENRL_DTL1	Records and Enrollment > Enroll Students > Block Enrollment > Block Enroll Merge > Block Enrl Detail1	Maintain the details of a block enrollment request for a specific student and class.
Block Enrl Detail2 (block enroll detail 2)	BLOCK_ENRL_DTL2	Records and Enrollment > Enroll Students > Block Enrollment > Block Enroll Merge > Block Enrl Detail2	Maintain the details of a block enrollment request for a specific student and class.

Predefining Student Enrollment Blocks

Access the Block Enrollment Students page (**Records and Enrollment > Enroll Students > Block Enrollment > Create Student Block > Block Enrollment Students**).

Field or Control	Description
Academic Institution	The academic institution to which the student enrollment block belongs. Select an academic institution upon entering the page.
Student Enrollment Block	Enter a description of the student enrollment block code.
ID	Select the identification code of the student you want to include in the group. The system prompts you with IDs from the STDNT_ID_SRCH table.
Academic Career	Select the student's academic careers that you want to include in the block. The system prompts you with values from the STDNT_CAREER table. This field is required whenever you select an ID.
Academic Program	Select the student's academic programs that you want to include in the block.
Add Merge Process	Click to access the Block Enrollment component, where you can process block enrollment requests. See Understanding the Block Enrollment Feature

Population Selection

The Population Selection group box is a standard group box that appears on run control pages when the Population Selection process is available or required for the transaction. Selection tools are available based on the selection tools that your institution selected in the setup of the Population Selection process for the application process and on your user security. Fields in the group box appear based on the

selection tool that you select. The fields behave the same way from within the group box on all run control pages and application processes. If your institution uses a specific delivered selection tool to identify IDs for a specific transaction, you must use it.

See “Using the Population Selection Process” (Campus Community Fundamentals)

Field or Control	Description
Selection Tool	Select <i>External File</i> or <i>PS Query</i> .
Query Name	<p>The following queries are delivered as samples:</p> <ul style="list-style-type: none"> SSR_STD_ENR_BLK_CAR_PROG (prompts on Institution, Academic Career, and Academic Program) SSR_STD_ENR_BLK_CAR_PROG_TRM (prompts on Institution, Academic Career, Academic Program, and Term) <p>When you create queries for use with Student Enrollment Blocks, you must use the bind record SSR_ENR_BLK_BND.</p>
Fill Student Block	Populates the student block grid with the results of the Population Selection query (EMPLID, Academic Career, and Academic Program (if this field is exposed). Rows can be deleted or added as needed.

Predefining Class Enrollment Blocks

Access the Block Enrollment Classes page (**Records and Enrollment > Enroll Students > Block Enrollment > Create Class Block > Block Enrollment Classes**).

This example illustrates the fields and controls on the Block Enrollment Classes page. You can find definitions for the fields and controls later on this page.

Block Enrollment Classes

Academic Institution: PSUNV PeopleSoft University
Class Enrollment Block: H1 ***Description:** History Blk 1

Find | View All First 1 of 5 Last

*Term:	*Action	Class Nbr	Grading Basis	Units	Crse Count	Related 1	Related 2
0390	Enroll	1332	GRD	3.00	1.00		

Action Dt Reason Drop if Enroll **Grade In** History 305 1
 01/02/2000 World History for Teachers
 Regular Undergrad

Transcript Note ID: Repeat Code: Instructor ID:

Overrides

Access ID: Full Class Enrollment Access

<input checked="" type="checkbox"/> Action Date	<input checked="" type="checkbox"/> Career	<input type="checkbox"/> Class Links	<input checked="" type="checkbox"/> Class Permission	<input checked="" type="checkbox"/> TimeConflict
<input checked="" type="checkbox"/> Appointment	<input checked="" type="checkbox"/> Closed Class	<input type="checkbox"/> Class Units	<input checked="" type="checkbox"/> Service Indicator	<input checked="" type="checkbox"/> Unit Load
<input type="checkbox"/> Dynamic Dates		<input type="checkbox"/> Grading Basis	<input checked="" type="checkbox"/> Requisites	<input type="checkbox"/> Wait List Okay

Requirement Designation

Ovr d Requirement Designation

Requirement Designation: Requirement Designation Option: Requirement Designation Grade:

<i>Field or Control</i>	<i>Description</i>
Academic Institution	The academic institution to which the class enrollment block belongs. Select an academic institution upon entering the page.
Class Enrollment Block	Enter a description of the class enrollment block code.
Class Block Defaults	Click to access the Class Block Defaults page, where you can set default values for security access overrides of enrollment functions. The overrides that you set on this page are used for each new class enrollment block detail that you enter.
Term	Select the term for which you want to enroll students in a specific class. Later on this page you specify the specific class in the Class Nbr field. You can add classes from multiple terms to the enrollment course block. Define terms on the Term Table page.
Add Merge Process	Click to access the Block Enrollment component, where you can process block enrollment requests.

Overrides

This group box contains multiple check boxes that identify what aspects of enrollment validation you want to override for this particular class enrollment block. Only overrides that you are authorized to access are available.

Related Links

[Setting Class Enrollment Block Defaults](#)

[Processing Enrollment Transactions Through the Quick Enrollment Component](#)

Setting Class Enrollment Block Defaults

Access the Class Block Defaults page (click the **Class Block Defaults** link on the Block Enrollment Classes page).

<i>Field or Control</i>	<i>Description</i>
Action	Select a value for this field to set the default enrollment action for the class enrollment block. The system by default sets the enrollment action to <i>Enroll</i> , but you can change this default value.
Reason	Select the reason for the enrollment action, such as whether the students are adding or dropping classes in this class enrollment block.

Overrides

This group box contains multiple check boxes that identify what aspects of enrollment validation you want to override for this particular class enrollment block. Only overrides that you are authorized to access are available.

<i>Field or Control</i>	<i>Description</i>
Access ID	The system displays the access ID, which describes the amount of enrollment access you have.
OK	Click to return to the Block Enrollment Classes page.

Related Links

[“Setting Up Enrollment Access IDs” \(Campus Solutions Application Fundamentals\)](#)

Merging, Retrieving, and Posting Data for Block Enrollment Requests

Access the Block Enroll Merge page (**Records and Enrollment > Enroll Students > Block Enrollment > Block Enroll Merge > Block Enroll Merge**).

With block enrollment, you can use any combination of custom student blocks and class blocks with predefined blocks. For example, you might have a predefined course block for first year law students that you want to merge with some late admits to the law school. Instead of predefining a student block for the new students, you might choose to merge the predefined course block for first year law students with a custom student block.

General Fields

<i>Field or Control</i>	<i>Description</i>
Enrollment Request ID	The system displays the identification number for the block enrollment request. As soon as you merge the student enrollment block with the class enrollment block, the system generates an enrollment request ID that is unique to the block enrollment request. The same number is assigned to each student and class combination in the block enrollment request.
Request Status	<p>The status of the block enrollment request:</p> <p><i>Errors:</i> The enrollment engine was unable to post the submitted enrollment request due to errors.</p> <p><i>Pending:</i> The request is pending submission for enrollment processing.</p> <p><i>Success:</i> The enrollment engine successfully posted the request.</p>

Merging Student and Class Enrollment Blocks

<i>Field or Control</i>	<i>Description</i>
Academic Institution	Select the academic institution for which you want to process this block enrollment request.
Student Block	<p>Select a predefined student enrollment block, or leave this field blank and click the Detail / Create link beneath the field to define a custom student enrollment block.</p> <hr/> <p>Important! If you create a custom student enrollment block, the system does not store the block for future retrieval.</p> <hr/>

Field or Control	Description
Detail / Create	<p>Click this link below the Student Block field either to view the detail for the student enrollment block that you selected, or to define a custom student enrollment block.</p> <p>To view the detail for a predefined student enrollment block, select a value for the Student Block field and then click this link. The system launches a new application window to display the Student Enrollment Block page. Edit the student block as necessary.</p> <p>To define a custom student enrollment block, leave the Student Block field blank and click this button. The system displays the Create Custom Student Block page, where you can define the students that you want to include in the student enrollment block.</p>
Class Block	<p>Select a predefined class enrollment block, or leave this field blank and click the Detail / Create link below the field to define a custom class enrollment block.</p> <hr/> <p>Important! If you create a custom class enrollment block, the system does not store the block for future retrieval.</p> <hr/>
Detail / Create	<p>Click this link below the Class Block field either to view the detail for the class enrollment block that you selected, or to define a custom class enrollment block.</p> <p>To view the detail for a predefined class enrollment block, select a value for the Class Block field, then click this link. The system launches a new application window to display the Class Enrollment Block page. Edit the class block as necessary.</p> <p>To define a custom class enrollment block, leave the Class Block field blank and click this button. The system displays the Create Customized Class Block page, where you can define the classes that you want to include in the class enrollment block.</p>

Field or Control	Description
Merge	<p>Click to run the SQR process that merges the student block with the class block. Your process request is scheduled in Process Scheduler. You can view the status of your merge using the process monitor. After the process completes the merge, the merge process updates the enrollment status of the block enrollment request to <i>pending</i> and the fields in the Merge Blocks group box become available for entry. You are now ready to retrieve and review the results of the merge process (optional) and post your block enrollment request, all of which can be done using the Block Enrollment component.</p> <hr/> <p>Note: The merge process combines student blocks with course blocks for all students in the student block, regardless whether a student activated in the term to which the class belongs. When you post the block enrollment request, if the enrollment engine encounters a student not activated in the term to which the class belongs, it cancels processing of that student's enrollment request and logs an error message. You can retrieve and view the error message through the Block Enrollment component.</p> <hr/>

Retrieving Data for Merged Blocks or Posted Block Enrollment Requests

Use the fields in the **Filtering Criteria** group box to retrieve the results of the merging process or the posting process. To narrow your search, enter specific filtering criteria.

Field or Control	Description
Academic Career	Select the academic career for which you want to retrieve detail for this block enrollment request. If you want to search for detail in all academic careers, leave this field blank.
Term	<p>Select the term for which you want to retrieve detail for this block enrollment request. If you want to search for detail in all terms, leave this field blank.</p> <hr/> <p>Note: If your filtering criteria include a term, you must enter an academic career value prior to selecting a term.</p> <hr/>

Field or Control	Description
Class Nbr (class number)	<p>If you want to retrieve detail for a specific class within this block enrollment request, select the class. Otherwise, leave this field blank to retrieve all classes within this block enrollment request.</p> <hr/> <p>Note: If your filtering criteria include a class number, you must enter the valid academic career and term prior to entering or searching for the class number.</p> <hr/>
	Click the Enter Search Criteria button to access the Basic Class Search page, where you can search the schedule of classes for the class that you want to retrieve.
Detail Status	<p>Select from the following choices the status of the block enrollment request for which you want to retrieve detail lines.</p> <p><i>None:</i> The system retrieves all detail lines within this block enrollment request.</p> <p><i>Errors:</i> The system retrieves all detail lines within this block enrollment request that the system was unable to post due to errors.</p> <p><i>Pending:</i> The system retrieves all detail lines within this block enrollment request that are pending submission for enrollment processing.</p> <p><i>Success:</i> The system retrieves all detail lines within this block enrollment request that the enrollment engine has successfully posted.</p>
ID	If you want to retrieve detail lines within this block enrollment request for a specific student, enter the student's ID.

Field or Control	Description
Retrieve	<p>Click to retrieve the results of the merging process or the posting process that match your filtering criteria. The system displays the Block Enroll Detail page, where you can view the results of your selection. If you want to view all detail lines within this block enrollment request, click this button without entering any filtering criteria. To narrow your search, enter values for any of the filtering criteria on the Block Merge Enroll page. For example, if you want to view only the errors found during the posting process, select <i>Errors</i> in the Detail Status field , then click this button.</p> <hr/> <p>Note: While you can view several thousand rows of merged data through the Block Enrollment component, it is possible to merge more data than the component can display. If you have merged more than several thousand rows of data, you should specify some filtering criteria before clicking the Retrieve button.</p> <hr/>

Posting Block Enrollment Requests

Field or Control	Description
Submit	<p>Click to process the block enrollment request for all detail lines within this block enrollment request. The enrollment engine posts all successful class enrollment requests to the appropriate student's enrollment record. Whenever you post a block enrollment request a subsequent time, the enrollment engine processes all requests within a block enrollment request that are not yet posted. The enrollment engine does <i>not</i> process detail lines within the block enrollment request that have already posted successfully.</p> <p>If you want to post the block enrollment request later, you can set up Process Scheduler to run the posting process automatically, or you can use the Mass Enrollment page to post the block enrollment request. To successfully complete a block enrollment request, however, you first must merge the student enrollment block with the class enrollment block on the Block Enroll Merge page.</p> <p>If any entry in the block enrollment request fails to post to the student's enrollment record, the entire block enrollment request has an error status because all requests within the block are tied to the same enrollment request ID. This, however, does <i>not</i> mean that everything was in error. Some detail lines within the block enrollment request might be successful, while some others have errors.</p> <p>To correct errors, adjust each affected student's detail line of the block enrollment request or term record as necessary, then post the block enrollment request again.</p>

Note: The posting process can handle as much data as you want to send to it. However, if the posting process takes too long to complete, you might get a remote call timeout error that prevents the process from completing successfully. The remote call timeout error depends on your timeout settings and the size of the batch you are posting. A system administrator can increase the timeout setting on the Remote Call tab of Configuration Manager. Alternatively, if the block enrollment request is too large, you can note the enrollment request ID and use the Mass Enrollment page to post the block enrollment request. The Mass Enrollment page uses Process Scheduler and is therefore not subject to remote call timeout errors.

Related Links

[Predefining Student Enrollment Blocks](#)

[Predefining Class Enrollment Blocks](#)

[Creating Custom Student Enrollment Blocks](#)

[Predefining Class Enrollment Blocks](#)

[Posting Mass Enrollment Requests](#)

[Searching for Classes](#)

Creating Custom Student Enrollment Blocks

Access the Create Custom Student Block page (click the **Detail/Create** link under the **Student Block** field on the Block Enroll Merge page).

Note: When you create a custom student enrollment block, the list of students that you enter is valid only for one-time merging of students into classes. After you run the merging process, you cannot retrieve the custom student enrollment block that you have created. Also, make sure that you have a finalized list of students before you create a custom student enrollment block because the only way to save your list after you enter it into the page is to run the merging process.

<i>Field or Control</i>	<i>Description</i>
ID	Select the identification code of the student you want to include in the custom student enrollment block. The system prompts you with IDs from the STDNT_ID_SRCH table.
Academic Career	Select the student's academic careers that you want to include in the block. The system prompts you with values from the STDNT_CAREER table. This field is required whenever you select an ID.
OK	When you have entered all of the students and their academic careers for this custom student enrollment block, click this button to return to the Block Enroll Merge page.

Creating Custom Class Enrollment Blocks

Access the Create Customized Class Block page (click the **Detail/Create** link under the **Class Block** field on the Block Enroll Merge page).

This example illustrates the fields and controls on the Create Customized Class Block page. You can find definitions for the fields and controls later on this page.

Block Enroll Merge

Create Customized Class Block

Academic Institution: PSUNV PeopleSoft University

Find | View All First 1 of 4 Last

*Term:	Action Reason	Class Nbr	Grading Basis Grade In	Units	Crse Count	Related 1	Related 2
0450	Enroll	1202	GRD	0.00	1.00		
				Math	20	1	
				Remedial Calculus			
				2001 Fall	Regular	Undergrad	

Overrides

Access ID: Full Class Enrollment Access **Override Service Indicator**

Override Action Date
 Override Class Limit
 Override Grading Basis
 Override Time Conflict

Override Appointment
 Override Class Links
 Override Permission
 Override Unit Load

Override Career
 Override Class Units
 Override Requisites
 Wait List Okay

Requirement Designation

Ovrd RD Designation:

RD Option: RD Grade:

Note ID:

Repeat:

Independent Studies

Instructor ID:

Note: When you create a custom class enrollment block, the list of classes that you enter is valid for only one-time merging of students into classes. After you run the merging process, you cannot retrieve the custom class enrollment block that you have created. Also, make sure that you have a finalized list of classes before you create a custom class enrollment block because the only way to save your list after you enter it into the page is to run the merging process.

<i>Field or Control</i>	<i>Description</i>
Term	Select the term for which you want to enroll students in a specific class. Later on this page, you'll specify the specific class in the Class Nbr field. You can add classes from multiple terms to the enrollment course block.
Overrides	This group box contains multiple check boxes that identify what aspects of enrollment validation you want to override for this particular class enrollment block. Only overrides that you are authorized to access are available.
OK	Enter the appropriate class data that you want to include in the custom class enrollment block, adding a new row for each class. Then click this button to return you to the Block Enroll Merge page.

Viewing Block Enrollment Request Details

Access the Block Enroll Detail page (**Records and Enrollment > Enroll Students > Block Enrollment > Block Enroll Merge > Block Enroll Detail**).

If the enrollment engine posting process encounters errors and cannot post the student's enrollment request, you can drill down to the enrollment request detail for any student and class combination found on the list to view the errors. Change the individual's enrollment request or career term record, then post the block enrollment request again.

<i>Field or Control</i>	<i>Description</i>
Enrollment Request ID	The system displays the identification number for the block enrollment request. As soon as you merge the student enrollment block with the class enrollment block, the system generates an enrollment request ID that is unique to the block enrollment request. The same number is assigned to each student and class combination in the block enrollment request. View an individual student's request within a block enrollment request through this component, or use this enrollment request ID to view an individual student request through the Enrollment Request and Quick Enroll components.
Seq # (sequence number)	Indicates the sequence in which the student and class combination resides in the block enrollment request. It is for internal processing purposes only.
ID	The identification number of the student to which this detail line of the block enrollment request relates.
Name	The name of the student to which this detail line of the block enrollment request relates.
Term	The term in which this detail line of the block enrollment request relates. A block enrollment request can have student and class combinations in multiple terms for the same student.
Career	The academic career to which this detail line of the block enrollment request relates.
Class Nbr (class number)	The specific class in which this detail line of the block enrollment request relates. Each class requested for a student appears on its own detail line.
Action	The enrollment action for the student's requested class.
Status	The enrollment status for the student's requested class.

Field or Control	Description
Detail	<p>After you merge a student enrollment block with a course enrollment block, click this button for a specific student and class combination to view and edit the details of that detail line of the block enrollment request. The system populates the Block Enrl Detail1 and Block Enrl Detail2 pages, then displays the Block Enrl Detail1 page for you to view the information.</p> <p>After you post the block enrollment request, you can click this button for a specific student and class combination to review the detail results of the enrollment posting process. If the detail line of the block enrollment request successfully posted to the student's record, you can view the details on the Block Enrl Detail1 and Block Enrl Detail2 pages (they are unavailable for edit). If the enrollment posting process encounters errors for any of the detail lines of the block enrollment request, you can view the message text about the errors, change the affected student's enrollment request or career term record as necessary, and then go to the Block Enroll Merge page and post the block enrollment request again.</p>

Note: If you encounter errors for multiple students in the block enrollment request and you want to override these errors, you must save the overrides for each student and class combination before proceeding to the next error.

Maintaining Detail for a Student's Block Enrollment Request

Access the Block Enrl Detail1 page (**Records and Enrollment > Enroll Students > Block Enrollment > Block Enroll Merge > Block Enrl Detail1**).

This example illustrates the fields and controls on the (AUS) Block Enrl Detail1 page. You can find definitions for the fields and controls later on this page.

Block Enroll Merge		Block Enroll Detail		Block Enrl Detail1		Block Enrl Detail2	
Enrollment Request ID:				0000001530			
Enrollment Request Find View All First 1 of 1 Last							
ID: SRAUS4000 Larsen,Joan Ray		Institution: PeopleSoft Australia Uni					
Career: Undergraduate		Primary Prog:		Term: Spring 01			
Seq #	Action	Class Nbr		Grading Basis	Related 1	Related 2	Permission
1	Enroll	2369	Acct 101	001T GRD	2368		
Action Dt		Reason		Grade In	Units Taken	Academic Program	
02/01/2001		Introduction to Accounting A		C	15.00	BCOM	
Request Status: Errors		User ID: SAMPLE					
Australian Data							
Student Career Nbr		0					
Liability Status							
Cohort Year		0000					
Overrides							
Access ID: Full Class Enrollment Access		<input type="checkbox"/> Service Indicator					
<input checked="" type="checkbox"/> Action Date	<input type="checkbox"/> Class Limit	<input type="checkbox"/> Grading Basis		<input type="checkbox"/> Time Conflict			
<input type="checkbox"/> Appointment	<input type="checkbox"/> Class Links	<input type="checkbox"/> Permission		<input type="checkbox"/> Unit Load			
<input type="checkbox"/> Career	<input type="checkbox"/> Class Units	<input type="checkbox"/> Requisites		<input type="checkbox"/> Wait List Okay			
Messages Find View All First 1 of 2 Last							
Message Sequence: 1		Severity: Error		Last Update DateTime: 05/03/05 3:16:13PM			
Non-associated related class component TUT; Enrollment did not take place. (14640,159) The related class section was not defined as part of the class association for the class components. The graded section was being defined as a single stand alone class component, but another related class component (perhaps defined as association 9999 and not associated to the graded section) is being used for this request. Remove the related course from the request or verify that the related section was not inadvertently left out when courses were established.							

Important! After you merge the student and class enrollment blocks but before you post the block enrollment request, you can use this page to edit each individual student's enrollment request. However, you *must* save your changes for *each* student and class combination of the block enrollment request prior to posting to have the changes included in the posting process.

(AUS) Australia Data

The system enters values in the **Student Career Nbr**, **Liability Status**, and **Cohort Year** fields from the student's primary academic program and term of enrollment.

Processing Enrollment Transactions Through the Enrollment Request Component

The Enrollment Request component has the exact same functionality as the Quick Enroll component. Transactions that you process through the Enrollment Request component can also be accessed through the Quick Enroll component and vice versa. You'll use the Enrollment Request component most often to enter enrollment information on a student-by-student basis either through an Interactive Voice Response (IVR) interface or through the pages themselves. You generate enrollment requests, which you can post

in the page or in a background process. The enrollment engine posting process validates the requests against all of the rules that you have created, such as rules for requisites and requirements. Depending on how you set up your enrollment security, you might be permitted to override just certain aspects of your enrollment rules, such as class limits or prerequisites.

Enrollment security plays an important role in defining who has access to add class enrollments to a student's enrollment record. Use the Update/Display mode to post unsuccessful enrollment requests or to view the enrollment request data.

This section discusses how to:

- Add or update student enrollment request transactions.
- Add transcript notes to enrollment requests.

Related Links

“Understanding Student Records Security” (Campus Solutions Application Fundamentals)

Pages Used to Process Enrollment Transactions Through the Enrollment Request Component

<i>Page Name</i>	<i>Definition Name</i>	<i>Navigation</i>	<i>Usage</i>
Enrollment Request	ENRL_REQUEST	Records and Enrollment > Enroll Students > Enrollment Request > Enrollment Request	Add or update enrollment request transactions for students.
Transcript Note	ENRL_REQ_NOTE	Click the Transcript Note link on the Enrollment Request page or the Create Transcript Note link on the Quick Enrollment page.	Add and update transcript notes on an enrollment request.
Access to Enrollment Functions	ENRL_REQ_ACCESS	Click the Operator Enrollment Access link on the Enrollment Request page or the View Enrollment Access link on the Quick Enrollment page.	View your security access to enrollment functions.

Adding or Updating Student Enrollment Request Transactions

Access the Enrollment Request page (**Records and Enrollment** > **Enroll Students** > **Enrollment Request** > **Enrollment Request**).

This example illustrates the fields and controls on the Enrollment Request page (1 of 2). You can find definitions for the fields and controls later on this page.

Enrollment Request

SR0400 Ana Beck
PeopleSoft University

Undergraduate
Liberal Arts Undergraduate
2003 Spring

Enrollment Request ID: 0000000000

User ID: PS

Status: Pending

[Operator Enrollment Access](#)

Submit

Enrollment Request Details Find | View All First 1 of 1 Last

Sequence Nbr: 1 Pending + -

*Action: Enroll Action Reason:

Override Action Date Action Date:

Wait List Okay

Class Nbr: 2071 Anthropolo 102 1 Lecture Intro to Anthropology

Regular Academic Session Undergraduate

Academic Program: LAU

Related Class 1:

Related Class 2:

Instructor ID:

Repeat Code:

[Transcript Note](#)

This example illustrates the fields and controls on the Enrollment Request page (2 of 2). You can find definitions for the fields and controls later on this page.

Override

Grading Basis: GRD Graded

Units Taken: 3.00

Designation:

Permission Nbr:

Grade Input:

Course Count: 1.00

Take Requirement Designation RD Grade:

Additional Overrides

Appointment

Requisites

Career

Service Indicator

Class Limit

Time Conflict

Class Links

Unit Load

Drop This Class if Enrolled:

Error Messages

Message Sequence:	Severity:	Last Update DateTime:

<i>Field or Control</i>	<i>Description</i>
User ID	The system displays the identification code of the user who created the enrollment request, providing you with a visible audit trail of the changes made to enrollment requests.

Copyright © 1988, 2024, Oracle and/or its affiliates.

1321

Field or Control	Description
Sequence Nbr (sequence number)	The system sets the sequence number to 1 and increases it by one for each class section added to the enrollment request. The number specifies the order in which the enrollment engine processes rows within the request.
End Date	<p>If an OEE enrollment transaction successfully posts to a student's enrollment record, the system displays the calculated end date of the OEE class. The enrollment process calculates the end date and all the other dynamic calendar dates for the student based on the OEE dynamic date rule assigned to the class. If no OEE dynamic date rule has been defined for the class, the enrollment process uses the rule established for the course offering. If no rule exists for the course offering, the enrollment process fails the transaction and the system returns an error message.</p> <p>You can view the other dynamic academic calendar dates that the enrollment process calculates for the student's OEE enrollment by clicking the academic calendar link on the Study List or by accessing the Student OEE Enroll Data page.</p>

Error Messages

Field or Control	Description
Message Sequence	The posting process displays a sequence number for each message that it writes to the message log for the corresponding request.
Severity	The posting process displays the severity of each message that it writes to the message log for the corresponding request. For example, if the posting process is unable to post a request due to errors, it displays a severity value of <i>Error</i> .
Last Update Date Time	The posting process displays the last date and time that it updated the message log for the corresponding request.
Message Text (unlabeled)	The posting process displays the message text and a detailed explanation of each message that it writes to the message log for the corresponding request. You can view and update messages in the Message Catalog within the appropriate message set.

Important! The remaining page elements are described in context of the Quick Enrollment page.

(AUS) Entering Australia Data

When enrolling students in an Australian institution, the **Australia Data** group box appears.

This example illustrates the Enrollment Request page, Australia Data group box.

Australian Data	
Student Career Nbr	<input type="text" value="0"/>
Liability Status	<input type="text" value="110"/> HECS-HELP Deferred pre2005
Cohort Year	<input type="text" value="2005"/> Cohort 2005

The system enters the field values on this page from the Student Term Activation page.

(NZL) Entering New Zealand Data

When enrolling students in a New Zealand institution, the **New Zealand Data** group box appears.

This example illustrates the Enrollment Request page, New Zealand Data box.

New Zealand Data	
Funding Source	<input type="text" value="FullFeeDom"/> Full Fee Domestic Student
Classification	<input type="text" value="03"/> Arts; Humanities; Social Sciences
Funding Category	<input type="text" value="A2"/> Arts & Soc Sci - Degree
EFTS Factor	<input type="text"/>

The system enters the field values on this page from the Course Catalog component.

Related Links

[Processing Enrollment Transactions Through the Quick Enrollment Component](#)

[Managing Wait Lists](#)

[Assigning and Maintaining Appointments for Individual Students](#)

[Viewing Student Statistics](#)

Adding Transcript Notes to Enrollment Requests

Access the Transcript Note page (click the **Transcript Note** link on the Enrollment Request page or the **Create Transcript Note** link on the Quick Enrollment page).

<i>Field or Control</i>	<i>Description</i>
Transcript Note ID	Select a standard transcript note for the class, if applicable.
Transcript Note	Enter additional free-form text about the specified transcript note. The system prints the text you enter onto the student's transcript.

<i>Field or Control</i>	<i>Description</i>
Tscript Note Nbr (transcript note number)	Enter the sequence number of the transcript note. The sequence number indicates the printing order of the transcript notes that you specify.

Processing Enrollment Transactions Through Self Service

If your institution has licensed Campus Self Service, your students can perform enrollment transactions directly over the web.

Related Links

“Understanding Self-Service Enrollment” (Campus Self Service)

Posting Mass Enrollment Requests

This section discusses how to post enrollment requests in mass.

Page Used to Post Mass Enrollment Requests

<i>Page Name</i>	<i>Definition Name</i>	<i>Navigation</i>	<i>Usage</i>
Mass Enrollment	RUNCTL_SRPCEMSS	Records and Enrollment > Enroll Students > Mass Enrollment > Mass Enrollment	Post a group of enrollment requests. Although enrollment processing is designed for you to generate and post requests online, Campus Solutions also provides this batch posting process as a means to speed data entry for registration officials who want to post large groups of enrollments at the same time rather than waiting for the enrollment engine to post each request at the time it is made.

Posting Enrollment Requests in Mass

Access the Mass Enrollment page (**Records and Enrollment > Enroll Students > Mass Enrollment > Mass Enrollment**).

You can also use the Mass Enrollment page to post block enrollment requests, especially larger requests that might be subject to a remote call timeout error if you were to click the **Post** button on the Block Enroll Merge page. Because the mass enrollment process uses Process Scheduler to post enrollment requests, you avoid possible remote call timeout errors.

Run the Mass Enrollment COBOL/SQL process (SRPCEMSS) as needed. All the rules checking (requisites, permissions, repeat checking, and so on) still occur.

Note: If you are using Program Enrollment or Activity Management, you must run the PSJob process (SREMSSJB).

See the Student Enrollment Event document in My Oracle Support (ID 1400723.1).

See [Managing APT Enrollment](#)

See [Understanding Activity Management](#)

Note: You should use the Mass Enrollment page and its corresponding process for converting historical enrollment records.

<i>Field or Control</i>	<i>Description</i>
From Enrollment Request ID and To Enrollment Request ID	Enter the start enrollment request ID in the From Enrollment Request ID field, and enter the last enrollment request ID to post in the To Enrollment Request ID field. Enrollment request ID values are generated by the system when you enter student enrollment requests. If you are entering only one enrollment request ID, such as for posting a single block enrollment request, enter the value in the From Enrollment Request ID field.

Working with Enrollment Request Messages

Acting on Enrollment Request Messages

This section lists the most frequent messages that the enrollment engine displays when you process an enrollment request, as well as the actions that you should take to resolve these messages. You can access the Message Catalog by navigating to **PeopleTools > Utilities > Use > Message Catalog**. In the English language, select message set number 14640.

<i>Number</i>	<i>Severity</i>	<i>Message Text</i>	<i>Explanation</i>	<i>Action</i>
3	Error	Not Enrolled in Class, Drop Not Processed.	The requested drop transaction was not processed. No enrollment records for the specified class for this term were found. Verify the class number and term, and resubmit the request.	Check the student's class schedule.
4	Error	Already In Drop Status.	The requested drop transaction was not processed. The class is already in drop status for the term specified. Verify the term and class number, and resubmit the request.	Check student's enrollment status in the class.
5	Error	Already Enrolled in Class, Add Not Processed.	The enrollment request was not processed; an enrollment record already exists for the class and term specified. Verify class number and term, and resubmit the request.	Check student's enrollment status in the class.

Number	Severity	Message Text	Explanation	Action
6	Error	Class %1 Not Enrolled, Class And Wait List Are Full.	The requested enrollment add was not processed. The enrollment limit for the class has been reached, and there is no room on the wait-list.	The class enrollment and wait-list capacities have been reached. Verify these limits on the Schedule of Classes - Enrollment Control page.
7	Error	Not Enrolled, Class %1 Full.	The requested enrollment add was not processed. The enrollment limit for the specified class has been reached. To attempt to wait-list, resubmit the request with the Wait List option selected.	The class enrollment capacity has been reached. Verify the enrollment limit on the Schedule of Classes - Enrollment Control page. The system also displays this message if the available space in the class is subject to reserve capacity requirements.
11	Error	Class Table In Use, Not Available For Drop Request.	The class table is being used by another system resource and is not available for the specified class. The drop request was not processed. Resubmit the request.	Another user is maintaining the class being dropped.
12	Error	Enrollment Record In Use, Not Available For Drop Request.	The Enrollment record is in use by another system resource and is not available to process the drop request. Try again later.	Another user or process is accessing the student's enrollment record.
13	Error	Unable to Drop class, will drop below required minimum units for enrollment.	The requested drop transaction was not processed.	Check the unit limits for the student's primary academic program on the Academic Program Table - Enrollment page.

Number	Severity	Message Text	Explanation	Action
14	Error	Unable to Drop class, Corequisites exist.	The requested drop transaction was not processed. Enrollment exists in a corequisite class. Classes must be dropped together.	The class being dropped is a corequisite to another class in the student's class schedule. Check the requisites for the other classes in the student's class schedule. Override requisites if necessary.
17	Error	Time Scheduling Conflict for class %1 and %2, not enrolled.	A scheduling conflict exists with a currently enrolled class. Select another class, or override the time conflict.	Refer to Explanation column.
18	Error	Requisites not met for Class, not enrolled.	Requirements have not been met to enroll in the specified class. The enrollment transaction was not processed.	Refer to Explanation column.
19	Error	Corequisites Not Met For Class, Not Enrolled.	Corequirements necessary to enroll in the class have not be met. The enrollment request was unsuccessful.	The class requires concurrent enrollment in another class. Check the requisites for this class. Override requisites if necessary.
20	Error	Class taken previously, Repeat not allowed.	None.	Review the repeat-for-credit rules for the class on the Course Catalog - Basic Data page.
29	Error	Class %1 Not Waitlisted, Waitlist is Full.	The Drop-To-Waitlist transaction was not processed.	Check the wait-list capacity for the class.
30	Error	Maximum term Unit Load exceeded.	Add transaction not processed. The maximum term unit load would be exceeded.	Check the unit limits for the student's primary academic program on the Academic Program Table - Enrollment page.
31	Error	Record Not Changed, Not on Waitlist	The Change-Waitlist-Position transaction was not processed.	The student is not wait-listed for this class.

Number	Severity	Message Text	Explanation	Action
32	Error	Enrollment is not allowed for this class: It is outside the Career of Study.	The Add transaction was not processed. Enrollment in this class is not allowed for this academic career.	The student's career has a career pointer rule, or the student's program references a career pointer exception rule, which prevents enrollment in this academic career.
36	Error	Error With Grade and Grade Basis For Penalty Drop Reason.	There is a setup error for drops with penalty. The grade is not compatible with the grade basis. Correct the setup. Drop not processed.	Check the drop-with-penalty setup on the Session Calendar 2 page or the Academic Program - Dynamic Date page for the student's primary academic program.
38	Error	%1 to Enroll in Class, Add Not Processed.	Consent is needed to enroll in the class. The add transaction was not processed.	The student must have a permission number to enroll in this class. A permission number can be generated, or a student-specific permission can be granted on the Class Permission page.
39	Message	Permission Number Entered Is Not Valid.	The permission number used is invalid. The transaction was processed without the permission number.	Check the Class Permissions page.
45	Message	Enrollment Drop Date is Past Drop With Penalty Date.	The enrollment drop date is past the pre-established drop with penalty date. Drop was processed as within drop with penalty date.	The class is being dropped after the drop-with-penalty or drop-with-greater-penalty deadline. The enrollment engine still processes the drop and uses the rule from last penalty date defined on the Session Calendar 2 page.
48	Error	Auto Enroll Not Processed, Section Not Associated with the Enrollment Section.	The class specified for the auto enrollment function is not associated with the enrollment section of the add transaction. Auto enrollment was not performed.	Check the setup on the Schedule of Classes component. All enrollment sections within the same class association must use the same component.

Number	Severity	Message Text	Explanation	Action
50	Error	Class Number %1 Not in Active Status. Cannot Enroll.	The add transaction was not processed. The class to be added is not in <i>ACTIVE</i> status for enrollment.	Verify the class status on the Schedule of Classes - Enrollment Control page.
53	Error	Related Class Enrollment Not Completed, Section Not Associated with Enrollment Section.	The related class enrollment function was not processed. The <i>related to</i> class is not associated with the enrollment section of the add transaction.	Check the setup on the Schedule of Classes component. All enrollment sections within the same class association must use the same component.
59	Message	Invalid Access to Override Class Limit.	User does not have access to override class limits. The transaction was processed without the override.	A user's enrollment access ID determines override access. The enrollment engine typically gives this message when an enrollment access group controls enrollment security. The enrollment access ID attached to the user's enrollment access group does not permit this override, or the user does not have time period access to the enrollment function. Check the setup on the Enrollment Group Access page.
60	Message	Invalid Access to Override Grade Basis.	User does not have access to override grade basis. The transaction was processed without the override.	See 59.
61	Message	Invalid Access to Override Class Units.	User does not have access to override class units. The transaction was processed without the override.	See 59.
62	Message	Invalid Access to Override Unit Load.	User does not have access to override unit load. The transaction was processed without the override.	See 59.

Number	Severity	Message Text	Explanation	Action
63	Message	Invalid Access to Override Class Links.	User does not have access to override class links. The transaction was processed without the override.	See 59.
64	Message	Invalid Access to Override Class Permission.	User does not have access to override class permission. The transaction was processed without the override.	See 59.
65	Message	Invalid Access to Override Requisites.	User does not have access to override requisites. The transaction was processed without the override.	See 59.
66	Message	Invalid Access to Override Time Conflict.	User does not have access override time conflicts. The transaction was processed without the override.	See 59.
67	Message	Invalid Access to Override Career.	User does not have access to override career. The transaction was processed without the override.	See 59.
68	Message	Invalid Access to Wait List Function.	User does not have access to the wait-list functionality. The transaction was processed without the override.	See 59.
69	Error	Invalid Access to Enrollment Transaction.	User does not have access to enrollment transaction. The transaction was not processed.	The enrollment access ID does not permit access to this function. Check the time period security for the access ID on the Enrollment Security Table page and the session time period deadline on the Session Time Period Table page.

Number	Severity	Message Text	Explanation	Action
70	Error	Invalid Access to Enrollment With Permission Transaction.	User does not have access to the Enrollment With Permission transaction. The transaction was not processed.	See 69.
71	Error	Invalid Access to Drop Transaction.	User does not have access to the drop transaction. The transaction was not processed.	See 69.
73	Error	Invalid Access to Update Grade Basis.	User does not have access to update grade basis. The transaction was not processed.	See 69.
74	Error	Invalid Access to Update Units.	User does not have access to update units. The transaction was not processed.	See 69.
75	Error	Invalid Access the Change Wait List Transaction.	User does not have access to the change wait-list transaction. The transaction was not processed.	See 69.
76	Error	Invalid Access to the Add Grade Transaction.	User does not have access to the add grade transaction. The transaction was not processed.	See 69.
77	Error	Invalid Access to Change Grade.	User does not have access to the change grade transaction. The transaction was not processed.	See 69.
78	Error	Class Table in Use, Not Available for Add Request.	The Class Table is being used by another process and is unavailable for updating. Retry request.	Another user or process is maintaining the class number used for the enrollment transaction.

Number	Severity	Message Text	Explanation	Action
79	Error	No Valid Appointment Found And Open Enrollment Period Has Not Begun.	The open enrollment period has not begun and no valid enrollment appointment was found. The enrollment request was not processed.	Use the Student Enrollment Appointment page to verify if the student has a valid appointment.
80	Error	Wait List Period Has Ended.	The wait-list request was not processed.	The last date for wait-list defined on the Session Table page has passed.
83	Error	Invalid Drop Date; Drop Date is Prior To Add Date.	The drop date entered is prior to the add date of the class being dropped. Re-enter the transaction with the correct date.	Verify the add date for the class. This error condition can occur when attempting to process a retroactive drop.
84	Error	Unit Limit Exceeded For Appointment Period.	The class add transaction was not processed. Adding the class would exceed the unit limit allowed for the appointment period.	Check the student's appointment limits using the Student Enrollment Appointment page.
85	Message	Invalid Access to Override Enroll Action Date.	User does not have access to override enroll action date. The transaction was processed without the override.	See 60.
86	Error	Swap not processed, Hold on record.	There is a hold on this record preventing the swap transaction from being processed. The hold must be removed before the swap is processed.	Check the student's service indicators.
87	Error	Hold on record, Add not processed.	There is a hold on this record, preventing the add from being processed. You must remove the hold to process the add transaction.	Check the student's service indicators.

Number	Severity	Message Text	Explanation	Action
88	Error	A Required Related Class (component %1) must also be Selected.	There is an additional component required for enrollment that is missing.	The class requires enrollment in a related component. Related components can be selected using the Related 1 and Related 2 fields.
89	Message	Invalid Access To Override Service Indicator	The user does not have access to override the service indicator. The transaction was processed without the override.	See 60.
90	Message	Invalid Access to Override Appointment Times.	The user does not have access to override the appointment times. The transaction was processed without the override.	See 60.
91	Error	Maximum Session Unit Load Exceeded.	The maximum session unit load would be exceeded with the addition of this class. The add transaction was not processed.	Check the student's session limits using the Student Enrollment Appointment page.
92	Error	Maximum Term Course Load Exceeded.	The maximum term course load would be exceeded with the addition of this class. The add transaction was not processed.	Check the unit limits for the student's primary academic program on the Academic Program Table - Enrollment page.
93	Error	Maximum Session Course Load Exceeded.	The maximum session course load would be exceeded with the addition of this class. The add transaction was not processed.	Check the student's course limit on the Student Enrollment Appointment page.
94	Error	Unable To Process Drop, Session Calendar Record Missing.	There is no Academic Session Calendar Record defined for the session of the drop transaction. A session must be defined to process the drop.	A session calendar row must be present to drop a regularly scheduled class. Check the academic calendar setup for the session on the Academic Calendar component.

Number	Severity	Message Text	Explanation	Action
97	Error	Maximum Session No GPA Units Exceeded.	The maximum session No GPA unit load would be exceeded with the addition of this class. The add transaction was not processed.	Check the student's session unit limits on the Student Enrollment Appointment page.
98	Error	Maximum Session Audit Units Exceeded.	The maximum session audit unit load would be exceeded with the addition of this class. The add transaction was not processed.	Check the student's session unit limits on the Student Enrollment Appointment page.
99	Error	Maximum Session Wait Units Exceeded	The maximum session wait unit load would be exceeded with the addition of this class. The add transaction was not processed.	Check the student's session unit limits on the Student Enrollment Appointment page.
100	Error	Maximum Term No GPA Units Exceeded.	The maximum term No GPA unit load would be exceeded with the addition of this class. The add transaction was not processed.	Check the unit limits for the student's primary academic program on the Academic Program Table - Enrollment page.
101	Error	Maximum Term Audit Units Exceeded.	The maximum term audit unit load would be exceeded with the addition of this class. The add transaction was not processed.	Check the unit limits for the student's primary academic program on the Academic Program Table - Enrollment page.
102	Error	Maximum Term Wait Units Exceeded.	The maximum term wait unit load would be exceeded with the addition of this class. The add transaction was not processed.	Check the unit limits for the student's primary academic program on the Academic Program Table - Enrollment page.
116	Message	Invalid Access to Override Requirement Designation.	The user does not have access to override the requirement designation. The transaction was processed without the override.	See 60.

Number	Severity	Message Text	Explanation	Action
120	Error	Appointment Audit Unit Limit Exceeded, Class Not Added.	Add transaction not processed. Adding this class would exceed the appointment audit unit limit.	Check the student's unit limits on the Student Enrollment Appointment page.
121	Error	Appointment No GPA Unit Limit Exceeded, Class Not Added.	Add transaction not processed. Adding class would exceed the appointment No GPA unit limit.	Check the student's unit limits on the Student Enrollment Appointment page.
123	Error	Maximum Term Load Exceeded, Units Not Changed.	Units not changed. The maximum term unit limit would be exceeded.	Check the unit limits for the student's primary academic program on the Academic Program Table - Enrollment page.
124	Error	Maximum Session Load Exceeded, Units Not Changed.	Units not changed. The maximum session unit load would be exceeded.	Check the student's session limits on the Student Enrollment Appointment page.
125	Error	Maximum Appointment Unit Load Exceeded, Units Not Changed.	Units not changed. The maximum appointment unit load would be exceeded.	Check the student's unit limits on the Student Enrollment Appointment page.
126	Error	Maximum No GPA Session Load Exceeded, Units Not Changed.	Units not changed. The maximum No GPA session unit load would be exceeded.	Check the student's session limits on the Student Enrollment Appointment page.
127	Error	Maximum Term No GPA Load Exceeded, Units Not Changed.	Units not changed. The maximum term No GPA load would be exceeded.	Check the unit limits for the student's primary academic program on the Academic Program Table - Enrollment page.
128	Error	Maximum Session Audit Load Exceeded, Units Not Changed.	Units not changed. The maximum session audit unit load would be exceeded.	Check the student's session limits on the Student Enrollment Appointment page.

Number	Severity	Message Text	Explanation	Action
129	Error	Maximum Audit Term Units Exceeded, Units Not Changed.	Units not changed. The maximum audit term units would be exceeded.	Check the unit limits for the student's primary academic program on the Academic Program Table - Enrollment page.
130	Error	Maximum Appointment No GPA Load Exceeded, Units Not Changed.	Units not changed. The maximum appointment No GPA unit load would be exceeded.	Check the student's unit limits on the Student Enrollment Appointment page.
131	Error	Maximum Appointment Audit Load Exceeded, Units Not Changed.	Units not changed. The maximum appointment audit unit load would be exceeded.	Check the student's unit limits on the Student Enrollment Appointment page.
133	Message	Permission to enroll in this class is required.	The class falls outside of the career of study.	The career pointer rules for the student's career or a career pointer exception rule for the student's primary academic program requires that the student have permission to take this class. Assign a permission number on the Class Permission page.
137	Error	Withdrawn from Term - Changes are not allowed	The transaction was not processed.	The student has been withdrawn for this term. Verify the student's status in this term on the Term History component.
138	Error	Warning - Enrollment status is Withdrawn.	Although enrollment status is <i>Withdrawn</i> , changes would be applied.	The enrollment engine gives this message when a grade change is made for a student who has been withdrawn from the term.
139	Error	Enrollment status is Cancelled for Term - No Enrollment Activity Allowed	Transaction not processed.	The student enrollment has been cancelled for this term. Verify the student's status in this term on the Term History component.

Number	Severity	Message Text	Explanation	Action
141	Message	The Requirement Designation Options was set to 'YES' by the enrollment process.	None.	This message appears when a student is enrolled in a class with an optional requirement designation and the Yes option was selected. The enrollment engine displays the same message when the requirement designation is required and is therefore set to <i>yes</i> for all students enrolling in the class.
142	Message	Only those with Academic Plan %1 are allowed to take Requirement Designation %2.	The enrollment process set the designation option to <i>NO</i> .	The enrollment engine displays this message when a student is enrolled in a class with an optional requirement designation and the Yes option is selected, but the student failed to meet the requirements for the requirement designation. The same message would appear for a non-optional requirement designation where the student does not meet the requirements.
143	Message	Class %1 is Full, Resectioned to Class %2	The selected class for enrollment is full; the request was processed with the resectioned class.	The enrollment engine displays this message when the Resection option is used in class enrollment control. The system enrolls the student in the resectioned section if the original choice is closed.

Number	Severity	Message Text	Explanation	Action
144	Message	A Grade of %1 has been assigned for this Drop Request.	The drop transaction assigned a grade to the student, leaving the student in <i>drop enrolled</i> status.	The class has been dropped during the drop-with-penalty or drop-with-greater-penalty period defined on the Session Calendar 2 page or the dates calculated by the Dynamic Class Dates process. For dynamically dated classes, use the Dynamic Class Dates page to view or maintain the dates. For OEE classes, use the Student OEE Enroll Data page.
146	Error	Multiple Enrollment not allowed for course, add not processed.	Multiple enrollment for this course is not allowed. The transaction was not processed.	A student can enroll in a the same course only once per term, unless the course permits multiple enrollments in a term (this option is set on the Course Catalog - Catalog Data page). The system also displays this message when a swap between different sections of the same course would result in a penalty grade on the swap from class.
160	Error	Requested change will put units below minimum Term Load. Not processed.	None.	As a result of a drop or swap transaction, the student will drop below the minimum units required by his or her academic program.
165	Warning	Auto Enroll sections used, related classes not used.	When specifying both auto enroll sections and related class sections, only the auto enroll sections are used for enrollment. The related classes were ignored.	

Number	Severity	Message Text	Explanation	Action
195	Message	First Date to Enroll has not been reached - not enrolled	The first date for enrollment has not been reached for the session or from the dynamic class data. Enrollment not allowed.	Check the Session Table page's First Date to Enroll field, or, for dynamically dated classes, the Dynamic Class Dates page.
196	Message	Last Date to Enroll has expired.	The last date for enrollment has expired for the session or from the dynamic class data. Enrollment not allowed.	Check the Session Table page's Last Date to Enroll field, or, for dynamically dated classes, the Dynamic Class Dates page.
197	Message	Student not eligible for enrollment in an OEE course	Student is attempting to enroll in an OEE course but neither the student's career nor student's primary academic program allows OEE enrollment.	The student's primary academic program does not permit enrollment into OEE classes. Verify that the Allow OEE Enrollment option is set correctly on the Academic Program Table component.
203	Message	OEE Date Calc Error: %1, %2.	The OEE date calculation routine has encountered a setup or data problem. Review the type of error in the message text. Enrollment was not processed.	The enrollment engine did not find an OEE dynamic date rule on the dynamic class dates table or at the course offering level. Review the course offering and dynamic class date setup for the class.
205	Message	Missing Drop Retain Reason Code	When dropping a course, the enrollment drop retain reason code was not defined from either the Academic Calendar Session, or, if dynamic dates or OEE enrollment are used, the drop retain reason code was not defined from the Academic Program table. The drop was not processed.	An enrollment action reason is required for drop/retain processing. Check the Session Calendar 2 page for regularly scheduled courses. For dynamically dated classes, including OEE classes, the drop/retain reason is entered on the Academic Program Table - Dynamic Dates page.

Number	Severity	Message Text	Explanation	Action
206	Error	Invalid access to the Requirement Designation Change Transaction	User does not have access to the change Requirement Designation transaction. The transaction was not processed.	See 69.
209	Error	Optional component class %1 is full. Resubmit without this component or waitlist all components.	The requested enrollment add was not processed. The enrollment limit for the specified class has been reached. To attempt to wait-list, resubmit the request with the wait-list option specified. To enroll in the class without the optional component, delete the optional component class number and resubmit.	To attempt to wait-list all components of the class, select the Wait List Okay check box and resubmit the request. To attempt to enroll in the class without the optional component, remove the optional component class number from the related class field and resubmit the request.
210	Error	Optional Related Class %1 add not processed. Class and Waitlist are full.	Optional related component is closed, and there is no room on the wait-list. To enroll in the class without the optional component, delete the optional component class number and resubmit.	To attempt to enroll in the class without the optional component, remove the optional component class number from the related class field and resubmit the request.
211	Error	Swap not allowed because the 'swap from' class would receive a penalty grade	This swap would result in a penalty grade for the swap from class, and the swap to class is a different section of the same course.	This message is given if the class does not allow multiple enrollments in a term.
212	Error	Class%1 already wait listed. Enrollment not processed.	Already wait-listed for this related component	The student needs to drop the wait-listed class before he or she can wait-list in another section with the same related non-enrollment section.

Number	Severity	Message Text	Explanation	Action
213	Error	Available Seats are reserved. Reserved Seat Requirements are not met. Student not enrolled	Available seats are subject to reserve capacity requirements.	Although the class may appear as open in Class Search, the remaining open seats are subject to one or more Reserve Capacity requirements.
214	Error	Permission is required to enroll in this class	This class is scheduled in a session that now requires permission to enroll in classes.	The Enrolment Time period for this session has passed, and students must now obtain instructor or department consent to enroll in classes.

Using Enrollment-Related Processes

Creating Historical Enrollment Records

This section discusses how to record historical enrollment records.

Pages Used to Create Historical Enrollment Records

<i>Page Name</i>	<i>Definition Name</i>	<i>Navigation</i>	<i>Usage</i>
Historical Course Enrollment	HIST_CRSE_ENROLLMT	Records and Enrollment > Enrollment Summaries > Historical Course Enrollment > Historical Course Enrollment	Record enrollment data when you do not have access to your Campus Solutions system, to your historical course catalog, and to a schedule of classes. When you use this page to convert historical enrollment records to Campus Solutions you will most likely run a Structured Query Report (SQR) or other such program to populate the application tables that supports this page. These application tables are HIST_TERM and HIST_TERM_ENRL. You can then access this page to make corrections as necessary.
Historical Course Enrollment - Transcript Text	HIST_CRSE_TRNS_TXT	Click the Transcript Text button on the Historical Course Enrollment page.	Enter free-form transcript text. This information, along with the historical enrollment information, appears on the student's transcript.

Recording Historical Enrollment Records

Access the Historical Course Enrollment page (**Records and Enrollment > Enrollment Summaries > Historical Course Enrollment > Historical Course Enrollment**).

<i>Field or Control</i>	<i>Description</i>
Academic Institution	Select the academic institution for which you want to record historical enrollment data for the student.

Field or Control	Description
Term	Select the term for which you want to record historical enrollment data for the student. The term that you select must be less than or equal to the last term for historical enrollment data for the specified academic career.
Enroll Seq (enrollment sequence)	Indicates the sequence in which a student enrolled in each course within a term. The system by default displays a chronological enrollment sequence number starting with 1, but you can override this default value for any row.
Subject Area	Select the subject area of the course for which you want to record historical enrollment data for the student.
Catalog Number	Enter the catalog number of the course for which you want to record historical enrollment data for the student. Because this is a standalone page, it has no connection to your current course catalog.
Units Taken	Enter the number of units that the student took for the course.
Units Passed	Enter the number of units that the student passed for the course.
Official Grade	Enter the official grade that the student received for the course.
Grade Points	Enter the grade points that the student received for the course.
Description	Enter the title of the course.
Transcript Text	Click to access the Historical Course Enrollment - Transcript Text page, where you can enter free-form transcript text. This information, along with the historical enrollment information, appears on the student's transcript.

Note: Courses entered on the Historical Course Enrollment page *do not* impact Academic Advisement's analysis processes or academic statistics. To include historical courses in advisement processes and academic statistics, you must treat them as transfer courses. Create a fictional academic institution, use the transfer credit process to create pseudo incoming courses, and then map those courses to your academic institution's course equivalencies.

Related Links

[Reviewing Examples of Course Equivalencies](#)

“Understanding Data Conversion” (Campus Solutions Application Fundamentals)

Managing Wait Lists

This section provides an overview of wait list management and discusses how to:

- View a student's wait list position.
- Move students from wait lists to enrollment.
- Purge students from wait lists.

Understanding Wait List Management

The wait list management functionality in Student Records enables you to set processing parameters that define the groups of students to move from wait lists to enrollment into classes within a specific enrollment period. This section discusses:

- Waitlist position numbers.
- Automatic enroll from waitlist.

Waitlist Position Numbers

When a student enrolls or is waitlisted into a class the Enrollment process assigns the next available student position number to the student. For instance, the first student to enroll in a class would get a student position number of 10, the second 20, the third 30, and so on. Student position numbers identify the order in which students enroll into a class. In addition, student position numbers determine the position students hold on the waitlist: the student with the wait list position number of 1 is the student who has the lowest student position number and an enrollment status of waiting.

For example, suppose Mia is the 31st student to try to enroll into a class with an enrollment capacity of 30. She is put on the wait list (has an enrollment status of waiting) and the Enrollment process gives her a student position number of 310. Her waitlist position number is 1, because she is the only student in the class with an enrollment status of waiting. Then a second student, Mitch, puts himself on the waitlist. The system gives him a student position number of 320. Because Mia has a lower student position number than Mitch, the system gives Mitch a waitlist position number of 2. If there is one seat available when you run the Waitlist process, Mia, the student with the lowest waitlist position number, is enrolled (the Enrollment process changes her enrollment status from waiting to enrolled). Mitch then has the lowest position number with an enrollment status of waiting. Therefore, his waitlist position number changes to 1.

In multiple component classes, the Enrollment process assigns students the next available student position number for each component. For this reason, a single student often has different waitlist position numbers for each component. For example, a student could have a student position number of 130 and a wait list position number of 1 for one component, and a student position number of 60 and a waitlist position number of 3 for the related component (depending on how many students were already enrolled and were on the waitlist for each component at the time the student received a student position number).

When the process runs on a class section, it creates an enrollment request. The enrollment request includes all related components of the class. For the enrollment engine to process an enrollment request successfully, all related components must have a seat available for that request. If all related components have a seat available for that request, the enrollment engine enrolls the student into all of the related

components. If at least one related component is full, the enrollment engine would produce an error for the request, and the student would not be enrolled into any of the related components.

Note: The Waitlist process runs on non enrollment components as well as on enrollment components. The process creates enrollment requests for students based on their positions on the waitlist in the section on which the process is running (which is not necessarily the enrollment component). Thus, the order in which the process runs on class sections is important, because the process might not enroll students in the order that they would expect, if they expect to be enrolled based on their waitlist position number in a section that was run after a related section.

You can run the Wait List process on a term, session, subject area, course, or class. The process runs on classes in sequential order based on the criteria on which you run the process, and on the key structure of the CLASS_TBL (course ID, course offering number, term, session code, and class section). For example, when you run the process on a term, the process first runs in order of course ID: 000001, 000002, and so on. If two courses have course ID 000001, it runs by course offering number: course 000001, course offering number 1, course 000001, course offering number 2, and so on. In the same way, the process would then use session code (unless you select session as one of your criteria on the Wait List Process page), and then class number. So within a course, course offering number, and session, the process would run on class section 1, class section 2, and so on. Because the Wait List process runs by class section, it would run on a multiple component class that has two lectures (sections 1 and 2) and two labs (sections 1A and 1B), in the following order: section 1, 1A, 1B, 2.

As you can see, the order of your classes and sections in the schedule of classes determine the order in which students are moved from the waitlist into the class for multiple component classes. Suppose you had two multiple component classes that shared a component, such as two biology lectures that share a lab, which have the following class sections: 1 (lecture), 1A (lab), and 2 (lecture). When you run the waitlist process on this class, the process creates enrollment requests for waitlisted students for section 1 and for its related class, section 1A. If seats are available in section 1 and 1A, the process moves students from the waitlist into both components. Then the process runs on section 1A (because section 1A is sequentially next based on the key structure of the CLASS_TBL). If students are still on the waitlist in section 1A (because they are on the waitlist for section 2, which has not yet been run), the process creates enrollment requests for those students. Again, if seats are available in section 1A and section 2, the enrollment engine processes the requests successfully. Finally, the process runs on section 2.

For example, Mia has a waitlist position number of 1 in section 2, and a waitlist position number of 5 in the related section 1A. Additionally, Mitch has a waitlist position number of 3 in section 1A. Because the Wait List process runs on section 1A first, Mia is put into the class after Mitch. The Wait List process evaluates Mia based on her position on the waitlist in section 1A, even though section 2 is the enrollment component.

Automatic Enroll from Waitlist Feature

The Wait List feature is controlled by the **Auto Enroll From Wait List** and **Wait List Capacity** options (on the Enrollment Control page of the schedule of classes) and the Last Day For Wait List date (on the Session Table page for classes with traditional academic calendars and on the Dynamic Class Dates page for classes with dynamic academic calendars). In addition, students have a wait list unit limit defined by academic load for terms and sessions within their primary academic programs on the Enrollment page and Session page of the Academic Program Table component.

If you select the **Auto Enroll From Wait List** option for a class, you can use the wait list process to move qualified students from the class wait list to enrollment into that class as space becomes available. If you do not select this option, you can manually move students from the wait list to enrollment into a class by

selecting **Override Class Limit** on the enrollment processing component. The manual process is best monitored by the instructor of the class.

As you manage your wait lists, you can use the Class Roster page to view students on the wait list for a particular class section. The system performs corequisite and prerequisite checking before placing a student on the waitlist. However, the system does *not* check for a scheduling time conflict before it places a student on a wait list. Scheduling time conflicts and all of the other enrollment edits are performed when the system attempts to move a student from the wait list to enrollment in a class. You can view an individual student's position and status on the wait list for a class by clicking the **Wait List Position** link. This link appears only for applicable enrollment requests on the enrollment request processing pages.

Enabling the Wait List Process

To enable the wait list process:

1. Set the last date for wait list for sessions on the Session Table page of the Term/Session Table component.
2. Define the maximum wait list units for terms within academic programs on the Enrollment page of the Academic Program Table component.
3. Define the maximum wait list units for sessions within academic programs on the Session page of the Academic Program Table component.
4. Select the **Auto Enroll From Wait List** check box for classes on the Enrollment Control page of the schedule of classes.

Related Links

[Viewing Class Rosters](#)

Pages Used to Manage Wait Lists

<i>Page Name</i>	<i>Definition Name</i>	<i>Navigation</i>	<i>Usage</i>
Wait List Position	ENRL_REQ_WL	Click the Wait List Position link on the corresponding enrollment processing page.	View a student's status and position on the wait list for a class section.
Wait List Process	RUNCTL_SRWTLST	Records and Enrollment > Term Processing > Waitlist > Waitlist Process > Wait List Process	Move groups of students from class wait lists to enrollment into classes. If you need to manually move students from the wait list to enrollment into a class, you must drop the student from the wait listed class then add the student into the class with the appropriate overrides selected.

Page Name	Definition Name	Navigation	Usage
Wait List Purge	RUNCTL_SRWLSTPURG	Records and Enrollment > Term Processing > Waitlist > Waitlist Purge > Wait List Purge	Run the Wait List Purge process to delete groups of students in waiting status based on the run parameters that you specify. The Wait List Purge process enables you purge the wait list for more than just one class. You can use the process to purge the wait list for all classes in an entire term, academic career, session, subject area, or campus based on your run parameters. Run the purge process on past terms when information about a student being waitlisted is no longer pertinent.

Viewing a Student's Wait List Position

If your institution has licensed PeopleSoft Campus Self Service, your students can also view their statuses and positions directly over the web. Wait list position numbers appear on the class schedule.

Related Links

“Viewing a Class Schedule” (Campus Self Service)

Moving Students from Wait Lists to Enrollment

Access the Wait List Process page (**Records and Enrollment > Term Processing > Waitlist > Waitlist Process > Wait List Process**).

Field or Control	Description
Institution	Select the academic institution for which you want to move groups of students from class wait lists to enrollment into a class.
Term	Select the term for which you want to move groups of students from class wait lists to enrollment into a class.
Session	If you want to limit wait list processing to a specific session, select a value.
Subject Area	If you want to limit wait list processing to a specific subject area, select a value. If you select a value for this field, the Course ID field and Class Nbr field become unavailable for edit.

Field or Control	Description
Course ID	If you want to limit wait list processing to a specific course, select a value. If you select a value for this field, the Subject Area field and Class Nbr field become unavailable for edit.
Class Nbr (class number)	If you want to limit wait list processing to a specific class, select a value. If you select a value for this field, the Subject Area field and Course ID field become unavailable for edit.
Wait List Process Switch	<p>The wait list process switch instructs the process how to evaluate wait list candidates. Select <i>Y</i> to process all <i>new</i> wait list candidates eligible for wait list evaluation. Select <i>A</i> to process <i>all</i> wait list candidates eligible for wait list evaluation.</p> <p>For example, a class has five students on the wait list and three spaces become open in the class. When you run the wait list process, it fills the three spaces, and two students remain on the wait list. At this point the class is no longer new to the wait list process. The only way it would be evaluated again is if space opened in the class and you selected <i>A</i> as the wait list process switch value.</p>
Run	Based on the Campus Solutions features that you are using, run either the Wait List COBOL/SQL process (SRPCWAIT) or the Wait List PSJob process (SRWAITJB).

SRPCWAIT Process

Run the Wait List COBOL/SQL process (SRPCWAIT) if you are *not* using Program Enrollment or Activity Management.

The process generates a new enrollment request for the student and displays one of the following enrollment status reasons on the new request: *RCAP* (reserve slots full), *FULL* (section is full), *CREQ* (corequisite enrollment), *ALIM* (appointment limit exceeded), *TLIM* (term limit exceeded), *SLIM* (session limit exceeded), *TIME* (time conflict exists), *RCMP* (related component), *TIMR* (time conflict resolved), or *EWAT* (enrolled from wait list). You can view these enrollment requests through the Block Enroll component.

If a class has reserve capacity rules and space opens in a reserve capacity group, the process evaluates whether students on the wait list meet these reserve capacity rules. If no students meet the rules, then the process moves no one from the class wait list to enrollment into the class. If a class has multiple reserve capacity groups and space opens in more than one group *and* a student matches the criteria of more than one reserve capacity group, the system enrolls the student into the first reserve capacity group it finds where the student meets the reserve capacity rules.

SRWAITJB Process

You must run the Wait List PSJob process if you are using Program Enrollment or Activity Management.

See the ‘Student Enrollment Event’ document in the Program Enrollment Additional Documentation pdf package in My Oracle Support (ID 1400723.1).

See [Managing APT Enrollment](#).

See [Understanding Activity Management](#).

Purging Students From Wait Lists

Access the Wait List Purge page (**Records and Enrollment > Term Processing > Waitlist > Waitlist Purge > Wait List Purge**).

<i>Field or Control</i>	<i>Description</i>
Sequence Number	The system displays a default sequence number. It is for internal processing purposes only.
Academic Institution	Select the academic institution for which you want to purge students from wait lists.
Term	Select the term for which you want to purge students from wait lists.
Academic Career	<p>If you want to purge students from wait lists for classes within a specific academic career, select a value for this field.</p> <hr/> <p>Note: This field and the remaining fields on this page are optional. They provide the means of searching for wait lists by various parameters.</p> <hr/>
Session	If you want to purge students from wait lists for classes within a specific session, select a value for this field.
Subject Area	If you want to purge students from wait lists for a specific class subject area, select a value for this field.
Class Nbr (class number)	If you want to purge students from wait lists for a specific class, select a value for this field.
Campus	If you want to purge students from wait lists for classes at a specific campus, select a value for this field.
From Date	If you want to purge from wait lists the students in waiting status with a class start date greater than or equal to a certain date, enter the date in this field.
To Date	If you want to purge from wait lists the students in waiting status with a class start date less than or equal to a certain date, enter the date in this field. The system displays, by default, the value in the From Date field.

Field or Control	Description
Last Date for Wait List	Enter a value in this field to have the process search for active wait lists in which the class <i>last date for wait list</i> value is less than or equal to the value that you specify here. Define last date for wait list values on the Session Table page for classes with traditional academic calendars.

Processing Withdrawals and Cancellations

This section provides an overview of withdrawal and cancellation processing, lists common elements, and discusses how to:

- Post withdrawals and cancellations for terms.
- Post withdrawals and cancellations for sessions.
- Resubmit failed withdrawal and cancellation requests.
- View withdrawal and cancellation request status.

Related Links

“Calculating Tuition for a Single Student” (Student Financials)

“Calculating Tuition for Multiple Students” (Student Financials)

Understanding Withdrawal and Cancellation Processing

In Student Records, you can enter and post withdrawals or cancellations for a term or session on a student-by-student basis through the Student Records Term Withdrawal COBOL/SQL process (SRPCWDPR). When you withdraw or cancel a student from a term, the process performs a series of session withdrawals or cancellations to complete the term withdrawal or cancellation. A student cannot be canceled from a session, and therefore a term, in which grades have been posted. The system prevents this with an error message and does so because enrollments for canceled terms and sessions are always excluded from the transcript. Withdrawals can be processed when grades are present; however, the classes with grades will be excluded from the process. A warning message appears when you select the withdrawal code for a session or term where grades are present.

Important! If you have not calculated the landmark calendar dates for the affected class enrollments, the Student Records Term Withdrawal process fails the entire withdrawal or cancellation request.

For term and session *withdrawals*, the Student Records Term Withdrawal process determines the deadline by comparing the last date of attendance entered on the Term Withdrawal or Session Withdrawal page to the withdrawal deadlines that you set on the Session Calendar 1 page or to the withdrawal deadlines that the Dynamic Class Dates process calculates and displays on the Dynamic Class Data page or Student Enroll OEE page. The Student Records Term Withdrawal process then generates and processes the enrollment requests for each impacted student enrollment record (STDNT_ENRL).

For withdrawals from traditional class enrollments, the process updates the impacted student enrollment records as follows:

- If the last date of attendance is less than or equal to the withdraw-without-penalty deadline on the Session Calendar 1 page, the process updates the last enrollment action reason to the withdraw-without-penalty reason set on the Session Calendar 1 page.
- If the last date of attendance is less than or equal to the withdraw-with-penalty deadline, the process determines the student's grading basis for the class, then assigns to the impacted student enrollment record the penalty grade value that is set on the Grading Scheme Table page for that grading basis.

If the penalty grade is not defined, the process assigns the penalty grade according to the grading basis and grade set on the Session Calendar 1 page. Depending on how the grade is set up, the process can reduce in progress units, which can potentially affect the student's academic load and financial aid load.

- If the last date of attendance is less than or equal to the withdraw-with-greater-penalty deadline, the process functionality parallels that of the withdraw-with-penalty functionality.

For withdrawals from dynamic date and OEE class enrollments, the process updates the impacted student enrollment records as follows:

- If the last date of attendance is less than or equal to the withdraw-without-penalty deadline on the Dynamic Class Data page or Student Enroll OEE page, the process updates the last enrollment action reason to the corresponding reason value set on the Dynamic Date page of the Academic Program Table component for the student's primary academic program.
- If the last date of attendance is less than or equal to the withdraw-with-penalty deadline on the Dynamic Class Data page or Student Enroll OEE page, the process determines the class grading basis, then assigns to the impacted student enrollment record the penalty grade value that is set on the Grading Scheme Table page for that grading basis.

If the penalty grade is not defined, the processes assigns the penalty grade according to the grading basis and grade set on the Dynamic Date page of the Academic Program Table component for the student's primary academic program. Depending on how the grade is set up, the process can reduce in progress units, which can potentially affect the student's academic load and financial aid load.

- If the last date of attendance is less than or equal to the withdraw-with-greater-penalty deadline on the Dynamic Class Data page or Student Enroll OEE page, the process functionality parallels that of the withdraw-with-penalty functionality.

Note: The system uses the session calendar (if it exists) when it fails to find a Dynamic Class Dates table row or the appropriate Academic Program table dynamic dates field when processing withdrawals from non-OEE dynamically dated classes.

Regardless of the enrollment and withdrawal types, the Student Records Term Withdrawal process also does the following for term and session withdrawals.

- Updates the withdraw code on the affected student session (STDNT_SESSION) records to a value of withdrew.
- Updates the withdraw code on the affected student career term (STDNT_CAR_TERM) records to a value of withdrew for term withdrawals only.

Note: The process does not update the student career term record for session withdrawals so that the student can still enroll in other sessions within the term.

For term and session *cancellations*, the cancel deadlines (Session, Dynamic Date, or OEE) are used only to provide a warning to the user because the cancellation process always has the same impact—any enrolled (but not graded) classes are dropped without penalty and the student's session and term (for term cancellations) withdraw codes are updated to Cancelled.

Note: Note. A student cannot be canceled from a session, and therefore a term, in which grades have been posted. The system prevents this with an error message and does so because enrollments for canceled terms and sessions are always excluded from the transcript.

Common Elements Used to Process Withdrawals and Cancellations

<i>Field or Control</i>	<i>Description</i>
Errors	If reasons exist that prevent a successful withdrawal or cancellation, click this link to access the Term Withdrawal Run Status page, where you can check the run status and error message text for the request.
Last Date of Attendance	The system by default sets the last date of attendance to the withdrawal/cancel date, but you can override the value. The Student Records Term Withdrawal process uses the last date of attendance to determine the deadlines, reasons, grading bases, and penalties for withdrawals from dynamic class date and OEE enrollments. The process also uses this date for financial aid and refund calculation purposes. If you override the last date of attendance value, you must recalculate the student's tuition based on the new date you enter.
Post Session Withdrawal	See definition for Post Term Withdrawal .

Field or Control	Description
Post Term Withdrawal	<p>Click to post the withdrawal or cancellation to the student's record.</p> <p>Before completing the posting request, the system verifies that the student has other enrollments for the term or session within the academic career. If the posting request causes the student to have no other enrollments in the term or session within the academic career, the system then identifies the student's billing careers on the student's career term record. If the student has a billing career that is the same as the academic career from which the student is withdrawing, the system stops processing the posting request and instructs you to change the student's billing career to an academic career in which the student has enrollments for the term or session. This edit prevents you from inadvertently billing a student based on an academic career in which the student has no enrollments for the term. Define a student's billing career by academic career on the Term Activation page.</p> <p>For example: a student is active in a term as both a graduate and undergraduate, and the student's billing career for both academic careers within the term is her or his undergraduate career. If the student is enrolled for classes in both the graduate and undergraduate career for the term and you attempt to withdraw the student from her or his undergraduate career for the term, the system stops processing and issues you a warning instructing you to change the billing career for that student's graduate career term record to an academic career other than the undergraduate career.</p> <hr/> <p>Note: If the Auto Calculate Term Withdrawal check box is selected for the term on the Tuition Calculation Controls page, then the Post Term Withdrawal button renders as Post Term Withdrawal and Calculate Tuition & Fees. When an administrative user posts a term withdrawal, tuition calculation runs, whether or not the user has Tuition Calculation security access. See "Specifying Tuition Calculation Parameters" (Student Financials)</p>
Success	<p>Click to access the Term Withdrawal Run Status page, where you can view the message log for the request.</p>

Field or Control	Description
Withdrawal \ Cancel	<p>Select whether you want to process a withdrawal or cancellation. Values for this field are delivered with your system as translate values. Do not modify these values in any way. Any modifications to these values require a substantial programming effort.</p> <p><i>Cancelled:</i> Select to cancel all of the student's class enrollments for the specified term or session. Posting a student's term cancellation request refunds 100% of her or his fees.</p> <p><i>Withdrew:</i> Select to withdraw the student from all class enrollment for the specified term or session. Posting a student's term withdrawal request refunds her or his fees according to the adjustment calendar associated with the student's tuition group.</p>
Withdrawal \ Cancel Date	Enter the date that the Student Records Term Withdrawal process uses as the action date for the withdrawal or cancellation.
Withdrawal \ Cancel Reason	Select the withdrawal/cancel reason that Student Financials uses for adjustments. Modification of these translate values requires significant programming effort.

Pages Used to Process Withdrawals and Cancellations

Page Name	Definition Name	Navigation	Usage
Term Withdrawal	WITHDRAWAL	Records and Enrollment > Student Term Information > Term History > Term Withdrawal	Process student withdrawals and cancellations for all sessions within an entire term.
Session Withdrawal	STDNT_SESSION_WDWL	Records and Enrollment > Student Term Information > Term History > Session Withdrawal	Process student withdrawals and cancellations for one session within a term rather than from all sessions within the entire term.

Page Name	Definition Name	Navigation	Usage
Term Withdrawal / Cancellation	RUNCTL_SRPCWDPS	Records and Enrollment > Term Processing > Withdrawal and Cancellation > Term Withdrawal/ Cancellation > Term Withdrawal / Cancellation	Resubmit failed term and session withdrawal or cancellation requests. The Withdrawal / Cancellation process is designed specifically to resubmit failed withdrawal requests. You can view the status of a request on the Term Withdrawal Run Status page. The process impacts Student Financials because withdrawals and cancellations affect tuition calculation.
Term Withdrawal Run Status	TERM_WD_RUN_STATS	Records and Enrollment > Term Processing > Withdrawal and Cancellation > Term Withdrawal Status > Term Withdrawal Run Status	View the status and process messages for enrollment requests generated by the withdrawal and cancellation process so that you can determine the changes that you must make to a request or a student's records To successfully post a request. You can also use this page as a record for all withdrawal and cancellation requests submitted through the Term History component.

Posting Withdrawals and Cancellations for Terms

Access the Term Withdrawal page (**Records and Enrollment > Student Term Information > Term History > Term Withdrawal**).

This example illustrates the fields and controls on the Term Withdrawal page. You can find definitions for the fields and controls later on this page.

Important! Posting a student's term cancellation request refunds 100 percent of the student's fees. Posting a student's term withdrawal request refunds her or his fees according to the adjustment calendar associated with the student's tuition group.

Note: Documentation about some fields on this page is provided in the earlier topic: Common Elements Used to Process Withdrawals and Cancellations.

Field or Control	Description
Academic Institution	The academic institution for which you want to process the student's withdrawal or cancellation request.
Term	The term for which you want to process the student's withdrawal or cancellation request.
Academic Level - Term Start	The student's academic level at the start of the specified term.
Pro-Rata Eligible	Select to enable pro-rata refunding—a refund to a student attending your academic institution for the first time and withdrawing on or before the 60 percent point in time. Clear this check box to not have the student considered for such a refund. Most U.S. academic institutions do not issue refunds after the 60 percent point in time.
Override Withdrawal Schedule	Select the override withdrawal schedule value. These values are specifically for refund calculations and are defined by Student Financials.

Related Links

[Viewing Withdrawal and Cancellation Request Status](#)

[Using the Term Activation Component](#)

“Recalculating Tuition and Fees After Enrollment Cancellation” (Student Financials)

“Setting Up Adjustment Calendars” (Student Financials)

Posting Withdrawals and Cancellations for Sessions

Access the Session Withdrawal page (**Records and Enrollment > Student Term Information > Term History > Session Withdrawal**).

This example illustrates the fields and controls on the Session Withdrawal page. You can find definitions for the fields and controls later on this page.

<i>Field or Control</i>	<i>Description</i>
Session	Select the session for which you want to process the student's withdrawal or cancellation request.
Units Taken for Progress	The system displays the student's in-progress units for the specified session.

Related Links

[Posting Withdrawals and Cancellations for Terms](#)

[Using the Term Activation Component](#)

Resubmitting Failed Withdrawal and Cancellation Requests

Access the Term Withdrawal / Cancellation page (**Records and Enrollment > Term Processing > Withdrawal and Cancellation > Term Withdrawal/Cancellation > Term Withdrawal / Cancellation**).

When the Term Cancellation process is run in the Student Financials application, that process generates a cancellation request. To process the cancellation request, enter the request number on this page and run the Student Records Term Withdrawal process (SRPCWDPR).

Field or Control	Description
From Term Withdrawal Request	Enter the request number for the beginning of the range of failed term withdrawal and cancellation requests that you want to resubmit for processing.
To Term Withdrawal Request	Enter the request number for the end of the range of failed term withdrawal and cancellation requests that you want to resubmit for processing.
Term Withdrawal Run Status	Click to access the Term Withdrawal Run Status page, where you can view the message log for a specific term withdrawal or cancellation request.

Run the Term Withdrawal COBOL/SQL process (SRPCWDPR) as needed.

Viewing Withdrawal and Cancellation Request Status

Access the Term Withdrawal Run Status page (**Records and Enrollment > Term Processing > Withdrawal and Cancellation > Term Withdrawal Status > Term Withdrawal Run Status**).

Related Links

[Acting on Enrollment Request Messages](#)

Purging Drop Enrollment Records

Class drops are kept in the student's academic record if a student drops from a course while the *drop retain record* date is defined on the academic calendar for the session in which the student was enrolled.

At some point, your institution might decide to purge the system of these retained drop enrollment records. The drop purge process affords you this functionality. Run the purge process on past terms only when information about a student's drop enrollment record is no longer pertinent.

Important! Running this process may have a financial impact on the student's account. It's highly recommended to consult with the bursar's office before using this process.

Page Used to Delete Drop Enrollment Records

<i>Page Name</i>	<i>Definition Name</i>	<i>Navigation</i>	<i>Usage</i>
Drop Purge Process	RUNCTL_SRDRPPURGE	Records and Enrollment > Term Processing > End of Term Processing > Drop Purge > Drop Purge Process	Run the Drop Purge SQR process (SRDRPPURGE) to delete drop enrollment records from your system based on the parameters you specify.

Deleting Drop Enrollment Records

Access the Drop Purge Process page (**Records and Enrollment > Term Processing > End of Term Processing > Drop Purge > Drop Purge Process**).

<i>Field or Control</i>	<i>Description</i>
Academic Institution	Select the academic institution for which you want to purge drop enrollment records.
Term	Select the term for which you want to purge drop enrollment records.
Sequence Number	The system displays a default sequence number. It is for internal processing purposes only. <hr/> Note: This field and the remaining fields on this page are optional. They provide the means of purging drop enrollment records by various parameters. <hr/>
Academic Career	If you want to purge drop enrollment records within a specific academic career, select a value.
Session	If you want to purge drop enrollment records within a specific session, select a value.
From Date	If you want to purge student enrollment records with a class start date (as defined on the CLASS_TBL) greater than or equal to a specific date, enter the date.
To Date	If you want to purge student enrollment records with a class start date (as defined on the CLASS_TBL) less than or equal to a specific date, enter the date.
Subject Area	If you want to purge drop enrollment records for a specific class subject area, select a value.

Field or Control	Description
Class Nbr (class number)	If you want to purge drop enrollment records for a specific class, select a value.
Campus	If you want to purge drop enrollment records at a specific campus, select a value.
Enrollment Status Reason	If you want to purge only the drop enrollment records that have a specific enrollment status reason attached to them, select the enrollment status reason. For example, you can purge drops that have an enrollment status reason of <i>Drop Wait</i> and that meet your other criteria. Enrollment status reasons appear in the Status/Reason field on pages within enrollment components.

Purging Shopping Cart Records

This section discusses how to purge Shopping Cart records.

Page Used to Purge Shopping Cart Records

Page Name	Definition Name	Navigation	Usage
Shopping Cart Purge	SSR_RUN_WSHLST_PRG	Records and Enrollment > Term Processing > End of Term Processing > Shopping Cart Purge	Run the Shopping Cart Purge application engine process (SSR_WSHLPRG) to purge Shopping Cart data for past terms.

Purging Shopping Cart Records

Access the Shopping Cart Purge page (**Records and Enrollment > Term Processing > End of Term Processing > Shopping Cart Purge**).

The Shopping Cart Purge page displays in a grid all existing rows in the Shopping Cart table (SSR_REGFORM) grouped by distinct institution, academic career and term combinations. Select the records that you want to purge and run the Shopping Cart Purge process.

Managing Post Enrollment Requirement Checking

Understanding Post Enrollment Requirement Checking Setup

Complete these steps to set up post enrollment requirement checking:

1. Define your enrollment requirements (See Setting Up Enrollment Requisites)
2. Attach enrollment requirements to course offerings and/or class association records.
3. Define student records installation related to enrollment requirements.
4. Define enrollment requirement note values.
5. Enroll students.

If you plan to use communications for post enrollment requirement checking, use the instructions in the following document to set up communications and then use the 3Cs process to create and generate the communication:

See: PERC Communications Setup and Processing.pdf in My Oracle Support (ID 1982691.1).

Related Links

[Defining Enrollment Requirements](#)

[Reviewing or Defining Student Records Installation Settings](#)

Managing the Enrollment Requirement Roster

This section discusses how to:

- Use the Enrollment Requirement Roster (Summary) page
- Track post enrollment requirement checking transaction history.

Pages Used to Manage Enrollment Requirement Rosters

<i>Page Name</i>	<i>Definition Name</i>	<i>Navigation</i>	<i>Usage</i>
Enrollment Requirement Roster (Summary)	SSR_REQS_RSTR_SUMM	Curriculum Management > Enrollment Requirements > Post Enroll Req Checking > Enrollment Requirement Roster > Enrollment Requirement Roster (Summary)	View the Enrollment Requirement Roster, track the enrollment requirement status of students, run post enrollment requirement checking, and process drop requests for non-compliance in on-line mode.
Enrollment Requirement Roster (Detail)	SSR_REQS_RSTR_DTL	Select the Detail View option on the Enrollment Requirement Roster (Summary) page.	View detailed information about how the status on the requirement was evaluated.
Enrollment Message Log	SSR_REQS_ENRL_MSG	Click the Process Status link on the Enrollment Requirement Roster (Summary) page.	View messages that are generated by the enrollment for the transaction requested.
Tracking of Key Transactions & User Notes	SSR_REQS_TRACKING	Click the Tracking link in the Audit / Information Links tab on the Enrollment Requirement Roster (Summary) page.	View post enrollment requirement checking transaction history and view and add notes.

Using the Enrollment Requirement Roster (Summary) Page

Access the Enrollment Requirement Roster (Summary) page (**Curriculum Management > Enrollment Requirements > Post Enroll Req Checking > Enrollment Requirement Roster > Enrollment Requirement Roster (Summary)**).

This example illustrates the fields and controls on the Enrollment Requirement Roster (Summary) page (1 of 2). You can find definitions for the fields and controls later on this page.

Enrollment Requirement Roster (Summary)

2010 Spring | Regular Academic Session | PeopleSoft University | Undergraduate

▼ CHEM 460 - 1 (3061)
 Biochemistry (Lecture)

Days and Times	Room	Instructor	Dates
Mo 4:00PM-5:00PM	TBA	Staff	01/24/2010 - 05/08/2010

▼ Enrollment Requirements:
 CHEM 460 is open only to Honors students who have completed CHEM 201 (3 units minimum grade of C) and a BIOLOGY 100 series course (3 units minimum grade of C)

Go To [Run Post Enrollment Requirement Checking](#) [Process Drops for Non-Compliance](#)

Enrollment Capacity 35 Review Complete for Batch Drop Processing

Select Display Option: Summary View Detail View

▼ Set Filter Options

Enrollment Status: filter

Display Enrolled (10) Waitlisted (0) Dropped (0)

Most Recent Requirement Status:

Display students in non-compliance Not Satisfied (3) Conditionally Satisfied (6)

Display other students Enrollment Component (0) Overridden (0)

Permitted (0) Satisfied (1) Unknown (0)

This example illustrates the fields and controls on the Enrollment Requirement Roster (Summary) page (2 of 2). You can find definitions for the fields and controls later on this page.

Enrolled Students
Customize | Find |
First 1-9 of 9 Last

Requirement Data
Audit / Information Links

	Select	ID	Name	Drop / Approved Indicator	Enrollment Req Status	Post Enroll Req Status	Status	Status Note
1	<input type="checkbox"/>	SR12446	Beale,Natalie	<input type="text" value=""/>	Conditional	Conditional	Enrolled	
2	<input type="checkbox"/>	SR12444	Campbell,Morgan	Drop Request	Conditional	Not Satisfied	Enrolled	PERC Drop - penalty grade
3	<input type="checkbox"/>	SR12442	Coldrick,Annie	<input type="text" value=""/>	Conditional	Conditional	Enrolled	
4	<input type="checkbox"/>	SR12445	Eley,Adam	Drop Request	Conditional	Not Satisfied	Enrolled	PERC Drop - penalty grade
5	<input type="checkbox"/>	SR12441	Hyde,Max	Drop Request	Conditional	Not Satisfied	Enrolled	PERC Drop - penalty grade
6	<input type="checkbox"/>	SR12449	Keen,Stephanie	<input type="text" value=""/>	Conditional	Conditional	Enrolled	
7	<input type="checkbox"/>	SR12443	Powell,Nicholas	<input type="text" value=""/>	Conditional	Conditional	Enrolled	
8	<input type="checkbox"/>	SR12448	Quinn,Abigail	<input type="text" value=""/>	Conditional	Conditional	Enrolled	
9	<input type="checkbox"/>	SR12447	Slocombe,Lewis	<input type="text" value=""/>	Conditional	Conditional	Enrolled	

[Select All](#) [Clear All](#) [Go to top](#)

notify selected students

Run Post Enrollment Requirement Checking

Run Post Enrollment Requirement Checking for selected students [run](#)

Set Drop Request Indicator for Students in Non-Compliance

If process results in a status of Conditionally Satisfied

If process results in a status of Not Satisfied

Process Drops for Non-Compliance

For students listed above, process drops for: [run](#)

selected students

students where Drop Request Indicator is selected

students with a post enrollment requirement status of: Conditionally Satisfied Not Satisfied

Override Action Date to:

The Course Information and Enrollment Requirements group boxes can be collapsed and expanded. Use the Student Records Installation-Enrollment Requirement Roster page to select a default appearance for the group boxes.

Click a class link to access the Class Detail page. View the enrollment requirements for the class as defined on Adjust Class Associations, Class Requisites page.

<i>Field or Control</i>	<i>Description</i>
Go To	The Go To links appear for page processing if the related check boxes— Allow Post Enrollment Requirement Checking to be run from Enrollment Requirement Roster and Allow Drop Processing to be run from Enrollment Requirement Roster —are selected on the Student Records Installation-Enrollment Requirement Processing page. Click the Go To links to access the related group boxes further down this page. If the check boxes are not selected on setup, the Go To links are not available.
Review Complete for Batch Drop Processing	This check box appears if the check box for Drop Review for Batch Processing is selected on the Student Records Installation-Enrollment Requirement Roster page. Select the check box to indicate that the post enrollment requirement status has been reviewed for non-compliant students—the batch drop process selects only those classes for which the check box has been selected.
Select Display Option	<p>The Enrollment Requirement Roster is available in two views: a summary view and a detailed view. Select the Summary View option to see the enrollment and post requirement status of students enrolled in the class. The Summary view page is discussed in this documentation.</p> <p>Select the Detail View option to see detailed information about how a student has or has not met the enrollment requirements for the class. The Post Enrollment Requirement Status area of the page displays status information based on the last time that post enrollment requirement checking was run for the student. The Detail view allows you to access the Audit and Information Links as found on the Summary view. You can also view or set the Drop Request /Approved indicator.</p>

Set Filter Options

The Set Filter Options group box can be collapsed and expanded. Use the Student Records Installation-Enrollment Requirement Roster page to select a default appearance for the group box.

The selections in this group box appear by default based on the setup page. You can change the selections here.

<i>Field or Control</i>	<i>Description</i>
Enrollment Status and Most Recent Requirement Status	Select the statuses that you want to view in the Enrollment Requirement Roster student grid.

<i>Field or Control</i>	<i>Description</i>
OEE Start Date	The OEE Start Date field appears when a class is scheduled within an OEE session. It is an optional field. Enter the date for which you want to filter students who have an OEE start date equal to or later than the defined date.

Field or Control	Description
<p>Most Recent Requirement Status: Display students in non-compliance and Most Recent Requirement Status: Display other students</p>	<p>The count for each status is shown in parentheses next to the status. Although the Enrollment Status count includes all students, the Most Recent Requirement Status count is based on the number of students with the selected Enrollment Status—for example, if you are viewing only Enrolled Students, the count shown for Most Recent Requirement Status includes only those students with an Enrollment Status of <i>Enrolled</i>.</p> <p>The statuses are:</p> <ul style="list-style-type: none"> • Not Satisfied: The student has not met the enrollment requirement status for the class. • Conditionally Satisfied: The student has conditionally met the enrollment requirement using in-progress course work. After the course work is completed and grades are posted, post enrollment requirement checking should be run to determine if the student has satisfied the enrollment requirement. • Enrollment Component: The student was enrolled using the enrollment component, which does not check for enrollment requirements. • Permitted: The enrollment requirement for the class was satisfied through a permission. <hr/> <p>Note: If the process is run for students with this status, the permission is not considered as part of the post enrollment requirement checking process. The student is re-evaluated.</p> <hr/> <ul style="list-style-type: none"> • Overridden: The enrollment requirement for this class was satisfied by using an enrollment requirement override. <hr/> <p>Note: If the process is run for students with this status, the override is not considered as part of the post enrollment requirement checking process. The student is re-evaluated.</p> <hr/> <ul style="list-style-type: none"> • Satisfied: The student has met the enrollment requirement for this class. • Unknown: No requirement status exists. This value typically appears when a requirement was added to the class after the student was enrolled or the student was enrolled in the class before post enrollment requirement processing was implemented.

Field or Control	Description
	<p>Note: Students who enrolled in classes before the implementation of the Post Enrollment Requirement Checking feature will not have an enrollment requirement status and will appear as Unknown on the Enrollment Requirement Roster.</p> <p>If you choose to run Post Enrollment Requirement Checking for the roster, the appropriate post enrollment requirement status will be assigned.</p>
Filter	Click the filter button to refresh the Enrollment Requirement Roster student grid.

Enrollment Requirement Roster Student Grid: Requirement Data Tab

Select the Requirement Data tab.

Field or Control	Description
Select	<p>Use this check box to:</p> <ul style="list-style-type: none"> • Select students to whom a notification is to be sent. • Select students to be included in page processing—run post enrollment requirement checking or process drops for non-compliance of enrollment requirements.
Process Status	<p>Sometimes a Process Status column appears between the Select and ID columns. Click the Process Status link to access the Enrollment Message Log page. Examples include when post enrollment requirement checking is run and the message displays information about the new status—for example, Enrollment Requirement is met conditionally. It is likely that this is due to a pending grade from a previous term. Another example is Enrollment Requirement is not met for the Class, action required. Enrollment Requirements for the class have not been met. The student may need to be administratively dropped from the class for non-compliance of enrollment requirements.</p>

Field or Control	Description
Drop/Approved Indicator	<p>This is an optional field. The field is available after post enrollment requirement checking has been run. The field is available only for students who have a non-compliant post enrollment requirement status of <i>Conditional</i> or <i>Not Satisfied</i> and an enrollment status of <i>Enrolled</i> or <i>Waitlisted</i>.</p> <p>Decision makers can set the indicator value to <i>Approved</i> for enrolled students if they consider the student should remain enrolled in the class even if the student's post enrollment status is non-compliant. An example might be if a cumulative GPA of 3.0 is required for the course and as a result of the student's grades from the previous term, the student now has a 2.9 GPA.</p> <p>Set the indicator value to <i>Drop Request</i> if an enrolled student is to be dropped from the class for non-compliance of enrollment requirements. If a student is wait listed, and the student should be dropped from the waitlist for non-compliance, set the value to <i>Drop Request</i>. Use the indicator if you will be dropping students using the option: <i>when Drop Request Indicator is selected</i>.</p>
Enrollment Req Status (Enrollment Requirement Status)	Displays the enrollment requirement status of a student at the point of registration. Click on the Enrollment Req Status link for a student to access the Enrollment Requirement Roster–Detail View with the enrollment requirement status information area expanded.
Post Enroll Req Status (Post Enrollment Requirement Status)	The post enrollment requirement status appears after the post enrollment requirement status checking process has been run. The process can be run multiple times. The value shown is the most current post enrollment requirement status. Click on the Post Enroll Req Status link for a student to access the Enrollment Requirement Roster–Detail View with the post enrollment requirement status information area expanded.
Status	This column appears only if more than one enrollment status is selected within the Set Filter Options group box. When more than one status is selected, the student's enrollment status appears in this field.

Field or Control	Description
Status Note	<p>This column displays additional information such as a student's wait list position, penalty grade, graded, previously waitlisted, withdrawn, and if the drop was initiated by PERC. For example, if a student is dropped through the Post Enrollment Requisite Checking process the status note reads <i>PERC Drop</i>.</p> <hr/> <p>Note: When a class is dropped using the action reason code of <i>PERC</i>, the enrollment record is retained regardless of the Academic Calendar date for the drop delete deadline.</p> <hr/>
notify selected students	<p>Click the Notify Selected Students button to access the Send Notification (SSS_NOTIFY) page to send email notifications to selected students. If a notification failure occurs, the sender receives a message indicating the type of failure, for example, host unknown. If no email account exists for a selected student, then on the Enrollment Requirement Roster, a Process Status column appears with the message <i>No Email Address</i> next to the student.</p>

Enrollment Requirement Student Grid: Audit / Information Links Tab

Select the Audit / Information Links tab.

This example illustrates the fields and controls on the Enrollment Requirement Roster (Summary) page: Audit / Information Links tab. You can find definitions for the fields and controls later on this page.

Enrolled Students							
Customize Find First 1-9 of 9 Last							
Requirement Data		Audit / Information Links					
	Select	ID	Name	Drop / Approved Indicator	Tracking	Course History	Statistics
1	<input type="checkbox"/>	SR12446	Beale,Natalie	<input type="text" value=""/>	Tracking	Course History	Statistics
2	<input type="checkbox"/>	SR12444	Campbell,Morgan	Drop Request	Tracking	Course History	Statistics
3	<input type="checkbox"/>	SR12442	Coldrick,Annie	<input type="text" value=""/>	Tracking	Course History	Statistics
4	<input type="checkbox"/>	SR12445	Eley,Adam	Drop Request	Tracking	Course History	Statistics
5	<input type="checkbox"/>	SR12441	Hyde,Max	Drop Request	Tracking	Course History	Statistics
6	<input type="checkbox"/>	SR12449	Keen,Stephanie	<input type="text" value=""/>	Tracking	Course History	Statistics
7	<input type="checkbox"/>	SR12443	Powell,Nicholas	<input type="text" value=""/>	Tracking	Course History	Statistics
8	<input type="checkbox"/>	SR12448	Quinn,Abigail	<input type="text" value=""/>	Tracking	Course History	Statistics
9	<input type="checkbox"/>	SR12447	Slocombe,Lewis	<input type="text" value=""/>	Tracking	Course History	Statistics

The **Select** check box and the ID, Name, Drop / Approved Indicator fields are carried over to this tab from the Requirement Data tab.

Field or Control	Description
Tracking	Click this link to access the Tracking of Key Transactions & User Notes page and view post enrollment requirement checking transaction history.
Course History	<p>This link is available if the Provide link to student Course History check box is selected on the Student Records Installation-Enrollment Requirement Roster page.</p> <p>Click to access the My Course History page as viewed from Student Self Service. Access is based on user security.</p> <p>See“Using Self-Service My Academics Functionality” (Campus Self Service)</p>
Statistics	<p>This link is available if the Provide link to Student Statistics check box is selected on the Student Records Installation-Enrollment Requirement Roster page.</p> <p>Click to access the Academics page as viewed from the Student Services Center or the administrative Term History component as defined on the Student Records Installation - Enrollment Requirement Roster page. Access is based on user security.</p> <p>See “Viewing and Editing an Individual's Information” (Campus Community Fundamentals)</p> <p>See Viewing Student Statistics.</p>

Run Post Enrollment Requirement Checking

This group box is available if the **Allow Post Enrollment Requirement Checking to be run from Enrollment Requirement Roster** check box is selected for Page Processing on the Student Records Installation-Enrollment Requirement Processing page.

Field or Control	Description
Set Drop Request Indicator for Students in Non-Compliance	<p>If the Allow Drop Request Indicator to be set for Students in Non-Compliance check box is selected on the setup page, use the options here to specify the circumstances under which a drop request indicator should be set for a student in non-compliance as a result of running post enrollment requirement checking.</p> <p>The check box settings appear by default from the setup page but you can change them here.</p>

Field or Control	Description
<p>If process results in a status of Conditionally Satisfied and If process results in a status of Not Satisfied</p>	<p>If the check box is selected, and post enrollment requirement checking results in a status of <i>Conditionally Satisfied</i> or <i>Not Satisfied</i> for a student, the process sets the drop request indicator for the student. If the check box is cleared, no indicator value is set.</p>

Process Drops for Non-Compliance

This group box is available if the **Allow Drop Processing to be run from Enrollment Requirement Roster** check box is selected for Page Processing on the Student Records Installation-Enrollment Requirement Processing page.

Field or Control	Description
<p>For student listed above, process drops for</p>	<p>Use these options to specify the selection criteria for dropping students for non-compliance of enrollment requirements. The post enrollment requirement checking process must be run before you process drops. The option settings appear by default from the setup page but you can change them here.</p>
<p>selected students</p>	<p>Select this option to drop only the selected students in the student grid.</p>
<p>students where Drop Request Indicator is selected</p>	<p>Select this option to drop only students in the student grid for whom the indicator is set to <i>Drop Request</i>.</p>
<p>students with a post enrollment requirement status of</p>	<p>Select this option for drops to be based on the post enrollment requirement status of the student. Select the Conditionally Satisfied check box to drop students in the student grid who have a post enrollment requirement status of <i>Conditionally Satisfied</i>. Select the Not Satisfied check box to drop students in the student grid who have a post enrollment requirement status of <i>Not Satisfied</i>. You can select one or both check boxes.</p>
<p>Override Action Date to</p>	<p>This check box is available if the Allow Override of Action Date check box is selected on the setup page. Select this check box and enter the action date for the transaction(s). You must have the relevant enrollment security to access this check box.</p>

Related Links

- [Reviewing or Defining Student Records Installation Settings](#)
- [Understanding Enrollment Requisite Setup and Maintenance](#)

Tracking Post Enrollment Requirement Checking Transaction History

Access the Tracking of Key Transaction & User Notes page (click the **Tracking** link in the Audit / Information Links tab on the Enrollment Requirement Roster (Summary) page.)

This example illustrates the fields and controls on the Tracking of Key Transaction & User Notes page.

Enrollment Requirement Roster

Tracking of Key Transactions & User Notes

ID: SR12444 Campbell,Morgan

Transaction History

Transaction	Transaction Status	Source / Type	User ID	ID & Name	Last Update DateTime
Last Post Req Check	Not Satisfied	Post Enrl Req Chk Batch	PS	KU0007 Dockett,Darnell James	02/16/11 10:00:08AM
Drop Requested		PERC Batch	PS	KU0007 Dockett,Darnell James	02/16/11 10:00:08AM
Enrollment	Conditional	Mass Enrollment	PS	KU0007 Dockett,Darnell James	02/16/11 8:01:58AM

Notes

*Note Type DROP Decision to Drop Student +

Notes Student's record was reviewed and decision was made to drop student for non-compliance. +

User ID PS

Empl ID KU0007

Name Dockett,Darnell James

DateTime

Use this page to view the post enrollment requirement checking transaction history for a student, including when a student enrolled, when post enrollment checking was run for the student, when a drop request/approved indicator was set for the student, when an administrative drop was processed and communications generated through 3Cs using the PERC communication category.

You can also add PERC related notes for a student. If the **Enable notes to be deleted** check box is selected on the Enrollment Requirement Roster setup page, you can delete notes.

Related Links

[Defining Enrollment Requirement Note Types](#)

Running Batch Post Enrollment Requirement Checking

This section discusses how to run batch post enrollment requirement checking for multiple classes.

Page Used to Run Batch Post Enrollment Requirement Checking for Multiple Classes

Page Name	Definition Name	Navigation	Usage
Run Post Enrollment Requirement Checking	SSR_REQS_RC_PER	Curriculum Management > Enrollment Requirements > Post Enroll Req Checking > Run Post Enrollment Req > Run Post Enrollment Requirement Checking	In batch mode, run post enrollment requirement checking for multiple classes.

Running Batch Post Enrollment Requirement Checking for Multiple Classes

Access the Run Post Enrollment Requirement Checking page (**Curriculum Management > Enrollment Requirements > Post Enroll Req Checking > Run Post Enrollment Req > Run Post Enrollment Requirement Checking**).

This example illustrates the fields and controls on the Run Post Enrollment Requirement Checking page (1 of 2). You can find definitions for the fields and controls later on this page.

Run Post Enrollment Requirement Checking

Run Control ID: PERC1 [Report Manager](#) [Process Monitor](#) Run

Select students using these conditions:

*Academic Institution: PeopleSoft University

*Term:

Select students with the following status:

Enrollment Status:

Select Enrolled Waitlisted

Most Recent Requirement Status:

Select students in non-compliance Not Satisfied Conditionally Satisfied

Select other students Enrollment Component Overridden

Permitted Satisfied Unknown

Action

Set Drop Request Indicator for Students in Non-Compliance

If process results in a status of Conditionally Satisfied

If process results in a status of Not Satisfied

This example illustrates the fields and controls on the Run Post Enrollment Requirement Checking page (2 of 2). You can find definitions for the fields and controls later on this page.

Population Selection

Population Selection
Selection Tool: [Edit Prompts](#)
Query Name: [Launch Query Manager](#) [Preview Selection Results](#)

Manual entry by class

Use Class Select [Clear List](#)

*Class Nbr	Subject	Catalog Nbr	Class Section	Title		
1	<input type="text" value="3059"/> SOC	100	1	Introduction to Sociology	+	-
2	<input type="text" value="1418"/> SOC	164	2	The Family	+	-

Transaction

Get / Refresh Last Request

Select students with the following status

The check box settings appear by default from the **Roster and Batch Processing Filter Default Settings** group box on the Student Records Installation-Enrollment Requirement Roster page but you can change them here.

Note: Because post enrollment requirement checking cannot be run for dropped students, an enrollment status of Dropped is not available for selection on this page.

Field or Control	Description
Enrollment Status	Select the enrollment statuses for which you are running post enrollment requirement checking.
Most Recent Requirement Status	<p>Select the most requirement statuses for which you are running post enrollment requirement checking. Typically the process is run for students with a status of <i>Not Satisfied</i> and <i>Conditionally Satisfied</i>.</p> <p>For documentation about the status values, refer to the previous documentation about the Enrollment Requirement Roster (Summary) page.</p>

Action

The Action group box is available if the **Allow Drop Request Indicator to be set for Students in Non-Compliance** check box is selected for batch processing on the Student Records Installation-Enrollment Requirement Processing page. The check box settings appear by default from the setup page but you can

change them here. Select one or both check boxes to indicate the statuses for which the batch process should set the Drop Request Indicator for non-compliant students.

Population Selection

Select this check box to run post enrollment requirement checking using population selection. Population selection is a method for selecting the IDs and/or courses to process for a specific transaction. The Population Selection group box is a standard group box that appears on run control pages when the Population Selection process is available or required for the transaction. Selection tools are available based on the selection tools that your institution selected in the setup of the Population Selection process for the application process and on your user security. Fields in the group box appear based on the selection tool that you select. The fields behave the same way from within the group box on all run control pages and application processes. If your institution uses a specific delivered selection tool (PS Query, Equation Engine equation, or external file) to identify IDs and/or courses for a specific transaction, you must use it.

“Understanding the Population Selection Group Box” (Campus Community Fundamentals)

“Using the Population Selection Process” (Campus Community Fundamentals)

Note: If you select the query using the catalog number, use wild cards to assist you with the query. For example, to search for all SOC 100 level courses, enter %1__ or _1%.

If the **Enforce Academic Organization Security** check box is selected on the Student Records Installation-Enrollment Requirement Roster page, academic organization security is also enforced for population selection.

Note: You can use population selection and/or class select. By default, the Population Selection and Use Class Select check boxes are cleared.

<i>Field or Control</i>	<i>Description</i>
Query Name	These predefined queries are delivered: <ul style="list-style-type: none"> • SSR_REQS_ACAD_GRP • SSR_REQS_ACAD_ORG • SSR_REQS_CAMPUS • SSR_REQS_CAREER • SSR_REQS_SESSION • SSR_REQS_SUBJECT • SSR_REQS_SUBJECT_CATNBR • SSR_REQS_TERM

Manual entry by class

<i>Field or Control</i>	<i>Description</i>
Use Class Select	Select this check box to run post enrollment requirement checking using class select.
Class Nbr class number	<p>Enter the class number for each class that is to be included in post enrollment requirement checking.</p> <hr/> <p>Note: To search for the catalog number using the look up prompt, use wild cards to assist you. For example, to search for Biology 100, enter %100% or _100.</p> <hr/> <p>If the Enforce Academic Organization Security check box is selected on the Student Records Installation-Enrollment Requirement Roster page, academic organization security is also enforced for manual entry by class.</p>

Transaction

After the process has completed, select the **Get/Refresh Last Request** button to access information about the process that was just run. Information includes the Enrollment Request ID (from Block Enrollment), the Request Status, the time that the process ran, the total number of transactions, the number of transactions in error, and the number of transactions with messages. You can click on the Enrollment Request ID to go directly to the Block Enrollment component for this group of transactions. This is of more importance when you run the drop process. The post enrollment requirement checking process just updates or assigns the students post enrollment requirement status.

Here is an example:

This example illustrates the fields and controls on the Transaction group box example. You can find definitions for the fields and controls later on this page.

▼ Transaction

Get/Refresh Last Request

Enrollment Request ID	0000002692	Number of Transactions	8
Request Status	Success/Messages	Transactions in Error	0
Last Update DateTime	02/18/2011 9:01:15AM	Transactions with Message	8

Printing Batch Enrollment Requirement Rosters

This section discusses how to print enrollment requirement rosters in batch.

Page Used to Print Enrollment Requirement Rosters in Batch

<i>Page Name</i>	<i>Definition Name</i>	<i>Navigation</i>	<i>Usage</i>
Print Enrollment Requirement Rosters	SSR_REQS_RC_RPT	Curriculum Management > Enrollment Requirements > Post Enrollment Req Checking > Print Enrollment Req Roster > Print Enrollment Requirement Rosters	In batch mode, print enrollment requirement rosters for multiple classes.

Printing Enrollment Requirement Rosters in Batch

Access the Print Enrollment Requirement Rosters page (**Curriculum Management > Enrollment Requirements > Post Enrollment Req Checking > Print Enrollment Req Roster > Print Enrollment Requirement Rosters**).

This example illustrates the fields and controls on the Print Enrollment Requirement Rosters page. You can find definitions for the fields and controls later on this page.

Print Enrollment Requirement Rosters

Run Control ID: PERC1 [Report Manager](#) [Process Monitor](#) Run

Select students using these conditions:

***Academic Institution:** PeopleSoft University

***Term:**

Select Display Option: Summary View Detail View Combined View

***Sort Option:**

Select students with the following status:

Enrollment Status:

Select Enrolled Waitlisted Dropped

Most Recent Requirement Status:

Select students in non-compliance Not Satisfied Conditionally Satisfied

Select other students Enrollment Component Overridden

Permitted Satisfied Unknown

Population Selection

Population Selection

Selection Tool: [Edit Prompts](#)

Query Name: [Launch Query Manager](#) [Preview Selection Results](#)

Manual entry by class

Use Class Select Clear List

*Class Nbr	Subject	Catalog Nbr	Class Section	Title		
1 <input type="text" value="3059"/> <input type="button" value="🔍"/>	SOC	100	1	Introduction to Sociology	<input type="button" value="+"/>	<input type="button" value="-"/>
2 <input type="text" value="1418"/> <input type="button" value="🔍"/>	SOC	164	2	The Family	<input type="button" value="+"/>	<input type="button" value="-"/>

<i>Field or Control</i>	<i>Description</i>
Select Display Option	Select Summary View to display the enrollment and post requirement status of the students in the class. Select Detail View to display detailed information about how a student has or has not met the enrollment requirements for the class. Select Combined View , to display first the summary view, followed by the detail view for each class.

Field or Control	Description
Sort Option	<p>Select the sort option to be used to display students <i>within</i> each class.</p> <hr/> <p>Note: The sort is always <i>within a class</i>, not across classes.</p> <hr/> <ul style="list-style-type: none"> • <i>1 - Name:</i> Sort students in a class by name order. • <i>2 - Enrollment Status, Name:</i> Sort students in a class by their enrollment status and then in name order within enrollment status. • <i>3 - Enrollment Status, Status Group, Name:</i> Sort students in a class by their enrollment status, then by their status group (non-compliant versus other students) within the enrollment status, and then by student name within the status group. <hr/> <p>Note: Status Group is non-compliant students versus other students.</p> <hr/> <ul style="list-style-type: none"> • <i>4 - Enrollment Status, Status Group, Requirement Status, Name:</i> Sort students in a class by their enrollment status, then by their status group (non-compliant versus other students) within the enrollment status, then by requirement status within each status group, and lastly by student name within each requirement status. • <i>5 - Status Group, Requirement Status, Name:</i> Sort students in a class by their status group (non-compliant versus other students), then by their requirement status within their status group, and then by student name within each requirement status.

For documentation about the Select students with the following status, Population Selection, and Manual Entry by Class group boxes, refer to similar documentation in an earlier section: *Running Batch Post Enrollment Requirement Checking for Multiple Classes*.

Processing Batch Drop Requests for Post Enrollment Requirements

This section discusses how to drop students in batch for non-compliance of enrollment requirements.

Page Used to Drop Non-Compliant Students in Batch

<i>Page Name</i>	<i>Definition Name</i>	<i>Navigation</i>	<i>Usage</i>
Process Drop Requests for Post Enrollment Requirements	SSR_REQS_RC_DRP	Curriculum Management > Enrollment Requirements > Post Enrollment Req Checking > Process Drop Requests > Process Drop Requests for Post Enrollment Requirement	In batch mode, process drops for students in non-compliance of enrollment requirements.

Dropping Non-Compliant Students in Batch

Access the Process Drop Requests for Post Enrollment Requirements page (**Curriculum Management > Enrollment Requirements > Post Enrollment Req Checking > Process Drop Requests > Process Drop Requests for Post Enrollment Requirement**).

This example illustrates the fields and controls on the Process Drop Requests for Post Enrollment Requirements page. You can find definitions for the fields and controls later on this page.

Process Drop Requests for Post Enrollment Requirements

Run Control ID: PERC1 [Report Manager](#) [Process Monitor](#) Run

Select students using these conditions:

***Academic Institution:** PeopleSoft University

***Term:**

Non-Compliance Selection

Enrollment Status:
 Select Enrolled Waitlisted

Drops will only be processed for classes where Drop Review is set to Complete

Process Drops for:
 students where Drop Request Indicator is selected
 students with a post enrollment requirement status of: Conditionally Satisfied Not Satisfied

Action

Override Action Date to:

Population Selection

Population Selection

Selection Tool: [Edit Prompts](#)

Query Name: [Launch Query Manager](#) [Preview Selection Results](#)

Manual entry by class

Use Class Select Clear List

*Class Nbr	Subject	Catalog Nbr	Class Section	Title		
1	<input type="text" value="3059"/> <input type="button" value="🔍"/> SOC	100	1	Introduction to Sociology	<input type="button" value="+"/>	<input type="button" value="-"/>

Transaction

Get / Refresh Last Request

Non-Compliance Selection

The check box settings appear by default from the Student Records Installation setup pages but you can change the settings here.

Note: Because there is no need to process drops for students who have already dropped the class, the *Dropped* enrollment status is not available here.

Field or Control	Description
Enrollment Status	Select only the enrollment statuses that you want included in the processing for non-compliance of enrollment requirements.
Drops will only be processed for classes where Drop Review is set to Complete	If the Enrollment Requirement Rosters must be reviewed prior to batch processing of drops check box is selected on the Student Records Installation-Enrollment Requirement Roster page, this message appears.
Process Drops for	Select the option for which you want to process drops: either students for whom the Drop Request Indicator is selected or students with a non-compliant post enrollment requirement status. If you select the status option, the Conditionally Satisfied and Not Satisfied check boxes become available and you can select one or both.

For documentation about the Action, Population Selection, and Manual Entry by Class group boxes, refer to similar documentation in the earlier section: *Running Batch Post Enrollment Requirement Checking for Multiple Classes*.

Running the Batch Drop Process

From the Process Scheduler Request page, you can select one of two options:

- **Generate and Process Drops (SRRQDROP):** Full processing in which the drop transactions are generated and then the drops are processed.
- **Generate Drop Transactions (SSR_REQS_DRP):** The drop transactions are generated but the drops are not processed—use this option if you want to review the transactions in the Block Enroll component before processing drops.

Transaction

After the process has completed, select the **Get/Refresh Last Request** button to access information about the process that was just run. Information includes the Enrollment Request ID (from Block Enrollment), the Request Status, the time that the process ran, the total number of transactions, the number of transactions in error, and the number of transactions with messages.

Click on the Enrollment Request ID to go directly to the Block Enrollment component for this group of transactions. You are taken to the Block Enroll Detail page. View the Status column for any transactions in error. Or, to view only errors, click on the Block Enroll Merge tab and under Filtering Criteria, set **Detail Status** to *Errors*, and click the **Retrieve** button. You are taken back to the Block Enroll Detail page—however only those transactions with errors appear. Click on the detail link for further information and decide if you want to resolve any transaction issues.

You can view an example of the Transaction group box in the earlier section: *Running Batch Post Enrollment Requirement Checking for Multiple Classes*.

Defining Enrollment Requirement Note Types

This section discusses how to define enrollment requirement note types.

Page Used to Define Enrollment Requirement Note Types

<i>Page Name</i>	<i>Definition Name</i>	<i>Navigation</i>	<i>Usage</i>
Define Enrollment Requirement Note Type	SSR_REQS_COMTYP	Curriculum Management > Enrollment Requirements > Post Enrollment Req Checking > Define Enrollment Req Note > Define Enrollment Requirement Note Type	Define note types to be used on the Enrollment Requirement Roster-Tracking of Key Transactions & User Notes page.

Purging Post Enrollment Requirement Data

This section discusses how to purge post enrollment requirement data.

Page Used to Purge Post Enrollment Requirement Data

<i>Page Name</i>	<i>Definition Name</i>	<i>Navigation</i>	<i>Usage</i>
Purge Post Enrollment Requirement Data	SSR_REQS_RC_PRG	Curriculum Management > Enrollment Requirements > Post Enrollment Req Checking > Purge Post Enroll Req Data > Purge Post Enrollment Requirement Data	Use population selection or manual entry by class to purge post enrollment requirement data that is no longer necessary to store within the system.

Purging Post Enrollment Requirement Data

Access the Purge Post Enrollment Requirement Data page (**Curriculum Management > Enrollment Requirements > Post Enrollment Req Checking > Purge Post Enroll Req Data > Purge Post Enrollment Requirement Data**).

This example illustrates the fields and controls on the Purge Post Enrollment Requirement Data page. You can find definitions for the fields and controls later on this page.

Purge Post Enrollment Requirement Data

Run Control ID: PERC1 [Report Manager](#) [Process Monitor](#) Run

Selection Criteria

*Academic Institution: PeopleSoft University

*Term:

Population Selection

Population Selection

Selection Tool: [Edit Prompts](#)

Query Name: [Launch Query Manager](#) [Preview Selection Results](#)

Manual entry by class

Use Class Select Clear List

*Class Nbr	Subject	Catalog Nbr	Class Section	Title		
1	<input type="text" value="3028"/> <input type="button" value="🔍"/> BUSADM	620	1	Corp Strategy II	+	-

Note: Purging should be done with caution. If you purge post enrollment requirement data for previous terms, the affected records will be deleted from the following tables:

- SSR_REQS_HEADR: holds the enrollment requirement status and post enrollment requirement status.
- SSR_REQS_RSLTS: holds the requirement status of the requirement group line and requirement line level.
- SSR_REQS_CRSEU: holds the course work that was used to identify the status of the requirement group line or requirement line.
- SSR_REQS_COMM: holds the notes data.
- SSR_REQS_ACTN: holds the drop request or approval action.
- SSR_REQS_CLASS: holds the drop review flag.

For documentation about the fields on this page, refer to the documentation about similar fields in the earlier section: *Running Batch Post Enrollment Requirement Checking for Multiple Classes*.

Using Enrollment Web Services

Understanding Enrollment Web Services

Enrollment Web Services support self-service enrollment regardless of the user interface through which students interact with an institution. Any user interface that is web-service enabled and SOAP compliant can access EWS.

For detailed information about EWS, see [Enrollment Web Services Developers Guide](#) and [Enrollment Web Services Users Guide](#) in My Oracle Support (ID 1371391.1).

Chapter 41

Managing Program Planning and Enrollment

Understanding the Academic Progress Tracker

The Academic Progress Tracker (APT):

- Records the Academic Items (or program requirements/components) that a student accumulates as the student progresses through a program of study.
- Maintains the structure of a student's program requirements (as defined in AIR) so that results can be calculated at user-defined levels and progress can be tracked.
- Provides a user-defined structure of results and statistics (total credits, grade points, and so on) that is not subject to the constraints imposed by the core term based structure which has a strictly defined set of fields.

While APT provides this flexibility, the core Campus Solutions system is still used to manage admission and enrollment. A student still must have a valid Student Records program stack and, for enrollment purposes, a valid term row. In most cases therefore, the APT instance will be built after a person becomes a student (through the core Campus Solutions process).

Linking an APT Instance to the Student Program

If the Enable Program Enrollment check box is selected on the Academic Institution 9 page, the APT Instance and Year of Program fields appear on the Admissions Application Program Data page and the Student Records Program Data page. The check box is deselected by default; you must select the check box to use the Academic Progress Tracker.

See [Setting Up for the Academic Progress Tracker](#)

This section discusses how to:

- Create an APT Instance from core Admissions.
- Create an APT Instance from core Student Records.

Related Links

[APT API Detail](#)

Pages Used to Link an APT Instance to the Student Program

<i>Page Name</i>	<i>Definition Name</i>	<i>Navigation</i>	<i>Usage</i>
Application Program Data	ADM_APPL_PROG_ENT ADM_APPL_PROG_MNT	Student Admissions > Application Entry > Add Application > Application Program Data Student Admissions > Application Maintenance > Maintain Applications > Application Program Data	Create an APT instance.
Student Program	STDNT_PROG	Records and Enrollment > Career and Program Information > Student Program/Plan > Student Program	Create an APT instance.

Creating an APT Instance from Admissions

Access the Application Program Data page (**Student Admissions > Application Entry > Add Application > Application Program Data**).

This example illustrates the fields and controls on the Application Program Data page for Program Enrollment. You can find definitions for the fields and controls later on this page.

The screenshot displays the 'Application Program Data' page for Program Enrollment. At the top, navigation tabs include Biographical Details, Addresses, Regional, Application Program Data (selected), Application Data, and Application School/Recruiting. The user's name is Rochelle Lewis, and the application number is 00024917. The academic institution is PeopleSoft University, and the career level is Undergraduate. The program data section shows a program number of 0, an admit term of 2014 Fall, and an academic program of BALAU. The program enrollment section shows a cohort tag of FALL-ADMIT and a year of program of 1st Year. The program status section shows the applicant's status as Applicant, with an action date of 09/27/2013. The plan data section shows an academic plan of ECONOMICS.

Field or Control	Description
Cohort Tag	This field appears only if the Enable Program Enrollment check box is selected on the Academic Institution 9 page. This value is obtained in the application process and indicates the point within a term (typically a session) that the applicant is expected to enroll.
APT Instance	This field appears only if the Enable Program Enrollment check box is selected on the Academic Institution 9 page. Note: The rules governing the generation of the instance at the admission stage and the process to generate the instance are planned for the future.
Year of Program	This field appears only if the Enable Program Enrollment check box is selected on the Academic Institution 9 page. This value is obtained in the application process and indicates the student's start point in a program of study, for example, a student could apply as a second year student.

See “Adding New Applications Manually” (Recruiting and Admissions)

See [Enabling Program Enrollment](#)

Creating an APT Instance from Admissions

Creation of an APT Instance:

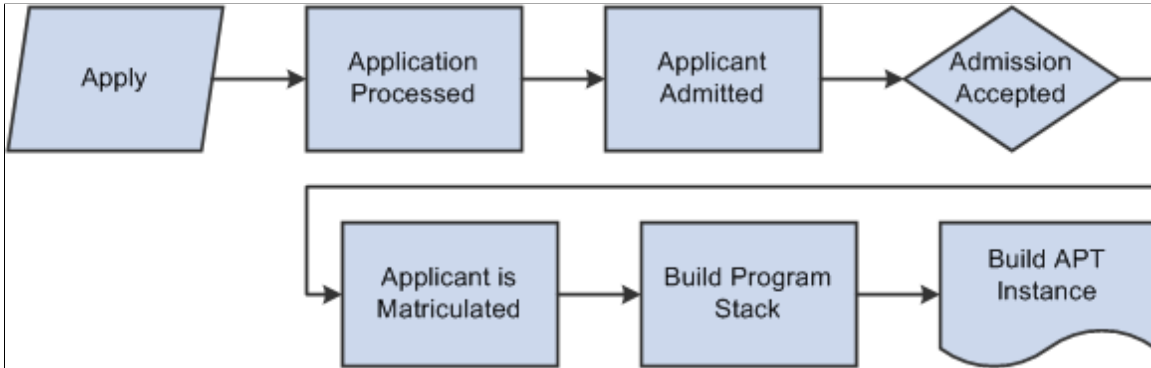

When the matriculation process creates the Student Records program stack, if a student is in a program/plan/sub-plan combination that is mapped to an AIR program, an API (SSR_APT.API) is called. The API creates an APT instance for the student, linking that instance to the program created by the matriculation process.

APT Instance Creation from Admissions Application Maintenance Component

An APT instance can be created directly from the Admissions Application Maintenance component when a user creates the student program using the matriculation (MATR) action.

The following diagram provides an overview of the processing that takes place:

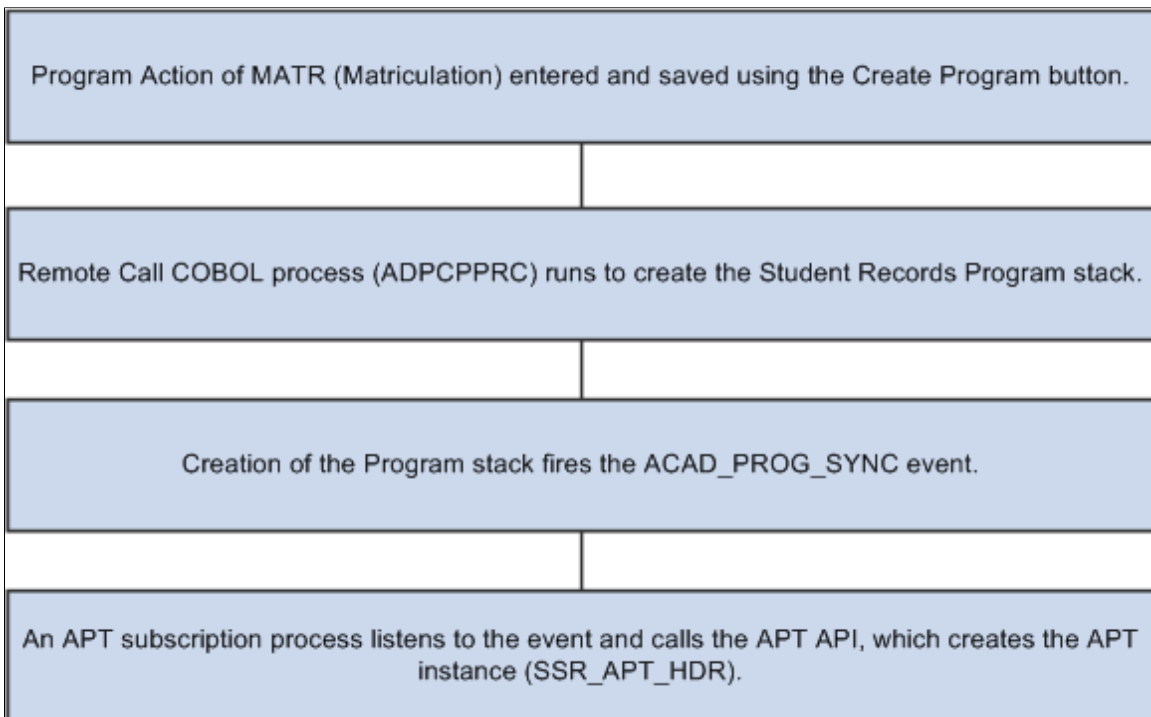

APT Instance Creation from Admissions Activate Applicants Process

The Admissions Activate Applicants batch process also creates an instance for a student when a mapping exists to an AIR program. When the process (ADPCPPRJ) creates Student Records program stack entries, this action fires the same ACAD_PROG_SYNC event described above. This is detected by the APT subscription service, which in turn calls APT API to build an instance.

See “Understanding How to Evaluate Applicants Using Automatic Processing” (Recruiting and Admissions)

Related Links

[APT API Detail](#)

Creating an APT Instance from Student Records Program/Plan Component

Access the Student Program page (**Records and Enrollment > Career and Program Information > Student Program/Plan > Student Program**).

This example illustrates the fields and controls on the Student Program page for Program Enrollment. You can find definitions for the fields and controls later on this page.

<i>Field or Control</i>	<i>Description</i>
Year of Program	This value is gathered in the application process and indicates the student’s start point in a program of study: for example, a student could apply as a second year student. The value is copied from the Admissions program stack by the matriculation process.

Field or Control	Description
APT Instance	<p>This field is populated with number of the APT Instance. This could be generated during the Admissions activation/ matriculation process, the APT Request process or from this component (see “Adding a New Program” below).</p> <p>Click the APT Instance link to access the Academic Progress Tracker component. From that component, click the Student Career Nbr link to return to the Student Program page.</p> <p>See Creating and Managing APT Instances Using the Academic Progress Tracker Component</p>
Cohort Tag	<p>This value is obtained in the application process and indicates the point within a term (typically a session) that the applicant is expected to enroll.</p>

An APT instance can be created from the Program/Plan component when a user adds a new program stack (or career number) or makes changes to an existing program stack: the APT API is called from this component to create an APT instance.

Adding a New Program

An APT instance can be created from the Program/Plan component when a user adds a new program stack (or career number) or makes changes to an existing program stack: the APT API is called from this component to create an APT instance. When a new career number is added and the component is saved, the APT API is called.

The API:

- Checks to see if mapping exists for the student’s program in the Academic Program Table Program Enrollment Mapping table. (SSR_PE_PRG_MAP).
- If mapping exists, finds a row which maps to the combination of Plan(s) Sub-Plan(s) and Approved Academic Load. If mapping does not exist, uses the default (a default is required).
- Creates an APT Instance for the mapped AIR program (process creates a row in the APT header table).
- Updates the Instance number (ACAD_PROG.SSR_APT_INSTANCE).
- The component returns a message to the user, confirming that an instance has been created.

See [Mapping Campus Solutions Academic Programs, Plans and SubPlans to AIR Based Programs of Study](#)

Changes to Existing Program Data

When a user inserts a new effective dated row and saves, an edit is performed to see if the new data – academic program, approved academic load, academic plan(s) or sub-plan(s) – has changed the program mapping from the previous row. If such a change has occurred:

- A message is returned to the user to ask if a new instance should be created.

- If the user answers yes, the API is called and the steps described in the previous Adding a New Program section are performed.

It is also possible that a student's program data could change in such a way that a new effective dated row could map to a prior APT instance. For example, a student might change from full-time (Instance 1) to part-time (Instance 2) and then subsequently change back to full-time. When this occurs, and the new data maps to a program on a prior instance:

- The user is prompted to create a new instance (because the mapping has changed).
- If a match is found on a prior instance, the user is prompted to point the new effective dated row to that instance.
- If the user answers yes, the instance number from the previous instance is used; otherwise a new instance is created.

Related Links

[Maintaining Student Program Stacks](#)

[APT API Detail](#)

Creating and Managing APT Instances Using the APT Request Process

As previously mentioned, an APT instance can be generated after an applicant has been activated, or directly from the Student Program/Plan component when you add a new program stack or when a change is made to an existing program stack. The APT Request process allows you to create new instances for groups of students and to maintain those instances by adding and activating new program nodes as they progress through a program of study.

The process of generating an APT instance can, depending on the processing action, involve two main steps:

1. The creation of a header record, which creates the keys of the instance and the academic item ID for the assigned program.
2. The population of the instance with the academic items or program requirements for a selected program item.

For detailed information about each of the operations performed by the APT API, see [APT API Detail](#).

This section discusses how to run the APT Request process.

Page Used to Run the APT Request Process

<i>Page Name</i>	<i>Definition Name</i>	<i>Navigation</i>	<i>Usage</i>
APT Request	SSR_APT_REQ_RUNCNT	Records and Enrollment > Program Enrollment > APT Request	Run the APT Request process.

Page Name	Definition Name	Navigation	Usage
APT Request Search	SSR_APT_REQ_SEARCH	Records and Enrollment > Program Enrollment > APT Request Search	Search APT Requests.

Running the APT Request Process

Access the APT Request page (**Records and Enrollment > Program Enrollment > APT Request**).

This example illustrates the fields and controls on the APT Request page. You can find definitions for the fields and controls later on this page.

APT Request

Run Control ID: PS [Report Manager](#) [Process Monitor](#) Run

*Academic Institution: [🔍](#)

*APT Action: [▼](#)

*Program Format ID: [🔍](#) [View Tree](#)

Create Plan Node Create Selected Plan node(s)

Population Selection

Population Selection

Selection Tool: [▼](#) [Edit Prompts](#)

Query Name: [🔍](#) [Launch Query Manager](#) [Preview Selection Results](#)

Term Activate Activate Planning Node

Create Next Node(s)/Attempt Options Personalize Find View All First 1 of 1 Last				
Planning Node	Description	Attempt Status	Attempt Outcome	Action Mode
1	<input type="text" value="10"/> 🔍 Year 1	<input type="text" value="Activated"/> ▼	<input type="text" value="Passed"/> ▼	<input type="text" value="Next Planning Node"/> ▼ + -

Field or Control	Description
APT Action	<p>These actions determine how the APT Request process (SSR_APT_REQ) builds a new APT instance or interacts with an existing instance. Select an action:</p> <ul style="list-style-type: none"> • <i>Create Instance:</i> Builds a new APT Instance by creating a header record (SSR_APT_HDR) containing the keys and other high level data for the instance. This action emulates the processing that occurs as a result of an Admissions program activation or from the Student Program/Plan component. This action updates the student program/plan stack with the instance number. • <i>Create Ins and Plan Node Attempt:</i> Creates a new instance and builds on the first planning node attempt, along with any child program format tree nodes as well as any other items for which the Automatically Move to APT check box is selected on the Enrollment Category page. This action updates the student program/plan stack with the instance number. <p>See Setting Up Enrollment Categories for Program Requirements</p> <ul style="list-style-type: none"> • <i>Create Plan Node(s):</i> Builds out the next planning node or specified planning node of the program, depending on whether the Create Plan Node or Create Selected Plan Node(s) option is selected (see documentation later in this section). The process creates the planning node item and attempt along with any items (for that node) for which the Automatically Move to APT check box is selected on the Enrollment Category page. The next node is the next node in the student’s program after the current or maximum node in APT. For example, if the program planning nodes are defined as years, node 100 (year 1), 200 (year 2), 300 (year 3) and the maximum node in APT is currently 200, the next node is year 3 (300). When you select this action, the Create Next Node/Attempt Options grid becomes available. • <i>Activate Planning Node:</i> Sets the Attempt Status field (on the APT Items page) to <i>Activated</i> for the items representing the planning node and child program format tree nodes. For example, with a program format like this: <p>This example illustrates the fields and controls on the Program Format example for APT (Academic Progress</p>

Field or Control	Description
	<p>Tracker). You can find definitions for the fields and controls later on this page.</p> <div data-bbox="911 317 1620 913" style="border: 1px solid black; padding: 5px;"> <p>Program Format Tree</p> <p>Academic Institution: PSUNV PeopleSoft University</p> <p>Program Format ID: UG_4YR_REG UG 4 Year Program</p> <p>▼ Tree View</p> <ul style="list-style-type: none"> 1 - Program <ul style="list-style-type: none"> 10 - Year 1 <ul style="list-style-type: none"> 101 - Year 1 - Semester 1 102 - Year 1 - Semester 2 20 - Year 2 <ul style="list-style-type: none"> 201 - Year 2 - Semester 1 202 - Year 2 - Semester 2 30 - Year 3 <ul style="list-style-type: none"> 301 - Year 3 - Semester 1 302 - Year 3 - Semester 2 40 - Year 4 <ul style="list-style-type: none"> 401 - Year 4 - Semester 1 402 - Year 4 - Semester 2 </div> <p>where <i>Year</i> is the Planning Node, this action would activate the Year and both of its child Semester items. Activation occurs on the current planning node in APT: that is, the maximum sequenced planning node with an attempt status equal to null.</p>
Program Format ID	<p>This field prompts against the Program Format Table for the selected institution. Use the View Tree link to view the Program Format definition. The value that is selected here serves as a high level control for the run control. Only students (identified by the population selection or entered manually) in programs with a matching program format ID are considered for processing.</p>
Create Plan Node	<p>When this option is selected, the APT request process sequentially identifies which planning node should be created for a student. For example, if the student's program format has four planning nodes, 10, 20, 30 and 40 and the action is <i>Create Ins and Plan Node Attempt</i>, the process creates the lowest planning node ID, 10.</p> <p>This option is selected by default.</p>
Create Selected Plan Node(s)	<p>If this option is selected, the user must identify which plan node (within a Program Format) should be created for the run. This allows planning nodes to be created in a user defined order when necessary.</p> <p>For example, you could define a Program Format where it is necessary to create and activate multiple planning nodes at the same time. Refer to the following example.</p>

This example shows a dual major program format, where planning nodes (years) are defined under each major:

Program Format

Institution PeopleSoft University

Format ID 3-YR-MAJOR

***Description**

Item Type Usage

Planning Node	YEAR	Year
Year of Program	YEAR	Year
Equates to Term	YEAR	Year

Add Session Level

Date Controls

Student Planning Term/Session Table

Tree View

- └─ [1 - Program of Study](#)
 - └─ [10 - Major 1](#)
 - └─ [20 - Year 1](#)
 - └─ [30 - Year 2](#)
 - └─ [40 - Year 3](#)
 - └─ [50 - Major 2](#)
 - └─ [60 - Year 1](#)
 - └─ [70 - Year 2](#)
 - └─ [80 - Year 3](#)

The Create Selected Plan Node(s) option can be used to identify, create and activate each year for each major. To activate the student in Year 1 for both Majors, Node IDs 20 and 60 would be specified.

Population Selection

The Population Selection group box is a standard group box that appears on run control pages when the Population Selection process is available or required for the transaction. Selection tools are available based on the selection tools that your institution selected in the setup of the Population Selection process for the application process and on your user security. Fields in the group box appear based on the selection tool that you select. The fields behave the same way from within the group box on all run control pages and application processes. If your institution uses a specific delivered selection tool to identify IDs for a specific transaction, you must use it.

Field or Control	Description
Selection Tool	Select <i>External File</i> or <i>PS Query</i> .
Query Name	<p>The following queries are delivered as samples:</p> <ul style="list-style-type: none"> SSR_APT_REQ_SAMPLE (prompts on Institution only). SSR_APT_REQ_PRG_TERM (prompts on Institution, Academic Career, AIR Program item ID and APT Cohort Term) <p>When you create queries for use with APT Request, you must use the bind record SSR_APT_PROG_VW.</p>

See “Using the Population Selection Process” (Campus Community Fundamentals)

Manual Selection

Field or Control	Description
Academic Career	Enter a valid academic career for the institution/student combination.
Student Career Nbr	Prompts against a view of the student’s program stack for the selected ID/Academic Career.
Academic Program	Enter a valid academic program value for the student.
APT Instance	If the APT Action is <i>Create Instance</i> or <i>Create Instance and Plan Node Attempt</i> , this field is not displayed and defaults to 0. For other actions (where the process acts on an existing instance) the APT instance number attached to the selected Student Career Number will default.

Activating Terms and Planning Nodes

Field or Control	Description
Term Activate	When this check box is selected, the process term activates (that is, creates student term/STDNT_CAR_TERM rows) for all terms within the planning node. This check box is available for all APT actions except <i>Create Instance</i> .

Field or Control	Description
Activate Planning Node	When this check box is selected, the process activates the planning node (and any child program format tree nodes) as they are created. This check box is available when the APT Action is <i>Create Ins and Plan Node Attempt</i> or <i>Create Plan Node(s)</i> .

Create Next Node(s)/Attempt Options

When the APT Action is *Create Plan Node(s)*, the Create Next Node(s)/Attempt Options grid becomes available (as in the page example above).

Field or Control	Description
Planning Node	Available only when the Create Selected Plan Node option has been selected. Select a planning node from the prompt values for the Program Format. The value that you select here is used in one of two ways, depending on the value selected in the Action Mode field (see below). The value represents either the node ID of the planning node to be created in this run or it represents the student(s) current planning node and the process should create the next planning node in the sequence.
Attempt Status	The value that you select here is the Attempt Status of the current planning node for the students being processed. The values are: <i>Activated</i> , <i>Completed</i> , and <i>Finalized</i> . Only students with the attempt status that you select are processed.
Attempt Outcome	The value that you select here is the Attempt Outcome of the current Planning node for the students being processed. The values are: <i>Passed</i> and <i>Not Passed</i> . Only students with the attempt outcome that you select are processed.

Field or Control	Description
Action Mode	<p>Determines whether the process should create a specified planning node or the next planning node or a new attempt against the current planning node. The values are:</p> <ul style="list-style-type: none"> • <i>Create Plan Node:</i> This value is available only when the Run Control mode is Create Selected Plan Node. You must enter a value in the Planning Node field. The process creates this planning node if it does not already exist in the student's APT instance. • <i>Next Planning Node:</i> Builds out the next planning node, including any child program format tree nodes and items for which the Automatically Move to APT check box is selected on the Enrollment Category page. <ul style="list-style-type: none"> • If the Run Control mode is Create Plan Node, this process uses the student's current (that is, maximum) planning node to determine the next planning node in sequence for the student. • If the Run Control mode is Create Selected Plan Node, you must enter a value in the Planning Node field. The process uses this value to determine the next planning node. • <i>New Attempt:</i> Creates a new attempt against the current planning node, if that planning node has been flagged as Eligible for Retake in the student's APT instance. When this is true, the process creates a new attempt against the planning node and also creates new attempts against any program format tree nodes flagged as Eligible for Retake. <ul style="list-style-type: none"> • If the Run Control mode is Create Plan Node, the process creates a new attempt against the student's current (that is, maximum) planning node. • If the Run Control mode is Create Selected Plan Node, you must enter a value in the Planning Node field. The process creates a new attempt against this planning node if it exists in the student's APT instance.

Searching APT Requests

Access the APT Request page (**Records and Enrollment > Program Enrollment > APT Request Search**).

This example illustrates the fields and controls on the APT Request Search page. You can find definitions for the fields and controls later on this page.

The screenshot shows the 'APT Request Search' interface. It includes several search filters: Academic Institution (PSUNV PeopleSoft University), Academic Career (dropdown), Academic Program (dropdown), Academic Program Item ID, Process Description (APT Request), APT Action (dropdown), and APT Request status (dropdown). There are also two range filters: 'APT Request ID Range' with 'From APT Request ID' and 'To APT Request ID' fields, and 'Last Update Range' with 'From Date' and 'To Date' fields. Search and Clear buttons are at the top right. Below the filters is a table with columns: Request Detail, Audit Data, APT Request ID, ID, Name, Academic Career, Student Career Nbr, Academic Program, APT Instance, Academic Item ID, APT Action, and APT Request status. The table contains 7 rows of data.

Request Detail	Audit Data	APT Request ID	ID	Name	Academic Career	Student Career Nbr	Academic Program	APT Instance	Academic Item ID	APT Action	APT Request status
1	000000000028	SR13679	Melissa Robinson	Undergraduate	0	BALAU	1			Create Plan Node(s)	Errors
2	000000000027	SR13678	Kevin Chan	Undergraduate	0	BALAU	1			Create Plan Node(s)	Errors
3	000000000026	SR13677	Audrey Carson	Undergraduate	0	BALAU	1			Create Plan Node(s)	Errors
4	000000000025	SR13676	Lana Meyers	Undergraduate	0	BALAU	1			Create Plan Node(s)	Errors
5	000000000024	SR13682	Miranda Liu	Undergraduate	0	BALAU	1			Activate Planning Node	Success
6	000000000023	SR13681	James Armstrong	Undergraduate	0	BALAU	1			Activate Planning Node	Success
7	000000000022	SR13680	Pablo Rosales	Undergraduate	0	BALAU	1			Activate Planning Node	Success

Field or Control	Description
APT Request ID Range	Enter the Request ID range you wish to search.
Last Update Range	Enter the date range you wish to search for when the APT was last updated.
APT Request status	Click the link for more details about the APT Request status.

Creating and Managing APT Instances Using the Academic Progress Tracker Component

This section discusses how to:

- Add an APT instance.
- Manage APT instance statuses.
- Use the AIR Tree.
- Use the APT Tree.
- Manage APT Items.
- Use the APT timeline.

Pages Used to Create and Manage APT Instances

<i>Page Name</i>	<i>Definition Name</i>	<i>Navigation</i>	<i>Usage</i>
Header	SSR_APT_HDR	Records and Enrollment > Program Enrollment > Academic Progress Tracker > Header	Add an APT instance.
AIR Tree	SSR_APT_AIR_TREE	Records and Enrollment > Program Enrollment > Academic Progress Tracker > AIR Tree	View program requirements and add academic items to APT.
APT Tree	SSR_APT_TREE	Records and Enrollment > Program Enrollment > Academic Progress Tracker > APT Tree	View the academic items within an APT instance.
APT Items	SSR_APT_ITM	Records and Enrollment > Program Enrollment > Academic Progress Tracker > APT Items	Manage APT items.
Timeline	SSR_APT_TIMETABLE	Records and Enrollment > Program Enrollment > Academic Progress Tracker > Timeline.	Use the APT timeline.

Adding an APT Instance

Access the Header page (**Records and Enrollment > Program Enrollment > Academic Progress Tracker > Header**).

This example illustrates the fields and controls on the Header page. You can find definitions for the fields and controls later on this page.

Header
AIR Tree
APT Tree
APT Items
Timeline

Test PE Transfer 001
SRPETR001

Academic Institution PeopleSoft University

Instance 2 Delete Program Transfer

Academic Career UGRD Undergraduate

Student Career Nbr 0 BA Liberal Arts Programs

▼ Academic Program Data

Effective Date 08/19/2020

Sequence 1

Program Status Active in Program

Academic Load Full-Time

Academic Plan	Sub Plan
Business Management	

Academic Item ID 00000001753 B.A. Economics

Format ID UG_3YR_PHASE UG 3 Year - Part 1 and 2

Cohort Tag FALL-ADMITS

Cohort Term 2020 Fall

*Curriculum Term 2020 Fall

Instance Locked

Instance Attributes Find | View All First ◀ 1 of 1 ▶ Last

*Attribute

An APT Instance is created by EMPLID, INSTITUTION and SSR_APT_INSTANCE. In addition to providing a link to the student’s program stack, the Instance Header record also captures key high level data about the student’s program of study.

Field or Control	Description
Delete	<p>You can delete an instance if no Instance Number exists on the Student Program page and no result rows exist for which the Include in Calculation check box is selected on APT Items page and the Result Status is Undetermined.</p> <p>See Linking an APT Instance to the Student Program</p> <p>See Managing APT Items</p>

Field or Control	Description
Program Transfer	<p>This button appears if a student has multiple APT instances, and it's enabled when the APT instance is active.</p> <p>Click to access the APT Transfer page. See Managing APT Program Transfer.</p>
Academic Career	Select an academic career. A student must have an active STDNT_CAREER row for the selected career.
Student Career Nbr	Select a student career number. The field prompts against all active student program stacks for the selected academic career. Click the related link to access the Program Plan component for the selected career number.
Effective Date and Sequence	Displays effective date and sequence of the current row for the student's program/plan stack.
Program Status	Displays the status of the program associated with the selected career number.
Academic Load	Displays the approved academic load for the program.
Academic Plan/Sub Plan	Display only.
Academic Item ID	Select an academic item ID. The prompt lists all valid academic items with an academic item type of Program (SSR_AIR_HDR.SSR_ITEM_TYPE = 'PRG'). This is a delivered academic item type value.
Format ID	Displays the program format ID attached to PRG Academic Item. This value is used to assign an enrollment cohort to a student (see Cohort Term).
Cohort Tag	This value is obtained in the application process and indicates the point within a term (typically a session) that the applicant is expected to enroll. If present, this value is used to assign an enrollment cohort to a student (see Cohort Term).
Cohort Term	<p>The admit term of the student (ACAD_PROG.ADMIT_TERM) appears by default but can be changed. This value is used to assign an enrollment cohort to a student. The system uses the institution, career, program format ID, approved academic load, cohort term and cohort tag (if it exists - it is not required) to point to an enrollment cohort definition for the student. If a student does not have a Cohort Tag, the system looks for matches in the Enrollment Cohort Table where the Cohort Tag value is null.</p> <p>See Setting Up Enrollment Cohorts</p>

Field or Control	Description
Curriculum Term	The value of the requirement term for the selected career number appears by default. You can change the value.
Instance Locked	Select this check box to lock the entire APT instance, preventing any updates. Note: This feature is planned for the future.
Instance Attributes	The scroll area allows you to assign attributes and values to an APT instance. Associate instance attributes for use with APT Instances on the Common Attributes – Record Context page. See “Associating a Common Attribute to a Record” (Campus Community Fundamentals)
Generate	Click this button to launch the process that fetches all academic items that are attached to the PRG academic item ID. The following documentation explains the generate process.

Generating Academic Items

As mentioned previously, the process of adding an APT instance involves two steps. The first is the creation of a header record using the fields described above. The second step is the generation of the academic items or program requirements for a selected program item. This could be a single item (for the program itself) if the program item is a shell for a customized student specific program, or it could be an extensive list of requirements that are nested under the program item in a series of layers or levels. The item generation process does the following:

1. Evaluates the TERM_TBL to find the start date of the student’s Requirement Term (SSR_APT_HDR.REQ_TERM).
2. Using that date, it retrieves the maximum active effective dated row for the PRG item (from SSR_AIR_HDR) where the effective date is less than or equal to the Curriculum Term start date.
3. Retrieves all Academic Item rows for the PRG item and its children, all child items of the PRG’s children and so on.

The list of items returned (on the AIR Tree page) represents a view of all the items that are tied to the PRG academic item in the header. These are the items that can be added from AIR to the student’s APT instance.

Managing APT Instance Statuses

An APT Instance is essentially an extension of the student’s program/plan stack, and the status of the instance (active or inactive) is conferred by the most current effective dated row on the program stack.

When an APT instance is inactivated, the instance is marked as inactive and an *end effective date* is displayed as in the following example:

An APT instance can be rendered inactive when one of the following events occurs on the program/plan stack:

- An effective dated row is added which inactivates the program stack (for example, the program row is discontinued or suspended).
- A change occurs in the program stack data (such as a program or plan change) which initiates the creation of a new APT instance as of a certain date.

For example, Student A has instance 1, which is active as of 07/01/2012. Student A changes Plan with an effective date of 08/01/2013. This plan change maps to a new AIR program which leads to the creation of a new instance for the student, instance 2. In this case, the APT Header data would look like this:

<i>Instance</i>	<i>Effective Date</i>	<i>End Effective Date</i>
1	07/01/2012	07/31/2013
2	08/01/2013	

Using the AIR Tree

The AIR Tree provides a view of a student’s program requirements as they are defined in the Academic Item Registry. When you click Generate on the Header page, all of the academic items attached to the

student’s academic program item (that is, the value in the Academic Item ID field on the Header page) are rendered in a view that represents both program structure and content.

See [Setting Up Academic Item Registry Entries, Item Details, and Item Security](#)



Access the AIR Tree page (**Records and Enrollment > Program Enrollment > Academic Progress Tracker > AIR Tree**).

This example illustrates the fields and controls on the AIR Tree page (1 of 2). You can find definitions for the fields and controls later on this page.

Header						
Expand / Collapse	AIR Item Description	Item Type	Enrollment Category	APT Action	APT Item Seq	AIR Item ID
Robert Jones SR13564						
Academic Institution PeopleSoft University						
APT Instance 1 Instance Status Active						
Personalize						
	B.A. Economics	Program of Study			0000000010	0000001753
	- B.A. Economics Part I	Phase				0000001754
	- BA Econ - Year 1	Stage				0000001755
	- BA Econ - Year 1 - Semester 1	Study Period				0000001756
	- ECON 2: Macroeconomic Principles	Course	Mandatory			0000000388
	- and ECON 3: Microeconomic Principles	Course	Mandatory			0000000389
	- and ECON 10: Introduction to Intl Economics	Course	Mandatory			0000000346
	- and POL SCI 1: Intro to US Govt and Politics	Course	Mandatory			0000000100
	- and STATS 101: Statistical Analysis I	Course	Mandatory			0000000566
	- and BA Econ - Year 1 - Semester 2	Study Period				0000001757
	- ECON 1001B: Economic Principles II	Course	Mandatory			0000000422
	- and ECON 1004B: Economic Methods II	Course	Mandatory			0000000446
	- and ECON 112: Intl Political Economy	Course	Mandatory			0000000529
	- and Economics Year 1 Options	Requirement	Mandatory			0000001749
	- Economics Year 1 Option List A	Course List	Required Electives			0000001743
	- (ECON 1011: Industrial Economics	Course	Required Electives			0000000397
	- and SOC 103: Social Problems)	Course	Required Electives			0000000019
	- or (ECON 1014: Economics of Social Problems	Course	Required Electives			0000000400
	- and SOC 180: World Pop Probs)	Course	Required Electives			0000000171
	- or Economics Year 1 Option List B	Course List	Required Electives			0000001744
	- (ECON 1012: Intntl Political Economy	Course	Required Electives			0000000398
	- and POL SCI 101: Introduction to Government)	Course	Required Electives			0000000095

This example illustrates the fields and controls on the AIR Tree page (2 of 2). You can find definitions for the fields and controls later on this page.

- or (ECON 1013: Public Sector Economics	Course	Required Electives		0000000399
- and POL SCI 105: Intro to World Politics)	Course	Required Electives		0000000097
☐ - and B.A. Economics Part II	Phase			0000001758
☐ - Economics Part.2 Required Courses	Course List	Required Electives		0000001745
- ECON 2011: Company, Finance and Strategy	Course	Required Electives		0000000407
- and ECON 2012: Corporate Finance	Course	Required Electives		0000000408
- and ECON 3005: U.S. and the Intntl Economy	Course	Required Electives		0000000427
- and ECON 3004: The International Economy	Course	Required Electives		0000000418
☐ - and BA Econ - Year 2	Stage			0000001759
☐ - BA Econ - Year 2 - Semester 1	Study Period			0000001760
- ECON 2001: Microeconomic Analysis I	Course	Mandatory		0000000401
- and ECON 2003: Mainstream Macroeconomics I	Course	Mandatory		0000000403
- and ECON 2005A: Economic Investigation I	Course	Mandatory		0000000405
☐ - and BA Econ - Year 2 - Semester 2	Study Period			0000001761
- ECON 2002: Microeconomic Analysis II	Course	Mandatory		0000000402
- and ECON 2004: Mainstream Macroeconomics II	Course	Mandatory		0000000404
☐ - and Economics Year 2 Options	Course List	Mandatory		0000001746
- ECON 208: Silicon Valley Econ Problems	Course	Electives		0000000536
- or ECON 220: Labor Economics	Course	Electives		0000000540
- or ECON 224: Health Economics	Course	Electives		0000000541
- or ECON 2017: Valuing the Environment	Course	Electives		0000000411
- or ECON 2018: Econ and Environment Policy	Course	Electives		0000000412
- or ECON 2021: Independent Study	Course	Electives		0000000413

Field or Control	Description
Enrollment Category	<p>A value appears in this column when the academic item has an enrolment category. An Enrollment Category is a user defined code that is used to control how an academic item is moved to an APT instance.</p> <p>See Setting Up Enrollment Categories for Program Requirements</p>
APT Action	<p>In the APT Action column, the Create Planning Node icon or Add icon can appear.</p>
	<p>The Create Planning Node icon appears when the item has not yet been added to APT. The icon appears only for the academic items that are identified as Planning Nodes in the Program Format definition for the program (SSR_PROG_FORM.SSR_ITEM_TYPE_PLN). Planning Nodes in the Program Format indicate the level at which a student can start to plan and enrol (for example, year by year).</p> <p>See Setting Up Program Formats</p>
	<p>The Add icon appears for all academic items other than grading items.</p>

Field or Control	Description
APT Item Seq	This column appears as soon as one item is added to APT. The sequence number is generated as items are added to APT and therefore sequencing depends on the order in which items are added. Click the link to access the APT Items page and view the expanded item detail section for the selected item. See Managing APT Items
AIR Item ID	This column lists the Academic Item IDs that are associated with the PRG item selected in the header – that is, child items of the PRG item and of all of its related items. Click the link to access the AIR component for the selected academic item.

Using the Create Planning Node Function

The Create Planning Node function simulates the APT Request action of *Create Plan Node(s)* by inserting all of the academic items for the first or subsequent sections of a student’s program of study by adding academic item(s) identified as Planning Nodes (in the Program Format definition).

See [Setting Up Program Formats](#)

The placement of the planning node (and selected child items) will open that particular section of the program—for example a stage, year or semester—for planning and enrollment.

The Create Planning Node function adds:

- The selected item (that is, the item identified as a Planning Node and where the icon appears).
- All ancestors in the lineage that are not already in APT.
- AND
- All non-COURSE immediate child items (for example a ‘stage’ or ‘study period’).
- Any descendent items that have an enrollment category for which `SSR_ENRL_CAT.SSR_AUTOMOVE_APT = 'Y'`.

In the following example, each phase is a Planning Node. The Enrollment Category of Mandatory is defined as one for which items should be automatically moved to a student’s APT:

Expand / Collapse	AIR Item Description	Item Type	Enrollment Category	APT Action	APT Item Seq	AIR Item ID
[-]	B.A. Economics	Program of Study			0000000010	0000001753
[-]	[-] B.A. Economics Part I	Phase				0000001754
[-]	[-] [-] BA Econ - Year 1	Stage				0000001755
[-]	[-] [-] [-] BA Econ - Year 1 - Semester 1	Study Period				0000001756
	[-] [-] [-] [-] ECON 2: Macroeconomic Principles	Course	Mandatory			0000000388
	[-] [-] [-] [-] and ECON 3: Microeconomic Principles	Course	Mandatory			0000000389
	[-] [-] [-] [-] and ECON 10: Introduction to Intl Economics	Course	Mandatory			0000000346
	[-] [-] [-] [-] and POL SCI 1: Intro to US Govt and Politics	Course	Mandatory			0000000100
	[-] [-] [-] [-] and STATS 101: Statistical Analysis I	Course	Mandatory			0000000566
[-]	[-] [-] [-] [-] and BA Econ - Year 1 - Semester 2	Study Period				0000001757
	[-] [-] [-] [-] [-] ECON 1001B: Economic Principles II	Course	Mandatory			0000000422
	[-] [-] [-] [-] [-] and ECON 1004B: Economic Methods II	Course	Mandatory			0000000446
	[-] [-] [-] [-] [-] and ECON 112: Intl Political Economy	Course	Mandatory			0000000529
[-]	[-] [-] [-] [-] [-] and Economics Year 1 Options	Requirement	Mandatory			0000001749
[-]	[-] [-] [-] [-] [-] Economics Year 1 Option List A	Course List	Required Electives			0000001743
	[-] [-] [-] [-] [-] [-] (ECON 1011: Industrial Economics	Course	Required Electives			0000000397
	[-] [-] [-] [-] [-] [-] and SOC 103: Social Problems)	Course	Required Electives			0000000019
	[-] [-] [-] [-] [-] [-] or (ECON 1014: Economics of Social Problems	Course	Required Electives			0000000400
	[-] [-] [-] [-] [-] [-] and SOC 180: World Pop Probs)	Course	Required Electives			00000000171
[-]	[-] [-] [-] [-] [-] [-] or Economics Year 1 Option List B	Course List	Required Electives			0000001744
	[-] [-] [-] [-] [-] [-] (ECON 1012: Intrntl Political Economy	Course	Required Electives			0000000398
	[-] [-] [-] [-] [-] [-] and POL SCI 101: Introduction to Government)	Course	Required Electives			0000000095
	[-] [-] [-] [-] [-] [-] or (ECON 1013: Public Sector Economics	Course	Required Electives			0000000399
	[-] [-] [-] [-] [-] [-] and POL SCI 105: Intro to World Politics)	Course	Required Electives			0000000097

When Phase 1 is created, the following items will be added to APT:

AIR Item Description	Item Type	AIR Item ID
BA Economics	Program of Study	0000001753
Part 1 – BA Economics Program	(Program Phase)	0000001754
Year 1 B.A Economics	Stage	0000001755
Year 1 – Semester 1	Study Period Plus all Mandatory items, in this case all courses	0000001756

AIR Item Description	Item Type	AIR Item ID
Year 1– Semester 2	Study Period Plus all Mandatory items: all three mandatory courses plus the mandatory Economics Year 1 Options item (but not its children, which do not have the Automatically move to APT check box selected on the Enrollment Category page, because the student needs to choose.)	00000001757

See [Setting Up Enrollment Categories for Program Requirements](#)

Using the Add Function

You can also add academic items to an APT instance on an individual basis using the Add function. For example the Add button can be used to add courses when you must select one or more courses from a list. When items are added to a student’s APT in this way however, the relationship of that item to other items in the AIR tree must be recorded in order to maintain the structure of the program at an individual student level. Because it is possible to add an item without also adding its parent, the *ancestors* of an item are also added if they have not themselves been added to the APT instance.

In most cases the Add function adds the selected item to APT as well as all ancestors in the lineage, up through the PRG root, that do not already exist in APT. The exception is course items that are not associated with an item that equates to Term.

See [Assigning Term Values to Courses](#)

This example illustrates the AIR Tree as explained below.

[-] [-] [-] and Part 2 - BA Economics Program	Program Phase		0000000578
[-] [-] [-] and Economics - Part 2 Required Courses	Course List	Required Courses	0000000565
[-] [-] [-] [-] ECON 2011: Company, Finance and Strategy	Course	Required Courses	0000000406
[-] [-] [-] [-] and ECON 2012: Corporate Finance	Course	Required Courses	0000000407
[-] [-] [-] [-] and ECON 3005: U.S. and the Intl Economy	Course	Required Courses	0000000426
[-] [-] [-] [-] and ECON 3004: The International Economy	Course	Required Courses	0000000417
[-] [-] [-] [-] and Year 2 - B.A. Economics	Stage		0000000579
[-] [-] [-] [-] [-] Year 2 - Semester 1	Study Period		0000000580
[-] [-] [-] [-] [-] [-] ECON 2001: Microeconomic Analysis I	Course	Mandatory	0000000400
[-] [-] [-] [-] [-] [-] and ECON 2003: Mainstream Macroeconomics I	Course	Mandatory	0000000402
[-] [-] [-] [-] [-] [-] and ECON 2005A: Economic Investigation I	Course	Mandatory	0000000404
[-] [-] [-] [-] [-] [-] and Year 2 - Semester 2	Study Period		0000000581
[-] [-] [-] [-] [-] [-] [-] ECON 2002: Microeconomic Analysis II	Course	Mandatory	0000000401
[-] [-] [-] [-] [-] [-] [-] and ECON 2004: Mainstream Macroeconomics II	Course	Mandatory	0000000403
[-] [-] [-] [-] [-] [-] [-] and Economics Year 2 Options	Course List	Electives	0000000568
[-] [-] [-] [-] [-] [-] [-] [-] ECON 220: Labor Economics	Course	Electives	0000000511
[-] [-] [-] [-] [-] [-] [-] [-] or ECON 224: Health Economics	Course	Electives	0000000512

In the example above, if you added course ECON 220 (highlighted in the example page) and no other items had been added to the APT for Part 2 B.A. Economics, the following items would also be added:

- ECON 220 (00000000511– selected item)
- Economics Year 2 Options (Course List: 00000000568 – parent of selected item)
- Year 2 - Semester 2 (Study Period: 00000000581 – parent of Course List)
- Year 2- B.A. Economics (Stage: 00000000579 – parent of Study Period)
- Part 2 - BA Economics Program (Phase: 00000000578– parent of Stage)

Using the APT Tree

The APT Tree provides a view of all of the academic items within a particular APT instance, the status of those items (completed or not completed) and the relationships between those items. Although APT data is sourced from data that is defined in a tree-like structure (AIR) it is possible that these relationships can be changed after the items are placed in an APT instance. A course could be moved from one stage to another, for example, such that the parent item is changed from STAGE 1 to STAGE 2. The individual student program tree structure presented in this way is used to calculate results at various levels in the program. Note. This feature is planned for the future.

Access the APT Tree page (**Records and Enrollment > Program Enrollment > Academic Progress Tracker > APT Tree**).

This example illustrates the fields and controls on the APT Tree page. You can find definitions for the fields and controls later on this page.

Header AIR Tree APT Tree APT Items Timeline					
Robert Jones		SR13564			
Academic Institution PeopleSoft University					
APT Instance 1		Instance Status Active			
Status	AIR Item Description	Item Type	Enrollment Category	APT Item Seq	AIR Item ID
<input type="radio"/>	B.A. Economics	Program of Study		0000000010	0000001753
<input type="radio"/>	- B.A. Economics Part I	Phase		0000000020	0000001754
<input type="radio"/>	- BA Econ - Year 1	Stage		0000000030	0000001755
<input type="radio"/>	- BA Econ - Year 1 - Semester 1	Study Period		0000000040	0000001756
<input type="radio"/>	- ECON 2: Macroeconomic Principles	Course	Mandatory	0000000050	0000000388
<input type="radio"/>	- ECON 3: Microeconomic Principles	Course	Mandatory	0000000060	0000000389
<input type="radio"/>	- ECON 10: Introduction to Intl Economics	Course	Mandatory	0000000070	0000000346
<input type="radio"/>	- POL SCI 1: Intro to US Govt and Politics	Course	Mandatory	0000000080	0000000100
<input type="radio"/>	- STATS 101: Statistical Analysis I	Course	Mandatory	0000000090	0000000566
<input type="radio"/>	- BA Econ - Year 1 - Semester 2	Study Period		0000000100	0000001757
<input type="radio"/>	- ECON 1001B: Economic Principles II	Course	Mandatory	0000000110	0000000422
<input type="radio"/>	- ECON 1004B: Economic Methods II	Course	Mandatory	0000000120	0000000446
<input type="radio"/>	- ECON 112: Intl Political Economy	Course	Mandatory	0000000130	0000000529
<input type="radio"/>	- Economics Year 1 Options	Requirement		0000000140	0000001749
<input type="radio"/>	- Economics Year 1 Option List A	Course List	Required Electives	0000000150	0000001743
<input type="radio"/>	- ECON 1011: Industrial Economics	Course	Required Electives	0000000160	0000000397
<input type="radio"/>	- SOC 103: Social Problems	Course	Required Electives	0000000170	0000000019

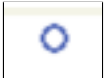
Field or Control	Description
Status	Indicates whether an item is <i>Completed</i> or <i>Not Completed</i> . This value will ultimately be set based on the APT item status (planned for the future). For now, the status can be set manually at the APT item level. See Managing APT Items
	Indicates the status of the item is <i>Completed</i> .
	Indicates the status of the item is <i>Not Completed</i> .

For information about the Enrollment Category, APT Item Seq, and AIR Item ID columns, refer to the previous documentation about these fields for the AIR Tree page.

Managing APT Items

The APT Items page provides a view of all items in an APT instance and their related detail. The three levels of data for an APT item are:

1. The APT Item Sequence level (SSR_APT_ITEM) which holds high level data such as the item sequence, weight, and status.
2. The Academic Item Attempt level: An academic item can have multiple attempts attached to it. An item such as COURSE can be repeated without altering the structure of the program. For example, a first year course can be repeated during the second year, but the outcome/credits apply to the first year requirements. Data such as academic year and term are also tracked at this level.
3. The Academic Item Attempt Results level: Each attempt can have multiple results associated with it. There can be multiple Result Types and the structure also accommodates multiple instances of the same result type. This structure allows you to define your own result profile – where the institution determines what type of data is used to track results. It also allows for different versions of results – for example, *preliminary*, *board approved*.

As you can see in the following page example, an Academic Item Attempt can have Attempt Schedule data (sibling) and can have multiple Results rows. The same structure is available for all academic items - the course item shown in the example page has the same basic APT structure as the Study Period item shown above it on the example page.

Access the APT Items page (**Records and Enrollment > Program Enrollment > Academic Progress Tracker > APT Items**).

This example illustrates the fields and controls on the APT Items page (1 of 3). You can find definitions for the fields and controls later on this page.

The screenshot shows the 'APT Items' page for Anthony Sage (SR0448) at PeopleSoft University. The page includes navigation tabs for Header, AIR Tree, APT Tree, APT Items, and Timeline. Below the header, it displays 'Academic Institution PeopleSoft University', 'APT Instance 1', and 'Instance Status Active'. There are two buttons: 'Expand All Sections' and 'Collapse All Sections'. A list of academic items is shown with expandable arrows:

- 0000000010 - Program of Study: B.A. Economics
- 0000000020 - Phase: B.A. Economics Part I
- 0000000030 - Stage: BA Econ - Year 1
- 0000000040 - Study Period: BA Econ - Year 1 - Semester 1

This example illustrates the fields and controls on the APT Items page (2 of 3). You can find definitions for the fields and controls later on this page.





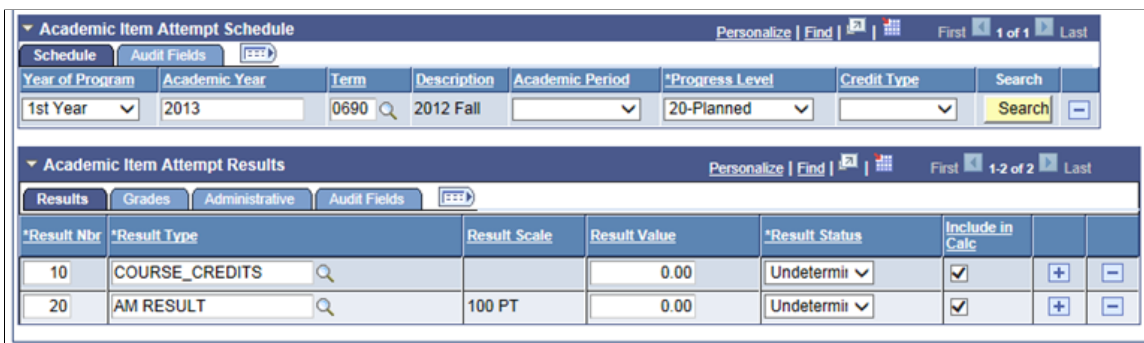

The screenshot shows the detailed view for the course '0000000370 - Course: SOC 230: Sociological Methods I'. The fields are organized into sections:

- Course Details:**
 - *APT Item Seq: 370
 - Parent Item Seq Nbr: 50
 - Academic Item ID: 0000000026
 - AIR Parent Item ID: SOC 230: Sociological Methods I
 - Academic Item Type: Course
 - Enrollment Category: (dropdown)
 - Item Weight: 1
 - Authorized Exception: Admin Addition
 - *Satisfied: No
 - Grading Item Type:
 - Exam Only Option:
 - Substituted:
 - Include in Calculation:
- Academic Item Attempt:**
 - *Attempt Nbr: 1
 - *Parent Attempt Nbr: 1
 - *Approval Status: Not Required
 - Attempt Status: (dropdown)
 - Attempt Outcome: (dropdown)
 - Eligible for Retake: (dropdown)
 - Include in Calculation:
 - Print in Transcript:
- Audit Fields:**
 - Created: 10/05/2013 08:34:00
 - Created By: [PS] Sample Data Entry
 - Last Modified: 17/12/2013 08:22:38
 - Modified By: [PS] Sample Data Entry

This example illustrates the fields and controls on the APT Items page (3 of 3). You can find definitions for the fields and controls later on this page.



APT Items Page: APT Item Sequence Level

<i>Field or Control</i>	<i>Description</i>
 Process Substitution	See: Substituting APT Items
 Add	See: Adding Child Items
 Delete	Item Delete is available for all APT items, however delete is prevented on save if the item being deleted has child items.
 Add Notes	Click to access a secondary page Item Notes where you can add notes and comments.
 Lock	Click to lock the item and all of its child items. A locked item cannot be updated: all fields at the item, attempt and result level are display only.
 Unlock	Click to unlock the item and child items that are locked.
APT Item Seq	The APT Item Sequence is assigned as items are added to an APT Instance. You can change the value to reorder items when required.

Field or Control	Description
Parent Item Seq Nbr	<p>This value is the APT Item Seq value of the parent item.</p> <p>You can change this value if you need to move an item to a different area of a student’s program (for example, from one stage to another).</p>
 Go	<p>Use the Go icon to quickly navigate to the parent academic item.</p>
Academic Item ID and Academic Item Type	<p>Displays the Academic Item ID and Academic Item Type of the item copied from the AIR program structure to the student’s APT.</p>
Grading Item Type	<p>Display only. This check box is selected when the APT row was created to represent a (child) grading item from AIR.</p>
Item Weight	<p>If an item has a weighting value (in the context of its parent), it is moved to this field when the item is saved to APT. You can change this value, to override the contribution of a particular item to a higher level calculated result.</p>
Authorized Exception	<p>This field displays only when an item that has been added to the instance does not exist in the Academic Item Registry as an item for the student’s program. There is currently only one value: <i>Admin Addition</i>.</p>
Satisfied	<p>Select <i>Yes</i>, <i>No</i>, or <i>Waived</i>.</p> <p>A value of <i>Yes</i> indicates that the requirements for an item have been satisfied and that the item (in combination with the Include in Calculation check box) can be used towards program completion/results calculation.</p>
Exam Only Option	<p>Select this check box to indicate that an item (and all child items) will be satisfied by exam only – that is, no course enrollment is required.</p> <p>This feature is planned for the future.</p>
Include in Calculation	<p>When this check box is cleared, all attempts/results for this item are ignored for result calculation purposes by the Rules Engine and system calculated results. Note: This feature is planned for the future.</p>

APT Items Page: Adding Child Items

In most cases, the items (courses and so on) that are added to an APT instance will be drawn from the items that are linked to the student's program. However, in some cases it might be necessary to make changes to a student's program by adding items that are not linked directly to the student's program of study or to remove items that are part of the program requirements defined in AIR. A typical example is where the student, usually in consultation with an advisor, is allowed to create a personalized or customized set of courses. This could apply to whole program or to a section of a program - a year or semester for example. In this case, it is likely that you will define an item that is really a placeholder for the program itself, or the year of program, to which you will add child items to represent the student's *custom* program. However, the Add feature allows you to add child items to an APT item with some exceptions.

When you add an item, you are presented with a list of values that is compiled as follows:

- If the current item is a Program Format Tree Node, the prompt lists all academic items that have an academic type specified as a valid child item in the Academic Item Type Matrix.

See [Identifying Child Item Types and Syncing Entities](#)

- The prompt also excludes those items that have an item type defined as a Program Format Tree Node. This ensures that any changes to the program structure conform to the Program Format for the item.
- All available COURSE items (unless the item is being added as a child of a COURSE – *except where* the current item is a Course Group, in which case a secondary page will list the courses that match the Course Group parameters).

Example: Add Child item to Year 1 of Program BA Economics:

- BA Economics has a Program Format comprised of Academic Item Types: PRG (Program), PHASE (Part 1 and 2), STAGE (Year), and STUDYPERIOD (term/semester).
- Year 1 has an Academic Item Type of Year with an Item Type of STAGE.
- Therefore, the available items to be added as child items would be all valid child items (according to the Item Type matrix) of the item type STAGE, excluding PRG, PHASE, STAGE, STUDYPERIOD, plus all available COURSE items.

APT Items Page: Substituting APT Items

The APT Item structure supports the need to substitute prescribed program content (academic items) with courses or other types of academic items. The substitution process typically involves the swapping of one course for another, but it is also possible to substitute different types of academic items, as well as the replacement of one item with many items. It is also possible to replace an item of one type with one (or more) of a different type.

Note: Not all academic items can be substituted: the Process Substitution button is hidden when an item has an academic type identified as a program format tree node, or if the item itself has been replaced with another APT item. The button is also hidden for any item that has child items in APT. For example, a Course List item, from which child item courses have been placed in APT cannot be substituted.

The Process Substitution button invokes a look up against Academic Item Registry for the institution attached to the student's APT instance.

Parent Item Type: STUDYPERIOD
Academic Institution: PSUNV
Item Type: begins with 
Academic Item ID: begins with
Description: begins with

[Basic Lookup](#)

Search Results

Only the first 300 results can be displayed.

View 100 First 1-300 of 300

Item Type	Academic Item ID	Description
CLUSTER	00000001731	Introductory Foreign Languages
COURSE	00000000001	MATH 101: College Algebra
COURSE	00000000002	MATH 10: Remedial Algebra
COURSE	00000000003	ART 101: Art Survey
COURSE	00000000004	ART 140: 2D Design
COURSE	00000000005	ART 100: Basic Studio in Art
COURSE	00000000006	ART 111: Introductory Art Seminar

The prompt lists all non-program format tree node academic items (with effective dated logic) that are *valid child items (according to item type matrix) of the parent item of the item* which is being substituted.





After an item has been selected, the Substitution function performs the following actions:

Substituted Item

- Selects the Substituted check box for the item.
- Creates a pointer on the substituted item to the *Replaced with* items.



This example further illustrates process substitution:

0000000060 - Course: ECON 2: Macroeconomic Principles

*APT Item Seq     

Parent Item Seq Nbr 

Academic Item ID 00000000388 ECON 2: Macroeconomic Principles
 AIR Parent Item ID 00000001756 BA Econ - Year 1 - Semester 1

Academic Item Type Course Grading Item Type
 Exam Only Option
 Substituted
 Replaced with 390  

Enrollment Category
 Item Weight
 Reason Code
 *Satisfied Include in Calculation

The *Replaced with* item is inserted into the APT Instance:

- Sets the parent value of the item to that of the substituted item.
- Ties the new item to the substituted item by recording that APT Item Sequence number of the substituted item.
- Note: The Process Substitution button is not available for the replacement item(s).

This example further illustrates process substitution:

00000000390 - Course: ECON 110: International Economics

*APT Item Seq ×

Parent Item Seq Nbr

Substitute for

Academic Item ID 00000000567 ECON 110: International Economics

AIR Parent Item ID

Academic Item Type Course Grading Item Type

Enrollment Category Exam Only Option

Item Weight

Reason Code

*Satisfied Include in Calculation

Reversing an APT Item Substitution





To reverse a substitution:

- On the substituted item: Delete the *Replaced with* value(s) using the Replaced with delete button.
- Delete the replacement item using the Item Delete button.

APT Items Page: Academic Item Attempt Level

An APT item can have multiple attempts. For example, if a student needs to retake a Year 1 course during Year 2, you could add a new attempt row under the Year 1 item, rather than moving that item from year to year. Each attempt has attributes attached to it.

This example illustrates the fields and controls on the APT Items page (Academic Item Attempt level). You can find definitions for the fields and controls later on this page.

<i>Field or Control</i>	<i>Description</i>
 Create New Attempt	This button is available if the attempt Eligible for Retake check box is selected (see information about this check box later in this section). When you click this button, a new attempt row is created for this item. The system also creates new attempts for any unlocked child item attempts for which the Eligible for Retake check box is selected. This is optional.
 Add Notes	Transfers to a secondary page Item Attempt Notes where you can add notes and comments.
	Locks the attempt. A locked item attempt cannot be updated: all fields at the attempt and result level are display only.
	Unlocks the item attempt.
Attempt Nbr	A system assigned value. Multiple attempts can exist for an APT item.

Field or Control	Description
Approval Status	<p>This field is used when approval is required for enrollment planning - that is, when an advisor must approve the course entries in the student's APT for a particular stage/study period before the student enrolls. The approval requirement is based on the Requires Approval check box on the Academic Item Registry page.</p> <p>Note: This feature is planned for the future.</p>
Attempt Status	<p>This field indicates that enrollment/credit requirements for an item attempt have been completed (<i>20: Completed</i>) and when the attempt can be counted towards satisfying the item itself and for result calculation (<i>60: Finalized</i>).</p>
Attempt Outcome	<p>This field will indicate whether the item attempt was successfully completed.</p>
Print in Transcript	<p>This value can be used to determine if an item attempt is included in user defined transcript or report.</p>
Eligible for Retake	<p>If the value in this field is <i>Yes</i>, the item can be retaken. This field is used to determine whether a new attempt is created.</p> <p>Refer to the "Managing Retake Processing" documentation section later in this topic.</p>
Include in Calculation	<p>When multiple attempts exist, select this check box to indicate which attempt should be used to determine the status/result for an academic item. The check box is selected by default.</p>
Course ID, OfferNbr, and Course Topic ID	<p>These values display for Course academic items</p>

Academic Item Attempt Schedule grid:

For information about Personalized Timeline,

See [Using the APT Timeline](#)

Field or Control	Description
Seq Nbr	<p>A system assigned number. An academic item attempt can have more than one schedule sequence. This could happen if a student completes an item over a number of terms. A typical example might be where a program is organized into Year 1, Year 2 and so on and where a part time student could take more than the prescribed 2 semesters to complete the requirements.</p>
Year of Program	<p>This field is populated when:</p> <ul style="list-style-type: none"> • APT row has an Academic Item Type which is equated to Year of Program (in the program format definition for the program). • APT row has an Academic Item Type which is equated to Term (in the program format definition for the program). • APT row has an Academic Item Type of COURSE.
Academic Year	<p>This field is populated when</p> <ul style="list-style-type: none"> • The student's APT header has an Enrollment Cohort value which been mapped to term values (this is not required) or a Personalized Timeline has been established and • APT row has an Academic Item Type which is equated to Term (in the Program Format definition for the program). • APT row has an Academic Item Type of COURSE.
Term	<p>This field is populated when:</p> <ul style="list-style-type: none"> • The student's APT header has an Enrollment Cohort value which been mapped to term values (this is not required) or a Personalized Timeline has been established and • APT row has an Academic Item Type which is equated to Term (in the Program Format definition for the program). • APT row has an Academic Item Type of COURSE.

Field or Control	Description
Session	<p>This field is populated when:</p> <ul style="list-style-type: none"> • The student’s APT header has an Enrollment Cohort value which been mapped to term and session values (this is not required) or a Personalized Timeline has been established and • APT row has an Academic Item Type which is equated to Term (in the Program Format definition for the Program). • APT row has an Academic Item Type of COURSE. <p>See: Assigning Year of Program, Academic Year and Term (STRM) Values to Academic Items added to APT later in this section.</p>
Academic Period	<p>This field is for future use.</p>
Start Date and End Date	<p>The start and end dates for the academic item. These fields are intended primarily for non-course based academic items that might not necessarily be scheduled in term/session—an internship for example. These dates can be used to provide a time frame for an item that is not tied to a formal academic teaching period.</p> <p>For course items, the Start Date and End Date fields are replaced with the other fields as in the following example page.</p>

This example illustrates the fields and controls on the APT Items Page (Course item example). You can find definitions for the fields and controls later on this page.

0000000060 - Course: ECON 2: Macroeconomic Principles

*APT Item Seq 📄 + - 📱 🔒

Parent Item Seq Nbr 📄

Academic Item ID 0000000388 ECON 2: Macroeconomic Principles

AIR Parent Item ID 0000001756 BA Econ - Year 1 - Semester 1

Academic Item Type Course Grading Item Type

Enrollment Category Exam Only Option

Item Weight Substituted

Reason Code

*Satisfied Include in Calculation

Academic Item Attempt Find | View All First 1 of 1 Last

*Attempt Nbr 📄 🔒

*Approval Status

Attempt Status

Attempt Outcome

Eligible for Retake

Include in Calculation

Print in Transcript

Course ID 666669 Macroeconomic Principles

Offer Nbr 1 Subject / Catalog ECON 2

Course Topic ID 0

Audit Fields

Academic Item Attempt Schedule Personalize | Find 📄 📊 First 1 of 1 Last

Schedule Audit Fields

Year of Program	Academic Year	Term	Description	Academic Period	*Progress Level	Credit Type	Search
1st Year	2013	0690	2012 Fall		40-In Progress	Enrollment	Search

Career	Term	Class Nbr	Enrollment Status	Units	Grade Scheme	Grading Basis	Official Grade
Undergraduate	2012 Fall	1728	Enrolled	3.00	Undergraduate Grading Scheme	Graded	

Field or Control	Description
Progress Level	<p>Indicates the status of the COURSE being applied to this item/attempt.</p> <p>When a course item is added to APT, this value is set to <i>Planned</i>. After a student is enrolled in a class section of the course, the value is set to <i>In Progress</i>. If the student subsequently drops the class section and it is deleted from STDNT_ENRL or retained in 'Dropped' status, the Progress Level value is set to <i>Dropped</i>. The level is set to <i>Completed</i> after a grade is present in STDNT_ENRL (the grade must earn credit).</p> <p>See Managing APT Enrollment</p> <p>See the Student Enrollment Event document in My Oracle Support (ID 1400723.1).</p>

Field or Control	Description
Credit Type	Indicates whether the course is being completed or was completed through class enrollment or from transfer credit.
Search	Launches a process to find a match for the COURSE item in STDNT_ENRL or Transfer Credit Model (including Test and Other Credit).
Career	Displays the student's career for the matching STDNT_ENRL row (as opposed to the course career).

Values appear in the remaining fields based on the matching STDNT_ENRL row.

Here is an example in which the Credit Type is Transfer Credit:

This example illustrates the fields and controls on the APT Items page (Credit Type example). You can find definitions for the fields and controls later on this page.

0000000060 - Course: ENGLIT 106: Introduction to Reading Poetry

*APT Item Seq 📄 + - 📄

Parent Item Seq Nbr 📄

Academic Item ID 0000000657 ENGLIT 106: Introduction to Reading Poetry

AIR Parent Item ID 0000001273 BA (Hons) English Level 4 Semester 1 Mand Courses

Academic Item Type Course Grading Item Type

Enrollment Category Exam Only Option

Item Weight Substituted

Reason Code

*Satisfied Include in Calculation

Academic Item Attempt Find | View All | First 1 of 2 | Last

*Attempt Nbr 📄

*Approval Status

Attempt Status

Attempt Outcome Include in Calculation

Eligible for Retake Print in Transcript

Course ID 667467 Introduction to Reading Poetry

Offer Nbr 1 Subject / Catalog ENGLIT 106

Course Topic ID 0

Audit Fields

Academic Item Attempt Schedule Personalize | Find | 📄 | 📄 | First 1 of 1 | Last

Year of Program	Academic Year	Term	Description	Session	Academic Period	*Progress Level	Credit Type	Search
1st Year	2014	2140	2014-2015 Academic Year	Semester 1		60-Completed	TC-Course	Search

Career	Transfer Model Nbr	Articulation Term	Group	Seq#	Units	Grade Scheme	Grading Basis	Official Grade
Undergraduate		1 2014-2015 Academic Year	1	1	15.000	Alpha Grading Scale	Alpha Graded Scale	A-

Values in the fields such as Career, Transfer Model Nbr and so on appear based on the matching Transfer Credit row.

APT Items Page: Attempt Schedule Search

This feature simulates the processing that occurs after a student is enrolled by providing a link to the source of the course credit. For enrollment, this link is established by an Enrollment Sync process that performs updates to a student's APT instance after enrollment is processed by the enrollment engine.

See [Managing APT Enrollment](#)

See the Student Enrollment Event document in My Oracle Support (ID 1400723.1).

The Search function creates this link by finding a match for a particular course and save the keys to the enrollment or transfer credit row in the appropriate table. The search process attempts to find a match in STDNT_ENRL and Transfer Credit, using the EMPLID and INSTITUTION of the instance as well as the CRSE_ID, CRSE_OFFER_NBR, and CRSE_TOPIC_ID (if they are present). If more than one match is found, you can select from the results.

Enrollment (STDNT_ENRL):

- When the matching row is selected, the row is saved to a new table SSR_APT_ENRL.
- Academic Year/Term on the schedule row is updated if the term of the matching course is different. For example, if a course is assigned to 0690 and the only match is in 0630, the term and academic year values are updated.

Transfer Credit

- When the matching row is selected, the row is saved to a new table SSR_APT_TRCR.
- Academic Year/Term on the schedule row is updated if the articulation term of the matching course is different. For example, if a course is assigned to 0690 and the only match is in 0630, the term and academic year values are updated.

APT Items Page: Assigning Year of Program, Academic Year and Term (STRM) Values to Academic Items added to APT

Although the APT data is not defined by term, you still need to track data by academic year/term as well as by the Year of Program (YOP) attribute. Using a combination of the Program Format definition attached to the PRG item and (if one exists) the Enrollment Cohort term and definition for the student, data is recorded as items are added to the APT so that you can query the data by academic year, term, or a student's year of program.

Here is an example of Program Format/Enrollment Cohort data:

Program Format data:

Program Format

Institution PeopleSoft University

Format ID UG_3YR_PHASE

***Description**

▼ **Item Type Usage**

Planning Node	PHASE	Phase
Year of Program	STAGE	Stage of Program
Equates to Term	STUDYPERIOD	Study Period

Add Session Level

▼ **Date Controls**

Student Planning Academic Period Table

▼ **Tree View**

- └─ 1 - Program
 - └─ 10 - Part I
 - └─ 100 - Year 1
 - └─ 110 - Year 1 - Semester 1
 - └─ 120 - Year 1 - Semester 2
 - └─ 20 - Part II
 - └─ 200 - Year 2
 - └─ 210 - Year 2 - Semester 1
 - └─ 220 - Year 2 - Semester 2
 - └─ 300 - Year 3
 - └─ 310 - Year 3 - Semester 1
 - └─ 320 - Year 3 - Semester 2

Enrollment Cohort data:

Enrollment Cohort

Academic Institution PeopleSoft University
 Academic Career Undergraduate
 Format ID UG_3YR_PHASE UG 3 Year - Part 1 and 2
 *Description UG 3YR I & II Fall

▼ Term Categories to Include

Term Category		
1 Regular Term	+	-

Refresh Term Prompts

*Academic Load Full-Time Cohort Tag FALL-ADMITS
 *Cohort Term 0730 2014 Fall
 Generate

*Seq Nbr	*Node ID	Node Description	*Term	Term Description	Planning Period	Description		
100	110	Year 1 - Semester 1	0730	2014 Fall	999999999999	Always Open	+	-
200	120	Year 1 - Semester 2	0740	2015 Spring	999999999999	Always Open	+	-
300	210	Year 2 - Semester 1	0750	2015 Fall	999999999999	Always Open	+	-
400	220	Year 2 - Semester 2	0760	2016 Spring	999999999999	Always Open	+	-
500	310	Year 3 - Semester 1	0770	2016 Fall	999999999999	Always Open	+	-
600	320	Year 3 - Semester 2	0780	2017 Spring	999999999999	Always Open	+	-

The Program Format nodes which are equated to Year of Program and Term determine which academic items will be used to record year of program, academic year, and term data in APT.

A session level can also be defined for use in term configurations where a term (STRM) value represents an academic year and a session (SESSION_CODE) is used to represent 'term' (for example, semester 1, semester 2). See: Academic Year and Term Data with Session Level section below.

See [Setting Up Program Formats](#)

Equates to Year of Program Items: Year of Program Data:

Equates to Year of Program example:

The screenshot shows a configuration window for an academic item. At the top, it is titled "0000000040 - Stage: BA Econ - Year 1". Below this, there are input fields for "*APT Item Seq" (value: 40) and "Parent Item Seq Nbr" (value: 30). A highlighted box contains the following information: "Academic Item ID 0000001755 BA Econ - Year 1" and "AIR Parent Item ID 0000001754 B.A. Economics Part I". Below these are fields for "Academic Item Type" (set to "Stage of Program"), "Item Weight" (value: 1), "Reason Code", and "*Satisfied" (set to "No"). There are also checkboxes for "Grading Item Type", "Exam Only Option", and "Include in Calculation" (checked).
 The "Academic Item Attempt" section includes fields for "*Attempt Nbr" (value: 1), "*Approval Status" (set to "Not Required"), "Attempt Status" (set to "Activated"), "Attempt Outcome", and "Eligible for Retake". It also has checkboxes for "Include in Calculation" (checked) and "Print in Transcript" (checked).
 The "Academic Item Attempt Schedule" section is highlighted with a red box and contains a table with the following data:

*Seq Nbr	Year of Program	Academic Year	Term	Description	Academic Period	Start Date	End Date	Search
1	1st Year	2013	0690	2012 Fall				Search
2	1st Year	2013	0700	2013 Spring				Search

- A year of program value is assigned as the academic items equated to Year of Program (in the Program Format definition) are added to the APT.

Academic Year, Term and Session (if applicable) values are also assigned. In this case the term value is assigned based on the term values that are assigned to the child equates to term item (BA Econ Year 1 - Semester 1 - see below).

- The example above shows Year 1 – B.A. Economics. When Year 2 is added (as a result of seeding or a course being added to APT) this will be assigned to 2nd Year and so on.

Equates to Term (EQT) Items: Year of Program, Academic Year and Term Data:

This data is recorded for the following:

- Academic Item(s) equated to Term (in the program format definition for the program).
- All COURSE academic items.

A year of program, academic year (derived from the term) and term are recorded for each of these.

Equates to Term example:

For information about Personalized Timeline,

See [Using the APT Timeline](#)

Field or Control	Description
Year of Program	If the item is also equated to year of program, this value is taken from the Program Format definition; otherwise the value is determined using the program definition value for a parent, grandparent and so on. In this example, the YOP value from the parent STAGE item is used to determine the value for the STUDYPERIOD.
Academic Year	The TERM_TBL.ACAD_YEAR value for the term value (STRM) returned from the Enrollment Cohort or Personalized Timeline (see Term).

Field or Control	Description
Term	Uses the Node ID associated with the Academic Item Type in the Program Format definition, to fetch the term value from the student's Enrollment Cohort or Personalized Timeline (if one exists). In this example, the STUDYPERIOD academic item has been identified as equating to term. A look-up is performed on the Enrollment Cohort using the Node IDs defined in the Program Format (this should be consistent if programs are defined using Build Program by Format).
Session	If the Program Format includes session level and the Enrollment Cohort or Personalized Timeline has Equates to Term nodes mapped to combinations of Term and Session, a session value will also be assigned.

Academic Year and Term Data with Session Level:

Year of Program and Equates to Term (and Session) levels can be tracked separately if the program format is defined this way. The following example shows an enrollment cohort based on a program format that has distinct equates to term (YEAR) and session (SEMESTER) items and how this data is recorded in APT:

Program Format example:

Program Format

Institution PeopleSoft University UK

Format ID DS_UG_3YR_SEM

***Description** -

Item Type Usage

***Planning Node** 🔍 Stage of Program

Year of Program YEAR Year

Equates to Term YEAR Year

Add Session Level

Session 🔍 Semester

Date Controls

Student Planning Academic Period Table

Tree View

- └─ [1 - Program](#)
 - └─ [10 - Year 1](#)
 - └─ [101 - Semester 1](#)
 - └─ [102 - Semester 2](#)
 - └─ [20 - Year 2](#)
 - └─ [201 - Semester 3](#)
 - └─ [202 - Semester 4](#)
 - └─ [30 - Year 3](#)
 - └─ [301 - Semester 5](#)
 - └─ [302 - Semester 6](#)

Enrollment Cohort example:

Enrollment Cohort

Academic Institution PeopleSoft University UK
 Academic Career Undergraduate
 Format ID UK-3YR-SEM-PRG 3 Yr Programme with Semester
 *Description UK 3 Year Programme - Semester

▼ Term Categories to Include

Term Category		
1 1st Semester	+	-
2 2nd Semester	+	-

Refresh Term Prompts

*Academic Load Full-Time
 Cohort Tag SEP-2013-14
 *Cohort Term 2130 2013-2014 Academic Year

Generate

*Seg Nbr	*Node ID	Node Description	*Term	Term Description	Session	Description
100	20	Year 1	2130	2013-2014 Academic Year		
200	25	Semester 1	2130	2013-2014 Academic Year	Semester 1	
300	30	Semester 2	2130	2013-2014 Academic Year	Semester 2	
400	35	Year 2	2140	2014-2015 Academic Year		
500	40	Semester 1	2140	2014-2015 Academic Year	Semester 1	
600	45	Semester 2	2140	2014-2015 Academic Year	Semester 2	
700	50	Year 3	2150	2015-2016 Academic Year		
800	55	Semester 1	2150	2015-2016 Academic Year	Semester 1	
900	60	Semester 2	2150	2015-2016 Academic Year	Semester 2	

With this configuration, the Year of Program and Equates to Term values are tracked at different levels because term can now be tracked down to the session level:

Equates to Term item:

0000000020 - Year: BA (Hons) Year 1 English Lit & Classical Writing

*APT Item Seq 20
 Parent Item Seq Nbr 10

Academic Item ID 00000002286 BA (Hons) Year 1 English Lit & Classical Writing
 AIR Parent Item ID 00000002285 BA (Hons) English Literature and Classical Writing

Academic Item Type Year
 Grading Item Type
 Exam Only Option

Item Weight 1
 Reason Code
 *Satisfied No Include in Calculation

Academic Item Attempt

*Attempt Nbr 1
 *Approval Status Not Required
 Attempt Status Activated
 Attempt Outcome
 Eligible for Retake Include in Calculation Print in Transcript

Audit Fields

Academic Item Attempt Schedule

*Seg Nbr	Year of Program	Academic Year	Term	Description	Session	Academic Period	Start Date	End Date	Search
1	1st Year	2013	2130	2013-2014 Academic Year					Search

Equates to Session Level item:

The screenshot displays the Oracle APT system interface for an item. At the top, the title is "0000000030 - Semester: BA (Hons) Yr 1 Sm1 English Lit & Classical Writing". Below this, there are several input fields:

- *APT Item Seq: 30
- Parent Item Seq Nbr: 20
- Academic Item ID: 00000002287 (BA (Hons) Yr 1 Sm1 English Lit & Classical Writing)
- AIR Parent Item ID: 00000002286 (BA (Hons) Year 1 English Lit & Classical Writing)
- Academic Item Type: Semester
- Item Weight: 1
- Reason Code: (empty)
- *Satisfied: No
- Grading Item Type:
- Exam Only Option:
- Include in Calculation:

 Below these fields is the "Academic Item Attempt" section, which includes:

- *Attempt Nbr: 1
- *Approval Status: Not Required
- Attempt Status: Activated
- Attempt Outcome: (empty)
- Eligible for Retake: (empty)
- Include in Calculation:
- Print in Transcript:

 At the bottom, there is an "Audit Fields" section containing an "Academic Item Attempt Schedule" table. The table has columns for Seq Nbr, Year of Program, Academic Year, Term, Description, Session, Academic Period, Start Date, End Date, and Search. The first row shows:

Seq Nbr	Year of Program	Academic Year	Term	Description	Session	Academic Period	Start Date	End Date	Search
1	1st Year	2013	2130	2013-2014 Academic Year	Semester 1				Search

Course Items:

YOP, Academic Year and Term data is recorded for COURSE items as they are added to APT (either through the seeding process or as an individual course is added). The values are assigned in one of two ways:

1. The value is derived from the parent item when that item is equated to YOP and/or term (for example if a course is the child of a study period). See a) below.
2. If the COURSE (or its parent) is not directly linked to an item that is equated to a term, the value is manually assigned by the user selecting from a list of values. See b) below and also see the following section "Assigning Term Values to Courses".

Course Items example:

The screenshot displays a software interface for managing course items. At the top, it shows the course title "0000000040 - Course: ENGLIT 138: The Epic Tradition". Below this, there are input fields for "APT Item Seq" (40) and "Parent Item Seq Nbr" (30). A central box highlights the following details: Academic Item ID 0000002279, ENGLIT 138: The Epic Tradition; AIR Parent Item ID 0000002287, BA (Hons) Yr 1 Sm1 English Lit & Classical Writing; Academic Item Type Course; and checkboxes for "Grading Item Type", "Exam Only Option", and "Substituted". Other fields include "Enrollment Category" (Mandatory), "Item Weight" (1), "Reason Code", "*Satisfied" (No), and "Include in Calculation" (checked).

The "Academic Item Attempt" section includes fields for "*Attempt Nbr" (1), "*Approval Status" (Not Required), "Attempt Status", "Attempt Outcome", and "Eligible for Retake", along with checkboxes for "Include in Calculation" and "Print in Transcript". It also lists "Course ID 667967", "Offer Nbr 1", "Course Topic ID 0", and "Subject / Catalog ENGLIT 138".

The "Audit Fields" section contains an "Academic Item Attempt Schedule" table with the following data:

Year of Program	Academic Year	Term	Description	Session	Academic Period	*Progress Level	Credit Type	Search
1st Year	2013	2130	2013-2014 Academic Year	Semester 1		20-Planned		Search

a) If the value is derived as the COURSE is added:

- Year of Program: If the COURSE (or its parent, grandparent) is linked to an academic item that equates to both YOP and term, the YOP from this item is used; otherwise the YOP value is derived from the parent of the item that equates to term. In this example, the COURSE is a child of a STUDYPERIOD (which equates to term), the STUDYPERIOD is child of STAGE which equates to YOP, and therefore the value from the parent STAGE is used here.
- Academic Year: The TERM_TBL.ACAD_YEAR value for the term value (STRM) returned from the Enrollment Cohort or Personalized Timeline (see Term).
- Term: If the COURSE is linked to an academic item which equates to term, the value is derived from parent/grandparent and so on.
- Session: If the Program Format includes session level and the Enrollment Cohort or Personalized Timeline has Equates to Term nodes mapped to combinations of Term and Session, a session value will also be assigned.

b) If the value is selected by a user:

- Year of Program: Is assigned by using the YOP value from the academic item (if the academic item equates to term and also equates to YOP); otherwise the YOP value is derived from the parent of the Equates to Term item.

- Academic Year: The TERM_TBL.ACAD_YEAR value for the term value (STRM) returned from the Enrollment Cohort or Personalized Timeline (using the academic item selected during term choice).
- Term: The TERM_TBL.STRM value from the Enrollment Cohort or Personalized Timeline for the item selected during term choice (using the academic item).
- Session: If the Program Format includes session level and the Enrollment Cohort or Personalized Timeline has Equates to Term nodes mapped to combinations of Term and Session, the user will actually select a combination of term and session.

APT Items Page: Assigning Term Values to Courses

This section discusses choosing a “term” for a COURSE item that is not associated (according to lineage) with an academic item equating to term.

An AIR COURSE, COURSELIST, COURSEGROUP or any user defined grouping of courses can be placed at any level in a program structure. A COURSELIST could be situated in the structure in such a way that while a student is required to complete them, they may do so at any point in the program. The program used in this example has a basic structure like this:

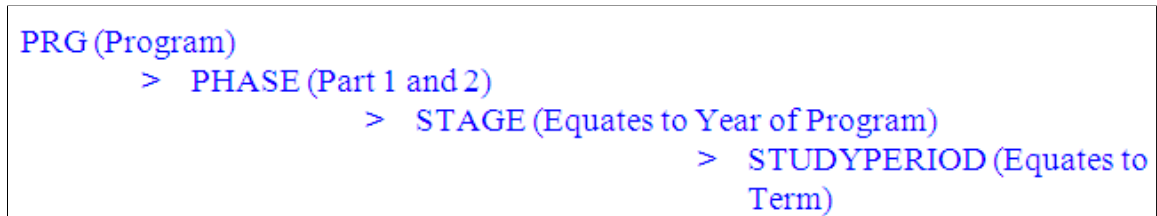

Any COURSE items that are associated with STUDYPERIOD items can be assigned a term using the Enrollment Cohort or Personalized Timeline (if one exists). However, you cannot know the term in which a COURSE associated with items above that level (PRG, PHASE, STAGE) is to be taken until the student actually plans/enrolls. In the example program used in this document, “Part 2” is comprised of two stages (Year 2 and 3) but there is a list of courses that the student must complete at some point during those two years.

This example illustrates the Item Details page (assigning term values to courses).

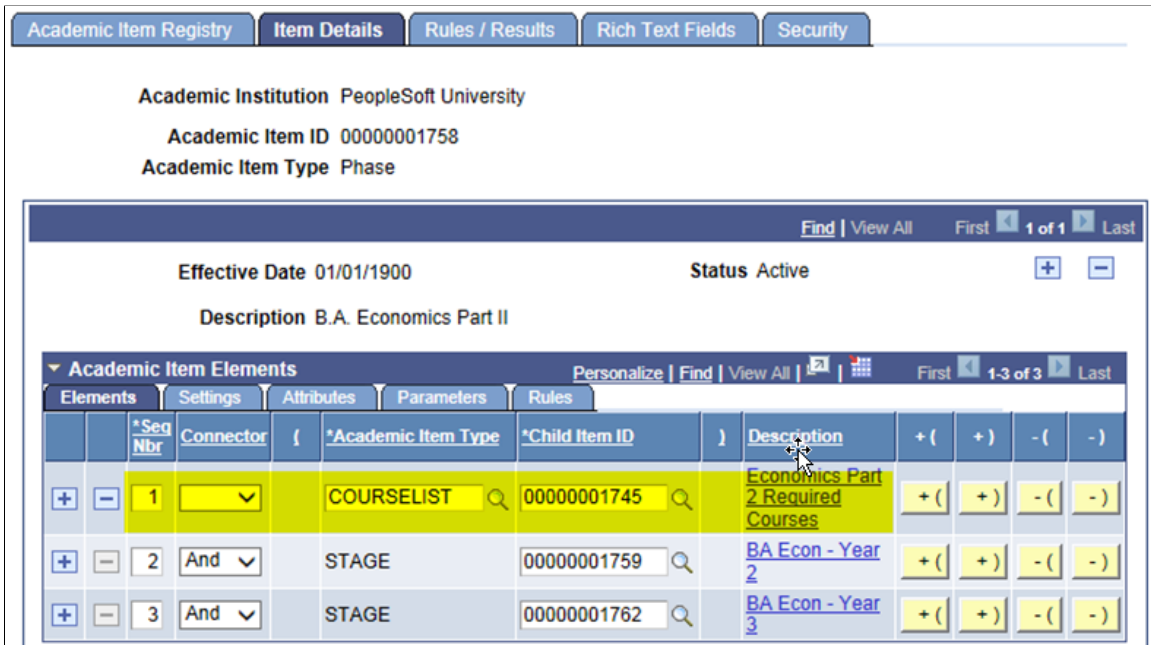

This will be represented in APT as follows:

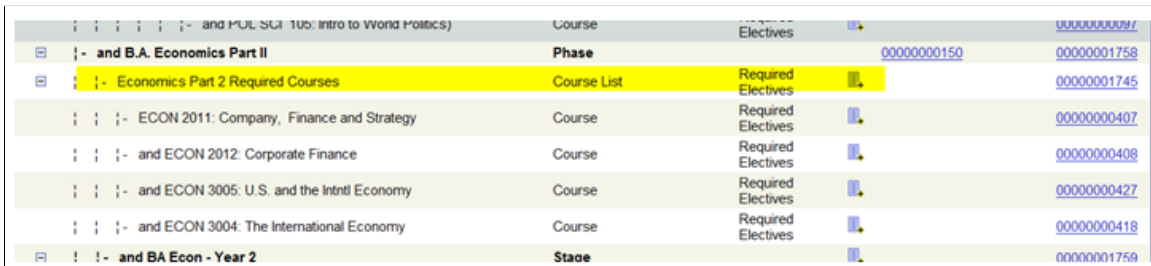

The Course List is a direct child of Part 2 and is not associated with a Stage (which equates to Year of Program) or Study Period (which equates to Term).

When a student (or advisor/administrator) selects a course that is placed in a program structure in this way, it ultimately must be assigned to a term for planning and enrollment purposes. To do this, the system must:

- Evaluate the children of the item where the course is situated.
- Determine which of those child items equates to term (this is determined by Program Format, where an Equates to Term value is required).
- Return a list of those items and prompt the user to assign one to the course.

In the example above, the courses are tied to the Phase level of the program structure. The immediate children of the PHASE item (other than the COURSELIST itself) are STAGE items, which equate to YOP. So in this particular case the system must go down another level. The STAGE items each have two child STUDYPERIOD items, which equate to term. All four of these must be available to the user, because this is the level at which enrollment will take place:

- User adds a course to APT:

This example illustrates adding a course to APT (step 1).

Phase	Required	Electives	Item ID
and BA, Economics Part II			00000001758
Economics Part 2 Required Courses	Required	Electives	00000001745
ECON 2011: Company, Finance and Strategy	Required	Electives	00000000487
and ECON 2012: Corporate Finance	Required	Electives	00000000408
and ECON 3005: U.S. and the Int'l Economy	Required	Electives	00000000427
and ECON 3004: The International Economy	Required		00000000427

- Child items equating to term are retrieved

The choices can be presented with user defined (message catalog text)

This example illustrates adding a course to APT (step 2).

Additional information needed for Courses / Course Groups:

This course may be taken anytime within BA, Economics Part II. Which study period would you like to schedule this for?

Select	Description
<input type="checkbox"/>	BA Econ - Year 2 - Semester 1
<input checked="" type="checkbox"/>	BA Econ - Year 2 - Semester 2
<input type="checkbox"/>	BA Econ - Year 3 - Semester 1
<input type="checkbox"/>	BA Econ - Year 3 - Semester 2

OK Cancel

- The item is saved to APT. The lineage (as defined in AIR) is preserved, in this example BA Econ = Year 2 – Semester 2.

For Year of Program/Term reporting purposes however, the course selection is associated with 2nd Year, Term 0730.

This example illustrates adding a course to APT (step 3).

0000000210 - Course: ECON 2012: Corporate Finance

*APT Item Seq

Parent Item Seq Nbr

Academic Item ID 0000000408 ECON 2012: Corporate Finance

AIR Parent Item ID 0000001745 Economics Part 2 Required Courses

Academic Item Type Course

Enrollment Category

Item Weight

Reason Code

*Satisfied

Grading Item Type

Exam Only Option

Substituted

Include in Calculation

Academic Item Attempt Find | View All First 1 of 1 Last

*Attempt Nbr

*Approval Status

Attempt Status

Attempt Outcome

Eligible for Retake

Include in Calculation

Print in Transcript

Audit Fields

Academic Item Attempt Schedule Personalize | Find First 1 of 1 Last

Year of Program	Academic Year	Term	Description	Academic Period	*Progress Level	Credit Type	Search
<input type="text" value="2nd Year"/>	<input type="text" value="2015"/>	<input type="text" value="0730"/>	<input type="text" value="2014 Fall"/>	<input type="text"/>	<input type="text" value="20-Planned"/>	<input type="text"/>	<input type="text" value="Search"/>

Managing Retake Processing

The Eligible for Retake field determines whether an academic item can be repeated at a future point in a student's program of study.

If the Item is a Program Format tree planning node: the APT Request process can be used to build a new attempt for that planning node as well as any child program format tree nodes and other child items (such as courses) that are eligible for retake. If a student needs to re-take an entire program node, such as a year or semester, we recommend the following steps:

- Set the Eligible for Retake field to *Yes* on the Planning Node and any child Equates to Term/Session nodes (if applicable). Also identify all child items (courses, course lists etc.) that must be retaken.
- Create a Personalized Timeline and adjust the term mapping as required. For example, if a student attempted Year 1 in term 2014 Academic year (term code 2014) and is required to re-take Year 1 during the next academic year, the personalized timeline would need to be adjusted such that Year 1 is now mapped to the term code for 2015 Academic Year, with any subsequent years adjusted accordingly.

See [Using the APT Timeline](#)

- Use the APT Request process to create a new attempt against the Year 1 planning node. This creates new attempts for all eligible academic items and assigns those items to the appropriate term/session.

See [Creating and Managing APT Instances Using the APT Request Process](#)

A course retake can be handled in one of two ways, depending on whether or not the retake needs to occur at a specific point in the remainder of the student's program of study:

- Retake at a specific point: if a student needs to retake the item at a set point in time, for instance retaking Year 1 course during Year 2:
 - Set the Eligible for Retake field to *Yes* on the original attempt.
 - Use the Create New Attempt button to create a new attempt against the course in APT.
 - Enter Academic Item Attempt schedule data for the new attempt.
 - Create and activate the next planning node (Year 2 , to use the same example) using APT Request.

In student self-service, this makes the course available as an item to be retaken in the specified term/session node on the My Education Plan component *once the term/session node for the original attempt has been finalized*.

- Student is allowed to retake at any point during the remainder of the program:
 - Set the Eligible for Retake field to *Yes* on the original attempt.
 - Create and activate the next planning node (Year 2 , to use the same example) using APT Request.

This option allows the student to select the course on the My Education Plan in any subsequent (active) term node once the term/session node for the original attempt has been finalized. When the course is selected, a new attempt is created for the course, with the schedule data for the term node where it was selected. If the student decides not to take the course at that point, the attempt and associated schedule data are removed from APT when the course is de-selected and the My Education Plan component is saved.

Recording Term-Related Data in APT When Students Are Not Assigned to an Enrollment Cohort or Personalized Timeline

The ability to auto-assign term-related data as items are added to APT without referencing a predefined cohort or personalized timeline is planned for the future.

APT Items Page: Academic Item Attempt Results Level

The APT structure is not delivered with a predefined set of fields for statistics and results (total units, grade points and so on). You must define the types of statistics and results that you want to track for your students, using the Result Type component. The number and type of results associated with a particular academic item (for example, a course, semester) are determined by the academic item definition (in AIR), where you indicate which results will be tracked for a particular academic item.

See [Setting Up Result Types](#)

This level of the structure allows you to track multiple versions of the same result type. For example, a Year of Program might have a Result Type of *Weighted Average Mark* associated with it. An institution might need to record the *calculated* version of this result (that is, the result calculated by a rules engine or uploaded from an external source) and the *finalized* version (which could be different from the calculated version) delivered from an exam or other review board. In this case, the Results grid would have two rows for the result type *Weighted Average Mark*. Obviously only one of the results would be used for calculating higher level results and for transcript purposes, but both results would be recorded.

Select the Results tab:

This example illustrates the fields and controls on the APT Items page: Results tab. You can find definitions for the fields and controls later on this page.

*Result Nbr	*Result Type	Result Scale	Result Value	*Result Status	Include in Calc		
10	COURSE_CREDITS		0.00	00-Undete	<input type="checkbox"/>	+	-
20	COURSE_RESULT	REG-100	0.00	00-Undete	<input type="checkbox"/>	+	-
30	GRADE_POINTS		0.000	00-Undete	<input type="checkbox"/>	+	-

An academic item attempt can have multiple result types associated with it.

Field or Control	Description
Result Nbr	System assigned sequence number.
Result Type	Prompts against Result Type table for the Institution. Note: The Result Type view has been modified to include Result Types that have Result Scales marked as Grade only. Any result types created before October 2014 should be saved again so that that they are available in the Result Type prompt.
Result Scale	You assign a Result Scale to a Result Type on the Result Type page (Set Up SACR, Product Related, Student Records, Program Enrollment, Result Type). Result Type inherits the field definition (Numeric) from the Result Scale – for example, a 10.0 point scale.
Result Value	This value is based on the Result Type setup.
Result Status	Indicates the status of the result. You can use this field to record a change to an existing Result Type row, or to indicate the status of a new instance of the same result type.
Include in Calc	Indicates that a Result Type row should be used in calculating a higher level result. When there is more than one instance of the same result type, only one has the check box selected. Note: This feature is planned for the future.

See [Setting Up Result Types](#)

Select the Grades tab:

This example illustrates the fields and controls on the APT Items page: Grades tab. You can find definitions for the fields and controls later on this page.

*Result Nbr	*Result Type	Grading Scheme	Grading Basis	Grade	Grade Points	Outcome
10	COURSE_CREDITS					
20	COURSE_RESULT	GRA	GRE	B	3.000	Passed
30	GRADE_POINTS					

Field or Control	Description
Grading Scheme	Controls the Grade prompt. Available if the Result Type has a Result Scale which is configured to allow include grade.
Grading Basis	Controls the Grade prompt. Available if Result Type has a Result Scale configured to allow include Grade. The field prompts against the Grading Basis for the selected Grading Scheme.
Grade	Allows for the recording of a core grade for the result type. Available if Result Type has a Result Scale configured to allow include grade. The field prompts against the Grade table for the selected Grading Scheme/Basis.
Grade Points	Displays the grade point value (from the GRADE_TBL) for the grade.
Outcome	If a result scale is associated with the result type, the result outcome can default from the result value or grade. It can also be set based on the evaluation of a rule, that is, the rule calculates the result and updates the result row with the result and outcome. The conditional value is used to record a result that must be confirmed by an exam board or other body. The result could be confirmed by the creation of another row with a Passed or Failed outcome.

Select the Administrative tab:

This example illustrates the fields and controls on the APT Items page: Administrative tab. You can find definitions for the fields and controls later on this page.

Result Nbr	Result Type	Reason Code	Description	Notes	Locked	Show Student		
10	COURSE_CREDITS	COMP	Result Compensation			<input type="checkbox"/>		
20	COURSE_RESULT	EXC	Exception			<input type="checkbox"/>		
30	GRADE_POINTS	COMP	Result Compensation			<input type="checkbox"/>		

Field or Control	Description
Reason Code	<p>You can enter a reason code for a result row. For example, a student may be granted a higher result and compensation due to ill-health or other mitigating circumstances or a result may be excluded due to plagiarism.</p> <p>See Setting Up APT Reason Codes</p>
Show Student	<p>This field can be used when defining the logic of the XMLP Results Template, which is user-defined. The logic within this template could use this field to determine whether the result should be displayed for the student.</p>

APT Items Page: Assigning Result Types to APT Academic Items

Result Types are associated with academic items in AIR using the Result Types grid to indicate which Result Types are attached to a particular academic item.

See [Defining Academic Item Details](#)

When an item is added to an APT instance, Academic Item Attempt Result rows are created for all result types linked to that academic item in AIR.

Using the APT Timeline

Access the Timeline page (**Records and Enrollment > Program Enrollment > Academic Progress Tracker > Timeline**).

This example illustrates the fields and controls on the Timeline page. You can find definitions for the fields and controls later on this page.

Header
AIR Tree
APT Tree
APT Items
Timeline

Robert Jones SR13564

Academic Institution PeopleSoft University

APT Instance 1 Instance Status Active

▼ Enrollment Cohort Timeline
Personalize | Find | View All | | First 1-6 of 6 Last

Node ID	Description	Term	Description	Academic Year
110	Year 1 - Semester 1	0630	2009 Fall	2010
120	Year 1 - Semester 2	0640	2010 Spring	2010
210	Year 2 - Semester 1	0650	2010 Fall	2011
220	Year 2 - Semester 2	0660	2011 Spring	2011
310	Year 3 - Semester 1	0670	2011 Fall	2012
320	Year 3 - Semester 2	0680	2012 Spring	2012

Create Personalized Timeline

View a student’s enrollment cohort data and override that data if necessary.

<i>Field or Control</i>	<i>Description</i>
Create Personalized Timeline	If you click this button, the enrollment cohort is copied down to the APT level and you can change term/session data. After it is created, the personalized timeline is used to assign YOP, Term and Session in APT.

Here's an example of a personalized timeline:

Personalized Timeline				Personalize Find View All		First	1-7 of 7	Last
*Node ID	Description	*Term	Description	Period ID	Description	Academic Year		
110	Year 1 - Semester 1	0630	2009 Fall	999999999999	Always Open	2010		
120	Year 1 - Semester 2	0640	2010 Spring	999999999999	Always Open	2010		
120	Year 1 - Semester 2	0700	2013 Spring	999999999999	Always Open	2013		
210	Year 2 - Semester 1	0710	2013 Fall	999999999999	Always Open	2014		
220	Year 2 - Semester 2	0720	2014 Spring	999999999999	Always Open	2014		
310	Year 3 - Semester 1	0725	2014 Summer	999999999999	Always Open	2014		
320	Year 3 - Semester 2	0750	2015 Fall	999999999999	Always Open	2016		

Note: If there are multiple rows with same node ID in Academic Progress Tracker (APT) Timeline (in Enrollment Cohort Timeline or Personalized Timeline), then the APT component and APT Request process retrieve the term from the maximum sequence number. The maximum sequence number row term will be the term in the corresponding APT schedule of an APT item when the item is created.

Using Item Attributes to Extend APT Instance Header Data Elements

The Common Attribute Framework allows you to extend the delivered APT_HDR data structure without customizations, by enabling you to add different types of data elements to your APT instances.

See “Understanding Common Attribute Framework” (Campus Community Fundamentals)

The Common Attribute Framework allows you to associate attributes with a functional area by a Record Context. Common Attributes have been enabled for the Academic Progress Tracker at the Instance level, which has its own Common Attribute Framework Record Context and Attribute Record.

<i>Field or Control</i>	<i>Description</i>
APT Header	<ul style="list-style-type: none"> Record Context: SSR_APT_HDR Attribute Record: SSR_APT_HDR_ADD <p>Attributes associated with this Record Context/Attribute Record combination are attached to an APT Instance header record and can be assigned on the Header page of the Academic Program Tracker component.</p>

Steps for Creating Common Attributes for APT

To create common attributes for APT:

1. Define the attribute using the Common Attribute component (Set Up SACR, Common Definitions, Common Attributes Setup, Common Attribute).
2. Attach that attribute to the APT Header Record Context (SSR_APT_HDR) (Set Up SACR, Common Definitions, Common Attributes Setup, Record Context).

Note: If you implemented Program Enrollment before April 2013, you must run the processes listed here after you apply the April 2013 updates.

3. Item Type Matrix Sync Entities

Navigate to the Item Type Matrix component (Set Up SACR, Product Related, Student Records, Program Enrollment, Item Type Matrix) and run the SSR_PE_SYNC process. The sync process ensures that the newly added attribute(s) are recognized as valid properties of the designated APT Entities (or all APT Entities if specific entities were not specified):

- Click the Sync Entities button. This initiates the SSR_PE_SYNC process.
- Check the Process Monitor to ensure that the process completes successfully.

This process can be scheduled using the process scheduler.

4. Entity Property Sync

Navigate to the Entity Property Sync page (SACR, System Administration, Entity, Entity Property Sync) and:

- Click the Sync All Entities button.
- Check the Process Monitor to ensure that the process completes successfully.

5. Wipe Entity Cache

Remain on the Entity Property Sync page and:

- After the Sync All Entity Properties process has completed successfully, click the Wipe Entity Cache button.
- Check the Process Monitor to ensure that the process completes successfully.

See [Identifying Child Item Types and Syncing Entities](#)

See “Understanding Common Attribute Framework” (Campus Community Fundamentals)

See “Defining a Common Attribute” (Campus Community Fundamentals)

See “Associating a Common Attribute to a Record” (Campus Community Fundamentals)

See “Understanding Entity Registry” (Campus Community Fundamentals)

See “Synchronizing Entity Properties” (Campus Community Fundamentals)

Using Item Attributes for the Academic Progress Tracker

As explained above:

- The Attribute Type determines the type of data that you can enter in the Item Attributes grid in AIR.
- An Attribute can be required when associated with a particular record context (the Required check box is selected on the Record Context page in Common Attributes setup). If an attribute associated with the SSR_APT_HDR context is set to required, the attribute will be added automatically when a user creates a new APT instance and a value will be required to save the component (if a default has not been assigned in the attribute definition). Note that a user must provide a value even if they add a non-required attribute.
- Attributes can also be repeatable if this property is enabled in the Record Context definition (the Repeatable check box is selected on the Record Context page in Common Attributes setup).

See “Defining a Common Attribute” (Campus Community Fundamentals)

See “Associating a Common Attribute to a Record” (Campus Community Fundamentals)

However, despite these variations, you always use the same process to add attributes for an APT instance—select the Attribute and then enter or select a Value—for example, date, text, numeric value, or a code where the code is a member of the List of Values defined for the attribute, a Table value, or XLAT value.

An APT Instance Header:

- Can have multiple attributes.
- Can have multiple rows for the same item attribute as long as the attribute is repeatable, and the Value is different (for example Attribute A, with Value 1, Attribute A with Value 2).

Attributes are assigned using the Instance Attributes scroll area:

Field or Control	Description
Attribute	The name of the attribute. This value comes from the description entered for the attribute on the Common Attribute component.
Value	This field changes depending on the type of attribute. This could be a numeric, date, time or text field. Alternatively, the field could prompt against a list of values if one has been defined for the attribute.

See “Defining a Common Attribute” (Campus Community Fundamentals)

See “Associating a Common Attribute to a Record” (Campus Community Fundamentals)

Managing APT Enrollment

Use the APT Enrollment component to enroll students based on APT course entries or to save classes in which students can enroll using Self Service.

This section provides an overview of APT enrollment processing and discusses how to process APT enrollment transactions.

Understanding APT Enrollment Processing

When a student is enrolled in a class using the APT enrollment process or through the self-service Schedule Builder feature, that enrollment data must be tied to an APT course item. This link is established as follows:

- Enrollment Request is submitted (from the self-service Schedule Builder or the APT Enrollment process).
 - An Enrollment Request is created and saved.
 - An APT Request (SSR_APT_REQUEST) is created and saved. One APT request row is created per APT Course, with an action of Enroll. So if the student is enrolling in three courses, three APT request rows are generated.
 - At this time, a cross reference between the Enrollment Request and the APT request is also created. A row is created in the SSR_APT_REQXREF table for each request, and the companion enrollment request ID is saved for each row. So if the student is enrolling in three courses, three APT cross reference rows are created. Each has a distinct APT request ID, but all three rows share the Enrollment Request ID. This cross reference table allows APT data to be referenced if an enrollment request needs to be resubmitted.
- COBOL engine is called and processes each detail row in the request.
 - Enrollment Engine updates the Enrollment Request (Success, Error, Message).
 - Rows are created in SSR_ENRL_BEVNT table if the SSR_ENROLLMENT_SYNC service operation is active.
- APT API is called.
 - API updates the APT Request Row.
 - If the enrollment was successful, a row is created in the SSR_APT_ENRL table.
 - If it is active, the SSR_ENROLLMENT_SYNC service operation is triggered.

Note: When a student drops a class through the self-service My Classes feature, the APT request process is initiated by the SSR_ENROLLMENT_SYNC service operation.

See the Student Enrollment Event document in My Oracle Support (ID 1400723.1).

See “Using Program Enrollment Self-Service Features” (Campus Self Service)

Page Used to Process APT Enrollment Transactions

Page Name	Definition Name	Navigation	Usage
APT Enrollment	SSR_APT_ENR_RUNCNT	Records and Enrollment > Program Enrollment > APT Enrollment	Enroll students based on APT course entries.

Processing APT Enrollment Transactions

Access the APT Enrollment page (**Records and Enrollment** > **Program Enrollment** > **APT Enrollment**).

This example illustrates the fields and controls on the APT Enrollment page. You can find definitions for the fields and controls later on this page.

APT Enrollment

Run Control ID: ps [Report Manager](#) [Process Monitor](#) Run

Academic Institution: PeopleSoft University

Academic Career: Undergraduate

Term: 2012 Fall

Session: ▼

Process mode: ▼

Population Selection

Population Selection
 Selection Tool: ▼ [Edit Prompts](#)
 Query Name: ▼ [Launch Query Manager](#) [Preview Selection Results](#)

Fetch Classes

Transaction

Get / Refresh Last Transaction

Enrollment Request ID 0000000000	Number of Transactions 0
Request Status	Transactions in Error 0
Last Update DateTime	Transactions with Message 0

The following values determine the keys that are used to fetch rows from the CLASS_TBL for this run and also determine the values that are used as prompts when defining the student population. If the run control values are Institution: *PSUNV*, Term: *0690*, then the Population Selection query (or a manually entered list of students) must use the same values to select rows from APT (SSR_APT_SCHD).

Field or Control	Description
Academic Institution	Select an Institution value.
Academic Career	Select an Academic Career value. This value is required for prompting against the TERM_TBL (which is keyed by INSTITUTION, ACAD_CAREER and STRM).
Term and Session	Select a Term and Session value. These values, along with the Institution value are used to fetch rows from the CLASS_TBL.

APT Enrollment can be used to create (and process) enrollment requests or to save classes so that they are accessible for the student to enroll in, using Self Service.

Field or Control	Description
Process Mode	<i>Enroll:</i> Select this mode to create an Enrollment Request (one request per run) which can be processed directly from this component, or retrieved, adjusted if necessary and posted using the Block Enroll component. <i>Schedule Builder:</i> If you select this mode, classes are saved directly to the SSR_REGFORM table where the student can retrieve them using the self-service Schedule Builder component to complete the enrollment process.

Population Selection

The Population Selection group box is a standard group box that appears on run control pages when the Population Selection process is available or required for the transaction. Selection tools are available based on the selection tools that your institution selected in the setup of the Population Selection process for the application process and on your user security. Fields in the group box appear based on the selection tool that you select. The fields behave the same way from within the group box on all run control pages and application processes. If your institution uses a specific delivered selection tool to identify IDs for a specific transaction, you must use it.

See “Using the Population Selection Process” (Campus Community Fundamentals)

This query is delivered as a sample: SSR_APT_ENR. It is intended as an example and is therefore based on very broad criteria. When you create queries for use with APT Enrollment, you must use the bind record SSR_APT_ENR_TGT.

Manual Selection

When the Population Selection check box is cleared, the Manual Selection grid is available for entry:

This example illustrates the fields and controls on the APT Enrollment page – Manual Selection grid. You can find definitions for the fields and controls later on this page.

Manual Selection						Personalize	Find	View All	First	1-2 of 2	Last
ID	APT Instance	APT Item Seq	Course ID	Class Description							
1	SRDEV071	1	666669	Economics 2							
2	SRDEV071	1	666670	Economics 3							

Field or Control	Description
APT Instance	Prompts against a view of the SSR_APT_HDR table for the selected student.
APT Item Seq(sequence)	<p>Prompts against a view of APT Items and returns all items with an item type of COURSE:</p> <ul style="list-style-type: none"> Where the Term value in the APT Item Attempt Table (SSR_APT_SCHD.STRM) is equal to the Run Control Term value. If the student’s Attempt Schedule contains a session value (that is, the enrollment cohort also records session values) a match is also made on the SSR_APT_SCHD.SESSION_CODE value and the Run Control session value. <p>See Creating and Managing APT Instances Using the Academic Progress Tracker Component</p>
Course ID and Class Description	The Course ID and Class Description (Subject Catalog Nbr) for the COURSE item are displayed when you use the Fetch Classes button (see the following documentation for Fetch Classes).

Fetching Classes and Using the Class Sections Grid

Use the Fetch Classes button to preview the class sections that will be used to create enrollment requests or to populate a student’s schedule builder. You can run the APT Enrollment process without fetching classes.

Field or Control	Description
Fetch Classes	<p>The Fetch Classes process fetches rows from the CLASS_TBL using:</p> <ul style="list-style-type: none"> • Run Control INSTITUTION, STRM, SESSION_CODE and • Population Select Result/Manual Selection: Distinct CRSE_ID/CRSE_OFFER_NBR combination(s) • for which CLASS_TYPE is E (enrollment section). <p>The fetched rows are displayed in the Class Sections grid. When Manual Selection is used, the Fetch Classes button also populates the Course ID and Subject Catalog Nbr for the selected APT Item (Course) in the Manual Selection grid.</p>

Here is an example of the Class Sections grid:

Class Sections									
Class Enrollment		Enrollment Options		Capacities		Personalize Find View All First 1-4 of 4 Last			
	Class Nbr	Section	Course ID		Related 1	Related 2	Auto Enroll 1	Auto Enroll 2	
1	1194	1	001308	MATH 102			-	-	
2	2360	1	002097	POL_SCI 1			-	-	
3	1728	1	666669	ECON 2			-	-	
4	2356	1	666670	ECON 3	2366	2370	1E	1I	

Results are ordered by CLASS_SECTION. The process returns the lowest CLASS_SECTION value when multiple sections of a class exist. The process also evaluates the CLASS_COMPONENT parts of the selected section for required related components and returns any related sections (related 1 and 2). Here again the lowest section number is used for each related component.

Class Enrollment tab:

Field or Control	Description
Class Nbr	Displays the CLASS_NBR value for the lowest CLASS_SECTION value with a CLASS_TYPE of E. You can select a different value if other sections are available.
Class Description	Click the Class Description link (SUBJECT and CATALOG_NBR) to access the Class Detail page and view enrollment capacity and totals.

Field or Control	Description
Related 1 and Related 2	Displays the CLASS_NBR value for the lowest CLASS_SECTION value for related components (a maximum of two, neither of which is auto-enroll). You can select different values if they are available.
Auto Enroll 1 and Auto Enroll 2	Click the links to access the Class Detail page and view enrollment capacity and totals.

Enrollment Options tab:

This example illustrates the fields and controls on the APT Enrollment Class Sections grid – Enrollment Options tab.

	Units	Wait List Okay	Instructor ID	Start Date	Requirement Designation	Take RD Option
1 MATH 102	3	<input type="checkbox"/>				<input type="checkbox"/>
2 POL SCI 1	3	<input type="checkbox"/>				<input type="checkbox"/>
3 ECON 2	3	<input type="checkbox"/>				<input type="checkbox"/>
4 ECON 3	3	<input type="checkbox"/>				<input type="checkbox"/>

Field or Control	Description
Units	Displays the unit value for the class. The value is editable for variable unit/credit classes.
Wait List OK	When this check box is selected, the enrollment engine attempts to wait list students in this class if the class is closed at the time when enrollment is processed. When the class (es) are processed by the enrollment engine, the User ID that creates the Run Control is checked for access to the Wait List OK function. If the User ID does not have this access, the wait list option is ignored and a closed class error is returned.
Instructor ID	You can edit this field if the class allows a choice of instructor.
Start Date	You can edit this field if the class is scheduled in the OEE session.
Take RD Option	You can edit this field if the Requirement Designation is optional.

Capacities tab:

This example illustrates the fields and controls on the APT Enrollment Class Sections grid – Capacities tab.

Class Sections							
Class Enrollment		Enrollment Options		Capacities		[REF]	
		No. of Students	Enrollment Capacity	Enrollment Total	Related 1	Related 2	
1	MATH 102	1	30	21	-	-	[-]
2	POL SCI 1	7	35	1	-	-	[-]
3	ECON 2	7	30	1	-	-	[-]
4	ECON 3	7	30	1	2366	2370	[-]

Field or Control	Description
No. of Students	Displays the total number of students in the selected population that need to be enrolled in the section of this course.
Enrollment Capacity	Displays the enrollment capacity of the selected enrollment section.
Enrollment Total	Displays the current enrollment total for the selected enrollment section.

Viewing Transaction Data

View APT Enrollment transaction data in the Transaction group box:

This example illustrates the fields and controls on the APT Enrollment Transaction group box. You can find definitions for the fields and controls later on this page.

Transaction	
Get / Refresh Last Transaction	
Enrollment Request ID	0000002582
Request Status	Errors Found
Last Update DateTime	02/28/2013 2:38:19PM
Number of Transactions	3
Transactions in Error	1
Transactions with Message	0

Field or Control	Description
Get / Refresh Last Transaction	Click to retrieve the last enrollment request generated for this Run Control/User ID (can be used when the same Run Control is used for multiple runs).

Field or Control	Description
Enrollment Request ID	Displays the last enrollment request generated for this Run Control/User ID. An enrollment request is generated only when the Process Mode is <i>Enroll</i> .
Request Status	Displays the status of the Enrollment Request (ENRL_REQ_HEADER.ENRL_REQ_PROC_ST).
Last Update Date Time	Displays the time stamp value for the enrollment request (ENRL_REQ_HEADER.DTTM_STAMP_SEC).
Number of Transactions	Displays the number of Enrollment Request detail rows (the number of Student/Class number combinations within the request).
Transactions in Error	Displays the number of Enrollment Request detail rows that resulted in error (ENRL_REQ_DETAIL.ENRL_REQ_DETL_STAT = E).
Transactions with Message	Displays the number of Enrollment Request detail rows that were processed successfully but for which an informational message was returned (ENRL_REQ_DETAIL.ENRL_REQ_DETL_STAT = M): for example, a student was added to a wait list or a student was enrolled in a class but the repeat check process returned a repeat warning.

Running the APT Enrollment Process

The Population Selection (or Manual Entry) populates a result table (SSR_APT_ENR_TGT) with the following values returned from the APT Item Attempt table for items where the item type is COURSE and where the APT Item Schedule (SSR_APT_SCHD) term (and session if the enrollment cohort uses session level) match the run control term value:

This example illustrates the fields and controls on the APT Enrollment Result Table. You can find definitions for the fields and controls later on this page.

	ID	Institution	Instance	Seq Nbr	Course ID	Offer Nbr
1	AA0002	PSUNV	1	50 666669		1
2	AA0002	PSUNV	1	60 666670		1
3	AA0002	PSUNV	1	70 007181		1
4	AA0002	PSUNV	1	80 002097		1
5	AA0002	PSUNV	1	90 666917		1
6	SR13435	PSUNV	1	60 666669		1
7	SR13435	PSUNV	1	70 666670		1
8	SR13435	PSUNV	1	80 007181		1

Field or Control	Description
Institution and Instance	Displays the Institution and Instance values for the selected instance.
Seq Nbr	Displays the SSR_APT_ATT.SSR_APT_ITEM_SEQ value.
Offer Nbr	Displays the Course Offering value if it exists (not required).

The process also fetches class section rows for each distinct CRSE_ID/CRSE_OFFER_NBR combination (these values are written to the table: SSR_APT_ENR_CLS). If a CRSE_OFFER_NBR value does not exist, the process fetches the first class section for the CRSE_ID, regardless of offering. If the Fetch Classes button has been used, this step is skipped because the sections have already been saved to the SSR_APT_ENR_CLS table.

When the Process mode is *Enroll*:

- Data from the student and class results tables is merged and a single enrollment request is created containing a detail row for each EMPLID/CLASS_NBR combination in the result set.
- The process calls the Enrollment Engine and the enrollment request is processed.
- When Enrollment processing is completed, the enrollment request ID is returned to the calling SSR_APT_ENR process and the ID is displayed on the Run Control component.

When the Process mode is *Schedule Builder*:

- Data from the student and class results tables are merged in the same way, however the resulting merged rows are inserted into the SSR_REGFORM table.
- Any existing rows with the same keys are overwritten.

See the Student Enrollment Event document in My Oracle Support (ID 1400723.1).

See “Using Program Enrollment Self-Service Features” (Campus Self Service)

Deleting Planning Nodes

The Delete Planning Node process allows you to delete planning node(s) that may have been created in error. Alternatively, planning nodes might need to be deleted if program requirements were changed after APT instances had been built or updated for a group of students. Whatever the reason, the APT Delete process is intended for use on an *exceptional* basis and it is expected that a very limited group of users would have access to run the process. As a safeguard against accidental deletes, the process never deletes a planning node if there has been any activity or update performed on it.

The process does not delete (that is, the selected student/planning node is skipped) if any of the following conditions are true:

- The APT Attempt Status of the Planning Node is a status other than *activated* or *null*.

- The Satisfied check box is selected for an APT Item (for the planning node or child items).
- The APT Item outcome is not null.
- Results exist for the Planning node or one of its child items.
- The APT Item Attempt (for the planning node) approval value is anything other than *Not Required*.
- The Planning Node item/attempt or one of its child items/attempt is locked.
- Child Course Academic Item(s) have a progress level other than *planned*.
- No Enrollment or Transfer Credit data exists for the planning node.
- No Items within the planning node are substitutes/replacements for other items in the instance.

This section discusses how to run the Delete Planning Nodes process.

Page Used to Delete Planning Nodes

Page Name	Definition Name	Navigation	Usage
Delete Planning Node(s)	SSR_APT_DEL_RUNCNT	Records and Enrollment > Program Enrollment > Delete Planning Nodes	Delete planning nodes.

Running the Delete Planning Nodes Process

Access the Delete Planning Node(s) page (**Records and Enrollment** > **Program Enrollment** > **Delete Planning Nodes**).

This example illustrates the fields and controls on the Delete Planning Node(s) page. You can find definitions for the fields and controls later on this page.

Delete Planning Node(s)

Run Control ID: PS [Report Manager](#) [Process Monitor](#) Run

*Academic Institution: [PeopleSoft University](#)

*Program Format ID: [View Tree](#)

*Node ID: [Year 3](#)

Population Selection

Population Selection
 Selection Tool: [Edit Prompts](#)
 Query Name: [Launch Query Manager](#) [Preview Selection Results](#)

Field or Control	Description
Program Format ID	Prompts against the Program Format Table for the selected institution. Use the View Tree link to view the Program Format definition. The value selected here serves as a high level control for the run control. Only students (whether identified by population selection or entered manually) in programs with a matching program format ID are processed.
Node ID	Select a planning node from the list. The prompt lists all planning nodes for the selected Program Format ID.

Population Selection

The Population Selection group box is a standard group box that appears on run control pages when the Population Selection process is available or required for the transaction. Selection tools are available based on the selection tools that your institution selected in the setup of the Population Selection process for the application process and on your user security. Fields in the group box appear based on the selection tool that you select. The fields behave the same way from within the group box on all run control pages and application processes. If your institution uses a specific delivered selection tool to identify IDs for a specific transaction, you must use it.

Field or Control	Description
Selection Tool	Select <i>External File</i> or <i>PS Query</i> .
Query Name	<p>The following queries are delivered as samples:</p> <ul style="list-style-type: none"> SSR_APT_DELETE_PLANNING_NODE (prompts on Institution and Program Format ID). SSR_APT_DELETE_PLAN_NODE (prompts on Institution, Academic Career, Planning Node Item Type, Academic Item ID, Program Item ID, Cohort Term and Curriculum Term). <p>When you create you own queries, you must use the bind record SSR_APT_HDR.</p>

See “Using the Population Selection Process” (Campus Community Fundamentals)

Manual Selection

The Manual Selection grid is available if you do not select the Population Selection check box. Use the grid to enter a list of students for processing:

This example illustrates the fields and controls on the Delete Planning Nodes page Manual Selection grid. You can find definitions for the fields and controls later on this page.

The screenshot shows a 'Manual Selection' grid with two columns. The first column is labeled 'ID' and contains the value 'SRPE2001'. The second column is labeled '*APT Instance' and contains the value '1'. There are search icons next to both input fields. The grid is part of a larger interface with a top bar containing 'Personalize | Find | View All | First 1 of 1 Last'.

<i>Field or Control</i>	<i>Description</i>
ID	Enter a student ID (EMPLID). The prompt includes only those students in programs with the program format ID equal to the Run Control value.
APT Instance	Select an APT Instance for the student.

Managing the APT Administrative Roster

Institutions need to be able to apply academic decisions in program curricula for selected students, such as replace a course that is no longer taught for a particular term or semester. Using a batch process, administrators can use the APT Administrative Roster component to add, remove, and substitute academic items for selected students. They can also use the component to enter, calculate, or evaluate results for selected students for any academic item within the Academic Item Registry (AIR) program structure.

This topic discusses how to:

- Process APT Administrative Roster transactions.
- Monitor APT Action processes.

Pages Used to Manage the APT Administrative Roster

<i>Page Name</i>	<i>Definition Name</i>	<i>Navigation</i>	<i>Usage</i>
APT Administrative Roster	SSR_APT_ADMN_REQ	Records and Enrollment > Program Enrollment > APT Administrative Roster	Add, remove and substitute academic items, and enter results.
Search Item ID in AIR Program	SSR_PROG_ITEM_PT	Select the prompt for an Item field on the APT Administrative Roster page.	Select the academic item for which the APT Action is to be performed.
Request History by Process	SSR_APT_REQ_HIST	Records and Enrollment > Program Enrollment > Request History by Process	View APT Action processes, outcomes and statuses.

Processing APT Administrative Roster Transactions

Access the APT Administrative Roster page (**Records and Enrollment > Program Enrollment > APT Administrative Roster**).

This example illustrates the fields and controls on the APT (Academic Progress Tracker) Administrative Roster page. You can find definitions for the fields and controls later on this page.

APT Administrative Roster

***Academic Institution** PeopleSoft University

Process Options

Manual Entry
 Selection Criteria
 Population Selection

Academic Career Undergraduate

Curriculum Term 2016 Fall **Curriculum Term Begin Date** 30/08/2016

As Of Date

***Academic Program** B.A. Business Management

Select update action

***APT Action**

Parent Item ID B.A. Bus Mgt - Semester 1

Child Item ID to Add ART 299: Art Studio

Enrollment Category

Select students

Academic Career Undergraduate

Cohort Tag

Cohort Term

Curriculum Term 2016 Fall

Attempt/Schedule

Node ID

Term

Attempt Status

Generate Student List

APT Data	Program Stack Data						Personalize Find First 1-5 of 5 Last
Select	ID	Name	APT Instance	APT	Cohort Tag	Cohort Term	Student Results
<input type="checkbox"/>	0081	Barker, Samantha	1	APT		2016 Fall	Results
<input type="checkbox"/>	0080	Grainger, Stewart	1	APT		2016 Fall	Results
<input type="checkbox"/>	0076	James, Siobhan	1	APT		2016 Fall	Results
<input type="checkbox"/>	0078	Robertson, Gary	1	APT		2016 Fall	Results
<input type="checkbox"/>	0079	Short, Suzzane	1	APT		2016 Fall	Results

[Select All](#) [Deselect All](#) [Add Row](#)

Submit

***Process Description** x Submit

[View Request History](#)

Process Options

<i>Field or Control</i>	<i>Description</i>
Manual Entry	Select specific student IDs to process for an APT Action.
Selection Criteria	<p>Use this option to further filter of students on an academic program based on the APT.</p> <ul style="list-style-type: none"> • Academic Career Select the Academic Career of the Program. Academic Career is disabled if you set a value for As of Date. • Curriculum Term Use the Curriculum (Requirement) Term start date to determine the Academic Item effective-dated row to display for the Program Structure modal page when adding or removing items. Items leading up to this date are displayed. This field is disabled if you set a value for As of Date. • As of Date Use this field to determine which Academic Item effective-dated row to display for the Program Structure modal page when adding or removing items. Items leading up to this date are displayed. This field is disabled if you set a value for Academic Career. • Academic Program Select an academic program. The prompt lists all valid academic items with an academic item type of Program (SSR_AIR_HDR.SSR_ITEM_TYPE = 'PRG') for the selected institution. This is a delivered academic item type value.

Field or Control	Description
Population Selection	<p>The Population Selection group box is a standard group box that appears on run control pages when the Population Selection process is available or required for the transaction. For the APT Administrative Roster page, only the Selection Tool <i>PS Query</i> is delivered, to ensure data consistency within the APT. Population Selection is also based on user security.</p> <p>The following queries are delivered as samples to be modified by the institution:</p> <ul style="list-style-type: none"> • SSR_APT_ADMIN_ROSTER_SAMPLE (prompts on Institution, Program and Item ID) • SSR_APT_ADMIN_ROSTER_RSLT_RSCA (prompts on Institution, Program ID, Item ID, Result Type and Result Scale) • SSR_APT_ADMIN_ROSTER_STAT (prompts on Institution, Program ID, Item ID) • SSR_APT_ADMIN_ROSTER_GRSC (prompts on Institution, Program ID, Item ID, Result Type and Result Scale). This query is used for result scales that are grade-only. <p>When you create result based queries, the bind record SSR_APT_ITMRSLT should be used. All other APT Action queries should include the bind record SSR_APT_HDR.</p> <p>See “Using the Population Selection Process” (Campus Community Fundamentals).</p>

Select update action: Add Item

Field or Control	Description
APT Action	<p><i>Add Item:</i> Add a child academic item from outside the AIR program structure to a parent academic item within the AIR program selected for an individual or group of students in batch. In the APT Administrative Roster page example, ECON 2 does not exist in the B.A Business Management program. This course is being added from outside the AIR program, as a child to the parent B.A. Bus Mgt Semester 1.</p> <p>The <i>Add Item</i> action also populates the Enrollment Category in the APT Tree (SSR_APT_TREE) if selected or available, and also indicates that this item addition was an administrative addition within the APT. See Using the APT Tree</p>

Field or Control	Description
Parent Item ID	<p>This prompt opens the Search Item ID in AIR Program page which provides a view of the AIR program. Select the parent item to which the child item will be added.</p> <hr/> <p>Note: The academic items available for selection are controlled by APT Action Security. See Setting Up APT Action Security</p> <hr/>
Child Item ID to Add	<p>If the current item is a program format tree node, the Child Item ID to Add prompt lists all academic items that have an academic type specified as a valid child item in the Academic Item Type Matrix.</p> <p>See Identifying Child Item Types and Syncing Entities</p> <p>The prompt excludes items that have an item type defined as a program format tree node. This ensures that any changes to the program structure conform to the program format for the item.</p>
Enrollment Category	<p>This field appears only if the Requires Enrollment Category check box has been selected for the academic item type that is being added. Select a value in the Enrollment Category field before submitting the process. See Defining Academic Item Type Attributes</p>

The documentation about the *Add Item* action and the following documentation about other update actions discusses the Search Item ID in AIR Program page.

Here is an example of the Search Item ID in AIR Program page:

Search Item ID in AIR Program

Academic Institution: PeopleSoft University
 Academic Program: 0000002138 B.A. Business Management
 Format ID: UG_4YR_REG UG 4 Year Program

- 1 - Program
 - 10 - Year 1
 - 101 - Year 1 - Semester 1
 - 102 - Year 1 - Semester 2
 - 20 - Year 2
 - 201 - Year 2 - Semester 1
 - 202 - Year 2 - Semester 2
 - 30 - Year 3
 - 301 - Year 3 - Semester 1
 - 302 - Year 3 - Semester 2
 - 40 - Year 4
 - 401 - Year 4 - Semester 1
 - 402 - Year 4 - Semester 2

Expand / Collapse	Item Description	Item Type	Enrollment Category	Item ID	Format Node
[-]	B.A. Business Management	Program of Study		0000002138	1 - Program
[]	[-] Year 1 - Foundation and Business Core	Stage		0000002138	10 - Year 1
[]	[] [-] B.A. Bus Mgt - Semester 1	Study Period		0000002140	101 - Year 1 - Semester 1
[]	[] [] [-] ECON 2: Macroeconomic Principles	Course	Mandatory	0000003088	
[]	[] [] [-] and ECON 3: Microeconomic Principles	Course	Mandatory	0000003089	
[]	[] [] [-] and POL SCI 1: Intro to US Govt and Politics	Course	Mandatory	0000001100	
[]	[] [] [-] and Modern European Languages - Intro Level	Course Group	Electives	0000001697	
[]	[] [] [-] or Survey of Modern Math I	Course	Electives	0000002151	
[]	[] [] [-] and B.A. Bus Mgt - Semester 2	Study Period		0000002141	102 - Year 1 - Semester 2
[]	[] [] [-] ECON 198: Special Topics in Economics	Course	Mandatory	0000002152	
[]	[] [] [-] and ECON 1004B: Economic Methods II	Course	Mandatory	0000000446	

Note: The academic items available for selection are controlled by APT Action Security. See [Setting Up APT Action Security](#)

Select update action: Remove Item

Field or Control	Description
<p>APT Action</p>	<p><i>Remove Item:</i> Examples of when you might use this action are: program requirements were changed after APT Instances had been built or updated for groups of students; to replace a course that is no longer taught in the semester or term. It is expected that a limited group of users, controlled by APT Action Security, will have access to remove items. See Setting Up APT Action Security</p> <p>As a safeguard against accidental deletes, the process never deletes an academic item if there has been any activity or update performed on it.</p> <hr/> <p>Note: If you remove a Program academic item (PRG), all content on the student’s APT Tree is removed. Therefore, such security access should be provided only in <i>exceptional</i> circumstances. The same is true for program format tree nodes.</p> <hr/> <p>The process does not remove an academic item if certain conditions are true. The conditions are the same as those listed in the documentation about deleting planning nodes. See Deleting Planning Nodes</p>
<p>Item ID</p>	<p>This prompt opens the Search Item ID in AIR Program page where you can select the academic item to be removed (controlled by APT Action Security).</p>

Select update action: Create Substitution

Field or Control	Description
APT Action	<p><i>Create Substitution:</i> The substitution process typically involves the swapping of one course for another. For example, academic decisions often allow students to substitute a course from the prescribed program curricula for another course that may be part of another program, structure or even a standalone course offered by the institution.</p> <p>You can also substitute different types of academic items and replace an item of one type with a different type.</p> <hr/> <p>Note: You cannot create a substitution for the following items: An item which is identified as a program format tree node; An item which has been replaced with another APT item; An item which has child items in APT (for example, a Course List item, from which child item courses have been placed into APT).</p>
Item to Substitute	<p>This prompt opens the Search Item ID in AIR Program page where you can select the academic item to be substituted (controlled by APT Action Security).</p>
Substitute Item	<p>The prompt lists all non-program format tree node academic items (with effective dated logic) that are <i>valid child items (according to item type matrix) of the parent item of the item</i> which is being substituted.</p>

Select update action: Enter Results

Field or Control	Description
APT Action	<p><i>Enter Results:</i> Enter results by result type and result scale (if one exists) for selected students. Results, Grades, Outcomes, Result Status, Reason Code, Include in Calc and Show Student can be updated for any academic item within the AIR Program selected on the roster page. You can also update a result already submitted. A new result row is created in APT when the process is submitted, to preserve the history of results recorded and for audit purposes. The Include in Calc check box is moved from the previous row to the latest row for the result type.</p>

Field or Control	Description
Item ID	This prompt opens the Search Item ID in AIR Program page where you can select the academic item for which results should be entered (controlled by APT Action Security).
Result Type and Result Scale	<p>The Result Type field prompts against Result Type table (SSR _RESULT_TYPE) for the institution.</p> <p>You assign a Result Scale to a Result Type on the Result Type page (Set Up SACR, Product Related, Student Records, Grading, Result Type). See Setting Up Result Types</p> <p>The question mark icon opens a secondary page to view the selected result scale.</p>

Select update action: Enter APT Status

Field or Control	Description
APT Action	<p><i>Enter APT Status</i></p> <p>This action updates the APT Attempt Status, Attempt Outcome, and Satisfied status for an academic item for selected students. For example, once all the results have been recorded for an academic term like a course list, the student’s APT can be updated to represent the final outcome of the academic item that has been attempted, such as:</p> <ul style="list-style-type: none"> • Attempt Status is Finalized • Attempt Outcome is Passed • Satisfied status is Yes
Item ID	Select to open the Search Item ID in AIR Program page. On this page, you can select the academic item for which APT Statuses should be entered. This is controlled by APT Action Security.

Select update action: Calculate Results

Field or Control	Description
APT Action	<p><i>Calculate Results</i></p> <p>When you click the Calculate button on the APT Administrative Roster page, this action calls a calculation rule from the Rules Engine Manager for selected students. A result row is inserted into the student's APT for the calculated result. The result outcome is also brought back to the roster page, including messages that indicate why a student result cannot be calculated.</p> <p>You can also recalculate results from the roster page. When the result is recalculated, a new result row is created in APT. The new result row is used to preserve the existing result history and for audit purposes.</p>
Item ID	<p>Select to open the Search Item ID in AIR Program page. On this page, you can select the academic item for which results will be calculated. This is controlled by APT Action Security.</p>
Result Type and Result Scale	<p>The Result Type field prompts against the institution's Result Type table (SSR_RESULT_TYPE).</p> <p>You assign a Result Scale to a Result Type on the Result Type page (Setup SACR, Product Related, Student Records, Grading, Result Type).</p> <p>See Setting Up Result Types.</p> <p>The question mark icon opens a secondary page to view the selected result scale.</p>

See *Using the Rules Engine for Calculation and Evaluation: System/Example Data* in My Oracle Support (ID 1400723.1).

Select update action: APT Status Evaluation

Field or Control	Description
APT Action	<p><i>APT Status Evaluation</i></p> <p>This action evaluates all results for an academic item, and updates the APT Statuses (Attempt Status, Attempt Outcome, and Satisfied) based on the outcome of this evaluation. For example, a student must achieve a mark of over 60.00, and have earned 3 credits to satisfy the requirements for a course list or semester. The student achieves a mark of 85.00 which earns the student 3 credits. The evaluation rule based on this example would be able to update the course list academic item statuses to an Attempt Status of 'Finalized', Attempt Outcome of 'Passed', and Satisfied status of 'Yes'. The results of the evaluation are updated in the student's APT and displayed on the roster page, along with the ability to check any error messages if APT statuses have not been updated.</p>
Item ID	Select to open the Search Item ID in AIR Program page. On this page, you can select the academic item for which results will be calculated. This is controlled by APT Action Security.
Rule Search	Select the Evaluation Rule that you wish to use to evaluate APT statuses for the selected academic item.

See *Using the Rules Engine for Calculation and Evaluation: System/Example Data* in My Oracle Support (ID 1400723.1).

Select Students

Use this grid to select criteria base on the Academic Progress Tracker (APT) to further filter students on an academic program.

Field or Control	Description
Academic Career	Select a career from the Academic Career table (ACAD_CAREER_TBL). This field is disabled if you select an academic career in the Process Options grid.
Cohort Tag	Select an academic cohort from the Academic Cohort table (SSR_COHORT_TBL) to identify students who commenced their program at a particular point in the academic year.

Field or Control	Description
Cohort Term and Curriculum Term	Select a term from the Term Values table (TERM_VALUES_TABLE). The Curriculum Term field is disabled if you select a Curriculum Term in the Process Options grid.
Node ID	Select a planning node to filter against students' APT Academic Item Attempt Schedule for the academic item you selected.
Term and Attempt Status	Use these fields to filter against students APT Academic Item Attempt Schedule for the academic item you selected.

Generate Student List

Click the Generate Student List button after you select criteria using Selection Criteria or Population Selection. When the student data is retrieved, you can access (view or update) the APT Instance or Program Stack data for a student directly from the roster page.

This example illustrates the fields and controls on the APT (Academic Progress Tracker) Administrative Roster page: Generate Student List grid. You can find definitions for the fields and controls later on this page.

Select students

Academic Career Undergraduate

Cohort Tag

Cohort Term

Curriculum Term 2016 Fall

Attempt/Schedule

Node ID Term Attempt Status

Personalize | Find | First 1-5 of 5 Last

APT Data	Program Stack Data		APT Instance	APT	Cohort Tag	Cohort Term	Student Results
<input type="checkbox"/>	0081	Barker, Samantha	1	APT		2016 Fall	Results
<input type="checkbox"/>	0080	Grainger, Stewart	1	APT		2016 Fall	Results
<input type="checkbox"/>	0076	James, Siobhan	1	APT		2016 Fall	Results
<input type="checkbox"/>	0078	Robertson, Gary	1	APT		2016 Fall	Results
<input type="checkbox"/>	0079	Short, Suzanne	1	APT		2016 Fall	Results

[Select All](#) [Deselect All](#) [Add Row](#)

Submit

*Process Description

[View Request History](#)

To process students for an APT Action, select individual students or **Select All**. Click **Add Row** to add a student to the list. The Student Results column provides access to the student’s XMLP results page. This is the same view as the student in Program Enrollment Self Service.

See *Using BI Publisher and the XMLP Results Template to Display Students’ Results and Outcomes in Program Enrollment Self Service: Sample Template in My Oracle Support (ID 1400723.1)*.

The generated student list grid example is the same for all APT Actions except Enter Results, Enter APT Status, Calculate Results and APT Status Evaluation.

Here is an example of the Generate Student List grid for the Enter and Calculate Results action:

Select	ID	Name	APT Instance	Results Exist	Result Value	Grading Scheme	Description	Grading Basis	Grade	Grade Points	Outcome	Result Status	Reason Code	Include in Calculation	Show Student	Student Results
<input type="checkbox"/>	0071	Basonby,Alison	1	<input checked="" type="checkbox"/>	96.00	UGD	Undergrad	GRD	A	4.000	Passed	Approved		<input checked="" type="checkbox"/>	<input type="checkbox"/>	Results
<input type="checkbox"/>	0079	Bywaters,Helen	1	<input checked="" type="checkbox"/>	96.00	UGD	Undergrad	GRD	A	4.000	Passed	Approved		<input checked="" type="checkbox"/>	<input checked="" type="checkbox"/>	Results
<input type="checkbox"/>	0072	Kingston,Alexandra	1	<input type="checkbox"/>	0.00	UGD	Undergrad	GRD				Undetermine		<input type="checkbox"/>	<input type="checkbox"/>	Results
<input type="checkbox"/>	SRPE3053	Mainwaring,Patricia	1	<input checked="" type="checkbox"/>	99.00	UGD	Undergrad	GRD	A	4.000	Passed	Approved	TEST	<input type="checkbox"/>	<input checked="" type="checkbox"/>	Results

The APT Action *Enter Results* displays a results roster grid when the Generate Student List is selected for the specific academic item. The results entry process observes the same functionality of entering results for individual students on the APT component; grades can default from the mark entered using the results scale mapping. The minimum and maximum mark from the result scale is also observed along with decimal places.

The outcome now defaults when entering the mark or grade based on the result scale mapping, and the Include in Calculation flag is also checked on entry of a result. The APT Action *Calculate Results* also uses the same results grid. If a result cannot be calculated for a student, a message column is displayed.

This example illustrates the APT (Academic Progress Tracker) Administrative Roster page: Result Messages for APT Action Calculate Results. You can find definitions for the fields and controls later on this page.

Select	ID	Name	APT Instance	Results Exist	Result Value	Grading Scheme	Description	Grading Basis	Grade	Grade Points	Outcome	Result Status	Reason Code	Include in Calculation	Show Student	Message Log	Student Results
<input checked="" type="checkbox"/>	0071	Basonby,Alison	1	<input checked="" type="checkbox"/>	96.00	UGD	Undergrad	GRD	A	4.000	Passed	Approved		<input checked="" type="checkbox"/>	<input checked="" type="checkbox"/>	Messages	Results

When retrieving groups of students for result entry for an academic item, the roster page identifies whether a result already exists for a student. If a result or calculation exists, the Result Exists check box is selected and the row is display-only mode. To update a result, select the student ID; the Result field is then available for edit. When a result is updated, a new result row for the result type is created in APT.

Note: If a result exists for Manual Entry, the row is immediately available for edit and update.

Field or Control	Description
Result Value	This value is based on the Result Type setup and is validated against the Result Scale.

Field or Control	Description
Grading Scheme	Controls the Grade prompt and is available if the Result Type has a Result Scale which is configured to allow include grade. The value defaults into the roster page.
Grading Basis	<p>Controls the Grade prompt. This field is available if the Result Type has a Result Scale which is configured to include grades. The field prompts against the Grading Basis for the selected Grading Scheme. The value defaults into the roster page.</p> <hr/> <p>Note: The grading basis default value on the roster page and APT component is taken from the default grading basis in the Program Enrollment mapping, which is done on the Academic Program configuration page.</p> <hr/>
Grade	Allows for the recording of a core grade for the Result Type and is available if the Result Type has a Result Scale configured to allow include grade. The field prompts against the Grade table for the selected Grading Scheme/basis. Defaults from the entry of a Result value based on the Result Scale if configured.
Grade Points	Displays the grade point value (from the GRADE_TBL) for the grade.
Attempt Outcome	Records the outcome of the result, for example, <i>Passed</i> or <i>Failed</i> . If the result scale is associated with a result type, the outcomes can default on entry of a result based on the result scale mappings.
Result Status	<p>Records the current result status, for example, <i>Awaiting Approval</i> or <i>Approved</i>. Prompts on Results Status translate values, and requires data entry (does not default).</p> <hr/> <p>Note: If built in the rule calculation, the APT Action Calculate Results can populate the result status as <i>Calculated</i>.</p> <hr/>
Reason Code	<p>Prompts on the APT Reason Code table and requires data entry. Use this field to record reasons why specific results were awarded, for example, compensation, mitigation, health reasons.</p> <p>This is not used in the delivered sample calculation.</p>

Field or Control	Description
Include in Calculation	Select the check box if this result should be included in calculating a higher level result. This is selected in the delivered sample rule calculation.
Show Student	This field can be used when defining the logic of the XMLP Results Template, which is user-defined. The logic within this template can use this field to determine whether the result should be displayed for the student.
Student Results	Provides a link to the XMLP student results page.

Note: The APT action Calculate Results can return all or some of the fields to the roster page. And depending on how the rule is built, it can insert a result into the APT.

For Results Calculation, see *Using the Rules Engine for Program Enrollment Student Self-Service: System/Example Data document* in My Oracle Support (ID 1400723.1).

This example illustrates the fields and controls on the APT (Academic Progress Tracker) Administrative Roster page: APT Action - Enter APT Status. You can find definitions for the fields and controls later on this page.



The APT Action *Enter APT Status* displays a grid when the Generate Student List is selected for the specific academic item. Using the grid, you can update the values for the APT statuses Satisfied, Attempt Outcome, and Attempt Status.

When you enter the APT status for groups of students for an academic item, the roster page identifies whether an APT status exists for a student. If an APT status exists, the row is display-only mode. To update any of the statuses, you must select the student ID so that the row is in edit mode. The same grid is displayed for APT Status Evaluation, and like the Calculate Results grid, a message column appears if there are any errors in the evaluation of a student’s APT statuses.

For APT Status Evaluation, see *Using the Rules Engine for Program Enrollment Student Self-Service: System/Example Data document* in My Oracle Support (ID 1400723.1).

Field or Control	Description
Attempt Status	Records the overall attempt status of the academic item, for example, Finalized.

Field or Control	Description
Attempt Outcome	Records the overall attempt outcome of the academic item, for example, Passed.
Satisfied	Records whether the academic item has been satisfied or not.

See [Managing APT Items](#)

See [Setting Up Result Types](#)

See [Setting Up APT Reason Codes](#)

Submit APT Actions (Add Item, Remove Item, Create Substitution, Enter Results, Enter APT Status)

You can run the APT action *Submit* as a background process. Alternatively, after submitting, you can view the process using the View Request History link and access the Request History by Process page.

See [Monitoring APT Action Processes](#).

Use the Process Description field on the roster page to provide specific descriptions for each process that you submit, for example, *Add Course Econ 2: Macroeconomic Principles*. These descriptions are recorded in the process and can also be used when you search for specific processes in the Request History by Process component.

Calculate - APT Action (Calculate Results)

The APT action *Calculate Results* does not use the Submit grid. The Calculate button calls the rule from the Rules Engine, inserts a results row in APT, and also displays the result outcome on the roster page. If a student result cannot be calculated, a message is also displayed.

Evaluate - APT Action (Evaluate APT Status)

The APT action *APT Status Evaluation* also does not use the Submit grid. The Evaluate button calls the rule from the Rules Engine, updates the APT statuses of Satisfied, Attempt Outcome, Attempt Status, and also displays the outcome on the roster page. If an outcome status cannot be evaluated, a message is also displayed.

Monitoring APT Action Processes

Use the Request History by Process page to monitor the details and outcomes of all APT Action processes submitted on the APT Administrative Roster page. You can monitor the request as it is submitted (the process instance ID is passed to the Request History by Process component), or view later after running the process in the background. You can also use the page to search for previous process instances submitted. If errors are returned during the submit process, you can fix them in the student's APT or program stack directly from this page, and then resubmit the process.

Although the APT actions Calculate Results and APT Status Evaluation are not submitted to the process scheduler from the roster page, you can still access the results of the rules for these APT actions using the Request History component.

Access the Request History by Process page (**Records and Enrollment > Program Enrollment > Request History by Process**).

Alternatively, access the page from the APT Administrative Roster page using the View Request History link.

This example illustrates the fields and controls on the Request History by Process page. You can find definitions for the fields and controls later on this page.

Request History by Process

Select Requests

APT Action: Remove Item

Process Description: Remove EON 2: Macroeconomic Principles

Process Instance From: 2731 To:

Run Date From: 08/06/2014 To: 08/06/2014

Run Status: Success

Refresh Request List

Request List Find | View All | First 1 of 1 Last

Select	Instance	APT Action	Run Date/Time	Run Status	Details
<input checked="" type="radio"/>	2731	Remove Item	08/06/14 06:19:27	Success	Details

Process Instance 2731

Process Description Remove EON 2: Macroeconomic Principles

Institution PSUNV PeopleSoft University

Academic Item ID 00000002138 B.A. Business Management

APT Action Remove Item

Item ID 00000000388 ECON 2: Macroeconomic Principles

Filter

Success (3) Warnings (0) Errors (1) Apply Filter

Filter Results Find | View All | First 1-4 of 4 Last

Select	Outcome	ID	Name	APT Inst	Program and Plan	Status
<input type="checkbox"/>	Success	SRPE3030	Kingston, Mandy	1	BA Liberal Arts Programs - Business Management	✔
<input type="checkbox"/>	Error	SRPE3029	Ramsbottom, Louisa	1	BA Liberal Arts Programs - Business Management	✘
<input type="checkbox"/>	Success	SRPE3028	Ravenscroft, Susannah	1	BA Liberal Arts Programs - Music Performance (BFA)	✔
<input type="checkbox"/>	Success	SRPE3027	Robinson, Chantelle	1	BA Liberal Arts Programs - Business Management	✔

Resubmit Selected

Filter

Use the Filter grid to filter results based on different outcome statuses. For example, you can display the students that have an error status to resolve the data for those students.

Field or Control	Description
Select	This check box appears only for those students who have an Error status. You can select student IDs for resubmission.
Outcome	The Outcome status is display only unless the outcome is an error, when a link provides details about the error message.
Resubmit Selected	<p>You can resubmit the APT Action process for an individual or group of students. After the error has been resolved, select the student ID in the grid and click the Resubmit Selected button. You are returned to the APT Administrative Roster page where you can change the Process Description. Submit the process from the APT Administrative Roster page as previously, and then return to the Request by History process using the View Request History link to view the outcome of the process.</p> <hr/> <p>Note: For APT actions Calculate Results and APT Status Evaluation, resubmission is not available from the Request History component. The error messages are displayed on the roster page, which allows recalculation directly from the roster.</p> <hr/>

APT API Detail

The following section provides further detail on the operations and processing performed by SSR_APT:API. Please note that when called from the Application Maintenance component, the Admissions Activate Applications process and the Student Program Plan component, the API creates *only the APT Instance* (SSR_APT_HDR). All other actions are performed when the API is called from the APT Request SSR_APT_REQ application engine.

See “Understanding Entity Registry” (Campus Community Fundamentals)

SSR_APT:API

Class APTAPI

Summary

Property Summary:

Data Type	Name and Description
public APTHeader	<p>APTHeader</p> <p>The APT Header APT Entity object that is populated when the getHeader() method is invoked.</p>
public BasicEntity	<p>CONTEXT_ROOT</p> <p>The APT Entity object which is set as the root context for all method processing in the API. This is usually set as the planning node or equates to term node APT item. This property is set by consumers of the API so that only items that fall under this root item are processed. If this property is blank, the APT Header is considered as the root item. This property is set when the setContextRoot() method is invoked.</p>
public BasicEntity	<p>CONTEXT_ROOT_AIR</p> <p>The AIR Entity object which is set as the root context for all method processing in the API. This is usually set as the planning node or equates to term node AIR item. This property is set by consumers of the API so that only items that fall under this root item are processed. If this property is blank, the PoS property is considered as the root item. This property is set when the setContextRoot() method is invoked.</p>
public string	<p>CRSE_FILTER</p> <p>This property determines if the APT structure should fill completed and in-progress courses. Set value 'Y' if the Course should ignore completed and in-progress courses.</p>
public EnrollmentCohort	<p>EnrollmentCohort</p> <p>The enrollment cohort object corresponding to the APT Header in context.</p>
public boolean	<p>FILL_COURSE_GROUP</p> <p>Set this property to true if the course group entities should be populated in the AIR structure.</p>
public boolean	<p>FILL_COURSE_OFFERING</p> <p>Set this property to false to turn off loading course offering details entity under AIR Course, default is true.</p>

Data Type	Name and Description
public boolean	FILL_NON_PFN_ITEMS Set this property to false if non planning node items should be excluded from the AIR structure.
public boolean	PERFORM_VALIDATE Set this property to false if validation logic should be ignored when save() method is invoked. By default validation logic is processed when save method is invoked.
public BaseAIREntity	PoS The Program of Study AIR Entity object corresponding to the APT Header object. This property is automatically instantiated along with the APTHeader APT Entity object when the getHeader() method is invoked.
public ProgramFormatSetup	Program Format The program format object corresponding to the APT Header in context.
public boolean	TERM_ACTIVATE Set this property to true to term activate into terms defined in the equates to term items on save.

Constructor Summary:

Return Data Type	Name and Description
public void	APTAPI()

Method Summary:

<i>Return Data Type</i>	<i>Name and Description</i>
public boolean	<p>activateCurrentPlanningNode (MessageLogBase p_Messages out)</p> <p>Activates the current planning node and all its program format tree node child items by setting the APT Attempt status to 'Activated'. This method will perform this operation only if the attempt status of the current planning node is null.</p>
public boolean	<p>activateCurrentPlanningNodeInAPTHHeader(string p_Emplid, string p_Institution, number p_Instance, MessageLogBase p_Messages out)</p> <p>Activates the current planning node and all its program format tree node child items by setting the APT Attempt status to 'Activated'. This method will perform this operation only if the attempt status of the current planning node is null.</p>
public boolean	<p>activateProgFormatNode(BaseAPTEntity p_APT_Entity, MessageLogBase p_Messages out)</p> <p>Activates the Program Format node entity object passed in as a parameter.</p>
public boolean	<p>addIAMEnrollentDataForItem(number p_SSR_APT_ITEM_SEQ, number p_ATTEMPT_NBR, string p_Term, string p_SSR_ACTIVITY_ID, number p_SSR_ACT_ID_SEQ_NBR, MessageLogBase p_Messages out)</p> <p>Adds Individual Activity Management (IAM) enrollment information to a student's APT course item.</p>
public boolean	<p>addIAMEnrollentDataForItemInAPTHHeader(string p_Emplid, string p_Institution, number p_Instance, number p_SSR_APT_ITEM_SEQ, number p_ATTEMPT_NBR, string p_Term, string p_SSR_ACTIVITY_ID, number p_SSR_ACT_ID_SEQ_NBR, MessageLogBase p_Messages out)</p> <p>Adds Individual Activity Management (IAM) enrollment information to a student's APT course item.</p>

Return Data Type	Name and Description
public BaseAPTEntity	<p>addItem (string p_AIR_Item_ID, MessageLogBase p_Messages out)</p> <p>Adds an AIR Item to a student's APT. This method takes care of automatically adding the parent items (if they do not exist) and adds child items based on the enrollment category of the item being added.</p> <p>This method requires that an APT header record already exists for the student and it should be populated in the APTAPI property APTheader by invoking the getHeader method.</p>
public BaseAPTEntity	<p>addItemToAPTheader(string p_Emplid, string p_Institution, number p_Instance, string p_AIR_Item_ID, MessageLogBase p_Messages out)</p> <p>Adds an AIR Item to a student's APT. This method takes care of automatically adding the parent items (if they do not exist) and adds child items based on the enrollment category of the item being added. This method requires that an APT header record already exists for the student.</p>
public BaseAPTEntity	<p>addItemUnderAPTItem (string p_Emplid, string p_Institution, number p_Instance, string p_Parent_Item_ID, string p_Child_Item_ID, MessageLogBase p_Messages out)</p> <p>Adds an AIR Item as a child to a specific APT item. This method can be used to add an item that is not present in the AIR hierarchy.</p>
public BaseAPTEntity	<p>addItemUnderAPTItemV2(string p_Emplid, string p_Institution, number p_Instance, string p_Parent_Item_ID, number p_Parent_Item_seq, string p_Child_Item_ID, MessageLogBase p_Messages out)</p> <p>Adds an AIR Item as a child to a specific APT item. This method can be used to add an item that is not present in the AIR hierarchy.</p>
public APTAttempt	<p>createAPTAttemptForItem (BaseAPTEntity p_parent, BaseAIREntity p_parent_AIR_Entity, MessageLogBase p_Messages out)</p> <p>Adds a new APT Attempt row for an APT item. This method also creates the APT schedule and APT Result data for the newly created APT Attempt.</p>

Return Data Type	Name and Description
public boolean	<p>createAPTHeader (string p_Emplid, string p_Acad_career, number p_Student_car_nbr, string p_Institution, MessageLogBase p_Messages out)</p> <p>Creates a new APT Header record. To save the newly created APT Header to the database invoke the save method.</p> <hr/> <p>Note: The student program stack ACAD_PROG.SSR_APT_INSTANCE is not updated by this method.</p>
public boolean	<p>createAPTHeaderFromEntity (StudentProgram p_StudentProgram, MessageLogBase p_Messages out)</p> <p>Creates a new APT Header record. This method uses a pre-populated entity object SSR_CAREER_TERM:Accessors:StudentProgram. This method holds the core logic for creating the APT header and is invoked by all the other methods that create APT header. To save the newly created APT Header to the database invoke the save method.</p> <hr/> <p>Note: The student program stack ACAD_PROG.SSR_APT_INSTANCE is not updated by this method.</p>
public boolean	<p>createAPTHeaderFromRecord (Record p_recACAD_PROG, MessageLogBase p_Messages out)</p> <p>Creates a new APT Header record. This method is meant to be used from online components by passing the ACAD_PROG component buffer record as the parameter. To save the newly created APT Header to the database invoke the save method.</p> <hr/> <p>Note: The student program stack ACAD_PROG.SSR_APT_INSTANCE is not updated by this method.</p>
public BaseAPTEntity	<p>createAPTItem (BasicEntity p_parent, string p_SSR_ITEM_ID, BaseAIREntity p_AIR_Entity, boolean p_full_mode, MessageLogBase p_Messages out)</p> <p>Creates one APT item under a parent APT item. This also creates the APT attempt, schedule and result records. Child academic items are also created based on the mode parameter and the enrollment category associated with the item.</p>

Return Data Type	Name and Description
public void	<p>createCounterRecord(string p_Emplid, string p_Institution, number p_Instance)</p> <p>This method should be called to set up the counter record SSR_APT_ITM_CNT. If a row already exists for the given emplid, institution and APT instance key values, it verifies if the counter value is correct and updates it to the right value if it is not. If a counter row does not exist for the given keys then it creates a new row with the correct counter value.</p>
public boolean	<p>deleteAPTHeader (string p_Emplid, string p_Institution, number p_Instance, MessageLogBase p_Messages out)</p> <p>Deletes APT Header record. Delete is only allowed if there are no references in student program stack or admissions application stack.</p>
public boolean	<p>dropEnrolledItem (number p_SSR_APT_ITEM_SEQ, number p_ATTEMPT_NBR, string p_Term, number p_classNumber, MessageLogBase p_Messages out)</p> <p>Deletes enrollment information from a student's APT course item.</p>
public boolean	<p>dropEnrolledItemInAPTHeader (string p_Emplid, string p_Institution, number p_Instance, number p_SSR_APT_ITEM_SEQ, number p_ATTEMPT_NBR, string p_Term, number p_classNumber, MessageLogBase p_Messages out)</p> <p>Deletes enrollment information from a student's APT course item.</p>
public boolean	<p>enrollItem (number p_SSR_APT_ITEM_SEQ, number p_ATTEMPT_NBR, string p_Term, number p_classNumber, MessageLogBase p_Messages out)</p> <p>Adds enrollment information to a student's APT course item.</p>
public boolean	<p>enrollItemInAPTHeader (string p_Emplid, string p_Institution, number p_Instance, number p_SSR_APT_ITEM_SEQ, number p_ATTEMPT_NBR, string p_Term, number p_classNumber, MessageLogBase p_Messages out)</p> <p>Adds enrollment information to a student's APT course item.</p>

<i>Return Data Type</i>	<i>Name and Description</i>
public BaseAPTEntity	<p>findAPTElementByItemSequence (BaseAPTEntity p_tree, number p_SSR_APT_ITEM_SEQ, array of string p_breadcrumbs out)</p> <p>Searches for and returns an entity object based on the APT item sequence number specified. It can be used only in APT trees.</p>
public BasicEntity	<p>findElementByItemID (BasicEntity p_tree, string p_SSR_ITEM_ID, array of string p_breadcrumbs out)</p> <p>Searches for and returns an entity object based on the item ID specified. It can be used for both AIR and APT trees.</p>
public BaseAIREntity	<p>getAIRItemByNodeID(number p_nodeID, MessageLogBase p_Messages out)</p> <p>Retrieves the AIR entity object from the student's APT based on the node ID of the item in Program Format. The APT Header should be populated in the APTAPI property APTHHeader by invoking the getHeader method prior to calling this method.</p>
public BaseAIREntity	<p>getAIRItemByNodeIDInAPTHHeader(string p_Emplid, string p_Institution, number p_Instance, number p_nodeID, MessageLogBase p_Messages out)</p> <p>Retrieves the AIR entity object from the student's APT based on the node ID of the item in Program Format.</p>
public void	<p>getAllItemIDsByType (BasicEntity p_tree, string p_SSR_ITEM_TYPE, array of string p_Items out)</p> <p>This method returns a list of all item IDs that match the parameter p_SSR_ITEM_TYPE in the entity tree p_tree.</p>
public void	<p>getAllItemsByType (BasicEntity p_tree, string p_SSR_ITEM_TYPE, array of BasicEntity p_Items out)</p> <p>This method returns all items under &p_tree that match the item type value provided in &p_SSR_ITEM_TYPE.</p>

Return Data Type	Name and Description
public BaseAPTEntity	<p>getAPTItemByNodeID (number p_nodeID, MessageLogBase p_Messages out)</p> <p>Retrieves the APT entity object from the student's APT based on the node ID of the item in Program Format. The APT Header should be populated in the APTAPI property APTheader by invoking the getHeader method prior to calling this method.</p>
public BaseAPTEntity	<p>getAPTItemByNodeIDInAPTheader(string p_Emplid, string p_Institution, number p_Instance, number p_nodeID, MessageLogBase p_Messages out)</p> <p>Retrieves the APT entity object from the student's APT based on the node ID of the item in Program Format.</p>
public string	<p>getCurrentPlanningNodeItemID (string p_Emplid, string p_Institution, number p_Instance, MessageLogBase p_Messages out)</p> <p>Finds the current planning node item ID of the student from the APT. This method examines AIR and APT structures of the student and determines the planning node item ID.</p>
public void	<p>getHeader (string p_Emplid, string p_Institution, number p_Student_car_nbr)</p> <p>Retrieves an existing header, allows adding/editing of children.</p>
public void	<p>getHeaderEfficiently (string emplid, string institution, number instance)</p> <p>Retrieves an existing header, allows adding/editing of children. This method is more efficient from a performance perspective than getHeader().</p>
public string	<p>getNextPlanningNodeItemID (string p_Emplid, string p_Institution, number p_Instance, MessageLogBase p_Messages out)</p> <p>Finds the planning node item ID that should be activated next. This method examines AIR and APT structures of the student and determines the next planning node item ID that should be activated.</p>

<i>Return Data Type</i>	<i>Name and Description</i>
public void	<p>Initialize()</p> <p>Initializes state properties ProgramFormat, EnrollmentCohort and PoS based on the current APTHeader value.</p>
public boolean	<p>removeIAMEnrollentDataForItem(number p_SSR_APT_ITEM_SEQ, number p_ATTEMPT_NBR, string p_Term, string p_SSR_ACTIVITY_ID, number p_SSR_ACT_ID_SEQ_NBR, MessageLogBase p_Messages out)</p> <p>Removes Individual Activity Management (IAM) enrollment information from a student's APT course item.</p>
public boolean	<p>removeIAMEnrollentDataForItemInAPTHeader(string p_Emplid, string p_Institution, number p_Instance, number p_SSR_APT_ITEM_SEQ, number p_ATTEMPT_NBR, string p_Term, string p_SSR_ACTIVITY_ID, number p_SSR_ACT_ID_SEQ_NBR, MessageLogBase p_Messages out)</p> <p>Removes Individual Activity Management (IAM) enrollment information from a student's APT course item.</p>
public boolean	<p>removeItem (string p_APT_Item_ID, MessageLogBase p_Messages out)</p> <p>Removes an APT Item from the student's APT structure. Invoke the APT API save() method to really delete it from the backend tables. The APT Header should be populated in the APTAPI property APTHeader by invoking the getHeader method prior to calling this method.</p>
public boolean	<p>removeItemFromAPTHeader (string p_Emplid, string p_Institution, number p_Instance, string p_APT_Item_ID, MessageLogBase p_Messages out)</p> <p>Removes an APT Item from the student's APT structure. Invoke the APT API save() method to really delete it from the backend tables.</p>

<i>Return Data Type</i>	<i>Name and Description</i>
public boolean	<p>removeSubstituteItem (string p_Substitute_Item_ID, MessageLogBase p_Messages out)</p> <p>Remove a substitute item from the student's APT structure. This method must be used instead of removeItem or removeItemFromAPTHHeader methods to remove a substitute item. The APT Header should be populated in the APTAPI property APTHeader by invoking the getHeader method prior to calling this method.</p>
public boolean	<p>removeSubstituteItemInAPTHHeader (string p_Emplid, string p_Institution, number p_Instance, string p_Substitute_Item_ID, MessageLogBase p_Messages out)</p> <p>Remove a substitute item from the student's APT structure. This method must be used instead of removeItem or removeItemFromAPTHHeader methods to remove a substitute item.</p>
public MessageLogBase	<p>Save()</p> <p>Saves the header and all children, if it is a new header creates a counter row.</p>
public void	<p>saveExceptionToLog (string p_component, Exception p_exception)</p> <p>This method will write debugging information to the SOA log file/table (based on SOA setup) based on the passed in exception object.</p>
public boolean	<p>setContextRoot (string p_itemID)</p> <p>Provide an EQT or Planning node item ID as parameter to set it as the API's context root item. This will help the API perform certain operations faster as it operates within the APT sub-tree of the planning/term node. This is not mandatory, but greatly improves performance of the APIT methods.</p>
public boolean	<p>substituteItem (string p_Item_ID, string p_Substitute_Item_ID, MessageLogBase p_Messages out)</p> <p>Substitutes one APT Item with another in the student's APT structure. The APT Header should be populated in the APTAPI property APTHeader by invoking the getHeader method prior to calling this method.</p>

Return Data Type	Name and Description
public boolean	<p>substituteItemInAPTHeader (string p_Emplid, string p_Institution, number p_Instance, string p_Item_ID, string p_Substitute_Item_ID, MessageLogBase p_Messages out)</p> <p>Substitutes one APT Item with another in the student's APT structure.</p>
public boolean	<p>TermActivate (BaseAPTEntity p_APTEntity, MessageLogBase p_Messages out)</p> <p>This method creates a new row in STDNT_CAR_TERM for the term value specified in the APT schedule.</p>

Details

Property Detail:

Name	Details
APTHeader	<p>APTHeader</p> <p>The APT Header APT Entity object that is populated when the getHeader() method is invoked.</p>
CONTEXT_ROOT	<p>public BasicEntity</p> <p>The APT Entity object which is set as the root context for all method processing in the API. This is usually set as the planning node or equates to term node APT item. This property is set by consumers of the API so that only items that fall under this root item are processed. If this property is blank, the APT Header is considered as the root item. This property is set when the setContextRoot() method is invoked.</p>
CONTEXT_ROOT_AIR	<p>public BasicEntity</p> <p>The AIR Entity object which is set as the root context for all method processing in the API. This is usually set as the planning node or equates to term node AIR item. This property is set by consumers of the API so that only items that fall under this root item is processed. If this property is blank, the PoS property is considered as the root item. This property is set when the setContextRoot() method is invoked.</p>

Name	Details
CRSE_FILTER	public string This property determines if the APT structure should fill completed and in-progress courses. Set value 'Y' if the Course should ignore completed and in-progress courses.
EnrollmentCohort	public EnrollmentCohort The enrollment cohort object corresponding to the APT Header in context.
FILL_COURSE_GROUP	public Boolean Set this property to true if the course group entities should be populated in the AIR structure.
FILL_COURSE_OFFERING	public Boolean Set this property to false to turn off loading course offering details entity under AIR Course, default is true.
FILL_NON_PFN_ITEMS	public Boolean Set this property to false if non planning node items should be excluded from the AIR structure.
PERFORM_VALIDATE	public Boolean Set this property to false if validation logic should be ignored when save() method is invoked. By default, validation logic is processed when save method is invoked.
PoS	public BaseAIREntity The Program of Study AIR Entity object corresponding to the APT Header object. This property is automatically instantiated along with the APTHeader APT Entity object when the getHeader() method is invoked.
ProgramFormat	public ProgramFormatSetup The program format object corresponding to the APT Header in context.

Name	Details
TERM_ACTIVATE	public boolean Set this property to true to term activate into terms defined in the EQT items on save.

Constructor Detail:

Name	Details
APTAPI	public APTAPI ()

Method Detail:

Name	Details
activateCurrentPlanningNode	public boolean activateCurrentPlanningNode (MessageLogBase p_Messages out) Activates the current planning node and all its program format tree node child items by setting the APT Attempt status to 'Activated'. This method will perform this operation only if the attempt status of the current planning node is null. Parameters: MessageLogBase p_Messages(out) - Messages/Warning if any will be added to this object Returns: boolean

Name	Details
<p>activateCurrentPlanningNodeInAPTHeder</p>	<p>public boolean activateCurrentPlanningNodeInAPTHeder (string p_Emplid, string p_Institution, number p_Instance, MessageLogBase p_Messages out)</p> <p>Activates the current planning node and all its program format tree node child items by setting the APT Attempt status to 'Activated'. This method will perform this operation only if the attempt status of the current planning node is null.</p> <p>Parameters:</p> <ul style="list-style-type: none"> • string p_Emplid - The Employee ID of the student • string p_Institution - The Institution value • number p_Instance - The APT instance number of the student • MessageLogBase p_Messages(out) - Messages/Warning if any will be added to this object <p>Returns:</p> <p>boolean</p>
<p>activateProgFormatNode</p>	<p>public boolean activateProgFormatNode(BaseAPTEntity p_APT_Entity, MessageLogBase p_Messages out)</p> <p>Activates the Program Format node entity object passed in as a parameter.</p> <p>Parameters:</p> <ul style="list-style-type: none"> • BaseAPTEntity p_APT_Entity - The program format node APT entity that should be activated. • MessageLogBase p_Messages(out) <p>Returns:</p> <p>boolean</p>

Name	Details
addIAMEnrollentDataForItem	<p>public boolean addIAMEnrollentDataForItem (number p_SSR_APT_ITEM_SEQ, number p_ATTEMPT_NBR, string p_Term, string p_SSR_ACTIVITY_ID, number p_SSR_ACT_ID_SEQ_NBR, MessageLogBase p_Messages out)</p> <p>Adds Individual Activity Management (IAM) enrollment information to a student's APT course item.</p> <p>Parameters:</p> <ul style="list-style-type: none"> • number p_SSR_APT_ITEM_SEQ - APT item sequence of the item to be updated • number p_ATTEMPT_NBR - APT attempt number of the item to be updated • string p_Term • string p_SSR_ACTIVITY_ID - IAM activity ID • number p_SSR_ACT_ID_SEQ_NBR - The class enrolled into • MessageLogBase p_Messages(out) - Messages/Warning if any will be added to this object <p>Returns:</p> <p>boolean</p>

Name	Details
<p>addIAMEnrollentDataForItemInAPTHeader</p>	<p>public boolean addIAMEnrollentDataForItemInAPTHeader (string p_Emplid, string p_Institution, number p_Instance, number p_SSR_APT_ITEM_SEQ, number p_ATTEMPT_NBR, string p_Term, string p_SSR_ACTIVITY_ID, number p_SSR_ACT_ID_SEQ_NBR, MessageLogBase p_Messages out)</p> <p>Adds Individual Activity Management (IAM) enrollment information to a student's APT course item.</p> <p>Parameters:</p> <ul style="list-style-type: none"> • string p_Emplid - The Employee ID of the student • string p_Institution - The Institution value • number p_Instance - The APT instance number of the student • number p_SSR_APT_ITEM_SEQ - APT item sequence of the item to be updated • number p_ATTEMPT_NBR - APT attempt number of the item to be updated • string p_Term • string p_SSR_ACTIVITY_ID - IAM activity ID • number p_SSR_ACT_ID_SEQ_NBR - The class enrolled into • MessageLogBase p_Messages(out) - Messages/Warning if any will be added to this object <p>Returns:</p> <p>boolean</p>

Name	Details
addItem	<p>public BaseAPTEntity addItem (string p_AIR_Item_ID, MessageLogBase p_Messages out)</p> <p>Adds an AIR Item to a student's APT. This method takes care of automatically adding the parent items (if they do not exist) and adds child items based on the enrollment category of the item being added.</p> <p>This method requires that an APT header record already exists for the student and it should be populated in the APTAPI property APTHHeader by invoking the getHeader method.</p> <p>Parameters:</p> <ul style="list-style-type: none"> • string p_AIR_Item_ID - Item ID of the AIR item that must be added to the student's APT • MessageLogBase p_Messages(out) - Messages/Warning if any will be added to this object <p>Returns:</p> <p>BaseAPTEntity</p>

Name	Details
<p>addItemToAPTHHeader</p>	<pre>public BaseAPTEntity addItemToAPTHHeader (string p_ Emplid, string p_Institution, number p_Instance, string p_AIR _Item_ID, MessageLogBase p_Messages out)</pre> <p>Adds an AIR Item to a student's APT. This method takes care of automatically adding the parent items (if they do not exist) and adds child items based on the enrollment category of the item being added. This method requires that an APT header record already exists for the student.</p> <p>Parameters:</p> <ul style="list-style-type: none"> • string p_Emplid - The Employee ID of the student • string p_Institution - The Institution value • number p_Instance - The APT instance number of the student • string p_AIR_Item_ID - Item ID of the AIR item that must be added to the student's APT • MessageLogBase p_Messages(out) - Messages/Warning if any will be added to this object <p>Returns:</p> <p>BaseAPTEntity</p>

Name	Details
addItemUnderAPTItem	<p data-bbox="865 264 1472 394">public BaseAPTEntity addItemUnderAPTItem (string p_Emplid, string p_Institution, number p_Instance, string p_Parent_Item_ID, string p_Child_Item_ID, MessageLogBase p_Messages out)</p> <p data-bbox="865 426 1435 520">Adds an AIR Item as a child to a specific APT item. This method can be used to add an item that is not present in the AIR hierarchy.</p> <p data-bbox="865 552 980 583">Parameters:</p> <ul data-bbox="865 615 1464 1087" style="list-style-type: none"> • string p_Emplid - The Employee ID of the student • string p_Institution - The Institution value • number p_Instance - The APT instance number of the student • string p_Parent_Item_ID - Item ID of the parent APT item under which the new item must be created as a child • string p_Child_Item_ID - Item ID of the AIR item to be created • MessageLogBase p_Messages(out) - Messages/Warning if any will be added to this object <p data-bbox="865 1119 948 1150">Returns:</p> <p data-bbox="865 1182 1016 1213">BaseAPTEntity</p>

Name	Details
<p>addItemUnderAPTItemV2</p>	<pre>public BaseAPTEntity addItemUnderAPTItem(string p_ Emplid, string p_Institution, number p_Instance, string p_ Parent_Item_ID, number p_Parent_Item_seq, string p_Child_ Item_ID, MessageLogBase p_Messages out)</pre> <p>Adds an AIR Item as a child to a specific APT item. This method can be used to add an item that is not present in the AIR hierarchy.</p> <p>Parameters:</p> <ul style="list-style-type: none"> • string p_Emplid - The Employee ID of the student • string p_Institution - The Institution value • number p_Instance - The APT instance number of the student • string p_Parent_Item_ID - Item ID of the parent APT item under which the new item must be created as a child • number p_Parent_Item_seq - APT Item sequence (SSR_APT_ITEM_SEQ) of the parent APT item under which the new item must be created as a child • string p_Child_Item_ID - Item ID of the AIR item to be created • MessageLogBase p_Messages(out) - Messages/Warning if any will be added to this object <p>Returns:</p> <p>BaseAPTEntity</p>

Name	Details
<p>createAPTAttemptForItem</p>	<pre>public APTAttempt createAPTAttemptForItem (BaseAPTEntity p_parent, BaseAIREntity p_parent_AIR_ Entity, MessageLogBase p_Messages out)</pre> <p>Adds a new APT Attempt row for an APT item. This method also creates the APT schedule and APT Result data for the newly created APT Attempt.</p> <p>Parameters:</p> <ul style="list-style-type: none"> • BaseAPTEntity p_parent - Parent APT item under which this new APT Attempt must be created • BaseAIREntit p_parent_AIR_Entity – The corresponding AIR item of the p_parent APT item • MessageLogBase p_Messages(out) <p>Returns:</p> <p>APTAttempt</p>
<p>createAPTHeader</p>	<pre>public boolean createAPTHeader(string p_Emplid, string p_ Acad_career, number p_Student_car_nbr, string p_Institution, MessageLogBase p_Messages out)</pre> <p>Creates a new APT Header record. To save the newly created APT Header to the database invoke the save method.</p> <hr/> <p>Note: The student program stack ACAD_PROG.SSR_APT_INSTANCE is not updated by this method.</p> <hr/> <p>Parameters:</p> <ul style="list-style-type: none"> • string p_Emplid - The Employee ID of the student • string p_Acad_career - The student's academic career in program/plan • number p_Student_car_nbr - The student's career number in program/plan • string p_Institution - The Institution value • MessageLogBase p_Messages(out) - Messages/Warnings if any will be added to this object. <p>Returns:</p> <p>boolean</p>

Name	Details
<p>createAPTHeaderFromEntity</p>	<p>public boolean createAPTHeaderFromEntity (StudentProgram p_StudentProgram, MessageLogBase p_Messages out)</p> <p>Creates a new APT Header record. This method uses a pre-populated entity object SSR_CAREER_TERM:Accessors:StudentProgram. This method holds the core logic for creating the APT header and is invoked by all the other methods that create APT header.</p> <p>To save the newly created APT Header to the database invoke the save method.</p> <hr/> <p>Note: The student program stack ACAD_PROG.SSR_APT_INSTANCE is not updated by this method.</p> <hr/> <p>Parameters:</p> <ul style="list-style-type: none"> • StudentProgram p_StudentProgram - ACAD_PROG entity object • MessageLogBase p_Messages(out) - Messages/Warnings if any will be added to this object <p>Returns:</p> <p>boolean</p>
<p>createAPTHeaderFromRecord</p>	<p>public boolean createAPTHeaderFromRecord (Record p_recACAD_PROG, MessageLogBase p_Messages out)</p> <p>Creates a new APT Header record. This method is meant to be used from online components by passing the ACAD_PROG component buffer record as the parameter. To save the newly created APT Header to the database invoke the save method.</p> <hr/> <p>Note: The student program stack ACAD_PROG.SSR_APT_INSTANCE is not updated by this method.</p> <hr/> <p>Parameters:</p> <ul style="list-style-type: none"> • Record p_recACAD_PROG - ACAD_PROG component buffer record object • MessageLogBase p_Messages(out) - Messages/Warnings if any will be added to this object <p>Returns:</p> <p>boolean</p>

Name	Details
createAPTItem	<p>public BaseAPTEntity createAPTItem (BasicEntity p_parent, string p_SSR_ITEM_ID, BaseAIREntity p_AIR_Entity, boolean p_full_mode, MessageLogBase p_Messages out)</p> <p>Create one APT item under a parent APT item. This also creates the APT attempt, schedule and result records. Child academic items are also created based on the mode parameter and the enrollment category associated with the item.</p> <p>Parameters:</p> <ul style="list-style-type: none"> • BasicEntity p_parent - Parent APT item under which this new APT item must be created • string p_SSR_ITEM_ID - AIR item ID of the APT item to be created • BaseAIREntity p_AIR_Entity - The corresponding AIR entity object of the APT item to be created • boolean p_full_mode - If true then it creates all children and cascades to create grandchildren and so on, if false only creates itself and any children which have enrollment category auto add option turned on • MessageLogBase p_Messages(out) <p>Returns:</p> <p>BaseAPTEntity</p>
createCounterRecord	<p>public void createCounterRecord(string p_Emplid, string p_Institution, number p_Instance)</p> <p>This method should be called to setup the counter record SSR _APT_ITM_CNT. If a row already exists for the given emplid, institution and APT instance key values, it verifies if the counter value is correct and updates it to the right value if it is not. If a counter row does not exist for the given keys then it creates a new row with the correct counter value.</p> <p>Parameters:</p> <ul style="list-style-type: none"> • string p_Emplid - The Employee ID of the student • string p_Institution - The Institution value • number p_Instance - The APT instance number of the student

Name	Details
<p>deleteAPTHeader</p>	<p>public boolean deleteAPTHeader (string p_Emplid, string p_Institution, number p_Instance, MessageLogBase p_Messages out)</p> <p>Deletes APT Header record. Delete is only allowed if there are no references in student program stack or admissions application stack.</p> <p>Parameters:</p> <ul style="list-style-type: none"> • string p_Emplid - The Employee ID of the student • string p_Institution - The Institution value • number p_Instance - The APT instance number of the student • MessageLogBase p_Messages(out) - Messages/Warnings if any will be added to this object <p>Returns:</p> <p>boolean</p>
<p>dropEnrolledItem</p>	<p>public boolean dropEnrolledItem (number p_SSR_APT_ITEM_SEQ, number p_ATTEMPT_NBR, string p_Term, number p_classNumber, MessageLogBase p_Messages out)</p> <p>Deletes enrollment information to a student's APT course item.</p> <p>Parameters:</p> <ul style="list-style-type: none"> • number p_SSR_APT_ITEM_SEQ • number p_ATTEMPT_NBR • string p_Term - Term into which the enrollment was made • number p_classNumber - The class enrolled into • MessageLogBase p_Messages(out) - Messages/Warning if any will be added to this object <p>Returns:</p> <p>boolean</p>

Name	Details
dropEnrolledItemInAPTHeder	<p>public boolean dropEnrolledItemInAPTHeder(string p_Emplid, string p_Institution, number p_Instance, number p_SSR_APT_ITEM_SEQ, number p_ATTEMPT_NBR, string p_Term, number p_classNumber, MessageLogBase p_Messages out)</p> <p>Deletes enrollment information from a student's APT course item.</p> <p>Parameters:</p> <ul style="list-style-type: none"> • string p_Emplid - The Employee ID of the student • string p_Institution - The Institution value • number p_Instance - The APT instance number of the student • number p_SSR_APT_ITEM_SEQ • number p_ATTEMPT_NBR • string p_Term - Term into which the enrollment was made • number p_classNumber - The class enrolled into • MessageLogBase p_Messages(out) - Messages/Warning if any will be added to this object <p>Returns:</p> <p>boolean</p>

Name	Details
enrollItem	<p>public boolean enrollItem(number p_SSR_APT_ITEM_SEQ, number p_ATTEMPT_NBR, string p_Term, number p_classNumber, MessageLogBase p_Messages out)</p> <p>Adds enrollment information to a student's APT course item.</p> <p>Parameters:</p> <ul style="list-style-type: none"> • number p_SSR_APT_ITEM_SEQ • number p_ATTEMPT_NBR • string p_Term - Term into which the enrollment was made • number p_classNumber - The class enrolled into • MessageLogBase p_Messages(out) - Messages/Warning if any will be added to this object <p>Returns:</p> <p>boolean</p>

Name	Details
enrollItemInAPTHHeader	<pre>public boolean enrollItemInAPTHHeader(string p_Emplid, string p_Institution, number p_Instance, number p_SSR_APT _ITEM_SEQ, number p_ATTEMPT_NBR, string p_Term, number p_classNumber, MessageLogBase p_Messages out)</pre> <p>Adds enrollment information to a student's APT course item.</p> <p>Parameters:</p> <ul style="list-style-type: none"> • string p_Emplid - The Employee ID of the student • string p_Institution - The Institution value • number p_Instance - The APT instance number of the student • number p_SSR_APT_ITEM_SEQ • number p_ATTEMPT_NBR • string p_Term - Term into which the enrollment was made • number p_classNumber - The class enrolled into • MessageLogBase p_Messages(out) - Messages/Warning if any will be added to this object <p>Returns:</p> <p>boolean</p>

Name	Details
<p>findAPTElementByItemSequence</p>	<p>public BaseAPTEntity findAPTElementByItemSequence (BaseAPTEntity p_tree, number p_SSR_APT_ITEM_SEQ, array of string p_breadcrumbs out)</p> <p>Searches for and returns an entity object based on the APT item sequence number specified. It can be used only in APT trees.</p> <p>Parameters:</p> <ul style="list-style-type: none"> • BaseAPTEntity p_tree - The root node from where the search should start • number p_SSR_APT_ITEM_SEQ - The Item ID of the item to be found • array of string p_breadcrumbs(out)- This array of string will be populated with entity IDs of the parent items from the element (being searched for) to the root. <p>Returns:</p> <p>BaseAPTEntity</p>
<p>findElementByItemID</p>	<p>public BasicEntity findElementByItemID (BasicEntity p_tree, string p_SSR_ITEM_ID, array of string p_breadcrumbs out)</p> <p>Searches for and returns an entity object based on the item ID specified. It can be used for both AIR and APT trees.</p> <p>Parameters:</p> <ul style="list-style-type: none"> • BasicEntity p_tree - The root node from where the search should start • string p_SSR_ITEM_ID - The Item ID of the item to be found • array of string p_breadcrumbs(out) - This array of string will be populated with entity IDs of the parent items from the element (being searched for) to the root. <p>Returns:</p> <p>BasicEntity</p>

Name	Details
getAIRItemByNodeID	<p>public BaseAIREntity getAIRItemByNodeID(number p_nodeID, MessageLogBase p_Messages out)</p> <p>Retrieves the AIR entity object from the student's APT based on the node ID of the item in Program Format. The APT Header should be populated in the APTAPI property APTHeader by invoking the getHeader method prior to calling this method.</p> <p>Parameters:</p> <ul style="list-style-type: none"> • number p_nodeID - The node ID from Program Format • MessageLogBase p_Messages(out) <p>Returns:</p> <p>BaseAIREntity</p>
getAIRItemByNodeIDInAPTHeader	<p>public BaseAIREntity getAIRItemByNodeIDInAPTHeader(string p_Emplid, string p_Institution, number p_Instance, number p_nodeID, MessageLogBase p_Messages out)</p> <p>Retrieves the AIR entity object from the student's APT based on the node ID of the item in Program Format.</p> <p>Parameters:</p> <ul style="list-style-type: none"> • string p_Emplid - The Employee ID of the student • string p_Institution - The Institution value • number p_Instance - The APT instance number of the student • number p_nodeID - The node ID from Program Format • MessageLogBase p_Messages(out) <p>Returns:</p> <p>BaseAIREntity</p>

Name	Details
<p>getAllItemIDsByType</p>	<p>public void getAllItemIDsByType (BasicEntity p_tree, string p_SSR_ITEM_TYPE, array of string p_Items out)</p> <p>This method returns a list of all item IDs that match the parameter p_SSR_ITEM_TYPE in the entity tree p_tree.</p> <p>Parameters:</p> <ul style="list-style-type: none"> • BasicEntity p_tree • string p_SSR_ITEM_TYPE • array of string p_Items(out)
<p>public void</p>	<p>getAllItemsByType (BasicEntity p_tree, string p_SSR_ITEM_TYPE, array of BasicEntity p_Items out)</p> <p>This method returns all items under parameter p_tree that match the item type value provided in p_SSR_ITEM_TYPE.</p> <p>Parameters:</p> <ul style="list-style-type: none"> • BasicEntity p_tree • string p_SSR_ITEM_TYPE • array of BasicEntity p_Items(out)
<p>getAPTItemByNodeID</p>	<p>public BaseAPTEntity getAPTItemByNodeID(number p_nodeID, MessageLogBase p_Messages out)</p> <p>Retrieves the APT entity object from the student's APT based on the node ID of the item in Program Format. The APT Header should be populated in the APTAPI property APTHHeader by invoking the getHeader method prior to calling this method.</p> <p>Parameters:</p> <ul style="list-style-type: none"> • number p_nodeID - The node ID from Program Format • MessageLogBase p_Messages(out) <p>Returns:</p> <p>BaseAPTEntity</p>

Name	Details
<p>getAPTItemByNodeIDInAPTHeder</p>	<pre>public BaseAPTEntity getAPTItemByNodeIDInAPTHeder (string p_Emplid, string p_Institution, number p_Instance, number p_nodeID, MessageLogBase p_Messages out)</pre> <p>Retrieves the APT entity object from the student's APT based on the node ID of the item in Program Format.</p> <p>Parameters:</p> <ul style="list-style-type: none"> • string p_Emplid - The Employee ID of the student • string p_Institution - The Institution value • number p_Instance - The APT instance number of the student • number p_nodeID - The node ID from Program Format • MessageLogBase p_Messages(out) <p>Returns:</p> <p>BaseAPTEntity</p>
<p>getCurrentPlanningNodeItemID</p>	<pre>public string getCurrentPlanningNodeItemID (string p_Emplid, string p_Institution, number p_Instance, MessageLogBase p_Messages out)</pre> <p>Finds the current planning node item ID of the student from the APT. This method examines AIR and APT structures of the student and determines the planning node item ID.</p> <p>Parameters:</p> <ul style="list-style-type: none"> • string p_Emplid - The Employee ID of the student • string p_Institution - The Institution value • number p_Instance - The APT instance number of the student • MessageLogBase p_Messages(out) - Messages/Warning if any will be added to this object <p>Returns:</p> <p>string</p>

Name	Details
getHeader	<p>public void getHeader (string p_Emplid, string p_Institution, number p_Student_car_nbr)</p> <p>Retrieves an existing header, allows adding/editing of children.</p> <p>Parameters:</p> <ul style="list-style-type: none"> • string p_Emplid - The Employee ID of the student • string p_Institution - The Institution value of the student • number p_Student_car_nbr - The student's career number in program/plan
getHeaderEfficiently	<p>public void getHeaderEfficiently(string emplid, string institution, number instance)</p> <p>Retrieves an existing header, allows adding/editing of children. This method is more efficient from a performance perspective than getHeader().</p> <p>Parameters:</p> <ul style="list-style-type: none"> • string emplid • string institution • number instance

Name	Details
getNextPlanningNodeItemID	<p>public string getNextPlanningNodeItemID (string p_Emplid, string p_Institution, number p_Instance, MessageLogBase p_Messages out)</p> <p>Finds the planning node item ID that should be activated next. This method examines AIR and APT structures of the student and determines the next planning node item ID that should be activated.</p> <p>Parameters:</p> <ul style="list-style-type: none"> • string p_Emplid - The Employee ID of the student • string p_Institution - The Institution value • number p_Instance - The APT instance number of the student • MessageLogBase p_Messages(out) - Messages/Warning if any will be added to this object <p>Returns:</p> <p>string</p>
Initialize	<p>public void Initialize()</p> <p>Initializes state properties ProgramFormat, EnrollmentCohort and PoS based on the current APTHeader value.</p>

Name	Details
<p>removeIAMEnrollentDataForItem</p>	<pre>public boolean removeIAMEnrollentDataForItem(number p_SSR_APT_ITEM_SEQ, number p_ATTEMPT_NBR, string p_Term, string p_SSR_ACTIVITY_ID, number p_SSR_ACT_ID_SEQ_NBR, MessageLogBase p_Messages out)</pre> <p>Removes Individual Activity Management (IAM) enrollment information from a student's APT course item.</p> <p>Parameters:</p> <ul style="list-style-type: none"> • number p_SSR_APT_ITEM_SEQ - APT item sequence of the item to be updated • number p_ATTEMPT_NBR - APT attempt number of the item to be updated • string p_Term • string p_SSR_ACTIVITY_ID - IAM activity ID • number p_SSR_ACT_ID_SEQ_NBR - The class enrolled into • MessageLogBase p_Messages(out) - Messages/Warning if any will be added to this object <p>Returns:</p> <p>boolean</p>

Name	Details
removeIAMEnrollentDataForItemInAPTHeader	<p>public boolean removeIAMEnrollentDataForItemInAPTHeader(string p_Emplid, string p_Institution, number p_Instance, number p_SSR_APT_ITEM_SEQ, number p_ATTEMPT_NBR, string p_Term, string p_SSR_ACTIVITY_ID, number p_SSR_ACT_ID_SEQ_NBR, MessageLogBase p_Messages out)</p> <p>Removes Individual Activity Management (IAM) enrollment information from a student's APT course item.</p> <p>Parameters:</p> <ul style="list-style-type: none"> • string p_Emplid - The Employee ID of the student • string p_Institution - The Institution value • number p_Instance - The APT instance number of the student • number p_SSR_APT_ITEM_SEQ - APT item sequence of the item to be updated • number p_ATTEMPT_NBR - APT attempt number of the item to be updated • string p_Term • string p_SSR_ACTIVITY_ID - IAM activity ID • number p_SSR_ACT_ID_SEQ_NBR - The class enrolled into • MessageLogBase p_Messages(out) - Messages/Warning if any will be added to this object <p>Returns:</p> <p>boolean</p>

Name	Details
removeItem	<p>public boolean removeItem (string p_APT_Item_ID, MessageLogBase p_Messages out)</p> <p>Removes an APT Item from the student's APT structure. Invoke the APT API save() method to really delete it from the backend tables.</p> <p>The APT Header should be populated in the APTAPI property APHeader by invoking the getHeader method prior to calling this method.</p> <p>Parameters:</p> <ul style="list-style-type: none"> • string p_APT_Item_ID - Item ID of the AIR item that must be removed from the student's APT • MessageLogBase p_Messages(out) - Messages/Warning if any will be added to this object <p>Returns:</p> <p>boolean</p>
removeItemFromAPHeader	<p>public boolean removeItemFromAPHeader (string p_Emplid, string p_Institution, number p_Instance, string p_APT_Item_ID, MessageLogBase p_Messages out)</p> <p>Removes an APT Item from the student's APT structure. Invoke the APT API save() method to really delete it from the backend tables.</p> <p>Parameters:</p> <ul style="list-style-type: none"> • string p_Emplid - The Employee ID of the student • string p_Institution - The Institution value • number p_Instance - The APT instance number of the student • string p_APT_Item_ID - Item ID of the AIR item that must be removed from the student's APT • MessageLogBase p_Messages(out) - Messages/Warning if any will be added to this object <p>Returns:</p> <p>boolean</p>

Name	Details
removeSubstituteItem	<p>public boolean removeSubstituteItem (string p_Substitute_Item_ID, MessageLogBase p_Messages out)</p> <p>Remove a substitute item from the student's APT structure. This method must be used instead of removeItem or removeItemFromAPTHheader to remove a substitute item The APT Header should be populated in the APTAPI property APThheader by invoking the getHeader method prior to calling this method.</p> <p>Parameters:</p> <ul style="list-style-type: none"> • string p_Substitute_Item_ID - Item ID of the APT substitute item that must be removed • MessageLogBase p_Messages(out) - Messages/Warning if any will be added to this object <p>Returns:</p> <p>boolean</p>
removeSubstituteItemInAPTHheader	<p>public boolean removeSubstituteItemInAPTHheader (string p_Emplid, string p_Institution, number p_Instance, string p_Substitute_Item_ID, MessageLogBase p_Messages out)</p> <p>Remove a substitute item from the student's APT structure. This method must be used instead of removeItem or removeItemFromAPTHheader methods to remove a substitute item.</p> <p>Parameters:</p> <ul style="list-style-type: none"> • string p_Emplid - The Employee ID of the student • string p_Institution - The Institution value • number p_Instance - The APT instance number of the student • string p_Substitute_Item_ID - Item ID of the APT substitute item that must be removed • MessageLogBase p_Messages(out) - Messages/Warning if any will be added to this object <p>Returns:</p> <p>boolean</p>

Name	Details
save	<p>public MessageLogBase Save()</p> <p>Saves the header and all children, if it is a new header creates a counter row.</p> <p>Returns:</p> <p>MessageLogBase</p>
saveExceptionToLog	<p>public void saveExceptionToLog(string p_component, Exception p_exception)</p> <p>This method will write debugging information to the SOA log file/table (based on SOA setup) based on the passed in exception object.</p> <p>Parameters:</p> <ul style="list-style-type: none"> • string p_component - Name of the component/process/ event that encountered the exception. Used for identifying the source of entry in the log. • Exception p_exception - The exception object. Error message and stack trace information will extracted from this object to be saved to the log.
setContextRoot	<p>public boolean setContextRoot (string p_itemID)</p> <p>Provide an EQT or Planning node item ID as parameter to set it as the API's context root item. This will help the API perform certain operations faster as it operates within the APT sub-tree of the planning/term node. This is not mandatory, but greatly improves performance of the APIT methods.</p> <p>Parameters:</p> <p>string p_itemID - APT item ID of a planning or equates to term node in the APT</p> <p>Returns:</p> <p>boolean</p>

Name	Details
substituteItem	<p data-bbox="865 262 1425 321">public boolean substituteItem (string p_Item_ID, string p_Substitute_Item_ID, MessageLogBase p_Messages out)</p> <p data-bbox="865 359 1437 485">Substitutes one APT Item with another in the student's APT structure. The APT Header should be populated in the APTAPI property APHeader by invoking the getHeader method prior to calling this method.</p> <p data-bbox="865 522 980 546">Parameters:</p> <ul data-bbox="865 583 1453 835" style="list-style-type: none"><li data-bbox="865 583 1453 642">• string p_Item_ID - Item ID of the AIR item that must be substituted<li data-bbox="865 680 1453 739">• string p_Substitute_Item_ID - Item ID of the AIR item that must be substituted<li data-bbox="865 777 1453 835">• MessageLogBase p_Messages(out) - Messages/Warning if any will be added to this object <p data-bbox="865 873 948 896">Returns:</p> <p data-bbox="865 934 943 957">boolean</p>

Name	Details
<p>substituteItemInAPTHeader</p>	<p>public boolean substituteItemInAPTHeader (string p_Emplid, string p_Institution, number p_Instance, string p_Item_ID, string p_Substitute_Item_ID, MessageLogBase p_Messages out)</p> <p>Substitutes one APT Item with another in the student's APT structure.</p> <p>Parameters:</p> <ul style="list-style-type: none"> • string p_Emplid - The Employee ID of the student • string p_Institution - The Institution value • number p_Instance - The APT instance number of the student • string p_Item_ID - Item ID of the AIR item that must be substituted • string p_Substitute_Item_ID - Item ID of the AIR item that must be substituted • MessageLogBase p_Messages(out) - Messages/Warning if any will be added to this object <p>Returns:</p> <p>boolean</p>
<p>TermActivate</p>	<p>public boolean TermActivate (BaseAPTEntity p_APTEntity, MessageLogBase p_Messages out)</p> <p>This method creates a new row in STDNT_CAR_TERM for the term value specified in the APT schedule.</p> <p>Parameters:</p> <ul style="list-style-type: none"> • BaseAPTEntity p_APTEntity - The APT entity whose scheduler STRM should be used for term activation • MessageLogBase p_Messages(out) - Messages/Warning if any will be added to this object <p>Returns:</p> <p>boolean</p>

Managing APT Program Transfer

When students change their program of study, the system creates a new APT instance. This section provides information on managing the program transfer process.

You need to make sure you have configured the program transfer settings on the Academic Institution 9 page. You also need to define which courses are equivalent to each other by creating course equivalency groups. Then, you can proceed with:

- [Defining Course Mappings for Programs](#)
- [Transferring Academic Items to a New Program](#)

Pages Used to Manage APT Program Transfer

<i>Page Name</i>	<i>Definition Name</i>	<i>Navigation</i>	<i>Usage</i>
Academic Institution 9	SSR_INST_PE	Set Up SACR > Foundation Tables > Academic Structure > Academic Institution Table > Academic Institution 9	Enable Program Enrollment and Activity Management defaults. For information, see “Enabling Program Enrollment and Activity Management Defaults” (Campus Solutions Application Fundamentals).
Course Equivalences	CRSE_EQUIV	Curriculum Management > Course Catalog > Course Equivalencies > Course Equivalencies	Define the course equivalency group. For information, see Creating Course Equivalency Groups .
Program Transfer Course Map	SSR_APT_COURSE_MAP	Curriculum Management > Academic Item Registry > Program Transfer Course Map	Define course mappings for programs.
APT Transfer	SSR_APT_PROG_TRANS	Records and Enrollment > Program Enrollment > APT Transfer	Transfer students’ academic items from the old program to the new program.

Defining Course Mappings for Programs

Access the Program Transfer Course Map page (**Curriculum Management > Academic Item Registry > Program Transfer Course Map**).

This example illustrates the fields and controls on the Program Transfer Course Map page. You can find definitions for the fields and controls later on this page.

Program Transfer Course Map

Academic Institution: PSUNV PeopleSoft University
 Destination Academic Program: 0000002138 B.A. Business Management

Destination Academic Program: Find | View All | First 1 of 1

*Effective Date: 01/01/1900 *Status: Active

Source Academic Program: Find | View All | First 1 of 1 Last

*Source Academic Program: 0000001753 B.A. Economics

Course Mapping									
*Source Course ID	*Source Course Offer Nbr	Subject / Catalog	Description	*Destination Course ID	*Destination Course Offer Nbr	Subject / Catalog	Description		
1	001213	SOC 103	Social Problems	007276	1	POL SCI 203	Intro to American Politics		+
2	666741	ECON 3001A	Microecon Policy Analysis I	666816	1	ACCT 2003	Management Accounting for Busi		+
3	666742	ECON 3001B	Microecon Policy Analysis II	666728	1	ECON 2001	Microeconomic Analysis I		+
4	666749	ECON 1001B	Economic Principles II	007125	1	ECON 198	Special Topics in Economics		+

Use this page to identify the courses from a source academic program that maps to equivalent courses in the destination academic program.

Note: The same course mapping is not allowed because these courses are matched automatically. For example, if SOC 103 (Social Problems) is in the source academic program *and* it already exists in the destination academic program, you don't have to include a mapping here. The system automatically matches these courses when you run the matching process on the APT Transfer page.

Transferring Academic Items to a New Program

Access the APT Transfer page (**Records and Enrollment > Program Enrollment > APT Transfer**).

This example illustrates the fields and controls on the APT (Academic Progress Tracker) Transfer page 1 of 2. You can find definitions for the fields and controls later on this page.

APT Transfer

Academic Institution: PeopleSoft University
 Test PE Transfer 001
 SRPETR001

Start Matching Post Transfer

Legend: Matched Equivalency Manual Not Matched

Destination APT: APT Instance 3 APT Tree Instance Status Active Effective Date 08/19/2020

APT Item Description	Item Type	Enrollment Category	Transfer Action	Term	Progress Level	Official Grade	Outcome	Personalize Include in Calculation Alert Number
B.A. Business Management								
- Year 1 - Foundation and Business Core								
- B.A. Bus Mgt - Semester 1								
- ECON 2: Macroeconomic Principles	Course	Mandatory	Matched: ECON 2	2020 Fall	40-In Progress			1 of 1
- ECON 3: Microeconomic Principles	Course	Mandatory	Matched: ECON 3	2020 Fall	40-In Progress			1 of 1
- POL SCI 1: Intro to US Govt and Politics	Course	Mandatory	Matched: POL SCI 1	2020 Fall	40-In Progress			1 of 1
- B.A. Bus Mgt - Semester 2								
- ECON 198: Special Topics in Economics	Course	Mandatory		2020 Fall QTr	20-Planned			1 of 1
- ECON 1004B: Economic Methods II	Course	Mandatory	Equivalency: ECON 112	2020 Fall QTr	40-In Progress			1 of 1
- Year 2 - Business Core								
- B.A. Bus Mgt - Semester 3								
- ECON 2001: Microeconomic Analysis I	Course	Mandatory		2021 Winter Qtr	20-Planned			1 of 1
- ECON 2003: Mainstream Macroeconomics I	Course	Mandatory		2021 Winter Qtr	20-Planned			1 of 1
- ECON 2005A: Economic Investigation I	Course	Mandatory		2021 Winter Qtr	20-Planned			1 of 1
- MGMT 1001: Organizational Behavior	Course	Mandatory		2021 Winter Qtr	20-Planned			1 of 1
- B.A. Bus Mgt - Semester 4								
- ECON 2012: Corporate Finance	Course	Mandatory		2021 Spring	20-Planned			1 of 1

This example illustrates the fields and controls on the APT (Academic Progress Tracker) Transfer page 2 of 2. You can find definitions for the fields and controls later on this page.

APT Item Description	Item Type	Enrollment Category	Term	Progress Level	Official Grade	Outcome	Personalize	Include in Calculation	Attempt Number
B.A. Economics	Program of Study						<input type="checkbox"/>		1 of 1
- B.A. Economics Part I	Phase						<input type="checkbox"/>		1 of 1
- BA Econ - Year 1	Stage						<input type="checkbox"/>		1 of 1
- BA Econ - Year 1 - Semester 1	Study Period						<input type="checkbox"/>		1 of 1
- ECON 2: Macroeconomic Principles	Course	Mandatory	2020 Fall	40-In Progress			<input checked="" type="checkbox"/>		1 of 1
- ECON 3: Microeconomic Principles	Course	Mandatory	2020 Fall	40-In Progress			<input checked="" type="checkbox"/>		1 of 1
- ECON 10: Introduction to Intl Economics	Course	Mandatory	2020 Fall	20-Planned			<input checked="" type="checkbox"/>		1 of 1
- POL SCI 1: Intro to US Govt and Politics	Course	Mandatory	2020 Fall	40-In Progress			<input checked="" type="checkbox"/>		1 of 1
- STATS 101: Statistical Analysis I	Course	Mandatory	2020 Fall	20-Planned			<input checked="" type="checkbox"/>		1 of 1
- BA Econ - Year 1 - Semester 2	Study Period						<input type="checkbox"/>		1 of 1
- ECON 1001B: Economic Principles II	Course	Mandatory	2020 Fall QTr	20-Planned			<input checked="" type="checkbox"/>		1 of 1
- ECON 1004B: Economic Methods II	Course	Mandatory	2020 Fall QTr	20-Planned			<input checked="" type="checkbox"/>		1 of 1
- ECON 112: Intl Political Economy	Course	Mandatory	2020 Fall QTr	40-In Progress			<input checked="" type="checkbox"/>		1 of 1
- Economics Year 1 Options	Requirement	Mandatory					<input type="checkbox"/>		1 of 1
- B.A. Economics Part II	Phase						<input type="checkbox"/>		1 of 1
- BA Econ - Year 2	Stage						<input type="checkbox"/>		1 of 1
- BA Econ - Year 2 - Semester 1	Study Period						<input type="checkbox"/>		1 of 1
- ECON 2001: Microeconomic Analysis I	Course	Mandatory	2021 Winter Ctr	20-Planned			<input checked="" type="checkbox"/>		1 of 1
- ECON 2003: Mainstream Macroeconomics I	Course	Mandatory	2021 Winter Ctr	20-Planned			<input checked="" type="checkbox"/>		1 of 1
- ECON 2005A: Economic Investigation I	Course	Mandatory	2021 Winter Ctr	20-Planned			<input checked="" type="checkbox"/>		1 of 1

Use this page to transfer courses or academic items from the source APT to the destination APT. When you search for students, the results show only active students with multiple APTs.

Field or Control	Description
Start Matching	Click to start the process of matching equivalent courses or academic items. The process looks at the transfer options you set up on the Academic Institution 9 page. The process then matches courses based on equivalent courses or academic items you defined on the Course Equivalences page and Program Transfer Course Map page, respectively. When the matching process ends, a Transfer Action column appears in the destination APT and shows you the academic items that matched.
Post Transfer	After running Start Matching, click to transfer then save the matched data in Destination APT.

Destination APT

Field or Control	Description
APT Tree	If you click this link, you see the APT Tree page where you can view the academic items within an APT instance.

Field or Control	Description
Transfer Action	<p>This column appears only after running Start Matching.</p> <p>You may see any one of these actions:</p> <ul style="list-style-type: none"> • Matched appears when the course ID from the source APT is the same as the course ID on the destination APT <i>and</i> there is a related enrollment or transfer credit in the source APT. <p>You can manually:</p> <ul style="list-style-type: none"> • Match courses if you enabled <i>Allow Manual Matching</i> in Program Transfer Options on the Academic Institution page. • Remove matched courses if you enabled <i>Allow Removal of Matched Course</i> in Program Transfer Options. • Equivalency appears if you enabled <i>Use Course Equivalency</i> in Program Transfer Options on the Academic Institution page. • Course Exists appears if a course already has an enrollment or transfer credit in the destination APT. • Transferred appears if the item was already transferred during a previous run of Start Matching.
Transfer Log	<p>This column appears after you run the transfer process. Click <i>Details</i> to see information for each item that was transferred.</p> <p>You can also go to the Academic Progress Tracker, APT Items page(Records and Enrollment > Program Enrollment > Academic Progress Tracker) to view the log. On the APT Items page of the destination APT instance, look in the Academic Item Attempt Schedule grid.</p>

Source APT

Field or Control	Description
Use for Transfer	Select to indicate which record to use as the source of data.

Synchronizing the Academic Progress Tracker

You can synchronize enrollment and transfer credit transactions to a student's Academic Progress Tracker (APT). The details of enrollment and transfer credit are carried over to APT when the term and course matches an AIR/APT Course Item or when a valid course equivalency has been identified. Dropped courses and unposted transfer credits are also synchronized to APT.

Pages Used to Synchronize the Academic Progress Tracker

<i>Page Name</i>	<i>Definition Name</i>	<i>Navigation</i>	<i>Usage</i>
APT Sync Result Type/Scale	SSR_APT_SYN_RSLT	Records and Enrollment > Program Enrollment > APT Sync > APT Sync Result/Type Scale	Prioritize and include the valid Result Types and Result Scales to sync grades to APT.
APT Sync Process	SSR_APT_SYN_RUNCNT	Records and Enrollment > Program Enrollment > APT Sync > APT Sync Process	Synchronize the enrollment and transfer credit transactions to students APT.
APT Sync Request	SSR_APT_SYNC_REQ	Records and Enrollment > Program Enrollment > APT Sync > APT Sync Request	Review the results of the APT Sync Requests.
Student's Tracker	SSR_APT_SYN_TRK	Records and Enrollment > Program Enrollment > APT Sync > Student's Tracker	Review and delete as needed APT Sync Student Tracker logs.
APT Sync Maintenance	SSR_APT_SYN_MAINT	Records and Enrollment > Program Enrollment > APT Sync > APT Sync Maintenance	Delete APT Sync logs and requests for the term range provided.

APT Sync Result Type/Scale Page

Use the APT Sync Result Type/Scale page (SSR_APT_SYN_RSLT) to prioritize and include the valid Result Types and Result Scales to sync grades to APT.

Navigation:

Records and Enrollment > Program Enrollment > APT Sync > APT Sync Result Type/Scale

This example illustrates the fields and controls on the APT Sync Result Type/Scale page.

APT Sync Result Type/Scale

This setup is for determining which Result Type and Scale to use when syncing Grades

Refresh from Result Type Setup

Find | View All
First ◀ 1 of 5 ▶ Last

Result Type AM RESULT Primary Result

Priority Order Include

Associated Academic Institutions				
Institution	Result Scale	Default	Priority Order	Include
PeopleSoft University Spain	Standard 10 Pt Scale	<input checked="" type="checkbox"/>	<input type="text" value="1"/>	<input checked="" type="checkbox"/>
PeopleSoft University Spain	Pass or Fail scale	<input type="checkbox"/>	<input type="text" value="999"/>	<input checked="" type="checkbox"/>
PeopleSoft University	100 Point Scale - Undergraduate	<input checked="" type="checkbox"/>	<input type="text" value="1"/>	<input checked="" type="checkbox"/>
PeopleSoft University	10 Point Scale	<input type="checkbox"/>	<input type="text" value="999"/>	<input checked="" type="checkbox"/>
PeopleSoft University	50 Point Scale	<input type="checkbox"/>	<input type="text" value="999"/>	<input checked="" type="checkbox"/>
PeopleSoft University	Extra Credit Scale	<input type="checkbox"/>	<input type="text" value="999"/>	<input checked="" type="checkbox"/>
PeopleSoft University	Pass or Fail Outcome	<input type="checkbox"/>	<input type="text" value="999"/>	<input checked="" type="checkbox"/>
PeopleSoft University	Pass Fail	<input type="checkbox"/>	<input type="text" value="999"/>	<input checked="" type="checkbox"/>
PeopleSoft University	100 Point Scale - Graduate Regular	<input type="checkbox"/>	<input type="text" value="999"/>	<input checked="" type="checkbox"/>

Field or Control	Description
Refresh from Result Type Setup	<p>Click this button to retrieve the result types that are set up on the Result Type page. See Setting Up Result Types.</p> <hr/> <p>Note: The Result Types from the Result Type page with a Result Value Field Type of <i>Result Scale</i> and an Item Type Usage of <i>Course</i> are retrieved here.</p>
Priority Order	Enter the order in which the Result Type is chosen to sync grades in APT Sync process. You must define the values before running the APT Sync Process.
Include	Select this check box to include the Result Type in APT Sync process. This check box is selected by default.

Associated Academic Institutions

Field or Control	Description
Default	Displays the default Result Scales as defined in Result Type Setup. See Setting Up Result Types .
Priority Order	<p>Determines the order in which the Result Scale is chosen to sync grades in APT Sync process within the Result Type.</p> <p>Users must define the values before running the APT Sync Process.</p>

Field or Control	Description
Include	Select this check box to include the Result Scale in APT Sync process. This check box is selected by default.

APT Sync Process Page

Use the APT Sync Process page (SSR_APT_SYN_RUNCNT) to synchronize the enrollment and transfer credit transactions to students APT.

Navigation:

Records and Enrollment > Program Enrollment > APT Sync > APT Sync Process

This example illustrates the fields and controls on the APT Sync Process page.

APT Sync Process

Run Control ID: PS Report Manager Process Monitor Run

Most Recent Process

Refresh Process Info

Process Instance	Run Status	Request Date/Time
Request Number		Go To APT Sync Request

Sync Options

Create APT Items if not available

Action when no longer in Enrollment

As Defined in Enrol Category

Set to Dropped Status

Set to Planned status

Action when no longer in Transfer Credit: APT item will be deleted for non-mandatory, otherwise it will be set to planned status

Remove APT Sync generated substitute item on Dropped Courses or Unposted Transfer Credit

Always

Only on Dropped Delete Courses and Deleted Transfer Credit

Use Course Equivalency

APT Sync Result Type/Scale to use for Syncing Grades/Results

Population Selection

Population Selection

Selection Tool

Query Name

Manual Selection by Student Detail

Use Manual Select

Most Recent Process

<i>Field or Control</i>	<i>Description</i>
Refresh Process Info	Click this button to retrieve the most recent process information for the Run Control ID.
Go To APT Sync Request (go to academic progress tracker sync request)	Click this to open the APT Sync Request page which displays the most recent process request information.

Sync Options

<i>Field or Control</i>	<i>Description</i>
Create APT Items if not available (create academic progress tracker items if not available)	Select this option to generate an APT Item sequence when an enrollment or posted transfer credit course matches AIR course and the planning node for the term has been created but there is no APT Item sequence yet.
Action when no longer in enrollment	<p>Select the option you want to use if an enrolled course is drop deleted:</p> <ul style="list-style-type: none"> • As defined in Enrol category: If the Enrollment Category assigned to the Course Item allows Add/Remove from APT, the enrollment is removed. If it is not allowed, the Course Item is set to <i>Dropped</i> status. • Set to Dropped Status: Course Item is set to <i>Dropped</i> status. • Set to Planned Status: Course Item link is deleted and set to <i>Planned</i> status. <hr/> <p>Note: Action When No Longer in Transfer Credit APT Items are deleted for non-mandatory Courses. Mandatory Courses are set to <i>Planned</i> status. The process deletes an APT Item if there is only one attempt. If an APT Item has multiple attempts, only the attempt that matches the Term is deleted.</p> <hr/>

Field or Control	Description
Remove APT Sync generated substitute item on Dropped Courses or Unposted Transfer Credit	<p>Select when you want the process to delete a substitute item that was created through APT Sync:</p> <ul style="list-style-type: none"> • Always: Remove item regardless if it is dropped only or drop deleted or unposted or deleted transfer credit. • Only on Dropped Delete Courses and Deleted Transfer Credit: Remove item only for dropped delete enrollment and deleted transfer credit. <hr/> <p>Note: Substitute Items created manually in the APT page can't be deleted using this option. The substitution remains, and the status is set to <i>Planned</i>.</p>
Use Course Equivalency	<p>Select to match by Course Equivalency and generate substitution if the enrolled or transfer credit course does not find the match in AIR/APT.</p> <hr/> <p>Note: If the equivalent AIR course belongs to a course group, substitution isn't allowed.</p>
APT Sync Result Type/Scale to use for Syncing Grades/ Results (academic progress trackers sync result type/scale to use for syncing grades/results)	<p>Click this link to open the APT Sync Result Type/Scale Setup page.</p>

Population Selection

There are 5 delivered queries for this feature:

- APT Sync by Course (SSR_APT_SYNC_BY _COURSE)
- APT Sync by Program (SSR_APT_SYNC_BY _PROGRAM)
- APT Sync by Student (SSR_APT_SYNC_BY _STUDENT)
- APT Sync by Term (SSR_APT_SYNC_BY _TERM)
- APT Sync by Term Sessions Course (SSR_APT_SYNC_BY _TERM_SESSION)

Field or Control	Description
Include Multiple APT (include multiple academic progress trackers)	Select to enable picking courses from multiple APT instances.

<i>Field or Control</i>	<i>Description</i>
Include Previously Unmatched	Select to attempt to sync students that were previously unmatched.

Manual Selection by Student Detail

<i>Field or Control</i>	<i>Description</i>
Use Manual Select	<p>Select this check box to manually select students for APT Sync.</p> <hr/> <p>Note: When using manual selection, the data automatically populates. For example, if you select a student who only has one enrollment to sync, you only have to select the Student ID and the other fields are automatically populated. If the student has two courses to sync, the only other prompt you have to provide will be which course you want to sync.</p> <hr/>

APT Sync Request Page

Use the APT Sync Request page (SSR_APT_SYNC_REQ) to review the results of the APT Sync Request process.

Navigation:

Records and Enrollment > Program Enrollment > APT Sync > APT Sync Request

This is a display-only page of results of the APT Sync Process.

Student's APT Sync Tracker Page

Use the Student's APT Sync Tracker page (SSR_APT_SYN_TRK) to review the results of the APT Sync Request process for an individual student and delete the result in order to re-sync the APT.

Navigation:

Records and Enrollment > Program Enrollment > APT Sync > Student's Tracker

Every APT Sync processed transaction generates a tracker log. The main purpose of the tracker is to prevent an enrollment or transfer credit transaction to continue to try matching AIR/APT. Once the APT Sync process has run, the enrollment or transfer credit will not sync again unless the status has changed. For example an enrollment has been synced, but the course was dropped after. The sync process identifies that change and generates a drop or drop delete sync transaction.

The Student's APT Sync Tracker page allows you to delete the row in case you have done some adjustments in AIR/APT and want the re-run the APT Sync Process. The page displays data relevant APT sync data and a Delete button.

APT Sync Maintenance Page

Use the APT Sync Maintenance page (SSR_APT_SYN_MAINT) to delete APT Sync Request transactions for ranges of terms.

Navigation:

Records and Enrollment > Program Enrollment > APT Sync > APT Sync Maintenance

This maintenance page allows you to delete Sync Request Transactions and/or Student's Tracker logs. Oracle suggests that you run this process on terms that have passed and for which you no longer need to reference the Sync Requests and Tracker Logs.

<i>Field or Control</i>	<i>Description</i>
From Term	Enter the first term for which you want to delete APT Sync Requests and Tracker Logs.
To Term	Enter the last term for which you want to delete APT Sync Requests and Tracker Logs.
Delete Sync Requests	Select to delete APT Sync Requests.
Delete Student's Tracker Logs	Select to delete APT Sync Students' Tracker Logs.

Managing Research Tracking

Managing Research Candidates

Research candidate records can be created through the following methods:

- Entry of an admissions application to a research eligible program or plan.
- Updating an existing admissions application to a research eligible program or plan.
- Using the Quick Admit process to a research eligible program or plan.
- Using the Student Program/Plan component to assign a research eligible program or plan.

Note: Research candidate information can be accessed through the Candidate Management component only after a candidate has been matriculated. Prior to matriculation, candidate information is accessed through the Admissions Application Entry and Application Maintenance components.

This section provides an overview of consumption and discusses how to:

- Review candidate information.
- Track research topics.
- Search for research topics.
- Assign candidate supervisors.
- Search for supervisors.
- Track consumption and submission.
- Track additional candidate assignments.
- Create assignments for multiple students.
- Update candidate management data using Admissions components.

Pages Used to Manage Research Candidates

<i>Page Name</i>	<i>Definition Name</i>	<i>Navigation</i>	<i>Usage</i>
Candidate Management – Information	SSR_RS_CAND_HDR	Records and Enrollment > Graduate Research Management > Candidate Management > Information	View summary information about candidates.

Page Name	Definition Name	Navigation	Usage
Candidate Management – Research Topic	SSR_RS_TOPIC	Records and Enrollment > Graduate Research Management > Candidate Management > Research Topic	View and edit information about a candidate’s research topic.
Topic Search	SSR_RS_TPCSRCH_SEC	Click the Topic Search button on the Candidate Management - Research Topic page.	Search for available research topics.
Candidate Management – Supervisors	SSR_RS_SUPERVISORS	Records and Enrollment > Graduate Research Management > Candidate Management > Supervisors	Assign supervisors and edit supervisor information for the candidate’s research project.
Supervisor Search	SSR_RS_SUPSRCH_SEC	Click the Supervisor Search button on the Candidate Management – Supervisors page.	Search for and select supervisors for the candidate's research project.
Consumption and Submission	SSR_RS_CONSMPTN	Records and Enrollment > Graduate Research Management > Candidate Management > Consumption and Submission	Assign and edit the candidate's thesis submission dates and research load.
Other Assignments	SSR_RS_OTHER_REQ	Records and Enrollment > Graduate Research Management > Candidate Management > Other Assignments	Add any new requirements that must be tracked on the Candidate Management component.
Create Assignments	SSR_RS_BAT_ASSIGN	Records and Enrollments > Graduate Research Management > Create Assignments	Create multiple new assignments for multiple students.
Candidature Details	SSR_RS_CNDDTRE_ADM	Student Admissions > Application Entry > Add Application > Candidature Details Student Admissions > Application Maintenance > Maintain Applications > Application Data	Access and update candidate management data using Admissions components.

Reviewing Candidate Information

Access the Candidate Management - Information page (**Records and Enrollment > Graduate Research Management > Candidate Management > Information**).

This example illustrates the fields and controls on the Candidate Management - Information page. You can find definitions for the fields and controls later on this page.

The screenshot displays the 'Candidate Management - Information' page for Christina Jones (SRR80011). The page has tabs for Information, Research Topic, Supervisors, Consumption and Submission, and Other Assignments. The candidate's name and ID are at the top. Below are fields for Academic Institution (PeopleSoft University), Academic Career (Medical School), Academic Program (Medical Research Lab), Program Status (Active in Program), Candidate Number (00000000022), Student Career Nbr (0), Academic Plan (Lab Research Site 1), and Days Remaining (1173.00). A 'Candidate Information' section contains Start Date (08/30/2013), Early Submission Date (08/14/2016), Load (FULL Full Time), Final Submission Date (12/12/2016), and Status Date (08/09/2013). A 'Milestones' table has one row with Milestone 1. At the bottom, there is a 'Transfer To' dropdown menu and a 'Go' button.

This page provides basic high-level information about the candidate. All the fields on this page are display-only; to update the page, use the Consumption and Submission page.

See [Tracking Consumption and Submission](#)

Field or Control	Description
	For information about the Send Notification button, See Using Online Notifications
Program Status	The status from the Student Program/Plan component. See Maintaining Student Program Stacks
Candidate Information	This section contains the current high-level consumption information, taken from the Consumption and Submission page.
Milestones	This section contains a list of the uncompleted milestone events for the candidate.
Transfer To	You can access common Research-related components by selecting them from the drop-down list and clicking the Go button.

Tracking Research Topics

Access the Candidate Management - Research Topic page (**Records and Enrollment > Graduate Research Management > Candidate Management > Research Topic**).

This example illustrates the fields and controls on the Candidate Management - Research Topic page. You can find definitions for the fields and controls later on this page.

The screenshot displays the 'Candidate Management - Research Topic' page. At the top, there are navigation tabs: Information, Research Topic (selected), Supervisors, Consumption and Submission, and Other Assignments. Below the tabs, personal and academic information is shown for Daphne Ferrer, including her academic institution (PeopleSoft University), career (Medical School), program (Medicine), and plan (Animal Testing Research 1). The 'Research Topic' section is the main focus, showing a sequence of 1 and a topic search bar. The 'Topic Details' section includes fields for 'Effective Date' (09/17/2013), 'Effective Status' (Active), and 'Topic Code' (RT0002). The 'Research Topic' field contains the text 'New Surgical Techniques for Left handers'. Below this are two 'Topic Description' fields, each containing the same text. The 'Thesis Title' field also contains the same text. Each text field is accompanied by a rich text editor toolbar with options for font, size, bold, italic, underline, and list creation.

This example illustrates the fields and controls on the Candidate Management - Research Topic page 2 of 2. You can find definitions for the fields and controls later on this page.

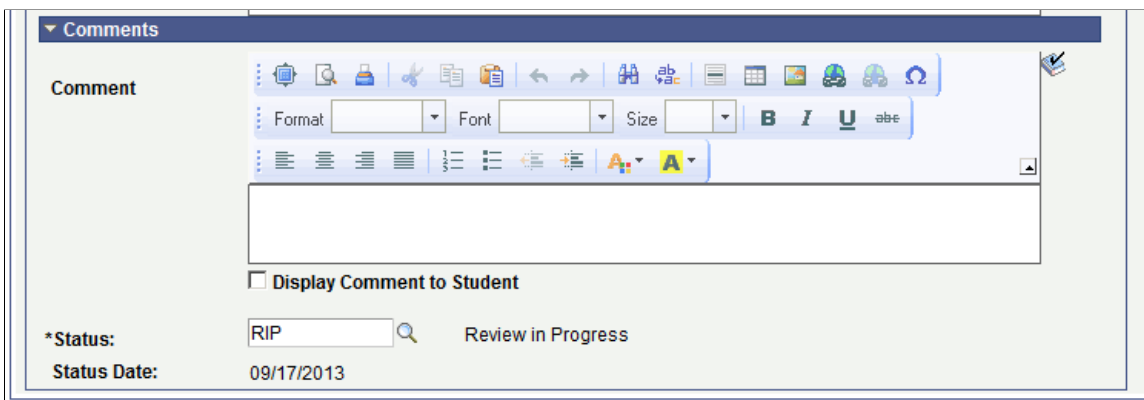

Use the Research Topic page to track the status of a research topic. Initial entry of the research topic is accomplished in one of two ways:

- Select a predefined research topic.
- Create a new research topic proposal.

The page supports the entry of multiple research topics, but only one should be active after the candidate is matriculated. The thesis title is displayed in the Thesis Management component.

Research Topic

This scroll area is used to insert and delete research topics. Use the Add or Delete buttons to perform these actions.

Field or Control	Description
Sequence	<p>Each number corresponds to a different research topic. Use the Add button at the Research Topic level to insert additional research topic records.</p> <p>The Sequence number is incremented for each research topic added. Note that the 3Cs buttons are placed at this level so that communications created from this page are for a specific research topic. The Administrative function of TOPC supports this.</p>

Field or Control	Description
Attachments	<p>Click this link to view or add attachments specific to the individual research topic. The number in parentheses indicates the number of attachments currently stored for the research topic.</p> <p>In the File Attachments grid, the Visible to Student check box allows you to set whether or not the attachment is visible to students in the Candidate Center self service pages. By default, this check box is:</p> <ul style="list-style-type: none"> • Deselected in administrator pages so attachments are not visible to students. • Selected in Candidate Center self-service pages when candidates add attachments.
Create Topic	<p>Click this button to open the fields on the page for update to allow the creation of a new topic. This bypasses the Topic Search functionality because a new research topic is being created instead of searching and selecting predefined research topics.</p>
Topic Search	<p>Click this button to display a search page to search for previously defined research topics.</p>
Additional Information	<p>This link appears only if common attributes have been created for the candidate’s research topic using the Common Attribute Framework. Click the link to accesses a Common Attributes subpage where you can enter or modify the additional information.</p> <hr/> <p>Note: The fields that can be entered on this subpage are different from the fields that can be entered on the Research Topic Setup – Additional Information page.</p> <hr/> <p>See:</p> <ul style="list-style-type: none"> • “Understanding Common Attribute Framework” (Campus Community Fundamentals) • “Defining a Common Attribute” (Campus Community Fundamentals) • “Associating a Common Attribute to a Record” (Campus Community Fundamentals)

Comments

This field is intended for administrators to add contextual notes to the current row of data. When a new effective data row is entered, the field is reset to blank. When the user scrolls through the row of the record, the comment scroll area automatically opens so that the comment is not missed. In addition, candidates will have the ability to enter comments through the Candidate Center by initiating a Research Service Item.

<i>Field or Control</i>	<i>Description</i>
Display Comment to Student	<p>Select to allow candidates to view the comment in the Candidate Center. By default, this check box is:</p> <ul style="list-style-type: none"> • Deselected in administrator pages. Select this option if you would like to share the comment with the candidate. • Selected in the Candidate Center self-service pages when candidates add comments.

Searching for Research Topics

Access the Research Topic Search page (click the **Topic Search** button on the Candidate Management - Research Topic page).

This example illustrates the fields and controls on the Research Topic Search page. You can find definitions for the fields and controls later on this page.

Topic Search

Academic Program: MED Academic Plan: MEDRS3 Academic Sub-Plan: Category:

Topic	Topic Categories	Academic Program	Academic Plan	Academic Sub-Plan	Categories Names	Description
<input type="radio"/> General Veterinary Surgical Research		MED	MEDRS3			Description

Use this page to search for available research topics for the candidate. By default, the candidate's academic program and plan will automatically be used to search for available research topics, but you can modify the filtering criteria, specifying Academic Program, Academic Plan, Academic Sub-Plan, and Category, and then use the Search button to locate additional available topics. Select a topic from the results grid to select the topic and display its details in the Research Topic page.

You should only select research topics where both the Academic Program and Academic Plan of the topic match the candidate's values. A warning message is displayed if the topic selected does not match the candidate's Academic Program and Academic Plan. You can click the Cancel button to return to the main page without making a selection.

Assigning Candidate Supervisors

Access the Candidate Management - Supervisors page (**Records and Enrollment > Graduate Research Management > Candidate Management > Supervisors**).

This example illustrates the fields and controls on the Candidate Management - Supervisors page. You can find definitions for the fields and controls later on this page.

The screenshot displays the 'Supervisors' page for candidate Maya Morris. At the top, there are tabs for 'Information', 'Research Topic', 'Supervisors', 'Consumption and Submission', and 'Other Assignments'. The 'Supervisors' tab is active, showing a list with one entry (Sequence: 1). Below this is the 'Supervisor Details' section for the selected supervisor (FA0802, Kabahit, Joel). Fields include:

- *Effective Date: 03/03/2014
- *Effective Sequence: 1
- *Effective Status: Active
- Start Date: 03/04/2014
- End Date: 09/03/2014
- Supervision Percentage: 100.00
- Supervisor Role: RSUP (Research Supervisor)
- Funding Percentage: (empty)
- Affiliation Code: PROF_TMPL
- Budget Department: (empty)
- Primary Supervisor: (checked)
- Academic Organization: ENDOCRIN (Endocrinology)
- Advisory Committee: (empty)

 A 'Comments' section is visible with a rich text editor and a 'Display Comment to Student' checkbox. At the bottom, there is a 'Transfer To:' dropdown and a 'Go' button.

Use this page to assign supervisors to the candidate. Multiple supervisors are supported.

Supervisors

Use this scroll area to insert and delete supervisor positions, using the Add and Delete buttons. The Sequence number increments for each supervisor position added. Note that the 3Cs buttons are placed at this level so that communications created from this page will be for a specific supervisor. The Administrative function of SUPR supports this.

Field or Control	Description
Attachments	<p>Click this link to view and add attachments to the selected supervisor sequence. The number in parentheses indicates the number of attachments currently stored for the supervisor.</p> <p>In the File Attachments grid, the Visible to Student check box allows you to set whether or not the attachment is visible to students on the Candidate Center self-service pages. By default, this check box is:</p> <ul style="list-style-type: none"> • Deselected in administrator pages so attachments are not visible to students. • Selected in Candidate Center self-service pages when candidates add attachments.

Supervisor Details

This scroll area maintains additional, candidate-specific information about the supervisor. In addition, schools can use this section to track the selection and approval of the supervisors. A supervisor position can be created without an actual person assigned until a later date. Research supervisors are defined in the Administrator Profile component.

Field or Control	Description
Supervisor Search	<p>Click this button to display the Supervisor Search page, where you can search for and select valid supervisors to include on the Supervisors page. A valid supervisor is one whose Academic Program or Academic Plan matches that of the candidate. Define supervisors using the Affiliations feature, the Academic Institution 10 page, and the Administrator Profile Management page.</p> <p>See Setting Up Research Administrators.</p>
Status	<p>The status values are defined in the Research Status Code setup component. The available research status codes are those defined with the System Usage value equal to <i>Supervisor</i>. Schools will likely create status codes to track the approval of the research supervisors as well as track the availability of the supervisor over time. This is a required field.</p> <hr/> <p>Note: This field has underlying PeopleCode that supports 3C Engine triggers that occur in real time or store in a trigger table for processing later. Essentially, communications can be triggered automatically based on assigning a specific status value.</p> <hr/>

Field or Control	Description
Additional Information	<p>This link appears only if common attributes have been created for the candidate’s research topic using the Common Attribute Framework. Click the link to access a Common Attributes subpage where you can enter or modify the additional information.</p> <p>See:</p> <ul style="list-style-type: none"> • Using Common Attribute Framework for Research Tracking • “Defining a Common Attribute” (Campus Community Fundamentals)

Comments

This field is intended for administrators to add contextual notes to the current row of data. When a new effective data row is entered, the field is reset to blank. When the user scrolls through the row of the record, the comment scroll area automatically opens so that the comment is not missed. In addition, candidates will have the ability to enter comments through the Candidate Center by initiating a Research Service Item.

Field or Control	Description
Display Comment to Student	<p>Select to allow candidates to view the comment in the Candidate Center. By default, this check box is:</p> <ul style="list-style-type: none"> • Deselected in administrator pages. Select this option if you would like to share the comment with the candidate. • Selected in the Candidate Center self-service pages when candidates add comments.

Related Links

“Defining 3C Engine Triggers” (Campus Community Fundamentals)

Searching for Supervisors

Access the Supervisor Search page (click the **Supervisor Search** button on the Supervisors page).

This example illustrates the fields and controls on the Supervisor Search page . You can find definitions for the fields and controls later on this page.

Selected	Empl ID	Display Name	Affiliation Code	Academic Program	Academic Plan	Academic Sub-Plan
<input type="checkbox"/>	AD1010	Kim Fletcher	ASSTPROF_I	MEDRF	MEDRF1	
<input type="checkbox"/>	SR0493	Kate McCarty	LECTURER	MEDRF	MEDRF1	

Use this page to search on Academic Program, Academic Plan, and Academic Sub-Plan in order to locate specific supervisors. Eligible research supervisors are defined in the Administrator Profile component. Select a topic from the results grid to display its details in the Supervisors page.

You can select only supervisors for whom either the Academic Program or Academic Plan relevant to the supervisor matches that of the candidate. Other supervisors in the search results are display-only.

Use the Cancel button to return to the main page without making a selection.

For information about the Administrator Profile component, see [Setting Up Research Administrators](#).

Tracking Consumption and Submission

This section discusses consumption and how to use the Consumption and Submission page.

Understanding Consumption

A challenge in monitoring research candidates is that they often do not follow an academic calendar while conducting their research. Research candidates are usually allocated a set amount of time to complete their research and submit their thesis for evaluation, so a method called Consumption is used to determine when the candidate has reached the limit of his or her allocated time.

This method is optional for schools to implement and does not replace the current methods for monitoring academic progress. As consumption is monitored, schools must determine the administrative action to be taken as the time allocated to a research candidate runs down.

The consumption process takes the amount of time allocated by the department to complete the research project, the rate at which research work is conducted (load), and the candidate's start date to determine the date at which the candidate's time runs down to zero. This is known as the final submission date. A current measure of the candidate's remaining time is maintained. Administrators can monitor this time remaining and initiate actions necessary to insure that the candidate is making progress.

Here is an example of a consumption calculation:

A research project is determined to require 90 days to complete at a full time rate. An applicant has accepted the research project set to begin on January 1, 2013, but will be conducted at a load of half time (.50). The consumption calculation would adjust the 90 full time days to reflect its consumption at a half time rate (90 days/50) and calculate 180 days to consume the allocated time. A final thesis submission date of June 30, 2013 is calculated.

The candidate begins his or her research as planned. On February 2 (32 days later), the consumption calculation would determine that the candidate has consumed 16 days (equals 32 calendar days x .5 consumption load) and has 74 days remaining (90 total allocated – 16 consumed).

Administrators can override the consumption settings for individual research candidates. For example, an adjustment to the start date may be required due to the nature of the research project or additional time may need to be added due to the availability of research topic. Adjustments made to a candidate’s start date, total allocated days, and load result in a recalculation of the submission dates.

Note: If the consumption feature is not implemented for some or all of an institution’s research candidates, schools still have the option of manually managing the load, begin date, and submission date fields for their research candidates. These fields may still be useful in monitoring the progress of their candidates.

Here is an example of the Consumption and Submission page if the consumption feature is not used (Consumption Model is None):

The screenshot shows a web interface for a research candidate named Laurence Fournier (ID 0067). The 'Consumption and Submission' tab is selected. Key fields include:

- Academic Institution:** French University
- Academic Career:** Research
- Academic Program:** Doctorate in English
- Candidate Number:** 000000000015
- Student Career Nbr:** 0
- Academic Plan:** English Literature

 The 'Consumption' section shows:

- *Effective Date:** 01/18/2013
- *Eff Seq:** 1
- *Effective Status:** Active
- Consumption Model:** None (selected), Days
- Ovrld Load:** [Empty field]
- Begin Date:** 09/14/2009
- Early Submission Date:** [Empty field]
- Final Submission Date:** [Empty field]

 At the bottom, there is a 'Comments' section with a rich text editor and a checkbox for 'Display Comment to Student'. The status is shown as [Empty field] and the status date is 01/18/2013.

Suspending, Resuming, and Resetting Consumption

In addition to being able to make adjustments to the consumption calculation to more accurately reflect an individual research candidate’s circumstances, administrators also have the ability to suspend (and later resume) or even reset the process. An example where suspension of the calculation may be applied is when the candidate takes a leave of absence from the university. The administrator must determine if suspension is required. For example, the candidate’s research topic suddenly becomes unavailable for study. If consumption is suspended, any further calculations are halted. The days remaining, days consumed, and the submission dates become locked while the suspension is in place. When the candidate returns from leave, consumption would then be resumed. When consumption is resumed, the time period

of the suspension is ignored (not counted as consumed), and the submission dates are recalculated based on the resumption date.

The option to reset the consumption calculator can be used in the case where a candidate has already started his or her research project, but at some point the administrator wants to restart the consumption process, but preserve the previous consumption information. The old information is preserved for audit purposes, but the information is not used once the reset has been implemented. For example, a research candidate has been working on an approved research topic. For some reason, the research topic can no longer be studied and the candidate must change to another research area. The administrator could choose to perform a reset instead of other options such as making adjustments to the current consumption data (adding more days, changing the research load), or requiring the candidate to reapply for admissions under the new topic.

Program Stack Changes and Consumption

Similar to all students in the Campus Solutions system, the academic status of the research candidate is maintained in the program stack. Changes in the candidate's program status may have a downstream impact on how consumption should behave. Using the leave of absence example earlier: to grant the leave of absence, the status must first be entered in the Student Program/Plan component to update the program stack. Next, the consumption status in the Candidate Management component would need to be updated. To assist in coordinating program status and consumption status changes, an optional feature to automatically update the candidate's consumption information based on changes made to the program stack is available. A specific program action and action reason combination entered in the Student Program/Plan component can be made to trigger the insertion of a new consumption row for research candidates who have consumption enabled. Administrators can cause the consumption process to suspend, resume previously suspended consumption, or simply insert a new informational row to document that a change in the program stack had occurred. The new consumption row uses the same effective date as the new program action row.

An example of the sequence of events that may take place to process a leave of absence:

1. A candidate applies for a leave of absence by submitting a service request.
2. The request is administered in the Service Request Management component.
3. If the leave of absence is approved, a new row is saved in Student Program/Plan using a Program Action of LOA and an Action Reason of SUSP (suspend consumption).
4. A row is then automatically inserted in the Consumption record in the Candidate Management component. How the fields on the Consumption and Submission page are updated depends on the setup on the Program Action Process Setup page. For example, if the setup indicates that when the Program Action in Student Program/Plan is *LOA* and the Action Reason is *SUSP*, then the Consumption Action should be *Suspend* and the Status (consumption status) should be *LOA*—the Consumption Indicator and Status fields on the Consumption and Submission page are updated accordingly.
5. Consumption is calculated up to the date that the leave of absence takes effect.

See:

- [Setting Up Consumption Actions for Program Actions](#)
- [Managing Service Requests](#)

- [Maintaining Student Program Stacks](#)

Using the Consumption and Submission Page

Access the Consumption and Submission page (**Records and Enrollment > Graduate Research Management > Candidate Management > Consumption and Submission**).

This example illustrates the fields and controls on the Consumption and Submission page. You can find definitions for the fields and controls later on this page.

The screenshot displays the 'Consumption and Submission' page for candidate SRRS0039. The page is divided into several sections:

- Information:** Border Marks: SRRS0039
- Academic Information:**
 - Academic Institution: PeopleSoft University
 - Academic Career: Medical School
 - Academic Program: Medical Research Lab
 - Candidate Number: 000000000031
 - Student Career Nbr: 0
 - Academic Plan: Lab Research Site 1
 - Days Remaining: 1200.00
- Attachments (3):** (Link)
- Consumption Section:**
 - *Effective Date: 02/01/2014
 - *Eff Seq: 1
 - *Effective Status: Active
 - Consumption Model: None (selected), Days
 - Overrd Load: FULL (selected), Full Time
 - Consumption Indicator: (Dropdown)
 - Consumption Rate: 1.00
 - Begin Date: 08/30/2014
 - Calculated Values: Total Days: 1200.00, Days Remaining: 1200.00, Days Consumed: 0.00
 - Early Submission Date: 08/14/2017
 - Final Submission Date: 12/12/2017
 - Early Submission %: 90
 - Recalculate button
- Comments Section:**
 - Comment: Student will be enrolled full time.
 - Display Comment to Student:
 - *Status: P (Pending Finalization)
 - Status Date: 02/01/2014
- Transfer To:** (Dropdown menu) and Go button

The Consumption and Submission page can be accessed only after a research candidate is matriculated into the program. Prior to matriculation, you can view and update consumption and submission data on the Candidature Management page in Admissions.

See [Updating Candidate Management Data Using Admissions Components](#).

Field or Control	Description
Consumption Model	Indicates whether consumption calculations will be performed. Available fields change based on the model selected. After research has begun, the field cannot be changed. If the model is None, the page limits the display to the Load, Status, and Submission Date fields.
Load	The consumption load of the candidate. If the load is changed, the submission dates are recalculated to reflect the change. A recalculation is performed either by pressing the recalculate button, or by a successful save of the page.
Begin Date	The date that the research program begins. After the research begins, you cannot override the date. If you need to override the date, delete all the consumption rows dated after the begin date, or use the consumption reset functionality.
Total Days	The time allocated to the candidate to complete his or her research. If modified, the submission dates are recalculated.
Days Remaining	Display-only field that shows the time remaining as of the effective date of the record. This value is calculated by subtracting the Days Consumed from the Total Days.
Days Consumed	<p>Display-only field reflecting the amount consumed as of the effective date.</p> <hr/> <p>Note: The Days Remaining field located at level zero on the page always displays the amount consumed as of the current date. The value is not adjusted to reflect calendar days.</p> <hr/>
Early Submission Date	A calculated date based on the default consumption settings used for the candidate.
Final Submission Date	The calculated date when the Days Remaining becomes zero.

Field or Control	Description
Status	<p>Select a status from the available list. The status values are defined in the Research Status Code setup component. The available research status codes are those defined with the System Usage value equal to Consumption. This is a required field.</p> <p>This field can be automatically updated when a row is saved in the Student Program/Plan, as explained in the “Understanding Consumption” section.</p>
Consumption Indicator	<p>Indicates whether the consumption calculation is suspended, resumed, or reset, as explained in the “Understanding Consumption” section.</p>
Ovrd (override)	<p>The column labeled Ovrd indicates whether the corresponding field (Begin Date, Total Days, Early Submission Date, Final Submission Date) has been overridden by the user.</p> <p>The Ovrd check box is automatically selected when the user changes the default values derived from setup (begin date, total days) or from the initial consumption calculation (dates). The check boxes are deselected if the original value is restored.</p>
Calculated Values: Total Days	<p>Displays the default value derived from setup. When the actual Total Days field is modified, the Ovrd check box is selected when the two value do not equal.</p>
Calculated Values: Days Remaining	<p>This is the actual Days Remaining value adjusted to reflect the number of calendar days (divide the actual days remaining by the Consumption Rate).</p>
Calculated Values: Early Submission Date	<p>Calculated from the current consumption settings displayed on the page. The Ovrd check box is selected when the actual Early Submission Date does not match.</p>
Calculated Values: Final Submission Date	<p>Calculated from the current consumption settings displayed on the page. The Ovrd check box is selected when the actual Final Submission Date does not match.</p>

<i>Field or Control</i>	<i>Description</i>
Recalculate	When you click this button, a recalculation of consumption for the current row occurs. By default, the button is not available unless a new row is inserted or a field that impacts the consumption calculation in the current row is modified. Note that when the consumption record is saved, a recalculation is always performed.

Comments

This field is intended for administrators to add contextual notes to the current row of data. When a new effective data row is entered, the field is reset to blank. When the user scrolls through the row of the record, the comment scroll area automatically opens so that the comment is not missed. In addition, candidates will have the ability to enter comments through the Candidate Center by initiating a Research Service Item.

<i>Field or Control</i>	<i>Description</i>
Display Comment to Student	<p>Select to allow candidates to view the comment in the Candidate Center. By default, this check box is:</p> <ul style="list-style-type: none"> • Deselected in administrator pages. Select this option if you would like to share the comment with the candidate. • Selected in the Candidate Center self-service pages when candidates add comments.

Tracking Additional Candidate Assignments

Access the Other Assignments page (**Records and Enrollment > Graduate Research Management > Candidate Management > Other Assignments**).

This example illustrates the fields and controls on the Other Assignments page. You can find definitions for the fields and controls later on this page.

Use this page to add new assignments to be tracked on the Candidate Management component.

For information about how to create assignments for multiple students, see [Creating Assignments for Multiple Students](#).

For information about how to set up assignments, see [Defining Additional Business Assignments](#).

The setup determines the fields that are displayed for the assignment. Multiple assignments are supported.

Assignment

Use this area of the page to add and delete assignments. Note that the 3Cs buttons are placed at this level so that communications created from this page will be for a specific assignment. The Administrative function of RREQ supports this.

Field or Control	Description
Assignment	Assignments are defined in the Assignment Types component.

Field or Control	Description
Attachments	<p>Click this link to view and add attachments to the selected assignment. The number in parentheses indicates the number of attachments currently stored for the supervisor.</p> <p>In the File Attachments grid, the Visible to Student check box allows you to set whether or not the attachment is visible to students on the Candidate Center self-service page. By default, this check box is:</p> <ul style="list-style-type: none"> • Deselected in administrator pages so attachments are not visible to students. • Selected in Candidate Center self-service pages when candidates add attachments.

Detail

At this level, the fields that appear are controlled by the Assignment definition performed in setup. The possible fields that may appear are:

Field or Control	Description
Completion Date	The expected or actual completion date of the assignment.
Approver ID	The person who approves the assignment.
Committee ID	The committee that approves the assignment.
Approval Date	The date of the approval.
Comments	<p>A rich text format field for free-form comments.</p> <p>This field is intended for administrators to add contextual notes to the current row of data. When a new effective-dated row is entered, this field is reset to blank. When the user scrolls through the row of the record, the comment scroll area automatically opens so that the comment is not missed.</p> <p>In addition, candidates will have the ability to enter comments through the Candidate Center by initiating a Research Service Item.</p>

Field or Control	Description
Display Comment to Student	<p>Select to allow candidates to view the comment in the Candidate Center. By default, this check box is:</p> <ul style="list-style-type: none"> • Deselected in administrator pages. Select this option if you would like to share the comment with the candidate. • Selected in the Candidate Center self-service pages when candidates add comments.

Several fields will always appear in this section: these include the Effective Date, Effective Sequence and Effective Status.

Field or Control	Description
Status	<p>Select a status from the available list. Available statuses include those assigned to a research group code that is associated with a user defined requirement type.</p> <p>The status values are defined in the Research Status Code setup component. The available research status codes are those defined with the System Usage value equal to Requirement. This is a required field.</p> <hr/> <p>Note: This field has underlying PeopleCode that supports 3C Engine triggers that occur in real time or store in a trigger table for processing later. Essentially, communications can be triggered automatically based on assigning a specific status value.</p> <hr/>
Additional Information	<p>This link appears only if common attributes have been created for the candidate’s research topic using the Common Attribute Framework. Click the link to accesses a Common Attributes subpage where you can enter or modify the additional information.</p> <p>See:</p> <ul style="list-style-type: none"> • Using Common Attribute Framework for Research Tracking • “Understanding Common Attribute Framework” (Campus Community Fundamentals) • “Defining a Common Attribute” (Campus Community Fundamentals)

Creating Assignments for Multiple Students

Access the Create Assignments page (**Records and Enrollments > Graduate Research Management > Create Assignments**).

This example illustrates the fields and controls on the Create Assignments page. You can find definitions for the fields and controls later on this page.

Create Assignments

Run Control ID: HE01 [Report Manager](#) [Process Monitor](#)

Population Selection

*Academic Institution: PSUNV PeopleSoft University

Use Current Date

*Effective Date: 09/10/2013

Selection Tool

Population Selection

Selection Tool: PS Query [Edit Prompts](#)

Query Name: SSR_RS_BAT_ASSIGN [Launch Query Manager](#) [Preview Selection Results](#)

Student Override

Student Override

Assignment Details [Find](#) | [View All](#) First 1 of 1 Last

*Assignment Type: HU Human Test Subject Clearance

*Assignment Status: HT20 Approved

Approval Date: 09/10/2013

Advisory Committee: TEST Test Review Committee

Completion Date: 09/30/2013

Comment:

Use this page to insert multiple, new assignments into existing research and project records.

This Application Engine process enables you to create assignment records for a group of EmplIDs, instead of using the Candidate Management-Other Assignments page or the Project Management-Additional Details page to create assignments for individual students.

You can either use the **Population Selection** framework to identify a population of students or manually enter a list of EmplIDs in the **Student Override** region.

Population Selection

Select this check box to run the process using Population Selection.

Population selection is a method for selecting the IDs to process for a specific transaction. The Population Selection group box is a standard group box that appears on run control pages when the Population Selection process is available or required for the transaction. Selection tools are available based on the selection tools that your institution selected in the setup of the Population Selection process for the application process and on your user security. Fields in the group box appear based on the selection tool that you select. The fields behave the same way from within the group box on all run control pages and

application processes. If your institution uses a specific delivered selection tool (PS Query, Equation Engine equation, or external file) to identify IDs for a specific transaction, you must use it.

Campus Solutions delivers a sample query (SSR_RS_BAT_ASSIGN) for the Create Assignments process.

If you select the **Population Selection** check box, the **Student Override** check box is unavailable for entry.

See “Using the Population Selection Process” (Campus Community Fundamentals).

Student Override

Select this check box to specify one or more EmplIDs for which you want to run the Create Assignments process.

If you select the **Student Override** check box, the **Population Selection** check box is unavailable for entry.

Note: If you select the Student Override option, only those EmplIDs that have an active Candidate Header or Project record are available. However, the system cannot enforce this rule if you use Population Selection. It is important to review the delivered sample query or sample Equation Engine equation to see how to select your target populations. In addition, use the SSR_PROJECT_IND field to distinguish between research candidate and student project records.

When you run the Create Assignments process using Population Selection, if the process finds an EmplID without an active Candidate Header or Project record, then the process skips the record and moves on to the next EmplID in the selection. The process message log displays the EmplIDs for all assignments created and those that were skipped.

After the process creates the new assignments, use the Candidate Management-Other Assignments page and the Project Management-Additional Details pages to manage them.

Assignment Details

For information about these fields, see [Tracking Additional Candidate Assignments](#).

Note: If an assignment record exists for a particular assignment type, the process does not create a duplicate record for the same.



Updating Candidate Management Data Using Admissions Components

Access the Candidature Details page (**Student Admissions > Application Entry > Add Application > Candidature Details**).

This example illustrates the fields and controls on the Candidature Details page (1 of 3). You can find definitions for the fields and controls later on this page.

Application School/Recruiting | Application Student Response | Additional Details | **Candidature Details**

Daphne Ferrer SRRS0020

Academic Institution: PeopleSoft University   

Academic Career: Medical School **Application Number:** 00025858

Academic Program: Medical Research Field **Candidate Number:** 000000000043

Academic Plan: Lab Research Site 2

[Attachments \(0\)](#)

Consumption Find | View All | First 1 of 1 Last

***Effective Date:** 03/19/2014 ***Eff Seq:** 1 ***Effective Status:** Active

Consumption Model: None Days

Ovrd Load: FULL Full Time **Consumption Rate:** 1.00

Begin Date: 08/30/2014 **Calculated Values** **Early Submission %:** 100

Total Days: 1250.00

Early Submission Date: 01/31/2018

Final Submission Date: 01/31/2018

Comments

Comment 

Set total days to 1250.

Display Comment to Student

***Status:** P Pending Finalization **Status Date:** 03/19/2014

This example illustrates the fields and controls on the Candidature Details page (2 of 3). You can find definitions for the fields and controls later on this page.

Research Topic
Find | View All First 1 of 1 Last

Sequence: 1 Topic Search Create Topic Attachments (0)

Topic Details
Find | View All First 1 of 1 Last

*Effective Date: 03/19/2014 *Effective Sequence: 1

Effective Status: Active

Topic Code: RT0008

Research Topic:

Huntington Hospital - Sponsored Research Project

Topic Description:

Research funded by the Huntington Hospital Research organization. A written proposal approved by the hospital must be submitted with the application for admission to the university.

Thesis Title:

▼ Comments

Comment:

Requested by the department

Display Comment to Student

*Status: P Proposal Submitted

Status Date: 03/19/2014

This example illustrates the fields and controls on the Candidature Details page (3 of 3). You can find definitions for the fields and controls later on this page.

Supervisors Find | View All First 1 of 1 Last

Sequence: 1 Attachments (0)

Supervisor Details Find | View All First 1 of 1 Last

*Effective Date: 03/19/2014 *Effective Sequence: 1

*Effective Status: Active

Supervisor Search

Supervisor: [Search]

Start Date: 03/31/2014 End Date: 12/31/2020

Supervision Percentage: 100.00 Supervisor Role: PSUP Primary Supervisor

Funding Percentage: 100.00 Affiliation Code: []

Budget Department: [] Primary Supervisor

Academic Organization: ECONOMICS

Advisory Committee: QECS Soc Qualifying Committee

Comments

Comment

Will be managed by committee.

Display Comment to Student

*Status: REVIEW Review in Progress

Status Date: 03/19/2014

This example illustrates the fields and controls on the Candidature Details page (4 of 4). You can find definitions for the fields and controls later on this page.

The screenshot displays the 'Assignments' page for an 'Employment Contract' (EC). The page includes the following fields and controls:

- Assignment:** EC (with a search icon) and Employment Contract. Attachments (0) with expand/collapse icons.
- Effective Date:** 03/19/2014 (with a calendar icon).
- Effective Status:** Active (dropdown menu).
- Completion Date:** (empty field with a calendar icon).
- Approver ID:** (empty field with a search icon).
- Advisory Committee:** (empty field with a search icon).
- Approval Date:** (empty field with a calendar icon).
- Effective Sequence:** 1 (input field).
- Comments:** A section with a rich text editor toolbar (including Bold, Italic, Underline, and other formatting options) and a text area. Below the text area is a checkbox labeled 'Display Comment to Student'.
- *Status:** Initiated (input field with a search icon).
- Status Date:** 03/19/2014.

This page is available only if the candidate has a research-eligible academic program or academic plan (the Use Research Processing check box is selected on the Research Processing Options page in the Academic Program Table or Academic Plan Table components).

See:

- [Setting Up Research Tracking Options for Academic Programs](#)
- [Setting Up Research Tracking Options for Academic Plans](#)

Each subpage follows the design of, and behaves similarly to, the pages used in the Candidate Management component (Records and Enrollment, Graduate Research Management, Candidate Management).

Field or Control	Description
Attachments	<p>Click this link to view and add attachments to the candidate. Attachments uploaded to this link are stored at the candidate level. The number in parentheses indicates the number of attachments currently stored.</p> <p>In the File Attachments grid, the Visible to Student check box allows you to set whether or not the attachment is visible to students on the Candidate Center self-service page. By default, this check box is:</p> <ul style="list-style-type: none"> • Deselected in administrator pages so attachments are not visible to students. • Selected in Candidate Center self-service pages when candidates add attachments.
Additional Information	<p>If common attributes have been created for the candidate's consumption and submission information, this link appears. Click the link to access a Common Attributes subpage where you can enter or modify the additional information.</p> <p>See:</p> <ul style="list-style-type: none"> • Using Common Attribute Framework for Research Tracking • "Understanding Common Attribute Framework" (Campus Community Fundamentals)
Comment	<p>This field is intended for administrators to add contextual notes to the current row of data. When a new effective data row is entered, the field is reset to blank. When the user scrolls through the row of the record, the comment scroll area automatically opens so that the comment is not missed. In addition, candidates will have the ability to enter comments through the Candidate Center by initiating a Research Service Item.</p>
Display Comment to Student	<p>Select to allow candidates to view the comment in the Candidate Center. By default, this check box is:</p> <ul style="list-style-type: none"> • Deselected in administrator pages. Select this option if you would like to share the comment with the candidate. • Selected in the Candidate Center self-service pages when candidates add comments.

For information about Research Topic, Supervisors, and Assignment sections of this page, refer to the documentation about the related pages in the Candidate Management component earlier in this section.

The following information is about the Consumption section of the page. (The example page above shows data for an applicant who has not been matriculated).

Admissions Processing: Understanding Consumption

By its definition, consumption does not begin until the candidate begins their research program. During the admissions process, you can establish the inputs to the consumption calculation and submission dates can be calculated; none of the values are finalized until the candidate has been admitted and matriculated. The following explains the consumption behavior during the admissions cycle.

Research-Eligible Application is Submitted:

A program or plan is research-eligible if the Use Research Processing check box is selected on the Research Processing Options page in the Academic Program Table or Academic Plan Table component.

When a research-eligible application is submitted, consumption information is populated in the Admissions component.

Candidate is Admitted into the Research Program:

During the Admissions process, before matriculation, an administrator might make changes to the application data that affect consumption calculation—for example, a change to the load or the time allocated for a candidate to complete the research.

Candidate is Matriculated into the Research Program:

After a candidate is matriculated, you must use the Candidate Management component (Records and Enrollment, Graduate Research Management, Candidate Management) to update candidate information, including consumption.

Field or Control	Description
Consumption Model	This value appears by default from the value in the Consumption Controls group box on the (Academic Program or Academic Plan) Research Processing Options page.
Ovrd(override)	This check box is selected for fields for which you have changed the value. For example if you change the value for Begin Date, the Ovrd check box is selected for that field. A recalculation of the Submissions dates occurs using the new Begin Date value. The exception is that if the Early Submission Date or Final Submission Date fields have been overridden, the overridden Submission date values remain.
Load	The rate and intensity at which the candidate's research is conducted. This is similar in concept to Academic Load, but is based on the candidate's research effort, not on enrollment. The Load value appears by default from the Consumption Load value in the Consumption Controls group box on the (Academic Program or Academic Plan) Research Processing Options page. You can change the load—the Submission dates are recalculated (except if the dates have been overridden).

Field or Control	Description
Begin Date	Derived from the start date of the Admit Term. You can change the date—the Submission dates are recalculated (except if the dates have been overridden).
Total Days	<p>The value appears here by default from the Candidacy Duration – Days value on the (Academic Program or Academic Plan) Research Processing Options page. You can change the number of days—the Submission dates are recalculated (except if the dates have been overridden).</p> <hr/> <p>Note: Time is not consumed until after matriculation and therefore Days Remaining is never calculated/does not appear in the Admissions components (it appears in the Candidate Management component after matriculation).</p> <hr/>
Early Submission Date	The earliest date on which candidates can submit their thesis for review. This date is initially calculated based on the Consumption Controls setup in the Academic Program Table or Academic Plan Table components. The Early Submission Date is recalculated if a change is made to the Load, Begin Date, or Total Days (except if the Early Submission Date has been overridden).
Final Submission Date	The latest date on which the candidate can submit the thesis for review. This date is initially calculated based on the Consumption Controls setup in the Academic Program or Academic Plan components. It is recalculated if changes are made to the Load, Begin Date, or Total Days (except if the Final Submission Date has been overridden).
Status	<p>This is the Consumption status. Values appear here based on the values defined on the Research Status Code Setup page (System Usage value is Consumption).</p> <p>The Status codes should be used to describe the reason that the consumption record was modified. This is a required field.</p> <hr/> <p>Note: This field has underlying PeopleCode that supports 3C Engine triggers that occur in real time or store in a trigger table for processing later. Essentially, communications can be triggered automatically based on assigning a specific status value.</p> <hr/>

Field or Control	Description
Calculated Values	When the system recalculates consumption (due to a change in load, for example), then if the Early Submission Date or Final Submission Date values (or the Remaining Days value after the student is matriculated) have been overridden, the system also calculates consumption based on the original values from setup (it ignores the overridden values) and provides that data here in the Calculated Values fields.
Consumption Rate and Early Submission %	These values appear by default from the (Academic Program or Academic Plan) Research Processing Options page.
Recalculate	This button is available when you enter a new row or change a value in a field, so that you can see the calculation results before you save the page. Regardless of whether you use the Recalculate button, a recalculation occurs when you save the page.

Related Links

[Setting Up Research Tracking Options for Academic Programs](#)

[Setting Up Research Tracking Options for Academic Plans](#)

“Updating Applications” (Recruiting and Admissions)

Managing a Candidate’s Thesis

This section provides an overview of thesis management and discusses how to:

- Enter thesis details.
- Enter thesis evaluation.
- Enter thesis comments.
- Enter additional information.
- Store thesis attachments.

Understanding Thesis Management

The Thesis Management component is the main administrative component that tracks the progress of the thesis and its evaluation. A single thesis record is part of the research candidate structure, and you can enter information after the research candidate has been created. The component interacts with the Evaluation Management feature to capture the evaluation status and any prize or honors recommendations.

See “Understanding Evaluation Management” (Campus Community Fundamentals)

See “Understanding Evaluation Management Setup” (Campus Community Fundamentals)

Pages Used to Manage a Candidate’s Thesis

Page Name	Definition Name	Navigation	Usage
Thesis Submission	SSR_RS_THESIS_MAIN	Records and Enrollment > Graduate Research Management > Thesis Management > Thesis Submission	This is the main thesis management page, containing the general details of the thesis.
Thesis Management – Evaluation	SSR_RS_THESIS_FNL	Records and Enrollment > Graduate Research Management > Thesis Management > Evaluation	After results are obtained, complete the details on this page and review any awards for the candidature.
Thesis Management – Comments	SSR_RS_THESIS_CMNT	Records and Enrollment > Graduate Research Management > Thesis Management > Comments	Enter and review comments relating to the candidate’s thesis.
Thesis Management – Additional Information	SSR_RS_THESIS_CA	Records and Enrollment > Graduate Research Management > Thesis Management > Additional Information	Enter and review Common Attribute fields associated with the candidate’s thesis. This page appears only if Common Attribute fields have been created using the Common Attribute Framework.
Thesis Management – Attachments	SSR_RS_THESIS_ATTCH	Records and Enrollment > Graduate Research Management > Thesis Management > Attachments	View and add attachments associated with the thesis.

Entering Thesis Details

Access the Thesis Submission page (**Records and Enrollment > Graduate Research Management > Thesis Management > Thesis Submission**).

This example illustrates the fields and controls on the Thesis Submission page. You can find definitions for the fields and controls later on this page.

Thesis Submission		Evaluation	Comments	Additional Information	Attachments
Sylvia Fouls		SRRS0033			
Academic Institution:	PeopleSoft University	Candidate Number:	000000000014	Early Submission Date:	06/09/2014
Academic Career:	Medical School	Career Nbr:	0	Final Submission Date:	06/09/2014
Academic Program:	Medicine	Days Remaining:	0.00		
Academic Plan:	Animal Testing Research 3				

Submission	
*Effective Date:	06/05/2014
*Effective Status:	Active
Effective Sequence:	1
Thesis Submission Nbr:	1
Principal Supervisor:	
Thesis Title:	Molecular Cloning and Expression of Myostatin in Gecarcinus lateralis and Carcinus means: implications for Regulation of Muscle Atrophy
Transcript Level:	Print on Official
*Thesis Status:	30 Evaluation Complete - Approved
Intent to Submit Approval:	
Intended Submission Date:	
Actual Submission Date:	
Num of Copies Submitted:	
Embargo Type:	
Start Date:	
End Date:	

This is the main thesis management page containing the general details of the thesis from the time the request for a Notice of Intention to Submit is issued through the submission of the thesis. The Thesis Management record is created when the system first recognizes the person as a research candidate. The thesis record structure is effective dated, so you must insert a new effective dated row in the component as data is modified. Central to this is the updating of the Thesis Status, which should explain the reason for the data modification.

Any user with access to the Thesis Management component can view or edit this page. Generally, however, update access is restricted to staff in the Research Office or Heads of Department (or similar level academic staff members).

Note: Because the thesis record becomes linked to the evaluation records created in the Evaluation Management System, validations have been placed to prevent deleting all related thesis data rows if an evaluation record has already been created.

Field or Control	Description
	For information about the Send Notification button, See Using Online Notifications
Thesis Submission Nbr (Thesis Submission Number)	A counter field that generally corresponds to a separate evaluation. The initial value is 1, and the value is generated by the system each time a new Submission row is inserted (as distinct from a new effective dated row), by clicking the Resubmit Thesis button. An example of use: The initial value of 1 is used to track the submission and evaluation of the thesis. The evaluation results in a request for the thesis to be modified and resubmitted for evaluation. The number is incremented by one to track the resubmission of the thesis and to create a new evaluation.
Principal Supervisor	The current supervisor nominated as being principally responsible for the candidature. This principal supervisor is the person identified in the Candidate Management, Supervisor page with the Principal Supervisor check box selected.
Thesis Title	Enter a thesis title. If you are using the Thesis Title field on the Research Topic page to develop the candidate's thesis title, that value is automatically copied if the field here is blank.
Transcript Level	Select the Transcript Level at which you want the Thesis Title information to be published.
Print on Transcript	Select this check box if you want to print the Thesis Title information on the transcript. <hr/> Note: It is possible to print multiple Thesis Titles from a single thesis record. The transcript process selects the most recent row for each unique thesis submission number where the transcript level is set and the Print on Transcript option is selected.
Thesis Status	This field works closely with the Effective Date and Effective Sequence fields to indicate the current stage of the candidate's thesis. The Status values are defined in the Research Status Code setup component. The available research status codes are those defined with the System Usage value equal to <i>Thesis</i> . This is a required field. <hr/> Note: This field has underlying PeopleCode that supports 3C Engine triggers that occur in real time or store in a trigger table for processing later. Essentially, communications can be triggered automatically based on assigning a specific status value.

Field or Control	Description
Resubmit Thesis	<p>Occasionally it is necessary for a candidate to completely rewrite a thesis after the first examination and resubmit it several months later, possibly with new examiners. This effectively restarts the thesis examination and grading process. Clicking the Resubmit Thesis button enables the processing of a resubmission by inserting a new row and resetting all fields to the correct values ready for a new Notice of Intention to Submit and the resubmission of the thesis.</p> <hr/> <p>Note: Inserting a new effective-dated row without using the Resubmit Thesis button carries forward all field values from the previous row; because the resubmission process is used infrequently, use the button instead and thus ensure that the correct values are set automatically.</p> <hr/> <p>If clicking the Resubmit Thesis button causes the maximum number of submissions to be exceeded (based on the maximum defined on the Research Processing Options page) a Warning message appears.</p> <p>See Setting Up Research Tracking Options for Academic Programs</p>
Candidate Management	Click this link to navigate to the Candidate Management component.

Submission

These fields relate to the Notice of Intent to Submit (NOITS) process which generally must be completed before the thesis can be evaluated.

Field or Control	Description
Intent to Submit Approval	This field specifies whether the supervisor has approved the candidate's intent to submit the thesis.
Intended Submission Date	This is the date when the candidate plans to submit the thesis in the NOITS (and when it has been approved by the supervisor). The Research Administrator manually enters this date.
Actual Submission Date	This field indicates when the thesis was actually delivered to the Research Administrator, ready to be examined.
Num of Copies Submitted (Number of Copies Submitted)	This field indicates the number of copies of the thesis submitted for examination.

Field or Control	Description
Details Declared Correct	Select this check box to indicate that the candidate’s supervisor has declared that the details provided by the student in the NOITS are correct. The check box is deselected by default.
Ready for Completion Seminar	Select this check box to notify the Head of Department to schedule the seminar using the Events module. The check box is deselected by default.
Return of Thesis Requested	Select this check box to indicate that the candidate has requested the return of the thesis after examination. The check box is deselected by default.

Embargo

These fields relate to the treatment of the thesis and examiners once the evaluation process has been completed.

Field or Control	Description
Embargo Type	The reason for the withholding the thesis from the public (Embargo). Select from: <i>Intellectual Property</i> , <i>Ethical Considerations</i> , <i>National Security</i> , and <i>Unembargoed</i> (default value).
Start Date and End Date	The start and end dates of the embargo period.

See “Understanding Evaluation Management” (Campus Community Fundamentals).

Entering Thesis Evaluation

Access the Thesis Management – Evaluation page (**Records and Enrollment > Graduate Research Management > Thesis Management > Evaluation**).

This example illustrates the fields and controls on the Thesis Management – Evaluation page. You can find definitions for the fields and controls later on this page.

Thesis Submission
Evaluation
Comments
Additional Information
Attachments

Sarah Connors SRRS0019
Academic Institution: PeopleSoft University **Candidate Number:** 000000000025 **Early Submission Date:**
Academic Career: Medical School **Career Nbr:** 0 **Final Submission Date:**
Academic Program: Medicine **Days Remaining:** 0.00
Academic Plan: Animal Testing Research 1

Find | View All
First
1 of 1
Last

Effective Date: 09/17/2013 **Effective Sequence:** 1 **Thesis Submission Nbr:** 1 🔍 📅 💬

Thesis Status: Evaluation in Progress

Examination

Exam Supervisor Approval: Exam Initiated
Certificate Final Approval: **Certificate Approver:**
Oral Defense Date 📅

Result

Evaluation Status: [Review Evaluations](#)

Recommendation: **Recommended Prize:**

Honors and Awards
Personalize | Find | 📄
First
1 of 1
Last
[Honors/Awards](#)

Honor/Award	Description

Degree: MD M.D. Doctor of Medicine [Student Career/Program](#)

Finalization

- Candidate Advised
- Examiner Payments Processed
- Library Submission Made
- Proceed to Graduation

After all the results required to determine the outcome of the candidature have been obtained, the appropriate *prescribed authority* completes the details on this page and records the award for the candidature. Generally, only members of a specific senior academic role should update this page, consistent with the role of Chair of Examiners, Dean, or similar.

Examination

Field or Control	Description
Exam Initiated	Select this check box to indicate that the candidate has submitted the examination certificate. You can select this check box only if the Intent to Submit Required check box on the Research Processing Options page has been selected.
Exam Supervisor Approval	This field indicates whether the candidate’s supervisor has approved or rejected the examination certificate. If the Exam Certificate Required check box is selected on the Research Tracking Options page, you must enter a value in this field.

<i>Field or Control</i>	<i>Description</i>
Certificate Final Approval	This field indicates whether the Head of Department (or perhaps the Dean or Chair of Examiners) has approved or rejected the examination certificate, which has been endorsed by the supervisor. If the Exam Certificate Required check box is selected on the Research Tracking Options page, you must enter a value in this field.
Certificate Approver	This field defaults to the current user. Because it is likely that the thesis data will be updated by an administrator or some other user on behalf of a professor or a dean, you can look up and select an approver from an available list.

See [Setting Up Research Tracking Options for Academic Programs](#)

See [Setting Up Research Tracking Options for Academic Plans](#)

Result

<i>Field or Control</i>	<i>Description</i>
Evaluation Status	This display-only field from the Evaluation Management component shows the current value of the Evaluation Status field for the highest evaluation number row for the subject candidate number. This is the current overall status of the thesis evaluation.
Review Evaluations	<p>Click this link to begin the evaluation process. When you click the link for the first time, you are prompted to create the candidate's evaluation records in the Manage Evaluation component, in which the actual evaluation detail takes place. The Evaluation Category and Evaluation Code parameters that have been defined for the candidate's academic program or academic plan are used to create the appropriate evaluation committee schemes and rating components. You can override these settings if a different evaluation makeup is necessary.</p> <p>If an existing evaluation has previously been created for the candidate, the link takes you to the Manage Evaluation component to view this information.</p>

<i>Field or Control</i>	<i>Description</i>
Recommendation	This field is read-only and displays data from the Recommendation field in the Manage Evaluation component. This information is displayed only when the candidate's evaluation code is equal to that specified in the Final Evaluation Result Code field; if no result code is shown, the evaluation process is not yet complete.
Recommended Prize	This read-only field shows the prize nominations (if any) for the candidate in the Manage Evaluations component.
Honors and Awards	More than one Honor or Award can be associated with the final result. They are displayed in this table.
Honors/Awards	Click this link to access the Honors and Awards Table (Set Up SACR, Product Related, Campus Community, Define Campus Community, Setup, Honors and Awards Table). The Prescribed Authority reviews the prize nominations and identifies the prize awarded to the candidate here (usually following a determination by the relevant committee).
Degree	This field displays the name of the degree with which the candidate is eligible to graduate. This is a read-only field of the degree granted the academic plan.
Student Career/Program	Click this link to access the Student Program/Plan component.

Finalization

<i>Field or Control</i>	<i>Description</i>
Candidate Advised	Select this check box when the candidate has been or is about to be advised of the outcome of the thesis examination and overall grade.
Examiner Payments Processed	Select this check box to indicate that the thesis examiner's payments have been processed. You manually set this field after determining that all payment processing is completed.
Library Submission Made	Select this check box to indicate that the archival copy of the final thesis has been sent to the University Library.

Field or Control	Description
Proceed to Graduation	Select this check box to indicate that this candidate is ready to be processed for graduation (and is now moving out of the responsibility of Thesis Management).

See “Managing Evaluations” (Campus Community Fundamentals)

Entering Thesis Comments

Access the Thesis Management – Comments page (**Records and Enrollment > Graduate Research Management > Thesis Management > Comments**).

This example illustrates the fields and controls on the Thesis Management – Comments page. You can find definitions for the fields and controls later on this page.

The screenshot displays the 'Comments' tab of a thesis management system. At the top, navigation tabs include 'Thesis Submission', 'Evaluation', 'Comments', 'Additional Information', and 'Attachments'. The candidate information for Sarah Connors (SRRS0019) is shown, including her academic institution (PeopleSoft University), career (Medical School), program (Medicine), and plan (Animal Testing Research 1). Submission dates and remaining days are also listed.

The 'Comments' section features a toolbar with icons for actions like 'Find', 'View All', 'First', '1 of 1', and 'Last'. The comment entry area includes fields for 'Effective Date' (09/17/2013), 'Effective Sequence' (1), 'Effective Status' (Active), and 'Thesis Submission Nbr' (1). The 'Thesis Status' is 'Evaluation in Progress'. A rich text editor is provided for entering comments, with a 'Format' dropdown, font and size selection, and bold, italic, and underline options. A 'Display Comment to Student' checkbox is present and unchecked. The 'Comment Author' is identified as KU0007 Betty Locherty.

Any user with access to the Thesis Management component can view or edit this page. You can add or delete comments only through the Thesis Submission page. Comments are specific to each effective dated row and will reset to blank each time a new row is inserted.

Field or Control	Description
Comments	Enter your comments in the text box. By default, the field is empty.

Field or Control	Description
Display Comment to Student	<p>Select to allow candidates to view the comment in the Candidate Center. By default, this check box is:</p> <ul style="list-style-type: none"> • Deselected in administrator pages. Select this option if you would like to share the comment with the candidate. • Selected in the Candidate Center self-service pages when candidates add comments.
Comment Author	<p>Select the OPRID of the user who updated the comment field from the available list. The Author defaults to the current user, but it is likely that the thesis data will be updated by an administrator or some other user on behalf of a professor or a dean. The name associated with the OPRID is also displayed on the page.</p>

Entering Additional Information

Access the Thesis Management - Additional Information page (**Records and Enrollment > Graduate Research Management > Thesis Management > Additional Information**).

This example illustrates the fields and controls on the Thesis Management - Additional Information page. You can find definitions for the fields and controls later on this page.

Enter and review Common Attribute fields associated with the candidate’s thesis. This page appears only if Common Attribute fields have been created using the Common Attribute Framework.

See:

- [Using Common Attribute Framework for Research Tracking](#)
- “Understanding Common Attribute Framework” (Campus Community Fundamentals)
- “Defining a Common Attribute” (Campus Community Fundamentals)

Storing Thesis Attachments

Access the Thesis Management - Attachments page (**Records and Enrollment > Graduate Research Management > Thesis Management > Attachments**).

This example illustrates the fields and controls on the Thesis Management - Attachments page. You can find definitions for the fields and controls later on this page.

This page is used to store thesis-specific attachments.

Field or Control	Description
Visible to Student	Select to set whether or not the attachment is visible to students on the self service page. By default, attachments added to administrator pages are not visible to students.
Add Attachment	Click this button to add an attachment to the page.

Managing Service Requests

A service request is any request that research candidates might make to their department for which the department would want to track and maintain the status of each request. Examples of service requests can include:

- Appointment requests.
- Leave of absence requests.
- Return from leave notifications.
- Change of research topic.
- Request for extension of the thesis due date.
- Request for a new supervisor.
- Submission of the thesis for review.

See [Setting Up Research Service Requests](#)

See “Creating and Updating Service Requests (Candidates)” (Campus Self Service)

See “Administering Service Requests (Administrators)” (Campus Self Service)

See [Setting Up Service Request Assignments](#)

Page Used to Manage Service Requests





<i>Page Name</i>	<i>Definition Name</i>	<i>Navigation</i>	<i>Usage</i>
Service Request Management	SSR_RS_REQUESTS	Records and Enrollment > Graduate Research Management > Service Request Management	Manage service requests.

Managing Service Requests

Access the Service Request Management page (**Records and Enrollment > Graduate Research Management > Service Request Management**).

This example illustrates the fields and controls on the Service Request Management page. You can find definitions for the fields and controls later on this page.

Service Request Management

Jeremy Dann SRRS0002





Academic Institution: PSUNV PeopleSoft University

Service Request

Category: OTHER	Other	Request Number:	4
Type: OTR	Non-specified request	Request ID:	1
Subtype:		Candidate Number:	

Service Request Details Find | View All First 1 of 1 Last

Sequence ID: 1	*As of Date: 07/03/2013		+
Assigned To: FA0800  Wrench,Julia	Request Date: 05/03/2013		-

Comment:

How many research programs are offered at the medical campus?

<input type="checkbox"/> Display Comment to Student	Approver ID: <input style="width: 80px;" type="text"/>
*Status: RECVD  Request Received	Status Date: 07/03/2013
Updated By: Locherty,Betty	Last Updated: 18/09/2013 7:50:07PM

File Attachments Personalize | Find | View All First 1 of 1 Last

Attachments Audit	
Attached File	View Add Attachment
	View Add Attachment -

Transfer To: Go

Service requests that result in changes to the candidate’s information require changes to be made in the Candidate Management component.

Use this page to review and process service requests made by the candidate—for example, a request for a leave of absence.

Field or Control	Description
	For information about the Send Notification button, See Using Online Notifications

Field or Control	Description
Category (service request category)	The values available here are defined on the Service Request Categories page.
Type (service request type)	The values available here are defined on the Service Request Type page.
Subtype (service request subtype)	The values available here are defined on the Request Subtype group box of the Service Request Type page. This is a required field if the institution has defined a subtype for the service request type.
Candidate Number	Because service requests can be submitted prior to the candidate being admitted to a research program, this field may initially be blank. Once assigned to a research program, assign the candidate number if the service request is related.

Service Request Details

This effective dated section of the page tracks the initial service request details and then documents the review and resolution of the request by the administrator.

Field or Control	Description
Request Date	Enter the date of the service request.
Comment	A rich text format field for free form comments.
Display Comment to Student	Select if you want the text entered in the Comment field to be displayed on the My Request Detail self-service page for the student.
Assigned To	Displays the EmplID of the administrator to whom the service request is assigned. The system automatically assigns the service request to an administrator. Users can reassign the service request to another administrator if needed. See Setting Up Service Request Assignments
Approver ID	If required, select the EmplID of the person that approved the service request.

Field or Control	Description
Status	Select a status from the available list. Available statuses include those assigned to a research group code that is associated with a user defined requirement type. The Status values are defined in the Research Status Code setup component. The available research status codes are those defined with the System Usage value equal to <i>Requests</i> . This is a required field.
Status Date	The date when the status was entered.
Updated By	The user who last updated the service request.
Last Updated	The date and time when the service request was last updated.
File Attachments	Add and view attachments for the specific service request.

Related Links

[Tracking Consumption and Submission](#)

Managing Candidate Eligibility Edit Messages

This section provides an overview of candidate eligibility edits and discusses how to review and override candidate information.

Understanding Candidate Eligibility Edits

Research candidates are determined to be research-eligible based on their participation in an eligible academic program or academic plan. When a candidate changes his or her academic program or plan, edits reevaluate the candidate's research eligibility. These edits are triggered by the components in which a modification of the candidate's academic program or academic plan can be made.

When a change to the candidate's academic program or academic plan warrants a review of the candidate's records, two things occur:

1. Every time the candidate's records are viewed in the Candidate Management component, a warning message appears. The warning message continues until the conditions that caused the warning are removed.
2. A *Candidate Review Required* message appears on the top of the Candidate Management component.

Use the Candidate Management Override component to resolve both conditions.

Page Used to Review A Candidate's Edit Messages

<i>Page Name</i>	<i>Definition Name</i>	<i>Navigation</i>	<i>Usage</i>
Candidate Management Override	SSR_RS_CAND_OVRD	Records and Enrollment > Graduate Research Management > Candidate Management Override > Candidate Management Override	Review records that have been flagged for review due to program or plan discrepancies.
Candidate Management Messages	SSR_RS_MSGS_SEC	Click the Messages link on the Candidate Management Override page.	Read the messages that indicate why the candidate's records must be reviewed.

Reviewing and Overriding Candidate Information

Access the Candidate Management Override page (**Records and Enrollment > Graduate Research Management > Candidate Management Override > Candidate Management Override**).

This example illustrates the fields and controls on the Candidate Management Override page. You can find definitions for the fields and controls later on this page.

Candidate Management Override

John Young SRRS0031 🔍 📄 💬 📧

Academic Institution: PeopleSoft University Candidature Review Needed

Candidature Header Record Information

Academic Career: MEDS Medical School

Student Career Nbr: 0

Candidate Number: 000000000012

Assigned

Academic Program: MED Medicine

Academic Plan: MEDRS1 Animal Testing Research 1

Update Messages

▼ Admissions Find | View All First 1 of 1 Last

Academic Program:

Program Status:

Plan Data Find | View All First 1 of 1 Last

Academic Plan:

Sub-Plan Data Find | View All First 1 of 1 Last

Sub-Plan:

▼ Student Records Find | View All First 1 of 1 Last

Academic Program: MED Medicine

Program Status: AC Active

Plan Data Find | View All First 1 of 1 Last

Academic Plan: MEDRS1 Animal Testing Research 1

Sub-Plan Data Find | View All First 1 of 1 Last

Sub-Plan:

Use this page to review records that have been flagged for review due to program or plan discrepancies. The page includes three sections: information from the Candidate Header Record (the main identifying record in the research data structure), information from Admissions, and information from Student Records.

When a candidate makes a change to his or her academic program or academic plan, the change does not automatically update the candidate section after matriculation. The main reason for this is that the impact of the change (on the research topic, supervisors, and thesis submission dates) cannot be determined by the system. The administrator must make the appropriate adjustments to the candidate's information and then, if the candidate remains eligible, update the Candidature Header information so that the academic program and plans now match the Student Record values.

You can override the Candidate Header Academic Program or Academic Plan values in order to sync with the admissions or program information.

Field or Control	Description
	For information about the Send Notification button, See Using Online Notifications

Candidature Header Record Information

The fields displayed in this section contain the main research candidate records: Academic Career, Student Career Number, Candidate Number, Academic Program, and Academic Plan. Additional fields include the following:

Field or Control	Description
Assigned	If this check box is selected, it indicates that the research candidate information on display is assigned to the candidate and is considered <i>active</i> . If the check box is deselected, it indicates that the information is unassigned, meaning that this represents an inactive set of candidature information. For example, if a research candidate changes his or her academic program or academic plan and no longer is research eligible, the Assigned check box is deselected and the student is no longer treated as a research candidate. If this occurs during the admissions process, the Candidate page on the admissions components will no longer be visible.
Messages	This becomes a link if any edit messages have been triggered. The link opens Candidate Management Messages page where you can read the messages which indicate why the candidate's records must be reviewed.
Update	Click this button to make the Academic Program, Academic Plan, and Student Career Nbr fields editable.

Reviewing Messages

Access the Candidate Management Messages page (click the **Messages** link on the Candidate Management Override page).

This example illustrates the fields and controls on the Candidate Management Messages page.

Candidate Management Messages						
Message Set	Message Number	Message Severity	Message Text	Description	Created	
1	14751	48 Message	The academic program or plan has been changed, please verify the candidate's research information.		11/18/2011 1:38:54PM	

Using Administrative Functions for Research Tracking

Campus Solutions delivers the administrative functions that can be used to create 3C communications for Research Tracking.

See “Understanding Administrative Functions” (Campus Community Fundamentals)

The functions are available from the Candidate Management and Thesis Management components.

Using Online Notifications

Use the Create Notification page to send online notifications. This page uses the Notification Framework to send predefined alerts, emails, or SMS to persons defined in the Campus Solutions database.

Page Used to Create Online Notifications

<i>Page Name</i>	<i>Definition Name</i>	<i>Navigation</i>	<i>Usage</i>
Create Notification	SCC_NTF_ADHOC	Click the Send Notification button on various Research Tracking and Academic Project pages.	Initiate online notifications using predefined notification templates.

Creating Online Notifications

Access the Create Notification page (click the **Send Notification** button on various Research Tracking and Academic Project pages).

This example illustrates the fields and controls on the Create Notification page (showing the permissions warning icon). You can find definitions for the fields and controls later on this page.

The Send Notification button which launches the Create Notification page appears on the following pages in Research Tracking and Student Academic Project components only if the Notification Consumer ID defined for the component has been set up and is set to Active:

- Candidate Management - Information page
- Candidate Management Override page
- Thesis Submissions page
- Administrator Profile Management page
- Project Management page
- Service Request Management page
- Service Request Dashboard (self service)

Field or Control	Description
Notification Type	The values available here (for example Alert, Email) are defined by the user based on the notification requirements of the administrator component.
Template Name	The templates available here are the active templates defined for the selected notification type. Click the Template Details button to view details about the template.

The selected notification type and template determine valid recipient levels (To, Cc, Bcc). Depending on the notification type, you can notify multiple recipients but at least one of them must be addressed as the

To recipient. When the notification type is email or SMS, the system verifies that the recipient has granted permission to be notified. If permission has not been granted, a warning icon appears with an explanatory message. You can also configure the Create Notification page to capture and include ad hoc comments in the notifications.

This example illustrates the Create Notification page (showing the Comment box).

Create Notification

NotificationType: Email

Template Name: Thesis Review Request

*Recipient Level	ID	Name
1 To	FA0800	Wrench, Julia

Comments

Send Notification Cancel

See [Setting Up Online Notifications](#)

See “Setting Up and Consuming the Notifications Framework” (Campus Community Fundamentals)

Viewing Sent Notifications

Administrators can use the Notifications Administration Overview page (Campus Community, Notifications, Admin Notifications) to view all notifications sent to a person. They can also use the self-service Notification Center for this purpose (Self Service, Notifications Center).

See “Using Admin Notifications” (Campus Community Fundamentals)

Viewing Administrator Notifications

Administrators can use the Service Request Dashboard Notifications pagelet to view all their notifications.

See “Administering Service Requests (Administrators)” (Campus Self Service)

Managing Student Academic Projects

Creating and Managing a Student Academic Project

Student Academic Projects was developed to address the needs of institutions for enhanced management of student projects such as thesis and dissertations. Student Milestones has previously used to track these types of academic projects. Student Academic Projects utilizes many of the functions developed for the Graduate Research Management (Research Tracking) feature such as the ability to define topics of study, the ability to define supervisors for the project, and the utilization of the Evaluation Management System to score the completed project by a committee of evaluators, or individuals. Projects can be associated to a specific term, term session, or enrolled class.

This section discusses how to:

- Create and manage a student academic project.
- Enter additional details for a student academic project.

Pages Used to Create and Manage a Student Academic Project

<i>Page Name</i>	<i>Definition Name</i>	<i>Navigation</i>	<i>Usage</i>
Project Management	SSR_PROJ_MGMT	Records and Enrollment > Academic Projects > Student Project Management > Project Management	Track the development of the project and access the Evaluation Management component to conduct and score the formal evaluation.
Additional Details	SSR_PROJ_MGMT2	Records and Enrollment > Academic Projects > Student Project Management > Additional Details	Assign supervisors to the project. Multiple supervisors are supported. Add any new requirements that must be tracked for the project.

Creating and Managing a Student Academic Project

Access the Project Management page (**Records and Enrollment > Academic Projects > Student Project Management > Project Management**).

This example illustrates the fields and controls on the Project Management page. You can find definitions for the fields and controls later on this page.

The screenshot displays the 'Project Management' page with the following sections and fields:

- Project Management / Additional Details:**
 - Sylvia Fouls, SRRS0033
 - Academic Institution: PeopleSoft University, Project Number: 000000000031
 - Academic Career: Medical School, Student Career Nbr: 0
 - Academic Program: Medicine, Program Status: Active in Program
 - Academic Plan: Animal Testing Research 3
- Form Fields:**
 - *Effective Date: 06/05/2014
 - *Effective Status: Active
 - Effective Sequence: 1
 - Submission Nbr: 1
 - Topic: Honors Project
 - *Project Type: HON (Honors Project)
 - *Status: COMPLETE (Honors Project Complete)
- Project Submission:**
 - Project Title: Adaptation and Convergence - Indigenous Media for a Christian Context in Central Mexico
 - Transcript Level: Print on Official
 - Print on Transcript:
 - Submission Deadline: []
 - Oral Defense Date: []
 - Actual Submission: []
 - Buttons: Review Evaluations, Resubmit Project
- Results and Approval:**
 - Evaluation Status: []
 - Recommendation: []
 - Grading Scheme: []
 - Recommended Prize: []
 - Grade Input: []
 - Grading Basis: []
 - Final Approval: []
 - Approved By: []
- File Attachments:**
 - Table with columns: Attached File, Visible to Student, View, Add Attachment
 - Buttons: Add Attachment

When you access this page in the Add mode to create a student academic project, you must specify the ID (EmplID), Academic Institution, and Academic Career of the matriculated student.

Field or Control	Description
Academic Institution, Academic Career, Academic Program, Academic Plan, Student Career Number, Program Status	Derived from the Student Program/Plan record.
Project Number	The system generates a unique project number when you add a new student academic project.

Field or Control	Description
Project Header Detail	<p>Click to view the student's academic program and academic plan at the time when the academic project was created. This link will only appear if the student's program or plan values at the time of project creation do not match the student's current program or plan.</p> <p>Depending on the type of project and the institution's business rules, a change in the student's academic program or academic plan after the student has started the project may require a review and approval by the administrator. When this condition occurs, the system displays the Project Header Detail link and the link enables the administrator to review the change and make the appropriate adjustments, if necessary.</p>
Additional Information	<p>Click to access the Common Attributes subpage. This page uses the thesis common attributes record.</p> <p>See Using Common Attribute Framework for Research Tracking</p>
	<p>For information about the Send Notification button, see Using Online Notifications</p>
Topic	<p>Enter a topic in this field. Or click the Topic Search button to select a topic that you have set up in the Academic Project Topics – Topic Setup page.</p>
Term and Class	<p>Click to access the Term and Class page where you can associate the project with a term, session and class number.</p>
Project Type	<p>Select one of the values defined on the Academic Project Types page. You must select a project type to be able to enter a Status value.</p>
Status	<p>The status codes available here are determined by the group code defined for the project type. The status values of the group code are defined on the Process Status Codes page with the <i>Project</i> system usage value.</p> <p>See Setting Up Research Status Codes</p>

Project Submission

Field or Control	Description
Project Title	Enter the project title in this field.

Field or Control	Description
Transcript Level	Select the Transcript Level at which you want the Project Title information to be published.
Print on Transcript	<p>Select this check box if you want to print Project Title information on the transcript.</p> <hr/> <p>Note: It is possible to print multiple Project Titles from a single project record. The transcript process selects the most recent row for each unique submission number where the Transcript Level is set and the Print on Transcript option is selected.</p> <hr/>
Submission Deadline	Date when the student should submit the project for evaluation.
Actual Submission	Track the actual submission of the project for evaluation.
Oral Defense Date	Enter the date of the oral defense, if required.
Review Evaluations	<p>Click to access the Manage Evaluation component. If no matching evaluation record exists, the system prompts you to select an Evaluation Category and Evaluation Code to create the evaluation records.</p> <p>See “Managing Evaluations” (Campus Community Fundamentals)</p>
Resubmit Project	<p>Click if you want a new evaluation to be administered. This may be necessary if the first evaluation results in a non-passing score. Resubmitting the project will preserve the information and evaluation of the first project. A new evaluation will be generated for the resubmitted project. There is no limit to the number of times a project can be re-evaluated.</p> <p>When you click this button, the system adds a new row to the page with the Submission Number incremented and the page fields reset to blank.</p>

Results and Approval

<i>Field or Control</i>	<i>Description</i>
Evaluation Status, Recommendation, Recommended Prize	Displays the values from the Manage Evaluation component.
Grading Scheme, Grading Basis, Grade Input	The system prompts you from the Grading Scheme Table page for these fields. The Grade Input represents the final grade assigned to the project. See Defining Grading Schemes
Final Approval	Select <i>Approved</i> or <i>Rejected</i> to indicate whether the Head of Department (or perhaps the Dean or Chair of Examiners) has approved or rejected the project.
Approved	EmplID of the person who has given the final approval.

Entering Additional Details for a Student Academic Project

Access the Additional Details page (**Records and Enrollment > Academic Projects > Student Project Management > Additional Details**).

This example illustrates the fields and controls on the Additional Details page. You can find definitions for the fields and controls later on this page.

Project Management
Additional Details

Beatrice Geary	SR0411	
Academic Institution:	PeopleSoft University	Project Number: 00000000276
Academic Career:	Graduate Business	Student Career Nbr: 0
Academic Program:	Masters of Business Admin	Program Status: Active in Program
Academic Plan:	Marketing (MBA)	

Supervisors
Find | View All
First 1 of 1 Last

Sequence: 1 [Attachments \(0\)](#)

Supervisor Details
Find | View All
First 1 of 1 Last

*Effective Date:	<input type="text" value="03/25/2013"/>	*Effective Sequence:	<input type="text" value="1"/>	*Effective Status:	<input type="text" value="Active"/>
Supervisor:	<input type="text" value="0002"/> Jones, Susan	Affiliation Code:	<input type="text" value="PROJ_SUP"/>		
Supervisor Role:	<input type="text" value="PSUP"/> Primary Supervisor				
*Status:	<input type="text" value="APPROVED"/> Supervisor Approved	Additional Information			
Status Date:	<input type="text" value="03/25/2013"/>				

Assignments
Find | View All
First 1 of 1 Last

Assignment: Intellectual Property Ownership [Attachments \(0\)](#)

Effective Date: |Effective Sequence: || Effective Status: | | | |
Advisory Committee:	Graduate Business		
Approval Date:			
Comment:	Format Font Size B I U abc		
*Status:	Review In Progress	[Additional Information](#)	
Status Date:			

The Supervisors scroll area is used to assign the project supervisor(s). The prompt values for the Supervisor field are limited to records created in the Academic Projects – Administrator Profile Management page with the project supervisor role and are eligible to be assigned to the project.

See [Assigning Candidate Supervisors](#)

See [Defining and Managing Administrator Profiles](#)

The Assignments scroll area is used to track any school defined assignments for the project. This is similar to the Candidate Management - Other Assignments page.

See [Tracking Additional Candidate Assignments](#)

Related Links

[Creating Assignments for Multiple Students](#)

Creating Student Academic Projects in Batch

This section discusses how to create Student Academic Projects using a batch process.

Pages Used To Create Student Academic Projects in Batch

<i>Page Name</i>	<i>Definition Name</i>	<i>Navigation</i>	<i>Usage</i>
Create Project Records	SSR_PROJ_BATPR	Records and Enrollment > Academic Projects > Student Project Management > Create Project Records	Create student academic project records in batch for a group of students.

Creating Student Academic Projects in Batch

Access the Create Project Records page (**Records and Enrollment > Academic Projects > Student Project Management > Create Project Records**).

This Application Engine process enables you to create student academic project records for a group of EmplIDs. The process creates the same records as done through the Add mode of the Student Project Management component.

You can either use the Population Selection Framework to identify the population of students or can manually enter a list of EmplIDs in the Student Overrides region.

Note: For the process to create an academic project, the EmplID must have an active ACAD_PROG record. The system enforces this selection rule if you use the Student Overrides region. The ID fields in the Student Overrides region prompt you with only those EmplIDs that have an active ACAD_PROG record. However, the system cannot enforce this rule if you use Population Selection. It is important to review the delivered sample query or sample Equation Engine equation to see how to select your target populations. Note that when you run the Create Project Records process using Population Selection and if the process finds an EmplID which does not have an active ACAD_PROG record, then the process will skip the EmplID record and move on to the next EmplID in the selection. The process message log will display the EmplIDs of all projects records created and those that were skipped.

After the process creates the student academic project records, use the Project Management and Additional Details pages to manage these records.

Population Selection

Select this check box to run the process using Population Selection.

Population selection is a method for selecting the IDs to process for a specific transaction. The Population Selection group box is a standard group box that appears on run control pages when the Population Selection process is available or required for the transaction. Selection tools are available based on the selection tools that your institution selected in the setup of the Population Selection process for the application process and on your user security. Fields in the group box appear based on the selection tool that you select. The fields behave the same way from within the group box on all run control pages and

application processes. If your institution uses a specific delivered selection tool (PS Query, Equation Engine equation, or external file) to identify IDs for a specific transaction, you must use it.

See “Using the Population Selection Process” (Campus Community Fundamentals)

Campus Solutions delivers a sample query (SSR_CREATE_ACADPROJ) and sample equation (SRPSSACADPROJ) for the Create Project Records process.

See “Queries for Population Selection” (Campus Community Fundamentals)

When you select the Population Selection check box, the Student Override check box becomes unavailable for entry.

Student Override

Select this check box to specify one or more EmplIDs for whom you want to run the Create Project Records process.

When you select the Student Override check box, the Population Selection check box becomes unavailable for entry.

Project Details

Use the fields in this group box to specify default field values that the process will assign to the project records.

<i>Field or Control</i>	<i>Description</i>
Effective Date	Select the date that the process should assign as Effective Dates and Status Dates to the project records. If left blank, then the process will use the current date.
Project Type	This field displays the same prompt values that the Project Type field in the Project Management page displays. You must select a project type to be able to enter a Status value.
Status	This field displays the same prompt values that the Status field in the Project Management page displays. This is a required field.
Topic Code	This field displays the same topics that the Topic Search button in the Project Management page displays.
Term	Term values are defined on the Term Table page.
Session	This field is available for edit only if you have selected an academic institution and term.

Field or Control	Description
Class Nbr	This field is available for edit only if you have selected an academic institution and term.
Grading Scheme	This field displays the same prompt values that the Grading Scheme field in the Project Management page displays.
Grading Basis	This field is available for edit only if you have selected a grading scheme. The field displays the same prompt values that the Grading Basis field in the Project Management page displays.
Supervisor	This field displays the same prompt values that the Supervisor field in the Additional Details page displays. The process is limited to adding a single supervisor record. Additional supervisors must be added directly in the Student Project Management component after the project record has been created.
Supervisor Role	Required if you have selected a supervisor. This field displays the same prompt values that the Supervisor Role field in the Additional Details page displays.
Supervisor Status	Required if you have selected a supervisor. This field displays the same prompt values that the (Supervisor) Status field in the Additional Details page displays.
Assignment	This field displays the same prompt values that the Assignment field in the Additional Details page displays. The process is limited to adding a single assignment record. Additional assignments must be added directly in the Student Project Management component after the project record has been created.
Assignment Status	Required if you have selected an assignment. This field displays the same prompt values that the (Assignment) Status field in the Additional Details page displays.

Duplicate checking edits

A student may have more than one project during their matriculation. In fact, a student can have multiple active projects occurring at the same time. The system supports this capability. At the same time, care must be taken to prevent the accidental creation of duplicate project records.

The Create Project Records process will perform the following check to detect a possible duplicate project record being created: If there already exists a project record with the same institution, career, project type, topic code, term, session, and class number that matches the run control settings, the record will be skipped and the message log will indicate that no project record was created due to it being a potential duplicate record. If you still want to create the project record, this must be done manually using the Student Project Management component.

Creating Assignments for Multiple Student Academic Projects

Use the Create Assignments page to insert new assignments into existing academic project records for multiple students.

See [Creating Assignments for Multiple Students](#)

Viewing Class Enrollment Data

Viewing Enrollment Request History

This section discusses how to search for and view enrollment requests.

Page Used to View Enrollment Request History

<i>Page Name</i>	<i>Definition Name</i>	<i>Navigation</i>	<i>Usage</i>
Enrollment Request Search	ENRL_REQ1_INQUIRY	Records and Enrollment > Enroll Students > Enrollment Request Search > Enrollment Request Search	Search for and view enrollment request history.

Searching for and Viewing Enrollment Requests

Access the Enrollment Request Search page (**Records and Enrollment > Enroll Students > Enrollment Request Search > Enrollment Request Search**).

The enrollment engine keeps a history of all enrollment requests that it processes successfully. The system queries against these transactions, as well as any enrollment transactions posted through the Grade Roster component, and displays all of the enrollment request transactions that meet your search criteria in a grid at the bottom of this page. You must enter at least two search criteria. For example, you can search to find out how a student was dropped from a class, or you can view a list of students enrolled in a class that has been cancelled.

Warning! Access to this inquiry component should be restricted to key individuals in the institution because sensitive student information, such as course grades, is visible in this component.

<i>Field or Control</i>	<i>Description</i>
Academic Career	Enter the academic career for which you want to search for enrollment transaction history.
Term	Enter the term for which you want to search for enrollment transaction history.
Enrollment Request ID	Enter the enrollment request ID for which you want to search for the enrollment transaction history.

Field or Control	Description
Enrollment Request Source	<p>Enter the enrollment request source for which you want to search for the enrollment transaction history. The enrollment request source is the process that generated the enrollment request.</p> <p>The Self Service Grade Posting (SG) code distinguishes instructor enrollment requests (such as grade changes) from student self-service (such as adds and drops).</p> <p>The system uses this code to exclude instructor self-service grade change requests from the search views for the Enrollment Request and Quick Enroll components. These types of requests cannot be viewed from these two components because they are intended to create and view enrollment requests that contain a single ID only. You can view instructor self-service grade change requests in the Enrollment Request Search or Block Enroll components.</p>
Enrollment Request Action	Enter the enrollment request action for which you want to search for the enrollment transaction history.
Enrollment Action Reason	Enter the enrollment action reason for which you want to search for the enrollment transaction history.
User ID	Enter the user ID of the person who processed the enrollment transactions that you want to view.
ID	Enter the ID of the student whose enrollment transactions you want to view. The system prompts you with IDs from the personal data table (PERSONAL_DATA).
Class Nbr (class number)	Enter the class for which you want to view the enrollment transactions within a term. To use this field, you must also specify a term in the Term field so that the system knows which term's schedule of classes is valid.

Field or Control	Description
From Date and End Date	Specify the date range for the enrollment action. For example, search for all enrollment requests for which students were dropped from a class through the Mass Enrollment component due to a canceled class during the fall quarter.

Field or Control	Description
From Date Time and Thru Date Time (through date time)	Enter a time range during which the enrollment requests were last updated.

<i>Field or Control</i>	<i>Description</i>
Search	Click to query the enrollment tables and retrieve enrollment transaction history based on your search criteria. The system displays your search results in the Enrollment List grid at the bottom of the page.
Refresh Previous Search Result	If you select this check box, the system populates the Enrollment List grid at the bottom of this page with only the latest search results and clears previous data from the list.

Enrollment List

The system populates the grid in the lower portion of the page with each enrollment request transaction that matches your search criteria. Each row contains 46 fields of pertinent information about the enrollment request, dispersed over eight tabs. Click the tabs to view additional fields.

Viewing Student Statistics

Student Records enables you to view summary information at various points during a student's academic career, with numerous ways to access the information. You can view summaries of both enrollment and term statistics.

This section discusses how to:

- View student enrollment summaries.
- View term statistics.
- Calculate term statistic values.
- View cumulative statistics for multiple terms.
- Calculate cumulative statistic values.
- View student terms.

Pages Used to View Student Statistics

<i>Page Name</i>	<i>Definition Name</i>	<i>Navigation</i>	<i>Usage</i>
Enrollment Summary	STDNT_ENRL_INQ	Records and Enrollment > Enrollment Summaries > Enrollment Summary > Enrollment Summary	View a summary of enrollment information. The student must first enroll in classes.

Page Name	Definition Name	Navigation	Usage
Enrollment Summary - Term Statistics	TERM_STATISTICS2	Records and Enrollment > Enrollment Summaries > Enrollment Summary > Term Statistics	View term statistics for a specific term. The student must first enroll in classes, have posted transfer credits, or both.
Term History - Term Statistics	TERM_STATISTICS	Records and Enrollment > Student Term Information > Term History > Term Statistics	View term statistics for all terms within an academic career. The student must first enroll in classes, have posted transfer credits, or both.
Cumulative Statistics	CUM_STATISTICS	Records and Enrollment > Student Term Information > Term History > Cumulative Statistics	View cumulative statistics for all terms within an academic career. The student must first enroll in classes, have posted transfer credits, or both.
Student Term Search	STDNT_TERM_SRCH	Records and Enrollment > Career and Program Information > Student Term Search > Student Term Search	View all terms in which a student has been active.

Viewing Student Enrollment Summaries

Access the Enrollment Summary page (**Records and Enrollment > Enrollment Summaries > Enrollment Summary > Enrollment Summary**).

View all classes in which a student is successfully enrolled for the term.

Field or Control	Description
	Click the Course Detail button to access the Class Detail page, where you can view details about the class listed on the Enrollment Summary page.
Print Study List	Click to print the student's enrollment summary.

Related Links

[Processing Enrollment Transactions Through Self Service](#)

Viewing Term Statistics

Access the Term History - Term Statistics page (**Records and Enrollment > Student Term Information > Term History > Term Statistics**).

This example illustrates the fields and controls on the Term History - Term Statistics page (1 of 2). You can find definitions for the fields and controls later on this page.

Term Statistics							
Edward Nolan		SR0431		★			
Find View All First 1 of 1 Last							
Academic Career: Undergraduate							
Find View All First 1 of 19 Last							
Institution: PeopleSoft University		Academic Level - Term Start: Sophomore					
Term: 0600 2008 Spring							
Enrollments							
	Graded Units	Grade Points	GPA	Earned Units	In Progress Units		
						Units Taken Towards Acad Load	14.000
						Units Earned Towards Acad Load	7.000
						Units Taken For Audit	3.000
For GPA	7.000	16.000	2.286	4.000	4.000		
Not For GPA	3.000			3.000	0.000		

This example illustrates the fields and controls on the Term History - Term Statistics page (2 of 2). You can find definitions for the fields and controls later on this page.

Transfer Credit							
	Graded Units	Grade Points	GPA	Earned Units	In Progress Units		
						Graded Transfer Units GPA / No GPA For Units Only	3.000
For GPA	3.000	9.000	3.000	3.000		Units Adjustment	0.000
Not For GPA	0.000			0.000		>>> Total Adjusted Transferred Units	6.000
Combined (Enrollment + Transfer Credit Units)							
	Graded Units	Grade Points	GPA	Earned Units	In Progress Units		
						Combined Earned Units GPA / No GPA Transfer Credit For Units Only	10.000
For GPA	10.000	25.000	2.500	7.000	4.000	Transfer Credit Units Adjustment	0.000
Not For GPA	3.000			3.000	0.000	>>> Total Term Units	13.000

View enrollment and transfer credit statistics for all terms in which the student has been or is enrolled. You can view this information for an individual term in the Enrollment Summary component.

Summary of Student Enrollment for the Term

The following information refers to the example screen shot:

- 4 Units with Grade A (for GPA) – 16 grade points
- 3 Units with Grade F (for GPA) – 0 grade points
- 3 Units with Grade Pass (Not For GPA)
- 4 Units with no grade (in progress) (class will be For GPA after grading)
- 3 Units with an Audit grade basis

Enrollments

Field or Control	Description
Graded Units - For GPA (graded units - for grade point average)	Displays the total number of units that are taken for a grade (A, B, C, D, F) and accumulate in the GPA.
Graded Units - Not For GPA (graded units - not for grade point average)	Displays the total number of units that are taken for a grade (Pass, Fail, Satisfactory, Unsatisfactory) and do not accumulate in the GPA. Note: The Graded Units - For GPA and Graded Units - Not for GPA fields do not include classes that are in a withdrawn status and classes that are taken with the audit grade basis.
Grade Points - For GPA (grade points - for grade point average)	Displays a number that is calculated by taking the grade points received for each grade (on a 4-point grading scale, an A equals 4 points), and multiplying that number by the number of units taken for each class for which a grade accumulates in the GPA.
GPA - For GPA (grade point average - for grade point average)	Displays the grade point average which is calculated by dividing the grade points for GPA by the graded units for GPA. Use the GPA Rounding/Truncating Option field on the Student Records Installation page (Set Up SACR, Install, Student Records Installation) to indicate to how many decimal places you want to round or truncate the grade point average. Note: No values appear in the Not For GPA row for the Grade Points and GPA fields.
Earned Units - For GPA (earned units - for grade point average)	Displays the total number of units that are passed with an earned credit grade (A, B, C, D) and accumulate in the GPA.
Earned Units - Not For GPA (earned units - not for grade point average)	Displays the total number of units that are passed with an earned credit grade (Pass, Satisfactory) and do not accumulate in the GPA.
In Progress Units - For GPA (in progress units - for grade point average)	Displays the total number of units that are not yet completed and for which the future assigned grade will accumulate in the GPA.
In Progress Units - Not For GPA (in progress units - not for grade point average)	Displays the total number of units that are not yet completed and for which the future assigned grade will not accumulate in the GPA.

Field or Control	Description
Units Taken Towards Acad Load (units taken towards academic load)	Displays the total number of units taken for progress. This total is used in Student Records to determine academic load.
Units Earned Towards Acad Load (units earned towards academic load)	<p>Displays the total number of units passed for progress. This total is used in Student Records to determine academic load and academic level.</p> <hr/> <p>Note: For Units Taken Towards Acad Load and Units Earned Towards Acad Load, the units are summed regardless of academic load determiner set on Level/Load Rules.</p> <hr/>
Units Taken For Audit	Displays the total number of audit units taken for the term.

Summary of Student Transfer Credit for Term

The following information refers to the example screen shot:

- 3 Units with Grade B (for GPA) for a model where the **Include in GPA** check box is selected on the Transfer Course Entry page.
- 3 Units with Grade T for a model where the **Include in GPA** check box is cleared on the Transfer Course Entry page.

Transfer Credit

The statistics in this group box include both internal and external transfer credits.

Field or Control	Description
Graded Units - For GPA (graded units - for grade point average)	Displays the total number of units that are transferred for a grade (A, B, C, D, F) and accumulate in the GPA for models where the Include in GPA check box is selected on the Transfer Course Entry page.
Graded Units - Not For GPA (graded units - not for grade point average)	Displays the total number of units that are transferred for a grade (T) and do not accumulate in the GPA for models where the Include in GPA check box is selected on the Transfer Course Entry page.

Field or Control	Description
Grade Points - For GPA (grade points - for grade point average)	Displays a number that is calculated by taking the grade points received for each grade (on a 4-point grading scale, an A equals 4 points), and multiplying that number by the number of units taken for each transferred class for which a grade accumulates in the GPA.
GPA - For GPA (grade point average - for grade point average)	<p>Displays the grade point average which is calculated by dividing the grade points for GPA by the graded units for GPA.</p> <p>Use the GPA Rounding/Truncating Option field on the Student Records Installation page (Set Up SACR, Install, Student Records Installation) to indicate to how many decimal places you want to round or truncate the grade point average.</p> <hr/> <p>Note: No values appear in the Not For GPA row for the Grade Points and GPA fields.</p> <hr/>
Earned Units - For GPA (earned units - for grade point average)	Displays the total number of transferred units that are passed with an earned credit grade (A, B, C, D) and accumulate in the GPA for models where the Include in GPA check box is selected on the Transfer Course Entry page.
Earned Units - Not For GPA (earned units - not for grade point average)	Displays the total number of transferred units that are passed with an earned credit grade (T) and do not accumulate in the GPA for models where the Include in GPA check box is selected on the Transfer Course Entry page.
Graded Transferred Units GPA / No GPA (graded transferred units for grade point average / not for grade point average)	Displays the sum of transferred units for which received grades both accumulate and do not accumulate in the GPA for models where the Include in GPA check box is selected on the Transfer Course Entry page.
For Units Only	Displays the total number of transferred units that are passed with an earned credit grade and do not accumulate in the GPA for models where the Include in GPA check box is cleared on the Transfer Course Entry page.
Units Adjustment	<p>Displays the total number of units that were manually removed from the student's overall transfer credit units. This field is updated on the Terms in Residence page in the Term Activation component.</p> <hr/> <p>Note: This number displays as a positive value, but is stored as a negative value.</p> <hr/>

Field or Control	Description
Total Adjusted Transferred Units	Displays the sum of graded transfer units (for GPA and not for GPA), plus the value in the Units Only field, minus the value in the Units Adjustment field.

Combined (Enrollment + Transfer Credit Units)

Field or Control	Description
Graded Units - For GPA (graded units - for grade point average)	Displays the sum of all enrollment and transfer credit units that are taken and transferred for a grade (A, B, C, D, F) and accumulate in the GPA.
Graded Units - Not For GPA (graded units - not for grade point average)	Displays the sum of all enrollment and transfer credit units that are taken and transferred for a grade (Pass, Fail, Satisfactory, Unsatisfactory, T) and do not accumulate in the GPA.
Grade Points - For GPA (grade points - for grade point average)	Displays the sum of all grade points for enrollment and transfer credit units that accumulate in the GPA.
GPA - For GPA (grade point average - for grade point average)	<p>Displays the grade point average which is calculated by dividing the grade points for GPA by the graded units for GPA.</p> <p>Use the GPA Rounding/Truncating Option field on the Student Records Installation page (Set Up SACR, Install, Student Records Installation) to indicate to how many decimal places you want to round or to truncate the grade point average.</p> <hr/> <p>Note: No values appear in the Not For GPA row for the Grade Points and GPA fields.</p> <hr/>
Earned Units - For GPA (earned units - for grade point average)	Displays the sum of all enrollment and transfer credit units that are passed with an earned credit grade (A, B, C, D) and accumulate in the GPA.
Earned Units - Not For GPA (earned units - not for grade point average)	Displays the sum of all enrollment and transfer credit units that are passed with an earned credit grade (Pass, Satisfactory, T) and do not accumulate in the GPA.
In Progress Units - For GPA (in progress units - not for grade point average)	Displays the total number of units that are not yet completed and for which the future assigned grade will accumulate in the GPA.

Field or Control	Description
In Progress Units - Not For GPA (in progress units - not for grade point average)	Displays the total number of units that are not yet completed and for which the future assigned grade will not accumulate in the GPA.
Combined Earned Unit GPA/ No GPA (combined earned unit for grade point average / not for grade point average)	Displays the sum of all enrollment and transfer credit units that are passed with an earned credit grade, including both those that accumulate and do not accumulate in the GPA.
Transfer Credit For Units Only	Displays the sum of transferred units that are passed with an earned credit grade and do not accumulate in the GPA for models where the Include in GPA check box is cleared on the Transfer Course Entry page.
Transfer Credit Units Adjustment	Displays the number of units that were manually removed from the student's overall transfer credit units.
Total Term Units	Displays the sum of all enrollment and transfer credit units that are passed with an earned credit grade, including both those that accumulate and do not accumulate in the GPA, plus transfer credit units that are passed with an earned credit grade that do not accumulate in the GPA for models where the Include in GPA check box is cleared, minus the number of units that were manually removed from the student's overall transfer credit units. Units taken for audit are excluded from this total.

Calculating Term Statistic Values

Use the following table to understand how term statistic values are calculated.

Term Statistics Page Field	Field from STDNT_CAR_TERM	Calculation
ENROLLMENT		
Graded Units - For GPA	UNT_TAKEN_GPA	Sum of UNT_TAKEN from STDNT_ENRL where AUDIT_GRADE_BASIS = N, UNITS_ATTEMPTED = Y, INCLUDE_IN_GPA = Y, EARN_CREDIT = n/a

Term Statistics Page Field	Field from STDNT_CAR_TERM	Calculation
Graded Units - Not For GPA	UNT_TAKEN_NOGPA	Sum of UNT_TAKEN from STDNT_ENRL where AUDIT_GRADE_BASIS = N, UNITS_ATTEMPTED = Y, INCLUDE_IN_GPA = N, EARN_CREDIT = n/a
Grade Points - For GPA	GRADE_POINTS	Sum of GRADE_POINTS from STDNT_ENRL where AUDIT_GRADE_BASIS = N, UNITS_ATTEMPTED = Y, INCLUDE_IN_GPA = Y, EARN_CREDIT = n/a
GPA - For GPA	CUR_GPA	GRADE_POINTS / UNT_TAKEN_GPA
Earned Units - For GPA	UNT_PASSD_GPA	Sum of UNT_EARNED from STDNT_ENRL where AUDIT_GRADE_BASIS = N, UNITS_ATTEMPTED = Y, INCLUDE_IN_GPA = Y, EARN_CREDIT = Y
Earned Units - Not For GPA	UNT_PASSD_NOGPA	Sum of UNT_EARNED from STDNT_ENRL where AUDIT_GRADE_BASIS = N, UNITS_ATTEMPTED = Y, INCLUDE_IN_GPA = N, EARN_CREDIT = Y

Term Statistics Page Field	Field from STDNT_CAR_TERM	Calculation
In-Progress Units - For GPA	UNT_INPROG_GPA	Sum of UNT_TAKEN from STDNT_ENRL where AUDIT_GRADE_BASIS = N, UNITS_ATTEMPTED = I, INCLUDE_IN_GPA = Y, EARN_CREDIT = n/a
In-Progress Units - Not For GPA	UNT_INPROG_NOGPA	Sum of UNT_TAKEN from STDNT_ENRL where AUDIT_GRADE_BASIS = N, UNITS_ATTEMPTED = I, INCLUDE_IN_GPA = N, EARN_CREDIT = n/a
Units Taken Towards Acad Load	UNT_TAKEN_PRGRSS	UNT_TAKEN_GPA + UNT_TAKEN_NOGPA + UNT_INPROG_GPA + UNT_INPROG_NOGPA Sum of UNT_PRGRSS from STDNT_ENRL where AUDIT_GRADE_BASIS = N, UNITS_ATTEMPTED = I or Y, INCLUDE_IN_GPA = n/a, EARN_CREDIT = n/a
Units Earned Towards Acad Load	UNT_PASSD_PRGRSS	UNT_PASSD_GPA + UNT_PASSD_NOGPA Sum of UNT_PRGRSS from STDNT_ENRL where AUDIT_GRADE_BASIS = N, UNITS_ATTEMPTED = Y, INCLUDE_IN_GPA = Y, EARN_CREDIT = Y

Term Statistics Page Field	Field from STDNT_CAR_TERM	Calculation
Units Taken For Audit	UNT_AUDIT	Sum of UNT_PRGRSS from STDNT_ENRL where AUDIT_GRADE_BASIS = Y, UNITS_ATTEMPTED = n/a, INCLUDE_IN_GPA = n/a, EARN_CREDIT = n/a
TRANSFER CREDIT		

Term Statistics Page Field	Field from STDNT_CAR_TERM	Calculation
Graded Units - For GPA	TRF_TAKEN_GPA	<p>Course Credits:</p> <p>1. Internal Transfer (TRNS_CRSE_SCH.TRNSFR_SRC_TYPE = I)</p> <p>Sum of UNIT_TRNSFR from TRNS_CRSE_DTL where</p> <p>UNITS_ATTEMPTED = Y,</p> <p>INCLUDE_IN_GPA = Y,</p> <p>EARN_CREDIT = n/a</p> <p>2. External Transfer (TRNS_CRSE_SCH.TRNSFR_SRC_TYPE =E)</p> <p>Sum of UNIT_TRNSFR from TRNS_CRSE_DTL where</p> <p>ORG_INST_TBL.TRNSFR_CR_INCL_GPA = Y,</p> <p>UNITS_ATTEMPTED = Y,</p> <p>INCLUDE_IN_GPA = Y,</p> <p>EARN_CREDIT = n/a</p> <p>3. Manual Transfer (TRNS_CRSE_SCH.TRNSFR_SRC_TYPE =M)</p> <p>Sum of UNIT_TRNSFR from TRNS_CRSE_DTL where</p> <p>TRNS_CRSE_SCH.INCLUDE_IN_GPA = Y,</p> <p>UNITS_ATTEMPTED = Y,</p> <p>INCLUDE_IN_GPA = Y,</p> <p>EARN_CREDIT = n/a</p> <p>Test Credits:</p> <p>Sum of UNIT_TRNSFR from TRNS_TEST_DTL where</p> <p>TRNS_TEST_MODEL.INCLUDE_IN_GPA = Y,</p> <p>UNITS_ATTEMPTED = Y,</p> <p>INCLUDE_IN_GPA = Y,</p> <p>EARN_CREDIT = n/a</p> <p>Other Credits:</p>

Term Statistics Page Field	Field from STDNT_CAR_TERM	Calculation
		Sum of UNIT_TRNSFR from TRNS_OTHR_DTL where TRNS_OTHR_MODEL.INCLUDE_IN_GPA = Y, UNITS_ATTEMPTED = Y, INCLUDE_IN_GPA = Y, EARN_CREDIT = n/a

Term Statistics Page Field	Field from STDNT_CAR_TERM	Calculation
Graded Units - Not For GPA	TRF_TAKEN_NOGPA	<p>Course Credits:</p> <p>1. Internal Transfer (TRNS_CRSE_SCH.TRNSFR_SRC_TYPE = I)</p> <p>Sum of UNIT_TRNSFR from TRNS_CRSE_DTL where</p> <p>UNITS_ATTEMPTED = Y,</p> <p>INCLUDE_IN_GPA = N,</p> <p>EARN_CREDIT = n/a</p> <p>2. External Transfer (TRNS_CRSE_SCH.TRNSFR_SRC_TYPE =E)</p> <p>Sum of UNIT_TRNSFR from TRNS_CRSE_DTL where</p> <p>ORG_INST_TBL.TRNSFR_CR_INCL_GPA = Y,</p> <p>UNITS_ATTEMPTED = Y,</p> <p>INCLUDE_IN_GPA = N,</p> <p>EARN_CREDIT = n/a</p> <p>3. Manual Transfer (TRNS_CRSE_SCH.TRNSFR_SRC_TYPE =M)</p> <p>Sum of UNIT_TRNSFR from TRNS_CRSE_DTL where TRNS_CRSE_SCH.INCLUDE_IN_GPA = Y,</p> <p>UNITS_ATTEMPTED = Y,</p> <p>INCLUDE_IN_GPA = N,</p> <p>EARN_CREDIT = n/a</p> <p>Test Credits:</p> <p>Sum of UNIT_TRNSFR from TRNS_TEST_DTL where</p> <p>TRNS_TEST_MODEL.INCLUDE_IN_GPA = Y,</p> <p>UNITS_ATTEMPTED = Y,</p> <p>INCLUDE_IN_GPA = N,</p> <p>EARN_CREDIT = n/a</p> <p>Other Credits:</p> <p>Sum of UNIT_TRNSFR from TRNS_OTHR_DTL where</p>

Term Statistics Page Field	Field from STDNT_CAR_TERM	Calculation
		TRNS_OTHR_MODEL.INCLUDE_IN_GPA = Y, UNITS_ATTEMPTED = Y, INCLUDE_IN_GPA = N, EARN_CREDIT = n/a

Term Statistics Page Field	Field from STDNT_CAR_TERM	Calculation
Grade Points - For GPA	TRF_GRADE_POINTS	<p>Course Credits:</p> <p>1. Internal Transfer (TRNS_CRSE_SCH.TRNSFR_SRC_TYPE = I)</p> <p>Sum of (UNIT_TRNSFR * GRD_PTS_PER_UNIT) from TRNS_CRSE_DTL where</p> <p>UNITS_ATTEMPTED = Y,</p> <p>INCLUDE_IN_GPA = Y,</p> <p>EARN_CREDIT = n/a</p> <p>2. External Transfer (TRNS_CRSE_SCH.TRNSFR_SRC_TYPE =E)</p> <p>Sum of (UNIT_TRNSFR * GRD_PTS_PER_UNIT) from TRNS_CRSE_DTL where</p> <p>ORG_INST_TBL.TRNSFR_CR_INCL_GPA = Y,</p> <p>UNITS_ATTEMPTED = Y,</p> <p>INCLUDE_IN_GPA = Y,</p> <p>EARN_CREDIT = n/a</p> <p>3. Manual Transfer (TRNS_CRSE_SCH.TRNSFR_SRC_TYPE =M)</p> <p>Sum of (UNIT_TRNSFR * GRD_PTS_PER_UNIT) from TRNS_CRSE_DTL where</p> <p>TRNS_CRSE_SCH.INCLUDE_IN_GPA = Y,</p> <p>UNITS_ATTEMPTED = Y,</p> <p>INCLUDE_IN_GPA = Y,</p> <p>EARN_CREDIT = n/a</p> <p>Test Credits:</p> <p>Sum of (UNIT_TRNSFR * GRD_PTS_PER_UNIT) from TRNS_TEST_DTL where</p> <p>TRNS_TEST_MODEL.INCLUDE_IN_GPA = Y,</p> <p>UNITS_ATTEMPTED = Y,</p> <p>INCLUDE_IN_GPA = Y,</p> <p>EARN_CREDIT = n/a</p>

Term Statistics Page Field	Field from STDNT_CAR_TERM	Calculation
		Other Credits: Sum of (UNIT_TRNSFR * GRD_PTS_PER_UNIT) from TRNS_OTHR_DTL where TRNS_OTHR_MODEL.INCLUDE_IN_GPA = Y, UNITS_ATTEMPTED = Y, INCLUDE_IN_GPA = Y, EARN_CREDIT = n/a
GPA - For GPA	SSR_TRF_CUR_GPA	TRF_GRADE_POINTS / TRF_TAKEN_GPA

Term Statistics Page Field	Field from STDNT_CAR_TERM	Calculation
Earned Units - For GPA	TRF_PASSED_GPA	<p>Course Credit</p> <p>1. Internal Transfer (TRNS_CRSE_SCH.TRNSFR_SRC_TYPE = I)</p> <p>Sum of UNIT_TRNSFR from TRNS_CRSE_DTL where</p> <p>UNITS_ATTEMPTED = Y,</p> <p>INCLUDE_IN_GPA = Y,</p> <p>EARN_CREDIT = Y</p> <p>2. External Transfer (TRNS_CRSE_SCH.TRNSFR_SRC_TYPE =E)</p> <p>Sum of UNIT_TRNSFR from TRNS_CRSE_DTL where</p> <p>ORG_INST_TBL.TRNSFR_CR_INCL_GPA = Y,</p> <p>UNITS_ATTEMPTED = Y,</p> <p>INCLUDE_IN_GPA = Y,</p> <p>EARN_CREDIT = Y</p> <p>3. Manual Transfer (TRNS_CRSE_SCH.TRNSFR_SRC_TYPE =M)</p> <p>Sum of UNIT_TRNSFR from TRNS_CRSE_DTL where</p> <p>TRNS_CRSE_SCH.INCLUDE_IN_GPA = Y,</p> <p>UNITS_ATTEMPTED = Y,</p> <p>INCLUDE_IN_GPA = Y,</p> <p>EARN_CREDIT = Y</p> <p>Test Credits:</p> <p>Sum of UNIT_TRNSFR from TRNS_TEST_DTL where</p> <p>TRNS_TEST_MODEL.INCLUDE_IN_GPA = Y,</p> <p>UNITS_ATTEMPTED = Y,</p> <p>INCLUDE_IN_GPA = Y,</p> <p>EARN_CREDIT = Y</p> <p>Other Credits:</p>

Term Statistics Page Field	Field from STDNT_CAR_TERM	Calculation
		Sum of UNIT_TRNSFR from TRNS_OTHR_DTL where TRNS_OTHR_MODEL.INCLUDE_IN_GPA = Y, UNITS_ATTEMPTED = Y, INCLUDE_IN_GPA = Y, EARN_CREDIT = Y

Term Statistics Page Field	Field from STDNT_CAR_TERM	Calculation
Earned Units - Not For GPA	TRF_PASSED_NOGPA	<p>Course Credits:</p> <p>1. Internal Transfer (TRNS_CRSE_SCH.TRNSFR_SRC_TYPE = I)</p> <p>Sum of UNIT_TRNSFR from TRNS_CRSE_DTL where</p> <p>UNITS_ATTEMPTED = Y,</p> <p>INCLUDE_IN_GPA = N,</p> <p>EARN_CREDIT = Y</p> <p>2. External Transfer (TRNS_CRSE_SCH.TRNSFR_SRC_TYPE = E)</p> <p>Sum of UNIT_TRNSFR from TRNS_CRSE_DTL where</p> <p>ORG_INST_TBL.TRNSFR_CR_INCL_GPA = Y,</p> <p>UNITS_ATTEMPTED = Y,</p> <p>INCLUDE_IN_GPA = N,</p> <p>EARN_CREDIT = Y</p> <p>3. Manual Transfer (TRNS_CRSE_SCH.TRNSFR_SRC_TYPE = M)</p> <p>Sum of UNIT_TRNSFR from TRNS_CRSE_DTL where</p> <p>TRNS_CRSE_SCH.INCLUDE_IN_GPA = Y,</p> <p>UNITS_ATTEMPTED = Y,</p> <p>INCLUDE_IN_GPA = N,</p> <p>EARN_CREDIT = Y</p> <p>Test Credits:</p> <p>Sum of UNIT_TRNSFR from TRNS_TEST_DTL where</p> <p>TRNS_TEST_MODEL.INCLUDE_IN_GPA = Y,</p> <p>UNITS_ATTEMPTED = Y,</p> <p>INCLUDE_IN_GPA = N,</p> <p>EARN_CREDIT = Y</p> <p>Other Credits:</p>

Term Statistics Page Field	Field from STDNT_CAR_TERM	Calculation
		Sum of UNIT_TRNSFR from TRNS_OTHR_DTL where TRNS_OTHR_MODEL.INCLUDE_IN_GPA = Y, UNITS_ATTEMPTED = Y, INCLUDE_IN_GPA = N, EARN_CREDIT = Y
Graded Transferred Units GPA / No GPA	DERIVED	TRF_TAKEN_GPA+ TRF_TAKEN_NOGPA
For Units Only	DERIVED	UNT_TRNSFR + UNT_TEST_CREDIT + UNT_OTHER
Units Adjustment	TC_UNITS_ADJUST	As entered on Terms of Residence page
Total Adjusted Transferred Units	DERIVED	(TRF_TAKEN_GPA+ TRF_TAKEN_NOGPA) + (UNT_TRNSFR + UNT_TEST_CREDIT + UNT_OTHER) - TC_UNITS_ADJUST
COMBINED UNITS		
Graded Units - For GPA	DERIVED	UNT_TAKEN_GPA + TRF_TAKEN_GPA
Graded Units - Not For GPA	DERIVED	UNT_TAKEN_NOGPA+ TRF_TAKEN_NOGPA
Grade Points - For GPA	DERIVED	GRADE_POINTS + TRF_GRADE_POINTS
GPA - For GPA	SSR_COMB_CUR_GPA	(GRADE_POINTS + TRF_GRADE_POINTS) / (UNT_TAKEN_GPA + TRF_TAKEN_GPA)
Earned Units - For GPA	DERIVED	UNT_PASSD_GPA + TRF_PASSED_GPA
Earned Units - Not for GPA	DERIVED	UNT_PASSD_NOGPA+ TRF_PASSED_NOGPA

Term Statistics Page Field	Field from STDNT_CAR_TERM	Calculation
In Progress Units - For GPA	UNT_INPROG_GPA	Sum of UNT_TAKEN from STDNT_ENRL where AUDIT_GRADE_BASIS = N, UNITS_ATTEMPTED = I, INCLUDE_IN_GPA = Y, EARN_CREDIT = n/a
In Progress Units - Not For GPA	UNT_INPROG_NOGPA	Sum of UNT_TAKEN from STDNT_ENRL where AUDIT_GRADE_BASIS = N, UNITS_ATTEMPTED = I, INCLUDE_IN_GPA = N, EARN_CREDIT = n/a
Combined Earned Unit GPA/ No GPA	DERIVED	(UNT_PASSD_GPA + TRF_PASSED_GPA) + (UNT_PASSD_NOGPA + TRF_PASSED_NOGPA)
Transfer Credit For Units Only	DERIVED	UNT_TRNSFR + UNT_TEST_CREDIT + UNT_OTHER
Transfer Credit Units Adjustment	TC_UNITS_ADJUST	As entered on Terms of Residence page
Total Term Units	UNT_TERM_TOT	((UNT_PASSD_GPA + TRF_PASSED_GPA) + (UNT_PASSD_NOGPA + TRF_PASSED_NOGPA)) + (UNT_TRNSFR + UNT_TEST_CREDIT + UNT_OTHER) - TC_UNITS_ADJUST

Viewing Cumulative Statistics for Multiple Terms

Access the Cumulative Statistics page (**Records and Enrollment > Student Term Information > Term History > Cumulative Statistics**).

This example illustrates the fields and controls on the Cumulative Statistics page (1 of 2). You can find definitions for the fields and controls later on this page.

Term Statistics		Cumulative Statistics		Term Withdrawal		Session Withdrawal		Academic Standing	
Edward Nolan				SR0431		★			
Find View All First 1 of 1 Last									
Academic Career:		Undergraduate							
Find View All First 1 of 19 Last									
Institution:		PeopleSoft University			Academic Level - Term End:		Sophomore		
Term:		0600 2008 Spring			Reset Cum Stats at Term Start:		<input type="checkbox"/>		
Enrollments									
	Grade Units	Grade Points	GPA	Earned Units	In Progress Units	Units Taken Towards Acad Load		52.000	
						Units Earned Towards Acad Load		42.000	
For GPA	42.000	127.000	3.024	39.000	7.000	Units Taken For Audit		3.000	
Not For GPA	3.000			3.000	0.000				

This example illustrates the fields and controls on the Cumulative Statistics page (2 of 2). You can find definitions for the fields and controls later on this page.

Transfer Credit									
	Graded Units	Grade Points	GPA	Earned Units	Graded Transfer Units GPA / No GPA				
					For Units Only				
For GPA	3.000	9.000	3.000	3.000	Units Adjustment				
Not For GPA	0.000			0.000	>>> Total Adjusted Transferred Units				
>>> 6.000									
Combined (Enrollment + Transfer Credit Units)									
	Graded Units	Grade Points	GPA	Earned Units	In Progress Units	Combined Earned Units GPA / No GPA			
						Transfer Credit For Units Only			
For GPA	45.000	136.000	3.022	42.000	7.000	Transfer Credit Units Adjustment			
Not For GPA	3.000			3.000	0.000	>>> Total Cumulative Units			
>>> 48.000									

This page displays running cumulative totals by term.

Enrollments

<i>Field or Control</i>	<i>Description</i>
Units Taken for Audit	Displays the total cumulative audit units taken.

Note: All other field definitions are the same as the definitions for the fields in the **Enrollments** group box on the Term Statistics page.

Note: RESET_CUM_STATS triggers a reset in cumulative computation.

Transfer Credit

All field definitions are the same as the definitions for the fields in the **Transfer Credit** group box on the Term Statistics page.

Combined (Enrollment + Transfer Credit Units)

<i>Field or Control</i>	<i>Description</i>
Total Cumulative Units	Displays the sum of all enrollment and transfer credit units that are passed with an earned credit grade, including both those accumulated and not accumulated in the GPA, plus transfer credit units that are passed with an earned credit grade and do not accumulate in the GPA for models where Include in GPA check box is cleared, minus the number of units that were manually removed from the student's overall transfer credit units. Units taken for audit are excluded from this total.

All other field definitions are the same as the definitions for the fields in the **Combined (Enrollment + Transfer Credit Units)** group box on the Term Statistics page.

Calculating Cumulative Statistic Values

Use the following table to understand how cumulative statistic values are calculated.

<i>Cumulative Statistics Page Field</i>	<i>Field from STDNT_CAR_TERM</i>	<i>Calculation</i>
ENROLLMENT		
Graded Units - For GPA	SSR_TOT_EN_TKN_GPA	Cumulative sum of UNT_TAKEN_GPA
Graded Units - Not For GPA	DERIVED	Cumulative sum of UNT_TAKEN_NOGPA
Grade Points - For GPA	SSR_TOT_EN_GRDPTS	Cumulative sum of GRADE_POINTS
GPA - For GPA	SSR_CUM_EN_GPA	$SSR_TOT_EN_GRDPTS / SSR_TOT_EN_TKNGPA$
Earned Units - For GPA	DERIVED	Cumulative sum of UNT_PASSD_GPA
Earned Units - Not For GPA	DERIVED	Cumulative sum of UNT_PASSD_NOGPA
In-Progress Units - For GPA	TOT_INPROG_GPA	Cumulative sum of UNT_INPROG_GPA

Cumulative Statistics Page Field	Field from STDNT_CAR_TERM	Calculation
In-Progress Units - Not For GPA	TOT_INPROG_NOGPA	Cumulative sum of UNT_INPROG_NOGPA
Units Taken Towards Acad Load	DERIVED	Cumulative sum of UNT_TAKEN_PRGRSS
Units Earned Towards Acad Load	DERIVED	Cumulative sum of UNT_PASSED_PRGRSS
Units Taken For Audit	TOT_AUDIT	Cumulative sum of UNT_AUDIT
TRANSFER CREDIT		
Graded Units - For GPA	SSR_TOT_TR_TKNGPA	Cumulative sum of TRF_TAKEN_GPA
Graded Units - Not For GPA	DERIVED	Cumulative sum of TRF_TAKEN_NOGPA
Grade Points - For GPA	SSR_TOT_TR_GRDPTS	Cumulative sum of TRF_GRADE_POINTS
GPA - For GPA	SSR_CUM_TR_GPA	$SSR_TOT_TR_GRDPTS / SSR_TOT_TR_TKNGPA$
Earned Units - For GPA	DERIVED	Cumulative sum of TRF_PASSED_GPA
Earned Units - Not For GPA	DERIVED	Cumulative sum of TRF_PASSED_NOGPA
Graded Transferred Units GPA / No GPA	DERIVED	$SSR_TOT_TR_TKNGPA +$ Cumulative sum of TRF_TAKEN_NOGPA
For Units Only	DERIVED	$TOT_TRNSFR + TOT_TEST_CREDIT + TOT_OTHER$
Units Adjustment	DERIVED	Cumulative sum of TC_UNITS_ADJUST
Total Adjusted Transferred Units	DERIVED	$SSR_TOT_TR_TKNGPA +$ Cumulative sum of TRF_TAKEN_NOGPA) + (TOT_TRNSFR + TOT_TEST_CREDIT + TOT_OTHER) – Cumulative sum of TC_UNITS_ADJUST
COMBINED UNITS		

Cumulative Statistics Page Field	Field from STDNT_CAR_TERM	Calculation
Graded Units - For GPA	TOT_TAKEN_GPA	SSR_TOT_EN_TKN_GPA + SSR_TOT_TR_TKNGPA
Graded Units - Not For GPA	TOT_TAKEN_NOGPA	Cumulative sum of UNT_TAKEN_NOGPA + Cumulative sum of TRF_TAKEN_NOGPA
Grade Points - For GPA	TOT_GRADE_POINTS	SSR_TOT_EN_GRDPTS + SSR_TOT_TR_GRDPTS
GPA - For GPA	CUM_GPA	$(SSR_TOT_EN_GRDPTS + SSR_TOT_TR_GRDPTS) / (SSR_TOT_EN_TKN_GPA + SSR_TOT_TR_TKNGPA)$
Earned Units - For GPA	TOT_PASSD_GPA	Cumulative sum of UNT_PASSD_GPA + Cumulative sum of TRF_PASSED_GPA
Earned Units - Not for GPA	TOT_PASSD_NOGPA	Cumulative sum of UNT_PASSD_NOGPA + Cumulative sum of TRF_PASSED_NOGPA
In Progress Units - For GPA	TOT_INPROG_GPA	Cumulative sum of UNT_INPROG_GPA
In Progress Units - Not For GPA	TOT_INPROG_NOGPA	Cumulative sum of UNT_INPROG_NOGPA
Combined Earned Unit GPA/ No GPA	DERIVED	$(\text{Cumulative sum of UNT_PASSD_GPA} + \text{Cumulative sum of TRF_PASSED_GPA}) + (\text{Cumulative sum of UNT_PASSD_NOGPA} + \text{Cumulative sum of TRF_PASSED_NOGPA})$
Transfer Credit For Units Only	DERIVED	TOT_TRNSFR + TOT_TEST_CREDIT + TOT_OTHER
Transfer Credit Units Adjustment	DERIVED	Cumulative sum of TC_UNITS_ADJUST
Total Cumulative Units	TOT_CUMULATIVE	Sum of TOT_PASSD_GPA + TOT_PASSD_NOGPA + TOT_TRNSFR + TOT_TEST_CREDIT + TOT_OTHER - (Cumulative Sum of TC_UNITS_ADJUST)

Viewing Student Terms

Access the Student Term Search page (**Records and Enrollment > Career and Program Information > Student Term Search > Student Term Search**).

<i>Field or Control</i>	<i>Description</i>
Academic Career	Every academic career for which the student has been active for a term.
Term	Every term in which the student has been active.
Academic Institution	The academic institution at which the student has been term active.
Eligible To Enroll	The student's eligibility to enroll in the specified academic career and term at an academic institution, according to the value of the corresponding field on the Term Activation page.

Viewing Student Class and Exam Schedules Using Self-Service Pages

If your institution has licensed PeopleSoft Campus Self Service, your students can view their class schedule and scheduled exams over the web.

Related Links

“Viewing a Class Schedule” (Campus Self Service)

Viewing Class Rosters

This section discusses how to view class rosters.

Page Used to View Class Rosters

<i>Page Name</i>	<i>Definition Name</i>	<i>Navigation</i>	<i>Usage</i>
Class Roster	CLASS_ROSTER	Curriculum Management > Class Roster > Class Roster	View the students who are enrolled in a class, have dropped a class, or are on the wait list for a class.

Viewing Class Rosters

Access the Class Roster page (**Curriculum Management > Class Roster > Class Roster > Class Roster**).

This example illustrates the fields and controls on the Class Roster page (1 of 2). You can find definitions for the fields and controls later on this page.

Class Roster

2010 Spring | Regular Academic Session | PeopleSoft University | Undergraduate

▼ **ENGLIT 120 - 1 (1176)**

Anglo-Saxon English Literature (Lecture)

Days and Times	Room	Instructor	Dates
MoWeFr 11:00AM-11:50AM	TBA	Staff	01/24/2010 - 05/08/2010

***Enrollment Status:** Enrolled ▼

Enrollment Capacity: 999 **Enrolled:** 531

Enrolled Students		Customize Find		First 1-531 of 531 Last		
Select	ID	Abarri, Dana S	Grade Basis	Units	Program and Plan	Level
1	FAPK0157	Abarri, Dana S	Graded	13.00	Liberal Arts Undergraduate - Undeclared Undergraduate	Freshman
2	<input type="checkbox"/>	FAD0010 Abney, Safura	Graded	12.00	Liberal Arts Undergraduate - Mathematics (BA)	Freshman
3	FAPK0184	Abrams, Karen A	Graded	13.00	Liberal Arts Undergraduate - Undeclared Undergraduate	Freshman
4	<input type="checkbox"/>	FAAG0067 Aditya, Billton	Graded	12.00	Liberal Arts Undergraduate - Undeclared Undergraduate	Freshman
5	FAPK0131	Ambrose, Pete F	Graded	13.00	Liberal Arts Undergraduate - Undeclared Undergraduate	Freshman
6	FAPK0136	Andrews, Cindy L	Graded	13.00	Liberal Arts Undergraduate - Undeclared Undergraduate	Freshman
7	FAPK0186	Anthony, George D	Graded	13.00	Liberal Arts Undergraduate - Undeclared Undergraduate	Freshman
8	<input type="checkbox"/>	FAAG0017 Austin, Gavin G	Graded	12.00	Liberal Arts Undergraduate - Undeclared Undergraduate	Freshman

This example illustrates the fields and controls on the Class Roster page (2 of 2). You can find definitions for the fields and controls later on this page.

528	<input type="checkbox"/>	FAPK0395	Zepeda, Gerald U	Graded	13.00	Liberal Arts Undergraduate - Undeclared Undergraduate	Freshman
529	<input type="checkbox"/>	FAPK0396	Ziegler, Llyod I	Graded	13.00	Liberal Arts Undergraduate - Undeclared Undergraduate	Freshman
530		FAPK0156	Zoe, Caroline D	Graded	13.00	Liberal Arts Undergraduate - Undeclared Undergraduate	Freshman
531		FAAG0038	Zon, Lawson E	Graded	12.00	Liberal Arts Undergraduate - Undeclared Undergraduate	Freshman

[Select All](#) [Clear All](#)

notify selected students

Field or Control	Description
Class Detail	Click to access the class detail information.
Enrollment Status	<p>Enter the student enrollment status that you want to view for the class. The available values are <i>All</i>, <i>Dropped</i>, <i>Enrolled</i>, and <i>Waitlisted</i>.</p> <p>The roster data determines which values are available. For example, if the class has no students with a dropped status, then the <i>Dropped</i> value is not available. If all the students in the class are enrolled, the only available value is <i>Enrolled</i>.</p>
Start Date	<p>This field is only available for classes scheduled in the Open Entry/Exit (OEE) session. When the field is available, the default value is the term start date.</p> <p>Enter a date in this field to filter the list of students in the class roster for an OEE class so that the only remaining students are those whose class start date is on or after a specific date.</p>
Enrollment Capacity	This value is provided by default from the value that is defined on the Schedule of Classes - Enrollment Cntrl page.
Enrolled	The total number of students enrolled in the class.
Dropped	The total number of students who were enrolled in the class but are now in a dropped status.
Waitlisted	The total number of students currently waitlisted for the class.

Field or Control	Description
Select	Use this check box to select particular students for notification. This check box is available only for students who have an email address defined within the system.
Name	Preferred name appears by default. If no preferred name exists, the primary name appears.
Grade Basis	The grading basis of enrolled students.
Units	The number of units that the student took for the class.
Start Date and End Date	The start and end dates for students in an OEE class.
Program and Plan	The student's primary academic program and any associated academic plans for that program.

Field or Control	Description
Status	The student's current enrollment status in the class. This column appears only when the <i>All</i> value is entered in the Enrollment Status field.
Status Note	This column displays the waitlist position number for students who have a waitlisted status. If a student has a status of enrolled, but has been assigned a drop penalty grade, the notation <i>withdrawn</i> appears in the column.
Select All and Clear All	Click the Select All link to select all students for notification. Only students who have an email address defined in the system are available for selection. To select particular students for notification, use the Select check box. Click the Clear All link to clear your selections.
Notify Selected Students	Click this button to access the Class Roster - Send Notification page and send email notifications to selected students.

Related Links

[Processing Enrollment Transactions Through Self Service](#)

Viewing Class Rosters Using Self-Service Pages

If your institution has licensed PeopleSoft Campus Self Service, your staff can view class rosters over the web.

Related Links

[“Viewing Self-Service Class Rosters” \(Campus Self Service \)](#)

Printing Class Rosters

This section discusses how to print class rosters.

Page Used to Print Class Rosters

<i>Page Name</i>	<i>Definition Name</i>	<i>Navigation</i>	<i>Usage</i>
Print Class Roster	RUNCTL_SRCLASSRSTR	Curriculum Management > Class Roster > Print Class Roster > Print Class Roster	Print class rosters.

Printing Class Rosters

Access the Print Class Roster page (**Curriculum Management > Class Roster > Print Class Roster > Print Class Roster**).

<i>Field or Control</i>	<i>Description</i>
Academic Institution	Enter the academic institution for which you want to print class rosters.
Term	Enter the term for which you want to print class rosters.

Assignment

<i>Field or Control</i>	<i>Description</i>
Session	Enter the session that contains the class rosters that you want to print. Values for this field are delivered with your system as translate values.
Display Permissions	Select to display permissions on the printed class roster. If the class section has permissions, the Class Roster report displays the name of the student assigned the permission, the date that the student used the permission, and the expiration date of the permission.

Field or Control	Description
Sort Option	<p>Select how you want to sort the student data in the class roster:</p> <p><i>Name</i>: Select this option to sort the student data in the class roster by name.</p> <p>Preferred name appears by default. If no preferred name exists, the primary name appears.</p> <p><i>Start Date, Name</i>: Select this option to sort the data for students in an OEE class based on the student's class start date.</p>

Select One of the Following

Field or Control	Description
Academic Organization	If you want to print class rosters for a specific academic organization, enter a value in this field and do not enter a value in the Subject Area and Class Nbr fields.
Subject Area	If you want to print class rosters for a specific subject area, enter a value in this field and do not enter a value in the Academic Organization and Class Nbr fields.
Class Nbr (class number)	If you want to print class rosters for a specific class, enter a value in this field and do not enter a value in the Academic Organization and Subject Area fields. You are prompted by the schedule of classes for the specified term.

Students In The Report

Field or Control	Description
Enrolled Students	Select this check box if you want the class roster to include the students who are enrolled in the class.
Dropped Students	Select this check box if you want the class roster to include the students who have dropped the class.
Waitlisted Students	Select this check box if you want the class roster to include the students who are on the wait list for enrollment in the class.

OEE Start Date Range

<i>Field or Control</i>	<i>Description</i>
From	Enter a date to filter OEE class rosters, so that only students with an OEE start date greater than or equal to this date are included.
To	Enter a maximum OEE start date for this run. Students with an OEE start date that is greater than this date are excluded.

Run the Class Roster Structured Query Report (SQR) process as needed.

Producing Student Study Lists

A student study list is a list of classes in which a student is enrolled for a term.

This section discusses how to generate student study lists.

Page Used to Produce Student Study Lists

<i>Page Name</i>	<i>Definition Name</i>	<i>Navigation</i>	<i>Usage</i>
Student Study List	RUNCTL_SRSTDYLIST	Records and Enrollment > Enrollment Summaries > Student Study List Report > Student Study List	Generate student study lists.

Generating Student Study Lists

Access the Student Study List page (**Records and Enrollment > Enrollment Summaries > Student Study List Report > Student Study List**).

<i>Field or Control</i>	<i>Description</i>
Institution	Enter the academic institution for which you want to generate student study lists.
Term	Enter the term for which you want to generate student study lists.
Academic Career	Enter a value in this field to generate student study lists for a specific academic career.

<i>Field or Control</i>	<i>Description</i>
Academic Program	Enter a value in this field to generate student study lists for a specific academic program. The Student Group field becomes unavailable for edit.
Student Group	Enter a value in this field to generate student study lists for a specific student group. The Academic Program field becomes unavailable for edit.

Run the Student Class Schedule Report SQR process (SRSTDLST). Run the PSJob process only if you are running the process on a server.

Managing Enrollment Verifications

Producing Enrollment Verification Reports

The Enrollment Verification feature enables you to produce enrollment verification reports for students. You can produce these reports for individual students on-demand or through a batch process using PeopleSoft Process Scheduler. This feature also enables you track the production of enrollment verifications for individual students, enter enrollment verification requests for future dates, and prevent production of enrollment verifications for students with specific service indicators.

This section discusses how to:

- Restrict service indicators from enrollment verification.
- Enter enrollment verification requests.
- Enter recipient address for enrollment verifications.
- Add notes to enrollment verifications.
- Process enrollment verifications in batch.

Pages Used to Produce Enrollment Verification Reports

<i>Page Name</i>	<i>Definition Name</i>	<i>Navigation</i>	<i>Usage</i>
Enrollment Verification Req (enrollment verification request)	ENRL_VER_REQUEST	Records and Enrollment > Enrollment Verifications > Enrollment Verification > Enrollment Verification Req	Enter the content of a student's enrollment verification request. Also view the history of a student's enrollment verification requests.
Address	ENRL_VER_REQUEST_2	Records and Enrollment > Enrollment Verifications > Enrollment Verification > Address	Enter the destination address of the enrollment verification and the number of copies to be sent. Direct each request to multiple recipients and addresses. For each recipient, either enter a free-form address or select existing address information already stored in the system.

Page Name	Definition Name	Navigation	Usage
Notes	ENRL_VER_REQUEST_3	Records and Enrollment > Enrollment Verifications > Enrollment Verification > Notes	Add an optional free-form message to be included on the student's printed enrollment verification report. The message can be unique to each recipient of the report.
Enrollment Verification Print	RUNCTL_ENRL_VER	Records and Enrollment > Enrollment Verifications > Enrollment Verification Print > Enrollment Verification Print	Process enrollment verification reports for students in batch based on the academic institution, request date, and whether the report has been previously printed.

Restricting Service Indicators from Enrollment Verification

As you can with academic transcripts, you can set up the system to hold the processing of enrollment verification requests when students have certain negative service indicators. In order for the enrollment verification processes to hold these students' requests, you must first associate the delivered service impact ENVER with a service indicator.

Related Links

“Viewing, Assigning, or Removing Service Indicators” (Campus Community Fundamentals)

Entering Enrollment Verification Requests

Access the Enrollment Verification Req page (**Records and Enrollment > Enrollment Verifications > Enrollment Verification > Enrollment Verification Req**).

For each request, you can process and print it immediately, process and print it in batch with other requests for a range of days, or hold it for batch processing and printing on a future date. The page displays the student's requests in descending order according to the sequence number of each request, the most recent request appearing on top.

Field or Control	Description
Sequence Number	The number assigned to each request that has been entered for the student.
Request Date	The date on which the request was entered into the system. If you are entering a new request, the system defaults this date to today's date.
Academic Institution	Select the academic institution for which you want to print the request. The system defaults to the academic institution defined for you on the User Defaults component.

Field or Control	Description
Date to be Printed	The system defaults to today's date the date this request is to be printed. If you want to print the request on a future date through the batch enrollment verification process (COBOL program SRPCENVB), select a new date. The enrollment verification process does not print the request until the system date matches this date and the date range of your batch request includes this date.
Date Processed	If the request has already been processed, the system displays the date that the processing occurred.
From Term	To report all terms for which the student has enrollment history, leave this field blank. To print an enrollment verification report for a single term, select the term. To print an enrollment verification report for a range of terms, select the beginning term in the range. The system defaults the value you select to the To Term field.
To Term	This field value defaults from the From Term field value. If you want to print an enrollment verification report for a range of terms, select the latest term in the range.
Current Program	Select to include the student's current academic career, academic program, academic plan, and academic subplan in the printed report. The system selects this option for you by default. <hr/> Note: To print the student's current program, academic plan, and academic subplan, the Transcript Level field on the Academic Program page, Academic Plan Table page, and Academic Sub-Plan Table page (respectively) must be set to a value other than <i>Not Print</i> . <hr/>
Earned Degrees	Select to include the student's earned degrees in the printed report. The enrollment verification process prints degrees in degree sequence number order and their associated degree plans in plan sequence number order. If you select this option and the student has no earned degrees, the process excludes this section of information from the printed report.
Cum and Term GPA (cumulative and term grade point average)	Select to include the student's GPA by term and cumulative GPA by academic career on the printed report. <hr/> Note: To print the student's cumulative GPA by academic career on the request, you must <i>also</i> select the Current Program option. <hr/>
User ID	If the request has already been processed, then for tracking purposes, the system displays the user ID of the person who entered the request.

Field or Control	Description
Status (not labeled)	The current status of the request, either <i>On Request</i> or <i>Completed</i> .
Print	<p>Click this button to process the request immediately and send the report directly to your default printer. All of the student's academic careers appear on the same report, listed separately by term. The COBOL program SRPCENVR extracts the student data from the STDNT_CAR_TERM table for all academic careers and applicable terms. After this is done, the process updates the request Status field to <i>Completed</i>.</p> <p>Also click this button to reprint a request. The system keeps no record of reprinted enrollment verifications. If the student has no enrollment history based on the request parameters, the system prints a report with the enrollment history header and the message <i>Enrollment History Unavailable</i>.</p> <p>If the student has a service indicator with an attached service impact of ENVER, the system displays the Service Indicator page, indicating that enrollment verification has been prevented due to negative service indicators.</p>

Technical Information

The COBOL program SRPCENVR writes data to two tables, and this data is printed by BI Publisher on report SR802---.rpt. One table holds the header data and another table holds the detail data. The COBOL process first outputs the header records—one for each request detail and copy requested. For example, if three copies are requested for address A, three header records are produced with address A. The COBOL process then produces the detail records one time for the whole request. The two tables are joined using the query tool and **BI Publisher**, producing the right number of copies for each requested address. You can alter the enrollment verification headers by modifying the SRCCENVR Program ID on the Strings Table page (PeopleTools, Utilities, Use Strings Table).

You can also change the date format for the Enrollment Verification Report (SR802). Access the Define Personalizations page (PeopleTools, Personalization, Personalization Options, Format tab, DFRMT option). You can set the date separator options on the same page, under the DTSP option. These settings control the following fields that appear on the SR802 report:

- Enrollment Verification As of date
- Expected Completion Date
- Declare Dt
- Begin Date
- End Date

Entering Recipient Addresses for Enrollment Verifications

Access the Address page (**Records and Enrollment > Enrollment Verifications > Enrollment Verification > Address**).

Field or Control	Description
Send to Requestor	Select to automatically populate the Send To field with the requestor's name and the address fields with the requestor's home address.
Specify External Org ID	Select to be able to choose an existing external organization. The system makes available the Org ID and Location fields for this purpose.
Org ID (organization ID)	This field becomes available when you select the Specify External Org ID check box. Select the organization to which you are sending the enrollment verification request. The field prompts against the Organization Table record. Define external organizations on the Organization Table page. After you press Tab to move out of the field, the system automatically populates the Send To field with the organization's name.
Location	This field becomes available when you select the Specify External Org ID option. Select the location code of the organization to which you are sending the enrollment verification request. After you press Tab to move out of the field, the system automatically populates the address fields with the location address.
Send to	Enter the name of the recipient to whom you are sending the enrollment verification report. If you select either the Send to Requestor check box or the Specify External Org ID check box, then this value populates automatically according to your selection; however, you can overwrite it. You can also enter multiple recipients.
Number of Copies	Enter the number of enrollment verification reports that you want to produce and send to this recipient and address.
Country	Select the country of the recipient's address. After you press Tab to move out of this field, the system displays the address format associated with that country. Enter all of the necessary address information in the address fields that appear. If you select either the Send to Requestor check box or the Specify External Org ID check box, then these fields populate automatically according to your selection. When you process and print the report, either through the Print button on the Enrollment Verification Req page or through the batch process, the address prints so that it appears properly through the window of a #10 envelope.

Related Links

“Understanding Organizations” (Campus Community Fundamentals)

“Creating Organization Records” (Campus Community Fundamentals)

“Entering Organization Location Data” (Campus Community Fundamentals)

Adding Notes to Enrollment Verifications

Access the Notes page (**Records and Enrollment > Enrollment Verifications > Enrollment Verification > Notes**).

<i>Field or Control</i>	<i>Description</i>
Send To and Organization	The system displays the name of the recipient in these fields.
Enrollment Verification Notes	If you want to include a message on the enrollment verification report, enter it in this text box.

Processing Enrollment Verifications in Batch

Access the Enrollment Verification Print page (**Records and Enrollment > Enrollment Verifications > Enrollment Verification Print > Enrollment Verification Print**).

This example illustrates the fields and controls on the Enrollment Verification Print page. You can find definitions for the fields and controls later on this page.

Enrollment Verification Print

Run Control ID: PS [Report Manager](#) [Process Monitor](#) Run

Academic Institution: PeopleSoft University

Begin Date:

End Date:

Unprinted Requests Only

<i>Field or Control</i>	<i>Description</i>
Academic Institution	Select the academic institution for which you want to print enrollment verification reports.
Unprinted Requests Only	<p>Select if you want the process to print only the request records that have a status of <i>On Request</i>, as displayed on the Request process page in the Enrollment Verification Req component. The process excludes all previously printed enrollment verification reports. The system selects this check box by default.</p> <hr/> <p>Note: If you clear this check box, the process reprints any request with a status of <i>Completed</i>. The new report contains all information as of the run date.</p> <hr/>

Field or Control	Description
Begin Date and End Date	<p>In the Request Date group box, select a range of dates to process only the request records entered into the system on or within these dates. By default, the system populates the End Date field with today's date. If you want to print the academic institution's request records for all dates, leave these fields blank.</p> <hr/> <p>Note: The process does not print request records where the date to be printed value is set to a future date. It prints these records after the date to be printed is on or before the system date and falls within the date range your request for the batch process.</p> <hr/>

First run the COBOL process SRPCENVB to populate the results tables. PeopleSoft Process Scheduler runs the process at user-defined intervals. The report prints in alphabetical order by the student's name (last name, first name) and displays data according to the criteria selected on the Enrollment Verification Req component. The process extracts the student data from the STDNT_CAR_TERM table for all academic careers and applicable terms. After this is done, the process updates the request status to *Completed*. Run the PSJob only if you are running the process on a server.

If you have set up negative service indicators with a service impact of ENVER and students have one of these service indicators, the SRCENVB process creates error records for these students.

Technical Information

The COBOL program SRPCENVB writes data to two tables. One table holds the header data and another table holds the detail data. The COBOL process first outputs the header records, one for each request detail and copy requested. For example, if three copies are requested for address A, three header records are produced with address A. The COBOL process then produces the detail records one time for the whole request. The two tables are joined using the query tool, producing the right number of copies for each requested address.

Requesting Enrollment Verifications Through Self Service

If your institution has licensed PeopleSoft Campus Self Service, your students can view enrollment verifications directly by using the web.

Related Links

“Using Self-Service My Academics Functionality” (Campus Self Service)

Chapter 46

Processing Transfer Credit

Understanding Transfer Credit Processing

This section lists common elements and discusses transfer credit processing and converting transfer credit units.



Common Elements Used to Process Transfer Credit





<i>Field or Control</i>	<i>Description</i>
Academic Plan	(Optional) In the Target Information group box, select the academic plan for which the transfer credit in this row of the transfer model will articulate.
Academic Program	In the Target Information group box, select the academic program for which the transfer credit in this row of the model will articulate.
Add Comments	Click to access the Model Comments page, where you can enter comments about this row of the transfer credit model.
Articulation Term	Select the term for which you want to process the individual's transfer credit for this row of the model. Note that you can articulate credits across multiple terms. You would do this, for example, if a student has continually taken credit outside your academic institution and you have posted credit at each point in time.
Calculate	When you articulate course and test credit, click this button to calculate the individual's transfer credit statistics according to the accepted transfer credit on the corresponding row of the model.
Comment	Click to access the Model Comments page, where you can enter comments about this row of the transfer credit model.

Field or Control	Description
Credit Source Type	<p>In the Source Information group box, select the type of source from which you will be modeling transfer credit on this row. Your selection tells the system from which table you will select your source institution. Values are:</p> <p><i>External:</i> The system prompts you with the source IDs of external organizations in your system. The External Org ID (external organization ID) and Data Source fields become available.</p> <p><i>Internal:</i> The system prompts you with source IDs of academic institutions in your system. You select this option, for example, when a student is transferring from one academic career to another within your academic institution. The Source Career and Source Institution fields become available.</p> <p><i>Manual:</i> If you intend to create transfer credit models manually, do not use this component. If you select this option, the system displays a message instructing you to use the corresponding manual component.</p>
Data Source	<p>For an external credit source type, select the data source from which the individual's external transfer credit has been entered into the system. The data source that you specify must match the data source on the individual's external education record. Values for this field are delivered with your system as translate values. You can modify these values.</p>
Equivalent Subject /Catlg Nbr (equivalent subject and catalog number)	<p>After you run the Transfer Credit process for a model, the system displays the subject and catalog number of the internal course that is equivalent to the transfer credit that it evaluated. The process determines these values for course transfer credit according to the internal equivalent course that is specified for the applicable course transfer equivalency rule on the Subject Area Elements page of the Transfer Subject Area component. The process also determines these values for test transfer credit according to the internal equivalent course that is specified for the applicable test transfer equivalency rule on the Test Credit Rule/Component page.</p> <p>When processing transfer credit manually, after you enter the equivalent subject and catalog number on the Equivalent Course Information page for this row of the model, the process displays your selection in this field. You access the Equivalent Course Information page by clicking the Edit Equivalent Course button on the corresponding row of the model.</p>
External Org ID (external organization ID)	<p>For an external credit source type, select the external organization from which the individual is transferring credit. Define external organizations on the External Organization page. You access this page from the education record of the transfer prospect, applicant, or student as defined on the Education component.</p>

Field or Control	Description
Group	The Transfer Credit process automatically groups incoming transfer credit and its internal equivalent courses together on separate rows within the grid at the bottom of the page. The number in this field identifies the group as unique among other groups on this row of the transfer credit model. You can, after the Transfer Credit process completes the evaluation, move internal equivalent courses from group to group as needed to alter the articulation model before you post the transfer credit to the individual's record. You can move internal equivalent courses from group to group by using the Move To Group button on the grid row of the course to move.
Include in FA WI Status	Select this check box to indicate that the accepted course must be used to calculate the weeks of instruction component of the student's grade level. By default, the check box is selected for all accepted course credit.
Lock	Select to lock the corresponding group row of the transfer credit model. You might select this check box, for example, if you intend to post or unpost transfer credit for that row at a later date. The groups for which you select this check box are excluded from a rerun of the Transfer Credit process. If you rerun the Transfer Credit process and something about the incoming transfer credit has changed (such as grades or units), then the process displays a red letter <i>Y</i> in front of that group. The <i>Y</i> alerts you that something about that incoming transfer credit changed after the group was locked. You might, therefore, want to investigate the change before you post or unpost the corresponding transfer credit.
Model Nbr (model number)	The system, by default, sets the first row of the transfer credit model to model number <i>1</i> . The system uses this number to store multiple, unique transfer credit models.

Field or Control	Description
Model Status	<p>The system displays the status of the model on the first page and subsequent page of the component. Values are:</p> <p><i>Submitted:</i> Indicates that you have run the transfer credit articulation process for this model.</p> <p><i>Posted:</i> Indicates that you clicked the Post button on the second page of the component and the system has successfully transferred the articulated transfer credit to the student's career term record (STDNT_CAR_TERM table) for this model.</p> <p><i>Completed:</i> Indicates that you have modeled and articulated the student's transfer credit, but that the model could not be posted to the student's career term record because the student is not currently active in either the academic program or articulation term that you selected for the model.</p> <p>When the student is activated into the academic program and articulation term that you selected, click the Copy TC Units button on the Terms in Residence page. This automatically updates the model status to Posted and writes the data to the STDNT_CAR_TERM table.</p>
Post	<p>Click to post an individual's transfer credit for the corresponding model. Posting automatically saves the page. When you post transfer credit, the system displays the posted transfer credit statistics according to the individual's calculated transfer credit statistics on the page. Posting a transfer credit model also updates the status of the model from <i>Submitted</i> to <i>Posted</i> or <i>Completed</i>. When you post your transfer credit model, the fields in the Target Information group box on the first page of the component become unavailable. To update target information, you must first unpost your model.</p>
Seq # (sequence number)	<p>For transfer credit in which you manually define equivalencies, the system automatically assigns a sequential number to each incoming row of transfer credit to identify unique rows in the table. These sequence numbers have no programming significance.</p>
Source Career	<p>For an internal credit source type, select the academic career from which the student is transferring credit.</p>
Source Institution	<p>For an internal credit source type, select the internal academic institution from which the student is transferring credit.</p>
Status	<p>After you run the Transfer Credit process for this row of the model, the process displays the transfer status of each transfer credit that it evaluated. Possible statuses are <i>Accepted</i>, <i>Rejected</i>, <i>No Rule</i>, and <i>Contingent</i>.</p>
Study Agreements	<p>Click to access the Student Agreements page, where you can view the details of a student's study agreement.</p>

Field or Control	Description
Total Units - Articulation Term	When you articulate test and other credits, the system calculates the individual's total transfer credit units according to the articulation term and incoming transfer credit on the corresponding of the model.
Total Units - Posted Model	When you articulate test and other credits, use this field to view a summary of the credits that have been transferred to the student's record through this model. You can view changes in this field only after you have posted or unposted the model and saved the transaction. The system displays values for this field in relation to the corresponding value in the Total Units - Articulation Term field that you have calculated for the model.
Transcript Level	Select a transcript level to determine the types of transcripts on which the system will include the transfer credit that articulates through this row of the model, provided that it is posted to the individual's record. Values are <i>Not Print</i> , <i>Official</i> , <i>Unofficial</i> , <i>Stdnt Life</i> (student life), and <i>Degr Prog</i> (degree progress).
Transfer Status	After you run the Transfer Credit process for this row of the model, the process displays the transfer status of each transfer credit that it evaluated. Possible statuses are <i>Accepted</i> , <i>Rejected</i> , <i>No Rule</i> , and <i>Contingent</i> .
Unpost	Click to completely remove the transfer credit that is posted through this model from the student's career term record. View the results for the student on the Term Statistics page.
	Click the Transfer Status Detail button to access the Transfer Rule Applied page or the Reject Reason page, where you can either view the transfer equivalency rule that the Transfer Credit process applied to the corresponding external course or, if the transfer credit is rejected, view the reject reason. This field applies only to transfer credit processing with predefined course and test equivalency rules.
	Click the Edit Equivalent Course button to access the Equivalent Course Information page, where you can edit equivalent course information prior to posting transfer credit.
	Click the Reject External Course button to reject incoming courses before you post transfer credit. Only the incoming course on the corresponding row is rejected. For example, if incoming Math 100 and Math 200 are equivalent to internal Math 104, and you click the reject button on the Math 100 line, the resulting rule is that Math 200 is equivalent to Math 104.

Field or Control	Description
	Click the Add Internal Equivalent button to access the Equivalent Course Information page, where you can add internal equivalent course information.
	Click the Delete Internal Equivalent button to delete internal equivalent courses for the corresponding group row. This button appears only if multiple internal equivalent courses exist for that row.
	Click the Move to Group button to open a field on the page for another group number. Use this field to move transfer credit from one group into another group. For example, assume that a group has a transfer status of <i>Rejected</i> . You can use this feature to move the transfer credit to another group that has a transfer status of <i>Accepted</i> to ensure that the transfer credit gets posted.
	Click the Comment/Override Reason button to access the Course Credit Comments, Test Credit Comments, or Other Credit Comments pages, where you can add an override reason and comment about any adjustments that you made to a group row of a transfer credit model.

Related Links

[Viewing Student Study Agreements](#)

[Defining Transcript Types](#)

Transfer Credit Processing

When you have set up your predefined transfer rules for courses and tests, you can start processing transfer credit. The Transfer Credit process includes retrieving all external transfer credit information; evaluating these external courses, tests, and other credit; then posting the transfer credit. Campus Solutions provides features to enable transfer credit processing by the following methods:

- Using predefined rules.
- Using student-specific agreements.
- Creating manual rules to assign course, test, and other credit.

Our processing design is based on modeling, so you can give individuals options for articulation that depend on the academic program or academic plan that is selected for them.

You can command the system to evaluate transfer credit by using the predefined transfer equivalency rules that you have created and then attached to academic programs and plans. Or you can process transfer credit by creating models manually as you go through processing. For course transfer credit, you can also use student-specific study agreements in conjunction with these predefined course transfer equivalency rules. Whether you are using predefined or manual rules or processing transfer credit

manually, the functionality is the same. However, to maximize the use of your time, use only the manual Transfer Credit process to transfer credit for schools from which you rarely receive students.

You should understand some general concepts before you begin processing transfer credit, regardless of which type of transfer credit and method you use. The Transfer Credit process enables you to model as many articulation scenarios for a prospect, applicant, or student as you want. You select the rule for your model (either predefined or manual), command the system to evaluate the scenario on the basis of that rule, revise the results if you want, and save the model or post the credits.

When you have posted credits, the system updates the individual's record. The same is true when you unpost an articulation model—when you have unposted credits, the system updates the individual's academic record. The system removes all the credits that were posted.

Another concept is the grouping of transfer credit. Incoming transfer credit and its internal equivalents are grouped together. The result is known as a *group*. You can, when the Transfer Credit process completes the evaluation, move internal equivalent courses from group to group as needed to alter the articulation before you post the transfer credit to the individual's record. Other features include many buttons that enable you to accept, reject, add, and discard courses from the group. You can also revise details, such as units and grade.

Note: A person does not have to be active in an academic program or academic plan to *create* model-transfer-credit scenarios. However, the student must be active to *post* transfer credit.

Converting Transfer Credit Units

Student Records converts incoming units to the term type of the transfer rule. This enables the system to accurately compare incoming units to the rule. To convert incoming units, the system first determines the number of units taken. Then the system calculates the number of units transferred. At each stage, the system must determine whether it needs to convert the units, and if so, the system converts them.

To calculate the number of units taken, the system:

1. Determines whether the transfer units need to be converted.

The system compares the term type of the course (on the External Courses page) with the term type of the rule (on the Subject Area Elements page). If they are different, the units must be converted. That is, if the student earned four quarter units in MATH 120, and the rule is based on semester units, the system needs to convert the four quarter units to semester units before comparing it to the rule and determining how many units transfer.

2. If yes, the system converts the units.

To convert the units, the system must first determine the correct multiple to use. To find the multiple, the system compares the term type and the external term type of the education record (as shown on the External Data page) with the term type and external term type on the External Term table. You set up external terms with their multiples on the External Term Table page. To convert the units, the system multiplies the number of units earned in the external course (as it appears on the External Courses page) with the multiple.

For example, suppose the system finds that the term type of the external course is quarter and the external term is fall. It would find the corresponding row on the External Term table to find the multiple, which in this case is 0.75. Then it would multiply this by the number of units that the student received, which was 4 in this example. So the equation is 0.75×4 , and the converted value is 3.

3. The system uses the converted value to compare against the rule to determine whether the units meet the requirements of the rule.

The system determines whether the converted value falls within the minimum and maximum unit range set in the rule (Incoming Course Information page). If the converted value falls within the range, the system distributes the units to the internal equivalent and excess unit course as determined by the rule. The system displays the converted units for each incoming course in the **Units Taken** field on the Equivalent Course Information page.

At this point, the system has determined the number of units taken. It must now determine the number of units transferred according to the transfer credit model.

To calculate the number of units transferred, the system:

1. Determines whether the units must be converted again by comparing the term unit type of the career to the term type of the rule.

You see on the Transfer Course Details page that the transfer credit model has an academic career. The system finds the term unit type for the career that appears on the model. Term unit type for careers appears on the Academic Career Table 2 page. The system then compares the term unit type of the career with the term type of the rule, as found on the Subject Area Elements page. If the term types are the same, the system does not need to convert the units.

2. If the term unit type of the career is different from the term type of the rule, the system converts the units.

The system converts the units just as it does for calculating the units taken, except that instead of using the term unit type of the education record, it uses the term unit type of the transfer credit model's career.

3. The system displays the calculated results for each incoming course in the **Units Transferred** field on the Incoming Course Information page.

Previously in Student Records, you had to set the unit value of the incoming equivalent course based on the term type of the incoming credit's institution. Now the system converts the incoming units to the term type of the rule, giving you more flexibility in setting up transfer rules.

Note: If you want unit conversion to occur after the units have been awarded to the internal equivalent and excess unit classes, set the term type on the rule to equal that of the incoming course. In this case, the system does not convert the units to match the rule (they will already match), the system converts them only to match the career of the model.

Understanding Internal Transfer Credit and Unit Conversion

When using unit conversion rules with internal transfer modeling, the system uses the multiple from the Unit Conversion table and converts them as illustrated in the following example.

An undergraduate Engineering student (quarter program) takes an undergraduate three-unit class (semester class), Biology 100, and receives a C. The university then models the student in a UGRD program (semester program).

The system converts the units like this:

1. The system automatically changes the Biology 100 class into quarter units (student receives 4.5 units at enrollment).
2. Transfer credit comes in when the university models the student for a career.
3. If the model is in a semester career, the units are converted to 3 units because the student enrollment units are quarter:

Incoming	Conversion factor	Quarter equivalent
3 semester units	x 1.5	= 4.5

4. The system uses the quarter value to determine whether the criteria for transfer are met.
5. The system looks at the rule and finds the unit value of the internal equivalent class, which in this case is 3:

Internal equivalent value	Conversion factor	Semester equivalent
3 semester units	x .6770	= 2.031

Note: If you want to bypass the rule value and just convert the units in student enrollment to the new career, set the transfer rule to *Specify Maximum Units* on the Subject Area Elements page.

Understanding Grading at Articulation

The Transfer Credit Articulation process determines the grade for internal equivalent courses based on the value that is entered in the **Default Grade** field on the Subject Area Elements page.

See [Defining Subject Area Elements](#).

Recording External Course and Test Information

The first step in processing transfer credit for courses and tests is receiving external course and test information. You enter external course information for individuals in the Education component and external test information in the Test Results component.

Related Links

“Entering and Updating External Education Data” (Recruiting and Admissions)

“Tracking Test Results for Prospects and Applicants” (Recruiting and Admissions)

Creating Student-Specific Agreements

Student-specific agreements are generally made prior to the student enrolling at your academic institution. Sometimes, however, your course transfer equivalency rules do not satisfy a specific student's situation, or an advisor wants to make a unique transfer agreement with a student.

This section discusses how to:

- Describe student agreements.
- Enter student agreement details.

Pages Used to Create Student-Specific Agreements

<i>Page Name</i>	<i>Definition Name</i>	<i>Navigation</i>	<i>Usage</i>
Student Agreements	STDNT_AGRMNT	Records and Enrollment > Transfer Credit Evaluation > Student Agreements > Student Agreements	Describe specific student agreements, and enter the catalog organization and comments.
Student Agreement Courses	STDNT_AGRMNT_CRSE	Records and Enrollment > Transfer Credit Evaluation > Student Agreements > Student Agreement Courses	Enter the external courses and equivalent internal courses of specific study agreements. These study agreement equivalency rules are separate from the course transfer equivalency rules that you might have created and attached to academic programs and plans.

Describing Student Agreements

Access the Student Agreements page (**Records and Enrollment > Transfer Credit Evaluation > Student Agreements > Student Agreements**).

This example illustrates the fields and controls on the Student Agreements page. You can find definitions for the fields and controls later on this page.

The screenshot shows a web interface for 'Student Agreements'. At the top, there are tabs for 'Student Agreements' and 'Student Agreement Courses'. Below the tabs, the user 'Ana Beck' is logged in, and the agreement ID is 'SR0400'. The form displays the following information:

- Academic Career:** UGRD Undergraduate
- Academic Institution:** PSUNV PeopleSoft University
- Source ID:** 2300022 Santa Barbara City College
- *Effective Date:** 09/30/2004
- *Status:** Active
- *Description:** Summer courses at SBCC
- *Catalog Org Type:** External
- *Catalog Organization:** 2300022 Santa Barbara City College
- Comment:** Ana will enroll in one english course at SBCC over the summer.
- *User ID:** PS

The user 'Betty Locherty' is shown at the bottom right of the form.

Field or Control	Description
Catalog Org Type (catalog organization type)	<p>The information in this field designates the table from which you will select a catalog organization for the external courses of the study agreement. Values are:</p> <p><i>External:</i> The system prompts you with external organizations in your system.</p> <p><i>Internal:</i> The system prompts you with academic institutions in your system.</p>
Catalog Organization	<p>Select the catalog organization for the external courses of this study agreement. The system prompts you with values based on your selection in the Catalog Org Type field. When you define course equivalencies for this study agreement on the Study Agreement Courses page, the system prompts you with courses based on the catalog organization that you select here.</p> <p>You can use any external organization or internal academic institution as the catalog organization to define external courses for this study agreement. However, when you define an external course on the Study Agreement Courses page, the Catalog Org Type and Catalog Organization fields become unavailable.</p>
Comment	Enter any comments that are relevant to this study agreement.
User ID	Displays the user identification code of the person who entered the study agreement into the system.

Entering Student Agreement Details

Access the Student Agreement Courses page (**Records and Enrollment > Transfer Credit Evaluation > Student Agreements > Student Agreement Courses**).

This example illustrates the fields and controls on the Student Agreement Courses page. You can find definitions for the fields and controls later on this page.

The screenshot shows the 'Student Agreement Courses' page for student Ana Beck. The student's details are as follows:

- Academic Career:** UGRD (Undergraduate)
- Academic Institution:** PSUNV (PeopleSoft University)
- Source ID:** 2300022 (Santa Barbara City College)
- Course ID:** SR0400

The page includes navigation controls (Find, View All, First, 1 of 1, Last) and an 'Effective Date' of 09/30/2004. Below this, there are two main sections: 'EXTERNAL COURSE' and 'INTERNAL COURSE'.

EXTERNAL COURSE fields:

- Subject:** ENGL
- Course Nbr:** 17
- Units Taken:** 4.00
- Ext Grd Scheme:** UGR
- Ext Grd Basis:** GRD
- Minimum Grade:** B

INTERNAL COURSE fields:

- *Course ID:** 003274
- *Offer Nbr:** 1
- *Units Transferred:** 3.000
- Grading Scheme:** UGD (Undergrad)
- Grading Basis:** GRD (Graded)
- Grade:** B (Good)

EXTERNAL COURSE

Enter the external course information for the study agreement in the **EXTERNAL COURSE** group box.

<i>Field or Control</i>	<i>Description</i>
Subject	Select the subject of the course.
Course Nbr (course number)	Select the course number for the external course. If you are using an external organization for the catalog organization (as defined on the Study Agreements page), the system prompts you with courses that you have associated with the external organization on the School Course Classification page. If you are using an internal academic institution for the catalog organization, the system prompts you with courses that are defined for that academic institution in the Course Catalog component.

Field or Control	Description
Units Taken	By default, the system displays the units of the external course according to the course definition. You can override this default value.
Ext Grd Scheme (external grading scheme)	Select the grading scheme from which you can select a valid grading basis for this external course.
Ext Grd Basis (external grading basis)	Select a grading basis to define all of the valid grades from which you can select a minimum grade for this external course.
Minimum Grade	Select a minimum grade that the student must receive in this external course for the course to fulfill the study agreement. <hr/> Note: On this page, the minimum grade that is needed is a letter grade, whereas in the Course Credit Transfer Rule component the minimum grade is entered as specific grade points. This is a feature intending that advisors who create student-specific agreements might not always be aware of the grading point scheme. <hr/>

INTERNAL COURSE

Enter the internal course information for the study agreement in the **INTERNAL COURSE** group box.

Field or Control	Description
Course ID	Select the internal course that is equivalent to the external course for this study agreement. The system prompts you to select a course from your academic institution's course catalog.
Offer Nbr (offering number)	By default, the system displays the offering number of the course that you selected according to the definition of the course in your academic institution's course catalog. You can override this default value.
Units Transferred	By default, the system displays the units of the course that you selected according to the definition of the course in your academic institution's course catalog. You can override this default value. These units represent the number of units that the student will receive for the internal course if the student fulfills the study agreement.

<i>Field or Control</i>	<i>Description</i>
Grading Scheme	Select a grading scheme from which you can select a valid grading basis for this external course.
Grading Basis	Select a grading basis to define all of the valid grades from which you can select a grade for this internal course.
Grade	Select the grade that the student will receive for the internal course if the student fulfills the study agreement.

Processing Course Transfer Credit

This section provides an overview of course transfer credit processing and discusses how to:

- Process course transfer credit models with predefined rules.
- Calculate and post course transfer credit with predefined rules.
- Process course transfer credit models manually.
- Calculate and post course transfer credit manually.
- View student study agreements.
- View incoming and edit equivalent course information.

Understanding Course Transfer Credit Processing

Two components are available to evaluate course transfer credit, the Course Credits component for predefined rules, and the Course Credits - Manual component for creating manual transfer credit models.

Use the Course Credits component to use predefined course transfer equivalency rules to articulate course transfer credit. Predefined rules can be attached to academic programs, academic plans, and student-specific study agreements. You can create models of articulation based on the source of the transfer credit and the student's academic program and plan. You can create as many models as necessary.

To process course transfer credit using predefined equivalency rules:

1. Set up the source information and target information for the transfer credit model on the Transfer Course Details page.
2. Select the articulation term for the model and command the system to evaluate the courses according to the predefined rules in the **Transfer Credit Term** group box of the Transfer Course Details page.
3. Calculate transfer credit statistics for the model, post and unpost transfer credit, and view a summary of transfer credit statistics on the Transfer Summary page.

4. View summary student statistics, after you have saved a posted or unposted model, in the **Course Credits Summary** group box of the Transfer Summary page.

Use the Course Credits - Manual component to manually enter transfer credit. This component is designed to be used for course transfer credit from schools from which you rarely receive students. This saves you from having to go through the rule-defining procedure for a few students.

To process course transfer credit manually:

1. Set up the source information and target information for the transfer credit model on the Transfer Course Entry page.
2. Select the articulation term for the model and enter the incoming course and internal equivalent course information in the **Transfer Credit Term** group box of the Transfer Course Entry page.

Save the page to run the Transfer Credit process and articulate the course credit.

3. Calculate transfer credit statistics for the model, post and unpost transfer credit, and view a summary of transfer credit statistics on the Course Credits By Term page.
4. View summary student statistics, after you save a posted or unposted model, in the **Course Credits Summary** group box of the Course Credits By Term page.

The Sort Order of Transfer Credit Articulation Results

The Detail table (TRNS_CRSE_DTL) holds the results of the transfer credit articulation process, and the data is displayed in the **Transfer Credit Term** group box on the Transfer Course Details page. The results are sorted in the following manner:

1. Incoming courses that have matching student agreement records.
2. Incoming courses that have exact matches—subject and catalog number for external credits, course ID, and course offering number for internal courses—in the Agreement rule set specified in the Program/Source Equivalency Rule for the model's program.

Within this rule set, rules with higher transfer priority are processed first. Within the same transfer priority numbers, rules with the most number of incoming courses—many-to-many or many-to-one—are evaluated first.

3. Incoming courses that have wildcard matches—subject and partial catalog number—in the Agreement rule set that is specified in the Program/Source Equivalency Rule for the model's program.
4. Incoming courses that have exact matches—subject and catalog number for external credits, course ID, and course offering number for internal—in the Override rule set that is specified in the Program/Source Equivalency Rule for the model's program.

Within this rule set, rules with higher transfer priority are processed first. Within the same transfer priority numbers, rules with the most number of incoming courses—many-to-many or many-to-one—are evaluated first.

5. Incoming courses that have wildcard matches—subject and partial catalog number—in the Override rule set that is specified in the Program/Source Equivalency Rule for the model's program.

6. Incoming courses that have exact matches—subject and catalog number for external credits, course ID, and course offering number for internal—in the Default rule set that is specified in the Program/Source Equivalency Rule for the model's program.

Within this rule set, rules with higher transfer priority are processed first. Within the same transfer priority numbers, rules with the most number of incoming courses—many-to-many or many-to-one—are evaluated first.

7. Incoming courses that have wildcard matches—subject and partial catalog number—in the Default rule set that is specified in the Program/Source Equivalency Rule for the model's program.
8. Rejected courses.

Pages Used to Process Course Transfer Credit

<i>Page Name</i>	<i>Definition Name</i>	<i>Navigation</i>	<i>Usage</i>
Transfer Course Details	TRNS_CRSE_DTL	Records and Enrollment > Transfer Credit Evaluation > Course Credits - Automated > Transfer Course Details	Create course transfer credit models and run the Transfer Credit process to evaluate the models. For each model, you specify target information, source information, and the articulation term. Then you run the Transfer Credit process to articulate course transfer credit, using predefined equivalency rules. You can revise the results as necessary.
Transfer Summary	TRNS_CRSE_TERM	Records and Enrollment > Transfer Credit Evaluation > Course Credits - Automated > Transfer Summary	Calculate an individual's transfer credit statistics, based on the accepted internal equivalent courses of a transfer credit model. After you view the statistics for the transfer credit model, you can post the transfer credit to an individual's record. You can also use this page to unpost transfer credit.
Transfer Course Entry	TRNS_CRSE_ENTRY	Records and Enrollment > Transfer Credit Evaluation > Course Credits - Manual > Transfer Course Entry	Set up course transfer credit models and articulate transfer credit manually as you set up models rather than by using predefined equivalency rules. This page is essentially the same as the Transfer Course Details page of the Course Credits component with the few exceptions that are described in this section.

Page Name	Definition Name	Navigation	Usage
Course Credits by Term	TRNS_CRSE_TERM	Records and Enrollment > Transfer Credit Evaluation > Course Credits - Manual > Course Credits by Term	Calculate an individual's transfer credit statistics for a model based on the accepted internal equivalent courses of the model. After you view the statistics for the transfer credit model, you can post the transfer credit to an individual's record. You can also use this page to unpost transfer credit. This is the same page as the Transfer Summary page of the course credits component.
Student Agreements	STDNT_AGR_CRSE_SEC	Click the Study Agreements link on the Transfer Course Details page or the Transfer Course Entry page. This link is available only if the student has a Student Agreement in the system.	View the details of a student's study agreement, including the external course and the internal equivalent course.
Student Agreement Header Info (student agreement header information)	STDNT_AGR_SEC	Click the Agreement Data link on the Student Agreements page.	View the description, catalog organization, comments about the agreement, and the name of the user who created the study agreement.
Transfer Rule Applied	TRNS_CRSE_RULE_SEC	Click the Transfer Status Detail button on the Transfer Course Details page.	View the course transfer equivalency rule that the Transfer Credit process applied to the corresponding external course. If the course is rejected, the system displays the reject reason. This page applies to transfer credit processing with predefined course equivalency rules.
Reject Reason	TRNS_CRSE_REJR_SEC	Click the Transfer Status Detail button on the Transfer Course Details page.	View the reason why the course transfer equivalency rule was rejected. This page applies only to transfer credit processing with predefined course equivalency rules.

Page Name	Definition Name	Navigation	Usage
Equivalent Course Information	TRNS_CRSE_INT_SEC	Click the Edit Equivalent Course button on the Transfer Course Details page to edit equivalent course information. Click the Add Internal Equivalent button on the Transfer Course Details page to enter additional equivalent courses.	View incoming course credit information for a specific row of a course transfer credit model, and view and edit equivalent course information.
Equivalent Course Information	TRNS_CRSE_MNL1_SEC	Click the Edit Internal Equivalent button on the Transfer Course Entry page.	View details about incoming course credit and internal equivalent course information for a specific row of a test transfer credit model for which you are manually defining equivalencies.
Course Credit Comments	TRNS_CRSE_DTL_SEC	Click the Comment/Override Reason button on the Transfer Course Details page or the Transfer Course Entry page.	Add an override reason and comment about any adjustments that you have made to a group row of a transfer credit model.
Model Comments	TRNS_CRSE_SCH_SEC	Click the Add/View Comments link on the Transfer Course Details page or the Transfer Course Entry page.	Add comments about this row of the transfer credit model.

Processing Course Transfer Credit Models with Predefined Rules

Access the Transfer Course Details page (**Records and Enrollment > Transfer Credit Evaluation > Course Credits - Automated > Transfer Course Details**).

This example illustrates the fields and controls on the Transfer Course Details page. You can find definitions for the fields and controls later on this page.

Transfer Course Details
Transfer Summary

Ana Beck
SR0400

Transfer Credit Model
Find | View All
First 2 of 2 Last

Academic Career: UGRD Undergraduate

Academic Institution: PSUNV PeopleSoft University

***Model Nbr:**

***Transcript Level:** Unofficial

Target Information

***Academic Program:** LAU Liberal Arts Undergraduate

Academic Plan:

Apply Agreement

Source Information

***Credit Source Type:** External

External Org ID: 000010146 Long Beach City College

Data Source: Self-Rpted

Transfer Credit Term
Find | View All
First 1 of 1 Last

***Articulation Term:** 0330 1998 Fall

Submitted

Equivalency Details
Evaluator Details

*Group	Status	External Term	External Subject / Catalog Nbr	Units Taken	Grade Input	Equivalent Subject / Catlg Nbr	Units Accepted	Grade Basis	Grade	Repeat Code	Incl in FA/VI
1	Accepted	1990 FALL	MATH 10	4.00	A	MATH 107	2.000	GRD	T		<input type="checkbox"/>

[Add/View Comments](#)

Field or Control	Description
Apply Agreement	Select to have the Transfer Credit process use the <i>agreement</i> equivalency rule selected for the specified academic program, plan, and source combination on the Rules Specification page. Clear this check box to ignore the specified agreement equivalency rule. By default, the system selects this check box.
(AUS) Level of Education	<p>This mandatory field appears only if the school type assigned to the credit has a DEST credit basis of <i>0200 Credit Offered for Prior VET Study</i>.</p> <p>School types are defined on the School Type Table page.</p> <p>This field appears only if the DEST, HECS, Centrelink, TAC check box is selected on the SA Features page.</p>

Field or Control	Description
(AUS) DEST Institution	<p>Note: This field is available only if you select the Australia DEST, HECS, Centrelink, TAC check box on the Academic Institution 6 page.</p> <hr/> <p>Enter the TCSI institution code from which the transfer credit is coming.</p> <p>Department of Industry, Innovation, Science, Research and Tertiary Education (TCSI) was previously known as DEEWR and before that, as DEST.</p>
Fetch	<p>After you have selected an articulation term for this row of the course transfer credit model, click this button to run the Transfer Credit process.</p> <p>The Transfer Credit process COBOL program evaluates the individual's course transfer credit according to the valid course transfer equivalency rules. The process determines valid course transfer equivalency rules for the specified source based on whether the rule is active previous to the begin date of the articulation term and based on whether the rule was attached to the individual's academic program or academic plan for the specified source. The process then compares the individual's external course information to the valid rules and calculates the results. The courses that the process evaluates appear in the grid at the bottom of the page.</p> <p>Define course transfer equivalency rules on the Transfer Subject Area component and attach them to academic programs and academic plans for the source on the Program/Source Equivalency component. Enter an individual's external course information on the External Courses page of the Education component.</p>
External Term	<p>After you run the Transfer Credit process for this row of the model, the process displays the external term of each course that it evaluated. The process determines the external term for the transfer course according to the value that is entered for the course in the corresponding field on the External Courses page of the Education component.</p>
External Subject/Catalog Nbr (external subject/catalog number)	<p>After you run the Transfer Credit process for this row of the model, the process displays the external subject and catalog number of each course that it evaluated. The process determines the external subject and catalog number for the transfer course according to the value that is entered for the course in the corresponding fields on the External Courses page of the Education component.</p>

Note: When you post a model, the **Source Information** group box for that row becomes unavailable.

Note: Using the column heading links to sort data on this page may ungroup external and equivalent courses.

Evaluator Details

Select the Evaluator Details tab.

This example illustrates the fields and controls on the Transfer Course Details page: Evaluator Details tab. You can find definitions for the fields and controls later on this page.

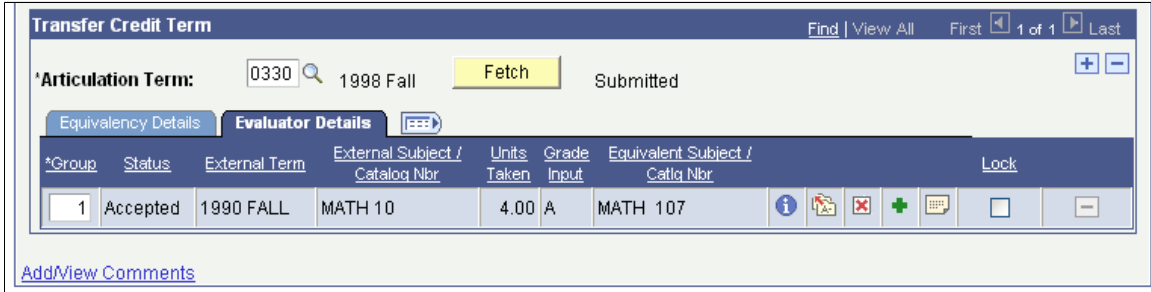

See the previous Common Elements section for information about the icons on this tab.

Calculating and Posting Course Transfer Credit with Predefined Rules

Access the Transfer Summary page (**Records and Enrollment > Transfer Credit Evaluation > Course Credits - Automated > Transfer Summary**).

This example illustrates the fields and controls on the Transfer Summary page. You can find definitions for the fields and controls later on this page.

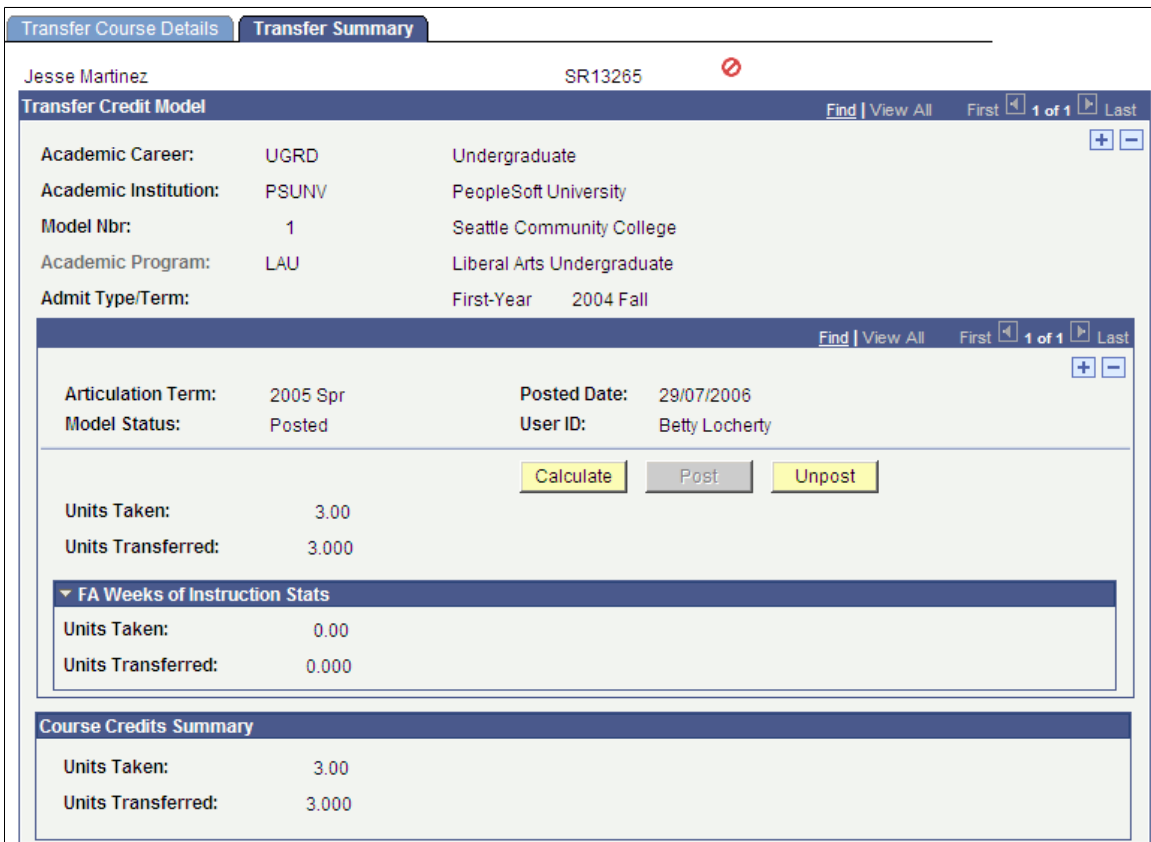

Field or Control	Description
Calculate	<p>After you articulate course credit, click this button to calculate the individual's transfer credit statistics according to the accepted transfer credit on the corresponding row of the model.</p> <hr/> <p>Note: When you post the transfer credit without clicking the Calculate button, the process still calculates the units.</p> <hr/> <p>If you selected to include the accepted equivalent courses of this model in the individual's GPA <i>and</i> you have transferred grades that include grade points, the system calculates the transfer taken for GPA, the transfer passed for GPA, the transfer grade points, and the transfer GPA.</p> <p>If you selected to include the accepted equivalent courses of this model in the individual's GPA <i>and</i> you transferred grades that are not included in, for example, F grade points, the system calculates the transfer taken not for GPA and the transfer passed not for GPA.</p> <p>If you have <i>not</i> selected to include the accepted equivalent courses of this model in the individual's GPA, the system calculates the units taken and the units transferred.</p> <p>You can select to include transfer credit in the GPA for external organizations and internal academic institutions on the Organization Affiliation page.</p>

FA Weeks of Instruction Stats

The group box displays transfer course statistics for courses marked to be included in the Financial Aid weeks of instruction calculations. When articulated transfer work is calculated, these values are calculated and stored in the Include in FA WI Stats area. These values are used by the Financial Aid Term process to then calculate the student's academic level.

Note: The calculation of the FA WI Stats values does not affect the calculation of the current articulated transfer work statistics. In addition, the new values are stored in the transfer credit records and are not moved to PS_STDNT_CAR_TERM.

Field or Control	Description
Units Taken	Displays the units that the individual took for the class being transferred.
Units Transferred	Displays the units of the internal equivalent course.

Course Credits Summary

Use the **Course Credits Summary** group box to view a summary of the course credits that have been transferred to the student's record through this model. You can view changes in this group box only after

you have posted or unposted the model and saved the transaction. The system displays values for the fields in this group box in relation to the corresponding values that you calculated for the model on this page.

Processing Course Transfer Credit Models Manually

Access the Transfer Course Entry page (**Records and Enrollment > Transfer Credit Evaluation > Course Credits - Manual > Transfer Course Entry**).

This example illustrates the fields and controls on the Transfer Course Entry page (1 of 2). You can find definitions for the fields and controls later on this page.

Transfer Course Entry | Course Credits by Term

Jesse Martinez SR13265

Transfer Credit Model Find | View All First 1 of 3 Last

Academic Career: UGRD Undergraduate

Academic Institution: PSUNV PeopleSoft University

***Model Nbr:** 1

***Transcript Level:** Official

Target Information

***Academic Program:** LAU Liberal Arts Undergraduate **Include in GPA**

Academic Plan:

Source Information

***Credit Source Type:** Manual

Source Institution: Seattle Community College

School Type: CC Community College

This example illustrates the fields and controls on the Transfer Course Entry page (2 of 2). You can find definitions for the fields and controls later on this page.

Transfer Credit Term Find | View All First 1 of 1 Last

***Articulation Term:** 0540 2005 Spr Posted

Incoming Course Find | View All First 1 of 1 Last

***Group *Seq#** 1 1

Status: Posted

Year: 2005 **Ext Term:** SPR

Subject: ANTH

Course Nbr: 101

Description: Anthropology Basics

Units Taken: 3.00

Grade Input: B

Equivalent Course Find | View All First 1 of 1 Last

Course ID: 001234 ANTHRO

Offer Nbr: 1 101

Units Transferred: 3.000

Grading Scheme: UGD Undergrad

Grading Basis: GRD Graded

Official Grade: T Transfer

Repeat Code:

Designation: **Include in FA WI Stats**

[Add/View Comments](#)

Target Information

<i>Field or Control</i>	<i>Description</i>
Include in GPA (include in grade point average)	<p>Select to include eligible courses within this model in students' GPA totals and No GPA totals at your academic institution. Clear this check box to include the eligible courses as units only.</p> <p>Eligible courses are those courses with the Include in GPA check box selected on the Equivalent Course Information page. Conversely, ineligible courses are those with the Include in GPA check box cleared on the Equivalent Course Information page.</p> <p>The system renders the Include in GPA field on this page unavailable when the model is posted.</p> <hr/> <p>Note: The Include in GPA check box in the Target Information group box has no impact on the Academic Advisement engine. The Academic Advisement engine looks at the Include in GPA check box on the Equivalent Course Information page to evaluate course grade points for academic requirements and enrollment requisites.</p> <hr/>

Source Information

<i>Field or Control</i>	<i>Description</i>
(AUS) Level of Education	<p>This mandatory field appears only if the school type assigned to the credit has a DEST credit basis of <i>0200 Credit Offered for Prior VET Study</i>.</p> <p>School types are defined on the School Type Table page.</p> <p>This field appears only if the DEST, HECS, Centrelink, TAC check box is selected on the SA Features page.</p>

Transfer Credit Term

<i>Field or Control</i>	<i>Description</i>
Details	Click to access the Equivalent Course Information page, where you can edit equivalent course information prior to posting transfer credit.

Field or Control	Description
Comments	Click to access the Course Credit Comments page, where you can add an override reason and comment about any adjustments that you have made to this row of the model.

Incoming Course

Use the **Incoming Course** group box to define your external course information for this row of the transfer credit model.

Field or Control	Description
Year	Enter the year in which the incoming course was taken.
Ext Term (external term)	Select the external term for each external course that you enter.
Subject	Enter the subject area of the incoming course.
Course Nbr (course number)	Enter the course number for the incoming course.
Description	Enter the description of the incoming course.
Units Taken	Enter the units taken for the incoming course.
Grade Input	Enter the grade received for the incoming course.

Equivalent Course

Use the **Equivalent Course** group box to define the internal course that is equivalent to the incoming course for this row of the transfer credit model. The system matches classes based on year, external term, subject, course number, units taken, and grade input.

Field or Control	Description
Course ID	Select the course that is equivalent to the incoming course for this row. The system prompts you to select a course from your academic institution's course catalog.

Field or Control	Description
Offer Nbr (offering number)	By default, the system displays the offering number of the course that you selected according to the definition of the course in your academic institution's course catalog. You can override this default value.
Units Transferred	<p>If you select the From Incoming Course option on the Academic Career Table page, the value in this field appears by default from the Units Taken field in the Incoming Course group box for the course that has the same group and sequence number.</p> <p>If you select the From Course Catalog option on the Academic Career Table page, the value in this field appears by default from the Maximum Units field in the Course Catalog (CRSE_CATALOG) component.</p> <p>Regardless of the option that you select on the Academic Career Table page, you can override the default value in this field to transfer a different number of units.</p>
Grading Scheme	Select the grading scheme of the specified internal equivalent course. This grading scheme defines all of the valid grading bases from which you can select an official grade for the specified internal equivalent course.
Grading Basis	Select the grading basis for the specified internal equivalent course. This grading basis defines all of the valid grades from which you can select an official grade for the specified internal equivalent course.
Official Grade	<p>Select the official grade of the specified internal equivalent course. This official grade defines the grade that an individual receives for the specified internal equivalent course.</p> <p>The value entered here is included in the student's cumulative GPA at your academic institution, provided that you selected the Include in GPA check box on this page and the Equivalent Course Information page.</p>

Field or Control	Description
Repeat Code	<p>Select a repeat code, if applicable.</p> <p>Repeat codes work in conjunction with repeat rules to determine whether a repeated class violates your repeat policies. When the repeat checking process runs, it searches the student's enrollment history to find class enrollments with matching course IDs. When it finds a match, it determines whether the repeat is legal based on the repeat rules that you define.</p> <p>When the repeat checking process identifies a course that violates a repeat rule, the process assigns the class enrollment a repeat code. This repeat code determines how the class enrollment is treated in the student's academic statistics, such as whether the grade is used to calculate the student's grade point average. The repeat code that the repeat checking process assigns appears here.</p>
Designation	Use this field to select a requirement designation for the class enrollment.
Save	After you select an articulation term and enter the incoming course and internal equivalent course information for this row of the course transfer credit model, click Save .

Related Links

[Viewing Incoming and Editing Equivalent Course Information](#)

[Understanding Repeat Checking Functionality](#)

[Running the Repeat Rule Checking Process in Batch](#)

Calculating and Posting Course Transfer Credit Manually

Access the Course Credits by Term page (**Records and Enrollment > Transfer Credit Evaluation > Course Credits - Manual > Course Credits by Term**).

This example illustrates the fields and controls on the Course Credits by Term page. You can find definitions for the fields and controls later on this page.

Transfer Course Entry
Course Credits by Term

Jesse Martinez
SR13265
⊘

Transfer Credit Model
Find | View All
First 1 of 1 Last

Academic Career:	UGRD	Undergraduate	+ -
Academic Institution:	PSUNV	PeopleSoft University	
Model Nbr:	1		
Academic Program:	LAU	Liberal Arts Undergraduate	
Admit Type/Term:	First-Year	2004 Fall	

Find | View All
First 1 of 1 Last

Articulation Term:	2005 Spr	Posted Date:	29/07/2006
Model Status:	Posted	User ID:	Betty Locherty

Calculate
Post
Unpost

Units Taken:	3.00		
Units Transferred:	3.000		

▼ FA Weeks of Instruction Stats

Units Taken:	0.00		
Units Transferred:	0.000		

Course Credits Summary

Units Taken:	3.00		
Units Transferred:	3.000		

Note: If transfer credit has been posted for a student and then a change is made to his or her record and the data is reposted, an input change flag appears on the page.

FA Weeks of Instruction Stats

The group box displays transfer course statistics for courses marked to be included in the Financial Aid weeks of instruction calculations. When articulated transfer work is calculated, these values are calculated and stored in the Include in FA WI Stats area. These values are used by the Financial Aid Term process to then calculate the student's academic level.

Note: The calculation of the FA WI Stats values does not affect the calculation of the current articulated transfer work statistics. In addition, the new values are stored in the transfer credit records and are not moved to PS_STDNT_CAR_TERM.

<i>Field or Control</i>	<i>Description</i>
Units Taken	Displays the units that the individual took for the class being transferred.
Units Transferred	Displays the units of the internal equivalent course.

Viewing Student Study Agreements

Access the Student Agreements page (click the **Study Agreements** link on the Transfer Course Details page or the Transfer Course Entry page).

Note: If you enter a course that is a duplicate, the system gives you a warning. You can cancel and fix the duplicate or continue with the post. If you continue with the post and attach the external course to both instances of the class, repeat checking will place repeat codes on the class.

<i>Field or Control</i>	<i>Description</i>
Agreement Data	Click to access the Student Agreement Header Info (student agreement header information) page, where you can view header information about the student-specific study agreement.

Viewing Incoming and Editing Equivalent Course Information

Access the Equivalent Course Information page (click the **Edit Equivalent Course** button on the Transfer Course Details page to edit equivalent course information).

This example illustrates the fields and controls on the Equivalent Course Information page. You can find definitions for the fields and controls later on this page.

Equivalent Course Information

Incoming Course

Term Year: 2005 SPR

Subject: ANTH Course Nbr: 101

Description: Anthropology Basics

Units Taken: 3.00 Grade Input: B Crse Level:

Equivalent Course

Course ID: 001234 Introduction to Anthropology

Offer Nbr: 1 ANTHRO 101

Units Transferred: 3.000 Valid Attempt

Grading Scheme: UGD Undergraduate Grading Scheme Grd Pt/Unt: 3.000

Grading Basis: GRD Graded Earn Credit

Official Grade: T Transfer Include in GPA

Repeat Code:

Designation:

Include in FA WI Stats

Units Att: Yes

Incoming Course

Use the **Incoming Course** group box to view details about the external course information for this row of the transfer credit model.

<i>Field or Control</i>	<i>Description</i>
Crse Level (course level)	The level for this course at the specified external organization. Values for this field are delivered with your system as translate values. You can modify these values.

Equivalent Course

Use the **Equivalent Course** group box to enter internal equivalent course information.

Related Links

[Viewing Incoming and Editing Equivalent Course Information](#)

Processing Test Transfer Credit

This section provides an overview of test transfer credit processing and discusses how to:

- Process test transfer credit models with predefined rules.
- Calculate and post test transfer credit with predefined rules.
- Process test transfer credit models manually.
- Calculate and post test transfer credit manually.
- Enter incoming test and equivalent course information.

Understanding Test Transfer Credit Processing

Two components are available to evaluate test transfer credit, the Test Credits - Automated component for predefined rules and the Test Credits - Manual component for creating test credit models manually. After you have set up your test codes and test components and you have read the Processing Course Transfer Credit section, the pages for processing test credit will be familiar.

Use the Test Credits - Automated component if you want to use predefined test transfer equivalency rules to articulate test transfer credit. You can attach predefined rules to academic programs and academic plans. You create models of articulation based on the individual's academic program or academic plan. You can create as many models as necessary.

To process test transfer credit using predefined equivalency rules:

1. Set up the target information for the transfer credit model on the Test Credit Details page.

2. Select the articulation term for the model and tell the system to evaluate the test credit according to the predefined rules on the Test Credit Details page.
3. Calculate transfer credit statistics for the model, post and unpost transfer credit, and view a summary of transfer credit statistics on the Test Credits By Term page.
4. View summary student statistics, after you have saved a posted or unposted model, in the **Total Units - Posted Model** field on the Test Credits by Term page.

Use the Test Credits - Manual component to enter transfer credit manually with equivalencies that you enter as you proceed. This component is designed for test transfer credit from sources from which you rarely receive test results. This saves you from having to go through the rule-defining procedure for a few students.

To process test transfer credit manually:

1. Set up the target information for the transfer credit model on the Test Credit Entry page.
2. Select the articulation term for the model and enter the incoming test and internal equivalent course information on the Test Credit Entry page.

Save the page to run the Transfer Credit process and articulate the test credit.

3. Calculate transfer credit statistics for the model, post and unpost transfer credit, and view a summary of transfer credit statistics on the Test Credits By Term page.
4. View summary student statistics, after you have posted a model, in the **Total Units - Posted Model** field on the Test Credits By Term page.

Pages Used to Process Test Transfer Credit

<i>Page Name</i>	<i>Definition Name</i>	<i>Navigation</i>	<i>Usage</i>
Test Credit Details	TRNS_TEST_DETAIL	Records and Enrollment > Transfer Credit Evaluation > Test Credits - Automated > Test Credit Details	Create test transfer credit models and run the Transfer Credit process to evaluate the models. For each model, specify a target academic program, the academic plan if applicable, and the articulation term. Then run the Transfer Credit process. You can revise the results as necessary.

Page Name	Definition Name	Navigation	Usage
Test Credit by Term	TRNS_TEST_TERM	<ul style="list-style-type: none"> • Records and Enrollment > Transfer Credit Evaluation > Test Credits - Automated > Test Credit by Term • Records and Enrollment > Transfer Credit Evaluation > Test Credits - Manual > Test Credit by Term 	Calculate an individual's transfer credit statistics for a model based on the accepted internal equivalent courses of a transfer credit model. After you view the statistics for the transfer credit model, you can post the transfer credit to an individual's record. You can also use this page to unpost transfer credit.
Test Credit Entry	TRNS_TEST_ENTRY	Records and Enrollment > Transfer Credit Evaluation > Test Credits - Manual > Test Credit Entry	Set up test transfer credit models and articulate transfer credit by creating test transfer models manually rather than by using predefined equivalency rules. This page is essentially the same as the Test Credit Details page of the Test Credits component, with the few exceptions that are described in this section.
Transfer Rule Applied	TRNS_TEST_RULE_SEC	Click the Transfer Status Detail button on the Test Credit Details page.	View the test transfer equivalency rule that the Transfer Credit process applied to the corresponding external course. If the test is rejected, the Reject Reason page displays the reject reason. The Transfer Rule Applied page applies only to transfer credit processing with predefined test equivalency rules.
Reject Reason	TRNS_TEST_REJR_SEC	Click the Transfer Status Detail button on the Test Credit Details page.	View the reason why the test transfer equivalency rule was rejected. This page applies only to transfer credit processing with predefined test equivalency rules.
Equivalent Course Information	TRNS_TEST_INT_SEC	Click the Edit Equivalent Course button on the Test Credit Details page to edit equivalent course information.	View incoming test credit information for a specific row of a test transfer credit model, view and edit equivalent course information, and enter additional equivalent courses and corresponding information.

Page Name	Definition Name	Navigation	Usage
Equivalent Course Information	TRNS_TEST_EDIT_SEC	Click the Edit Equivalent Course button on the Test Credit Entry page.	Add incoming test credit information and internal equivalent course information for a specific row of a test transfer credit model for which you are manually defining equivalencies.
Test Credit Comments	TRNS_TEST_DTL_SEC	Click the Comment/Override Reason button on the Test Credit Details page or the Test Credit Entry page.	Add an override reason and comment about any adjustments that you made to a group row of a transfer credit model.
Model Comments	TRNS_TEST_MOD_SEC	Click the Comment link on the Test Credit Details page or the Test Credit Entry page.	Add comments about this test transfer credit model.

Processing Test Transfer Credit Models with Predefined Rules

Access the Test Credit Details page (**Records and Enrollment > Transfer Credit Evaluation > Test Credits - Automated > Test Credit Details**).

This example illustrates the fields and controls on the Test Credit Details page. You can find definitions for the fields and controls later on this page.

Test Credit Details
Test Credit by Term

Marlo Nascimiento
SR0812

Find | View All
First
1 of 1
Last

Academic Career: UGRD Undergraduate + -

Academic Institution: PSUNV PeopleSoft University

***Model Nbr:**

***Transcript Level:**

Target Information

***Academic Program:** Liberal Arts Undergraduate Include in GPA

Academic Plan:

Find | View All
First
1 of 1
Last

***Articulation Term:** 1999 Spring Posted + -

*Group	Status	Test ID	Test Component	Equivalent Subject / Catlg Nbr	Lock
<input type="text" value="1"/>	Posted	AP	ENGC	ENGLIT 100	🗑️ 🗨️ 🔒
<input type="text" value="2"/>	Posted	AP	FRA	FREN 101	🗑️ 🗨️ 🔒

[Add/View Comments](#)

Field or Control	Description
Fetch	After you select an articulation term for this row of the course transfer credit model, click this button to run the Transfer Credit process. The Transfer Credit process COBOL program evaluates the individual's test transfer credit according to the valid test transfer equivalency rules. The process determines valid course transfer equivalency rules, based on whether the rule is active previous to the begin date of the articulation term and based on whether the rule has been attached to the individual's academic program or academic plan. The process then compares the individual's external test information to the valid rules and calculates the results. The tests that the process evaluates appear in the grid at the bottom of the page. Define test transfer equivalency rules on the Test Credit Rule / Component page and attached to academic programs and academic plans for the source on the Test Credit Equivalency page. An individual's external test information is entered on the Test Results component.
Test ID	After you run the Transfer Credit process for this row of the model, the process displays the identification code of each test that it evaluated. The process determines the individual's tests according to the value entered for the test in the corresponding fields on the Test Results component.
Test Component	After you run the Transfer Credit process for this row of the model, the process displays the component of each test that it evaluated. The process determines the individual's test components according to the value that is entered for the test in the corresponding fields on the Test Results component.

Note: Using the column heading links to sort data on this page may ungroup external and equivalent courses.

Calculating and Posting Test Transfer Credit with Predefined Rules

Access the Test Credit by Term page (**Records and Enrollment > Transfer Credit Evaluation > Test Credits - Automated > Test Credit by Term**).

This example illustrates the fields and controls on the Test Credit by Term page. You can find definitions for the fields and controls later on this page.

Test Credit Entry		Test Credit by Term	
Jesse Martinez		SR13265	
Academic Career:		UGRD	Undergraduate
Academic Institution:		PSUNV	PeopleSoft University
Model Nbr:		1	
Academic Program:		LAU	Liberal Arts Undergraduate
Admit Term:		0530	2004 Fall
Articulation Term:		2006 Fall	Posted Date: 03/25/2008
Model Status:		Posted	User: Betty Locherty
		<input type="button" value="Calculate"/> <input type="button" value="Post"/> <input type="button" value="Unpost"/>	
Units Transferred:		3.000	
FA Weeks of Instruction Stats			
Units Transferred:		3.000	
Test Credits Summary			
Units Transferred:		3.000	

The units of the internal equivalent course appear in the **Units Transferred** field in the **FA Weeks of Instruction Stats** (financial aid weeks of instruction statistics) group box.

Processing Test Transfer Credit Models Manually

Access the Test Credit Entry page (**Records and Enrollment > Transfer Credit Evaluation > Test Credits - Manual > Test Credit Entry**).

This example illustrates the fields and controls on the Test Credit Entry page. You can find definitions for the fields and controls later on this page.

The screenshot shows the 'Test Credit Entry' page for user Marlo Nascimienta (SR0812). The page includes the following fields and controls:

- Academic Career:** UGRD (Undergraduate)
- Academic Institution:** PSUNV (PeopleSoft University)
- *Model Nbr:** 1
- *Transcript Level:** Unofficial
- Target Information:**
 - *Academic Program:** LAU (Liberal Arts Undergraduate)
 - Academic Plan:** (Empty field)
 - Include in GPA**
- *Articulation Term:** 0350 (1999 Spring, Posted)
- Table of Articulation Terms:**

*Group	*Seq#	Status	Test ID	Test Component	Equivalent Subject / Catlg Nbr
1	1	Posted	AP	ENGC	ENGLLIT 100
2	1	Posted	AP	FRA	FREN 101

Field or Control	Description
Test ID	After you select a test ID on the Equivalent Course Information page for this row of the model, the system displays your selection in this field. You access the Equivalent Course Information page by clicking the Edit Equivalent Course button on the corresponding row of the model.
Test Component	After you select a test component on the Equivalent Course Information page for this row of the model, the system displays your selection in this field. You access the Equivalent Course Information page by clicking the Edit Equivalent Course button on the corresponding row of the model.
Save	After you select an articulation term and enter the incoming test credit and internal equivalent course information for this row of the test transfer credit model, click Save to run the Transfer Credit process. The Transfer Credit process COBOL engine evaluates the individual's test transfer credit according to the test credit and internal equivalent information on the Incoming Course information page.

Calculating and Posting Test Transfer Credit Manually

Access the Test Credit by Term page (**Records and Enrollment > Transfer Credit Evaluation > Test Credits - Manual > Test Credit by Term**).

The Test Credit by Term page in the Test Credits - Manual component is the same page as the Test Credits By Term page in the Test Credits Component.

Related Links

[Calculating and Posting Course Transfer Credit Manually](#)

Entering Incoming Test and Equivalent Course Information

Access the Equivalent Course Information page (click the **Edit Equivalent Course** button on the Test Credit Entry page).

This example illustrates the fields and controls on the Equivalent Course Information page . You can find definitions for the fields and controls later on this page.

Equivalent Course Information

Test Credit Input	
Test ID:	AP Adv Plcmnt
Component:	EH European Hist/World Cultures
Data Source:	ACT Test Score: 4.00
Test Date:	05/12/2006 Percentile:

Equivalent Course	
Course ID:	003274 Surv Brit Lit
Offer Nbr:	1 ENGLIT 100
Units Transferred:	3.000 <input checked="" type="checkbox"/> Valid Attempt
Grading Scheme:	UGD Undergraduate Grading Scheme <input checked="" type="checkbox"/> Earn Credit
Grading Basis:	GRD Graded <input type="checkbox"/> Include in GPA
Official Grade:	T Transfer Grd Pt/Unt: 3.000
Repeat Code:	Units Att: Yes
Designation:	<input type="text"/> <input checked="" type="checkbox"/> Include in FA WI Stats

Test Credit Input

Use the **Test Credit Input** group box to enter test information.

<i>Field or Control</i>	<i>Description</i>
Test ID	The identification number of the test for which you are defining a course equivalency.
Component	The component of the test for which you are defining a course equivalency.

Field or Control	Description
Test Date	The date that the test was taken.
Test Score	The individual's test score.
Data Source	The data source.
Percentile	The percentile of the individual's score.

Equivalent Course

Use the **Equivalent Course** group box to enter internal equivalent course information.

Processing Other Transfer Credit

This section provides an overview of other transfer credit processing and discusses how to:

- Process other transfer credit models.
- Calculate and post other transfer credit.
- Add incoming other credit and equivalent course information.

Understanding Other Transfer Credit Processing

Processing other transfer credit, credit for prior learning, is always a manual process. The pages in the Other Credit component are very similar to those in the Course Credit and Test Credit components. After you have read the Processing Course Transfer Credit section, the pages for processing other credit will be familiar.

The other credit category is appropriate because it requires no external organization information. However, you must assign other credit through a course in your academic institution's course catalog. Therefore, you might set up special summary courses in the course catalog, then grant the student additional transfer credits using these special courses.

To process other transfer credit:

1. Set up the target information for the transfer credit model on the Other Credit Detail page.
2. Select the articulation term for the model and enter the equivalent course information on the Other Credit Detail page.
3. Calculate transfer credit statistics for the model, post and unpost transfer credit, and view a summary of transfer credit statistics on the Other Credit By Term page.

4. View summary student statistics, after you have posted a model, in the **Total Units - Posted Model** field on the Test Credits By Term page.

Pages Used to Process Other Transfer Credit

<i>Page Name</i>	<i>Definition Name</i>	<i>Navigation</i>	<i>Usage</i>
Other Credit Detail	TRNS_OTHR_DETAIL	Records and Enrollment > Transfer Credit Evaluation > Other Credits - Manual > Other Credit Detail	Set up other transfer credit models and articulate transfer credit. For each model, you specify target information, the articulation term, other credit information, and internal equivalent course information.
Other Credit by Term	TRNS_OTHR_TERM	Records and Enrollment > Transfer Credit Evaluation > Other Credits - Manual > Other Credit by Term	Calculate transfer units statistics for a model, post and unpost transfer credit, and view a summary of transfer credit statistics.
Equivalent Course Information	TRNS_OTHR_EDIT_SEC	Click the Edit Equivalent Course button on the Other Credit Detail page.	Add incoming other credit information and internal equivalent course information for a specific model. You can also use this page to edit information that you have previously saved.
Other Credit Comments	TRNS_OTHR_DTL_SEC	Click the Comment/Override Reason button on the Other Credit Detail page.	Add an override reason and comment about any adjustments that you have made to a group row of a transfer credit model.
Model Comments	TRNS_OTHR_MOD_SEC	Click the Comment button on the Other Credit Detail page.	Add comments about this row of the transfer credit model.

Processing Other Transfer Credit Models

Access the Other Credit Detail page (**Records and Enrollment > Transfer Credit Evaluation > Other Credits - Manual > Other Credit Detail**).

This example illustrates the fields and controls on the Other Credit Detail page. You can find definitions for the fields and controls later on this page.

Field or Control	Description
Other Credit	After you enter other credit on the Equivalent Course Information page for this row of the model, the process displays your selection in this field. You access the Equivalent Course Information page by clicking the Edit Equivalent Course button on the corresponding row of the model.
Save	After you select an articulation term and enter the incoming other credit and internal equivalent course information for this row of the other transfer credit model, click Save .

Calculating and Posting Other Transfer Credit

Access the Other Credit by Term page (**Records and Enrollment > Transfer Credit Evaluation > Other Credits - Manual > Other Credit by Term**).

This example illustrates the fields and controls on the Other Credit by Term page. You can find definitions for the fields and controls later on this page.

The screenshot displays the 'Other Credit by Term' page for student Jesse Martinez (SR13265). The page is divided into several sections:

- Student Information:** Jesse Martinez, SR13265.
- Academic Career:** UGRD Undergraduate.
- Academic Institution:** PSUNV PeopleSoft University.
- Model Nbr:** 1.
- Academic Program:** LAU Liberal Arts Undergraduate.
- Admit Term:** 2004 Fall.
- Articulation Term:** 2007 Fall.
- Posted Date:** 03/25/2008.
- Model Status:** Posted.
- User:** Betty Locherty.
- Buttons:** Calculate, Post, Unpost.
- Units Transferred:** 3.000.
- FA Weeks of Instruction Stats:**
 - Units Transferred: 3.000
- Other Credits Summary:**
 - Units Transferred: 3.000

The units of the internal equivalent course appear in **Units Transferred** field in the **FA Weeks of Instruction Stats** (financial aid weeks of instruction statistics) group box.

Adding Incoming Other Credit and Equivalent Course Information

Access the Equivalent Course Information page (click the **Edit Equivalent Course** button on the Other Credit Detail page).

This example illustrates the fields and controls on the Equivalent Course Information page. You can find definitions for the fields and controls later on this page.

Equivalent Course Information

Other Credit

Other Credit: **Short Desc:**

Long Description:

Other Credit Type: **Evaluation Date:**

Equivalent Course

Course ID: Calculus I for Engineering

Offer Nbr: MATH 121

Units Transferred: **Valid Attempt**

Grading Scheme: Undergraduate Grading Scheme **Earn Credit**

Grading Basis: Graded **Include in GPA**

Official Grade: Transfer **Grd Pt/Unt:** 3.000

Repeat Code: **Units Att:** Yes

Designation:

Include in FA WI Stats

Other Credit

Use the **Other Credit** group box to enter information about other credit.

<i>Field or Control</i>	<i>Description</i>
Other Credit	Enter a description of the other credit.
Short Desc (short description)	Enter a short description of the other credit.
Long Description	Enter a long description of the other credit.
Other Credit Type	Select the type of other credit. Values for this field are delivered with your system as translate values. You can modify these values.
Evaluation Date	Enter the evaluation date of the other credit.
Clear Credit	Click to clear the fields in the Other Credit group box. This button works for new data that you are entering and data that you have previously saved in the fields.

Equivalent Course

Use the **Equivalent Course** group box to enter internal equivalent course information.

Processing Transfer Credit in Batch

This section provides an overview of batch transfer credit processing and discusses how to:

- Post transfer credit in batch.
- View process results for batch posting of transfer credit.

Understanding Batch Transfer Credit Processing

Processing a student's transfer credit can be a complicated and time-consuming process. Aside from transferring credit from an external organization to your academic institution, you might want to move a student's credit from one academic career to another or from one internal academic institution to another.

To facilitate processing transfer credit, use the Batch Transfer Credit feature. This feature enables you to process transfer credit by batch, simplifying your online data entry and reducing processing time. Provided that you have already entered the student's external education record and defined the transfer credit equivalency rules, you can submit a request to have transfer credit modeled for a group of students who match the parameters that you specify. When you submit your request, the system performs the model setup, transfer articulation, and posting processes for all students in the group.

To process transfer credit by batch:

1. Define the posting process on the Process Definitions page.
2. Define the processing parameters—the group of students to process by batch—on the Transfer Credit Batch page, then run the process through PeopleSoft Process Scheduler.

Pages Used to Process Transfer Credit in Batch

<i>Page Name</i>	<i>Definition Name</i>	<i>Navigation</i>	<i>Usage</i>
Transfer Credit Batch	RUNCTL_SR_TRCRBP	Records and Enrollment > Transfer Credit Evaluation > Batch Posting > Transfer Credit Batch	Post transfer credit in batch. Process parameters include the student's identification code and the keys that the system will use in retrieving incoming transfer credit, plus the target academic career, academic program, academic plan (where applicable), and articulation term.

Page Name	Definition Name	Navigation	Usage
Process Results	RUNCTL_SR_TRCRBPER	Records and Enrollment > Transfer Credit Evaluation > Batch Posting > Process Results	View information that is related to the process that you have run on the Transfer Credit Batch page. To view a student's statistics after you run the process, go to the student's individual transfer credit record on the appropriate component—either external course credit, test credit, or other credit.

Posting Transfer Credit in Batch

Access the Transfer Credit Batch page (**Records and Enrollment > Transfer Credit Evaluation > Batch Posting > Transfer Credit Batch**).

This example illustrates the fields and controls on the Transfer Credit Batch page. You can find definitions for the fields and controls later on this page.

Field or Control	Description
Group Nbr (group number)	The group number is the numeric counter that distinguishes each row of the process instance from other rows. By default, the system displays the first group as 1 and increases the number by one as you add groups to the process instance.
Description	Enter a description of the group to uniquely identify the group.

Field or Control	Description
Processing Option	<p>Select from the following values the processing option to use for this run of the process. Depending on the option that you select, you can create models in batch, post models in batch, or do both at the same time.</p> <p><i>Create Model:</i> Select to create transfer credit models based on the student external education record for external transfers or based on the academic career record for internal transfers.</p> <p><i>Post Model:</i> Select to post models that have already been created. If the student is active in the articulation term and academic program that you select, the system posts the transfer credit to each affected student's career term record, sets the transfer model to posted, then automatically runs the Repeat Checking process. If a student is not active in the articulation term and academic program that you select, the system does not post the transfer model. Instead, the system sets the transfer model status to <i>Completed</i>. When the student is activated for the specified academic program and articulation term, you can move the transfer statistics to the student's career term record using the transfer credit copy function on the Terms in Residence page.</p> <p><i>Create and Post Model:</i> Select to create the model and then post it in the same run of the process.</p>
Apply Agreement	<p>Select to have the Transfer Credit process use the <i>agreement</i> equivalency rule that is selected for the specified academic program, academic plan, and source combination on the Rules Specification page. Clear this check box to ignore the specified agreement equivalency rule. By default, the system selects this check box.</p>
Overlay Unposted Models	<p>Select if you are rerunning the batch and you want to overlay any unposted models.</p>
Transcript Level	<p>Select a specific transcript level. If left blank, the default set at <i>Academic Career</i> is used.</p>

Transfer Credit Source

In the **Transfer Credit Source** group box, select the type of source from which you will be modeling transfer credit for this group. Your selection instructs the system from which table you will be selecting your source.

Field or Control	Description
External	<p>Select to have the system prompt you with the source IDs of external organizations in your system. The External Org ID and Data Source fields appear and are available.</p>

Field or Control	Description
Internal	Select to have the system prompt you with source IDs of academic institutions in your system. You would select this option, for example, when a student is transferring from one academic career to another within your academic institution. The Source Career and Source Institution fields appear and are available.
External Org ID (external organization identification)	For an external transfer credit source, select the external organization from which you are processing transferring credit.
Data Source	For an external transfer credit source, select the data source from which the individual's external transfer credit has been entered into the system. Values for this field are delivered with your system as translate values. You can modify these values.
Source Career	For an internal transfer credit source, select the academic career from which you are processing transfer credit.
Source Institution	For an internal transfer credit source, select the internal academic institution from which you are processing transferring credit.

Transfer Credit Target

Use the grid in the lower portion of the page to enter student ID and target information within your academic institution for each student for whom you want to process transfer credit by batch within the group.

Field or Control	Description
ID	Select the identification code of each student for whom you want to process transfer credit in the group. The system prompts you with IDs from the personal data table (PERSONAL_DATA).
Academic Career	Select the academic career to which the specified student's transfer courses will articulate.
Academic Institution	Select the academic institution to which the specified student's transfer courses will articulate.

Field or Control	Description
Academic Program	Select the academic program to which this student's transfer in this row credit will articulate.
Academic Plan	Select the academic plan to which the specified student's transfer credit in this row will articulate. This field is optional. However, if an academic plan is specified, the individual must be active in that academic plan before the transfer credit is posted.
Articulation Term	Select the term for which you want to process the specified student's transfer credit for this row. Note that you cannot articulate credits across multiple terms by inserting additional rows for the student. You would do this, for example, if a student has continually taken credit outside your academic institution over time and you have posted credit at each point in time.

Run the Transfer Credit Batch Posting job (SRPCTCBJ) as needed. The job consists of two processes—the Transfer Credit Batch Posting process and the Repeat Rule Driver process (SRPCERTD). Both processes are COBOL/SQL.

Depending on the processing options that you select, the Transfer Credit Batch Posting process performs one of the following actions: creates transfer credit models, posts transfer credit, or creates models and posts transfer credit by batch, for the defined group of students. When you initiate the process with the latter option set, the process goes through the records of each student that you have entered and validates your input parameters, creates the transfer credit model, calculates transfer credit articulation, and posts the credits to the student's academic career term. Students can be in multiple groups in the same run control process for which transfer work for multiple institutions exists.

If you need to change the results, you can do so on a student-by-student basis by editing the transfer credit model that the background process creates. You adjust the results the same way that you would adjust them if you were modeling one student at a time. First, unpost the transfer credit. Then adjust one or more courses manually. Finally, repost the transfer credit.

The Repeat Rule Driver process launches the Repeat Checking process, checking the newly posted course credit on each affected student's career term record against existing course credit to identify repeated courses.

Note: The system uses the begin date of the articulation term as the effective date when validating which equivalency rules are valid.

Viewing Process Results for Batch Posting of Transfer Credit

Access the Process Results page (**Records and Enrollment > Transfer Credit Evaluation > Batch Posting > Process Results.**).

<i>Field or Control</i>	<i>Description</i>
Refresh	Click to display the messages and description of the process instance. If you rerun the process, click this button to view the messages and descriptions from the most recent run. The system populates the page with the most recent message log information.

Viewing and Printing Transfer Credit Information

This section discusses how to:

- View academic test summaries.
- View schools by group.
- Retrieve transfer credit summaries.
- View and print transfer credit summaries.
- Print transfer credit summaries in batch.

Pages Used to View and Print Transfer Credit Information

<i>Page Name</i>	<i>Definition Name</i>	<i>Navigation</i>	<i>Usage</i>
Academic Test Summary	STDNT_TEST_SUMMARY	Records and Enrollment > Transfer Credit Evaluation > Academic Test Summary > Academic Test Summary	View a summary of academic test information for prospects and applicants, such as test score and data source.
Organization Groups Summary	ORG_GROUP_SUMM	Records and Enrollment > Transfer Credit Rules > Schools by Group > Organization Groups Summary	View schools, or any type of organization, in groups that you designate. You can display the list in the order that you choose.
Transfer Credit Summary - Selection Criteria	SRTC_RPT_DTL	Records and Enrollment > Transfer Credit Evaluation > Transfer Credit Summary > Selection Criteria	Define the selection criteria to search for transfer credit summaries.
Transfer Credit Summary - Selection Result	SRTC_RPT_DTL_RSLT	Records and Enrollment > Transfer Credit Evaluation > Transfer Credit Summary > Selection Result	View and print transfer credit summaries for individuals. The system displays transfer credit summaries based on your selection criteria on the Selection Criteria page.

<i>Page Name</i>	<i>Definition Name</i>	<i>Navigation</i>	<i>Usage</i>
Evaluation Reports	RUNCTL_SR_TRCR_RPT	Records and Enrollment > Transfer Credit Evaluation > Transfer Evaluation Report > Evaluation Reports	Print transfer credit summary evaluation reports for multiple individuals at the same time.

Viewing Academic Test Summaries

Access the Academic Test Summary page (**Records and Enrollment > Transfer Credit Evaluation > Academic Test Summary > Academic Test Summary**).

Related Links

“Tracking Test Results for Prospects and Applicants” (Recruiting and Admissions)

Viewing Schools by Group

Access the Organization Groups Summary page (**Records and Enrollment > Transfer Credit Rules > Schools by Group > Organization Groups Summary**).

Related Links

“Viewing Organizations by Group Types” (Campus Community Fundamentals)

Retrieving Transfer Credit Summaries

Access the Transfer Credit Summary - Selection Criteria page (**Records and Enrollment > Transfer Credit Evaluation > Transfer Credit Summary > Selection Criteria**).

<i>Field or Control</i>	<i>Description</i>
ID	Select the ID of the individual whose transfer credit summary you want to view or print. The system prompts you with IDs from the personal data table (PERSONAL_DATA).
Academic Institution	Select the academic institution for which the specified individual's transfer credit was processed.
All Careers	Select to retrieve transfer credit summaries for all academic careers that are associated with the specified individual.
Career/Program/Plan	Select to retrieve the specified individual's transfer credit summaries within a specific academic career, target academic program, and target academic plan. The Academic Career , Academic Program , and Academic Plan fields become available when you select this option.

Field or Control	Description
Academic Career	Select a specific academic career for which you want to retrieve the specified individual's transfer credit summaries.
Academic Program	Select a specific academic program for which you want to retrieve the specified individual's transfer credit summaries.
Academic Plan	Select a specific academic plan for which you want to retrieve the specified individual's transfer credit summaries.
Posted Status	<p>This filter option enables you to retrieve transfer credit summaries for the specified individual, based on transfer status. Values are:</p> <p><i>All</i>: Enables you to retrieve all transfer credit summaries regardless of transfer status.</p> <p><i>Completed</i>: Enables you to retrieve only transfer credit summaries in which transfer credit has been evaluated and models created but the individual does not yet have an academic program, academic plan, and term activation record for the academic program and articulation term as defined on the transfer credit model.</p> <p><i>Modeled</i>: Enables you to retrieve only transfer credit summaries in which models have been created.</p> <p><i>Posted</i>: Enables you to retrieve transfer credit summaries for transfer credit that have been posted to a student's career term records (STDNT_CAR_TERM table). This differs from the <i>Completed</i> status because the individual has an academic program, academic plan, and term activation record for the academic program and articulation term as defined on the transfer credit model.</p>
Articulation Term	This filter option enables you to select a specific term for which transfer credit has been processed. The system displays only models that have been processed for the articulation term that you specify.
Articulation Term	<p>This sort order option enables you to view and print models based on the begin date of the articulation term. Two options are available: <i>Ascending</i> and <i>Descending</i>. <i>Ascending</i> prints models from the oldest to the newest articulation term.</p> <p><i>Descending</i> prints models from the newest to the oldest articulation term.</p>
Submit	After you have defined your selection criteria and filtering options, click this button to retrieve the transfer credit summaries for the specified individual according to your selection criteria. When the retrieval process is complete, the system automatically displays the Selection Result page.

Viewing and Printing Transfer Credit Summaries

Access the Transfer Credit Summary - Selection Result page (**Records and Enrollment > Transfer Credit Evaluation > Transfer Credit Summary > Selection Result**).

<i>Field or Control</i>	<i>Description</i>
Generate Report	<p>Click to run the SQR (Structured Query Report) report (SRTCSTEV). The report contains the same information as the summary page with the addition of a Repeat field for a student who has already completed course work at the institution. The report is designed in an easy-to-read format intended to be distributed to prospects, applicants, students, recruiters, or advisors. They can see what classes transferred and to which equivalent classes. They can also view their internal and external GPAs.</p> <hr/> <p>Important! To print the report, you must first make some changes to your run control definitions.</p> <hr/>
Articulation Term	The articulation term for which the transfer credit was processed.
Group	The group number within the model that associates incoming transfer credit with its internal equivalent courses. The number in this field identifies the group as unique among other groups.
Model Status	The status of the transfer credit model. Values are: <i>Submitted</i> , <i>Completed</i> , and <i>Posted</i> .
External Subject / Catalog Nbr (external subject/catalog number)	The external subject and catalog number of the class being transferred.
Units Taken	The units that the individual took for the class being transferred.
Grade Input	The grade that the individual received for the class being transferred.
Status	The transfer status of the credit being transferred. Possible transfer status values are <i>Accepted</i> , <i>Contingent</i> , <i>Posted</i> , <i>No Rule</i> , and <i>Rejected</i> .
Equivalent Subject / Catlg Nbr (equivalent subject/catalog number)	The subject and catalog number of the internal course that is equivalent to the transfer credit.
Units Transferred	The units of the internal equivalent course.
Official Grade	The individual's official grade for the internal equivalent course.

Field or Control	Description
Reject Reason	If the transfer credit was rejected, the system displays the reject reason.

Printing Transfer Credit Summaries in Batch

Access the Evaluation Reports page (**Records and Enrollment > Transfer Credit Evaluation > Transfer Evaluation Report > Evaluation Reports**).

Field or Control	Description
Academic Institution	Click to select the academic institution for which transfer credit was processed.
Academic Career	Select a specific academic career for which you want to retrieve the transfer credit summaries.
Academic Program	Select a specific academic program for which you want to retrieve the transfer credit summaries.
Academic Plan	Select a specific academic plan for which you want to retrieve transfer credit summaries.
Posted Status	<p>This filter option enables you to retrieve transfer credit summaries based on transfer status. Values are:</p> <p><i>All</i>: Enables you to retrieve all transfer credit summaries regardless of transfer status.</p> <p><i>Completed</i>: Enables you to retrieve only transfer credit summaries in which transfer credit has been evaluated and models created but the individual does not yet have an academic program, academic plan, and term activation record for the academic program and articulation term, as defined on the transfer credit model.</p> <p><i>Modeled</i>: Enables you to retrieve only transfer credit summaries in which models have been created.</p> <p><i>Posted</i>: Enables you to retrieve transfer credit summaries for transfer credit that has been posted to a student's career term records (STDNT_CAR_TERM table). This differs from the <i>Completed</i> status because the individual is a matriculated student who has an academic program, academic plan, and term activation record for the academic program and articulation term, as defined on the transfer credit model.</p>
Articulation Term	This filter option enables you to select a specific term for which transfer credit has been processed. The system displays only models that have been processed for the articulation term that you specify.

Field or Control	Description
Order By	<p>In the Sort Order group box, select the order in which you want the system to sort the transfer credit summaries. Values are:</p> <p><i>Name</i>: The system prints transfer credit summary reports in alphabetical order by last name, first name.</p> <p><i>ID</i>: The system prints transfer credit summary reports in ID order.</p>
Submit	<p>After you have defined selection criteria and filtering options, click this button to run the Student Transfer Credit Evaluation SQR report (SRTCSTEV), using PeopleSoft Process Scheduler, for the specified individual according to your selection criteria.</p>

Viewing Transfer Credit Reports Through Self Service

If your institution has licensed PeopleSoft Campus Self Service, your instructors can view transfer credit reports directly over the web.

Related Links

“Viewing Transfer Credit Reports Through Self-Service Pages” (Campus Self Service)

Evaluating Transfer Credit Through Self Service

If your institution has licensed PeopleSoft Campus Self Service, your self-service users can create course transfer credit models based on transfer courses from external organizations or from internal academic careers and programs.

Related Links

“Evaluating Transfer Credit Through Self-Service Pages” (Campus Self Service)

Tracking Attendance

Understanding Attendance Tracking

Depending on your business requirements, you might need to track student attendance. Some state agencies require institutions to track student attendance by hours or minutes. Often attendance tracking affects funding decisions. Using the PeopleSoft Campus Solutions Attendance Tracking feature, you can meet these needs. The Attendance Tracking feature enables you to record all of the necessary details about a period of interaction between your students and instructors. You can do the following:

- View attendance records online or print them for manual use.
- Track a wide range of attendance statistics, such as late arrivals and time spent in class.
- Track student attendance in a class section, component, or unit of instruction.
- Generate attendance rosters for individual classes or for multiple classes.
- Track student attendance in any type of course, such as traditional courses, remedial courses, contract courses, extension courses, and courses with nontraditional modes of delivery (such as online instruction, modular instruction, open entry and open exit, distance learning, and so on).
- Create attendance rosters for non-classroom events, such as field trips.

Generating Attendance Rosters

After you schedule classes and enroll students, you can create attendance rosters by using either the Class Attendance page or the Attendance Roster Generator page. Through the Class Attendance page, you can create attendance rosters for one class meeting or for all class meetings within a single scheduled class. Through the Attendance Roster Generator page, you can create attendance rosters for all scheduled classes or for a selection of scheduled classes, within a term.

Each class meeting has its own roster, which comprises the student name and ID, term, session, class section, meeting pattern, attendance date, attendance type, contact hours, and each student's attendance record. The attendance type and the type of student attendance data that you can track are defined on the Course Catalog - Component page. You can use any of these three pages to access the attendance rosters that you generate—each page offers both a different view and a different method of access.

When you generate attendance rosters, the system creates a roster for every scheduled class meeting within your processing parameters and creates a template (a data entry page where you can enter attendance detail for each student) for each class meeting date. You can add new templates, thus adding attendance rosters for class meetings that are not officially scheduled (for example, a field trip to the observatory). For each class meeting, you can view student attendance details. If necessary, you can insert new rows for students who are not formally enrolled in the class (for example, a student who is participating in the class and planning to enroll if space on the waiting list becomes available).

With either attendance roster generation process (batch or online), you can populate your attendance rosters either by downloading from student enrollment (select the Populate from Student Enroll check box) or by building your attendance rosters from scratch (clear the Populate from Student Enroll check box). If you populate your attendance rosters by downloading from student enrollment, the system populates each roster with student names and IDs. If you choose to build an attendance roster, generate the attendance rosters and the system creates blank templates for each class meeting. Each template has the class attendance date and contact hours, based on the class meeting pattern in the schedule of classes and the class meeting attendance type that your institution uses. You can then use the Class Attendance page to scroll through the class meeting dates, select the specific class meeting dates for which to generate attendance rosters, and populate each of these specific class meeting rosters from student enrollment by clicking the **Create** button that corresponds to each of these class meetings. You can also enter student IDs by using the Class Attendance page, the Class Attendance By Template page, or the Student Attendance page. Changes that you make on any of these pages are immediately visible in all three components.

After you generate attendance rosters, you can use the Class Attendance page, the Class Attendance By Template page, and the Student Attendance page to track student attendance. Each page provides you with a different view and a different method of access.

Note: You can track events that are not course-related using the Plan Events component in PeopleSoft Campus Community.

Generating Individual Class Attendance Rosters

To generate an attendance roster for a single class:

1. Access the Attendance Roster By Class page and click the **Generate** button to generate templates for every class meeting within a scheduled class, or click the **Create** button to generate a template for a single class meeting.
2. Click the **View** button to access the Class Attendance Detail page and enter attendance for a specific meeting online.
3. (Optional) Print the roster for an individual meeting by clicking the meeting button.

Prerequisites

Schedule the class and assign at least one attendance type on the Schedule of Classes - Basic Data page. The classes for which you generate attendance rosters must have scheduled meeting patterns, and the Generate Class Meeting Attendance check box must be selected on both the Course Catalog - Components page and Schedule of Classes - Basic Data page.

Pages Used to Generate Individual Class Attendance Rosters

Page Name	Definition Name	Navigation	Usage
Attendance Roster By Class	CLASS_ATTENDANCE	Curriculum Management > Attendance Roster > Attendance Roster By Class > Attendance Roster By Class	Generate or update attendance rosters for individual classes and class meetings. You can also use this page to track student attendance and view, update, and print the attendance rosters for each class meeting.
Class Attendance	CLASS_ATTEND_RSTR	Click the View button on the Attendance Roster By Class page.	Track student attendance for a class meeting.

Generating Attendance Rosters for Individual Classes

Access the Attendance Roster By Class page (**Curriculum Management > Attendance Roster > Attendance Roster By Class > Attendance Roster By Class**).

This example illustrates the fields and controls on the Attendance Roster By Class page. You can find definitions for the fields and controls later on this page.

Attendance Roster By Class

Course ID: 003274	Term: 2003 Fall
Course Name: Surv Brit Lit	Session: Regular Academic Session
Subject / Catalog#: ENGLIT 100	Institution: PeopleSoft University
Class Nbr: 1111	Instructor:
Class Section: 1	

Generate
 Populate from Student Enroll
 Generate Class Mtg Attendance

[Report Manager](#)

Student Attendance Roster											
Customize Find View All First 1-6 of 45 Last											
				Template Nbr	Type	*Attendance Date	*From Time	*To Time	Contact Minutes	Override	
1	Create	Print	View	1	Class Meeting	08/27/2003	11:00AM	11:50AM	50	<input type="checkbox"/>	+ -
2	Create	Print	View	2	Class Meeting	08/29/2003	11:00AM	11:50AM	50	<input type="checkbox"/>	+ -
3	Create	Print	View	3	Class Meeting	09/03/2003	11:00AM	11:50AM	50	<input type="checkbox"/>	+ -
4	Create	Print	View	4	Class Meeting	09/05/2003	11:00AM	11:50AM	50	<input type="checkbox"/>	+ -
5	Create	Print	View	5	Class Meeting	09/08/2003	11:00AM	11:50AM	50	<input type="checkbox"/>	+ -

When you change attendance rosters using the Attendance Roster By Class page, the system reflects these changes on the Class Attendance By Template page and the Student Attendance page.

Field or Control	Description
Generate	<p>Click to create attendance rosters for all class meetings within this scheduled class. The system populates the grid with templates for each class meeting.</p> <p>When you click the Generate button, it is important to remember that the system always uses the class meeting attendance type defined on the Academic Institution 3 page.</p>
Report Manager	<p>Click to print generated attendance rosters for all class meetings.</p>
Populate from Student Enroll	<p>Select to have the system populate attendance rosters with the enrolled students for every class meeting within this scheduled class when you generate or create attendance rosters. The system selects this check box by default.</p> <p>If you clear this check box and click the Generate button, the system creates blank attendance rosters for every class meeting. You can then scroll through the class meeting dates in the grid located in the lower portion of the page, select the View link for the specific class meeting dates for which to track attendance, and manually enter student IDs.</p>
Processing Options	<p>Select one of the three radio buttons to specify the type of process to run. These work in concert with the Generate button only. These do not work in concert with the Create button. Values are the following:</p> <p><i>Create:</i> Select this option when you want to create new rosters or replace old ones.</p> <p><i>Update Attendance/All Students:</i> Select this option when you want to add, but not delete students from the specified group of rosters. Students who have dropped are set to inactive status by having the Present flag set to Off. The system adds new students to the rosters, but only marks these students as present for the class sessions that occur after the add date.</p> <p><i>Update Attendance/Active Only:</i> Select this option if you want to add and delete students from the roster based on their current enrollment statuses in the course for the specified group of attendance rosters. The add and drop date on the STDNT_ENRL table determines how rosters are updated. Use this option when a student drops a class and you want to remove the student and leave no attendance history.</p>

Field or Control	Description
<p>Attendance From Date and Attendance To Date</p>	<p>Use the Attendance From Date and the Attendance To Date fields to specify the range of rosters to update. These fields appear only for classes where the Generate Class Meeting Attendance check box is selected on the Components and Basic Data pages. If displayed, the system populates the fields with the class begin and end date, as specified on the schedule of classes. You can change these values. If you manually change the attendance from and to date range, the system creates or updates rosters for meetings that are greater than or equal to the Attendance From Date field and less than or equal to the Attendance To Date field.</p> <hr/> <p>Note: A student might appear twice on an attendance roster because enrollment is keyed by academic career. For instance, a student might enroll in a class twice, each time through a different academic career and would thus appear on the attendance record twice.</p> <p>If students add, drop, or change their personal data in a class after you have generated the attendance roster, you can click the Create button to generate new attendance rosters. Provided that you select the Populate from Student Enroll check box, the system generates new rosters that include these changes. You can also click the Create button to generate new attendance rosters when the class meeting pattern in the schedule of classes changes. For example, perhaps the class meeting time is rescheduled from 8:00 a.m. to 9:00 a.m., or class meeting dates are changed from <i>MWF</i> to <i>TR</i>. You can regenerate the class meeting attendance rosters to reflect the new date or time.</p> <hr/> <p>Warning! The Generate button always functions as though you are generating attendance rosters from scratch. Therefore, if you have already entered student attendance data into any of the attendance rosters, you should click the Create button associated with each individual attendance roster template.</p> <p>You should <i>not</i> click the Generate button or you will lose the attendance data that you have already entered into the rosters.</p> <hr/>
<p>Generate Class Mtg Attendance (generate class meeting attendance)</p>	<p>This check box is a display-only check box on this page and is set on the Schedule of Classes - Basic Data page. It determines whether the class can be included in batch roster generation, and it affects which radio buttons and from and to date fields appear.</p>

Field or Control	Description
Create	<p>Click this button on the corresponding meeting row to generate or regenerate an attendance roster for that class meeting row. The system automatically populates the template by downloading data from student enrollment regardless of whether you select the Populate From Student Enroll check box.</p> <p>You can use the Create button to generate attendance rosters that you enter manually, to generate attendance rosters for additional class meetings that are not formally scheduled, and to update attendance rosters with the latest student enrollment and personal data.</p> <p><i>To generate attendance rosters manually,</i> enter the attendance information into a row and click the corresponding Create button. For example, perhaps your institution wants to track attendance for milestone periods within a class such as the 30 percent and 70 percent periods.</p> <p><i>To generate attendance rosters for additional class meetings,</i> click the Add button to insert a new row anywhere in the grid, then enter the necessary attendance information, and click the corresponding Create button. For example, perhaps you have added a field trip to the course.</p> <p><i>To update attendance rosters with the latest enrollment data,</i> you first must select the Override check box on a row within the grid. Then, click the Create button for that row. You do not need to select the Populate from Student Enroll check box because it works in conjunction with the Generate button. You might update attendance rosters when students have added or dropped the class or when there has been a change to student personal data, such as their first names or last names. You can also click the Generate button to update enrollment information for all class meetings of the scheduled class rather than changing only one class meeting. However, you should only click the Generate button <i>before</i> you manually enter attendance data into your rosters because it creates new rosters, overwriting and replacing existing information.</p>
Print	<p>Click the Print button on a data row to print an attendance roster for a specific class meeting. This automatically creates a web output in portable document format (PDF).</p> <p>Click the Report Manager link to access and print the roster.</p>
View	<p>Click this button on a data row to view and enter information for an attendance roster.</p>
Template Nbr (template number)	<p>The system generates a template number for each class meeting of the scheduled class. The template number identifies each attendance roster as unique and also denotes the order in which the system prints the attendance rosters. When you change a template number and save the page, the next time that you access the page the system positions the template numbers in numerical order.</p>

Field or Control	Description
Type	<p>Indicates the roster attendance type for the class meeting, such as <i>Class Meeting</i>, <i>Conference</i>, <i>Field Trip</i>, <i>Instructor Consultation</i>, or <i>Study Group</i>. The attendance type determines which attendance tracking fields the system uses for the attendance roster. When you generate attendance rosters the first time for all class meetings by using the Attendance Roster Generator page or the Class Attendance page, the system populates all attendance rosters with the default attendance type value from the Academic Institution 3 page. If you want to use an attendance type value other than the default, change the value in the Type field for each attendance roster template. When you exit the field, the system makes the change and updates the fields that appear on the roster (according to the selected options for this particular course component and attendance type on the Components page). Values for this field are delivered with your system as translate values. You can modify these values. This is a required field.</p> <p>To use attendance types, define the attendance types and their associated fields for course components on the Components page.</p> <p>See Defining Attendance Type Translate Values.</p> <p>The system displays the <i>Attendance Date</i>, <i>From Time</i>, <i>To Time</i>, and <i>Contact Minutes</i> for each class meeting on both the detail and summary rows of a class meeting attendance roster template. When you generate attendance rosters for all class meetings within a scheduled class, either by using the Class Attendance page or the Attendance Roster Generator page, the system assigns each attendance roster these four values based on the class meeting pattern in the schedule of classes. When you generate attendance rosters for individual class meetings (by using the Class Attendance page on a new row), you must assign these values manually.</p>
Attendance Date	Indicates the date of the class meeting. You can change this value. This field is required.
From Time	Designates the start time of the class meeting. This field appears on attendance rosters of this course component only when you select the Use To and From Time check box for the attendance type on the Components page. You can change this value.
To Time	Designates the end time of the class meeting. This field appears on attendance rosters of this course component only when you select the Use To and From Time check box for the Attendance Type on the Components page. You can change this value.

Field or Control	Description
Contact Minutes	Indicates the total length of the class meeting in minutes and is the difference between the to time and from time values. This field appears on attendance rosters of this course component only when you select the Use Contact Minutes check box for the attendance type on the Components page. You can change this value.
Override	Select this check box if you want to update an existing attendance roster with the latest student enrollment information and personal data. Then, when you click the Create button on the same row, the system generates new attendance rosters that contain the latest student enrollment information and personal data and overwrites the previous roster. You can select this check box, for example, if you have already generated class meeting attendance rosters and then students enroll in the course, drop from the course, or change their personal data.

Entering Class Attendance Detail

Access the Class Attendance page (click the **View** button on the Attendance Roster By Class page).

This example illustrates the fields and controls on the Class Attendance page. You can find definitions for the fields and controls later on this page.

Class Attendance

Course ID: 003274	Term: 2003 Fall
Course Name: Surv Brit Lit	Session: Regular Academic Session
Subject / Catalog#: ENGLIT 100	Institution: PeopleSoft University
Class Nbr: 1111	Instructor:
Class Section: 1	

Template Nbr: 1 **Attendance Type:** Meeting **Attendance Date:** 08/27/2003

Student Attendance Roster											
Customize Find View All First 1-2 of 2 Last											
*Student ID	Name	Career	Present	Tardy	Left Early	Reason	From Time	*To Time	Contact Minutes		
1	SR13582	Basile,Valerie	Undergraduate	<input checked="" type="checkbox"/>	<input type="checkbox"/>	<input type="checkbox"/>	<input type="text" value=""/>	11:00AM	11:50AM	50	<input type="button" value="+"/> <input type="button" value="-"/>
2	SR135662	Chavez,Angela	Undergraduate	<input checked="" type="checkbox"/>	<input type="checkbox"/>	<input type="checkbox"/>	<input type="text" value=""/>	11:00AM	11:50AM	50	<input type="button" value="+"/> <input type="button" value="-"/>

Field or Control	Description
Student ID and Name	<p>The system displays the ID and name of each student enrolled in the class when you generate attendance rosters and opt to have the system populate from data from student enrollment. If you generate rosters and do not select the Populate from Student Enroll check box, you can enter the IDs manually, and the system displays each student's name in the Name field after you exit the Student ID field. Insert rows to add students who are not formally enrolled in the class to the class meeting attendance roster; delete rows to remove students from the class meeting attendance roster. Adding students to the roster does not enroll them in the class. It is for personal tracking only.</p> <hr/> <p>Warning! If you entered attendance data into your rosters and you want to add or remove a student from the attendance roster for class meetings (because the student has recently enrolled in or dropped from the class), you can add or remove them from the roster manually, or you can click the Create button on the corresponding class meeting template (with the Override check box selected). This generates a new attendance roster for one class meeting with the latest student enrollment information. Generating attendance rosters by clicking the Generate button in the upper portion of the page creates new attendance rosters for all the class meetings. You would therefore lose any attendance data that you have already entered into the rosters.</p>
Academic Career	<p>The system displays the academic career of the student. This is useful if you track the types of students who enroll in classes, such as how many undergraduate students are in a class compared to how many graduate students.</p>
Present	<p>Select to indicate that the student attended the class meeting. This field appears on the attendance rosters of this course component only if you select the Use Present check box for this class meeting's attendance type on the Components page.</p>
Tardy	<p>Select to indicate that the student arrived late to the class meeting. This field appears on the attendance rosters of this course component only if you select the Use Tardy check box for this class meeting's attendance type on the Components page.</p>
Left Early	<p>Select to indicate that the student left the class meeting before its scheduled end time. This field appears on the attendance rosters of this course component only if you select the Use Left Early check box for this class meeting's attendance type on the Components page.</p>

Field or Control	Description
Reason	Select a reason to describe a reason for a student's presence, tardiness, or early departure. This field appears on the attendance rosters of this course component if you select the Use Reason check box for this class meeting's attendance type on the Components page. Values for this field are delivered with your system as translate values. You can modify these values.
From Time	Indicates the time that the student arrived at the class meeting. This field appears on attendance rosters of this course component when you select the Use To and From Time check box for the attendance type on the Components page. If you select the Override Template Date/Time check box on the Components page, you can change the from time value on a student-by-student basis. Otherwise, the From Time and To Time fields for the template define the parameters of the From Time and To Time fields on the attendance rosters, and you can change only the from time to a value that falls within the template's time range.
To Time	Indicates the time that the student left the class meeting. This field appears on attendance rosters of this course component if you select the Use To and From Time check box for the attendance type on the Components page. If you select the Override Template Date/Time check box on the Components page, you can change the To Time value on a student-by-student basis. Otherwise, the From Time and To Time fields for the Template define the parameters of the From Time and To Time fields on the attendance roster, and you can change only the to time to a value that falls within the template's time range.
Contact Minutes	Indicates the student's total minutes in attendance. This field appears on attendance rosters of this course component if you select the Use Contact Minutes check box for the attendance type on the Components page. You can change this value.
Attendance Date	Indicates the date on which the student attended the class meeting. This field appears on attendance rosters of this course component if you select the Override Template Date/Time check box for the attendance type on the Components page. If you select the Override Template Date/Time check box on the Components page, you can change the attendance date on a student-by-student basis. Otherwise, the attendance date for the template defines the value for the Attendance Date field.

Generating Batch Attendance Rosters

This section provides an overview of batch attendance roster generation and discusses how to generate attendance rosters in batch mode.

Understanding Batch Attendance Roster Generation

The following list discusses some of the reasons why you would need to run the batch attendance roster generation process:

- Create new rosters or update existing rosters based on a certain date range.
- Update rosters because students add or drop classes after you generate the initial rosters.
- Update the roster with only newly added students and keep on record those students who have dropped or withdrawn from classes.

To generate attendance rosters in batch:

1. Access the Attendance Roster generator page and specify your run parameters.
2. Click the **Roster Options** link to access the Roster Generator Options page where you can specify roster options for a specific sequence item in your run control set.
3. Click the **Run** button on the Attendance Roster generator page.

Prerequisites

Before you can generate attendance rosters in batch, you must:

- Define scheduled meeting patterns for the classes for which you generate attendance rosters.
- Select the **Generate Class Meeting Attendance** check box on the Course Catalog - Components page.
- Select the **Generate Class Meeting Attendance** check box on the Schedule of Classes - Basic Data page.

Pages Used to Generate a Batch of Attendance Rosters

<i>Page Name</i>	<i>Definition Name</i>	<i>Navigation</i>	<i>Usage</i>
Attendance Roster Generator	RUNCTL_SRPCATNP	Curriculum Management > Attendance Roster > Generate Attendance Roster > Attendance Roster Generator	Create or update attendance rosters for multiple classes within a term, based on the criteria and options that you select.
Roster Generator Options	ATT_ROS_GEN_SEC	Click the Roster Options link on the Attendance Roster Generator page.	Narrow your processing parameters.

Running the Attendance Roster Generator Process

Access the Attendance Roster Generator page (**Curriculum Management** > **Attendance Roster** > **Generate Attendance Roster** > **Attendance Roster Generator**).

Field or Control	Description
Academic Institution	The institution for which to generate rosters. The system populates this field with the value from the User Defaults 1 page, which you can change. This field is required.
Term	Select the term that contains the classes for which to generate attendance rosters. Term values are defined on the Term Table page.
Attendance Create/Update Flag	<p>Use this field to specify a default for the same field on the Roster Generator Options page. This is a default that you can change on a row-by-row basis by clicking the Roster Options link in the grid. Values for the default are the following:</p> <p><i>Create Attendance:</i> Select when you want to create new rosters or replace old ones.</p> <p><i>Update Attendance/Active Only:</i> Select when you want to add and delete students from the roster, based upon their current enrollment statuses in the course for the specified group of attendance rosters. The add and drop date on the STDNT_ENRL table determines how the system updates rosters. Select this option when a student drops the class and you want to remove the student and leave no attendance history.</p> <p><i>Update Attendance/All Students:</i> Select when you want to add, but <i>not</i> delete students from the specified group of rosters. Students who have dropped are made inactive when their Present flag is set to <i>Off</i>. New students will be added to the rosters, but they can be marked only as present or otherwise for the class sessions that occur after the add date.</p>
Commit Frequency	The system populates the commit frequency field with <i>1</i> by default. The lower the commit frequency, the better concurrence of data. While a higher commit frequency enables faster processing of the job, the job could get tied up with another process. You should leave the commit frequency at <i>1</i> .
Attendance From Date and Attendance To Date	<p>Use these fields to specify defaults for the grid below them. These values determine which rosters the process updates. If you do not specify a default, the system sets the values in the grid to the length of each class as defined on the schedule of classes, enabling you to update all of the term's rosters (like a wild card). If you manually specify a separate attendance from date and to date range on the Roster Generator Options page, the process updates class rosters only for those dates that are greater than or equal to the Attendance From Date field and less than or equal to the Attendance To Date field.</p> <p>Use the fields in the grid, and click the Roster Options link, to indicate specific criteria for each sequence number. The system uses this detail to determine which attendance rosters it generates when you run the process. Select as many selection criteria as necessary. Insert rows as needed.</p>

Field or Control	Description
Sequence	The system sets the sequence number to 1 and increases it by one for each row that you add to the request. The number specifies the order in which the system processes class attendance rosters.
Class Nbr (class number)	Enter the class number for which to generate attendance rosters. The system prompts you with the classes that are defined in the schedule of classes for the term. After you enter the class number, exit the field, and the system populates and hides some of the remaining fields on both the Attendance Roster Generator page and the Roster Generator Options page.
Session	Select the session for which to generate attendance rosters. The system prompts you with the sessions that are defined for the term. Values for this field are delivered with your system as translate values. You can modify these values.
Acad Org (academic organization)	Select the academic organization for which to generate attendance rosters. Academic organization values are defined on the Academic Organization Table page.
Campus	Select the campus for which to generate rosters. Campus values are defined on the Campus Table page.
Subject	Select the subject area for which to generate the rosters. Subject area values are defined on the Academic Subject Table page.
Roster Options	Click to access the Roster Generator Options page, where you can further specify your processing parameters for each sequence number.

Note: Because your institution can define multiple meeting attendance types for a course in the course catalog, the system uses the class meeting attendance type on the Academic Institution 3 page for all attendance rosters that you generate by using the Attendance Roster Generator page. The attendance type indicates the type of attendance roster, such as Class Meeting, Conference, Field Trip, Instructor Consultation, or Study Group. If you want to create attendance rosters with different attendance types from that of the default, change the value for individual class meetings on the Class Attendance page and Class Attendance By Template page, or you can change it for individual students on the Student Attendance page.

Click **Run** to run this request. PeopleSoft Process Scheduler runs the SRATTEND process at user-defined intervals. After the process finishes, the system makes the row unavailable but continues to display the processing parameters so that you can view a history of what you have done. These rows have no impact on future processing. You can click the **Delete** button to delete them.

Entering Roster Generator Options

Access the Roster Generator Options page (click the **Roster Options** link on the Attendance Roster Generator page).

Field or Control	Description
Attendance From Date and Attendance To Date	Use these fields to specify the range of rosters to create or update. Only class rosters that are for dates greater than or equal to those in the Attendance From Date field and less than or equal to those in the Attendance To Date field are updated. If you do not specify a value, the system sets the fields to the values on the Attendance Roster Generator page. If you do not specify from and to dates on either the Attendance Roster Generator page or the Roster Generator Options page, the system sets the values to the length of each class as defined on the schedule of classes. This enables you to update all of the term's rosters.
Catalog Number From and Catalog Number To	If you have a specific range of catalog numbers within a subject area for which to generate rosters, enter a value in the Catalog Number From and Catalog Number To fields.
Class Start Date From and Class Start Date To	If you have a specific start date range for which to generate attendance rosters, enter a value in the Class Start Date From and Class Start Date To fields. If you enter an individual class number in the grid on the Attendance Roster Generator page, the system hides these fields <i>and</i> populates them with the class start date from the Schedule of Classes - Meetings page.
Populate From Student Enroll	<p>Select to have the system populate attendance rosters with the enrolled students for every scheduled class meeting that matches your processing criteria. The system selects this check box by default. If you clear this check box, the system still creates attendance rosters for every class meeting but you will have to manually enter the students and their enrollment data into the rosters.</p> <hr/> <p>Note: A student might appear twice on an attendance roster because enrollment is keyed by academic career. For instance, a student might enroll in a class twice, each time through a different academic career, and would thus appear on the attendance record twice.</p> <hr/>
Generate Class Mtg Attendance (generate class meeting attendance)	<p>Select to have the system generate or regenerate attendance rosters only for classes in which you select the Generate Class Mtg Attendance (generate class meeting attendance) check box on the Schedule of Classes - Basic Data page. The system selects this check box by default on the Roster Generator Options page. If you clear this check box, the system generates attendance rosters for all scheduled classes matching your processing criteria, regardless of how the Generate Class Mtg Attendance check box is set on the Schedule of Classes - Basic Data page.</p>

Field or Control	Description
Sync Attendance with Class Meeting (synchronize attendance with class meeting)	When you run the attendance roster generator process, you can update all rosters within your parameters or update only those that have had meeting pattern changes since the original rosters were generated. To update changed rosters, select the Sync Attendance with Class Meeting check box. To update all rosters (even if a roster has had no changes), clear the Sync Attendance with Class Meeting check box.
Attendance Create/Update Flag	<p>Use to specify the type of roster to generate for this sequence number. The system populates this field with the value specified on the Attendance Roster Generator page, but you may change it on a row-by-row basis. Values are:</p> <p><i>Create Attendance:</i> Select when you want to create new rosters or replace old ones.</p> <p><i>Update Attendance/Active Only:</i> Select when you want to add and delete students from the roster, based on their current enrollment statuses in the course for the specified group of attendance rosters. The add and drop date on the STDNT_ENRL table determines how rosters are updated. Select this option when a student drops the class and you want to remove the student and leave no attendance history.</p> <p><i>Update Attendance/All Students:</i> Select when you want to add, but <i>not</i> delete students from the specified group of rosters. Students who have dropped are set to inactive status by having the Present flag set to <i>Off</i>. The system adds new students to the rosters, but only marks these students as present for the class sessions that occur after the add date.</p>

Printing Attendance Rosters

After you have generate rosters, click the **Print** button on the Class Attendance page to create and print the Class Attendance report as a PDF file.

Related Links

[Generating Individual Class Attendance Rosters](#)

Using Attendance Rosters

After you create your attendance rosters, you can access them to track student attendance. This section lists prerequisites and discusses how to:

- Track attendance by class.
- Track attendance by class meeting.
- Select a roster for a student.

- Track attendance by student.

You can indicate for each class meeting whether a particular student is present, tardy, or leaves early. You can even enter the reason. You can also enter the exact time that the student is in attendance, the contact minutes, and the attendance date. The system updates all three previously mentioned pages with the changes. If your institution collects data on paper, or if you prefer to track attendance on paper, you can print your attendance rosters and enter the data into the system later.

Prerequisites

Before you can record attendance, you must generate the attendance roster.

Pages Used to Record Attendance

<i>Page Name</i>	<i>Definition Name</i>	<i>Navigation</i>	<i>Usage</i>
Attendance Roster By Class	CLASS_ATTENDANCE	Curriculum Management > Attendance Roster > Attendance Roster By Class > Attendance Roster By Class	Track student attendance by accessing attendance rosters for individual classes. For each class meeting, you can view, enter, update, and print the corresponding attendance roster. You can also generate attendance rosters for classes and class meetings.
Attendance Tracking By Template	ATTEND_TRACKING_1	Curriculum Management > Attendance Roster > Class Attendance By Template > Attendance Tracking By Template	View, enter, and change data on a class meeting basis.
Attendance Roster by Student	STDNT_ATTNDNCE1	Curriculum Management > Attendance Roster > Attendance Roster By Student > Attendance Roster by Student	Select a roster for a student.
Student Attendance Roster	STDNT_ATTND_SRCH	Click the Class Number link on the Attendance Roster by Student page.	Track an individual student's attendance in a class. You can view, enter, modify, and delete the student's existing attendance data. The student must be enrolled in the class or manually added to the attendance roster.

Tracking Attendance by Class

Access the Attendance Roster By Class page (**Curriculum Management** > **Attendance Roster** > **Attendance Roster By Class** > **Attendance Roster By Class**).

Related Links

[Generating Individual Class Attendance Rosters](#)

Tracking Attendance by Class Meeting

Access the Attendance Tracking By Template page (**Curriculum Management** > **Attendance Roster** > **Class Attendance By Template** > **Attendance Tracking By Template**).

Changes made here are immediately visible on the Class Attendance page and the Student Attendance page.

<i>Field or Control</i>	<i>Description</i>
Template Number	The system displays the template number for the class meeting. The template number uniquely identifies each class meeting attendance roster.
Attendance Type	<p>Indicates the attendance type for the class meeting, such as <i>Class Meeting</i>, <i>Conference</i>, <i>Field Trip</i>, <i>Instructor Consultation</i>, or <i>Study Group</i>. These attendance types determine which fields the system uses for your attendance roster. When you generate attendance rosters for all class meetings by using the Attendance Roster Generator page or the Class Attendance page, the system populates all attendance rosters with the class meeting attendance type value from the Academic Institution 3 page. If you want to use attendance type values other than the default, you can change the Attendance Type field value for an individual attendance roster template. When you exit the field, the system makes the change online and updates the roster fields in accordance with the options for this particular course component and attendance type, as set on the Components page. Values for this field are delivered with your system as translate values. You can modify these values. This is a required field.</p> <p>To use attendance types, you must first define the attendance types and their associated fields for the course component on the Components page.</p> <p>When you generate attendance rosters for all class meetings within a scheduled class (either by using the Class Attendance page or the Attendance Roster Generator page), the system assigns each attendance roster with the following four field values (based on the class meeting pattern of the class in the Schedule of Classes). When you generate attendance rosters for individual class meetings (by using the Class Attendance page on a new row), you must manually assign the following four field values:</p>

Field or Control	Description
Attendance Date	Indicates the date of the class meeting. You can change this value.
Attendance From Time	Designates the start time of the class meeting. This field appears on the class meeting attendance roster when you select the Use To and From Time check box for the attendance type on the Components page. You can change this value.
Attendance To Time	Designates the end time of the class meeting. This field appears on the class meeting attendance roster only when you select the Use To and From Time check box for the attendance type on the Components page. You can change this value.
Contact Minutes	Indicates the total length of the class meeting in minutes and is the difference between the to time and from time values. This field appears on the class meeting attendance roster when you select the Use Contact Minutes check box for the attendance type on the Components page. You can change this value.
ID and Name	The system displays the ID and name of each student that is enrolled in the class when you generate attendance rosters and opt to have the system populate the roster from student enrollment. Otherwise, you can enter the IDs manually, and the system displays each student's name in the Name field after you exit the ID field. Insert rows to add to the class meeting attendance roster students who perhaps are not formally enrolled in the class; delete rows to remove students from the class meeting attendance roster. Adding rows does not enroll or drop students. This is for tracking nonenrolled students only.
Present	Select to indicate that the student attended the class meeting. This field appears on the attendance rosters of this course component when you select the Use Present check box for this class meeting's attendance type on the Components page.
Tardy	Select to indicate that the student arrived late to the class meeting. This field appears on the attendance rosters of this course component when you select the Use Tardy check box for this class meeting's attendance type on the Components page.
Left Early	Select to indicate that the student left the class meeting before its scheduled end time. This field appears on the attendance rosters of this course component when you select the Use Left Early check box for this class meetings attendance type on the Components page.

Field or Control	Description
Reason	Enter a reason to describe a student's presence, tardiness, or early departure. This field appears on the attendance rosters of this course component when you select the Use Reason check box for this class meeting's attendance type on the Components page. Values for this field are delivered with your system as translate values. You can modify these values.
From Time and To Time	Indicates the time that the student arrived and left the class meeting. This field appears on attendance rosters of this course component when you select the Use To and From Time check box for the attendance type on the Components page. If you select the Override Template Date/Time check box on the Components page, you can change the from or to time value on a student-by-student basis. Otherwise, the From Time and To Time fields for the template define the parameters of the From Time and To Time fields on the attendance rosters. You can change the from and to time value to a time that falls only within the template's time range.
Contact Minutes	Indicates the student's total minutes in attendance. This field appears on attendance rosters of this course component when you select the Use Contact Minutes check box for the attendance type on the Components page. You can change this value.
Attendance Date	Indicates the date on which the student attended the class meeting.
Academic Career	<p>The system displays the academic career of the student. This is useful for tracking the types of students who enroll in a class, such as how many undergraduate students are in a class as compared to graduate students.</p> <hr/> <p>Note: A student might appear twice on an attendance roster because enrollment is keyed by academic career. For instance, a student might enroll in a class twice, each time through a different academic career and would thus appear on the attendance record twice.</p> <hr/>

Selecting a Roster for a Student

Access the Attendance Roster by Student page (**Curriculum Management > Attendance Roster > Attendance Roster By Student > Attendance Roster by Student**).

Click the class number to access the Student Attendance Roster page for that class section.

Tracking Attendance by Student

Access the Student Attendance Roster page (click the **Class Number** link on the Attendance Roster by Student page).

Field or Control	Description
Attendance Date	Indicates the date on which the student attended the class meeting. This field appears on attendance rosters of this course component only when you select the Override Template Date/Time check box for the attendance type on the Components page. If you select the Override Template Date/Time check box on the Components page, you can edit the Attendance Date field value. Otherwise, the attendance date for the template defines the value for the Attendance Date field on the attendance rosters.
Type	<p>Indicates the attendance type for the class meeting, such as <i>Class Meeting</i>, <i>Conference</i>, <i>Field Trip</i>, <i>Instructor Consultation</i>, or <i>Study Group</i>. These attendance types determine which fields the system uses for your attendance roster. When you generate attendance rosters for all class meetings by using the Attendance Roster Generator page or the Class Attendance page, the system populates all attendance rosters with the class meeting attendance type value from the Academic Institution 3 page. If you want to use attendance type values other than your institution's attendance type value, you can change the attendance Type field value for an individual student. When you exit the field, the system makes the change and updates the fields that appear on the roster according to the selected options for this particular course component and attendance type on the Components page. Values for this field are delivered with your system as translate values. You can modify these values.</p> <p>To use attendance types, define the attendance types and their associated fields for the course component on the Course Component Attendance page.</p>
Description	Describes the attendance type value, such as <i>Class Meeting</i> , <i>Conference</i> , <i>Field Trip</i> , <i>Instructor Consultation</i> , or <i>Study Group</i> .
Present	Select to indicate that the student attended the class meeting. This field appears on the attendance rosters of this course component when you select the Use Present check box for this class meeting's attendance type on the Components page.
Tardy	Select to indicate that the student was late to the class meeting. This field appears on the attendance rosters of this course component when you select the Use Tardy check box for this class meeting's attendance type on the Components page.
Left Early	Select to indicate that the student left the class meeting before its scheduled end time. This field appears on the attendance rosters of this course component when you select the Use Left Early check box for this class meeting's attendance type on the Components page.

Field or Control	Description
Reason	<p>Enter a reason to describe a student's presence, tardiness, or early departure. This field appears on the attendance rosters of this course component when you select the Use Reason check box for this class meeting's attendance type on the Components page. Values for this field are delivered with your system as translate values. You can modify these values.</p> <p>The system displays the from time, to time, and contact minutes for the class meeting. When you generate attendance rosters for all class meetings within a scheduled class, either by using the Class Attendance page or the Attendance Roster Generator page, the system assigns each attendance roster these three values based on the class meeting pattern of the class in the schedule of classes. When you generate attendance rosters for individual class meetings (by using the Class Attendance page on a new row), you must manually assign these values.</p>
From Time	<p>Indicates the time that the student arrived at the class meeting. This field appears on attendance rosters of this course component when you select the Use To and From Time check box for the attendance type on the Components page. If you select the Override Template Date/Time check box on the Components page, you can change the from time value on a student-by-student basis. Otherwise, the From Time and To Time fields for the template define the parameters of the From Time and To Time fields on the attendance rosters, and you can only change the from time to a value that falls within the template's time range.</p>
To Time	<p>Indicates the time that the student left the class meeting. This field appears on attendance rosters of this course component when you select the Use To and From Time check box for the attendance type on the Components page. If you select the Override Template Date/Time check box on the Components page, you can change the to time value on a student-by-student basis. Otherwise, the From Time and To Time fields for the Template define the parameters of the From Time and To Time fields on the attendance rosters and you can only change the to time to a value that falls within the template's time range.</p>
Contact Minutes	<p>Indicates the student's total minutes in attendance. This field appears on attendance rosters of this course component when you select the Use Contact Minutes check box for the attendance type on the Components page. You can change this value.</p>
Template Number	<p>The system displays the template number for the class meeting. The template number uniquely identifies each class meeting attendance roster.</p>

Chapter 48

Tracking Student Data

Common Element Used in Tracking Student Data

<i>Field or Control</i>	<i>Description</i>
Tran Level (transcript level)	Select the transcript level on which you want the given data to print. Values for this field are delivered with your system as translate values. You can modify these values. The delivered values are <i>Degr Prog</i> (degree progress), <i>Not Print</i> , <i>Official</i> , <i>Stdnt Life</i> (student life), and <i>Unofficial</i> .

Related Links

[Understanding Transcript Levels](#)

Tracking Academic Standing

This section discusses how to:

- Assign academic standing in batch.
- Track academic standing for individual students.

Pages Used to Track Academic Standing

<i>Page Name</i>	<i>Definition Name</i>	<i>Navigation</i>	<i>Usage</i>
Academic Standing/Honors Awards	RUNCTL_SR_ASHA	Records and Enrollment > Term Processing > End of Term Processing > Acad Standing/Honors & Awards > Academic Standing/Honors Awards	Enter parameters for and run the Academic Standing/Honors Awards process (SRPCEASD). The process evaluates students using the rules defined on the Academic Standing Rule page, assigning academic standing to students that pass the rule parameters.

Page Name	Definition Name	Navigation	Usage
Academic Standing	ACAD_STDNG_ACTN	Records and Enrollment > Student Term Information > Term History > Academic Standing	Track student academic standing. The Academic Standing process populates this page according to the rules you defined on the Academic Standing Rules page. You can also manually enter information on this page.

Assigning Academic Standing in Batch

Access the Academic Standing/Honors and Awards page (**Records and Enrollment > Term Processing > End of Term Processing > Acad Standing/Honors & Awards > Academic Standing/Honors Awards**).

The Acad Standing/Honors Awards (academic standing/honors awards) COBOL SQL process (SRPCEASD) evaluates students who are active in the academic institution, academic career, term, and academic program that you select. If students meet the parameters of the academic standing rule or honor award rule, the process updates these students' academic standing records or honors and awards records according to the rule. The process does not update students' academic standing for grades that do not count towards GPA, such as pass/no pass grades.

Field or Control	Description
Institution	Select the academic institution that you want the system to use in the Academic Standing process.
Career	Select the academic career that you want the system to use in the Academic Standing process.
Term	Select the term that you want the system to use in the Academic Standing process.
Acad Prog (academic program)	Select the academic program that you want the system to use in the Academic Standing process.
Calculate Academic Standing	Select to calculate academic standing.
Calculate Honors & Awards	Select to calculate honors and awards. You can select both check boxes at the same time.
Date	Enter the date that you want the system to use in the Academic Standing process. The Academic Standing process displays the date that you enter here in the Date Received field on the Academic Standing page.

Related Links

[Tracking Honors and Awards](#)

Tracking Academic Standing for Individual Students

Access the Academic Standing page ([Records and Enrollment](#) > [Student Term Information](#) > [Term History](#) > [Academic Standing](#)).

<i>Field or Control</i>	<i>Description</i>
Effective Sequence	<p>When manually entering academic standing, the default for the first academic standing action within a student's academic career and term is 0.</p> <p>If multiple academic standing actions exist within the same academic career and term, you must override the default value by manually incrementing the effective sequence for each additional academic standing action entered for the same effective date.</p> <p>When the Academic Standing process populates this field, it enters effective sequences starting at ten and increments them by ten (such as 10, 20, and 30) when the effective date is the same as an existing row.</p>
Manual Override	<p>Select to indicate that you entered the information on this page manually.</p> <hr/> <p>Note: When you run the Academic Standing process, the system does not calculate academic standing for any records in which this check box is selected.</p> <hr/>
Academic Standing Action	Select an academic standing action.
Academic Program	Select the academic program of the student. The system prompts you for student's record.
Formal Description, Internal Description, and Academic Standing Status	The system displays these values according to corresponding values on the Academic Standing Table page.

Tracking Honors and Awards

This section discusses how to:

- Assign honors and awards in batch.
- Track honors and awards for individual students.

Pages Used to Track Honors and Awards

<i>Page Name</i>	<i>Definition Name</i>	<i>Navigation</i>	<i>Usage</i>
Academic Standing/Honors and Awards	RUNCTL_SR_ASHA	Records and Enrollment > Term Processing > End of Term Processing > Acad Standing/Honors & Awards > Academic Standing/Honors and Awards	Enter parameters for and run the Academic Standing/Honors Awards process (SRPCEASD). The process evaluates students using the rules defined on the Honors and Awards Rule page, assigning honors and awards to students that pass the rule parameters.
Honors and Awards	HONORS_AWARDS_CS	Records and Enrollment > Graduation > Honors and Awards > Honors and Awards	Track student honors and awards. The Honors/Awards process populates the page according to the rules you set on the Honors/Awards Rule page. You can also manually enter information on this page.

Assigning Honors and Awards in Batch

Access the Academic Standing/Honors and Awards page (**Records and Enrollment > Term Processing > End of Term Processing > Acad Standing/Honors & Awards > Academic Standing/Honors and Awards**).

Use this to run the Academic Standing/Honors Awards process (SRPCEASD), which assigns honors and awards to students based on your run parameters and honor award rules.

Related Links

[Tracking Academic Standing](#)

Tracking Honors and Awards for Individual Students

Access the Honors and Awards page (**Records and Enrollment > Graduation > Honors and Awards > Honors and Awards**).

<i>Field or Control</i>	<i>Description</i>
Internal/External	Indicate whether the student's honor or award relates to an external organization or your internal institution. Your selection here affects the honors and awards that you can choose in the Honor/Award field. The system prompts you with the corresponding honors and awards that you defined on the Honor/Award Table page.

Field or Control	Description
Date Recvd (date received)	Enter the date that the student received the honor or award.
Academic Institution	Select the academic institution for which you are entering the honor or award. Your selection here affects the honors and awards that you can choose in the Honor/Award field. The system prompts you with the corresponding honors and awards that you defined on the Honor/Award Table page for the academic institution that you select. Define academic institution values on the Academic Institution Table component.
Honor/Award	Select the honor and award code that you want to assign to a student's record.
Formal Description and Grantor	The system uses the honor and award code that you enter to populate the formal description and grantor of the honor or award. This information comes from the Honor/Award Table page.
Career	Enter the academic career for which the student is receiving the honor or award. The system prompts you with only the academic careers in which the student has been active.
Term	Enter the term for which the student is receiving the honor or award. The system prompts you with the terms in which the student has been active according to the academic career you select.
Academic Program	Enter the academic program for which the student is receiving the honor or award. The system prompts you with the student's academic programs according to the academic career.
Academic Plan	Enter the academic plan for which the student is receiving the honor or award. The system prompts you with the student's academic plans according to the academic career or program.
System Generated	The system selects this check box if the Honors/Awards process generated this honor and award.

Tracking Special Grade Point Averages

This section provides an overview of how to assign special grade point averages and discusses how to maintain a student's special grade point averages.

Related Links

[Setting Up Special Grade Point Averages](#)

Understanding How to Assign Special Grade Point Averages

You can assign special grade point averages to students in three ways:

- If you have calculated students' grade point averages through the PeopleSoft Academic Advisement report process using the analysis database report option, your institution can design a process that populates the Student Special GPA page with the results of the calculation, storing them for future analysis.
- You can create and define your own calculation process through the process scheduler.
- You can directly input the special grade point average onto the Student Special GPA page, then use these averages for other applications within PeopleSoft Campus Solutions.

Related Links

“Creating a User-Defined Advisement Report Using the Analysis Database” (Academic Advisement)

Page Used to Track Special Grade Point Averages

<i>Page Name</i>	<i>Definition Name</i>	<i>Navigation</i>	<i>Usage</i>
Student Special GPA	STDNT_SPCL_GPA	Records and Enrollment > Student Term Information > Term History > Student Special GPA	Assign types of grade point averages to a specific student's term record, indicating whether the student's special grade point average belongs to his or her academic program, academic plan, or academic subplan.

Maintaining a Student's Special Grade Point Averages

Access the Student Special GPA page (**Records and Enrollment > Student Term Information > Term History > Student Special GPA**).

<i>Field or Control</i>	<i>Description</i>
GPA Type (grade point average type)	Select the grade point average type for the grade point average that you want to enter.
Sequence	The sequence number default is 1. The system increases the number sequentially by one as you add new rows. The system evaluates special grade point average numbers in sequence.
GPA (grade point average)	The default grade point average is 0.000. Enter the student's special grade point average. No programming is tied to this field in the delivered application. Any reporting you choose to perform based on the value entered here must be programmed by your institution.

<i>Field or Control</i>	<i>Description</i>
Entered Online	Select to distinguish this special grade point average from those populated by a configured background process. This flag has no programming tied to it, but you can use it for reporting purposes.
Academic Program	(Optional) Select the student's academic program for which you are creating the special grade point average. The list box displays the student's active academic programs.
Academic Plan	(Optional) Select the student's academic plan for which you are creating the special grade point average. The list box displays the student's active academic plans.
Academic Sub-Plan	(Optional) Select the student's academic subplan for which you are creating the special grade point average. The list box displays the student's active academic subplans.

Tracking Milestones

Milestones are non-course-related events that a student must fulfill for a degree. They include things such as language requirements, qualifying and oral examinations, thesis, and dissertation. Use the Student Milestones component to assign milestones and advisors to individual students, as well as to record completions of milestones and attempts to fulfill them. Use the Process Milestones component to assign or update milestones for multiple students.

This section discusses how to:

- Assign and update milestones for a student.
- Create milestones from templates.
- Assign and updates milestones for multiple students.

Related Links

[Setting Up Milestones](#)

Pages Used to Track Milestones

<i>Page Name</i>	<i>Definition Name</i>	<i>Navigation</i>	<i>Usage</i>
Student Milestones	STUDENT_MILESTONE1	Records and Enrollment > Enroll Students > Student Milestones	Assign and update milestones for a student.

Page Name	Definition Name	Navigation	Usage
Create Student Milestones	STDNT_MLSTN_COPY	Click the Milestone Copy button on the Student Milestone page.	Create milestones from templates by copying milestone information from the milestone template to the student's transcript.
Process Milestones	SSR_RC_MLSTN	Records and Enrollment > Enroll Students > Process Milestones	Assign and update milestones for multiple students.

Assigning and Updating Milestones for a Student

Access the Student Milestones page (**Records and Enrollment > Enroll Students > Student Milestones > Student Milestones**).

Field or Control	Description
Milestone Copy	Click to copy milestone information from the milestone template to the student's record. See Setting Up Milestones .

Milestone Detail

Field or Control	Description
Milestone Nbr (milestone number)	The milestone number default is 10. As you insert rows, the system increments this number sequentially. The milestone number is used for sequencing.
Milestone Level	Select the milestone level. Some milestones, such as Comprehensive Exams, can have multiple levels. You can override this value.
Milestone Complete	The system displays the milestone complete status according to the values entered in the Attempts grid.
Academic Plan	Select the academic plan to which the milestone is attached. The system prompts you from the student's academic record.
Milestone Title	Enter a title for the milestone. You can print the title on the student's transcript.

Field or Control	Description
Manage Milestone Documents	Attach documents related to the milestone.
Hide Comment on Stdnt Self-Svc	If you select this check box, comments do not appear on the Student Milestone Details page in Student Self Service.
Term Required and Term Anticipated	<p>Select the term by when the milestone must be completed or by when you anticipate the student will complete the milestone.</p> <p>Depending on the value that is entered in the Calculate Required Date and Calculate Anticipated Date fields on the Milestone Table page – for example, <i>Expected Grad Term Start Date</i>, a value may appear in the Term Required and Term Anticipated fields by default. You can override the value.</p>
Date Required and Anticipated Date	<p>If you select a term, the system populates this date based on the term Ending Date value on the Term Table page.</p> <p>Alternatively, the date appears based on the Milestone Table setup as explained previously. You can override the date.</p>
Print Milestone Detail	<p>Indicates when the milestone is printed on the transcript. The system transfers this value from the Milestone Template page.</p> <p>You can override this value. Values for this field are delivered with your system as translate values. The delivered values are <i>Always</i>, <i>Never</i>, and <i>Satisfied</i>.</p>
Advised by Committee	Select to assign an advisory committee to the student. When you select this check box the Committee field appears.

Advisors

Field or Control	Description
Advisor/Evaluator	If you do not select the Advised by Committee check box, select individual advisors for the student. The system prompts you with advisors that are within the student's academic career and academic program.

Attempts: Grade Information

Field or Control	Description
Attempts Allowed	The system displays the attempts allowed according to the values entered on the Milestone Template page. You can override this value.
Attempt Nbr (attempt number)	Enter the number of the student's attempt at this milestone.
Grading Scheme and Grading Basis	The system populates the grading scheme and grading basis from the Milestone Template page. You can override these values.
Grade Input	Enter a grade (if required by the grading scheme and grading basis).
Milestone Complete	Select the status of the milestone. Values for this field are delivered with your system as translate values. You can modify these values. The delivered values are <i>Completed</i> , <i>In Progress</i> , and <i>Not Completed</i> .
How Attempted	Select how the milestone was attempted. Values for this field are delivered with your system as translate values. You can modify these values. The delivered values are <i>Attended Seminar</i> , <i>Exam Taken</i> , <i>Filed Petition</i> , <i>Native Speaker</i> , and <i>Submitted Work</i> .
Date Attempted	Enter the date that the student attempted the milestone.

Attempts: Enrollment Details

This grid displays the class information if the milestone is assigned to the student when the student enrolls in a course.

See [Linking Milestones to Course Data](#).

Related Links

[Setting Up Milestones](#)

Creating Milestones from Templates

Access the Create Student Milestones page (click the **Milestone Copy** button on the Student Milestone page).

Field or Control	Description
Career Milestones	Select to choose a milestone that is within the student's academic career. The system transfers the information from the template to the Student Milestone page.
Program Milestones	Select to choose a milestone that is within the student's academic program. The system transfers the information from the template to the Student Milestone page.
Plan One Milestones and Plan Two Milestones	Select plan one and/or plan two milestones to choose a milestone that is within the student's academic plan. The system transfers the information from the template to the Student Milestone page.

Related Links

[Setting Up Milestones](#)

Assigning and Updating Milestones for Multiple Students

Access the Process Milestones page (**Records and Enrollment > Enroll Students > Process Milestones**).

This example illustrates the fields and controls on the Process Milestones page (1 of 2). You can find definitions for the fields and controls later on this page.

Process Milestones

Run Control ID: PS [Report Manager](#) [Process Monitor](#) Run

*Academic Institution: PeopleSoft University

*Academic Career:

*Academic Program: Fine Arts Undergraduate

Academic Plan:

*Effective Date:

*Process Action: Milestone Copy

*Duplicate Milestone Options: Process Duplicate Milestones

Population Selection

Population Selection

Selection Tool: [Edit Prompts](#)

Query Name: [Launch Query Manager](#) [Preview Selection Results](#)

Student Select List

Use Student Select

This example illustrates the fields and controls on the Process Milestones page (2 of 2). You can find definitions for the fields and controls later on this page.

The screenshot shows the 'Milestone Detail' form with the following fields and controls:

- Milestone:** PORTFOLIO (with search icon)
- Milestone Nbr:** 10 (with +/- buttons)
- Milestone Level:** (empty field with search icon)
- Academic Plan:** (empty field)
- Description:** Art Portfolio
- Formal Description:** Art Portfolio
- Milestone Title:** (empty text area with save icon)
- Comment:** (empty text area with save icon)
- Hide Comment on Stdnt Self-Svc
- *Calculate Required Date:** Do Not Calculate (dropdown)
- Term Required:** (empty field with search icon)
- Date Required:** (empty date field with B1 icon)
- *Calculate Anticipated Date:** Do Not Calculate (dropdown)
- Anticipated Term:** (empty field with search icon)
- Anticipated Date:** (empty date field with B1 icon)
- *Transcript Level:** Official (dropdown)
- *Print Milestone Detail:** Always (dropdown)
- Advised by Committee

Advisors Table:

*Advisor/Evaluator	Name
1	

Attempts Allowed: 2

Attempts Table:

Grading Scheme	Grading Basis	Grade Input	*Milestone Complete	How Attempted	Date Attempted
UGD	PNP		Not Complete		

Field or Control	Description
Process Action	Select a process action: <i>Delete, Insert Milestones, Insert/Update Milestones, or Update Milestones.</i> You cannot delete milestones which have been completed.
Process Duplicate Milestones	Select this check box to indicate that if duplicate milestones are found they should be inserted/updated.

Population Selection

The Population Selection group box is a standard group box that appears on run control pages when the Population Selection process is available or required for the transaction. Selection tools are available based on the selection tools that your institution selected in the setup of the Population Selection process for the application process and on your user security. Fields in the group box appear based on the selection tool that you select. The fields behave the same way from within the group box on all run control pages and application processes. If your institution uses a specific delivered selection tool to identify IDs for a specific transaction, you must use it.

See “Understanding the Population Selection Group Box” (Campus Community Fundamentals)

See “Using the Population Selection Process” (Campus Community Fundamentals)

Field or Control	Description
Selection Tool	Select <i>External File</i> or <i>PS Query</i> .
Query Name	<p>These queries are delivered:</p> <ul style="list-style-type: none"> • SSR_MLSTN_PROGPLAN • SSR_MLSTN_PROGRAM <p>If you create your own query, you must use the following bind record: SSR_MLSTN_BND - Pop Select Mlstn Report Bind.</p>

Student Select List

Select the **Use Student Select** check box to select individual EmplIDs to include in the Process Milestones process.

Milestone Detail

The values in the **Calculate Required Date** and **Calculate Anticipated Date** fields appear by default from the setup on the Milestone Table page. You can change these values.

For information about other fields on the page, refer to the documentation in the earlier section: Assigning and Updating Milestones for a Student.

Related Links

[Setting Up Milestones](#)

Tracking Extracurricular Activities

This section discusses how to record and track an individual's extracurricular activities.

Related Links

[Setting Up Extracurricular Activities](#)

Page Used to Track Extracurricular Activities

<i>Page Name</i>	<i>Definition Name</i>	<i>Navigation</i>	<i>Usage</i>
Extracurricular Activities	STDNT_EXTRA_ACTVTY	Records and Enrollment > Student Background Information > Extracurricular Activity > Extracurricular Activities	Record and track an individual's extracurricular activities. This page is shared with PeopleSoft Recruiting and Admissions and Campus Community.

Tracking an Individual's Extracurricular Activities

Access the Extracurricular Activities page (**Records and Enrollment > Student Background Information > Extracurricular Activity > Extracurricular Activities**).

<i>Field or Control</i>	<i>Description</i>
Activity	Select an extracurricular activity.
Start Date	The default for the start date is your system date.
End Date	Enter the date that the activity ended.
Academic Institution and Academic Career	The system populates the academic institution and academic career of the student, unless the student has more than one academic career or institution on their record. In that case, you can select the appropriate academic institution and academic career.
Term	Select the academic term in which the activity took place.
Activity Type	The system populates the activity type if it was defined on the Extracurricular Activity Table page. You can change this value.
Office Held	Select the office that the person held (if applicable). Values for this field are delivered with your system as translate values. You can modify these values. The delivered values are <i>Captain, EIC, President, Treasurer, and Vice Pres</i> (vice president).
Time Unit 1 and Time Unit 2	Enter the amount of time the student spent participating in this activity. Time units can represent hours per week, hours per month, and so on. Select the time unit qualifier in the field next to this one. Values for this field are delivered with your system as translate values. You can modify these values.

<i>Field or Control</i>	<i>Description</i>
Additional Info (additional information)	Enter any comments or notes about the student's participation in this extracurricular activity.

Tracking Student Groups

This section lists the page used to track student groups.

Related Links

[Managing Student Groups](#)

Page Used to Track Student Groups

<i>Page Name</i>	<i>Definition Name</i>	<i>Navigation</i>	<i>Usage</i>
Student Groups	STDNT_GROUPS	Records and Enrollment > Career and Program Information > Student Groups > Student Groups	Track student membership in various groups for reporting, fee calculation, or degree progress assessment. You track groups within an academic institution, so students of any program or career can be associated with the same group.

Tracking Student Attributes

This section discusses how to track student attributes.

Related Links

[Setting Up Student Attributes](#)

Page Used to Track Student Attributes

<i>Page Name</i>	<i>Definition Name</i>	<i>Navigation</i>	<i>Usage</i>
Student Attributes	STDNT_ATTRIBUTES	Records and Enrollment > Career and Program Information > Student Program/Plan > Student Attributes	Track student attributes and values for students.

Tracking Student Attributes

Access the Student Attributes page (**Records and Enrollment > Career and Program Information > Student Program/Plan > Student Attributes**).

<i>Field or Control</i>	<i>Description</i>
Student Attribute	Select the student attribute that you want to attach to the student for cohort tracking and reporting purposes. The Consolidate Academic Statistics process compares this student attribute to the value existing in the Student Attribute for Cohort field on the Academic Institution 3 page. If the process finds a match, it writes this student attribute to the student's academic statistics record.
Student Attribute Value	Select the student attribute value associated with the student attribute.
Primacy	Enter the primacy number for this student attribute. If you enter the same student attribute more than once, the Consolidate Academic Statistics process writes the one with the lowest primacy number to the student's consolidated statistics record. This primacy number has no relation to financial aid primacy.

Related Links

[Understanding Consolidate Academic Statistics Process Calculations](#)

[Performing Academic Statistics Consolidation](#)

Using Student Records Service Impacts

Use service indicators to provide or limit access to services in your system. Service indicators can be holds to prevent an individual from receiving certain services or positive indicators to designate special services to be provided. Service indicators consist of one or more service impact values identifying the types of specific services that are restricted or provided.

Student Records enables you to attach specific service impacts to negative service indicators, which, when assigned to a student, restricts the student from receiving certain services. These specific service impacts are the following:

<i>Field or Control</i>	<i>Description</i>
CENR	Restricts <i>all</i> enrollment activity (such as adds, drops, swaps, or wait lists) for a student with existing enrollment for the current term.

Field or Control	Description
IENR	Prevents a student from initially enrolling into a class but permits the student to add or drop classes if they already have enrollment activity for the current term.
AENR	Prevents a student from initially enrolling into a class <i>and</i> prevents the student from adding a class, <i>but</i> permits the student to drop classes if they have already have enrollment activity for the current term.
ENVER	Prevents the enrollment verification process from printing a student's enrollment verification request.
GRADE	Restricts a student's access to self-service View My Grades. Also prevents the student grade report process from printing the student's grade report.
DENR	Prevents a student from dropping or swapping a class but permits the student to add classes or make changes to existing enrollments.
WENR	Prevents all enrollment activity other than drops that result from the Student Records withdrawal process or the Student Financials cancellation process.

Related Links

“Setting Up Service Impacts” (Campus Community Fundamentals)

“Setting Up Service Indicator Codes and Reasons” (Campus Community Fundamentals)

“Viewing, Assigning, or Removing Service Indicators” (Campus Community Fundamentals)

Assigning Academic Advisors to Students

This section discusses how to assign academic advisors to students.

When the message catalog message set number 14600, message numbers 877 & 878 message severity is set to Warning, the user is able to assign academic advisors or committees to a student whose academic program and plan is inactive for the defined student advisor effective date. To prevent the assigning of an academic advisor or committee to a student whose academic program and plan is inactive, for the defined effective date, the message severity should be set to Error. You can also change the message text and explanation. For example, add the word Error in front of the message text.

The academic program plan look up for the Student Advisor displays the maximum effective dated value corresponding to the defined effective date on the Student Advisor page. When you enter or select an inactive maximum effective dated program or plan value, you receive a warning message, but you can successfully save the transaction. The academic program status appears on the Student Advisor page — for example, LOA.

Access the Look Up Academic Program page from the **Academic Program** field on the Student Advisor page.

This example illustrates the fields and controls on the Look Up Academic program. You can find definitions for the fields and controls later on this page.

Look Up Academic Program

EmplID: SR12219
Academic Institution: PSUNV
Academic Career: Undergraduate
Academic Program: begins with

[Basic Lookup](#)

Search Results

Academic Program	Description	Program Status
FAU	Fine Arts Undergraduate	Leave of Absence

When the message catalog severity is set to Warning, the user is able to assign an advisor to a student in an inactive program. For example, in the search results of the Look Up Academic Program, the FAU program is listed as Leave of Absence for the January 15, 2001 effective date.

Access the Look Up Academic Plan page from the **Academic Plan** field on the Student Advisor page.

This example illustrates the fields and controls on the Look Up Academic Plan page. You can find definitions for the fields and controls later on this page.

Look Up Academic Plan

EmplID: SR12219
Academic Institution: PSUNV
Academic Career: Undergraduate
Academic Program: FAU
Academic Plan: begins with
Description: begins with

[Basic Lookup](#)

Search Results

Academic Plan	Description	Program Status
MUSIC	Music Performance (BFA)	Leave of Absence

In the search results of the Look Up Academic Program or Academic Plan, the program status appears. The results also display the maximum effective dated value corresponding to the defined effective date

on the Student Advisor page. If the max effective dated program or plan value or status has changed, historical academic advisement rows are not affected unless the user makes a change to the historical record. Users cannot assign and save program or plan values that are not the max effective dated value for the student advisor effective date. For example, if Mary St. James had an academic plan of ETHST-BA in January 1, 2001. Effective January 1, 2006, she had a change to the Honors plan. On the Student Advisor page, with an effective date of April 1, 2006, the user will receive an invalid value message upon entering ETHST-BA as the student's plan.

Page Used to Assign Academic Advisors to Students

<i>Page Name</i>	<i>Definition Name</i>	<i>Navigation</i>	<i>Usage</i>
Student Advisor	STDNT_ADVISOR	Records and Enrollment > Student Background Information > Student Advisor > Student Advisor	Assign individual advisors or a committee of advisors to a student. The student must be active in an academic career and an academic program.
Setup	SSR_STAD_SETUP	Records and Enrollment > Student Background Information > Student Advisor Assignment > Setup	Define the parameters with which to select and match advisors and students.
Advisor	SSR_STAD_ADVISOR	Records and Enrollment > Student Background Information > Student Advisor Assignment > Advisor	View the list of advisors that you can assign to students based on the selection criteria you defined on the Setup page.
Student	SSR_STAD_STUDENT	Records and Enrollment > Student Background Information > Student Advisor Assignment > Student	View the list of students based on the selection parameters you defined on the Setup page. From here, you also assign advisors to students.

Assigning Advisors to Students Individually

Access the Student Advisor page (**Records and Enrollment > Student Background Information > Student Advisor > Student Advisor**).

This example illustrates the fields and controls on the Student Advisor page. You can find definitions for the fields and controls later on this page.

Use this page to assign individual advisors or a committee of advisors to a student. The student must be active in an academic career and an academic program.

Field or Control	Description
Academic Institution	Select the academic institution for which you want to assign the student an academic advisor.
Effective Date	Enter the date that the student's advisor or advisory committee becomes effective for the student.
Advisor Role	Select the role that the advisor serves for the student. Values for this field are delivered with your system as translate values. You can modify these values.
Advisor Number	The system, by default, sets the number of the advisor to 1, and it increases the number by one as you add new advisors or committees.
Academic Career	Select the student's academic career for which you want to assign the advisor. The system prompts you with options based on the student's career term record.
Academic Program	Select the student's program for which you want to assign the advisor. The system prompts you with options based on the student's program record.
Academic Plan	Select the student's plan for which you want to assign the advisor. The system prompts you with options based on the student's program record.

Field or Control	Description
Academic Sub-Plan	Select the student's sub-plan for which you want to assign the advisor. The system prompts you with options based on the student's program record.
Academic Advisor	If an individual advises a student, select that individual advisor. The system prompts you with advisors that are within the student's academic career and academic program. If this field is unavailable for entry, you must first clear the Advised by Committee check box.
Advisor Percentage	This field is enabled only when the Advised by Committee check box is not selected. This field allows a numeric value to one decimal place.
Committee	If a committee rather than an individual advises a student, select the committee. If this field is unavailable for entry, you must first select the Advised by Committee check box.
Advised by Committee	If a committee rather than an individual advises a student, select this check box. The Committee field becomes available for entry, and the Academic Advisor field becomes unavailable for entry.
Must Approve Enrollment	Select to indicate that the advisor must approve a student's enrollment into classes. This check box is for information purposes only. No coding is behind it.
Must Approve Graduation	Select to indicate that the advisor or committee must make a degree check before your institution can complete the student's graduation process. The Graduation Approved check box becomes available for entry. Both check boxes are for information purposes only. No coding is behind them.
Graduation Approved	Select to indicate that the advisor or committee has made a degree check and your institution can now complete the student's graduation process. This check box is available for entry only when you select the Must Approve Graduation check box.

Defining the Parameters for Selecting and Matching Advisors and Students

Access the Student Advisor Assignment Setup page (**Records and Enrollment > Student Background Information > Student Advisor Assignment > Setup**).

This example illustrates the fields and controls on the Student Advisor Assignment Setup page. You can find definitions for the fields and controls later on this page.

Setup
Advisor
Student

Assignment Code TEST2

Academic Institution PSUNV

Academic Career Law

Details

*Description

*Status

Mode

Select Advisors By

Distribute Advisors By

Select Students By

Assign Student Advisors At

Selection Parameters

Academic Program Fine Arts Undergraduate

Academic Plan

Academic Sub-Plan

Additional Parameters

Admit Term

Multiple Academic Career

Student Advisor Details

*Advisor Role Must Approve Enrollment

Advisor Percentage Must Approve Graduation

Use this page to define the parameters with which to select and match advisors and students.

To define a set of parameters, click Add New Value, then enter values for:

- Academic Institution
- Academic Career
- Assignment Code. This value uniquely identifies this set of parameters.

Details

<i>Field or Control</i>	<i>Description</i>
Status	Select whether this set of parameters is active or inactive.

<i>Field or Control</i>	<i>Description</i>
Mode	Select: <ul style="list-style-type: none">• <i>Assign</i> to assign a new advisor.• <i>Un-assign ALL</i> to remove advisors from their role for the selected student population.• <i>Re-assign ALL</i> to delete and recreate all of the Student Advisor records to redistribute the students.

Field or Control	Description
Select Advisors By	<p>Identify the method by which the advisor population is selected.</p> <p>Select:</p> <ul style="list-style-type: none"> • <i>File (All)</i> to use a file that contains a list of advisors that you want to assign to a select group of students. <p>Program, Plan, Sub-Plan are ignored by this selection method.</p> <ul style="list-style-type: none"> • <i>File (Matching)</i> to use a file that contains a list of advisors who are selected if they match the Program, Plan, Sub-Plan you identified. • <i>PS Query</i> to use a PS Query record. <p>When creating queries, use the bind record SSR_STAD_ADV.</p> <ul style="list-style-type: none"> • <i>PS Query (with Matching)</i> to use a PS Query record that selects advisors if they match the Program, Plan, Sub-Plan you identified. <p>When creating queries, use the bind record SSR_STAD_ADV.</p> <ul style="list-style-type: none"> • <i>Committee</i> to choose a committee as an advisor. • <i>Career/Program/Plan/Sub-Plan</i> to select a program, plan, and sub-plan in the Selection Parameters region. <p>The details in the Instructor/Advisor Table record are used to select advisors based on the values for career, program, plan, and sub-plan that are matched to the values here. The values here and on the Instructor/Advisor Table are matched exactly, NULL equals NULL. For example, if you don't identify a plan here, all advisor records that don't have plans are selected.</p> <ul style="list-style-type: none"> • <i>Career Only</i> to select advisors if the career value here matches what's in the Instructor/Advisor Table record. <p>The Instructor/Advisor Table records are selected only if the program, plan and sub-plan are all null. Otherwise, they aren't selected.</p>
Committee	<p>This field appears only when you select <i>Committee</i> in Select Advisors By.</p> <p>You can assign only one committee.</p>

<i>Field or Control</i>	<i>Description</i>
Distribute Advisors By	Identify how advisors are assigned. Select: <ul style="list-style-type: none">• <i>Multiple</i> to match all advisors to all students.• <i>Single</i> to match an advisor to a student. Each student gets an advisor.

Field or Control	Description
<p>Select Student By</p>	<p>Identify the method by which the student population is selected.</p> <p>Select:</p> <ul style="list-style-type: none"> • <i>File</i> to use a file that contains a list of advisors that you want to assign to a select group of students. <p>This file contains the Employee ID (EMPLID), Program, Plan (optional), and Sub-Plan (optional).</p> • <i>PS Query</i> to use a PS Query record. <p>When creating queries, use the bind record SSR_STAD_STU.</p> • <i>Career/Program/Plan/Sub-Plan</i> to select a program, plan, sub-plan, admit term, dual career, and academic standing in the Additional Parameters region. <p>The details in the student program/plan record are used to select students based on the values that are matched to the values here. The values here and on the student record are matched exactly. For example, if you don't identify a plan here, all student records that don't have plans are selected.</p> • <i>Career Only</i> to select students based on the values that match to the student career, admit term, dual career, and academic standing in the Additional Parameters region. <p>When one of the values you define for admit term, dual career, and academic standing is NULL, it matches all values for the student record. For example, if admit term here is NULL, match all student admit terms. Program, plan, sub-plan are ignored.</p> • <i>Unassigned</i> to enable the fields in Selection Parameters and Additional Parameters regions. <p>The details in the student program/plan record are used to select students based on the values that are matched to the values here. When one of the values you define for admit term, dual career, and academic standing is NULL, it matches all values for the student record. For example, if admit term here is NULL, all student admit terms are matched.</p> <p>Students are selected only if a Student Advisor Record <i>doesn't</i> exist for the student for their program, plan, and sub-plan, that is, the student doesn't have an advisor.</p>

Field or Control	Description
Assign Student Advisors At	<p>Note: This setting is separate from the parameters you use to identify the advisor and student populations. Those parameters don't need to match the level you set in this field.</p> <hr/> <p>Select the level at which advisors are assigned:</p> <ul style="list-style-type: none"> • Program • Program and plan • Program, plan, and sub-plan <p>For example, you select a student or advisor population for the program 'ARTS' and you want to assign advisors to students at the sub-plan level. Advisors' records should have a program = ARTS and must have values in plan and sub-plan. The system matches advisors to students based on these values and student advisor records are created with the corresponding program, plan, and sub-plan values.</p>

Selection Parameters

This region is enabled only when you select any one of these values in **Select Students By** to identify your student population:

- Career/Program/Plan/Sub-Plan
- Career Only
- Unassigned

This is also enabled when you select *Career/Program/Plan/Sub-Plan* in **Select Advisors By** to identify your advisor population.

Additional Parameters

This region is enabled only when you select any one of these values in **Select Students By** to identify your student population:

- Career/Program/Plan/Sub-Plan
- Career Only
- Unassigned

Student Advisor Details

The information you enter in this region populates the matching fields on the Student Advisor record when it is created.

Viewing the Advisor Population

Access the Advisor page (**Records and Enrollment > Student Background Information > Student Advisor Assignment > Advisor**).

This example illustrates the fields and controls on the Advisor page. You can find definitions for the fields and controls later on this page.

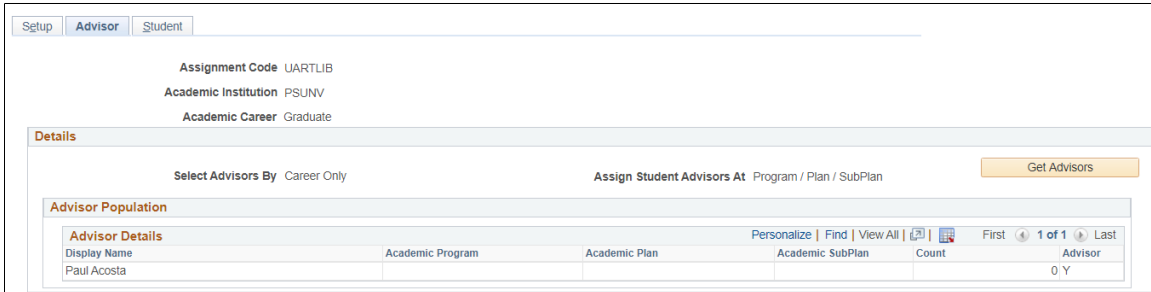

Here, you can view the list of advisors you can assign to students.

Field or Control	Description
Get Advisors	<p>Note: This button is disabled if Select Advisor By is set to <i>Committee</i>.</p> <hr/> <p>Click to retrieve a list of advisors based on any one of these methods:</p> <ul style="list-style-type: none"> Defining the parameters by which advisors are selected on the Setup page. Uploading a file with a list of advisors. Using PS query to identify advisors.

Assigning Advisors to a Student Population

Access the Student page (**Records and Enrollment > Student Background Information > Student Advisor Assignment > Student**).

This example illustrates the fields and controls on the Student. You can find definitions for the fields and controls later on this page.

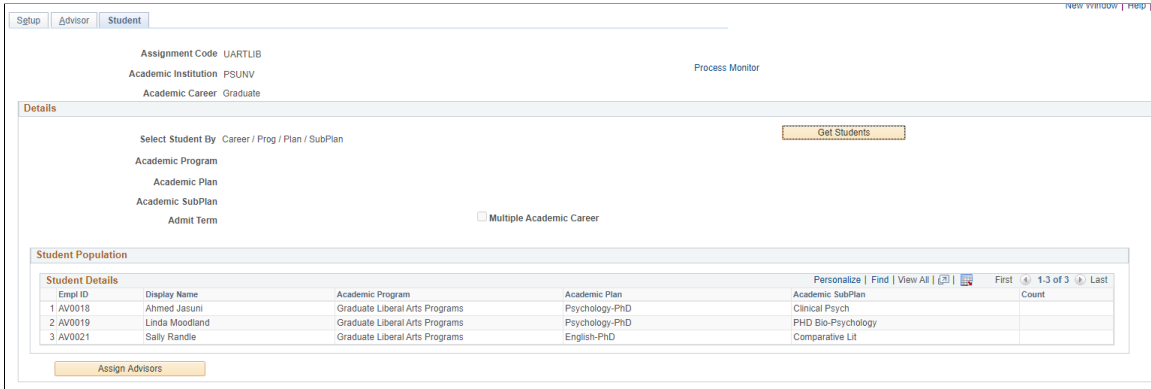

Here, you can view the list of students that you selected based on the criteria you defined on the Setup page. This is the student population to whom you want to assign advisors, if they don't have one. You also see students who have existing or newly assigned advisors.

Field or Control	Description
Get Students	<p>Click to retrieve a list of students based on any one of these methods:</p> <ul style="list-style-type: none"> Defining the parameters by which students are selected on the Setup page. Uploading a file with a list of students. Using PS query to identify students.

Field or Control	Description
Assign Advisors	<p>Click to run the Assign Advisors process to match students and advisors.</p> <p>If you select this mode on the Setup page:</p> <ul style="list-style-type: none"> • <i>Assign</i>, you're assigning a new advisor. • <i>Un-assign ALL</i>, you're removing advisors from this role for the selected student population. • <i>Re-assign ALL</i>, you're deleting and recreating all of the Student Advisor records to redistribute the students. <p>Take note of these selections:</p> <ul style="list-style-type: none"> • If Select Advisors By = Career Only, advisors are matched to students regardless of students' programs, plans, and sub-plans. Otherwise, students are matched according to the advisors' programs, plans, and sub-plans. • If Distribute Advisor By = Multiple, all advisors are assigned to all students. Otherwise, advisors are matched to students alternately, one by one. <p>For example, you select a student or advisor population for the program 'ARTS' and you want to assign advisors to students at the sub-plan level. Advisors' records should have a program = ARTS and must have values in plan and sub-plan. The system matches advisors to students based on these values and student advisor records are created with the corresponding program, plan, and sub-plan values.</p>

Viewing Advisors Through Self Service

If your institution has licensed PeopleSoft Campus Self Service, your students can view their advisors directly over the web.

Related Links

“Pages Used to View Advisee Information Through Self-Service” (Campus Self Service)

Viewing Advisee Information Through Self Service

If your institution has licensed PeopleSoft Campus Self Service, advisors can view an advisee's roster, view an advisee's academic program information, and view a new/drop-in advisee's roster directly over the web.

Related Links

“Viewing Advisee Information Through Self-Service Pages” (Campus Self Service)

Viewing Student Careers

This section lists the page used to view student careers.

Page Used to View Student Careers

<i>Page Name</i>	<i>Definition Name</i>	<i>Navigation</i>	<i>Usage</i>
Student Career	STDNT_CAREER	Records and Enrollment > Career and Program Information > Student Career > Student Career	View a summary of academic career information for an individual student.

Viewing Comments, Checklists, and Communications

You can create comments, checklists, and communications for students. This section discusses comments, checklists, and communications only briefly here. However, this functionality is discussed more fully in the Campus Community documentation.

- Use the Comment Summary page to view comments created for a student.
- Use the Communication Summary page to view a communication summary for a student.
- Use the Checklist Summary page to view checklist summary information for a student.
- Use the Operator 3C Groups Summary page to view and modify user inquiry groups.

Viewing Student Photos

This section lists the page used to view student photos.

Page Used to View Student Photos

<i>Page Name</i>	<i>Definition Name</i>	<i>Navigation</i>	<i>Usage</i>
Photograph	EMPLOYEE_PHOTO	Records and Enrollment > Student Background Information > Photo > Photograph	View student photos.

Managing Interoperability for Learning Management Systems (LMS)

Understanding the LMS Interoperability Batch Extract

The goal of an LMS is to use a common set of interoperability standards that enable the sharing of instructional content and data between learning and administrative environments. Based on instructional management systems (IMS) enterprise system specifications, currently PeopleSoft LMS interoperability batch extract supports one-way file transfer between PeopleSoft Campus Solutions and an external learning management system.

PeopleSoft LMS extract enables institutions to provide a third-party LMS (such as Blackboard CourseInfo) with personal profile data for learners and instructors, enrollment data and maintenance, and limited course scheduling data and maintenance. The LMS batch extract also provides basic integration with PeopleSoft Student Portal. Depending on your extract target, you can format LMS data with a unique file type of XML V1.1, Blackboard CourseInfo 4, or API Input (a WebCT format currently being phased out). WebCT Campus Edition Institutional (version 4.1) and WebCT Vista 2.1 both support XML V1.1

Currently, the feature does not support passing data or information back to PeopleSoft Campus Solutions from another LMS environment; nor does it include a real-time transactional messaging interface based on event processing.

PeopleSoft LMS batch extract supports IMS Enterprise Specification V1.1 XML data binding specifications. It also supports a simple, common, delimited option for API Input format.

File selection criteria are available at runtime for you to specify which type of files to pass. In addition, you can use packaging options to indicate how you want the system to organize the extract files.

The PeopleSoft LMS interoperability extract includes the following extract functions:

- Administrative (properties object) data that describes the contents of an extract file.
- Personal (person object) data about students and instructors that are associated with the LMS classes included in the extract.
- High-level class (group object) data describing each LMS class that is included in the extract.

This includes group term information and group course information.

- Student enrollment and instructor (group membership object) data for each LMS class.

The group is the LMS class and the membership includes the students and instructors that are associated with the LMS class.

High-level definitions for each of these data are provided in the following sections.

Properties Object Data

The properties object data serves as a file header and contains descriptive data about the contents of the file.

Person Object Data

Person object data includes:

- The person source ID wherein 1) the source is the academic institution with which the student or instructor is associated, and 2) the ID is either the individual's employee ID or user ID, depending on which is specified on the Academic Institution 3 page.
- The user ID, which is either the employee ID or user ID, depending on which is specified on the Academic Institution 3 page, of the student or instructor.
- Personal data for all students enrolled or previously enrolled in the selected LMS classes and the instructors teaching the classes.

Group Object Data - Term Information

Group object data - term information includes:

- The source ID wherein 1) the source is the description of the academic institution in which the classes are scheduled, and 2) the ID is the term code.
- The term description information and the term start and end dates.

Group Object Data - Course Information

Group object data - course information includes the source ID, wherein 1) the source is the description of the academic institution in which the class is scheduled, and 2) the ID is a unique identifier for the group. The group identifies the LMS class, which, by default, is TERM-INSTITUTION-SUBJECT-CATALOG NBR-SEC#-CLASS NBR

The ID includes the term code and class number added to the autogenerated LMS extract group ID from the LMS Data page in the schedule of classes.

Group Membership Object Data - Group

Group membership object data - group includes the source ID, which is the same as the source ID for group object data - course information.

Group Membership Object Data - Member

Group membership object data - member includes:

- The source ID, which is the same as the person source ID for person object data.
- The ID type for person or group.
- The role and, for instructors, the subrole, if any.
- The user ID (same as the person user ID for person object data).

- The class start and end dates.
- The enrollment status reason.
- For students only, a mode (grading basis) and result final grade.
- The student's preferred email address, or campus or home email address.
- The datasource, which is set on the run control page.

Understanding Integration with LMS Self-Service User Authentication

PeopleSoft LMS interoperability also provides single sign on authentication within PeopleSoft Campus Self Service, enabling students and instructors to access their learning management system home page and academic content for their LMS classes without having to sign on to the LMS website.

PeopleSoft LMS authentication uses the IMS enterprise system specifications to create a batch XML V1.1 extract file that is imported into the external LMS database. The XML V1.1 LMS extract file type is designated within the schedule of classes and autogenerates an LMS extract group ID that the system supplements with a term code and the class number to create a unique class identifier.

The LMS authentication passes user ID information and, as required, the unique class identifier to the LMS website. The user is authenticated and taken to the designated page within the LMS website, either the user's home page or the academic content for a specific class.

Note: Currently, WebCT Vista 2.1 and WebCT Campus Edition Institutional (version 4.1) are the only external learning management systems using the LMS authentication feature. Prior versions of WebCT are not supported. To determine whether support for other LMS applications has been added since this publication, please contact your PeopleSoft GSC representative.

See “Configuring Self-Service User Authentication for Your Learning Management System Website” in My Oracle Support (ID 702673.1).

Understanding LMS Setup

As you prepare to set up the LMS batch extract feature, consider the following questions:

- What type of batch extract file does your LMS vendor use: XML V1.1 (required for PeopleSoft LMS authentication), Blackboard CourseInfo 4.0, or the API Input format (a WebCT format currently being phased out)?
- If personal data is something that you need to extract, what phone type and address usage do you want to extract for the person objects?

Note: If you use the Blackboard CourseInfo extract file type, all persons whom you extract must have electronic addresses in the system.

- Will all of your classes need to be available for extract to an LMS system?

Each LMS extract file type presents slightly different extract processing requirements. Before you use the LMS Batch Extract component, familiarize yourself with the requirements of the file type that you plan to use.

All of the extract file types use *Update* and *Snapshot* extract modes.

Blackboard CourseInfo 4 creates delimited files that are uploaded through a batch utility in the Blackboard system. Students must have email addresses (preferred, home, or campus) for your PeopleSoft Campus Solutions system to extract and include the student in the people object.

The API Input format creates delimited files that are uploaded in the WebCT system through the use of an API.

Note: The API Input format is currently being phased out. However, the WebCT Campus Edition and Vista formats both support the XML V1.1 LMS extract file type that is required for Campus Solutions.

The following table further describes the requirements:

<i>Item</i>	<i>Enterprise XML V1.1</i>	<i>Blackboard CourseInfo 4</i>	<i>API Input</i>
Extract File Creation Methods	<ul style="list-style-type: none"> • Individually. • In combination with other files. • Combined in a single file. 	<ul style="list-style-type: none"> • Individually. • In combination with other files. 	<ul style="list-style-type: none"> • Individually. • In combination with other files. <hr/> <p>Note: You cannot select global files to run individually. They are run automatically every time the student file is selected. This is necessary because the global API has two formats: <i>FileAdd</i> and <i>FileUpdate</i>.</p> <hr/>
Object Output Files	<p>People</p> <ul style="list-style-type: none"> • <i>Update:</i> All students and instructors who are members of the classes that meet the runtime criteria. • <i>Snapshot:</i> All students and instructors who are members of the classes that meet the runtime criteria. 	<p>User</p> <ul style="list-style-type: none"> • <i>Update:</i> All active students in classes that meet the runtime criteria. • <i>Snapshot:</i> All active students in classes that meet the runtime criteria. 	<p>Student (the files are loaded through an API in which the course ID is specified on the command line; therefore, one file is created per class.)</p> <ul style="list-style-type: none"> • <i>Update:</i> Only active students in classes that meet the runtime criteria who have a STATUS_DT that is greater than or equal to the class enrollment extract datetime new students. • <i>Snapshot:</i> All active students in classes that meet the runtime criteria.

Item	Enterprise XML V1.1	Blackboard CourseInfo 4	API Input
	<p>Group</p> <ul style="list-style-type: none"> • <i>Update</i>: Only classes with no extract datetime that meet the runtime criteria and all classes that are designated as combined sections. • <i>Snapshot</i>: All classes that meet the runtime criteria. 	<p>Course</p> <ul style="list-style-type: none"> • <i>Update</i>: Only classes with no extract datetime that meet the runtime criteria. • <i>Snapshot</i>: All classes the meet the runtime criteria. 	<p>Class (Campus Solutions provides this file as informational because WebCT does not use an API to load classes.)</p> <ul style="list-style-type: none"> • <i>Update</i>: Only classes with no extract datetime that meet the runtime criteria. • <i>Snapshot</i>: All classes that meet the runtime criteria.

Item	Enterprise XML V1.1	Blackboard CourseInfo 4	API Input
	<p>Membership</p> <ul style="list-style-type: none"> <i>Update:</i> All instructors of the classes that meet the runtime criteria. <p>All students that meet the runtime criteria who have a STATUS_DT, ENROL_ADD_DT, GRADING_BASIS_DT, ENROL_DROP_DT, or GRADE_DT that is greater than or equal to the class enrollment extract datetime (for example, newly enrolled students or currently enrolled students with a meaningful change).</p> <ul style="list-style-type: none"> <i>Snapshot:</i> All students and instructors of classes that meet the runtime criteria. 	<p>Populate Course</p> <ul style="list-style-type: none"> <i>Update:</i> All instructors of the classes that meet the runtime criteria. <p>Only active students in classes that meet the runtime criteria who have a STATUS_DT that is greater than or equal to the class enrollment extract datetime (for example, new students).</p> <ul style="list-style-type: none"> <i>Snapshot:</i> All instructors and active students of the classes that meet the runtime criteria. 	<p>Global</p> <ul style="list-style-type: none"> <i>Update:</i> <p><i>FileAdd format:</i> Only active students in classes that meet the runtime criteria who have a STATUS_DT that is greater than or equal to the class enrollment extract datetime for all their classes.</p> <ul style="list-style-type: none"> <i>FileUpdate format:</i> Students who have already passed through the extract process at least once before, but have at least one new class in the run. <p>Active students are not included if their status date is less than the class enrollment extract datetime for all of their classes (for example, no new course list information is available to pass).</p> <p>Active students who are in more than one class, and who have a STATUS_DT that is greater than or equal to the class enrollment extract datetime for a class (for example, at least one new course is available to add to a student's list).</p> <ul style="list-style-type: none"> <i>Snapshot FileAdd format only:</i> All active students in classes that meet the runtime criteria.

Note: Students who have dropped the reported class prior to the drop or retain date are not included in any update of the LMS extract. If you run a snapshot, then run an update prior to the drop or retain date. Any students dropped since the snapshot are not updated or deleted from the LMS because their enrollments have been deleted from PeopleSoft Campus Solutions. Plan your production refresh schedule with this in mind.

Setting Up LMS Values and Default Options

Now that you have considered the extract file type that you plan to use, you can set up values and options for PeopleSoft interoperability LMS batch extract and LMS authentication.

To set up LMS values and options:

1. If you plan to use the XML V1.1 extract file type, you must set up LMS datasource codes and descriptions, LMS target codes and descriptions, and LMS type codes and descriptions.

You must create a data source code and a description for every possible extract source (for example, Undergraduate School of Business Administration, or PeopleSoft University). You must consider how you want to name your extract source information, and whether you typically extract from one small department or school at a time or extract a large group of data for a term at a time.

You must create target codes and descriptions for all of your targets (for example, the PSUNV/LMS shared server, or the School of Law server). Also, you need to create codes and descriptions for all of the different types of extract processes that you may run. These naming conventions are used as part of each XML V1.1 extract and are useful tracking tools.

2. If you plan to use PeopleSoft LMS self-service user authentication, you must set up LMS authentication profiles.

Currently, WebCT is the only LMS that uses LMS authentication. If you plan to use the LMS single sign on authentication, you must assign the LMS extract file type of XML for the LMS classes on the Schedule of Classes - LMS Data page.

3. If you plan to use PeopleSoft LMS self-service user authentication, you must set up LMS providers.

LMS providers are assigned to classes on the Schedule of Classes - LMS Data page and the Schedule New Course - LMS Data page in the **Providers for Authentication** field. LMS providers can also be assigned as default values on the Academic Institution 3 page and the Course Catalog - Components page.

4. (Optional) If you want to automatically include all newly scheduled classes in a particular LMS extract file type, you can specify the desired LMS extract file type on the Academic Institution 3 page.

If you are using LMS authentication, you can also assign a default LMS provider for authentication on the Academic Institution 3 page.

Every time that you schedule a new class, the system uses the values on the Academic Institution 3 page as default values on the Schedule of Classes - LMS Data page.

5. (Optional) If you want to automatically include only some of your newly scheduled classes in the LMS extract file type, you can specify the desired LMS extract file type, and if required, the LMS provider for authentication, on each course's respective Course Catalog - Components pages.

When you schedule classes, the system uses the values that you specify on the Course Catalog - Components page as default values on the Schedule of Classes - LMS Data page instead of using the values from the Academic Institution 3 page.

Note: You can set up default values at the institution level or at the catalog level to populate the schedule of classes. However, the extract uses only the values that are set at the class level.

- You can add or modify LMS options on the Schedule of Classes - LMS Data page or on the Schedule New Course - LMS Data page.

The LMS extract file type that is specified on the LMS Data page autogenerates an LMS extract group ID. The batch extract uses these LMS values, as does the self-service authentication process, when linking a student or instructor from a self-service page to the academic content for the class on the LMS website.

For each class that does *not* require authentication to use an LMS or other website, enter the target URL on the Schedule of Classes - LMS Data page. The URL address must be complete (for example, include "http://").

Note: Do *not* enter URLs for classes that require authentication. The system autogenerates the required URLs from the Student Center, My Class Schedule, Faculty Center - My Teaching Schedule, and Learning Management Systems self-service pages.

Pages Used to Set Up LMS Values and Default Options

Page Name	Definition Name	Navigation	Usage
LMS Datasource	LMS_DATASOURCE	Curriculum Management > Learning Management Systems > LMS System Setup > LMS Datasource	Set up codes and descriptions for potential XML batch extract sources.
LMS Target	LMS_TARGET	Curriculum Management > Learning Management Systems > LMS System Setup > LMS Target	Set up codes and descriptions for potential XML batch extract targets.
LMS Type	LMS_TYPE	Curriculum Management > Learning Management Systems > LMS System Setup > LMS Type	Set up codes and descriptions for potential XML batch extract types.
Learning Management System Authentication Profile	ESA_PROFILE_PG	Curriculum Management > Learning Management Systems > LMS Authentication Profile > Learning Management System Profile	Set up authentication profiles to communicate with your external LMS websites and to synchronize keys between your Campus Solutions site and the LMS site.

Page Name	Definition Name	Navigation	Usage
LMS Provider	LMS_INT_SETUP	Curriculum Management > Learning Management Systems > LMS Provider Setup > LMS Provider	Set up codes, descriptions, and LMS authentication profiles to enable authentication for students and instructors to access their LMS home page and LMS academic content pages. Using this page, define all LMS providers to be used with LMS authentication at your institution.
Academic Institution 3	INSTITUTION_TABLE3	Set Up SACR > Foundation Tables > Academic Structure > Academic Institution Table > Academic Institution 3	Define a default provider for authentication and the LMS extract file type to use when scheduling new classes. Define remaining LMS options for the LMS batch extract to use.
Components	CRSE_CATALOG_CMPNT	Curriculum Management > Course Catalog > Course Catalog > Components	Enter default provider for authentication and LMS extract file type values on a course-by-course basis to use when scheduling new classes.
LMS Data	CLASS_LMS_SETUP	<ul style="list-style-type: none"> • Curriculum Management > Schedule of Classes > Schedule New Course > LMS Data • Curriculum Management > Schedule of Classes > Maintain Schedule of Classes > LMS Data 	Enter or modify LMS values to use when generating the LMS batch extract and when clicking a class's LMS link on the self-service pages.

Setting Up LMS Datasource Values

Access the LMS Datasource page (**Curriculum Management > Learning Management Systems > LMS System Setup > LMS Datasource**).

This example illustrates the fields and controls on the LMS Datasource page. You can find definitions for the fields and controls later on this page.

*LMS Datasource Code	*LMS Datasource Description		
BUADGRAD	Graduate School of Business Administration	+	-
BUADUGRD	Undergraduate School of Business Administration	+	-
EXTED	School of Extended Education	+	-
GRAD	Graduate Program	+	-
LAW	School of Law	+	-
LBART	College of Liberal Arts	+	-

LMS datasource codes and descriptions are required on the LMS Batch Extract page as part of your run control parameters if you run the batch extract process with an LMS batch extract file type of XML V1.1. If you run the batch extract process with an LMS extract file type of Blackboard CourseInfo 4 or API Input format, this setup is not required.

<i>Field or Control</i>	<i>Description</i>
LMS Datasource Code and LMS Datasource Description	<p>Enter an LMS datasource code and corresponding LMS datasource description for all valid data sources. The data source is an identifier for the site generating the XML file and is used in the properties object (header record).</p> <p>For XML file types, the LMS datasource code must be entered at runtime on the LMS Batch Extract - Setup page.</p>

Setting Up LMS Target Values

Access the LMS Target page (**Curriculum Management > Learning Management Systems > LMS System Setup > LMS Target**).

This example illustrates the fields and controls on the LMS Target page. You can find definitions for the fields and controls later on this page.

*LMS Target Code	*LMS Target Description		
BUADSRVR	School of Business LMS Server	+	-
LAWSRVR	School of Law LMS Server	+	-
LBARTSSVR	Liberal Arts LMS Server	+	-
PSUNVSRVR	PSUNV Shared LMS Server	+	-

LMS target code and description information is required on the LMS Batch Extract - Setup page as part of your run control parameters if you run the batch extract process with an LMS type of XML V1.1. If you run the batch extract process with an LMS extract file type of Blackboard CourseInfo 4 or API Input format, this setup is not required.

Field or Control	Description
LMS Target Code and LMS Target Description	<p>Enter an LMS target code and corresponding LMS target description for all valid recipients of the XML files. The target code is an identifier for the site receiving the XML file and is used in the properties object (header record).</p> <p>For XML file types, the LMS target code is entered at runtime on the LMS Batch Extract - Setup page.</p>

Setting Up LMS Type Values

Access the LMS Type page (**Curriculum Management > Learning Management Systems > LMS System Setup > LMS Type**).

This example illustrates the fields and controls on the LMS Type page. You can find definitions for the fields and controls later on this page.

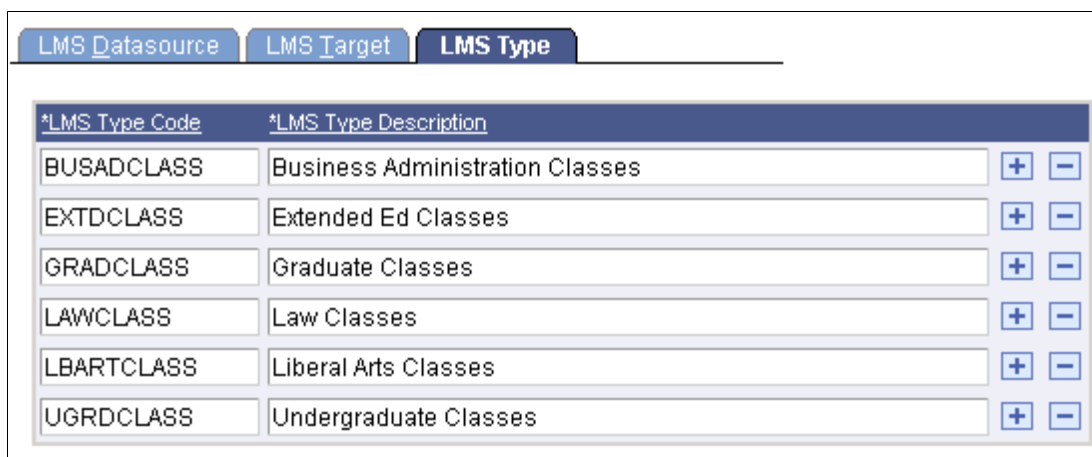

LMS type and description information is required on the LMS Batch Extract - Setup page as part of your run control parameters if you run the batch extract process with an LMS type of XML V1.1. If you run the batch extract process with an LMS extract file type of Blackboard CourseInfo 4 or API Input format, this setup is not required.

Field or Control	Description
LMS Type Code and LMS Type Description	<p>Enter an LMS type code and a corresponding LMS type description to specify the nature of any extract that you may perform with this type. The type code is used in the properties object (header record).</p> <p>For XML types, the LMS type code is entered at runtime on the LMS Extract - Setup page.</p>

Setting Up LMS Authentication Profiles

If you plan to use PeopleSoft LMS authentication, you must configure your system to communicate with external LMS sites by creating an LMS authentication profile and synchronizing the keys between your Campus Solutions site and the external LMS site. Keys enable the two sites to recognize the requests that are passed between them and to authenticate your self-service users to the LMS site.

Using LMS authentication, end-users sign on one time to enter the PeopleSoft Campus Self Service.

When using the self-service Learning Management Systems page, users can click an LMS provider link, which takes them to their home page within the LMS system such as WebCT. For classes, you can assign LMS providers for authentication at the Academic Institution and Course Catalog Component level. The system then uses the provider as a default value when adding a class to the schedule of classes. You can also assign or update providers at the class level.

If an LMS provider is assigned to a class, the system displays an **LMS** button next to the class within the self-service Student Center, My Class Schedule page, and Faculty Center - My Teaching Schedule page. When students or instructors click the button, the system quickly performs the authentication and moves the user to the academic class content on the LMS website. The authentication happens without users explicitly signing on to the other site, without their having any sense of moving out of the Campus Solutions application, and without having to add another user ID or password to their ever-growing list of IDs and passwords.

You can also assign LMS providers without using LMS authentication for use on the Learning Management Systems self-service page. In this case, you assign a target URL, such as an institution or division website that has links to instructor web pages.

You can also use the LMS provider as a run control parameter within the LMS batch extract process.

See “Configuring Self-Service User Authentication for Your Learning Management System Website” in My Oracle Support (ID 702673.1).

Related Links

“Using LMS Authentication” (Campus Self Service)

Defining LMS Providers

Access the LMS Provider page (**Curriculum Management > Learning Management Systems > LMS Provider Setup > LMS Provider**).

This example illustrates the fields and controls on the LMS Provider page. You can find definitions for the fields and controls later on this page.

LMS Provider

Academic Institution: PSUNV PeopleSoft University

LMS Provider: CAMPUS LMS

Learning Management System Providers

View All First 1 of 1 Last

*Effective Date	01/01/1900	Effective Status	Active
Description:	CAMPUS LMS		
LMS Authentication Profile	CAMPUS LMS	<input checked="" type="checkbox"/> Display as LMS Link	
Comments:	<div style="border: 1px solid gray; padding: 2px; min-height: 40px;"> The Campus LMS allows users to access the school website that has links to individual faculty member websites. </div>		

<i>Field or Control</i>	<i>Description</i>
Effective Date	Enter the date when the status of this LMS provider becomes effective. Use a new effective date each time that you make a change to a provider. Insert new rows as needed, and modify the record.
Description	Enter the description to display to students and instructors from the self-service Learning Management System page.
LMS Authentication Profile	If the provider uses the LMS authentication feature, select the LMS authentication profile to use for that provider.
Default URL	The system hides and clears the Default URL field when you enter an LMS authentication profile. If you do not enter an LMS authentication profile, the Default URL field is available so that you can specify the default URL to use for a provider who does not use LMS authentication. You might want to use the URL that takes the user to an institution or division website from the Learning Management Systems page. Be sure to enter the complete URL (including http://).
Display as LMS Link	Select this check box to display the LMS provider as a link on the self-service Learning Management System page. The link enables users to access their LMS site homepage by way of PeopleSoft LMS authentication.
Comments	Enter comments to further describe or identify the LMS provider.

Defining LMS Default and Extract Options for Your Institution

Use the **LMS Options** group box on the Academic Institution Table 3 page to specify the LMS extract file type default values if all your classes need to be available to extract to a learning management system. If you plan to use PeopleSoft LMS authentication, you must also specify the provider for authentication.

The system uses the values that are defined on the Academic Institution Table 3 page as default values when adding a class to the schedule of classes.

The LMS batch extract uses the personal data extract parameters of phone type and address usage. The user ID extract option identifies whether the extract should use the student or instructor's employee ID or user ID. User IDs are created on the User Profile page.

Note: The user ID value is of particular importance for LMS authentication. For the user's authentication to work properly, the selected user ID extract option must be the same as the LMS authentication profile - authentication user ID value. If you set the user ID extract option to user ID on the Academic Institution Table 3 page, then authentication user ID must also be set to user ID on the LMS Authentication Profile page.

See “Configuring Self-Service User Authentication for Your Learning Management System Website” in My Oracle Support (ID 702673.1).

Related Links

“Setting Additional Institution Defaults and Options” (Campus Solutions Application Fundamentals)

Defining LMS Default Options for Course Components

Use the Course Catalog - Components page to enter LMS values on a course-by-course basis if you have not specified a default LMS extract file type and a default provider for authentication (if you plan to use PeopleSoft LMS authentication) on the Academic Institution 3 page. When you enter LMS values on the Course Catalog - Components page, the system overrides the values that are set on the Academic Institution 3 page and uses the Course Catalog - Components page values as defaults.

Related Links

[Defining Course Components](#)

Defining LMS Options for Classes

If you have not specified, on either the Academic Institution 3 page or the Course Catalog - Components page, a default LMS extract file type and a default provider for authentication (if you plan to use PeopleSoft LMS authentication), you must enter your LMS values on the Schedule of Classes - LMS Data page.

All LMS classes must have an LMS extract file type and an LMS extract group ID defined on the Schedule of Classes - LMS data page. You can also modify the LMS that comes in from the Academic Institution 3 page or the Course Catalog - Components page.

Note: You must assign an extract file type to use. To use PeopleSoft LMS authentication, you must use the XML LMS extract file type and you must identify a provider for authentication.

The LMS authentication is designed to work with the IMS enterprise system specifications that are used to create the batch XML V1.1 extract file. When the XML V1.1 LMS extract file type is designated within the Schedule of Classes, the system autogenerates the LMS extract group ID. During the extract process and LMS authentication from self-service pages, the system creates a unique class identifier by supplementing the LMS group ID with a term code and the class number.

If you do not want to use LMS authentication, but want to link students who are enrolled in a class to a designated URL such as an instructor's website, you can specify the website in the **LMS URL** field. The website URL must be preceded by the http:// designation.

Note: Do not specify URLs for classes that require authentication to the LMS site. When using PeopleSoft LMS authentication, the system autogenerates the required URLs from the Student Center, My Class Schedule, and Faculty Center - My Teaching Schedule self-service pages.

Related Links

[Defining LMS Options for Classes](#)

Running the LMS Batch Extract Process

Use the PeopleSoft LMS Batch Extract process to create extract files of object properties data in the appropriate format for your target LMS. If you use PeopleSoft LMS authentication, you must use the XML LMS extract file type and select the appropriate provider for authentication.

You can specify all of your runtime parameters on the LMS Batch Extract - Setup and LMS Extract - Criteria pages, and designate the appropriate file path for your extract files on the LMS Batch Extract - Output page. After the process finishes, you can locate your extract files in the file directory that you specify. You can run the extract process in either snapshot or update mode.

Prerequisites

Before you can perform an extract for XML V1.1, you must create LMS datasource, LMS target, and LMS type values in the LMS Setup component.

Related Links

[Setting Up LMS Values and Default Options](#)

Pages Used to Extract LMS Data

<i>Page Name</i>	<i>Definition Name</i>	<i>Navigation</i>	<i>Usage</i>
LMS Batch Extract Process - Setup	RUNCTL_SRLMSEX1	Curriculum Management > Learning Management Systems > LMS Batch Extract Process > Setup	Specify properties and parameters for the extract process and header properties object.

<i>Page Name</i>	<i>Definition Name</i>	<i>Navigation</i>	<i>Usage</i>
LMS Batch Extract Process - Criteria	RUNCTL_SRLMSEX2	Curriculum Management > Learning Management Systems > LMS Batch Extract Process > Criteria	Further narrow your specifications for the extract process.
LMS Batch Extract Process - Output	RUNCTL_SRLMSEX3	Curriculum Management > Learning Management Systems > LMS Batch Extract Process > Output	Specify the extract file path and storage conventions for the extract process.

Defining LMS Run Control Parameters

Access the LMS Batch Extract Process - Setup page (**Curriculum Management > Learning Management Systems > LMS Batch Extract Process > Setup**).

This example illustrates the fields and controls on the LMS Batch Extract Process - Setup page. You can find definitions for the fields and controls later on this page.

Setup

Criteria

Output

Run Control ID: 1 [Report Manager](#) [Process Monitor](#) Run

***Institution:** PeopleSoft University

***Term:** 2004 Fall

File Properties

Provider for Authentication:

***LMS Extract File Type:**

Datasource:

Target:

Type:

***Extract Mode:**

Language:

<i>Field or Control</i>	<i>Description</i>
Institution	Enter the institution that specifies the source of the extract data.
Term	Enter the term that specifies the source of the extract data.

Field or Control	Description
Provider for Authentication	Specify the authentication provider to use within the extract. Single signon providers are defined on the LMS Provider Setup page and are assigned to classes on the Schedule of Classes - LMS Data page.
LMS Extract File Type	<p>Specify the file type, or extract format, to use within the extract. Values are: <i>XML V1.1</i> (required for PeopleSoft LMS authentication), <i>Blackboard CourseInfo 4</i>, and <i>API Input</i> (the WebCT format that is currently being phased out; however, WebCT Campus Edition and Vista both support XML V1.1).</p> <p>Values for this field are delivered with your system as translate values. Do not modify these values in any way. Any modifications to these values require a substantial programming effort.</p> <p>The LMS extract file type that you specify here must be the same as the LMS extract file type that is assigned to the LMS classes on the Schedule of Classes - LMS Data page.</p> <hr/> <p>Note: If you select a file type of <i>Blackboard CourseInfo4</i> or <i>API Input</i>, the Datasource, Target and Type fields become unavailable.</p> <hr/>
Datasource and Target	Enter the datasource and target that serve as identifiers for the site generating the XML file. For example, you might have a datasource of <i>College of Liberal Arts</i> and a target of <i>Liberal Arts LMS Server</i> .
Type	Enter the extract type that describes the classes that you want to extract. For example, keeping with the datasource and target examples, you might enter <i>Liberal Arts Classes</i> .

Field or Control	Description
<p>Extract Mode</p>	<p>Specify an extract mode. Values for this field are delivered with your system as translate values. Do not modify these values in any way. Any modifications to these values require a substantial programming effort. The current set of values include:</p> <p><i>Snapshot:</i> Full set of data for purposes of initial group creation or reloads.</p> <p><i>Update:</i> Partial set of changes that applies to enrollment, group, and group membership.</p> <p>The effectiveness of the LMS extract mode of <i>Update</i> on the run control page depends on the LMS extract file type on the Schedule of Classes - LMS Data page. This is because Blackboard CourseInfo 4.0 standard edition and API Input (the WebCT format that is currently being phased out) both have limiting specifications on what data they can currently accept in update form. When you run Blackboard CourseInfo 4 in <i>Update</i> mode, only new user and new course data since the last time the process ran is accepted. When you run API Input in <i>Update</i> mode, only new user and new course data, since the last time the process ran, and new enrollment and new course list information, is accepted.</p> <p>In addition, students who dropped prior to the drop or retain date are not included in any update of the LMS extract. In other words, if you run a snapshot, then run an update prior to the drop or retain date, any students dropped since the snapshot are not updated or deleted from the LMS because their enrollments have been deleted from Campus Solutions. Plan your refresh schedule with this in mind.</p>

Field or Control	Description
<p>Language</p>	<p>Enter a two-character language value that serves as an attribute of the properties object, for example, <PROPERTIES lang="en">,ISO 639 format. This field is optional.</p>

After you enter all necessary data on the LMS Batch Extract - Setup, LMS Batch Extract - Criteria, and LMS Batch Extract - Output pages, click **Run** to run this request. PeopleSoft Process Scheduler runs the LMS Batch Extract process at user-defined intervals.

Defining LMS Run Control Criteria

Access the LMS Batch Extract Process - Criteria page (**Curriculum Management > Learning Management Systems > LMS Batch Extract Process > Criteria**).

This example illustrates the fields and controls on the LMS Batch Extract Process - Criteria page. You can find definitions for the fields and controls later on this page.

The fields on this page prompt against the institution and term that you specify on the LMS Batch Extract - Setup page. If you do not enter any narrowing parameter information on the LMS Batch Extract Process - Criteria page, the process runs for the institution and term that are specified on the LMS Batch Extract Process - Setup page.

Selection Criteria

Select an option to indicate the level of filtering to apply in addition to the parameters on the LMS Batch Extract Process - Setup page.

Field or Control	Description
None	Select to disable all fields.
Filter	Select to enable the field filters.
Class Number	Select to disable the field filters and enable the Class Nbr (class number) field.

Additional Elements

<i>Field or Control</i>	<i>Description</i>
Career	Enter a career if you want to isolate only those courses that are offered under a particular academic career.
Session	Enter a session to isolate classes within the term that are specified on the LMS Batch Extract Process - Setup page and within a particular session.
Campus	Enter a campus to filter those classes that are offered by a particular campus.
Academic Group	Enter an academic group to filter classes that are associated with a particular group.
Subject Area	Enter a subject area to filter those classes with a particular subject.
Catalog Nbr (catalog number)	Enter a catalog number to isolate a particular course.
Class Nbr (class number)	Enter a class number to specify a particular class offering. This field is available when the Class Number option is selected.

After you enter all necessary data on the LMS Batch Extract Process - Setup, LMS Batch Extract Process - Criteria, and LMS Batch Extract Process - Output pages, click **Run** to run this request. PeopleSoft Process Scheduler runs the LMS Batch Extract process at user-defined intervals.

Note: The system treats cleared fields as wild cards and returns all values.

Defining LMS Output Parameters

Access the LMS Batch Extract Process - Output page (**Curriculum Management > Learning Management Systems > LMS Batch Extract Process > Output**).

This example illustrates the fields and controls on the LMS Batch Extract Process - Output page. You can find definitions for the fields and controls later on this page.

Note: The LMS Batch Extract Process - Output page appears differently depending on the file type (*XML*, *Blackboard*, or *API*) that you select.

Field or Control	Description
<p>File Path</p>	<p>Enter a file path to indicate the extract file location. This is where your extracted people, classes, and enrollment files are located. In addition to sending report output for this process to a file (through setting preferences in the PeopleSoft Process Monitor), you can also send any additional output files that are created by this process to a file directory. To send the extract output to a file directory, enter a valid directory path that maps to a folder with appropriate read/write permission. If you cannot locate such a folder, consult your system administrator.</p>
<p>Combine Output</p>	<p>This check box is available if you select a file type of <i>XML V1</i> on the LMS Batch Extract Process - Setup page. Select this check box to combine person, group, and membership objects into one file.</p> <p>When this check box is cleared, you can further specify the level and location of objects to extract. In doing so, you must also create individual file names for each object.</p> <hr/> <p>Note: You must always include the file type (such as XML) in the output name.</p>

Field or Control	Description
People	Select this check box to include person object data in the extract for all students and instructors who are associated with the selected LMS classes. Enter a corresponding file name for this data. This check box is unavailable if you select a file type of <i>API Input</i> (the WebCT format that is currently being phased out) on the LMS Batch Extract Process - Setup page.
Group	Select this check box to include group object data in the extract for all selected LMS classes. Enter a corresponding file name for this data.
Membership	Select this check box to include membership object data in the extract, which identifies each LMS class and the students and instructors who are associated with the class. Enter a corresponding file name for this data.

After you enter all necessary data on the LMS Batch Extract Process - Setup, LMS Batch Extract Process - Criteria, and LMS Batch Extract Process - Output pages, click **Run** to run this request. The LMS Batch Extract process:

- Collects and stores the appropriate data in an extract file (or files) with the name and file path that you specify.
- Creates an SQR .log file that provides detail about the process itself.
- Creates a detailed LMS Batch Extract report (SRLMSEX.<file extension>) that highlights the parameters, messages, and total record count for the process.

PeopleSoft Process Scheduler runs the LMS Batch Extract Report process at user-defined intervals.

Click the **Process Monitor** link to access the Process Detail page, where you can view the status of submitted process requests. From the Process Detail page, click the **View Log/Trace** link to access the SQR .log and LMS Batch Extract report (SRLMSEX.<file extension>).

Using Self-Service Pages and LMS Authentication

If your institution has licensed PeopleSoft Campus Self Service, students and instructors can access LMS websites from your system.

Related Links

“Using LMS Authentication” (Campus Self Service)

Chapter 50

Grading Students

Understanding Grading

After you set up your grading schemes and grade bases, define mapping rules, and generate grade rosters, you are ready to enter grades.

You can enter grades in one of three ways:

- System administrators or power users can enter grades directly on the Grade Roster page for each class.
- Instructors can define class assignments, percentages, and even electronically communicate with students by entering grades directly through PeopleSoft Gradebook, a separately licensed PeopleSoft application.
- Instructors or other authorized self-service users can enter midterm and final grades through PeopleSoft Campus Self Service, a separately licensed PeopleSoft application.

Prerequisites

Before you can enter and post grades, you must:

- Set up your grading schemes and grade bases.
- Define mapping rules.
- Generate grade rosters.

Related Links

[Understanding Grade Preparation](#)

Printing Grade Rosters

This section provides an overview of printing a grade roster and discusses how to run the Grade Roster report.

Understanding Printing a Grade Roster

Some organizations have business processes that use grade rosters in printed form. This section discusses how to print grade rosters in batch or for a specific class.

Complete these steps to print grade rosters:

1. Access the Grade Roster Print page.
2. Enter your run control parameters.
3. Click the **Run** button.
4. Locate your printed rosters through the **Report Manager** link, and print them as needed.

Page Used to Print Grade Rosters

<i>Page Name</i>	<i>Definition Name</i>	<i>Navigation</i>	<i>Usage</i>
Grade Roster Print	RUNCTL_SRGRDROSTER	Curriculum Management > Grading > Print Grade Roster > Grade Roster Print	Print generated rosters.

Running the Grade Roster Report

Access the Grade Roster Print page (**Curriculum Management > Grading > Print Grade Roster > Grade Roster Print**).

This example illustrates the fields and controls on the Grade Roster Print page. You can find definitions for the fields and controls later on this page.

Grade Roster Print

Run Control ID: 1 [Report Manager](#) [Process Monitor](#) Run

*Academic Institution: PeopleSoft University Print Note Area
 Print Incomplete Area

*Term: 2005 Fall

Grade Roster Type:

Find | View All First 1 of 1 Last

Sequence Number: 1 Specific Class + -

Academic Organization: Mathematics

Session:

Class End Date From:

Class End Date To:

Campus:

Print Options

*Instructor Print Option

Print Course Administrator

Print Blind Grading ID

<i>Field or Control</i>	<i>Description</i>
Academic Institution	Select the institution for which to print rosters.

Field or Control	Description
Term	Select a term for the roster. Term values are defined on the Term Table page.
Grade Roster Type	Select the grade roster type to print. The default is <i>Final</i> . Grade roster type values are delivered with your system as translate values. While you should not change the <i>Final Grade</i> value, you can add as many nonfinal grade values as you want.
Print Note Area	Select to provide extra space on the roster for instructors to write notes.
Print Incomplete Area	Select to provide extra space on the roster for instructors to make note of incomplete information.
Specific Class	Select to print a roster for one class.
Class Nbr (class number)	If you select the Specific Class check box, the Class Nbr field becomes available. Select the class number for the roster to print.
Academic Organization	If you do not select the Specific Class check box, select an academic organization. Academic organization values are defined on the Academic Organization Table page.
Session	Select the session for which to print rosters.
Class End Date From and Class End Date To	Select the class end date from and to dates. The system selects rosters to print for classes with an end date that is greater than or equal to the value in the Class End Date From field and less than or equal to the value in the Class End Date To field.
Campus	Select the campus that is associated with the grade rosters. Attach campus values to courses in the course catalog and to classes in the schedule of classes.
Instructor Print Option	Select the type of instructor information to print on the grade roster for the graded component. Attach instructor values to classes on the Schedule of Classes - Basic Data page. Values are: <i>All</i> : Prints the names of all instructors. <i>Grdng Auth</i> : Prints only the name of the instructor who is authorized to grade. <i>None</i> : Prints no instructor names.

<i>Field or Control</i>	<i>Description</i>
Print Course Administrator	Select to print the course administrator's name on the grade roster. Attach course administrator values to classes on the Schedule of Classes - Basic Data page.
Print Blind Grading ID	Select to print the blind grading IDs of students. Student names do not appear on the roster.

Entering Grades Online

This section provides an overview of entering grades online and discusses how to:

- Use the Grade Roster page to enter grades.
- Review student enrollment detail.
- Review transcript notes.
- Review student incomplete information.

Understanding Entering Grades Online

System administrators and power users can enter grades directly to the Grade Roster page for each class. Complete these steps to enter grades online:

1. Enter grades and transcript notes on the Grade Roster page.
2. (Optional) Review student enrollment detail on the Student Enrollment Detail page.
3. (Optional) Enter or review a transcript note for the student on the Transcript Note page.
4. (Optional) Enter student incomplete information on the Student Incomplete page.
5. Save the grade roster.

Pages Used to Enter Grades Online

<i>Page Name</i>	<i>Definition Name</i>	<i>Navigation</i>	<i>Usage</i>
Grade Roster	GRADE_ROSTER1	Curriculum Management > Grading > Grade Roster > Grade Roster	Enter official grades and requirement designation grades, view enrollment summary information, and add transcript notes.

Page Name	Definition Name	Navigation	Usage
Enrollment Detail	GRADE_ROSTER_ENRL	Click the Detail link on the Grade Roster page.	Review detailed information about a student's enrollment, including their primary academic program, grading basis, units taken, and so on.
Transcript Note	GRADE_ROSTER_NOTEA	Click the Note link on the Grade Roster page.	Enter or view a transcript note that is related to the student's enrollment record. The system displays this note on transcript types for which the Print Transcript Notes check box is selected on the Enrollment/Statistics page.
Student Incomplete	GRADE_ROSTER_INCA	Click the Incomplete Detail button on the Transcript Note page.	Enter a lapse deadline, lapse to grade, or comment for students who have no grade or a grade that is equivalent to a grade of <i>Incomplete</i> .
Student Milestone Grade	SSR_MLSTN_GRD	Curriculum Management > Grading > Grade Roster > Student Milestone Grade	Enter a student's milestone grade.
Milestone	SSR_CRSE_MLSTN_GRD	Click the Milestone link on the Grade Roster page.	View a student's milestone grade.

Using the Grade Roster Page to Enter Grades

Access the Grade Roster page (**Curriculum Management > Grading > Grade Roster > Grade Roster**).

This example illustrates the fields and controls on the Grade Roster page. You can find definitions for the fields and controls later on this page.

Grade Roster Type		Grade Roster							
Find First 2 of 2 Last									
Term:	2005 Sum	Class Nbr:	1254 Perspectives on the Present						
Session:	Twelve Wk	Catalog:	HISTORY 100						
Section:			1						
Seq Nbr:			2						
Roster Type									
Final Grade	Final Grade	<input type="checkbox"/> Display Unassigned Roster Grade Only							
Approval Status:	Not Reviewed								
ID	Name	Roster Grade	Converted Roster Grade	Official Grade	Career	Grading Basis	Final Roster Status	Detail	Note
1 SR12206	Kalombo,Chantal	<input type="text"/>			Undergrad	PNP	Pending	Detail	Note
2 SR12201	Keshishi,Khanom	A+	A	A	Undergrad	Graded	Posted	Detail	Note
3 SR12202	Lancet,Amit	B		B	Undergrad	Graded	Posted	Detail	Note
4 SR12210	Omar,Raad	<input type="text"/>			Undergrad	Graded	Pending	Detail	Note
5 SR12212	Pople,John	<input type="text"/>			Graduate	Graded	Pending	Detail	Note
6 SR12031	Ruiz,Robert			WF	Undergrad	Graded	Graded	Detail	Note

If you use blind grading IDs, the roster lists students in random order. If you do not use blind grading IDs, the roster lists students in ID order.

Field or Control	Description
Sort Option	<p>This option is available on Open Entry/Exit class rosters. You can sort IDs in one of two ways. Values are:</p> <p><i>Last,First</i>: Sorts IDs by last name.</p> <p><i>Date,Last</i>: Sorts IDs by fully graded date, and then by last name within the start date. This view is particularly useful for classes that are offered in open entry and open exit format, where students can have fully graded dates that differ.</p>
Display Unassigned Roster Grade Only	<p>Select to view only those students with unassigned grades. This option is particularly useful for open entry and open exit classes for which you might grade students at different intervals based on their various end dates.</p>
Name	<p>Preferred name appears by default. If no preferred name exists, the primary name appears.</p> <p>Preferred name also appears by default on the Enrollment Detail, Transcript Note, Student Milestone Grade, and Milestone pages.</p>

Field or Control	Description
Roster Grade	<p>Enter the student's grade for the course. This field displays only grades assigned on the grade roster; it does not display grades assigned in enrollment. After grades are posted, this field displays the grade but is unavailable for updating.</p> <p>All active Grade Input values from the Grading Scheme Table page are available in the Roster Grade field, regardless of whether the Include in Self Service check box on the Grading Scheme Table page is selected.</p>
Converted Roster Grade	<p>This field appears when at least one roster grade has a value defined in the Convert to Grade field on the Grading Scheme Table page.</p> <p>The Converted Roster Grade field continues to appear when grades are posted.</p>
Official Grade	<p>This field displays posted grades and grades that have been assigned on a student enrollment page.</p>
Roster RD Grade (roster requirement designation grade)	<p>This field becomes available if the class has a requirement designation that requires a separate grade. Values are:</p> <p><i>Satisfied:</i> A basic credit.</p> <p><i>Not Satisfied:</i> No credit type of grade.</p> <p>If the requirement designation requires a separate grade, then it is assumed that the requirement designation is satisfied when a passing grade is posted for the student.</p> <p>See Defining Requirement Designations.</p>
Detail	<p>Click to access the Student Enrollment Detail page, where you can view detailed information about each enrollment.</p>
Note	<p>Click to access the Transcript Note page, where you can view a transcript note that is related to the student enrollment record.</p>

After a student's grade is posted or assigned and saved on an enrollment page, the student's final roster grade field becomes unavailable for update. The system displays the roster's approval status on the Grade Roster page, as well as a status of *Posted* when the roster is posted.

Reviewing Student Enrollment Detail

Access the Enrollment Detail page (click the **Detail** link on the Grade Roster page).

Use this page to view detailed information about a student's enrollment. You can view the student's enrollment status, grading basis, units taken, and primary academic program. If you have already entered a grade for the student, you can also view the grade in and official grade.

Reviewing Transcript Notes

Access the Transcript Note page (click the **Note** link on the Grade Roster page).

Field or Control	Description
Note ID	Enter a value. Note ID values are defined on the Transcript Note Table page.
Transcript Note	Enter free-form text. The system displays this text in addition to the predetermined transcript note ID text.
Transcript Note Sequence Nbr (transcript note sequence number)	The system increments the transcript note sequence number for each row of free-form text. The sequence number determines the order in which the free-form transcript notes appear on the transcript (if they appear).
Incomplete Detail	If you enter a grade of <i>Incomplete</i> on the Grade Roster page, the Incomplete Detail link is available. Click this link to enter data related to an <i>Incomplete</i> grade.

Note: Users cannot add, change, or remove transcript notes from the grade roster after grades are posted. After grades are posted, users can add, change, and remove transcription notes from any one of the administrative enrollment pages and then regenerate the grade roster:

Enrollment: On Student Enrollment 3 page, enter a new note, modify an existing note, or delete a current note.

Enrollment Request: Select the action of *Normal Maintenance* for the class and enter a new note, modify an existing note, or delete a current note. Be sure to submit the transaction.

Quick Enroll: Select the action of *Normal Maintenance* for the class and then, on the Other Class Info page, click **Create Transcript Note**. Enter a new note, modify an existing note, or delete a current note. Be sure to submit the transaction.

To update the grade roster with the changes to the transcript notes, navigate to the Grade Roster Type page, select **Override**, and click the **Create** button to regenerate the grade roster.

Reviewing Student Incomplete Information

Access the Student Incomplete page (click the **Incomplete Detail** button on the Transcript Note page).

Field or Control	Description
Lapse Deadline and Lapse To Grade	The system populates these fields when you enter a grade of <i>Incomplete</i> . The system creates a student incomplete record when you post the <i>Incomplete</i> grade. However, you can manually enter these values. If the student has an <i>Incomplete</i> grade, you can specify the date for this grade to lapse to another grade. The Grade Lapse process does not overwrite values that are entered manually.

Field or Control	Description
Comment	Enter any comments about the lapse grade. These comments do not appear on the transcript.

Related Links

[Viewing the Lapse Report Results Online](#)

[Defining Grade Lapse Rules](#)

Entering Grades Through Self Service

If your institution has licensed PeopleSoft Campus Self Service, your instructors can access grade rosters and enter midterm and final grades directly over the web.

Related Links

[“Entering Grades Through Self-Service” \(Campus Self Service \)](#)

Entering Grades Through the Self-Service Gradebook

In addition to the grade methods mentioned in the previous section, instructors can use PeopleSoft Gradebook to enter grades for individual assignments, quizzes, and tests, midterm grades, and final grades. PeopleSoft Gradebook is a separately licensed application.

Related Links

[“Entering Grades” \(Gradebook\)](#)

Posting the Grade Roster

Posting the grade rosters is an important step because it officially assigns final class grades to the students' career term records.

This section provides an overview of posting grades, lists prerequisites, and discusses how to:

- Post grades for a single class.
- Post grades for multiple classes.

Understanding How to Post Grades

You can post grades in these ways:

- Post grades for a single class on the Grade Roster page.

- Post grades for a single class on the Self Service Grade Roster page.
- Post grades for multiple classes on the Grade Post page.

Post Grades for a Single Class

Complete these steps to post grades for a single class:

1. (Optional) To perform a partial post of grades, select the **Partial Post** check box and click the **Post** button on the Grade Roster page.
2. To post the entire grade roster, clear the **Partial Post** check box and click the **Post** button on the Grade Roster page.

Post Grades on the Self-Service Grade Roster Page

Complete these steps to post grades on the self-service Grade Roster page:

Note: The instructor must have post access to be able to post from Campus Self Service.

1. Assign grades on the Self Service Grade Roster page.
2. Set approval status to approved and save.
3. Click **Post**.

Post Grades for Multiple Classes

Complete these steps to post grades for multiple classes:

1. Access the Grade Post page and specify the institution, term, and partial post option for which you want to post grades.
2. (Optional) Narrow the batch for which you want to post grade rosters by entering any of the following values:
 - a. *Session*
 - b. *End date*
 - c. *Academic Organization*
 - d. *Subject Area*
3. (Optional) Add rows as needed.
4. Click the **Run** button.

Prerequisites

Before you can post grades, you must:

- Generate the grade rosters.

- Enter grades on the Grade Roster page or enter grades through the PeopleSoft Gradebook application.

Pages Used to Post Grade Rosters

<i>Page Name</i>	<i>Definition Name</i>	<i>Navigation</i>	<i>Usage</i>
Grade Roster Type	GRADE_ROSTER_TYPE	Curriculum Management > Grading > Grade Roster > Grade Roster Type	Click the Post button on the Grade Roster Type page to post grades on a course-by-course basis. For partial posting, select the Partial Post check box before you click the Post button.
Grade Post	RUNCTL_GRD_POST	Curriculum Management > Grading > Grade Post > Grade Post	Post grades for multiple classes. You can post grades for multiple classes within an academic organization or subject area.

Posting Grades for a Single Class

Access the Grade Roster Type page (**Curriculum Management > Grading > Grade Roster > Grade Roster Type**).

Click the **Post** button to post grades on a course-by-course basis. For partial posting, select the **Partial Post** check box before you click the **Post** button.

Related Links

[Creating Grade Rosters for a Single Class](#)

Posting Grades for Multiple Classes

Access the Grade Post page (**Curriculum Management > Grading > Grade Post > Grade Post**).

<i>Field or Control</i>	<i>Description</i>
Academic Institution	Select the academic institution for the grade posting. This value determines which terms, sessions, and other field values are available.
Term	Select the term for the grade posting. Term values are defined on the Term Table page.
Session	Select the session for the grade posting. Session is an optional field. Session values are defined on the Session Table page.

Field or Control	Description
Class End Date From and Class End Date To	Select the class end date from and to dates. The system selects rosters to create for classes with an end date that is greater than or equal to the value in the Class End Date From field and less than or equal to the value in the Class End Date To field. Both fields are optional and one may be entered without the other.
Academic Organization	Select either an academic organization or a subject area in which to post grades. Academic organization values are defined on the Academic Organization Table page.
Subject Area	Select either an academic organization or a subject area in which to post grades. Subject area values are defined on the Academic Subject Table page.
Partial Post Option	<p>Select to post only those grades that you enter and save on the roster. Later, you can enter the remaining grades and post those. Values are:</p> <p><i>Yes:</i> Select to partially post all rosters in your parameters, regardless of whether or not the rosters are missing grades. The batch grade post process performs a partial post on all grade rosters, regardless of whether you selected the Partial Post check box on the Grade Roster Type page.</p> <p><i>No:</i> Select to post only rosters that have a status of <i>Approved</i>. This option does not permit reposting of the same roster type.</p> <hr/> <p>Note: After the system posts the grades, all statistics accumulate. If any revisions are needed on individual records, you must make these on a student-by-student basis on an enrollment page or on the self-service Grade Roster page, request grade change.</p> <hr/>

Generating Midterm Deficiency Reports and Communications

Important! Letter Generation (Letter Gen) is a deprecated product. It is strongly recommended that you use Communication Generation (Comm Gen) instead. For more information on Comm Gen, see “Using the Communication Generation Process” (Campus Community Fundamentals)

This section provides an overview of midterm deficiency reporting and discusses how to:

- Generate the midterm deficiency report.
- Generate midterm deficiency letters.

Understanding Midterm Deficiency Reporting

The Mid-Term Deficiency process generates a report that lists students with deficient midterm grades. Deficient grades are those grades with a grade input value that is equal to the value in the **Grade Input** field on the Mid-Term Deficiency Report page.

Page Used to Monitor Midterm Deficiencies

<i>Page Name</i>	<i>Definition Name</i>	<i>Navigation</i>	<i>Usage</i>
Mid-Term Deficiency Report	RUNCTL_SRTRMDEFCNY	Curriculum Management > Grading > Mid-Term Deficiency Report > Mid-Term Deficiency Report	Produce a summary report of all students whose grades are deficient during the midterm for each class.

Generating the Midterm Deficiency Report

Access the Mid-Term Deficiency Report page ((**Curriculum Management > Grading > Mid-Term Deficiency Report > Mid-Term Deficiency Report**)).

The system inserts the IDs of all students with deficient grades into the Communication table so that you can easily identify them and create individual warning letters.

<i>Field or Control</i>	<i>Description</i>
Academic Institution	Select an academic institution for which to evaluate students.
Term	Select a term for the system to use as it searches for student enrollment records. Term values are defined on the Term Table page.
Academic Organization	Select an academic organization for the system to use as it searches for records. Academic organization values are defined on the Academic Organization Table page.
Session	Select a session for the system to use as it searches for records. Session values are defined on the Session Table page.
Class End Date From and Class End Date To	Select the class end date from and to values. The values in these fields further narrow your processing parameters. The system evaluates enrollment records for classes that are active between these dates and within all other parameters you specify.
Campus	Select a campus for the system to use as it searches for records. Campus values are defined on the Campus Table page.

Field or Control	Description
Grading Scheme	Select a grading scheme to prompt for appropriate grades in the Grade Input field. Grading scheme values are defined on the Grading Scheme Table page.
Grade Input	Select the grade that the system should seek to identify whether a student is midterm deficient.

Click **Run** to run the report using PeopleSoft Process Scheduler. The process populates the Communication table with IDs for students with deficient grades. Later, you can produce a letter to inform them of their status.

Generating Midterm Deficiency Letters

Complete these steps to generate midterm deficiency letters:

1. Set up midterm deficiency keys on the Communication Speed Keys page.

After you set these parameters, you do not have to set them each time you run the report. Select the Administrative Function of *STRM*, which is a delivered value. When defining your communication speed key for midterm deficiency reports, select the method of *letter*; the direction of *out*, and the letter code of *MAD* (Midterm Academic Deficiency).

2. Generate midterm deficiency reports on the Mid-Term Deficiency page.

In addition to generating a report of midterm deficiencies, the report places students with deficiencies into the Communication table so that you can generate a letter informing them of their deficient grades.

The Mid-Term Deficiency report creates one midterm deficiency communication record per student who fits the criteria for having deficiencies. After you run letter generation for letter code *MAD*, the system inserts a row in the corresponding comma delimited (.CSV) extract file for each deficient class for the term. Using Microsoft Word Merge, the system creates a single letter for a student with midterm deficient grades. The letter includes up to 10 classes in which the student is deficient.

If you run the Mid-Term Deficiency report and letter generation again at a later date, Microsoft Word Merge produces student letters that include all previously deficient classes for the term, as well as any newly selected deficient classes.

3. Generate letters on the Letter Generation - General Parameters page.

To generate midterm deficiency report letters, select the letter code of *MAD*.

Running the Grade Lapse Process

This section provides an overview of the grade lapse process and discusses how to:

- Define grade lapse rules.

- Run the grade lapse process.
- View the lapse report results online.

Understanding the Grade Lapse Process

Use the Grade Lapse process to convert posted *In-progress* or *Incomplete* grades to some other grade that you specify. You can define grades as *In-progress* on the Grade Scheme table.

Typically, you run the Grade Lapse process two to three weeks after all grades are entered and posted. Your lapse deadline can be before the processing date.

Complete these steps to run the Grade Lapse process:

1. Define grade lapse rules for your academic programs on the Incomplete page.
2. Enter and post grades for a given time period.
3. Run the Grade Lapse process on the Grade Lapse page.
4. View new, lapsed grades on the Incomplete page.

After you set up your grade lapse rules, you can run the Grade Lapse process at any time. The Grade Lapse process uses the lapse grade that you indicate to populate the Student Incomplete page. Later, you can post the new grade.

Pages Used to Run the Grade Lapse Process

Page Name	Definition Name	Navigation	Usage
Repeat/Incomplete	INCOMPLETE_GRADE	Set Up SACR > Foundation Tables > Academic Structure > Academic Program Table > Repeat/Incomplete	Define grade lapse rules for academic programs. Each rule defines the grade that your incomplete grades lapse to when you run the report and what related transcript notes (if any) appear on a student's transcript.
Grade Lapse	RUNCTL_SR_GRD_LPS	Curriculum Management > Grading > Grade Lapse > Grade Lapse	Enter processing parameters for the Grade Lapse process and to run the process.
Student Incomplete	STDNT_INCOMPLETE	Records and Enrollment > Student Term Information > Student Incomplete > Student Incomplete	Review the Grade Lapse process results for an individual student.

Defining Grade Lapse Rules

Access the Repeat/Incomplete page (**Set Up SACR > Foundation Tables > Academic Structure > Academic Program Table > Repeat/Incomplete**).

This example illustrates the fields and controls on the Repeat/Incomplete page. You can find definitions for the fields and controls later on this page.

Academic Program		Standing/Honors		Taxonomy/Campus		Repeat/Incomplete		Enrollment	
Academic Institution:		PSUNV PeopleSoft University							
Academic Program:		LAU Liberal Arts Undergraduate							
Find View All First 1 of 1 Last									
Effective Date:		01/01/1900			Status:		Active		
Repeat Rule									
Repeat Rule:		<input type="text"/>							
Process on Enrollment:		Yes		<input type="checkbox"/>		Temporarily Suspend Repeat Check on Enrollment			
Repeat Grade Check:		Never		<input type="checkbox"/>		Temporarily Suspend Repeat Check on Grade Input			
Course Catalog Repeats									
*Course Catalog Repeat Message:		None							
Incomplete Grade									
Incomplete Grade:		<input type="text"/>		Incomplete		<input checked="" type="checkbox"/> Lapse Grade			
Lapse To Grade:		<input type="text"/>		Fail					
Lapse Days:		<input type="text"/>							
Lapse Transcript Note ID:		<input type="text"/>							
Completed Transcript Note ID:		IREM		Incomplete Removed		<input type="checkbox"/> Print Completed Date			

<i>Field or Control</i>	<i>Description</i>
Incomplete Grade	Enter a value that you define as an incomplete grade for students who are active in this program. This grade lapses to the value in the Lapse To Grade field as a result of the Grade Lapse process <i>only</i> if you select the Lapse Grade check box. If you neither select the Lapse Grade check box nor enter a Lapse To Grade value, then the system never lapses the incomplete grade. Grade values are defined on the Grading Scheme Table page.

Field or Control	Description
Lapse Grade	Select to use the lapse grade rules for this incomplete grade. Some incomplete grades may not have lapse rules attached to them (in which case you would leave the Lapse To Grade field blank.) If you do not select this check box, the system does not change incomplete grades to any lapse grade value for classes taken in this academic program, and the lapse transcript note ID does not appear.
Lapse To Grade	Select the lapse to grade value. Grade values are defined on the Grading Scheme Table page.
Lapse Days	<p>Enter the number of days past the fully-graded date that an incomplete grade can stay on a student's record. This value is provided by default from the Term Calendar 3 page to the student career term record during term activation. Lapse days function as a grace period.</p> <p>For example, assume that at PSUNV the fully-graded date for the undergraduate academic career (<i>UGRD</i>), term 0330, regular session (1) is 12/01/01.</p> <p>If the institutional policy at PSUNV for the LAU academic program allows a student to make up incomplete grades for one month past the term's end, you would enter <i>30</i> in the Lapse Days field. When you run the Grade Lapse process, use 1/10/02 as the lapse deadline. This way, you can be sure that all students who might make up an incomplete have done so and that the grades have been entered and posted. The additional 10 days provide you with time to post grades.</p> <hr/> <p>Note: Run the grade lapse report after all grades are entered and posted, which can be after your lapse day's deadline.</p> <hr/>
Lapse Transcript Note ID	Select the transcript note ID for the lapse grade. Transcript note IDs are defined on the Transcript Note Table page.
Print Lapse Date	Select to display the lapse date on the student's transcript. The system uses the lapse days value to generate the lapse date. It does <i>not</i> use the lapse process date.
Completed Transcript Note ID	Select the transcript note ID that appears after the student's final grade is posted. Transcript note IDs are defined on the Transcript Note Table page.
Print Completed Date	Select to display the completed date on the student's transcript.

Related Links

“Defining Academic Programs” (Campus Solutions Application Fundamentals)

Running the Grade Lapse Process

Access the Grade Lapse page (**Curriculum Management > Grading > Grade Lapse > Grade Lapse**).

The Grade Lapse process converts the original *Incomplete* grade to the lapse grade. In addition, the process creates a report that lists all enrollment request numbers for grades that it lapses.

You should run this process two to three weeks *after* all grades are entered and posted. Your lapse deadline should be before the date you run the process.

Field or Control	Description
Institution	Select the institution that the system uses to limit the scope of the process. The selected value defines which careers are valid.
Career	Select the academic career that the system uses to limit the scope of the process. The system evaluates students with enrollment records for this career.
Term	Select the term that the system should use to limit the scope of the process. The system evaluates students with enrollment records for this career and term.
Lapse Deadline	<p>Select the lapse date deadline to specify the date for grades to lapse (change from their original grade to the <i>lapse to grade</i>).</p> <p>The lapse deadline must be greater than or equal to the fully-graded date plus the lapse days. The fully-graded date is set up on the Term Calendar 3 page, and the system populates this value by default to the student career term record during term activation or during the term activation update process. It is the date that the institution expects to have all grades posted for a particular career, term, and session. Lapse days are defined for an academic program and grade on the Incomplete page in the Academic Program Table component.</p> <p>The Grade Lapse process looks at all of the student incomplete records that meet your processing parameters. It then uses the lapse deadline to determine which students have <i>Incomplete</i> grades on their records and converts those students' grades to the lapse grade value that you define on the Incomplete page in the Academic Program Table component.</p> <p>Subsequent processes pick up any new <i>Incomplete</i> grades that you enter. You can run this process as many times as you need for a specific term and career.</p> <hr/> <p>Warning! The Grade Lapse process does not convert <i>Incomplete</i> grades that you enter on the Student Enrollment 1 page. <i>Incomplete</i> grades that you enter on this page do not have a corresponding row in the incomplete table.</p> <hr/>

<i>Field or Control</i>	<i>Description</i>
Academic Program	Because different programs can have different lapse rules, select the academic program that the system uses to limit the scope of the population to process. Academic Program is an optional field.

Click **Run** to run this request. PeopleSoft Process Scheduler runs the Grade Lapse process at user-defined intervals.

Running the PSJob on the server generates the Grade Lapse report and automatically posts the transaction.

Viewing the Lapse Report Results Online

Access the Student Incomplete page (**Records and Enrollment > Student Term Information > Student Incomplete > Student Incomplete**).

<i>Field or Control</i>	<i>Description</i>
Lapse Deadline and Lapse To Grade	The grade post process populates the Lapse Deadline and Lapse To Grade fields. However, you can manually enter these values. If the student has an incomplete grade, you can specify the date for this incomplete grade to lapse to another grade. The process does not overwrite values that you enter manually.
Comment	Enter any comments about the lapse grade. The comments do not appear on the transcript.

Viewing Student Grades and Statistics

When you post grades, the system calculates term statistics. Use the Student Grade Inquiry component to view a student's grades and statistics for the term.

Related Links

[Viewing Term Statistics](#)

Prerequisite

Before you can review term statistics, you must post grades for the term.

Pages Used to View Student Grades and Statistics

<i>Page Name</i>	<i>Definition Name</i>	<i>Navigation</i>	<i>Usage</i>
Student Grade Inquiry	STDNT_GRADE_INQ	Records and Enrollment > Student Term Information > Student Grades > Student Grade Inquiry	Review grades for a student within a term.
Term Statistics	TERM_STATISTICS	Records and Enrollment > Student Term Information > Student Grades > Term Statistics	Review a student's current term statistics.

Auditing Grade Changes

This section provides an overview of grade change audits and discusses how to enter grade change audit search parameters.

Understanding Grade Change Audits

PeopleSoft Campus Solutions provides grade change audit functionality that captures and displays detailed information about grade changes made through online pages, batch processes, and SQL. Specifically, the system tracks and writes an audit record to the grade change audit table for each of these changes:

- Online and self-service changes to the **GRADE_INPUT** field.
- Batch changes to the **GRADE_INPUT** field on the Grade Lapse Process page.
- SQL changes to the **Grade Input** field.

The grade change audit table captures the entire PS_STDNT_ENRL record and stores an image of the record before and after any changes. The system dates and time stamps and also marks each record in the audit table as a before or after image.

Complete these steps to audit grade changes:

1. Enter the parameters that define your audit group on the Grade Change Audit page.
2. Select the **View Changes Only** check box to see only changes to original grades.
Clear the **View Changes Only** check box to see both original grades and subsequent grade changes.
3. Click the **Search** button to retrieve your results.
4. Review the results of your search on the Change Detail, Units and GPA, and Miscellaneous Details tabs.

Prerequisites

To record the grade changes that the Grade Change Audit functionality audits, your IT team must first install and execute delivered SQL trigger files.

Related Links

“Understanding CS-to-HCM Integration” (Campus Solutions Application Fundamentals)

Page Used to Audit Grade Changes

Page Name	Definition Name	Navigation	Usage
Grade Change Audit	GRADE_AUDIT	Curriculum Management > Grading > Grade Change Audit > Grade Change Audit	Specify grade change audit search parameters and review detailed information about grade changes that match the selection criteria.

Entering Grade Change Audit Search Parameters

Access the Grade Change Audit page (**Curriculum Management > Grading > Grade Change Audit > Grade Change Audit**).

Note: Multiple views of this page are available by clicking the tabs in the scroll area. We document fields that are common to all views first.

Field or Control	Description
ID	The ID of the student to audit. Leave this field blank to have the system retrieve all values for this field (wildcard).
User ID	The ID of the user to audit. Leave this field blank to have the system retrieve all values for this field (wildcard).
Start Date	Enter the earliest date to audit. Leave this field blank to have the system retrieve all values for this field (wildcard).
End Date	Enter the latest date to audit. Leave this field blank to have the system retrieve all values for this field (wildcard).
View Changes Only	Select this check box to have the system return only those records with an action of <i>After</i> . Clear this check box to have the system return records with an action of <i>Before</i> and <i>After</i> .

Field or Control	Description
Search	<p>Click to retrieve audit data. To refresh the data that the system returns, update the selection criteria and click the button again.</p> <hr/> <p>Note: After you click the Search button, the retrieval process begins. If the system finds records in the GRADE_AUDIT table within your search criteria, the system refreshes the data on the Change Detail tab. If the process returns no changes, the fields on the Change Detail tab remain blank.</p> <hr/>
User ID	Displays the ID of the individual who made changes to the PS_STDNT_ENRL record.
ID	Displays the ID of the student whose grade changed.
Date/Time	Displays when a user made changes to the PS_STDNT_ENRL record.
Action	<p>Displays the state of the change record. Values are:</p> <p><i>Before:</i> The image of the record before it was updated.</p> <p><i>After:</i> The image of the record after it was updated.</p>

All remaining columns on the Units and GPA tab and the Miscellaneous Detail tab display a subset of columns from the Grade Audit table, which stores a snapshot of the student's record in the PS_STDNT_ENRL table.

Related Links

[Processing Enrollment Transactions Through the Enrollment Component](#)

Graduating Students

Tracking Graduation Progress

This section discusses how to:

- Track individual candidate progress.
- Review graduation status history.
- Update academic program for a group of students.
- Track candidate group progress.

Pages Used to Track Graduation Progress

<i>Page Name</i>	<i>Definition Name</i>	<i>Navigation</i>	<i>Usage</i>
Graduation Tracking	SSR_STDNT_GRAD	Records and Enrollment > Graduation > Graduation Tracking	Determine if a student has completed all the requirements necessary to receive his or her degree.
Graduation Status History	SSR_STDGRD_HIST_SP	Click the View Status History button on the Graduation Tracking page.	View an audit trail of all graduation status changes to a student record.
Graduation Processing	SSR_RUNCTL_GRADRPT	Records and Enrollment > Graduation > Graduation Processing	Manage the degree checkout process for a group of students.
Graduation Tracking Batch	SSR_RUNCTL_GRADTRK	Records and Enrollment > Graduation > Graduation Tracking Batch	Create and update graduation tracking data for a group of students.

Track Individual Candidate Progress

Access the Graduation Tracking page (**Records and Enrollment > Graduation > Graduation Tracking**).

This example illustrates the fields and controls on the Graduation Tracking page: Cumulative Units tab. You can find definitions for the fields and controls later on this page.

Graduation Tracking

Mary Fernwood SRGR0001

Academic Career	Undergraduate	Student Career Nbr	0
Academic Program	Liberal Arts Undergraduate	Institution	PeopleSoft University
Exp. Graduation Term	0730 2014 Fall	Program Status	Active in Program
Degree	BA Bachelor of Arts	User ID	PS Status AC

Graduation Tracking

Graduation Review Status Applied	Last Modified On 20/06/2014 12:06:13PM
Status Date 20/06/2014	Updated By PS

Update Graduation Status View Status History

Academic Plan

Plan Seq	Acad Plan	Description	Acad Plan Type	Acad Subplan	Degree
10	PSYCH	Psychology	Major		Bachelor of Arts

Statistics Personalize | Find | View All | First 1 of 1 Last

Cumulative Units									
Term	Acad Level Projected	Taken for Progress	Passed for Progress	Taken Toward GPA	Passed Toward GPA	Taken Not Toward GPA	Passed Not Toward GPA	In Progress GPA	In Progress Not for GPA
0700	Senior	114.000	99.000	99.000	99.000			15.000	

The sections that appear on this page are configured on the Institution Table page. The Academic Plan group box displays all plans for the student's career/student career number identified at the top of the page. If the student has more than one degree in the career/student career number, all plans appear under each degree.

The information displayed in the statistics section are from the student career term record that is less than or equal to the expected graduation term. The Cumulative Units tab displays a summary of the status of all units taken by the student in a term.

Field or Control	Description
Update Graduation Status	Select this check box to open a new Graduation Review Status field for entry of a new status.
View Status History	Click this button to access the Graduation Status History page.

The **Cumulative GPAs** tab displays all GPAs for a student.

The **Transfer Credit** tab displays posted units for transfer, test and other credit.

The **Class Information** tab displays classes that do not have a grade or have a grade that is set up as an incomplete grade for which the student is enrolled. If a class needs to be tracked during the graduation review process, enter a **Grad Note** on that class. If the class is dropped (after the drop retain date) or once the class is graded, it still appears in this section, due to the **Grad Note**.

Field or Control	Description
Select Display Option	Select <i>Show All</i> to display all enrollments, or select <i>Limited View</i> to display only ungraded ones.

Enter any free-form text" - add this "In the Milestones, Graduation Notes, Honors, Special GPA section of the page, enter any free-form text in the **Comment** field for the graduation reviewer. If the student is eligible for any honors at graduation, enter an **Honors Code**.

Reviewing Graduation Status History

Access the Graduation Status History page (click the **View Status History** button on the Graduation Tracking page).

Updating Academic Program for a Group of Students

Access the Graduation Processing page (**Records and Enrollment > Graduation > Graduation Processing**).

This example illustrates the fields and controls on the Graduation Processing page (1 of 2). You can find definitions for the fields and controls later on this page.

Graduation Processing

Run Control ID: Batch [Report Manager](#) [Process Monitor](#) Run

Academic Institution: ▼

Academic Career: ▼

Population Selection

Population Selection

Selection Tool: [Edit Prompts](#) [Load Selection Results](#)

Query Name: [Launch Query Manager](#) [Preview Selection Results](#)

Selection Results

[Add Students](#) [Clear List](#)

Student ID	Name	Acad Prog	Primary Plan	Degree	Degree Checkout Status	Expected Graduation Term	Degree GPA	Degree Honors 1	Degree Honors 2	Exclude
1										<input type="checkbox"/>

Graduation Process Action

Graduation Process Action: ▼

This example illustrates the fields and controls on the Graduation Processing page (2 of 2). You can find definitions for the fields and controls later on this page.

Program/Degree Update Options	
New Degree Checkout Status	Degree Awarded
Action Reason	Successful Completion
Completion Term	0850 2010 Fall
Program Effective Date	User Date
User Defined Date	02/15/2011
Confer Date Option	User Date
Confer Date	02/15/2011
Update Degree Values	
Degree GPA	No GPA
Degree Honors 1	
Degree Honors 2	
Update Degree Values	
Report Options	
<input type="checkbox"/> Create Transcript Request <input type="checkbox"/> Create Academic Advisement Req	

This page enables you to update academic program information for multiple students; you can either click the **Add Students** link to enter student IDs or create a list using the Population Selection process.

Select the Population Selection option to use flexible methods to load audience data into the system. This group box expands when the **Population Selection** process is selected.

Population selection is a method for selecting the IDs to process for a specific transaction. The Population Selection group box is a standard group box that appears on run control pages when the Population Selection process is available or required for the transaction. Selection tools are available based on the selection tools that your institution selected in the setup of the Population Selection process for the application process and on your user security. Fields in the group box appear based on the selection tool that you select. The fields behave the same way from within the group box on all run control pages and application processes. If your institution uses a specific delivered selection tool (such as PS Query) to identify IDs for a specific transaction, you must use it.

See “Understanding the Population Selection Group Box” (Campus Community Fundamentals)

See “Using the Population Selection Process” (Campus Community Fundamentals)

<i>Field or Control</i>	<i>Description</i>
Load Selection Results	Select this link to populate the Selection Results section with the student list created during the Population Selection process. At this point, you can exclude a student. When you are ready to award the degree, you can update the Degree GPA and the Honors 1 and Honors 2 fields using the Update Degree Values . The fields can also be manually updated.

Field or Control	Description
Graduation Process Action	Select an action: <i>Degree Checkout Status, Expected Graduation Status, Reports Only - Transcripts/AA, or Update All</i> . These are delivered values.
New Degree Checkout Status	Select a status to be applied to the IDs: <i>Applied for Graduation, Approved, Denied, Needs to Finish Pending Work, Program in Review, Review in Progress, Withdrawn, Degree Awarded, and Eligible for Graduation</i> . When the degree checkout status is <i>Degree Awarded</i> , the <i>Action Reason, Completion Term, Program Effective Date, and Confer Date Option</i> fields become available. For all other degree checkout status values, the <i>Action Reason, New Expected Grad Term, and Expected Grad Term Option</i> fields become available.
Program Effective Date, Confer Date Option	Values for these fields are: <i>Confer Dt (Confer Date), Today, or User Date</i> . The <i>Confer Dt</i> is the date defined in the Academic Calendar.
Create Transcript Request	Select this check box to create transcript requests for the population defined. You must also select the transcript type.
Create Academic Advisement Req	Select this check box to create an academic advisement report for the population selected. You must also select a report identifier, report date, as of date and advisement report type.

When you click the **Run** button, the system takes the student group created using Population Selection and inserts a new row into the Academic Program table for each student; depending on the degree checkout status, either a new data row is inserted or a completion row (Degree Awarded) and the action reason selected on this page.

Tracking Candidate Group Progress

Access the Graduation Tracking Batch page (**Records and Enrollment > Graduation > Graduation Tracking Batch**).

Use the Population Selection process to create a graduation tracking row for a student or update an existing row. **Graduation Review Status** values are defined by your institution.

To add graduation review notes to students' graduation tracking, select a Graduation Review Note and a text note.

Posting Degrees

The process of posting degrees requires that you update student program records and, if necessary, report and audit degree changes. This section provides an overview of the degree posting process, lists prerequisites, and discusses how to:

- Complete the student's program.
- Verify and update student degree data.
- View and modify degree data.
- View and modify degree honors data.
- View and modify degree plan data.
- View and modify degree subplan data.

Understanding the Degree Posting Process

To post a degree:

1. Insert a new row and enter a program action of *Completion of Program* on the Student Program page.

This sets the **Degree Checkout Stat** (degree checkout status) field on the Student Degrees page to *Approved*.

2. (Optional) On the Student Degrees page, verify the completion term, specify degree honors, and enter a degree grade point average (GPA).

3. Click the **Update Degrees** button on the Student Program page to post the degree.

This sets the **Degree Checkout Stat** field to *Awarded*.

4. (Optional) When the process finishes, you can view and edit posted degrees through the Student Degrees component.

- a. View and modify degree honors information on the Degree Honors page.
- b. View and modify degree plan information on the Degree Plan page.
- c. View and modify subplan information on the Degree Sub-Plan page.

5. (Optional) Use the Degree Change Audit component to audit any degree status changes.

See [Auditing Degree Changes](#).

Prerequisites

Before you can post a student's degree, you must:

- Define degrees and degree honors.

- Assign degrees to academic plans.
- Matriculate the student, or confirm that the student has a history of matriculation.

Pages Used to Post Degrees

Page Name	Definition Name	Navigation	Usage
Student Program	STDNT_PROG	Records and Enrollment > Career and Program Information > Student Program/Plan > Student Program	Insert a new row and update the Program Action field value to a status of <i>Completion of Program</i> .
Student Degrees	STDNT_DEGR	Records and Enrollment > Career and Program Information > Student Program/Plan > Student Degrees	Verify and update a student's completion term, degree honors, degree GPA, and degree checkout status.
Degree	ACAD_DEGREE	Records and Enrollment > Graduation > Student Degrees > Degree	View and modify posted degree data.
Degree Honors	ACAD_DEGREE_HONORS	Records and Enrollment > Graduation > Student Degrees > Degree Honors	View and modify degree honors information, which is particularly useful when you want to award more than two honors code values to a student (there is a limit of two honors codes on the Student Degrees page).
Degree Plan	ACAD_DEGREE_PLAN	Records and Enrollment > Graduation > Student Degrees > Degree Plan	View and modify degree plan information.
Degree Sub-Plan	ACAD_DEGREE_SUBPLN	Records and Enrollment > Graduation > Student Degrees > Degree Sub-Plan	View and modify subplan information.

Completing the Student's Program

Access the Student Program page (**Records and Enrollment > Career and Program Information > Student Program/Plan > Student Program**).

Field or Control	Description
Program Action	<p>Insert a new row in this field, and select a value of <i>Completion of Program</i>.</p> <hr/> <p>Note: If you must revoke a degree after it has been awarded, insert a row and enter a program action of <i>Revoke Degree</i>. The system automatically updates the degree tables.</p> <hr/>

Related Links

[Pages Used to Manage Student Program Stacks](#)

Verifying and Updating Student Degree Data

Access the Student Degrees page (**Records and Enrollment > Career and Program Information > Student Program/Plan > Student Degrees**).

Field or Control	Description
Degree Checkout Stat (degree checkout status)	<p>Throughout a student's degree history, you can progressively update the values in this field. Values are: <i>Applied, Approved, Awarded, Denied, In review, Pending, and Withdrawn</i>.</p> <p>When you select the status of <i>Completion of Program</i> in the Program Action field on the Student Program page, the system populates the Degree Checkout Stat field here to <i>Approved</i>; you cannot modify this value. The system changes this status from <i>Approved</i> to <i>Awarded</i> when you click the Update Degrees button. When you click this button, all fields on this page become unavailable. You must complete future edits on the Degree page, or you can revoke the degree altogether by inserting a new row in the Program Action field on the Student Program page and selecting a value of <i>Revoke Degree</i>.</p>
Completion Term	Enter the term in which the degree is awarded.
Degree Honors 1 and Degree Honors 2	If applicable, select a value from the list of values that you defined on the Degree Honors Table page.
Degree GPA (degree grade point average)	<p>Enter the degree GPA. When you click the Update Degrees button, the GPA and degree honors are stored on the student's degree records.</p> <p>Although the system does not calculate this value, you can create an academic advising report to assist you with calculating the value.</p>

Viewing and Modifying Degree Data

Access the Degree page (**Records and Enrollment > Graduation > Student Degrees > Degree**).

<i>Field or Control</i>	<i>Description</i>
Degree Number	The system generates the degree number, which is unique for each degree that you assign to a student.
Degree and Institution	These values appear by default from the Student Degrees page. You cannot override these values after degree posting is complete. The degree appears on the transcript if you specify a <i>Local Degrees</i> print area on the Transcript Type - Degrees/Program page.
Primary Career, Completion Term, Confer Date, Degree Status and Degree GPA	These values appear by default from the Student Degree page. The Confer Date defaults to the Confer Date for student's completion term. You can override the values.
Degree Status Date	This date appears by default from the effective date for the <i>Completion</i> row on the Student Program page.
Prefix and Suffix	Select from those prefixes and suffixes that you defined on the Degree Honors Table page. Only those honors with a type of <i>Degree Prefix</i> and <i>Degree Suffix</i> , respectively, are available. The prefix and suffix appears with the degree description on the transcript if you specify a <i>Local Degrees</i> print area on the Transcript Type - Degrees/Program page.
Class Rank and Of	Enter class rank values for the student's degree. The class rank information appears with the degree description on the transcript if you specify a <i>Local Degrees</i> print area and select the Print Degree Rank check box on the Transcript Type - Degrees/Program page.

Viewing and Modifying Degree Honors Data

Access the Degree Honors page (**Records and Enrollment > Graduation > Student Degrees > Degree Honors**).

<i>Field or Control</i>	<i>Description</i>
Honors Number	The system generates the honors number and uses this value for sequencing honors on the transcript.
Honors Code	If available, this value appears by default from the Student Degrees page. Add rows to select additional honors for the degree. Honors values are defined on the Degree Honors Table page.

Field or Control	Description
Award Date	This value appears by default from the Confer Date field on the Degree page. See “Setting Up Term Landmark Dates” (Campus Solutions Application Fundamentals).
Print on Diploma	No programming is tied to this check box.
Print on Transcript	Select this check box to display the honors value on the student's transcript. For the degree honors information to appear on the transcript, you must also specify a <i>Local Degrees</i> print area and select the Print Degree Honors check box on the Transcript Type- Degrees/Program page.

Warning! Changes to this page do not post to a student's record. You must post honors to the student's record by running the posting process using the Academic Standing/Honors and Awards page. When you run the process, select the **Calculate Honors & Awards** check box to calculate honors and awards.

Viewing and Modifying Degree Plan Data

Access the Degree Plan page (**Records and Enrollment > Graduation > Student Degrees > Degree Plan**).

Field or Control	Description
Plan Seq (plan sequence)	This value defines the primacy of the plan within the program.
Career	The career to which the degree is assigned.
Career Nbr (career number)	The specific career number to which the degree is assigned. The system increments this number for each active program in the same career.
Acad Plan (academic plan)	The academic plan to which the degree is assigned.
Degr Stat (degree status)	The status of the degree: <i>Awarded</i> and <i>Revoked</i> . You can override the degree status. Values for this field are delivered with your system as translate values. Do not modify these values in any way. Any modifications to these values require a substantial programming effort.
Degr Dt (degree date)	The effective date from the Student Program page, where the program action is <i>Completion of Program</i> .
Plan Type	The type of plan, as defined on the Academic Plan Table page.

Field or Control	Description
Override	Select this check box to revise the transcript description and the diploma description.
Transcript Description	The description of the plan degree to appear on the transcript. The plan transcript description appears on transcripts where you specify a <i>Local Degrees</i> print area on the Transcript Type - Degrees/Program page.
Diploma Description	No programming is tied to this field.
Honors Prefix	Specify an honors prefix for this plan degree, if any. Honors prefix values are defined with a type of <i>Degree Plan Prefix</i> on the Degree Honors Table page. The plan honors prefix appears next to the plan degree on transcripts where you specify a <i>Local Degrees</i> print area on the Transcript Type - Degrees/Program page.
Honors Suffix	Specify an honors suffix for this plan degree, if any. Honors suffix values are defined with a type of <i>Degree Plan Suffix</i> on the Degree Honors Table page. The plan honors suffix appears next to the plan degree on transcripts where you specify a <i>Local Degrees</i> print area on the Transcript Type - Degrees/Program page.
Plan GPA (plan grade point average)	The system does not calculate the plan GPA value, although you can create an academic advising report to assist you with the calculation. The plan GPA appears with the plan degree on transcripts where you specify a <i>Local Degrees</i> print area and select the Print Degree Plan GPA check box on the Transcript Type - Degrees/Program page.
Plan Rank and Of	Enter plan rank values for the student's plan. The plan rank information appears with the plan degree description on the transcript if you specify a <i>Local Degrees</i> print area and select the Print Degree Plan Rank check box on the Transcript Type - Degrees/Program page.

Viewing and Modifying Degree Subplan Data

Access the Degree Sub-Plan page (**Records and Enrollment > Graduation > Student Degrees > Degree Sub-Plan**).

Field or Control	Description
Academic Sub-Plan	The academic subplan associated with the plan degree.

Field or Control	Description
Sub-Plan Seq (subplan sequence)	The sequence number for the subplan. This value defines the primacy of the subplan within the plan.
Override	Select this check box to revise the transcript description and the diploma description.
Transcript Description	The subplan transcript description appears on transcripts where you specify a <i>Local Degrees</i> print area and select the Print Degree Sub-Plan check box on the Transcript Type - Degrees/Program page.
Diploma Description	No programming is tied to this field.
Honors Prefix	Specify an honors prefix for this subplan degree, if any. Honors prefix values are defined with a type of <i>Degree Sub-Plan Prefix</i> on the Degree Honors Table page. The subplan honors prefix appears next to the subplan degree on transcripts where you specify a <i>Local Degrees</i> print area and select the Print Sub-Plan check box on the Transcript Type - Degrees/Program page.
Honors Suffix	Specify an honors prefix for this subplan degree, if any. Honors suffix values are defined with a type of <i>Degree Sub-Plan Suffix</i> on the Degree Honors Table page. The subplan honors suffix appears next to the subplan degree on transcripts where you specify a <i>Local Degrees</i> print area and select the Print Sub-Plan check box on the Transcript Type - Degrees/Program page.

Automating Graduation Processing and Reporting

The Graduation Processing and Reporting feature, which is run through the Graduation Reporting component, facilitates the degree checkout process. The feature works as a part of core functionality, and it works as an integrated complement to the PeopleSoft Campus Self Service application (through which students can use self-service pages to apply for graduation).

Using the Graduation Processing and Reporting feature, you can dynamically define a student population, and for this population you can:

- Update degree checkout status values (from a valid status that you specify to another status that you specify).
- Create requests for transcripts, degree audits, and special advisement reports.
- Generate a graduation report.

This section provides an overview of the graduation reporting process, lists prerequisites, and discusses how to:

- Enter graduation report parameters.
- Retrieve the student population.

Understanding the Graduation Reporting Process

To run the graduation reporting process:

1. Select the **Student Population** check box, and enter your student population selection criteria on the Graduation Reporting page.
2. Click the **Run** button to run the Graduation Reporting process.
3. Click the **Fetch** button on the Selection Results page in order to populate the page with your resultant student population.
4. Delete rows to remove students that you do not want to process.

Insert rows to add students that did not match your parameters, but whom you want to process.

5. Navigate to the Graduation Reporting page and clear the **Student Population** check box.
6. Select the run option check boxes and their respective data.

For example, select the **Update Program and Degrees** check box, and provide the information required in the Program/Degree Update Options group box, including the new degree checkout status, completion term, and program effective date.

7. Click the **Run** button and run the Graduation Reporting process.

If you run a report, you should use a type of *Web* and a format of *PDF*.

8. After the process finishes, you can do the following:
 - a. Navigate to the Transcript Generation page to generate transcripts (use the transcript request number on the Graduation Reporting page).
 - b. Navigate to the Student Degrees page or the Degrees page to view updated degree checkout status values.
 - c. Review the Graduation report.

Prerequisites

If you plan to create transcript requests, you must first define transcript types in the Define Transcript Type component.

Related Links

[Defining Transcript Types](#)

Pages Used to Automate Graduation Processing and Reporting

<i>Page Name</i>	<i>Definition Name</i>	<i>Navigation</i>	<i>Usage</i>
Graduation Report	RUNCTL_GRAD_RPT	Records and Enrollment > Graduation > Graduation Report > Graduation Report	<p>Enter graduation report parameters: define a population of students for which you can update degree checkout status values, create transcript requests, and generate graduation reports.</p> <p>For example, when a student applies for graduation through the self-service Apply for Graduation feature, the system sets that student's degree checkout status to <i>Applied</i>. You can use the Graduation Reporting component to set all students with a status of <i>Applied</i> to <i>In Review</i>.</p>
Selection Results	RUNCTL_GRAD_RPT2	Records and Enrollment > Graduation > Graduation Report > Selection Results	Retrieve the results of your population query, add or delete students, and edit the degree GPA and degree honors for each student.

Entering Graduation Report Parameters

Access the Graduation Report page (**Records and Enrollment > Graduation > Graduation Report > Graduation Report**).

Run Options

<i>Field or Control</i>	<i>Description</i>
Select Population	<p>The first step to using the Graduation Reporting component is entering selection criteria and fetching a student population. Select this check box to enable the fields that define your student population in the Selection Criteria group box. After you enter all of your parameters, click the Run button to run the Graduation Reporting process. View your student population on the Selection Results page, where you can add or delete students.</p> <hr/> <p>Note: The process does not select students with a current program action of Admission Revocation, Defer Enrollment, Discontinuation, Suspension, or Administrative Withdrawal.</p>

Field or Control	Description
Update Programs and Degrees	<p>After you enter your selection criteria and fetch your population, select this check box to enable the fields in the Program/Degrees Update Options group box and enter your update data.</p> <p>After you specify your update data, click the Run button to run the Graduation Reporting process to update program and degree information for the students in your population. Specifically, this process updates for all students in your population the student career term records with the values from:</p> <ul style="list-style-type: none"> • The Program/Degree Update Options group box on this page. • The Degree GPA and Degree Honors fields on the Selection Results page.
Create Transcript Request	<p>After you enter your selection criteria and fetch your population, select this check box to enable the fields in the Transcript Request Options group box and to enter your transcript type data. After you specify your data, run the Graduation Reporting process to create a batch transcript request for the students in your population. Next, generate the transcripts on the Transcript Generation page.</p>
Generate Report	<p>After you enter your selection criteria and fetch your population, select this check box and run the process to create a report that highlights all of the graduation data for the students in your population.</p>

Selection Criteria

Field or Control	Description
Academic Institution	The academic institution of the students you want to fetch.
Academic Career	The academic career of the students you want to fetch.
Degree Checkout Status	The current degree checkout status of the students to fetch: <i>Applied, Approved, Denied, In Review, Pending, or Withdrawn.</i>

Field or Control	Description
Academic Program 1, Academic Program 2, and Academic Program 3	You can enter up to three academic programs within the career you specify to identify the students you want to fetch. If any fields are left blank, the system fetches all students in the career you specify.
Expected Graduation Term	The expected graduation term of the students to fetch. The system verifies this value against the value in the Expected Grad Term (expected graduation term) field on the Student Program page. This field is optional.

Program/Degree Update Options

Field or Control	Description
New Degree Checkout Status	<p>When you select the Update Programs and Degrees check box, the New Degree Checkout Status field becomes available.</p> <p>Specify the degree checkout status that you want to assign to all students in your population: <i>Approved, Awarded, Denied, In review, Pending, or Withdrawn</i>. For a new checkout status of <i>Awarded</i>, the system inserts a new effective-dated row on the Student Program page with a program action of <i>Completion of Program</i>. For all other checkout status values, the system inserts a new effective-dated row on the Student Program page with a program action of <i>Data Change</i>. The system does not specify a program action reason.</p>
Completion Term	When you select a New Degree Checkout Status field value of <i>Awarded</i> , you must specify the completion term that you want the system to assign to students in your population.

Field or Control	Description
Program Effective Date	<p>The field becomes available when you select the New Degree Checkout Status field value of <i>Awarded</i>. Select the value that you want assigned as the effective date for the student's academic program upon awarding the student's degree (that is, upon setting the program action to <i>Completed</i> and the Degree Checkout Status to <i>Awarded</i>.)</p> <p>Values are:</p> <p><i>Confer Date</i>: Select to use the confer date (defined on the academic calendar) as the student's program completion effective date.</p> <p>If, however, the confer date is prior to the current program effective date, the process assigns today's date as the program effective date, not the confer date. For example, the student applied for graduation on September 1, 2009 and you are trying to confer the degree for a prior term (such as Spring 2009); the process then assigns today's date (the system date) as the student's academic program effective date.</p> <p><i>Today's Date</i>: This is the default value whereby the process assigns today's date (the system date) as the program effective date. If the current program effective date is also today's date, then the process assigns a new effective sequence number with today's date. For example, if the student applies for graduation today, and you run the process to award the degree with today's date, the program effective date remains today's date and the process inserts an incremental effective sequence with the number of "2."</p> <p><i>User Defined</i>: Select this value if you want to define the date that should be used as the program effective date. Then select a date in the User Defined Date field.</p>
User Defined Date	<p>If you select the Program Effective Date field value of <i>User Defined</i>, select a date.</p> <hr/> <p>Note: If the user-defined date is prior to the current program effective date, the process assigns today's date as the program effective date, not the user-defined date.</p> <hr/>

Transcript Request Options

Elements in this group box are available when you select the **Create Transcript Request** check box.

Field or Control	Description
Transcript Request Nbr (transcript request number)	The system generates and displays the number of your transcript request after you specify your transcript options and run the Graduation Reporting process. Use this number to generate transcripts on the Transcript Generation page.
Transcript Type	Specify the type of transcript to create for all students in your population.
Transcript default as of date	When you select a transcript type that is also an advising report (special or standard), this field becomes available. A value appears by default from the Transcript Default Date field on the Installation Student Administration page. You can override it.
Database Report	When you select a transcript type that is also an advising report (special or standard), this check box becomes available. Select this check box to create a transcript request where the results of the advising report populate the analysis database tables.

Related Links

“Understanding the Analysis Database” (Academic Advisement)

Retrieving the Student Population

Access the Selection Results page (**Records and Enrollment > Graduation > Graduation Report > Selection Results**).

Field or Control	Description
Fetch	Click to populate the page with your student population. If no students appear, either no students match your selection criteria, or you did not run the Graduation Reporting process.
Add a Student	Click to access the Add Student page where you can search for other student IDs within the career that you have specified. Only students that are active in their program are available.
Student ID	The ID of the student in the population.
Name	The name of the student in the population.

Field or Control	Description
Academic Program	The academic program of the student in the population. If a student is active in more than one program in the career you specify, the selection returns all instances. You can delete program instances as necessary.
Primary Academic Plan	The primary academic plan of the student.
Degree	The degree that is associated with the program and primary plan of the student.
Degree Checkout Status	The student's degree checkout status prior to the update degree checkout status process. The system reads this value from the Student Degrees page.
New Degree Checkout Status	The student's degree checkout status of the student after the update degree checkout status process. The system reads this value from the Student Degrees page.
Degree GPA (degree grade point average)	Enter a degree GPA on one of three pages: the Selection Results page (prior to program completion/degree checkout status of <i>Awarded</i>), the Student Degrees page (prior to program completion or degree checkout status of <i>Awarded</i>), or the Degrees page (after program completion).
Degree Honors 1 and Degree Honors 2	The student's degree honors for this degree. The values appears from the Student Degrees page. Enter degree honors on one of three pages: the Selection Results page (prior to program completion/degree checkout status of <i>Awarded</i>), the Student Degrees page (prior to program completion/degree checkout status of <i>Awarded</i>), or the Degrees page (after program completion).

Auditing Degree Changes

This section provides an overview of degree change audits, lists prerequisites, and discusses how to:

- Enter degree change audit search parameters.
- View degree change audit results.
- View degree honors change audit results.
- View degree plan change audit results.
- View degree subplan change audit results.

Understanding Degree Change Audits

Degrees are among the most sensitive data within the Student Records application. As such, Campus Solutions offers Degree Change Audit functionality that captures and displays detailed information about student degree postings or changes to postings. Changes include online changes to the Student Degrees page that occur when you click the **Update Degrees** button on the Student Degrees page and changes to any of the pages in the Student Degrees component. Inserts, updates, or deletions on these pages cause the system to write an audit record to the degree change audit table. The degree change audit table captures the entire record for ACAD_DEGR, ACAD_DEGR_HONS, ACAD_DEGR_PLAN, and ACAD_DEGR_SPLN, storing an image of each record before and after any change. The system date/time stamps and marks each record in the audit table as an "insert" or "delete," or as a "before" or "after" in the case of updates.

Use the Degree Change Audit component to search your database for details about degree changes. An option on the Search Criteria page enables you to filter out the "before" image.

Prerequisites

To record the degree changes that the Degree Change Audit functionality audits, your IT team must first install and execute delivered SQL trigger files.

To view degree changes, you must first click the **Search** button on the Search Criteria page.

Related Links

“Understanding CS-to-HCM Integration” (Campus Solutions Application Fundamentals)

Pages Used to Audit Degree Changes

<i>Page Name</i>	<i>Definition Name</i>	<i>Navigation</i>	<i>Usage</i>
Degree Change Audit - Search Criteria	DEGREE_AUDIT	Records and Enrollment > Graduation > Degree Change Audit > Search Criteria	Define your degree change audit search parameters. All of the fields on this page are optional.
Degree	AUD_ACAD_DEGR	Records and Enrollment > Graduation > Degree Change Audit > Degree	Review detailed information about degree changes that match the selection criteria specified on the Search Criteria page. The elements on this page are the same as those found on the Degree page.
Degree Honors	AUD_ACAD_DEGR_H	Records and Enrollment > Graduation > Degree Change Audit > Degree Honors	Review detailed information about changes to degree honors that match the selection criteria specified on the Search Criteria page.

Page Name	Definition Name	Navigation	Usage
Degree Plan	AUD_ACAD_DEGR_P	Records and Enrollment > Graduation > Degree Change Audit > Degree Plan	Review detailed information about degree plan changes that match the selection criteria specified on the Search Criteria page.
Degree Subplan	AUD_ACAD_DEGR_S	Records and Enrollment > Graduation > Degree Change Audit > Degree Subplan	Review detailed information about degree subplan changes that match the selection criteria specified on the Search Criteria page. The elements of all four tabs on this page are the same as those found on the Degree Sub-Plan page.

Entering Degree Change Audit Search Parameters

Access the Degree Change Audit - Search Criteria page (**Records and Enrollment > Graduation > Degree Change Audit > Search Criteria**).

Field or Control	Description
ID	The ID for the student who you want to audit. Leave this field blank to have the system retrieve all values for this field (wild card).
User ID	The ID for the user who you want to audit. Leave this field blank to have the system retrieve all values for this field (wild card).
Start Date	The earliest date to audit. Leave this field blank to have the system retrieve all values for this field (wild card).
End Date	The latest date to audit. Leave this field blank to have the system retrieve all values for this field (wild card).
View Changes Only	If cleared, the system returns all records with an action of <i>Insert</i> , <i>Before</i> , <i>After</i> , or <i>Delete</i> . If selected, the system does not return records with an action of <i>Before</i> and returns only records with an action of <i>Insert</i> , <i>After</i> , or <i>Delete</i> .
Search	After you enter your search parameters, click this button to return audit data to the Degree page. To change the data that the system returns, update the selection criteria and search for data again.

Note: When you click the **Search** button, the retrieval process begins. If the system finds changes to any of the records within your search criteria, the system automatically takes you to the first page where changes exist. If no changes are found, the system remains on the Search Criteria page.

Viewing Degree Change Audit Results

Access the Degree page (**Records and Enrollment > Graduation > Degree Change Audit > Degree**).

Note: Multiple views of this page are available by clicking the tabs in the scroll area. We document fields common to all views first.

Field or Control	Description
User ID	The ID of the individual who made changes to the ACAD_DEGR record. For rows where the action is <i>Delete</i> , no user ID appears. This is because when a record is deleted from the database, although the trigger can track that the record has been deleted, it cannot track the user ID of the person who deleted it. When deletes occur, the character string "*****" appears in the User ID field.
Date/Time	When changes to the ACAD_DEGR record were made.
Action	<p>Action types include the following:</p> <p><i>Insert:</i> User inserted a new row (a row was added to the database).</p> <p><i>Delete:</i> User deleted a row out of the database. For rows where the action is <i>Delete</i>, no user ID appears. This is because when a record is deleted from the database, although the trigger can track that the record has been deleted, it cannot track the user ID of the person who deleted it. When deletes occur, the character string "*****" appears in the User ID field.</p> <p><i>Before:</i> Image of the record before it was updated.</p> <p><i>After:</i> Image of the record after it was updated.</p>
ID	The ID of the student whose degree was changed.
Degree Nbr (degree number)	Students can have more than one degree, and each degree is assigned a degree number.
Degree	The student's degree.
Institution	The academic institution associated with the degree.

Completion Info Tab

Select the Completion Info tab.

Field or Control	Description
Career	The career under which the student earns the degree.
Completion Term	The completion term of the degree.
Confer Date	The date the degree was conferred. This is the date when the degree is official.
Degr Stat (degree status)	The status of the degree. Choices are <i>A</i> (active) and <i>R</i> (revoked).
Degr Dt (degree date)	The date the degree is updated to a status of awarded or revoked. This date may differ from the actual confer date.

Honors/Rank Tab

Select the Honors/Rank tab.

Field or Control	Description
Hon Prefix (honors prefix)	The degree honors prefix for the degree.
Hon Suffix (honors suffix)	The degree honors suffix for the degree.
Degree GPA (degree grade point average)	The degree grade point average.
Class Rank Of	The student's class rank and class size.

Related Links

[Verifying and Updating Student Degree Data](#)

Viewing Degree Honors Change Audit Results

Access the Degree Honors page (**Records and Enrollment > Graduation > Degree Change Audit > Degree Honors**).

Note: Multiple views of this page are available by clicking the tabs in the scroll area. We document fields common to all views first.

Field or Control	Description
User ID	The ID of the individual who made changes to the ACAD_DEGR_HONS record. For rows where the action is <i>Delete</i> , no user ID appears. This is because when a record is deleted from the database, although the trigger can track that the record has been deleted, it cannot track the user ID of the person who deleted it. When deletes occur, the character string "*****" appears in the User ID field.
Date/Time	When changes to the ACAD_DEGR_HONS record were made.
Action	<p>Action types include the following:</p> <p><i>Insert</i>: User inserted a new row (a row was added to the database).</p> <p><i>Delete</i>: User deleted a row out of the database. For rows where the action is <i>Delete</i>, no user ID appears. This is because when a record is deleted from the database, although the trigger can track that the record has been deleted, it cannot track the user ID of the person who deleted it. When deletes occur, the character string "*****" appears in the User ID field.</p> <p><i>Before</i>: Image of the record before it was updated.</p> <p><i>After</i>: Image of the record after it was updated.</p>
ID	The ID of the student whose degree was changed.
Degree Nbr (degree number)	Students can have more than one degree, and each degree is assigned a degree number.

Honors Info Tab

Select the Honors Info tab.

Field or Control	Description
Honors Nbr (honors number)	Students can have multiple honors for each degree. Each honors value has a unique number.
Hon Code (honors code)	The honors code associated with the degree.
Award Date	The date the honor was awarded.

Field or Control	Description
Diploma	The setting of the Print on Diploma check box on the Degree Honors page. The check box status values are <i>Y</i> for selected, and <i>N</i> for cleared.
Transcript	The setting of the Print on Transcript check box on the Degree Honors page. The check box status values are <i>Y</i> for selected, and <i>N</i> for cleared.

Viewing Degree Plan Change Audit Results

Access the Degree Plan page (**Records and Enrollment > Graduation > Degree Change Audit > Degree Plan**).

Field or Control	Description
User ID	The user ID of the individual who made changes to the ACAD_DEGR_PLAN record. For rows where the action is <i>Delete</i> , no user ID appears. This is because when a record is deleted from the database, although the trigger can track that the record has been deleted, it cannot track the user ID of the person who deleted it. When deletes occur, the character string "*****" appears in the User ID field.
Date/Time	When changes to the ACAD_DEGR_PLAN record were made.
Action	Action types include the following: <i>Insert</i> : User inserted a new row (a row was added to the database). <i>Delete</i> : User deleted a row out of the database. For rows where the action is <i>Delete</i> , no user ID appears. This is because when a record is deleted from the database, although the trigger can track that the record has been deleted, it cannot track the user ID of the person who deleted it. When deletes occur, the character string "*****" appears in the User ID field. <i>Before</i> : Image of the record before it was updated. <i>After</i> : Image of the record after it was updated.
ID	The ID of the student whose degree was changed.
Degree Nbr (degree number)	Students can have more than one degree, and each degree is assigned a degree number.

Field or Control	Description
Acad Plan (academic plan)	All plans associated with the degree.

Career/Degree Tab

Select the Career/Degree tab.

Field or Control	Description
Career	The career under which the student earns the degree.
Career Nbr (career number)	The number of the career associated with the degree. For students with more than one program in a single career, this number increments from zero.
Degr Stat (degree status)	The status of the degree. Choices are <i>A</i> (active) and <i>R</i> (revoked).
Degr Dt (degree date)	The date the degree is updated to a status of awarded or revoked. This date may differ from the actual confer date.
Override	This represents the setting of the Override check box on the Degree Plan page.

Descriptions Tab

Select the Descriptions tab.

Field or Control	Description
Dipl Descr (diploma description)	The academic plan diploma description, if different from the default.
Trns Descr (transcript description)	The academic plan transcript description, if different from the default.

Honors/Rank Tab

Select the Honors/Rank tab.

Field or Control	Description
Hon Prefix (honors prefix)	The degree honors prefix for the plan.
Hon Suffix (honors suffix)	The degree honors suffix for the plan.
Degree GPA (degree grade point average)	The plan grade point average.
Class Rank Of	The student's class rank and class size.
Plan Seq (plan sequence)	The number of the plan within the program.

Related Links

[Viewing and Modifying Degree Plan Data](#)

Viewing Degree Subplan Change Audit Results

Access the Degree Subplan page (**Records and Enrollment > Graduation > Degree Change Audit > Degree Subplan**).

Note: Multiple views of this page are available by clicking the tabs in the scroll area. We document fields common to all views first.

Field or Control	Description
User ID	The user ID of the individual who made changes to the ACAD_DEGR_SPLN record. For rows where the action is <i>Delete</i> , no user ID appears. This is because when a record is deleted from the database, although the trigger can track that the record has been deleted, it cannot track the user ID of the person who deleted it. When deletes occur, the character string "*****" appears in the User ID field.
Date/Time	When changes to the ACAD_DEGR_SPLN record were made.

Field or Control	Description
Action	<p>Action types include the following:</p> <p><i>Insert:</i> User inserted a new row (a row was added to the database).</p> <p><i>Delete:</i> User deleted a row out of the database. For rows where the action is <i>Delete</i>, no user ID appears. This is because when a record is deleted from the database, although the trigger can track that the record has been deleted, it cannot track the user ID of the person who deleted it. When deletes occur, the character string "*****" appears in the User ID field.</p> <p><i>Before:</i> Image of the record before it was updated.</p> <p><i>After:</i> Image of the record after it was updated.</p>
ID	The ID of the student whose degree was changed.
Degree Nbr (degree number)	Students can have more than one degree, and each degree is assigned a degree number.

Plan/SubPlan Override Tab

Select the Plan/SubPlan Override tab.

Field or Control	Description
Acad Plan (academic plan)	The academic plan.
Sub-Plan	The academic subplan.
Override	Represents the Override check box on the Degree Sub-Plan page.

Descriptions Tab

Select the Descriptions tab.

Field or Control	Description
Dipl Descr (diploma description)	The academic subplan diploma description, if different from the default.
Trns Descr (transcript description)	The academic subplan transcript description, if different from the default.

Honors/Plan/Sequence Number Tab

Select the Honors/Plan/Sequence Number tab.

Field or Control	Description
Hon Prefix (honors prefix)	The degree honors prefix for the subplan.
Hon Suffix (honors suffix)	The degree honors suffix for the subplan.
Seq Nbr (sequence number)	The sequence number of the subplan assigned to the plan.

Applying for Graduation Through Self Service

If your institution has licensed PeopleSoft Campus Self Service, your students can apply for graduation directly over the web.

Related Links

[“Applying for Graduation Using Self-Service Pages” \(Campus Self Service \)](#)

[“Applying for Graduation Using PeopleSoft Fluid User Interface” \(Campus Self Service \)](#)

Managing Fluid Applications for Graduation

Institutions can use the Application for Graduation component to view and edit application data submitted through fluid. You can also create an application for graduation using this component.

When you search for records, the results will show students with an active program stack, a degree checkout status, and an expected graduation term. You can add an application record by updating the data on the student's program record and adding an Expected Graduation Term (if one doesn't exist) and setting the student's Degree Checkout Status to *Applied*.

Related Links

[“Setting Up Fluid Application for Graduation By Institution” \(Campus Self Service \)](#)

[“Setting Up Fluid Application for Graduation By Program” \(Campus Self Service \)](#)

[“Applying for Graduation Using PeopleSoft Fluid User Interface” \(Campus Self Service \)](#)

Pages Used to Manage Fluid Applications for Graduation

Page Name	Definition Name	Navigation	Usage
General Info	SSR_GR_APP_FL	Records and Enrollment > Graduation > Application for Graduation > General Info	Manage student applications. You can edit various items on this page if you have the required permissions.
Additional Info	SSR_GR_APP_DZ_FL	Records and Enrollment > Graduation > Application for Graduation > Additional Info	View and edit the data that students submit on the Additional Information page in fluid. This page is optional. If your institution uses drop zones on this page, other features may then be enabled.

Managing Student Applications

View and edit student applications for graduation.

General Information

Access the General Info page (**Records and Enrollment > Graduation > Application for Graduation > General Info**).

This example illustrates the fields and controls on the General Info page. You can find definitions for the fields and controls later on this page.

General Info
Additional Info

Student's Application for Graduation

Roberta Joseph SRGRAPP01

Academic Program Find | View All First 1 of 1 Last

Institution PeopleSoft University	Student Career Nbr 0
Academic Career Undergraduate	Program Status Active in Program
Academic Program Liberal Arts Undergraduate	
Expected Graduation Term 0900 2023 Spring	
Degree Checkout Status Applied for Graduation	
Last Updated 05/01/2023 3:55:43PM	
Last Updated By SSS_SRGRAPP01 <input type="checkbox"/> From Fluid Self Service	

Academic Plan and Sub-Plan

Plan Seq	Degree	Plan Type	Plan Description
10	Bachelor of Science	Major	Mathematics (BS)

Selected Name

Name Type
As Of Date

Display Name

Name Format Type

First Name	Middle Name	Last Name
------------	-------------	-----------

File Attachment

Attached File	View	Add	
	View	Add	<input type="button" value=""/>

[Go To Names](#)

Selected Address

Address Type
As Of Date 01/01/2018

Country United States

Address 1 18840 Densmuir

City Encino State CA Postal 91436

County USA

[Go To Addresses](#)

Selected Email

Select	Email Address	Email Type	Preferred
1	<input checked="" type="checkbox"/>	rjoseph@psunv.edu	Campus <input type="checkbox"/>

[Go To Electronic Addresses](#)

Selected Phone

Select	Phone	Phone Extension	Country Code	Phone Type	Preferred
1	<input checked="" type="checkbox"/>	805/508-8055	001	Mobile	<input checked="" type="checkbox"/>

[Go To Phone Numbers](#)

Note: Some links to other components may appear. You will be able to see these links if you have the required permissions to access those components.

Academic Program

This region displays the program stack information related to the application, including the expected graduation term, and related plan and sub-plan data.

Selected Name

This region displays the name type that was used for the application, displaying the name according to Display Name Type (if one was used in the configuration) and Name Type set up.

You can update the name type that was selected for the application for graduation. For example, if the application was submitted with "Legal" as the name type and that needs to be changed to "Preferred," then you can change it here.

If you have access to the Names component, you can click **Go to Names**. Use that component to change the student's name. For example, you can change Preferred Name "John Smith" to "John J. Smith." Or you can add a new name, and use that for the application for graduation, if necessary.

Selected Address

This region displays the address type that was used for the application, displaying the name according to the name type configuration and name display type (if this was used in the configuration).

You can update the address type that was selected for the application for graduation. If you have access to the Addresses component, click **Go to Addresses**. Use that component to change a student's existing address type.

Selected Email

This region displays one or more email addresses used for the application (depending on the configuration).

If you have access to the Electronic Addresses component, click **Go to Electronic Addresses**. Use that component to change a student's email, such as correcting an existing email, or adding a new one.

Selected Phone

This region displays one or more phone numbers used for the application (depending on the configuration).

If you have access to the Phone Numbers component, click **Go to Phone Numbers**. Use that component to change a student's number, such as correcting an existing number, or adding a new one.

Additional Information

Access the Additional Info page (**Records and Enrollment > Graduation > Application for Graduation > Additional Info**).

This example illustrates the fields and controls on the Additional Info page. You can find definitions for the fields and controls later on this page.

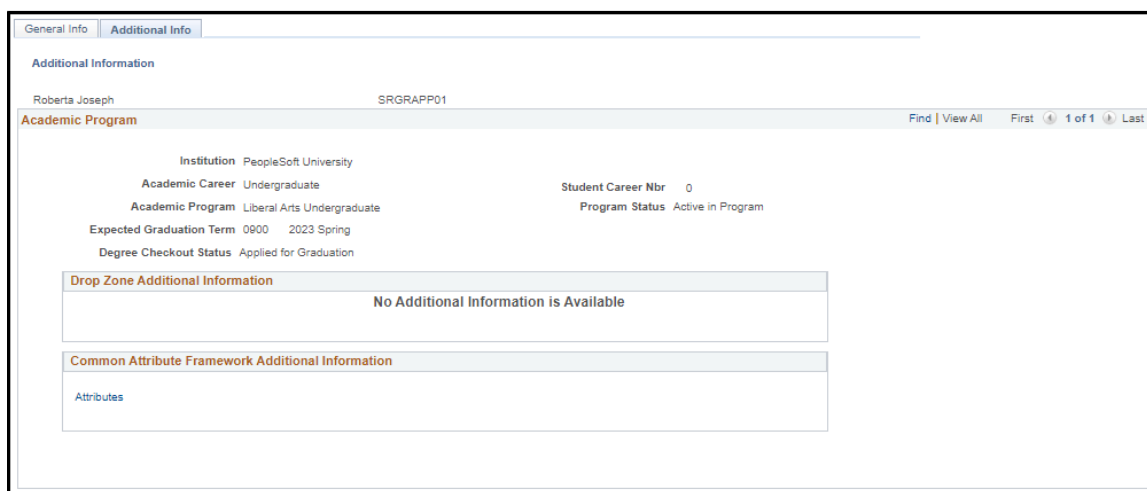

Drop Zone Additional Information

This group box displays any customer-defined feature/content implemented via PeopleTools Drop Zones. See “Using Drop Zones on Fluid Pages” (Campus Solutions Application Fundamentals).

Common Attribute Framework Additional Information

This group box displays all common attributes defined for the Application for Graduation record context (SSR_APPGRD_RCVW) and any data saved in SSR_APPGRAD_CAF for the student's application for graduation. You can add or update this data. An example would be options for graduation tickets.

Producing Transcripts

Understanding Transcript-Related Processes

Important! The COBOL transcript process is a deprecated product. It is strongly recommended that you use the Application Engine transcript process instead. For more information on the Application Engine transcript process.

Two distinct processes are available to create transcripts. One transcript process uses COBOL to generate the transcript and Crystal reports to print the transcript. The other transcript process generates transcripts using Application Engine, creates detailed results tables, and uses XML to produce the report in PDF format. The processes have separate and distinct transcript type setup and processing pages. These transcript processes were not designed to be in production concurrently. The control of which process creates transcripts is determined by the security granted to the components.

After you have set up transcript notes, transcript types, and transcript type security, you're ready to create transcript requests and process transcripts. The PeopleSoft Transcript feature enables you to define multiple types of transcripts at varying levels of security, formality, appearance, and function. You can produce transcripts for individual students or for dynamically created groups of students that meet criteria you specify. You can process transcripts online or in the background at scheduled intervals, and you can send the results to a file, a window, or a printer. Finally, the Transcript feature includes a purge process that enables you to delete transcript results and requests. Purging transcripts periodically is a maintenance practice that enhances system performance.

If you are using the COBOL process to create transcripts, the choices you have for producing transcripts are the same as those that you have for producing advising reports. In the Application Engine transcript process, the advisement reports are created by using a different component. We briefly discuss advising reports in this section, but you are encouraged to review the Academic Advisement product documentation for more information.

The COBOL transcript process provides you with five components that you can use to create, process, print, and purge transcript requests. This table lists and describes how to use those components:

Component	Usage
Transcript Request component	Request, process, and print small numbers of transcripts (recommended for fewer than 20).
Batch Transcript Request	Define group parameters and create request for large group (more than 20) of students.
Batch Transcript Generation component	Process and generate transcripts for a previously created online request. Generate transcripts for a previously created batch request.

Component	Usage
Batch Transcript Print component	Print transcripts that were previously generated through either the Transcript Request inquiry component or the Batch Transcript Generation process component.
Transcript Purge component	Purge transcript requests and transcript results based on parameters that you specify.

The Application Engine transcript process provides three components that you can use to create, process, print, and purge transcript requests. This table lists and describes how to use those components:

Component	Usage
Request Transcript Report component	Request, process, and print small numbers of transcripts (recommended for fewer than 20).
Process Transcripts component	This component combines the functionality of both the Batch Transcript Request and the Generate and Print Transcripts component.
Purge Transcript Reports component	Purge transcript requests and transcript results based on parameters that you specify.

Processing Transcripts for Individuals or Small Groups of Students

Important! The COBOL transcript process is a deprecated product. It is strongly recommended that you use the Application Engine transcript process instead. For more information on the Application Engine transcript process, see [Understanding Transcript-Related Processes](#).

This section provides an overview of the Request Transcript Report component, lists prerequisites, and discusses how to:

- Create transcript request headers.
- Specify students for evaluation.
- Enter transcript recipient information.
- View process messages for transcript requests.

Use the Request Transcript Report component to process application engine based transcripts for individuals or small groups of students.

Note: The pages of the Transcript Request component (TSCRPT_RQST) still exist in the system: SA_REQUEST_HEADER, SA_REQUEST_DETAIL, SA_REPORT_RESULTS, and SA_REQ_REPORT_ERR.

Use this component to process the COBOL based transcripts.

Understanding the Request Transcript Report Component

Use the Request Transcript Report component (application engine) to create and update transcript requests for an individual student or a small group of students. A small group of students is defined as a group of fewer than 20. Process the request, and you can view the transcripts online and print them. You can also use the Request Transcript Report component to create transcript requests for processing on future dates or events. For example, a student can request that a transcript be processed after they are awarded a degree, after their grades are posted for a term, or when a specific date arrives. When the future transcript request is saved, the system generates a report request number. You can then use a single report request number, a range of report request numbers, or requested print dates to process these requests.

Complete these steps to create a transcript request by student ID:

1. Select the transcript type and enter other general parameters on the Transcript Request Header page.
2. Enter IDs for students requesting transcripts, as well as recipient information, on the Transcript Request Detail page.
3. Submit your request by clicking the **Process Request** button on the Request Detail page.
4. View results in .PDF format by clicking the **View Report** link that appears for each student.
5. If no link appears, view any process errors on the Report Errors page.
6. Print all results by clicking the **Print** button.

Prerequisite

Before you can create an online transcript request, you must create a transcript type.

Pages Used to Create an Online Transcript Request

<i>Page Name</i>	<i>Definition Name</i>	<i>Navigation</i>	<i>Usage</i>
Transcript Request Header	SSR_TSRQST_HDR	Records and Enrollment > Transcripts > Request Transcript Report > Transcript Request Header	Select the type of transcript you want to process and set general parameters for the request.
Transcript Request Detail	SSR_TSRQST_DTL	Records and Enrollment > Transcripts > Request Transcript Report > Transcript Request Detail	Enter the IDs that you want to process and the number of copies you want to create. Run the Flexible Transcript generation process.

Page Name	Definition Name	Navigation	Usage
Send To Information	SA_REQUEST_DTL_SEC	Click the Send To button on the Transcript Request Detail page.	Specify an address to which to send a student's transcript.
Report Messages	SA_REQ_REPORT_ERR	Records and Enrollment > Transcripts > Request Transcript Report > Report Messages	Review messages about any problems the system encounters while processing the transcript request.

Creating Transcript Request Headers

Access the Transcript Request Header page (**Records and Enrollment > Transcripts > Request Transcript Report > Transcript Request Header**).

This example illustrates the fields and controls on the Transcript Request Header page. You can find definitions for the fields and controls later on this page.

Transcript Request Header
Transcript Request Detail
Report Messages

Report Request Nbr: 000000000 **Request Date:** 10/02/2006 **User ID:** PS

Request Attributes

***Institution:** PeopleSoft University

***Transcript Type:** Official Transcripts - All

Freeze Record

Override Service Indicator

Number of Copies:

Future Release:

Academic Career:

Term:

Print Date:

Request Reason:

Cancel Request

Field or Control	Description
Institution	The system populates this field by default. You can change this value before you enter a transcript type.

Field or Control	Description
Transcript Type	<p>Select a transcript type with the correct detail organization that you want to appear on the transcripts. The system populates this field by user default, but you can change this value.</p> <p>Transcript type values are defined on the Define Transcript Type - Basic Data page, and the Transcript Type default is defined on the User Defaults 4 page.</p>
Freeze Record	<p>Select to protect the request from being purged during the transcript purge process. Because requests build up quickly in your system, the application provides a purge process to delete them. If you select this check box, the purge process does not delete the request.</p>
Override Service Indicator	<p>Select this check box to have the system process transcripts for all students, regardless of whether their service indicators match those specified for this transcript type on the Basic Data page.</p> <p>For instance, some service impacts—if listed on the Basic Data page and attached to the student through a service indicator—might prevent a student from receiving a transcript.</p> <p>See Defining Transcript Type Basic Data.</p> <p>See Using Student Records Service Impacts.</p> <p>See “Viewing, Assigning, or Removing Service Indicators” (Campus Community Fundamentals)</p> <p>If you do not select this check box, the system enforces the service indicator rules and does not generate transcripts for students with negative service indicators that match the service impacts on the Basic Data page for this transcript type.</p>

Field or Control	Description
Future Release	<p>Select a value to indicate that you want the system to print the transcript at a later date. Values for this field are delivered with your system as translate values. Do not modify these values in any way. Any modifications to these values require a substantial programming effort. Values are:</p> <ul style="list-style-type: none"> • <i>Degree Confer Date</i>: The Career and Term fields become available for entry. • <i>Grades Post</i>: The Career and Term fields become available for entry. • <i>Specific Date</i>: The Print Date field is populated by default to the current date and is available for entry. • <i>Hold</i>: The Print Date field is populated by default to the current date and is available for entry. This option indicates that you are going to process the request at a later and as yet undetermined time. The system saves this request until you change the future release value and enter a specific print date. • <i>Immediate Processing</i>: The Print Date field is populated by default to the system date. This value is used as the online default, as well as by self service. • <i>Transfer Credit Post</i>: The Print Date field is populated by default to the current date and becomes available for entry. You can issue a transcript after the system has articulated transfer credit to the student's academic record. This process is not automatic.
Academic Career and Term	<p>If available for entry, select the appropriate academic career and term values. Later, you can issue a transcript on the fully graded date (future release value of <i>Grades Post</i>) or after you award degrees for the students (future release value of <i>Degree Confer Date</i>). The system populates the Print Date field with either the fully graded date from the Academic Term Calendar 3 page or the degree confer date from the Academic Term Calendar 3 page. Term values are defined on the Term Table page.</p> <p>To create transcripts for future release, enter the request parameters and save the request without processing it. To later process and print the future release request, enter a single or range of report request numbers or requested print dates on the Transcript Generation page (if running COBOL transcripts) or Process Transcripts (if running application engine transcripts). The system processes requests for all transcripts due to print within the range you specify. After you process a transcript request, the system marks the report request ID as complete and excludes it from further processing.</p>

This table lists how the **Future Release** field values affect the **Academic Career**, **Term**, and **Print Date** fields:

Field Value	Academic Career	Term	Print Date
<i>Degree</i>	Available for entry	Available for entry	Unavailable for entry (default is <i>Degree Confer Date</i> for Term).
<i>Grades</i>	Available for entry	Available for entry	Unavailable for entry (default is <i>Fully Graded Date</i> for Term).
<i>Hard Date</i>	Unavailable for entry	Unavailable for entry	Available for entry (default is the system date).
<i>Hold</i>	Unavailable for entry	Unavailable for entry	Available for entry (default is the system date).
<i>Imed Proc</i> (immediate processing) (default)	Unavailable for entry	Unavailable for entry	Unavailable for entry (default is the system date).
<i>Transfr Cr</i> (transfer credit)	Unavailable for entry	Unavailable for entry	Available for entry (default is the system date).

Field or Control	Description
Request Reason	Select a request reason. The reason appears on the transcript if the transcript type is set to display request reason information. Values for this field are delivered with your system as translate values. You can modify these values.
Cancel Request	Select this check box to cancel a future-dated transcript request before it is processed.

Using the Request Header Page (COBOL Based Transcripts Only)

These additional fields appear on the Request Header page (Records and Enrollment, Transcripts, Transcript Request, Request Header):

Field or Control	Description
Output Destination	<p>Select the output destination of the transcript. This determines where the system electronically sends the results of the process. Values for this field are delivered with your system as translate values. Do not modify these values in any way. Any modifications to these values will require a substantial programming effort. Values are:</p> <p><i>Page:</i> Sends the transcripts to the Report Results page to be viewed online before printing. You can then click the Print button to initialize Crystal, viewing and printing transcripts through a new window.</p> <p><i>Printer:</i> Like the Page option, sends the transcripts to the Report Results page to be viewed online before printing. You can then click the Print button to initialize Crystal, viewing and printing transcripts through a new window.</p>
Report Format	<p>With a transcript type that includes an advising report, the Report Format field becomes available for entry. A single report request can have multiple report formats. Values for this field are delivered with your system as translate values. Do not modify these values in any way. Any modifications to these values will require a substantial programming effort. Values are:</p> <p><i>Standard Report Format:</i> Indicates that the report is delivered to a page or printer.</p> <p><i>Analysis Database:</i> Indicates that the results of the report are written to the analysis database. The results are stored in computer-readable format so application programs can be written against the tables to create user configurable reports. (This is the only field value that refreshes the database tables.)</p> <p><i>Completed Only:</i> Indicates that the report contains only those requirement groups that have been wholly completed. (Usually, the advising report bolds incomplete requirement groups and requirements while completed requirement groups are not bold.)</p> <p><i>Incompleted Only:</i> Indicates that the report contains only those requirement groups that have not been wholly completed. (This field value can help a counselor determine exactly what a student needs to satisfy in order to graduate.)</p>

Specifying Students for Evaluation

Access the Transcript Request Detail page (**Records and Enrollment > Transcripts > Request Transcript Report > Transcript Request Detail**).

<i>Field or Control</i>	<i>Description</i>
Seq Nbr (sequence number)	The system determines the sequence number, and the number is the order in which the transcripts are processed.
ID	Enter IDs of students for whom you want to process transcripts. The system populates the name by default after you enter the ID and tab out of the field.
Number of Copies	Although you can indicate the overall number of copies on the Transfer Request Header page, you can override the number on a student-by-student basis by changing the value in this field.
Send To	Before you process the transcript request, click to enter recipient information for each ID.
Process Request	Click when you are ready to submit the request for processing. An Application Engine process commences. When the process is complete, the system displays the View Report link next to the student's ID. If no View Report link appears, access the Report Errors page to investigate what went wrong during the process.
View Report	Click this link to view the transcript as a PDF file. Each student ID has a link to view its report.
Print	After you successfully complete the transcript request process, the Print button becomes available. Click the button to submit all of the transcripts on this request to the printer.

Using the Request Detail Page (COBOL Based Transcripts Only)

Here is some information about the Request Detail page (Records and Enrollment, Transcripts, Transcript Request, Request Detail):

<i>Field or Control</i>	<i>Description</i>
Process Request	Click when you are ready to submit the request for processing. A COBOL/SQL process commences and, when complete, the system displays the results on the Report Results page and automatically opens that page.

<i>Field or Control</i>	<i>Description</i>
Print	After you have successfully completed the transcript request process, the Print button on the Request Detail page becomes available. Click the button to submit the Crystal to the Report manager. Use the Report Manager link to view and print the Crystal output, which the system sorts by Student Name within Transcript Request ID. Click the Print button on the Crystal window and choose whether you want to print all pages or a range of pages. When you have large groups of transcripts to print, clicking the Print All button significantly reduces the time it takes you to print them. You can also print transcripts by individual student ID by clicking the Print button on the Report Results page.

Entering Transcript Recipient Information

Access the Send To Information page (click the **Send To** button on the Transcript Request Detail page).

<i>Field or Control</i>	<i>Description</i>
Send To	Enter the name of the addressee.
Specify External Org ID (specify external organization ID)	Select to send the transcript to an external organization that you already have in your database.
Org ID (organization ID)	Select the appropriate external organization ID number. If you do not select the Specify External Organization ID check box, enter the name and address of the recipient in the available address fields.
Update	Click to save and exit the page.
Cancel	Click to exit the page.
Edit Address	Click this link to enter or update the address where the transcript is to be sent.

Viewing Process Messages for Transcript Requests

Access the Report Messages page (**Records and Enrollment > Transcripts > Request Transcript Report > Report Messages**).

<i>Field or Control</i>	<i>Description</i>
Sequence	After you run the process, the system displays the sequence number in the Sequence column.

<i>Field or Control</i>	<i>Description</i>
Message Text	The message text explains the message or error, if any.

Using the Report Results Page (COBOL)

Here is some information about the Report Results page (Records and Enrollment, Transcripts, Transcript Request, Report Results):

<i>Field or Control</i>	<i>Description</i>
Print	<p>Click to submit the Crystal to the Report manager. Use the Report Manager link to view and print the Crystal output. Click the Print button on the Crystal window and choose whether you want to print all pages or a range of pages. When you have large groups of transcripts to print, clicking the Print All button significantly reduces the time it takes you to print them. You can also print transcripts by individual student ID by clicking the Print button on the Report Results page.</p> <p>To print transcripts for multiple students whose transcripts you have processed within this report request number, click the Print button on the Request Detail page then click Print All from the Crystal window. If necessary, you can save the transcript request and both process and print the request at a later time.</p>

To view messages about any problems that the system encounters while processing the transcript request (COBOL), use the Report Errors page (Records and Enrollment, Transcripts, Transcript Request, Report Errors).

Processing Batch Transcripts (Application Engine)

This section discusses how to process Application Engine based batch transcripts.

The Process Transcripts process enables you to process transcripts in multiple ways for a large group of students at one time. Based on a specific academic institution or transcript type, you can select the appropriate process action to: create a transcript request; generate or generate and print transcripts; only print transcripts; or request, generate, and print transcripts in a single step.

Complete these steps to process batch transcripts:

1. Specify the parameters for which you want to process transcripts on the Process Transcripts page.
2. Click the **Run** button on the Process Transcripts page to request, generate, or print your transcript.
3. After the process finishes, select **View Log and Trace** and select the PDF file.

Note: To process transcript requests for individual student IDs, use the Request Transcript Report component.

Page Used to Process Batch Transcripts

Page Name	Definition Name	Navigation	Usage
Process Transcripts	SSR_RUNCTL_TSRPT	Records and Enrollment > Transcripts > Batch Transcripts > Process Transcripts	Select the institution and type of transcript that you want to process, and the appropriate processing action and student criteria for the group of students.

Defining Transcript Processing Options

Access the Process Transcripts page (**Records and Enrollment > Transcripts > Batch Transcripts > Process Transcripts**).

This example illustrates the fields and controls on the Process Transcripts page. You can find definitions for the fields and controls later on this page.

Process Transcripts

Run Control ID: PS [Report Manager](#) [Process Monitor](#) Run

*Academic Institution:

*Transcript Type:

Process Action:

Request Options

Override Service Indicator

Population Selection

Population Selection

Student Select List

Use Student Select Clear List

EmpID	Name		
1 SR12201 <input style="width: 50px;" type="text"/>	Keshishi,Khanom	+	-

Note: The fields on this page change based on the **Process Action** that you select.

Field or Control	Description
Academic Institution	Select the institution for which the transcript type is associated. When you run the process, the system creates a transcript request number for each row within the process instance. Institution values are defined on the Academic Institution Table page.
Transcript Type	Select the transcript type. Be sure you select a transcript type with the correct detail organization that you want to appear on the transcripts. You can organize by academic career or chronology. Transcript type values are defined on the Define Transcript Type - Basic Data page.
Process Action	<p>Select one of these options: <i>Create Transcript Request</i>, <i>Generate Transcript</i>, <i>Generate and Print Transcript</i>, <i>Print Transcript</i>, or <i>Request, Generate and Print</i>.</p> <p>If you select a Process Action of <i>Generate Transcript</i> or <i>Generate and Print Transcript</i>, the system finds all transcripts that have an On Request status (requested only).</p> <p>If you select a Process Action of <i>Print Transcript</i>, the system finds all transcripts that have a Completed status (generated), but have not yet printed.</p> <p>To reprint a previously printed transcript, select the Reprint check box. This check box is available only when you select a Process Action of <i>Print Transcript</i>.</p> <hr/> <p>Note: If you select the Allow XML Output File check box on the Define Transcript Type - Basic Data page, the Output XML File and Output File Path fields appear on this page when you select a value of <i>Generate and Print Transcript</i>, <i>Print Transcript</i>, or <i>Request, Generate and Print</i> in the Process Action field.</p> <hr/>
Override Service Indicator	Select this check box to override any service indicators attached to student records that may prevent a transcript from being generated.

Population Selection

This group box appears if you select the *Create Transcript Request* or *Request, Generate and Print* process action.

Population selection is a method for selecting the IDs to process for a specific transaction. The Population Selection group box is a standard group box that appears on run control pages when the Population Selection process is available or required for the transaction. Selection tools are available based on the selection tools that your institution selected in the setup of the Population Selection process for the application process and on your user security. Fields in the group box appear based on the selection tool that you select. The fields behave the same way from within the group box on all run control pages and application processes.

If your institution uses a specific delivered selection tool (PS Query, Equation Engine equation, or external file) to identify IDs for a specific transaction, you must use it.

See “Understanding the Population Selection Group Box” (Campus Community Fundamentals)

See “Using the Population Selection Process” (Campus Community Fundamentals)

Field or Control	Description
Query Name	<p>If you selected <i>PS Query</i>, select an existing query in the system. The application delivers these predefined queries:</p> <ul style="list-style-type: none"> • SSR_TS_ACADLEVEL: Transcript Query by Acad Level (transcript query by academic level) • SSR_TS_ADVISOR: Transcript Query by Advisor • SSR_TS_CAREER: Transcript Query by Career • SSR_TS_PROGPLAN: Transcript Query by Prog Plan (transcript query by program/plan) • SSR_TS_PROGRAM: Transcript Query by Program • SSR_TS_STUDENT_GRP: Transcript Query by Stdnt Grp (transcript query by student group) <hr/> <p>Note: You should not modify the delivered queries. Instead, create new queries using the Save-As feature so that the integrity of the delivered queries is not compromised.</p> <hr/>

Student Select List

This group box appears if you select the *Create Transcript Request* or *Request, Generate and Print* process action. Select the **Use Student Select** check box to add individual student IDs to your batch transcript process request. You can use this method alone or in combination with the Population Selection process to create the batch request.

Field or Control	Description
EmplID (employee ID)	Enter individual student IDs that you want to include in the batch transcript request. The student's name appears to the right of this field.
Clear List	Click this button to remove all entered names from the student list.

Generate and Print Options

This group box appears if you select the *Generate Transcript*, *Generate and Print Transcript*, or *Print Transcript* process option.

<i>Field or Control</i>	<i>Description</i>
Generate Transcripts By	Select whether to generate transcripts by <i>Request Date</i> or <i>Request Nbr</i> (request number).
Request Date	To generate transcripts by date, enter a single date or date range for the previously created transcript requests.
Request Number	To generate transcripts by number, enter one or more previously created transcript request numbers.

Additional Options

If you selected the *Generate and Print Transcript*, *Print Transcript*, or *Request, Generate and Print* process option, this group box appears.

<i>Field or Control</i>	<i>Description</i>
Print Sort Option	Select whether to sort the transcripts for printing by <i>Last Name</i> , <i>Student ID</i> , or <i>Zip/Postal Code</i> .

Using the XML Transcript Template

This section discusses how to use the XML transcript template.

Understanding the XML Transcript Template

When a transcript is processed, an XML file is also created, with data for testing.

The XML file is uploaded to the Data Source page (Reporting Tools, XML Publisher, Data Source, Data Source).

To use the XML transcript template:

1. Select **Reporting Tools** > **XML Publisher** > **Report Definition** and search by SSR.
2. Select *SSR_TSRPT* and access the Template page.
3. Click the **Download** button to select the template (it is an .rtf file).

Note: Two rows exist: Landscape and Portrait.

4. To access the sub template, select **Reporting Tools** > **XML Publisher** > **Content Library**.
5. Search using SSR and select *SSR_TSRPT_STMPLT*.
6. To use the Word Plug-In during testing of the template design, you must make some changes to the template so that the Word Plug-In knows where to find the sub template: click **Download** to view the instructions, which are at the top of the sub template.
7. To access the Plug-In, select **Reporting Tools** > **XML Publisher** > **Setup** > **Design Helper**.

PeopleTools: BI Publisher for PeopleSoft

Personalizing XML Transcript Dates

The system date format is set up on the Define Personalizations page in PeopleTools (**PeopleTools** > **Personalization** > **Personalization Options** > **Define Personalizations** > **Format**). Individual users can also set the date format by using the **My Personalizations** menu link. A local variable exists on the XML Transcript template, *date_mask*, to represent the date mask as the date format that was set up using personalizations. This variable is then added to each date field in the template, as the academic plan date. The Print Date and Plan Date fields on the transcript use this date formatting, as this example illustrates.

This example illustrates personalized date formatting on an XML transcript.

Name:	Sevilla Flores
Student ID:	SRTS0003
Institution Info:	PeopleSoft University 4301 Hacienda Boulevard Pleasanton, CA 94588
Print Date:	07/22/2009
Birthdate:	05/01/1977
Sex:	Female
Student Address:	2705 3rd Ave Chandler, AZ 85459
Academic Program History	
Program:	Fine Arts Undergraduate
03/01/1997:	Active in Program
03/01/1997:	Music Theory and History Major
Program:	Fine Arts Undergraduate
08/01/1998:	Active in Program
08/01/1998:	Music Performance Major
Other Institutions Attended	
	Long Beach City College 1234 Main Street 234 Third Street Long Beach, CA 90271
Basis of Admission	
(GEN)	Applicant has met the general requirements for admission.
Degrees Awarded	
Degree:	Honors in Bachelor of Fine Artswith Distinction
Confer Date:	06/01/2001
Degree GPA:	3.500
Degree Rank:	5 of 45
Degree Honors:	Cum Laude
Plan:	Honors in Music Performance
Plan GPA:	3.900
Sub-Plan:	Piano
Sub-Plan:	Voice
Requestor:	Betty Locherty

Creating Batch Transcript Requests (COBOL)

Important! The COBOL transcript process is a deprecated product. It is strongly recommended that you use the Application Engine transcript process instead. For more information on the Application Engine transcript process, see:

[Understanding Transcript-Related Processes](#)

[Processing Batch Transcripts \(Application Engine\)](#)

The Transcript Request process (COBOL) component enables you to create transcript requests for a large group of students at one time based on a specific academic institution and transcript type, and based on additional selection criteria and key values that you specify to define the group. For example, you can use this component to create transcript requests for all senior-level undergraduates for the fall term.

Note: The pages of the Transcript Request process (RUNCTL_SR_TSBATCH) and the Batch Transcript Generation (RUNCTL_SR_TSBATCH) components still exist in the system: RUNCTL_SRTSCRPT and RUNCTL_SRTSBGEN.

Use these components to process the COBOL based transcripts.

To create a batch transcript request (COBOL):

1. Specify the parameters for which you want to create transcript requests on the Batch Transcript Request page.
2. Click the Run button on the Batch Transcript Request page to create your request.
3. After the Transcript Request process finishes, view the Message Log and note the Transcript Request Number. You can enter the Transcript Request Number on the Transcript Generation page to generate the transcripts.

This section lists prerequisites and discusses how to run the Batch Transcript Requests process.

Prerequisites

Before you can process a batch transcript request, you must:

- Define your run control ID.
- Define transcript types and any of the key values that you want to use as search criteria.

Page Used to Create Batch Transcript Requests

<i>Page Name</i>	<i>Definition Name</i>	<i>Navigation</i>	<i>Usage</i>
Batch Transcript Request	RUNCTL_SRTSCRPT	Records and Enrollment > Transcripts > Batch Transcripts > Batch Transcript Request	Select the institution and type of transcript that you want to process, select the criteria for the group of students, and create the transcript requests for all students who meet your selection criteria. This process only creates a request; it does not generate a transcript. To generate transcripts, use the Transcript Generation component.

Running the Batch Transcript Request Process

Access the Batch Transcript Request page ((**Records and Enrollment > Transcripts > Batch Transcripts > Batch Transcript Request**)).

This example illustrates the fields and controls on the Batch Transcript Request page. You can find definitions for the fields and controls later on this page.

Batch Transcript Request

Run Control ID: PS [Report Manager](#) [Process Monitor](#) Run

User ID: PS Run Control ID: PS

Request No: 1 Product: SA Application: SRTSRQST When: Always

Instance: Status: Pending

*Institution	*Transcript Type	*Transcript Request Criteria	Group Name			
PSUNV	ALLOF	Student Group	ATHL	<input type="text" value="Athlete"/>	<input type="button" value="+"/>	<input type="button" value="-"/>

<i>Field or Control</i>	<i>Description</i>
Institution	Select the institution for which the transcript type is associated. Add rows as necessary. When you run the process, the system creates a transcript request number for each row within the process instance. Institution values are defined on the Academic Institution Table page.
Transcript Type	<p>Select the transcript type. Be sure you select a transcript type with the correct detail organization that you want to appear on the transcripts. You can organize by academic career or chronology. Academic advising reports can include both an advising report and a regular transcript. When transcript types have the Advising Report check box or the Special Advising Report check box selected on the Basic Data page, the transcript includes an audit of academic requirement groups. Transcript type values are defined on the Transcript Type - Basic Data page.</p> <p>If you select an advising transcript type, the Use Stored What-If, Database Report, and As of Date fields become available for entry.</p>
Use Stored What-If	Select to process the batch of advisement reports based on stored what-if information for each student (as opposed to actual student academic career, academic program, academic plan and academic subplan information). For example, a student may have a stored what-if scenario set up for them that has an alternate combination of academic program, academic plan, academic subplan, requirement term, and so on. If the Use Stored What-If check box is selected, the system uses the hypothetical what-if data rather than the student's actual data from the Student Program/Plan component.

Field or Control	Description
Database Report	<p>Select this check box to update the academic advisement analysis database with the results of the transcript request (at the time of the Transcript Generation process). Specific data for each student based on each student's respective requirements is then available for query and reporting. For example, you may run an advisement report with the Student Group and Athlete options selected, thereby populating the analysis database with advising results for student athletes. You may then query those tables to create user configurable reports for all athletes at a later date.</p>
As of Date	<p>Set the As of Date field as appropriate to include or exclude future-dated academic programs, academic plans, academic subplans, conditions, and entity groups when you process any type of academic advising report.</p> <p>At the start of the advising report process (on the Transcript Generation page), the system references the value in the As of Date field to determine which STUDENT_CAR_TERM records are active for each student. Active records are defined as rows on the Track Student Careers component, with an effective date that is equal to or less than the as-of date and with a program action of activate, data change, plan change, program change, or readmit. After the system identifies the active rows, it compares the student's career, program, plan, subplan, and requirement term information against the appropriate academic requirement groups. Appropriate academic requirement groups are defined as those with effective dates that are equal to or less than the start date of the student's requirement term. Regardless of the As of Date field value, the system evaluates all courses on a student's transcript, future-dated or otherwise.</p> <hr/> <p>Note: As delivered, the system populates the As of Date field by default to <i>01/01/3000</i>, but you can modify the date each time you run the process. To set the As of Date field default to the current date, go to the Installation Student Administration page and clear the Transcript Default As of Date field.</p> <hr/>
Transcript Request Criteria	<p>Select batch processing criteria and further describe the group. Select one of these values:</p> <p><i>Academic Level:</i> If you select this option, the Career, Term, and Level fields become available for entry. The values in all three of these fields intersect to form a single criterion set.</p> <p><i>Advisor:</i> If you select this option, the Advisor field becomes available for entry.</p> <p><i>Career/Program/Plan:</i> If you select this option, the Career, Acad Program (academic program), and Acad Plan (academic plan) fields become available for entry.</p> <p><i>Student Group:</i> If you select this option, the Group Name field becomes available for entry.</p>

Field or Control	Description
Career	Creates transcript requests for all students within the academic career you specify. Academic career values are defined on the Academic Career Table page. This field is required.
Acad Program (academic program)	Creates transcript requests for all students within the academic career and academic program that you specify. Academic program values are defined in the Academic Program Table component.
Acad Plan (academic plan)	Creates transcript requests for all students within the academic career, academic program, and academic plan that you specify. Academic plan values are defined on the Academic Plan Table page.
Term	Creates transcript requests for all students that are term activated in the academic career and academic level as of the term you specify. Term values are defined on the Term Table page. This field is required.
Academic Level	Creates transcript requests for all students within the academic career and academic level as of the term you specify. Academic level values are defined on the Academic Level Table page. This field is required.
Advisor	Creates transcript requests for all active students who are assigned to this advisor on the Student Advisor page. This field is required.
Group Name	Creates transcript requests for all students who are active within the group that you specify. Student group names are defined on the Student Group Table page and assigned to students on the Student Groups page.

Click the **Run** button to run this request. When you click the **OK** button, an Application Engine process scans the database and creates transcript requests for the students who match your selection criteria. When the Run Status for SRTSRQST process is Success, you can generate the transcripts on the Transcript Generation page. Be sure to click the **Message Log** link on the Process Detail page to note the system-generated transcript request numbers. You need these numbers to generate transcripts on the Transcript Generation page and to print transcripts on the Transcript Print page.

Using the Grade Review Transcript Release Process

Using the Grade Review Transcript Release process, you can update your students' fully graded date and grade review status in batch mode, and then process transcripts or degree audits for students who meet your specific run control parameters. Essentially, this process releases transcripts or degree audits only if a student's classes are fully graded for the term. If some required grades are missing, the process does

not generate a transcript. Instead, it assigns a special grade review value to the student so that they can be easily identified for future processing.

Complete these steps to use the Grade Review process:

1. Set up grade review values on the Grade Review Table page.
2. Set specific grade bases as *required* on the Grading Scheme Table page.
3. Process grade reviews.
4. View the grade review information on the Student Grade Review page.
5. View fully graded date information on the Term Control Dates page.
6. View the transcripts through the Transcript Request component.

Pages Used to Run the Grade Review Process

Page Name	Definition Name	Navigation	Usage
Grade Review Table	GRD_REVIEW_TABLE	Set Up SACR > Product Related > Student Records > Grading > Grade Review > Grade Review Table	Define different values that you want to assign to students as a result of the grade review process. For example, <i>MISS</i> for missing grades, <i>PEND</i> for pending grade review, and <i>COMP</i> for completed all grades. The system assigns these values to students on the Term History - Student Grade Review page based on the status of the students' grades for the term you specify.
Grading Scheme Table	GRADING_SCHEME_TBL	Set Up SACR > Foundation Tables > Academic Structure > Grading Scheme Table > Grading Scheme Table	Define the grade bases that you want to require. The system references the Grade Required check box setting to determine if a student's transcript can be released or not. Students who are enrolled in classes with a grade basis that is set to Grade Required must have all of their grades entered and posted for a specific term in order for the system to release their transcript through the Grade Review process.

Page Name	Definition Name	Navigation	Usage
Grade Review	RUNCTL_SRGRDREV	Curriculum Management > Grading > Grade Review > Grade Review	Specify the group of students that you want to evaluate for fully graded data. Also, define other processing parameters and enter the values that you want to assign to the students' records. Run the Grade Review (SRPCGRDR) process.
Student Grade Review	STDNT_GRD_REVIEW	Records and Enrollment > Student Term Information > Term History	View or change the grade review value that the Grade Review process assigned, or enter a grade review value. Define grade review values on the Grade Review Table page.

Setting Up Grade Review Values

Access the Grade Review Table page (**Set Up SACR** > **Product Related** > **Student Records** > **Grading** > **Grade Review** > **Grade Review Table**).

This example illustrates the fields and controls on the Grade Review Table page. You can find definitions for the fields and controls later on this page.

Grade Review Table

Academic Institution: PSUNV PeopleSoft University

Academic Career: UGRD Undergraduate

Grade Review: MISS

Find | View All First 1 of 1 Last

***Effective Date:** ***Status:**

***Description:**

Short Description:

Field or Control	Description
Effective Date	Enter an effective date for this grade review status. The effective date defines when the status that you select is valid.

<i>Field or Control</i>	<i>Description</i>
Status	Select a status for this grade review. Select <i>Active</i> when adding a new grade review status. The <i>Inactive</i> option should only be used if your institution will no longer use this grade review status.
Description	Enter a description for the status. The description appears on the Student Grade Review page.
Short Description	Enter a short description for the status.

Specifying Required Grade Bases

Access the Grading Scheme Table page (**Set Up SACR > Foundation Tables > Academic Structure > Grading Scheme Table > Grading Scheme Table**).

Related Links

[Defining Grading Schemes](#)

Defining Grade Review Parameters

Access the Grade Review page (**Curriculum Management > Grading > Grade Review > Grade Review**).

This example illustrates the fields and controls on the Grade Review page (1 of 2). You can find definitions for the fields and controls later on this page.

Grade Review

Run Control ID: PS [Report Manager](#) [Process Monitor](#) Run

*Academic Institution: PSUNV PeopleSoft University
*Academic Career: UGRD Undergraduate
*Term: 0410 2000 Fall
*System Date: 07/10/2001

Grade Review Values to Assign

Grade Review Status:	COMP	Completed all Required Grades
Grade Review Missing Grades:	MISS	Missing Grades
Grade Review Excl Acad Stand:	ACAD	Excluded due to Acad Standing

Processing Options

Generate Transcript Transcript Type: Unofficial Transcript-- All

Set Fully Graded Date

Grades Required

Process Blank Grade Review

Process Following Grade Review Statuses

Find First 1 of 1 Last

*Grade Review Status: + -

This example illustrates the fields and controls on the Grade Review page (2 of 2). You can find definitions for the fields and controls later on this page.

Student Selection Criteria

Academic Program: Liberal Arts Undergraduate

Academic Plan:

Academic Sub-Plan:

Academic Load: ▼

Academic Level: ▼

Degree Checkout Status: ▼

Expected Graduation Term:

Student Group: Athlete

Exclude Following Academic Standings
Find
First ◀ 1 of 1 ▶ Last

***Academic Standing:** + -

<i>Field or Control</i>	<i>Description</i>
Academic Institution	Select the institution for which you want to run the grade review process. The system populates this field by default to the setting on the User Defaults 1 page.
Academic Career	Select the academic career of students for which you want to run the grade review process. The system populates this field by default to the setting on the User Defaults 1 page.
Term	Select the term for which you want to run the grade review process. The system populates this field by default to the setting on the User Defaults 1 page.
System Date	The process assigns this date to the student records when it assigns new grade review values. For example, if a student is fully graded and meets all other processing parameters, the student's grade review status is set to <i>COMP</i> on the Student Grade Review page, with an effective date equal to the system date. In addition, if you select the Set Fully Graded Date check box, the system sets the student's fully graded date to the system date on the Term Control Dates page.
Grade Review Status	Select a status to assign to a student on the Student Grade Review page if the system finds him to be fully graded for the term.

Field or Control	Description
Grade Review Missing Grades	Select a status to assign to a student on the Student Grade Review page if the system finds the student to be in acceptable academic standing but lacking fully graded enrollment records for the term. If a student is neither fully graded nor in acceptable standing, the system assigns the value in the Grade Review Excl Acad Stand field to the student on the Student Grade Review page.
Grade Review Excl Acad Stand (grade review excluded due to academic standing)	Select a status to assign to a student on the Student Grade Review page if the system finds him to be fully graded but his academic standing for the term is equal to the value in the Academic Standing field. If a student is neither fully graded nor in acceptable standing, the system assigns the value in the Grade Review Excl Acad Stand field to the student on the Student Grade Review page.
Generate Transcript	<p>Select to process transcripts for the students in your selected population.</p> <hr/> <p>Warning! If you select the Generate Transcript check box and run the Grade Review process, the system immediately generates transcripts (not just transcript request numbers) for all students in your population. Depending on the size of your population and the transcript type you select, this process could take a substantial amount of time to complete.</p> <hr/>
Transcript Type	Select the type of transcript that you want to generate.
Report Format	<p>If you select a transcript type that is an advising report, the Report Format field is available for entry. Select from these values:</p> <p><i>Standard Report Format:</i> Indicates that the report is delivered to a page or a printer.</p> <p><i>Analysis Database:</i> Indicates that the results of the report are written to the analysis database. The results are stored in computer-readable format so application programs can be written against the tables to create user configurable reports. (This is the only field value that refreshes the database tables.)</p> <p><i>Completed Only:</i> Indicates that the report contains only those requirements that have been wholly completed. (Normally, the advising report marks incomplete requirement groups and requirements in bold, while completed requirement groups and requirements are not in bold.)</p> <p><i>Incompleted Only:</i> Indicates that the report contains only those requirements that have not been wholly completed. (This field value can help a counselor determine exactly what a student needs to satisfy in order to graduate.)</p>

Field or Control	Description
Set Fully Graded Date	Select to set a student's fully graded date (on the Term Control Dates page) to the system date you specify in the System Date field. The system sets the fully graded date only if the process assigns a new grade review status to the student. If no grade review status is assigned, the fully graded date field does not update. Clear this check box if you never want to update the fully graded date.
Grades Required	Select to have the system use the Grade Required check box setting on the Grade Scheme Table page to determine if grades are missing. If you select this check box, the system only evaluates courses taken with grade bases for which the Grade Required check box is selected. If you clear this check box, students in the population will be set regardless of whether their grades are in.
Process Blank Grade Review	Select to include in your student selection students with no grade review value.
Grade Review Status	Enter the current grade review status of students that you want to process. Add rows to specify more than one valid grade review status value.
Academic Program	Select the academic program of the students you want to review.
Academic Plan	Select the academic plan of the students you want to review.
Academic Sub-Plan	Select the academic subplan of the students you want to review.
Academic Load	Select the academic load of the students you want to review for the term you specify.
Academic Level	Select the academic level (term begin) of the students you want to review for the term you specify.
Degree Checkout Status	Select the degree checkout status of the students you want to review.
Expected Graduation Term	Select the expected graduation term of the students you want to review.
Student Group	Select the student group of the students you want to review.

Field or Control	Description
Academic Standing	Select the academic standing of students (on the Term History page for the term you specify) that you want to <i>exclude</i> from the grade review. Add rows to specify more than one type of academic standing value that you want to exclude from the review.

Click **Run** to run this request. PeopleSoft Process Scheduler runs the Grade Review Process Driver process at user-defined intervals. If you selected the **Generate Transcripts** check box, you can view the transcripts online or print them when the process finishes.

Producing Electronic Transcripts

After you have set up the TS130 controls and mapped your internal values within the EDI Manager, you can create electronic transcript requests and process outbound files. This section discusses how to:

- Enter electronic transcript request information.
- Enter the recipient's address information.
- Enter send options.
- View electronic transcript request history for a student.

Related Links

[Setting Up Electronic Transcript Processing](#)

Pages Used to Produce Electronic Transcripts

Page Name	Definition Name	Navigation	Usage
Transcript Request	TSCRPT_REQUEST	Records and Enrollment > Transcripts > Electronic Transcripts > Electronic Transcript Request > Transcript Request	Enter general information about this transcript request.
Address	TSCRPT_ADDRESS	Records and Enrollment > Transcripts > Electronic Transcripts > Electronic Transcript Request > Address	Enter address information for the organization to which you are sending the electronic transcript.

<i>Page Name</i>	<i>Definition Name</i>	<i>Navigation</i>	<i>Usage</i>
Send Options	TSCRPT_EMAIL_SEND	Records and Enrollment > Transcripts > Electronic Transcripts > Electronic Transcript Request > Send Options	Specify the send method and the recipient's email information.
Request History	TSCRPT_HISTORY	Records and Enrollment > Transcripts > Electronic Transcripts > Electronic Transcript Request > Request History	View the electronic transcript request history for this student.

Entering Electronic Transcript Request Information

Access the Transcript Request page (**Records and Enrollment > Transcripts > Electronic Transcripts > Electronic Transcript Request > Transcript Request**).

This example illustrates the fields and controls on the Transcript Request page. You can find definitions for the fields and controls later on this page.

The screenshot shows the 'Transcript Request' page with the following fields and controls:

- Transcript Seq No:** 1, On Request, Process button, + -
- Request Date:** 07/16/2004
- *Academic Institution:** PSUNV (dropdown), PeopleSoft University
- *Transcript Type:** Official Transcripts - All (dropdown)
- Request Reason:** Graduation (dropdown)
- Request Reason:** (text input field)
- Override Service Indicator:**
- *Future Release:** Immediate Processing (dropdown)
- Academic Career:** (text input field)
- Term:** (text input field)
- Date to be Processed:** 07/16/2004, **Date Processed:** (text input field)
- User ID:** Locherty, Betty

<i>Field or Control</i>	<i>Description</i>
Transcript Seq No (transcript sequence number)	The system assigns a sequential number to each request that you enter for the student.

Field or Control	Description
Request Date	The system displays the date on which you enter the request. When you enter a new request, the system uses the current date by default.
Academic Institution	Select the academic institution for which you want to print the request. By default, the system selects the academic institution defined in the User Defaults component.
Transcript Type	Select a transcript type with the correct detail that you want to report electronically. Only transcript types for which you have user security and that have valid careers for this student are available. Transcript type values are defined on the Transcript Type - Basic Data page.
Request Reason	Select the request reason. Request reason values are delivered with your system as translate values. You can modify these values. You can enter free-form text to further clarify the request reason in this field.
Override Service Indicator	Select this check box to have the system process the transcript for this student, regardless of whether the student has a service indicator with service impacts that match those specified for this transcript type on the Basic Data page. Service impacts that are listed on the Basic Data page and are attached to the student prevent a student from receiving a transcript. If you do not select this check box, the system enforces the service indicator rules and does not generate transcripts for a student with service impacts that match those on the Basic Data page for this transcript type. See “Viewing, Assigning, or Removing Service Indicators” (Campus Community Fundamentals)

Field or Control	Description
Future Release	<p>Select a future release to indicate that you want the system to generate the transcript at a later date. Future release values are delivered with your system as translate values. These translate values should not be modified in any way. Any modifications to these values require a substantial programming effort.</p> <p>Values are:</p> <p><i>Degree Confer Date:</i> The Career and Term fields become available for entry.</p> <p><i>Grades Post:</i> The Career and Term fields become available for entry.</p> <p><i>Hold:</i> The system sets the Date to be Processed field to the current date and is available for entry. This option indicates that you are going to process the request at a later and undetermined time. The system saves this request until you change the future release value and enter a specific print date.</p> <p><i>Immediate Processing:</i> The system sets the Date to be Processed field to the system date.</p> <p><i>Specific Date:</i> The system sets the Date to be Processed field to the current date and it is available for entry. You can enter a specific date for the transcript request to be processed through the Generate Electronic Transcript page.</p> <p><i>Transfer Credit Post:</i> The system sets the Date to be Processed field to the current date and it becomes available for entry. You can issue a transcript through the Generate Electronic Transcript page after the system articulates transfer credit to the student's academic record. Because this process is not automatic, you must still generate the electronic transcript on the Generate Electronic Transcript page.</p>
Academic Career and Term	<p>If available for entry, select the appropriate academic career and term values. You can issue a transcript later through the Generate Electronic Transcript page on the fully graded date—future release value of <i>Grades Post</i>—or when the degree confer date arrives for the student—future release value of <i>Degree Confer Date</i>. The system populates the Date to be Processed field with either the fully graded date from the Term Control Dates page in the Term Activation component, or the degree confer date from the Degree page in the Student Degrees component. Term values are defined on the Term Table page.</p> <p>To create transcripts for future release, enter the request parameters and save the request without processing it. To process and send the future release request later, enter into the Generate Electronic Transcript page a range of dates based on the Dates to be Processed field. The system processes requests for all electronic transcripts that have not yet been generated within the range you specify. After you process a transcript request, the system marks the report request ID as <i>Generated</i>, and the system excludes it from further batch processing.</p>

<i>Field or Control</i>	<i>Description</i>
Entered By	The system displays the user ID and name of the person who entered the request.
Process	<p>Click to process the request immediately and send the report as indicated on the Send Options page. The system takes you to the Request History page.</p> <p>The Process button calls an Application Engine program that processes the request and creates the flat file. PeopleSoft PeopleCode, using Workflow, will send the resulting file as an email attachment if so requested on the Send Options page.</p> <p>The process updates the request status to be generated. If you also send the file by email, the process updates the request status to complete.</p> <p>If the student has a service indicator with an attached service impact that is defined on the transcript type setup, the system displays the Service Indicator page and indicates that it prevented the transcript due to negative service indicators.</p>

Entering the Recipient's Address Information

Access the Address page (**Records and Enrollment > Transcripts > Electronic Transcripts > Electronic Transcript Request > Address**).

<i>Field or Control</i>	<i>Description</i>
Send to Student	Select to automatically populate the Send to field with the student's name. The Address Type field becomes available.
Address Type	Select the address type for the student to which you want to send this transcript. The system populates the address fields based on the address type you select. This field is available when you select the Send to Student check box.
Specify External Org ID (specify external organization ID)	Select to choose an existing external organization. The system makes the Org ID and Location Nbr fields available.
Org ID (organization ID)	This field becomes available when you select the Specify External Org ID check box. Select the organization to which you are sending the electronic transcript. Define external organizations on the Organization Table page. When you exit this field, the system automatically populates the Send to field with the organization's name.

Field or Control	Description
Location Nbr (location number)	This field becomes available when you select the Specify External Org ID check box. Select the location number of the organization to which you are sending the electronic transcript. Define location numbers for external organizations on the Organization Location page. When you exit this field, the system automatically populates the address fields with the location address.
Send to	Enter the name of the recipient to whom you are sending the electronic transcript. If you select either the Send to Student check box or the Specify External Org ID check box, then this value populates automatically according to your selection. This value can be overwritten.
Country	Select the country of the recipient's address. When you exit this field, the system displays the address format associated with that country.
Edit Address	Click to enter a different address to which you want to send this transcript.

Entering Send Options

Access the Send Options page (**Records and Enrollment > Transcripts > Electronic Transcripts > Electronic Transcript Request > Send Options**).

Field or Control	Description
Send Options	Select the method that you want to use to send the TS130 file. Select <i>E-Mail</i> if you want to send the electronic transcript by email. The system sends the output file as soon as you run the Transcript Request process. Select <i>Place File in Directory</i> to enable you to transfer the file at a later time by using a file transfer protocol, such as the FTP.
E-Mail Address	Enter a valid email address to which the system sends the transcript.
File Name	The generated file name appears after processing. The naming convention is defined on the TS130 Setup page. The system inserts the control number before the file extension to identify unique files.

Field or Control	Description
Output File Path	<p>Insert the file path to which the system writes the TS130 file at the time it is generated. The system displays this value by default from the TS130 Setup page (or the Organization TS130 Setup page if the send to address is an organization with information in the Org TS130 Setup page). Users must have write permission for this specified directory to prevent runtime errors.</p> <hr/> <p>Note: Regardless of your send option, you need to specify a directory to store the TS130 file because the email process picks the file up as an attachment and sends it by email from this directory. For example, you could use c:\temp\.</p> <hr/>
E-Mail Message	Enter free-form text that will appear in the body of the email.

Note: You can set up defaults for the **Send Options**, **E-Mail Address**, and **Output File Path** fields on the Organization TS130 Setup page.

Viewing Electronic Transcript Request History for a Student

Access the Request History page (**Records and Enrollment > Transcripts > Electronic Transcripts > Electronic Transcript Request > Request History**).

Field or Control	Description
DateTime	Displays the date and time of the action performed on this request.
Name	Displays the user name of the user performing the action.
File Name	Displays the unique file name.
Action	Displays the various actions performed on this request. Values include <i>Generate</i> , <i>Batch Generate</i> , <i>E-Mail</i> , and <i>Batch E-Mail</i> .
TS131 Status	Displays the status of any incoming TS131 acknowledgements that have been processed for this request. Values include <i>Confirm</i> and <i>Reissue</i> .
TS131 Processed	Displays the date on which the sender processed the TS131 inbound file.

Producing Electronic Transcripts in Batch

This section provides an overview of producing electronic transcripts in batch and discusses how to:

- Generate electronic transcripts in batch.
- Send electronic transcripts in batch by email.
- Enter a text message on the request.

Understanding Producing Electronic Transcripts in Batch

The Generate Electronic Transcript page enables you to generate previously created TS130 requests that you saved through the Electronic Transcript Request page. The process combines transcripts from multiple requests when the requests specify the same recipient. This component is ideal for generating electronic transcripts requested for release on future dates or following specific events.

For example, students can request future release of their transcripts based on degree confer date, term grade posting date, transfer credit posting date, or a date you specify. When the future date arrives, you can access the Generate Electronic Transcript page, enter the transcript type that you want the system to process, enter a single date or a range of process dates, and generate the TS130 files. For example, if a student knows in March that he or she needs a transcript sent electronically to a specific institution on June 15, the date of graduation, he or she can enter this request and save it online in March with a future date of June 15 on the Transcript Request page. On June 15, they system can process this request through the Generate Electronic Transcript page and can generate this student's transcript electronically, along with all other requests scheduled for processing on this date.

After you run the process through the Generate Electronic Transcript page, you can access the TS130 files in the output directory indicated on the request, and you can send these files by email, in batch, through the E-Mail Electronic Transcript page. On the E-Mail Electronic Transcript page, enter the same run control that you used in the Generate Electronic Transcript process. Only those requests with a send option of email will appear. The batch generation process groups requests by email address and directory, thus forming virtual envelopes that can include several students' transcripts.

Pages Used to Produce Electronic Transcripts in Batch

<i>Page Name</i>	<i>Definition Name</i>	<i>Navigation</i>	<i>Usage</i>
Generate Electronic Transcript	RUNCTL_E_SRTSCPRT	Records and Enrollment > Transcripts > Electronic Transcripts > Generate Electronic Transcript > Generate Electronic Transcript	Generate previously created TS130 transcript requests that you saved through the Electronic Transcript Request page.
E-Mail Electronic Transcript	EMAIL_TS130	Records and Enrollment > Transcripts > Electronic Transcripts > EMail Electronic Transcript > EMail Electronic Transcript	Email TS130 requests in batch.

Page Name	Definition Name	Navigation	Usage
Transcript E-Mail Detail	EMAIL_TS130_SBP	Click the Notes and Details link on the Email Electronic Transcript page.	Enter a message to be delivered in the body of the email. This message overwrites the email messages for each individual request within this file.

Generating Electronic Transcripts in Batch

Access the Generate Electronic Transcript page (**Records and Enrollment > Transcripts > Electronic Transcripts > Generate Electronic Transcript > Generate Electronic Transcript**).

Field or Control	Description
Academic Institution	Select the institution that the system should use in the process. Institution values are defined on the Academic Institution Table page.
Transcript Type	Select the transcript type. Transcript type values are defined on the Transcript Type - Basic Data page. Be sure you select a transcript type that matches the pending requests that you want to generate.
From and Through	Enter the range of dates for which you want to generate electronic transcripts. To generate electronic transcripts for one day, enter the same date in both fields.

Sending Electronic Transcripts in Batch by Email

Access the EMail Electronic Transcript page (**Records and Enrollment > Transcripts > Electronic Transcripts > EMail Electronic Transcript > EMail Electronic Transcript**).

Field or Control	Description
EMail	Select this check box if you want the process to send this file. Clear this check box for any row that has a file that should not be sent at this time.
TS130 Control	Enter the date the TS130 was generated.
E-Mail Address	Enter the email address of the recipient.
File Name	Enter the generated file name of the TS130.

<i>Field or Control</i>	<i>Description</i>
File Path	Enter the file path where the file is located and will be picked up as an attachment in the email.
Notes and Details	<p>Click to access the Transcript E-Mail Detail page, where you can view the requests that are included in each flat file and the history of each request. You can also enter text that will be delivered in the body of the email.</p> <hr/> <p>Note: The email text entered here overwrites email message text on the request.</p> <hr/>

Entering a Text Message on the Request

Access the Transcript E-Mail Detail page (click the **Notes and Details** link on the Email Electronic Transcript page).

<i>Field or Control</i>	<i>Description</i>
Message	Enter a message to be delivered in the body of the email. This message overwrites the email message for each individual request within this file.

Note: If you rerun the Generate Electronic Transcript process, the system deletes all email records under that run control value and creates new records.

Reviewing TS130 Outbound Transactions

The Electronic Transcript Query enables you to see the status of various electronic transcript requests based on the user who entered the request, student ID, request date, process date, or request status.

This section discusses how to review transcript request data.

Page Used to Review TS130 Outbound Transactions

<i>Page Name</i>	<i>Definition Name</i>	<i>Navigation</i>	<i>Usage</i>
Electronic Transcript Query	TRANSCRIPT_QUERY	Records and Enrollment > Transcripts > Electronic Transcripts > Electronic Transcript Query > Electronic Transcript Query	View the status of various electronic transcript requests.

Reviewing Transcript Request Data

Access the Electronic Transcript Query page (**Records and Enrollment > Transcripts > Electronic Transcripts > Electronic Transcript Query > Electronic Transcript Query**).

Field or Control	Description
User ID	Enter the user ID of the person who completed the request if you want to view requests created by a single user.
Student ID	Enter the student ID if you want to view requests for a specific student.
Date From	Enter dates in the From and Through fields to view electronic transcript requests with request date values within a certain date range. These two fields can contain the same date.
Process Date Range	Enter dates in the From and Through fields to view electronic transcript requests with process date values within a certain date range. Process date values are specified in the Date Processed field on the Transcript Request page.
Request Status	Select a request status to filter the status of requests you want to view. Values include: <i>Acknowledgement Received, Completed, Generated, On Request, and Reissue Requested.</i>
Fetch	Click to retrieve the results of your inquiry.
Go to Request	Click to go to the Electronic Transcript Request component for this request.

Processing TS131 Inbound Files

This section provides an overview of TS131 inbound files and discusses how to download TS131 files.

Understanding TS131 Inbound Files

Institutions that receive TS130 Electronic Transcripts from you should send back to you a Student Educational Record (Transcript) Acknowledgement, or TS131, file. This file confirms that the recipient received the record, and it ensures that the recipient received certain key elements as they were sent.

This process reconciles TS131 inbound files with individual electronic transcript requests. The process updates the Request History page in the Electronic Transcript Request component to indicate that it was successfully received or that the request needs to be reissued. You can query on which requests must be reissued through the Electronic Transcript Query page. Additionally, the Generate Electronic Transcript process also regenerates requests marked as Reissue.

Page Used to Process TS131 Inbound Files

<i>Page Name</i>	<i>Definition Name</i>	<i>Navigation</i>	<i>Usage</i>
Download TS131	RUNCTL_TS131_DWNLD	Records and Enrollment > Transcripts > Electronic Transcripts > Download TS131 > Download TS131	Download TS131 files.

Downloading TS131 Files

Access the Download TS131 page (**Records and Enrollment > Transcripts > Electronic Transcripts > Download TS131 > Download TS131**).

<i>Field or Control</i>	<i>Description</i>
Single File	Select this option to process a single file. The File Name field appears.
File List Driven	Select this option to process a list of files. Enter the name of the file that contains a list of files that you want to process in the File Name field.
Directory	Enter the name of the file if you selected the Single File or File List Driven option.
File Pattern	Enter the pattern of the file names that you want to process. For example, enter <i>*.txt</i> to process all text files in the directory that you specified. This field appears if you selected the Directory option.
Input/Output file	Enter the path to the file or files that you want to process.

Note: You must enter the final slash in the file path.

Reviewing Student Transcript Request History

This section lists a prerequisite and discusses how to run a transcript request query.

Prerequisite

Before you can search for a transcript request history, you must first have made at least one transcript request for a student.

Page Used to Review Student Transcript Request History

<i>Page Name</i>	<i>Definition Name</i>	<i>Navigation</i>	<i>Usage</i>
Transcript Request Inquiry	SSR_TSRQST_INQ	Records and Enrollment > Transcripts > Transcript Request Inquiry > Transcript Request Inquiry	List all of the transcript requests for a specific student.

Running a Transcript Request Query

Access the Transcript Request Inquiry page (**Records and Enrollment > Transcripts > Transcript Request Inquiry > Transcript Request Inquiry**).

<i>Field or Control</i>	<i>Description</i>
Academic Institution	Select the institution for which the transcript was generated. Institution values are defined on the Academic Institution Table page.
Transcript Type	Select the transcript type. Transcript type values are defined on the Transcript Type - Basic Data Page.
Student ID	Enter the ID for the student whose transcript request history you want to review.
Flexible Transcript	Select this check box to search for dynamically created transcripts only.
Search	When you click this button, the system displays transcript requests that meet the selection criteria you selected.

Purging Transcripts

Important! The COBOL transcript process is a deprecated product. It is strongly recommended that you use the Application Engine transcript process instead. For more information on the Application Engine transcript process, see [Understanding Transcript-Related Processes](#).

This section lists a prerequisite and discusses how to purge transcript reports.

To purge transcripts, use the Purge Transcript Reports component.

Note: The Transcript Purge (RUNCTL_SRTRPURG) component still exists in the system. Use this component to purge COBOL based transcripts.

Prerequisite

Before you can purge transcript requests and transcripts, you must create transcript requests.

Page Used to Purge Transcripts

<i>Page Name</i>	<i>Definition Name</i>	<i>Navigation</i>	<i>Usage</i>
Purge Transcript Reports	SSR_RC_TSRPT_PURGE	Records and Enrollment > Transcripts > Purge Transcript Reports > Purge Transcript Reports	Purge transcript requests, including transcript results, if any. The system purges all transcript reports within the parameters that you specify.

Purging Transcript Reports

Access the Purge Transcript Reports page (**Records and Enrollment > Transcripts > Purge Transcript Reports > Purge Transcript Reports**).

Note: You can enter any or all of the parameters on the page to select the appropriate transcript reports to purge.

<i>Field or Control</i>	<i>Description</i>
Purge All Results	Select this option to purge all results. Warning! Selecting the Purge All Results option will override the Freeze Record flag set on the report request record and will delete all data from the results tables. If you also select the Purge Report Requests and Logs option, all associated request records will also be purged, even if the Freeze Record flag is set.
Select Results to Purge	Select this option to purge by transcript type parameter, date range, or user ID selection.
Purge Report Requests and Logs	When this option is selected, the transcript requests that all information associated with the request will be deleted. Requests will not appear on the Transcript Request Inquiry after the process runs.
Academic Institution	Enter the institution for which you want to purge transcripts. This value determines the availability of transcript types in the Transcript Type field.
Transcript Type	Enter the transcript type for which you want to purge transcripts.

Field or Control	Description
Request Date From and Request Date To	Enter values that specify purge parameters. The system purges transcript requests created on and including these dates. The request date is the date that the transcript request number is created.
Request Print Date From and Request Print Date To	Enter values that specify purge parameters. The system purges transcript requests printed on and including these dates. The request print date is not a literal definition. The request print date refers to the date on which the transcript is generated and available for printing. For online transcript requests, this value is provided by the value in the Print Date field on the Transcript Request Header page. For batch transcript requests, this date is the date that the transcript is generated.
Request User ID	Select an ID from your user ID list. The system purges transcript requests and print requests initiated by this user.

Click **Run** to run this request. PeopleSoft Process Scheduler runs the Purge Transcript Reports process at user-defined intervals.

Using Self-Service Transcripts

If your institution has licensed PeopleSoft Campus Self Service, your students can request official and unofficial transcripts through self-service pages. See “Understanding Self-Service Student Center” (Campus Self Service)

Consolidating and Reporting Academic Statistics

Understanding Consolidating and Reporting Academic Statistics

With the Consolidate Academic Statistics process (SRPCCONP), you can capture demographic and statistical information about your students, reporting these students under one primary academic career and program for a statistical period of time. If a student is active in multiple academic careers or programs within one or more terms of an academic statistics period, the process combines the student's academic career, program, level, and load information, based on the student's academic career and program that have the lowest primacy number. Your institution can report each student under one academic career and program for a statistical period of time and have the multiple academic level, load, and other statistics consolidated. You can then use these consolidated academic statistics to meet reporting requirements—such as Integrated Postsecondary Education Data System (IPEDS) and National Student Clearinghouse (NSC).

After your institution completes the prerequisite setup for consolidating and reporting academic statistics, you are ready to capture and consolidate academic statistics for students who are active in terms at the academic institution for a given academic statistics period. You can, through the Consolidated Statistics page, run three COBOL/SQL processes:

- Take Term Statistics Snapshot (SRPCCONA).
- Recurring Term Snapshot (SRPCCONU).
- Consolidate Academic Statistics (SRPCCONP).

Important! To gather statistics that reflect different times of the year, you must run the Recurring Term Snapshot process (SRPCCONU) and the Consolidate Academic Statistics process (SRPCCONP) on a regular basis because the statistics themselves are based on the run date, not on the snapshot date. The processes use the snapshot date to locate the valid academic career and term combinations to include in the calculations.

After you have run the Consolidate Academic Statistics process (SRPCCONP) and are satisfied with the statistical results, you can then create reports based on the calculations found in the consolidated statistics table. Campus Solutions provides reporting features—such as NSC—that use the Consolidate Academic Statistics process results. Or you can create other reports to meet the needs of your institution. This documentation discusses the delivered reporting features.

Related Links

[Understanding Consolidate Academic Statistics Process Calculations](#)
[Performing Academic Statistics Consolidation](#)

Understanding Consolidated Statistics Processes

Before you run any of the consolidated statistics processes, it is important to understand when to use each process and how each process functions. This section summarizes each process, describes the common functionality shared between the processes, and outlines how each application process functions.

Take Term Statistics Snapshot Process

The Take Term Statistics Snapshot process (SRPCCONA) takes a term snapshot of every academic career and term combination listed in the grid in the lower portion of the Consolidated Statistics process page, where the snapshot date is less than or equal to the system date. The process considers as valid only the academic career and term combinations listed on the Academic Statistics Period page for the academic statistics period for which you run the process.

Run the process only when the consolidation trigger for the given academic statistics period is set to *Consolidation Date*. With such a consolidation trigger, this process is a precursor to running the Consolidate Academic Statistics process (SRPCCONP).

The process stores results in a temporary holding table (PS_STDNT_CARTRM_PD) for future use. This table has no corresponding page in which to view the stored data. There may be several rows of information in this table for one student per academic statistics period, depending on the academic career, term, and snapshot date combination. For example, on the Academic Statistics Period page, you might have set the following snapshot dates:

<i>Academic Career</i>	<i>Term</i>	<i>Snapshot Date</i>
BUSN	0505 (fall semester 2003)	09/20/03
BUSN	0518 (spring semester 2004)	02/01/04
LAW	0507 (fall quarter 2003)	09/15/03
LAW	0512 (spring quarter 2004)	01/30/04

Suppose that student A is in both the BUSN and LAW academic careers. In this scenario, after all term snapshots have been run, there will be four rows for student A in the temporary holding table PS_STDNT_CARTRM_PD.

Whenever you select *Consolidation Date* as your consolidation trigger for the academic statistics period, you must run two processes—the Term Snapshot process and the Consolidate Academic Statistics process. With such a consolidation trigger, the Consolidate Academic Statistics process consolidates all of a student's data that is found in the temporary holding table for a specific academic statistics period, calculating only one row of data for each student within an academic statistics period. The Consolidate Academic Statistics process writes these results to the consolidated statistics table (PS_STDNT_CONS_STAT). You can view many of the results from the Consolidate Academic Statistics process in the Student Consolidated Statistics component.

Note: You must use the Consolidation Date consolidation trigger for statistics periods that you create for NSC reporting. The term snapshot data provided by the SRCCONA process is also used to derive NSC program level data (this is written to the PS_SSR_STD_CON_ST2 table). See "Consolidate Academic Statistics Process: Deriving Program Level Data for NSC Reporting."

Consolidate Academic Statistics Process

The Consolidate Academic Statistics process (SRPCCONP) combines all of a student's valid academic statistics into one consolidated record.

You must run the Consolidate Academic Statistics process for every academic statistics period, regardless of the consolidation trigger for the academic statistics period. For academic statistics periods where the consolidation trigger is set to *Consolidation Date*, you must first run either the Take Term Statistics Snapshot process (SRPCCONA) or the Recurring Term Snapshot process (SRPCCONU) for all academic career, term, and snapshot date combinations of an academic statistics period before running the Consolidate Academic Statistics process. For academic statistics periods where the consolidate trigger is set to *As of Date* or *As of Today*, you need run only the Consolidate Academic Statistics process. The Consolidate Academic Statistics process uses the SRPCCONS program to calculate results, which the system then stores in the PS_STDNT_CONS_STAT table.

Regardless of the consolidation trigger for your academic statistics period, when a student is active in more than one academic career and academic program during the same academic statistics period, the Consolidate Academic Statistics process locates the student's primary academic career and program in two ways: by the academic careers and programs in which the student is active, and by the primacy number on the academic career and program. Because many federal and state reports require that you count students under one academic career and program even if the student is actively enrolled in more than one, the process combines all of the academic level, load, career, and program information for each student, based upon the primacy number you give to the academic career and program. The process reports the student based upon the student's academic career and program that has the lowest primacy number at the institution.

For information about NSC program level reporting, see "Consolidate Academic Statistics Process: Deriving Program Level Data for NSC Reporting."

Important! You should run the Consolidate Academic Statistics process at night, during the weekend, or at any other time with reduced demands on the system.

Consolidate Academic Statistics Process: Deriving Program Level Data for NSC Reporting

To meet NSC reporting requirements, institutions must report *program level* data for each student where the program level indicator (SSR_NSC_PRG_IND) is set to *Yes*. If a student is pursuing multiple programs, an institution must report enrollment data by program in addition to overall (per student) enrollment status related data. NSC program level data is equivalent to Campus Solutions Academic Plan data.

See [Setting Up For NSC Program Level Reporting](#)

The Consolidated Academic Statistics process derives program level data for students selected in an academic statistics period for which the **NSC Report** check box is selected on the Academic Statistics Type page and the **Consolidation Trigger** value is equal to *Consolidation Date* on the Academic Statistics Period page.

See [Setting Up Statistic Period Types](#)

See [Setting Up Academic Statistics Periods](#)

Program level data is written to the SSR_STD_CON_ST2 table and provides the source for the NSC extract program data. The table can capture a maximum of six sets of program level data. How many sets of program data are reported depends on the number of careers that have been consolidated for the statistics period and the number of eligible academic plans within those careers.

See [Understanding Consolidate Academic Statistics Process Calculations](#)

Consolidate Academic Statistics Process: Excluding Grades from Academic Load Calculation for NSC Reporting

The following information discusses how academic load is calculated if you use grade exclusions for NSC Reporting.

You can exclude units that are counted towards STDNT_CAR_TERM progress, based on grade definition, from the NSC load calculation.

The grade exclusions, which are defined on the Academic Statistics Type page, are used by the Consolidated Academic Statistics (SRPRCONP) process to exclude units from the total units used to calculate a student's academic load for a statistics period.

See [Setting Up Statistic Period Types](#).

This exclusion feature is specific to load calculations performed as part of the Consolidated Academic Statistics process.



Note: If you use exclusions, it is likely that some students—those with units excluded from calculation based on a grade (or grades)—will have a different academic load reported in Consolidated Statistics than the load calculated for the same term in STDNT_CAR_TERM. You should be aware that a higher or lower load might be reported to the NSC based on grade definition and the grade exclusion rules that you create.





Here is an example:

- On the Academic Statistics Type page, for Statistics Period Type of N, the Exclude Withdrawal Grades grid indicates that grades of WF are to be excluded when calculating academic load for a statistics period.

A student has this enrollment data for the Spring 2011 term:

Level / Load	
Academic Level - Projected:	Freshman
Academic Level - Term Start:	Freshman
Academic Level - Term End:	Freshman
Approved Academic Load:	Full-Time
Academic Load:	Enrolled Full-Time

Classes		
 Enrolled	 Dropped	 Wait Listed

Class	Description	Units	Grading	Grade	Status
ART 112-1 (1006)	History of World Art (Lecture)	3.00	Graded	WF	
ECON 1-1 (1554)	Introduction to Economics (Lecture)	3.00	Graded		
PHILO 150-1 (1526)	Intro to Logic (Lecture)	3.00	Graded	WF	
PHILO 205-1 (1030)	Elementary Logic (Lecture)	3.00	Graded	WF	
SOC 104-FA2 (2173)	American Race Relations (Lecture)	4.00	Graded		

- There are 16 units and 9 of these units have been dropped for penalty grades of WF. At PSUNV, the WF grade is included in a student's progress units, for load calculation and GPA purposes.
- Although the student's term load (as calculated in STDNT_CAR_TERM) is *full-time* (based on 16 units), if this student's record was evaluated by the Consolidated Academic Statistics process (with the grade exclusion rules defined as outlined above), the load would be calculated in the following way:
 - Number of enrolled units for reporting period is 16.00.
 - Number of units to be excluded based on Academic Statistics Type exclusion rule is 9.00 (3 x 3 units with grade of WF).
 - Total units for Load Calculation is 7.00. This is the number of units that is passed from SRPCCONP into SRPCCALC.cbl for getting the NSC load.

- Academic Load (according to Load rule) is *half-time*.

The following information discusses how the NSC Enrollment Status Change Date is calculated when the academic load changes as a result of grade exclusion.

In order to report an accurate NSC Enrollment Status Change Date, the Consolidated Statistics process evaluates the drop date based on a student's enrollment record (STDNT_ENRL.DROP.ENRL_DROP_DT) when processing grade exclusions.

This allows the reporting of a date on which the student's term record (STDNT_CAR_TERM.UNTPRG_CHG_NSLC_DT) might not necessarily reflect a change in load.

Here is an example:

- In the scenario described above, the student has dropped 3 classes, with each drop resulting in penalty grade of WF. Because the units associated with this grade are counted towards the student's progress units, there is no change in the student's progress units, and therefore the STDNT_CAR_TERM.UNTPRG_CHG_NSLC_DT value for the term remains null.
- Although the units value does not change, a drop date is captured on the student's enrollment record.
- Because the WF grades are excluded from NSC load calculation, the process reports a reduced load for the student (half-time in this case) and therefore has to report a status change date.
- The process evaluates the classes with the *excluded* grades and uses the latest drop date as the Enrollment Status Change Date (STDNT_CONS_STAT.ENRL_STAT_CHG_DT).

Common Functionality Shared Between Processes

Before you run any of the consolidated statistics processes, it is important to understand how the processes locate which student data to include in their results. First, the processes locate the valid academic career and term combinations that are in progress as of the snapshot date. After the processes locate the valid academic career and term combinations, they gather all of the career-term records for students active in these academic career and term combinations, excluding any student who has completed their degree, except within the student's degree completion term. After the processes gather the applicable student career-term records, they further gather these students' enrollment records and compare the start and end dates for all classes in which the student is actively enrolled to the snapshot date to determine if a student's class units should count towards her or his academic level and load calculation. For example, the process excludes a student's class units if the student has enrolled in the class for a future session. This structure assists nonterm-based institutions in identifying a student's status at any given point in time, such as a student's primary academic program, primary academic career, term, academic level, academic load, and current and cumulative career-term statistics.

Flow Chart of Consolidated Statistics Processes

The following diagram illustrates when to run the Consolidate Academic Statistics process (SRPCCONP) and the Take Term Statistics Snapshot process (SRPCCONA) and, when initiated, how these processes function:

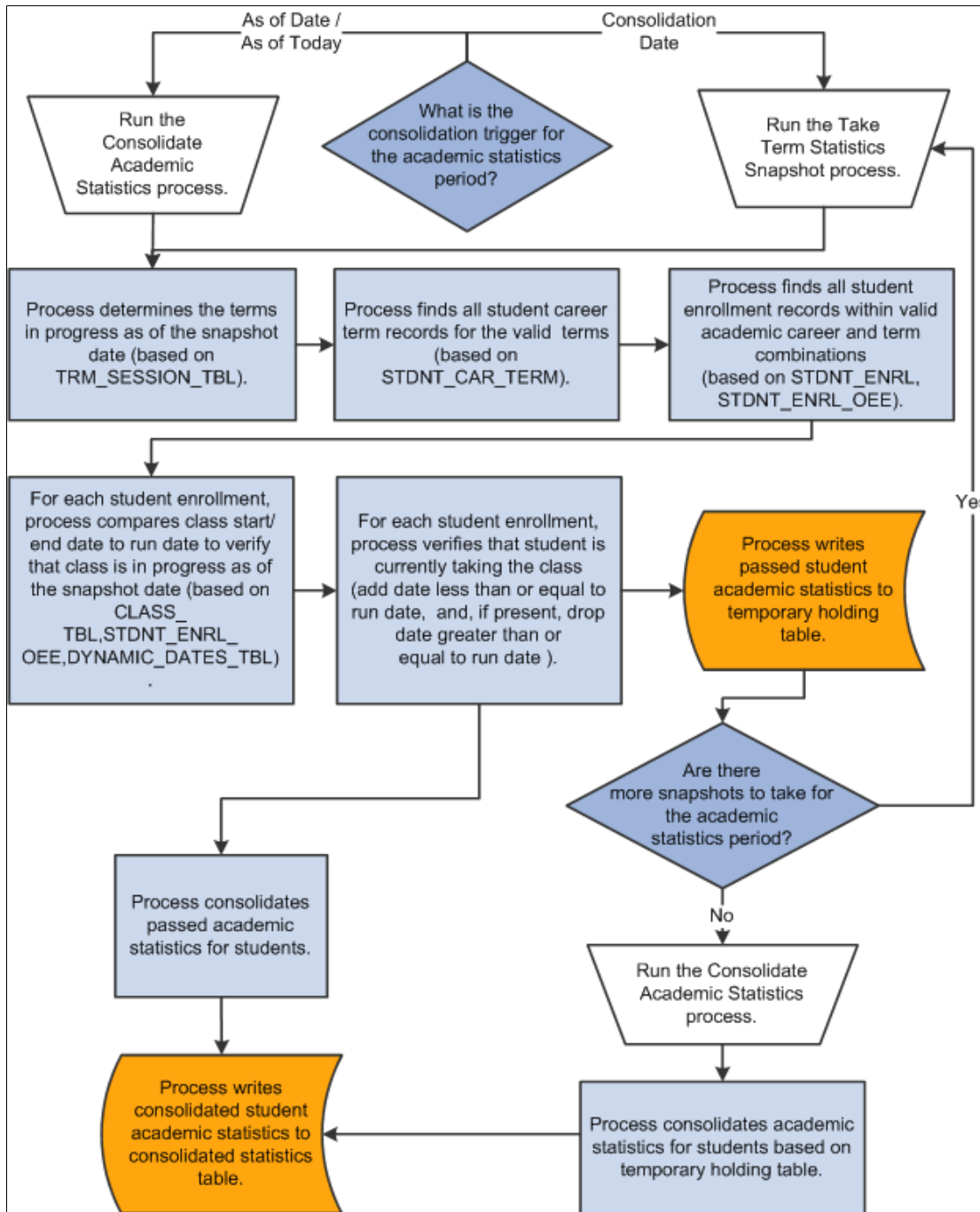

Understanding Consolidate Academic Statistics Process Calculations

After you run the Consolidate Academic Statistics process (SRPCCONP), the system stores the results (except for NSC program level data) in the Consolidated Statistics table (PS_STDNT_CONS_STAT). National Student Clearinghouse (NSC) program level data is stored in the SSR_STD_CON_ST2 table. See [Understanding Consolidated Statistics Processes](#)

You can access the statistics stored in the PS_STDNT_CONS_STAT table for a specific student through the Student Consolidated Stats component, for a group of students through the Mass Consolidated Statistics component, or through SQL select statements when you query the database.

The PS_STDNT_CONS_STAT table contains over a hundred data elements and only the most vital are available for inquiry online (which statistics are available is decided based on the guidelines of federal reports such as NSC, IPEDS and IRS, and feedback from clients).

Use the following table to view the logic behind how the SRPCCONS program, which is part of the Consolidate Academic Statistics process (SRPCCONP), calculates each student's consolidated academic statistics. The table lists the fields found in the PS_STDNT_CONS_STAT table in the order in which they appear in the record definition, and explains the related logic.

Field	Logic
EMPLID (EmplID)	Populated from the corresponding field on the STDNT_CAR_TERM record for the student's primary academic program.
INSTITUTION (Academic Institution)	Originated from input through the Consolidated Statistics process page.
ACAD_STATS_PERIOD (Academic Statistics Period)	Originated from input through the Consolidated Statistics process page.
CONS_STATUS (Consolidation Status)	Result of the Consolidate Academic Statistics process (SRPCCONS). If successful, then the program logic sets the status to S (success).

Field	Logic
ACAD_CAREER (Academic Career)	<p>Populated from the corresponding field on the STDNT_CAR_TERM record.</p> <p>If the academic statistics period has <i>As of Date</i> or <i>As of Today</i> (system date) for its trigger, then that date triggers the cut-off for the admit term.</p> <p>If the academic statistics period has <i>Consolidation Date</i> for its trigger, then that date triggers the cut off for the admit term (same as the <i>As of Date</i> or <i>As of Today</i> trigger).</p> <p>If more than one academic career passes these criteria, then the program logic locates the active academic career.</p> <p>If two academic careers are active on the same date, then the program logic looks at the primacy number. The lowest number takes precedence.</p> <p>If the academic careers have the same primacy number, then the program logic will compare the effective dates (EFFDT). The later date takes precedence.</p>
STRM (Term)	<p>Populated with values from the corresponding field on the STDNT_CAR_TERM record.</p> <p>If the academic statistics period has <i>As of Date</i> or <i>As of Today</i> for its trigger, then the program logic reports the term from the student's primary academic program.</p> <p>If the academic statistics period has <i>Consolidation Date</i> for its trigger, then the program logic reports the term from the student's primary academic program in relation to the consolidation as of date. For example, if you take snapshots for terms 0330, 0350, and 0370 but your consolidation as of date falls within term 0350, then the program logic reports term 0350.</p>
WITHDRAW_CODE (Withdrawal/Cancel)	Populated with values from the corresponding field on the STDNT_CAR_TERM record based on the student's primary academic program.
WITHDRAW_REASON (Withdrawal/Cancel Reason)	Populated with values from the corresponding field on the STDNT_CAR_TERM record based on the student's primary academic program.
WITHDRAW_DATE (Withdrawal/Cancel Date)	Populated with values from the corresponding field on the STDNT_CAR_TERM record based on the student's primary academic program.
LAST_DATE_ATTENDED (Last Date of Attendance)	Populated from the corresponding field on the STDNT_CAR_TERM record based on the student's primary academic program.

Field	Logic
STDNT_CAR_NBR (Student Career Number)	Populated from the corresponding field on the STDNT_CAR_TERM record based on the student's primary academic program.
ACAD_PROG_PRIMARY (Primary Academic Program)	Calculated from the corresponding field on the STDNT_CAR_TERM record. If a student has two or more active academic programs, the program logic calculates the primary academic program according to the primacy value of the academic programs. It is the calculated academic program that will be reported.
ACAD_LOAD_APPR (Approved Academic Load)	Populated from the corresponding field on the STDNT_CAR_TERM record.
ACADEMIC_LOAD (Academic Load)	<p>Computed by the SRPCRULE/SRPCLOAD process based on units in progress and using academic load rules according to the academic statistics period.</p> <p>See the logic description for the OVRD_ACADEMIC_LOAD field.</p> <hr/> <p>Note: If you use grade exclusions for NSC Reporting, the SRPCCONP process excludes units from the total units used to calculate a student's academic load for a statistics period, based on the grade exclusions defined at the Statistics Type level.</p> <hr/> <p>See Understanding Consolidated Statistics Processes.</p>
OVRD_ACADEMIC_LOAD (Override Academic Load)	The system sets this field value to <i>N</i> , indicating that the Academic Load field (ACADEMIC_LOAD) contains the value of the calculated academic load (ACADEMIC_LOAD_CL). You can override the calculated academic load (ACADEMIC_LOAD_CL) by selecting the Override Academic Load check box (OVRD_ACADEMIC_LOAD) in the Mass Consolidated Statistics component or on the Basic Data page in the Student Consolidated Stats component, then selecting a new value for the Academic Load field (ACADEMIC_LOAD). Selecting this check box sets the OVRD_ACADEMIC_LOAD field value to <i>Y</i> .

Field	Logic
ACADEMIC_LOAD_CL (Academic Load Calculated)	<p>Computed by the SRPCRULE/SRPCLOAD process, based on units in progress and using academic load rules according to the academic statistics period.</p> <p>See the logic description for the OVRD_ACADEMIC_LOAD field.</p> <hr/> <p>Note: If you use grade exclusions for NSC Reporting, the SRPCCONP process excludes units from the total units used to calculate a student's academic load for a statistics period, based on the grade exclusions defined at the Statistics Type level.</p> <hr/> <p>See Understanding Consolidated Statistics Processes.</p>
FA_LOAD (Financial Aid Load)	<p>Computed by SRPCRULE/SRPCLOAD.</p>
ACADEMIC_LOAD_NSLC (NSC Academic Load)	<p>Calculated from units in progress and using NSC academic load rules (PS_ACAD_LOAD2_TBL) according to the academic statistics period. You can override the calculated result by selecting the Override Academic Load check box in the Mass Consolidated Statistics component or on the Basic Data page in the Student Consolidated Stats component, then selecting a new value for this field.</p> <hr/> <p>Note: If you use grade exclusions for NSC Reporting, the SRPCCONP process excludes units from the total units used to calculate a student's academic load for a statistics period, based on the grade exclusions defined at the Statistics Type level.</p> <hr/> <p>See Understanding Consolidated Statistics Processes.</p>
ACAD_LOAD_NSLC_CL (NSC Academic Load Calculated)	<p>Calculated from units in progress and using NSC academic load rules (PS_ACAD_LOAD2_TBL) according to the academic statistics period.</p> <hr/> <p>Note: If you use grade exclusions for NSC Reporting, the SRPCCONP process excludes units from the total units used to calculate a student's academic load for a statistics period, based on the grade exclusions defined at the Statistics Type level.</p> <hr/> <p>See Understanding Consolidated Statistics Processes.</p>
ACAD_LEVEL_PROJ (Academic Level - Projected)	<p>Computed by SRPCRULE/SRPCVL.</p>

Field	Logic
ACAD_LEVEL_PROJ_CL (Academic Level Proj Calculated)	Computed by SRPCRULE/SRPCLVL.
ACAD_LEVEL_BOT (Academic Level - Term Start)	Computed by the SRPCRULE/SRPCLVL process based on cumulative units and using the academic level rules according to the Academic Level Table page.
ACAD_LEVEL_BOT_CL (Academic Level BOT Calculated)	Computed by the SRPCRULE/SRPCLVL process based on cumulative units and using the academic level rules according to the Academic Level Table page.
ACAD_LEVEL_EOT (Academic Level - Term End)	Computed by SRPCRULE/SRPCLVL. See the logic description for the OVRD_ACAD_LVL_ALL field.
ACAD_LEVEL_EOT_CL (Academic Level EOT Calculated)	Computed by SRPCRULE/SRPCLVL. See the logic description for the OVRD_ACAD_LVL_ALL field.
ACAD_LEVEL_IPEDS (IPEDS Academic Level)	Calculated from cumulative units at the end of the term or using academic level and IPEDS academic level mapping according to the Level/Load Rules Table page. You can override the calculated result by selecting the Override All Academic Levels check box in the Mass Consolidated Statistics component or on the Basic Data page in the Student Consolidated Stats component, then selecting a new value for this field. See the logic description for the OVRD_ACAD_LVL_ALL field.
ACAD_LEVEL_IPED_CL (IPEDS Academic Level Calculated)	Calculated from cumulative units and using academic level and IPEDS academic level mapping according to the Level/Load Rules Table page. See the logic description for the OVRD_ACAD_LVL_ALL field.
SSR_NSC_CRD_LVL (NSC Class Credential Level)	Consolidate Academic Statistics reports the NSC Classification from the Academic Plan Table. If the process finds a NSC Classification value of Bachelor's Degree in the Academic Plan Table component, then, based on the calculated academic level, it retrieves the appropriate NSC Level Category value.
SSR_NSC_CRD_LVL_CL Calculated NSC Class Credential Level	See the logic description for SSR_NSC_CRD_LVL

Field	Logic
SSR_OVRD_NSC_CRLVL (Override Calculated NSC Class Credential Level)	The system sets this field value to N, indicating that the NSC Class Credential Level field (SSR_NSC_CRD_LVL) contains the value of the calculated class credential level (SSR_NSC_CRD_LVL_CL). To override the calculated class credential level, select the Override NSC Class Credential Level check box (SSR_OVRD_NSC_CRLVL) in the Mass Consolidated Statistics component or on the Basic Data page in the Student Consolidated Stats component, then select a new value for the NSC Class Credential Level field. Selecting the check box sets the SSR_NSC_CRD_LVL_CL field value to Y.
NSLDS_LOAN_YEAR (NSLDS Loan Year)	Computed by SRPCRULE/SRPCLVL.
OVRD_ACAD_LVL_PROJ (Override Projected Level)	Populated from the corresponding field on the STDNT_CAR_TERM record.
OVRD_ACAD_LVL_ALL (Override All Academic Levels)	<p>Populated from the corresponding field on the STDNT_CAR_TERM record.</p> <p>The system sets this field value to N, indicating that the IPEDS Academic Level field (ACAD_LEVEL_IPEDS) and the Academic Level - Term End field (ACAD_LEVEL_EOT) contain the value of the respective calculated academic levels (ACAD_LEVEL_IPED_CL and ACAD_LEVEL_EOT_CL).</p> <p>You can override the calculated academic levels (ACAD_LEVEL_IPED_CL) and (ACAD_LEVEL_EOT_CL) by selecting the Override Units For Progress check box (OVRD_ACAD_LVL_ALL) in the Mass Consolidated Statistics component or on the Basic Data page in the Student Consolidated Stats component, then selecting a new value for the IPEDS Academic Level field (ACAD_LEVEL_IPEDS) and Academic Level - Term End field (ACAD_LEVEL_EOT).</p> <p>Selecting this check box sets the OVRD_ACAD_LVL_ALL field value to Y.</p>
ELIG_TO_ENROLL (Eligible to Enroll)	Populated from the corresponding field on the STDNT_CAR_TERM record.
UNT_TAKEN_PRGRSS (Units Taken for Progress)	<p>Computed by the Consolidate Academic Statistics process (SRPCCONS).</p> <p>See the logic description for the OVRD_UNT_TAKEN_PRG field.</p>

Field	Logic
UNT_TAKEN_PRGRS_CL (Calculated Progress Units)	Computed by the Consolidate Academic Statistics process (SRPCCONS). See the logic description for the OVRD_UNT_TAKEN_PRG field.
OVRD_UNT_TAKEN_PRG (Override Units for Progress)	The system sets this field value to <i>N</i> , indicating that the Units Taken For Progress field (UNT_TAKEN_PRGRSS) contains the value of the calculated progress units (UNT_TAKEN_PRGRS_CL). You can override the calculated progress units (UNT_TAKEN_PRGRS_CL) by selecting the Override Units For Progress check box (OVRD_UNT_TAKEN_PRG) in the Mass Consolidated Statistics component or on the Basic Data page in the Student Consolidated Stats component, then selecting a new value for the Units Taken for Progress field (UNT_TAKEN_PRGRSS). Selecting this check box sets the OVRD_UNT_TAKEN_PRG field value to <i>Y</i> .
UNT_PASSD_PRGRSS (Units Passed for Progress)	Computed by the Consolidate Academic Statistics process (SRPCCONS).
UNT_TAKEN_GPA (Units Taken Toward GPA)	Computed by the Consolidate Academic Statistics process (SRPCCONS).
UNT_PASSD_GPA (Units Passed Toward GPA)	Computed by the Consolidate Academic Statistics process (SRPCCONS).
UNT_TAKEN_NOGPA (Units Taken Not Toward GPA)	Computed by the Consolidate Academic Statistics process (SRPCCONS).
UNT_PASSD_NOGPA (Units Passed Not Toward GPA)	Computed by the Consolidate Academic Statistics process (SRPCCONS).
UNT_INPROG_GPA (Units In Progress - GPA)	Computed by the Consolidate Academic Statistics process (SRPCCONS).
UNT_INPROG_NOGPA (Units In Progress - Not for GPA)	Computed by the Consolidate Academic Statistics process (SRPCCONS).
GRADE_POINTS (Grade Points)	Computed by the Consolidate Academic Statistics process (SRPCCONS).

Field	Logic
UNT_AUDIT (Units Audited)	Computed by the Consolidate Academic Statistics process (SRPCCONS).
UNT_TRNSFR (Units Transferred)	Populated from the corresponding field on the STDNT_CAR_TERM record.
TRF_TAKEN_GPA (Transfer Taken for GPA)	Populated from the corresponding field on the STDNT_CAR_TERM record.
TRF_TAKEN_NOGPA (Transfer Taken Not for GPA)	Populated from the corresponding field on the STDNT_CAR_TERM record.
TRF_PASSED_GPA (Transfer Passed for GPA)	Populated from the corresponding field on the STDNT_CAR_TERM record.
TRF_PASSED_NOGPA (Transfer Passed Not for GPA)	Populated from the corresponding field on the STDNT_CAR_TERM record.
TRF_GRADE_POINTS (Transfer Grade Points)	Populated from the corresponding field on the STDNT_CAR_TERM record.
UNT_TEST_CREDIT (Units From Test Credit)	Populated from the corresponding field on the STDNT_CAR_TERM record.
UNT_OTHER (Units From Other Credit)	Populated from the corresponding field on the STDNT_CAR_TERM record.
UNT_TAKEN_FA (Fin Aid Progress Units Taken)	Populated from the corresponding field on the STDNT_CAR_TERM record.
UNT_PASSD_FA (Fin Aid Progress Units Passed)	Populated from the corresponding field on the STDNT_CAR_TERM record.
UNT_TAKEN_FA_GPA (FA Units Taken Toward GPA)	Populated from the corresponding field on the STDNT_CAR_TERM record.

Field	Logic
GRADE_POINTS_FA (Financial Aid Grade Points)	Computed by the Consolidate Academic Statistics process (SRPCCONS).
UNT_TERM_TOT (Total Term Units)	Computed by the Consolidate Academic Statistics process (SRPCCONS).
RESET_CUM_STATS (Reset Cum Stats at Term Start)	Currently not in use.
TOT_TAKEN_PRGRSS (Total Taken for Progress)	Computed by the Consolidate Academic Statistics process (SRPCCONS).
TOT_PASSD_PRGRSS (Total Passed for Progress)	Computed by the Consolidate Academic Statistics process (SRPCCONS).
TOT_TAKEN_GPA (Total Taken Toward GPA)	Computed by the Consolidate Academic Statistics process (SRPCCONS).
TOT_PASSD_GPA (Total Passed Toward GPA)	Computed by the Consolidate Academic Statistics process (SRPCCONS).
TOT_TAKEN_NOGPA (Total Taken Not Toward GPA)	Computed by the Consolidate Academic Statistics process (SRPCCONS).
TOT_PASSD_NOGPA (Total Passed Not Toward GPA)	Computed by the Consolidate Academic Statistics process (SRPCCONS).
TOT_INPROG_GPA (Total In Progress - GPA)	Computed by the Consolidate Academic Statistics process (SRPCCONS).
TOT_INPROG_NOGPA (Total In Progress - Not for GPA)	Computed by the Consolidate Academic Statistics process (SRPCCONS).
TOT_AUDIT (Total Audited)	Computed by the Consolidate Academic Statistics process (SRPCCONS).

Field	Logic
TOT_TRNSFR (Total Transferred)	Computed by the Consolidate Academic Statistics process (SRPCCONS).
TOT_TEST_CREDIT (Total From Test Credit)	Computed by the Consolidate Academic Statistics process (SRPCCONS).
TOT_OTHER (Total From Other Credit)	Computed by the Consolidate Academic Statistics process (SRPCCONS).
TOT_CUMULATIVE (Total Cumulative Units)	Computed by the Consolidate Academic Statistics process (SRPCCONS). See the logic description for the OVRD_TOT_CUM field.
TOT_CUMULATIVE_CL (Total Cumulative Units Calculated)	Computed by the Consolidate Academic Statistics process (SRPCCONS). See the logic description for the OVRD_TOT_CUM field.
OVRD_TOT_CUM (Override Total Cumulative Unit)	The system sets this field value to <i>N</i> , indicating that the Total Cumulative Units field (TOT_CUMULATIVE) contains the value of the calculated total cumulative units (TOT_CUMULATIVE_CL). You can override the calculated total cumulative units (TOT_CUMULATIVE_CL) by selecting the Override Total Cumulative Unit check box (OVRD_TOT_CUM) in the Mass Consolidated Statistics component or on the Basic Data page in the Student Consolidated Stats component, then selecting a new value for the Total Cumulative Units field (TOT_CUMULATIVE). Selecting this check box sets the OVRD_TOT_CUM field value to <i>Y</i> .
TOT_GRADE_POINTS (Total Grade Points)	Computed by the Consolidate Academic Statistics process (SRPCCONS).
TOT_TAKEN_FA (Total Fin Aid Units Taken)	Computed by the Consolidate Academic Statistics process (SRPCCONS).
TOT_PASSD_FA (Total Fin Aid Units Passed)	Computed by the Consolidate Academic Statistics process (SRPCCONS).
TOT_TAKEN_FA_GPA (Total Fin Aid Taken Toward GPA)	Computed by the Consolidate Academic Statistics process (SRPCCONS).

Field	Logic
TOT_GRD_POINTS_FA (Total Fin Aid Grade Points)	Computed by the Consolidate Academic Statistics process (SRPCCONS).
FORM_OF_STUDY (Form of Study)	Populated from the corresponding field on the STDNT_CAR_TERM record based on the student's primary academic program. See the logic description for the OVRD_FORM_OF_STUDY field.
FORM_OF_STUDY_PD (Form of Study for Period)	Used in the United States, specifically for IRS reporting in a delivered report in the database. When you have an academic statistics period that consolidates several terms: If the latest term form of study equals <i>Enrollment</i> and units equals <i>0</i> , then the program logic populates FORM_OF_STUDY_PD with the <i>prior</i> term's form of study value. If the latest term form of study equals <i>Enrollment</i> and units are greater than <i>0</i> , then the program logic populates FORM_OF_STUDY_PD with the <i>latest</i> term's form of study value.
FORM_OF_STUDY_CL (Form of Study Calculated)	Populated from the corresponding field on the STDNT_CAR_TERM record based on the student's primary academic program. See the logic description for the OVRD_FORM_OF_STUDY field.
OVRD_FORM_OF_STUDY (Override Form of Study)	The system sets this field value to <i>N</i> , indicating that the Form of Study field (FORM_OF_STUDY) contains the value of the calculated form of study (FORM_OF_STUDY_CL). You can override the calculated form of study (FORM_OF_STUDY_CL) by selecting the Override Form of Study check box (OVRD_FORM_OF_STUDY) in the Mass Consolidated Statistics component or the Basic Data page in the Student Consolidated Stats component, then selecting a new value for Form of Study field (FORM_OF_STUDY). Selecting this check box sets the OVRD_FORM_OF_STUDY field value to <i>Y</i> .
TERM_TYPE (Term Type)	Populated from the corresponding field on the STDNT_CAR_TERM record based on the student's primary academic career.
CLASS_RANK_NBR (Class Rank Nbr)	Populated from the corresponding field on the STDNT_CAR_TERM record.

Field	Logic
CLASS_RANK_TOT (Class Rank Total)	Populated from the corresponding field on the STDNT_CAR_TERM record.
SEL_GROUP (Tuition Group)	Populated from the corresponding field on the STDNT_CAR_TERM record.
BILLING_CAREER (Billing Career)	Populated from the corresponding field on the STDNT_CAR_TERM record based on the student's primary academic career and primary academic program.
UNIT_MULTIPLIER (Unit Multiplier)	Populated from the corresponding field on the STDNT_CAR_TERM record.
ACAD_YEAR (Academic Year)	Populated from the corresponding field on the STDNT_CAR_TERM record based on the student's primary academic career and primary academic program.
CUR_RESIDENT_TERMS (Current In Residence Terms)	Populated from the corresponding field on the STDNT_CAR_TERM record.
TRF_RESIDENT_TERMS (Transfer In Residence Terms)	Populated from the corresponding field on the STDNT_CAR_TERM record.
CUM_RESIDENT_TERMS (Cumulative In Residence Terms)	Computed by the Consolidate Academic Statistics process (SRPCCONS).
REFUND_PCT (Refund Percentage)	Populated from the corresponding field on the STDNT_CAR_TERM record.
REFUND_SCHEME (Refund Scheme)	Populated from the corresponding field on the STDNT_CAR_TERM record.
PRO_RATA_ELIGIBLE (Pro-rata Eligible)	Populated with values from the corresponding field on the STDNT_CAR_TERM record based on the student's primary academic career and primary academic program.
FULLY_ENRL_DT (Fully Enrolled Date)	Populated from the corresponding field on the STDNT_CAR_TERM record.

Field	Logic
FULLY_GRADED_DT (Fully Graded Date)	Populated from the corresponding field on the STDNT_CAR_TERM record.
EXT_ORG_ID (External Org ID)	Populated with values from the corresponding field on the STDNT_CAR_TERM record based on the student's primary academic program. Relates to external study only, as entered through the External Study page in the Term Activation component.
COUNTRY (Country)	Populated with values from the corresponding field on the STDNT_CAR_TERM record based on the student's primary academic program. Relates to external study only, as entered through the External Study page in the Term Activation component.
STUDY_AGREEMENT (Study Agreement)	Populated with values from the corresponding field on the STDNT_CAR_TERM record based on the student's primary academic program. Relates to external study only, as entered through the External Study page in the Term Activation component.
START_DATE (Start Date)	Populated with values from the corresponding field on the STDNT_CAR_TERM record based on the student's primary academic program. Relates to external study only, as entered through the External Study page in the Term Activation component.
END_DATE (End Date)	Populated with values from the corresponding field on the STDNT_CAR_TERM record based on the student's primary academic program. Relates to external study only, as entered through the External Study page in the Term Activation component.
CUR_GPA (Current GPA)	<p>Computed by the Consolidate Academic Statistics process (SRPCCONS).</p> <p>If the academic statistics period has <i>As of Date</i> or <i>As of Today</i> for its trigger, then the program logic uses the current GPA.</p> <p>If the academic statistics period has <i>Consolidation Date</i> for its trigger, the program logic uses the current term GPA.</p> <p>If a student is active in multiple programs and careers with different grading bases (for example, a 100-point scale and a 4-point scale), then the program logic reports only the student's primary career and program GPA.</p> <p>See the logic description for the OVRD_GPA field.</p>

Field	Logic
GPA_CL (GPA Calculated)	<p>Computed by the Consolidate Academic Statistics process (SRPCCONS).</p> <p>If the academic statistics period has <i>As of Date</i> or <i>As of Today</i> for its trigger, then the program logic uses the current GPA.</p> <p>If the academic statistics period has <i>Consolidation Date</i> for its trigger, the program logic uses the current term GPA.</p> <p>If a student is active in multiple programs and careers with different grading bases (for example, a 100-point scale and a 4-point scale), then the program logic reports only the student's primary career and program GPA.</p> <p>See the logic description for the OVRD_GPA field.</p>
OVRD_GPA (Override GPA)	<p>The system sets this field value to <i>N</i>, indicating that the Current GPA field (CUR_GPA) contains the value of the calculated GPA (GPA_CL). You can override the calculated GPA (GPA_CL) by selecting the Override GPA check box (OVRD_GPA) in the Mass Consolidated Statistics component or on the Basic Data page in the Student Consolidated Stats component, then selecting a new value for the Current GPA field (CUR_GPA). Selecting this check box sets the OVRD_GPA field value to <i>Y</i>.</p>
CUM_GPA (Cumulative GPA)	<p>Computed by the Consolidate Academic Statistics process (SRPCCONS). Total grade points divided by total units. If the student is active in multiple programs and careers with different grading bases (for example, 100-point scale and 4-point scale), then the program logic reports only the student's primary career and program GPA.</p> <p>See the logic description for the OVRD_CUM_GPA field.</p>
CUM_GPA_CL (Cumulative GPA Calculated)	<p>Computed by the Consolidate Academic Statistics process (SRPCCONS). Total grade points divided by total units. If the student is active in multiple programs and careers with different grading bases (for example, 100-point scale and 4-point scale), then the program logic reports only the student's primary career and program GPA.</p> <p>See the logic description for the OVRD_CUM_GPA field.</p>
OVRD_CUM_GPA (Override Cum GPA)	<p>The system sets this field value to <i>N</i>, indicating that the Cumulative GPA field (CUM_GPA) contains the value of the calculated GPA (CUM_GPA_CL). You can override the calculated cumulative GPA (CUM_GPA_CL) by selecting the Override Cum GPA check box (OVRD_CUM_GPA) in the Mass Consolidated Statistics component or on the Basic Data page in the Student Consolidated Stats component, then selecting a new value for the Cumulative GPA field (CUM_GPA). Selecting this check box sets the OVRD_CUM_GPA field value to <i>Y</i>.</p>

Field	Logic
OVRD_TUIT_GROUP (Override Tuition Group)	Populated from the corresponding field on the STDNT_CAR_TERM record.
OVRD_WDRW_SCHED (Override Withdrawal Schedule)	Populated from the corresponding field on the STDNT_CAR_TERM record based on the student's primary academic career and primary academic program.
TUITION_RES_TERMS (Tuition Residency)	Populated from the corresponding field on the STDNT_CAR_TERM record.
TC_UNITS_ADJUST (TC Units Adjustment)	Populated from the corresponding field on the STDNT_CAR_TERM record.
STDNT_COHORT_PRIM (Primary Student Cohort)	The Consolidate Academic Statistics process (SRPCCONS) reports one student attribute only for cohort processing. Define student attributes and their valid values on the Student Attributes Table page. Define the student attribute for cohort reporting at your institution on the Institution 3 page. When you run the process, it calls, for each student, a routine to retrieve the student's most primary student attribute value for the specific student attribute for cohort value that you define on the Institution 3 page. Assign student attributes and values to students on the Student Attributes page of the Student Program/Plan component.
ETHNIC_GROUP_SR (Ethnic Group)	<p>Populated from joining the ETHNICITY_DTL record which contains the ETHNIC_GRP_CD against the ETHNIC_GRP_TBL which contains ETHNIC_GROUP, which is reported.</p> <hr/> <p>Note: The field value is derived according to IPEDS reporting requirements if the academic statistics type is identified as IPEDS.</p> <hr/> <p>See Setting Up Statistic Period Types.</p>
AGE_CATEGORY_SR (Age Category)	Populated from the corresponding field on the PERSON record. Age categories are defined per IPEDS rules. The program logic calculates age by using a student's birth date from personal data (based on system date) and comparing their birth date to the as of date, as of today date (system date), or consolidation as of date.
DEGREE (Degree)	Populated from the ACAD_DEGR record if the ACAD_PLAN for the ACAD_PROG being reported matches the ACAD_PLAN in the ACAD_DEGR_PLAN record.

Field	Logic
EXP_GRAD_TERM (Expected Graduation Term)	Populated from corresponding field on the ACAD_PROG record based on the student's primary academic program.
COMPLETION_TERM (Completion Term)	Populated from the corresponding field on the ACAD_PROG record based on the student's primary academic program. If the statistics type includes the academic program status <i>Completed</i> , the process selects those students who have a completion term that is greater than or equal to the consolidated statistics term (STRM), and those whose effective date of the student's completion row is greater than or equal to the term start date and less than or equal to the term end date.
DEGR_CONFER_DT (Confer Date)	Populated from the ACAD_DEGR record if the ACAD_PLAN for the ACAD_PROG being reported matches the ACAD_PLAN in the ACAD_DEGR_PLAN record.
ENRL_STAT_CHG_DT (Enrollment Status Change Date)	Populated based on the program action on the ACAD_PROG record. If the program status is CM and the program action is COMP, the DEGR_CONFER_DT is reported. If the program status is CM and the program action is not COMP, the EFFDT of the ACAD_PROG record is reported. If the program status is active or waitlisted, and during the term a program or NSC reporting unit change has occurred, the date of the change is reported. Otherwise, no date is reported. If any other program status is reported, the EFFDT of the ACAD_PROG record is reported. Note: If you use grade exclusions for NSC Reporting, the SRPCCONP process evaluates the drop date based on a student's enrollment record (STDNT_ENRL.DROP.ENRL_DROP_DT) to accurately report the ENRL_STAT_CHG_DT. See Understanding Consolidated Statistics Processes .
ACAD_PROG_MAIN (Academic Program)	Populated with the student's primary academic program (ACAD_PROG) within the student's primary academic career based on the STDNT_CAR_TERM record.
STDNT_CAR_NBR_MAIN (Student Career Number)	Populated with the student career number (STDNT_CAR_NBR) based on the student's primary academic career and primary academic program as found on the STDNT_CAR_TERM record.
ACAD_PLAN (Academic Plan)	Calculated from the corresponding field on the ACAD_PLAN record based on the student's calculated primary academic program.

Field	Logic
ACAD_SUB_PLAN (Academic Subplan)	Populated from the corresponding field on the ACAD_SUBPLAN record based on the student's primary academic program.
EXTRA_ACTIVITY (Extracurricular Activity)	Populated from the corresponding field on the EXTRACUR_ACTVTY record. Primacy is taken into consideration by joining PS_EXTR_ACTVTY_TBL on common keys.
SF_1098_GRAD_FLG (1098 Grad Flag)	Currently not in use, reported as N.
SF_1098_HLFTME_FLG (1098 Half Time Flag)	Currently not in use, reported as N.
CORRECTION_STATUS (Correction Status)	Currently not in use, reported as 1.
SF_CORRECTION_DTTM (Correction Date Time)	Currently not in use, reported as NULL.
SF_OVERRIDE_GRAD (Override Grad Flag)	Currently not in use, reported as N.
SF_OVERRIDE_HALF (Override Half Flag)	Currently not in use, reported as N.
SF_ORIGINAL_SENTDT (Original Sent Date)	Currently not in use, reported as NULL.
SF_ORIGINAL_PRT_DT (Original Print Date)	Currently not in use, reported as NULL.
ATHLETIC_AID (Athletic Aid)	Populated from FIN_AID_TYPE field found on the financial aid record ITEM_TYPE_FA. If the FIN_AID_TYPE value equals <i>A</i> (athletic), then the program sets the ATHLETIC_AID flag for consolidated statistics to <i>Y</i> (yes). You can override this value with the Athletic Aid check box in the Mass Consolidated Statistics component or on the Basic Data page in the Student Consolidated Stats component.

Field	Logic
PROG_STATUS (Program Status)	This is the student's status within her or his primary academic program.
MULTI_ACAD_CAREER (Multiple Academic Career)	The program logic sets this flag to <i>Y</i> (yes) if the program is consolidating multiple careers and programs for a student regardless of a student's enrollment status. You can override this value with the Multiple Academic Career check box in the Mass Consolidated Statistics component or on the Basic Data page in the Student Consolidated Stats component.
FA_UNIT_WARNING (Excluded FA eligible Term Warn)	SRPCCONS currently does not calculate the value for the FA_UNIT_WARNING flag. The program logic sets this field value to <i>N</i> (no).
CAMPUS (Campus)	Populated from the corresponding field on the ACAD_PROG record based on the student's primary academic program.
LEVEL_LOAD_RULE (Level Load Rule)	The academic level and load rule that the SRPCCONS process uses to calculate the student's academic level and academic load.
OPRID (Operator ID)	Populated from the corresponding field on the run control table PS_RUN_CNTL_CONS, based on the user who saved the Consolidated Statistics process page.
LASTNAME_RPTD_NSLC (Last name Reported NSLC)	<p>Populated from input through the Consolidated Statistics process page provided that a value was entered into the Prev Stat NSC (previous statistics NSC) field on the page.</p> <p>The program will use the EMPLID, INSTITUTION, and ACAD_STATS_PERIOD to pull up the STDNT_CONS_STAT record from the previous NSC run and pull the data from the record. STDNT_CONS_STAT record will have the Last Name field populated when SRNSLCEX.SQR is run (<i>Manage Academic Records, Reports, NSC</i>).</p>
SSN_RPTD_NSLC (SSN Reported NSLC)	<p>Populated from input through the Consolidated Statistics process page provided that a value was entered into the Prev Stat NSC field on the page.</p> <p>The program will use the EMPLID, INSTITUTION, and ACAD_STATS_PERIOD to pull up the STDNT_CONS_STAT record from the previous NSC run and pull the data from the record. STDNT_CONS_STAT record will have the SSN field populated when SRNSLCEX.SQR is run (<i>Manage Academic Records, Reports, NSC</i>).</p>

Field	Logic
PREV_STATSPER_NSLC (Prev Acad Stats Period NSLC)	Originated from data on the Consolidated Statistics process page when the process is run.

The Consolidated Academic Statistics process writes NSC program level data to the SSR_STD_CON_ST2 table and the NSC extract uses this data. The table can capture a maximum of six sets of program level data.

NSC program level data is reported when the Program Indicator field value is *Yes*.

The following table lists the fields found in the SSR_STD_CON_ST2 table in the order in which they appear in the record definition, and explains the related logic. There are also descriptions for the first set of program fields (PRG1). The same logic is used for all six sets of program fields.

Fields	Logic
SSR_NSC_PRG_IND (Program Indicator)	If a student has at least one valid academic plan(for the reporting period) that has been identified on the Academic Plan table as a plan that should be reported as an "NSC Program" (ACAD_PLAN_TBL.SSR_NSC_INCL_PLAN = Y), then this value is set to <i>Yes</i> .
SSR_NSC_PRG1_CIPCD (Program CIP Code)	The Consolidated Statistics process reports the CIP code for the academic plan. The value is retrieved from the table ACAD_PLAN_TBL and the column CIP_CODE. See “Setting Up Taxonomy” (Campus Solutions Application Fundamentals)
SSR_NSC_PRG1_CIPYR (CIP Year)	The year in which the CIP code being reported was published. Because this value can change over time, the value is attached to the Statistics Type definition. The data is retrieved from the table ACD_STAT_TP_TBL and the column SSR_NSC_PRG_CIPYR. See <u>Setting Up Statistic Period Types</u>

Fields	Logic
<p>SSR_NSC_PRG1_CRLVL (Program Credential Level)</p>	<p>The credential level of the program required by the NSC. The Code and Description values are:</p> <ul style="list-style-type: none"> • 01: Undergraduate Certificate of Diploma Program • 02: Associate’s Degree • 03: Bachelor’s Degree • 04: Post Baccalaureate Certificate • 05: Master’s Degree • 06: Doctoral Degree • 07: First Professional Degree • 08: Graduate / Professional Certificate • 99: Non Credential Program (Preparatory Coursework / Teacher Certification) <p>These values are mapped from the NSC Credential Level values attached to the student’s academic plan. The values are defined by Aid Year on the Financial Aid Credential Level Cross Reference page. The Consolidated Statistics process retrieves this value from the table SFA_CRDLVL_XREF and the column SFA_COD_CRED_LVL.</p> <p>See “Setting Up Taxonomy” (Campus Solutions Application Fundamentals)</p> <p>See “Setting Up 150 Percent Direct Subsidized Loan Limit (SULA)” (Financial Aid)</p>
<p>SSR_NSC_PRG1_LNGTH (Published Program Length)</p>	<p>The length of the instructional program in weeks, months, or years. The value in the extract is represented by six digits, with a decimal implied between the third and fourth digit. For example, an NSC report value of 036000 is 36 and 000500 is 0.5.</p> <p>The value is retrieved from the table ACAD_PLAN_TBL and the column is SSR_PROG_LENGTH.</p> <p>See “Setting Up Taxonomy” (Campus Solutions Application Fundamentals)</p>

Fields	Logic
<p>SSR_NSC_PRG1_LENCD (Published Length Measurement)</p>	<p>The code that defines the length of measurement for the Published Program Length. The Code and Description values are:</p> <ul style="list-style-type: none"> • Y: Year • M: Month • W: Week <p>The value is retrieved from the table ACAD_PLAN_TBL and the column is SSR_PROG_LEN_TYPE.</p> <p>See “Setting Up Taxonomy” (Campus Solutions Application Fundamentals)</p>
<p>SSR_NSC_PRG1_TT4YR (Weeks Program Title IV Academic Year)</p>	<p>The number of weeks of instruction in the program’s academic year. This value is reported only if the Published Program Length is reported as either Months or Weeks. Because the value can be overridden at the student level, the Consolidated Statistics process uses the following logic to report this data:</p> <ul style="list-style-type: none"> • If the student’s academic program overrides the default value, it is reported. The value is retrieved from the table STDNT_PELL_RULE and the column is BASE_WEEKS_ACAD. See “Reviewing the Student’s Packaging Status” (Financial Aid) • If the default program value is not overridden, the value is used from the Aid Processing Rule setup defined for the academic program for the current aid year. The value is retrieved from the table FA_DFLT_RUL_SET and the column is BASE_WEEKS_ACAD. See “Creating Aid Processing Rule Sets” (Financial Aid) • If neither value is found, the default value from the FA installation table is used. The value is retrieved from the table INSTALLATION_FA and the column is ACAD_WEEKS_BASE. See “Defining Installation Level Defaults” (Financial Aid)
<p>SSR_NSC_PRG1_BGNDT (Program Begin Date)</p>	<p>The date on which the student began the program. This value is calculated based on when the student became active in the current academic program from the EFFDT of the ACAD_PROG table. The valid academic program statuses used for reporting are defined on the Academic Statistics Type page. The value is retrieved from the table ACAD_PROG and the column is EFFDT.</p> <p>See Setting Up Statistic Period Types</p>

Fields	Logic
SSR_NSC_PRG1_SPIND (Special Program Indicator)	<p>This code is used to identify whether the program belongs to one of a select special group. The Code and Description values are:</p> <ul style="list-style-type: none"> • A: Special Admission Associate Degree Program • B: Bachelor's Degree Completion Program • N: Not Applicable • P: Preparatory Coursework Graduate/Professional • T: Non Credential Teacher Certification • U: Preparatory Coursework Undergraduate <p>The value is retrieved from the table ACAD_PLAN_TBL and the column is SFA_SPEC_PROG_FLG.</p> <p>See "Setting Up Taxonomy" (Campus Solutions Application Fundamentals)</p>

Fields	Logic
<p>SSR_NSC_PRG1_ENRST (Program Enrollment Status)</p>	<p>The student's enrollment status for this program in the reporting period. The Code and Description values are:</p> <ul style="list-style-type: none"> • F: Full Time • Q: Three Quarter Time • H: Half Time • L: Less Than Half Time • A: Leave of Absence • G: Graduated • W: Withdrawn • D: Deceased <p>Different calculation methods are used, depending on the status:</p> <ul style="list-style-type: none"> • For actively enrolled students: use the number of units enrolled for the current program and get the NSC academic load. The value is retrieved from the table ACAD_LOAD_TBL and the column is ACADEMIC_LOAD_NSLC. • Leave of Absence is reported if the academic program has a program status of LA. • Graduated is reported if the academic program has a program status of CM. • Deceased is reported if the academic program has a program status of DE. • Withdrawn is reported if the: <ul style="list-style-type: none"> • Current STDNT_CAR_TERM record has a WITHDRAW_CODE not equal to NWD and the LAST_DATE_ATTENDED is populated, <i>or</i> • Student changes plan during the reporting period. When this is the case, the student is reported in Withdrawn status for the change from plan.

Fields	Logic
<p>SSR_NSC_PRG1_ENRDT</p> <p>Program Enrollment Status Effective Date</p>	<p>The effective date of the current program enrollment status. The value reported here can change depending on whether enrollment status has changed since the last reporting period.</p> <ul style="list-style-type: none"> • If this is the first NSC submission of the term or there has been no change in the students enrollment status, the date is equal to the term begin date. <p>Effective Update Image 28, if the Enrollment Status Date Option on the Academic Institution 3 page is set to <i>Use the Date the Enrollment Status was Determined</i> and there hasn't been any change in the student's enrollment status, the process reports the last enrollment status effective date that was calculated for the student. For example, if a student that starts in Fall 2022 sustains full-time enrollment throughout that term and enrolls for Spring 2023 as full-time, then the enrollment status effective date for the first Spring 2023 submission would be the start date of the Fall 2022 term.</p> <ul style="list-style-type: none"> • If the Enrollment Status has changed since the previous statistics period the date is calculated as follows: <p>If the status changes to F, Q, H or L, then the date reported is the enrollment status change date from STDNT_CAR_TERM, column UNTPRG_CHG_NSLC_DT.</p> <p>If the status changes to W, then the date will be sourced differently depending on whether the student has withdrawn completely or if they have changed (or removed) a plan:</p> <ul style="list-style-type: none"> • <i>Withdrawal</i> (STDNT_CAR_TERM record has a WITHDRAW_CODE not equal to NWD) <p>The date reported is the LAST_DATE_ATTENDED value from the STDNT_CAR_TERM row.</p> <ul style="list-style-type: none"> • <i>Plan Change</i> (student changed plans during the reporting period) <p>The date reported is the date the student changed from the plan, that is, the effective date of the change row on the student's program stack (ACAD_PROG.EFFDT).</p> <p>If the status changes to G, then the date reported is the effective date from the program stack Completed row (ACAD_PROG.EFFDT).</p>

Fields	Logic
<p>SSR_NSC_PRG1_DTADJ</p> <p>Enrollment Data Adjusted: Y/N</p>	<p>This field will be populated if the Enrollment Status Date Option on the Academic Institution 3 page (delivered in Update Image 28) is enabled. When enabled, the value will be set to <i>Yes</i> if the enrollment status date has been adjusted based on an evaluation of the student’s consolidated statistics history. That is, the date has been determined not only by statistics periods that were run, but also any prior statistics period data generated for the student.</p> <p>If the value was set to <i>Yes</i>, then the first time the process was run with the new option enabled, the <i>Yes</i> value is carried over to subsequent statistics periods but the process will not reevaluate the student’s entire consolidated statistics history</p>
<p>SSR_NSC_PRG1_USEDT</p> <p>Use Adjusted Date: Y/N</p>	<p>This field will be populated if the Enrollment Status Date Option on the Academic Institution 3 page (delivered in Update Image 28) is enabled and indicates that the Enrollment Status Effective Date was adjusted using the student’s consolidated statistics history rather than the Term Begin Date.</p>
<p>SSR_NSC_PRG1_STAT</p> <p>Status</p>	<ul style="list-style-type: none"> • S: Success • I: Incomplete Data • Date Adjusted: The enrollment status effective date was adjusted using historical consolidated statistics data. • Same CIP Merged: This status is assigned if Consolidate by NSC Five-Point Match Criteria is enabled and two or more plans are matched. • Same CIP Found: This value will be returned if Consolidate by NSC Five-Point Match Criteria isn't enabled and is intended as a warning message to alert the user to possible duplicates. • Date Based On Enrollment Data: This status is used when the process finds discrepancies in the historical statistics data and used STDNT_CAR_TERM or STDNT_ENRL data to calculate a revised enrollment status effective date. • Date Based on As Of Date: The process was unable to calculate a revised enrollment status date using historical statistics data or by evaluating STDNT_CAR_TERM or STDNT_ENRL data and therefore used the Statistics Period.

Consolidating Academic Plans Using NSC Matching Criteria

In cases where a student has multiple plans with the same CIP code and other National Student Clearinghouse (NSC) attributes (such as credential level), these can be consolidated for NSC program reporting purposes using the **Consolidate by NSC Five-Point Match Criteria** option on the Academic Institution 3 page.

When this option is enabled, the Consolidated Statistics process will use NSC five-point matching criteria when evaluating student plan data to consolidate plans. Using the earliest program start date/enrollment status effective date, the plans are reported as a single program under one CIP code *if* the process finds two or more active plans where all the following items match:

- Plan CIP code
- Plan Credential level
- Program Published Length
- Program Published Length Measurement
- Program Weeks in Title IV Academic Year

NSC Program Level Reporting: Academic Plan Usage

For NSC program level reporting purposes, the Consolidated Statistics process selects all of a student's eligible academic plans. This requires that users identify academic plans for NSC program reporting purposes. See "Setting Up Taxonomy" (Campus Solutions Application Fundamentals).

The process reports all eligible plans, that is, Plan values where the ACAD_PLAN_TBL.SSR_NSC_INCL_PLAN value = Y, across careers, up to the current NSC maximum of six.

Consider the following examples:

For an undergraduate student with three plans, Plan A, B, and C, and with their Report as NSC Program check boxes set to Y, N, and Y, respectively, the process reports the student with a Program Indicator value = Y. At the program level, the process will report Plan A (and associated data) as NSC Program 1 and Plan C for NSC Program 2.

For a non-degree student, that is, a student who does not have any plans set for NSC, the process reports the student with a Program Indicator value = N. This means no program data is reported.

In a case where a student has multiple careers, such as Law and Graduate Business, the process will report all eligible plans for each career. If the student had one Law Plan (LAWPLANA) and 2 Business Plans (MBAPLANA, MBAPLANB) and all 3 plans were identified as NSC Programs, the process reports the student with a Program Indicator value = Y. At the program level, LAWPLANA (and associated data) is reported for NSC Program 1, MBAPLANA for NSC Program 2, and MBAPLANB for NSC Program 3.

Reporting NSC Program Changes

Program changes are reported as they occur during the reporting period. In the event that a student changes programs (academic plan) during the term, the new program will be reported in an *Enrolled* status, and the effective date of the Plan change will be used for the program begin date and enrollment status values. In addition, the original program will be reported with a *Withdrawn* status, and an enrollment status date equal to the date of the Plan change.

Consider the following examples.

Student with a Single Plan or NSC Program

A student was admitted to Plan A for Fall 2014 term on 8/1/14 and is enrolled full-time. The Fall term begins 8/30/2014. In the first NSC submission of the Fall 2014 term (consolidation date: 09/05/2014), the student is reported with the following data:

Data	Value
Program 1	Plan A CIP Code
Program 1 Begin Date	08/01/2014
Program 1 Enroll Status	F
Program 1 Enroll Status Date	08/30/2014

Subsequently, the student changes from Plan A to Plan B, with an effective date of 09/07/2014. On the subsequent NSC submission (consolidation date: 09/15/2014), the following data would be reported for the student:

Program 1 Data	Value	Program 2 Data	Value
Program 1	Plan B CIP Code	Program 2	Plan A CIP Code
Program 1 Begin Date	09/07/2014	Program 2 Begin Date	08/01/2014
Program 1 Enroll Status	F	Program 2 Enroll Status	W
Program 1 Enroll Status Date	09/07/2014	Program 2 Enroll Status Date	09/07/2014

The withdrawn (W) program entry will continue to be reported for any subsequent submissions in the same reporting period, but will not be included for later reporting periods. In this example, the withdrawn Plan A would not be reported in the Spring 2015 term submissions.

Student with Two Plans or NSC Programs

A student was admitted to Plan A and Plan B for the Fall 2014 term on 8/1/14 and is enrolled full-time. The Fall term begins 8/30/2014. In the first NSC submission of the fall 2014 term (consolidation date: 09/05/2014), the student is reported with the following data:

Program 1 Data	Value	Program 2 Data	Value
Program 1	Plan A CIP Code	Program 2	Plan B CIP Code

Program 1 Data	Value	Program 2 Data	Value
Program 1 Begin Date	08/01/2014	Program 2 Begin Date	08/01/2014
Program 1 Enroll Status	F	Program 2 Enroll Status	F
Program 1 Enroll Status Date	08/30/2014	Program 2 Enroll Status Date	08/30/2014

Subsequently, the student changes Plan A to Plan C, with an effective date of 09/07/2014. On the next NSC submission (consolidation date: 09/15/2014), the following data would be reported for the student:

Program 1 Data	Value	Program 2 Data	Value	Program 3 Data	Value
Program 1	Plan B CIP Code	Program 2	Plan C CIP Code	Program 3	Plan A CIP Code
Program 1 Begin Date	08/01/2014	Program 2 Begin Date	09/07/2014	Program 3 Begin Date	08/01/2014
Program 1 Enroll Status	F	Program 2 Enroll Status	F	Program 3 Enroll Status	W
Program 1 Enroll Status Date	08/30/2014	Program 2 Enroll Status Date	09/07/2014	Program 3 Enroll Status Date	09/07/2014

The withdrawn (W) program entry will continue to be reported for any subsequent submissions in the same term reporting periods, but will not be included for later term submissions. In this example, the withdrawn Plan A would not be reported in the Spring 2015 term submissions.

Academic Load Calculation at the NSC Program Level

During academic load calculation, the process will report the same academic load value across NSC programs using the academic load rule for the student's consolidated career. Given the examples used in [Reporting NSC Program Changes](#), the following academic loads are calculated:

- For an undergraduate student with three plans, the consolidated or campus level academic load is *F*.

NSC Programs	Academic Load
Prog1: PLANA	F

<i>NSC Programs</i>	<i>Academic Load</i>
Prog2: PLANB	F
Prog3: PLANC	F

- For a non-degree student, that is, a student that does not have an NSC program, the consolidated or campus level academic load is L

<i>NSC Programs</i>	<i>Academic Load</i>
No data	No data

- For a law student (career = LAW) who is also an MBA (career = Business) student with two plans within the MBA program, the consolidated or campus level academic load is H.

<i>NSC Programs</i>	<i>Academic Load</i>
Prog1: LAWPLANA	H
Prog2: MBAPLANA	H
Prog3: MBAPLANB	H

Performing Academic Statistics Consolidation

This section discusses how to consolidate academic statistics.

Page Used to Perform Academic Statistics Consolidation

<i>Page Name</i>	<i>Definition Name</i>	<i>Navigation</i>	<i>Usage</i>
Consolidated Statistics	RUNCTL_CONS_STATS	Records and Enrollment > Enrollment Reporting > Consolidated Statistics > Process Consolidate Statistics > Consolidated Statistics	Consolidate students' academic statistics for an academic statistics period.

Consolidating Academic Statistics

Access the Consolidated Statistics page (**Records and Enrollment > Enrollment Reporting > Consolidated Statistics > Process Consolidate Statistics > Consolidated Statistics**).

If the academic statistics period has *Consolidation Date* for its consolidation trigger, you must first run either the Take Term Statistics Snapshot process (SRPCCONA) or the Recurring Term Snapshot process (SRPCCONU) for all academic career and term combinations defined within the academic statistics period. Then you must run the Consolidate Academic Statistics process (SRPCCONP). If the academic statistics period has *As of Date* or *As of Today* as its consolidation trigger, you need run only the Consolidate Academic Statistics process.

This example illustrates the fields and controls on the Consolidated Statistics page. You can find definitions for the fields and controls later on this page.

Consolidated Statistics

Run Control ID: NSC0900-0N Report Manager Process Monitor Run

*Academic Institution PeopleSoft University

*Academic Statistics Period 2023 Spring NSC 1N

Prev Stats NSC

*Consolidation Mode *Commit Frequency

NSC Options

Enrollment Status Date Option

When determining Enrollment Status Date

Use Term Begin Date or Academic Load Change Date (Legacy)

Use the Date the Enrollment Status was Determined

Plan with Same CIP Code Keys

NSC CIP Code Options

Leave of Absence Option

When returning from Leave of Absence

Use Return from LOA Date

Use Active Program Start Date

If Return Within Days

Student Career Term Snapshot Input Parameters

Personalize | Find | | First 1 of 1 Last

* <th style="width: 10%;">*Term</th> <th style="width: 25%;">Term Description</th> <th style="width: 15%;">Snapshot Date</th> <th style="width: 10%;">Overwrite</th> <th style="width: 35%;"></th>	*Term	Term Description	Snapshot Date	Overwrite	
1 UGRD	0900	2023 Spr	02/02/2023	<input type="checkbox"/>	<input type="button" value="-"/>

Field or Control	Description
Academic Institution	Select the academic institution that contains the academic statistics period for which you want to run the process.
Academic Statistics Period	Select the academic statistics period for which you want to run the process.

Field or Control	Description
Prev Stats NSC (previous statistics National Student Clearinghouse)	<p>Select the academic statistics period used as the source for the previous NSC Extract report that your institution submitted to the NSC within the current reporting period.</p> <p>The Prev Stats NSC field enables your institution to report enrollment status changes to the NSC throughout a reporting period so that student loan lenders know when a student's enrollment status declines. The field enables the Consolidate Academic Statistics process to perform a comparison of a student's current enrollment status to that which was previously reported to the NSC within the same reporting period. The current report thus includes only the key differences between it and the previous report.</p> <p>Use the Prev Stats NSC field <i>only if</i> you have previously reported to the NSC for the current reporting period or term. <i>Do not</i> use this field for a <i>first of term</i> submission to the NSC.</p>

Field or Control	Description
Consolidation Mode	<p>Select the consolidation mode to indicate how the process that you are running writes its results to the applicable table.</p> <p>The Take Term Statistics Snapshot and the Recurring Term Snapshot processes write results to a temporary holding table (PS_STDNT_CARTRM_PD). Each student has only one row for an academic career, term, and snapshot date combination.</p> <p>The Consolidate Academic Statistics process writes results to the consolidated statistics table (PS_STDNT_CONS_STAT). Each student has only one row for each academic institution and academic statistics period combination. Values for this field are delivered with your system as translate values. Do not modify these values in any way. Any modifications to these values require a substantial programming effort. Select from the following choices.</p> <p><i>Insert:</i> Select this option to have the Take Term Statistics Snapshot process and the Recurring Term Snapshot process insert only new rows into the temporary holding table and leave untouched the rows in the table where students already have data for the academic career, term, and snapshot date combination. Or, select this option to have the Consolidate Academic Statistics process insert only new rows into the consolidated statistics table and leave untouched the rows in the table where students already have data for the academic institution and the academic statistics period combination specified for this run of the process.</p> <p><i>Overwrite:</i> Select this option to have the Take Term Statistics Snapshot process and the Recurring Term Snapshot process delete all existing rows from the temporary holding table where students already have data for the academic career, term, and snapshot date combination, <i>then</i> insert new rows into the table for students that have data for the academic career, term, and snapshot date combination. Or, select this option to have the Consolidate Academic Statistics process delete all existing rows from the consolidated statistics table where students already have data for the academic institution and academic statistics period combination specified on this page, <i>then</i> insert new rows into the table for students that have data for the academic institution and academic statistics period combination.</p>
Commit Frequency	<p>The system sets the commit frequency to 1. For other processes this is generally the best option. However, for these processes, you should set the commit frequency higher, such as 300, for faster processing of the job due to the potentially large volume of records.</p>

NSC Options

Use the NSC Options group box to override Institution Table (Academic Institution 3 page) options. This lets you use different processing options for different populations of students, where the student population is determined by the academic careers that are included in the academic statistics period. The Consolidated Statistics process will use the options defined in run control for the statistics period you select. For example, if the Institution Table option for **Terms with Missing Enrollment Status Data** has

an entry for "Summer Terms" and that value was removed for a run for a statistics period, the process would include Summer Terms rather than skip them for evaluating the student's enrollment history.

The options in this group box are similar to NSC Options group box on Academic Institution 3 page. For more information about how these options work, see “Setting Additional Institution Defaults and Options” (Campus Solutions Application Fundamentals).

Student Career Term Snapshot Input Parameters

Field or Control	Description
Academic Career	<p>The system displays a grid on the lower portion of the page only if the <i>Academic Statistics Period</i> that you select has <i>Consolidation Date</i> as its consolidation trigger. To populate the temporary holding table when you run the Take Term Statistics Snapshot process and the Recurring Term Snapshot process, enter the academic career, term, and snapshot date combinations for which you want the process to create student records in the temporary holding table. The combinations must be valid ones that your institution has defined for this academic statistics period on the Academic Statistics Period page.</p> <p>In this field, select the academic career for which you want the Take Term Statistics Snapshot process or the Recurring Term Snapshot process to create student records in the temporary holding table.</p>
Term	<p>Select the term within the academic career for which you want the Take Term Statistics Snapshot process or the Recurring Term Snapshot process to create student records in the temporary holding table.</p>
Overwrite	<p>Select to have the Take Term Statistics Snapshot process or the Recurring Term Snapshot process delete all existing rows from the temporary holding table (STDNT_CARTRM_PD), where students already have data for the academic career, term, and snapshot date combination, <i>then</i> insert new rows into the table for students that have data for the academic career, term, and snapshot date combination. Selecting this check box enables you to rerun the Take Term Statistics Snapshot process without retaining the values in the temporary holding table that were generated from a previous run of the process.</p> <p>If you set the Consolidation Mode field for the academic statistics period to <i>Insert</i>, then select the Overwrite check box for an individual row, the process deletes and replaces data records in the temporary holding table that match the academic institution, academic statistics period, academic career, and term for that individual row.</p>

Viewing Consolidated Academic Statistics for Individual Students

This section discusses how to use the Student Consolidated Stats component to view the results of the Consolidate Academic Statistics process (SRPCCONP) on a student-by-student basis for a specific academic statistics period. For example, perhaps a student has just enrolled in another class and you want to adjust this student's statistics to more accurately report them. The component divides the results into the following four categories:

- Basic data.
- Statistics.
- Withdrawal and external study information.
- Demographic data.

Related Links

[Understanding Consolidate Academic Statistics Process Calculations](#)

Pages Used to View Consolidated Academic Statistics for Individual Students

<i>Page Name</i>	<i>Definition Name</i>	<i>Navigation</i>	<i>Usage</i>
Student Consolidated Stats - Basic Data (student consolidated statistics - basic data)	STDNT_CONS_STATS0	Records and Enrollment > Enrollment Reporting > Consolidated Statistics > Student Consolidated Stats > Basic Data	View basic data about a student's consolidated academic statistics for an academic statistics period, such as the student's primary academic career, term, primary academic program, academic level and load determination, and academic program status. Also use this page to view the calculated results of the Consolidate Academic Statistics process (SRPCCONP) for the student's academic load, academic level, units, form of study, and GPA. If necessary, override the calculated results.
Student Consolidated Stats - Statistics (student consolidated statistics - statistics)	STDNT_CONS_STATS1	Records and Enrollment > Enrollment Reporting > Consolidated Statistics > Student Consolidated Stats > Statistics	View a student's consolidated term statistics and cumulative statistics for an academic statistics period.

Page Name	Definition Name	Navigation	Usage
Withdrawal/External Study	STDNT_CONS_STATS3	Records and Enrollment > Enrollment Reporting > Consolidated Statistics > Student Consolidated Stats > Withdrawal/ External Study	View withdrawals and cancellations on a student-by-student basis for an academic statistics period. Also use this page to view consolidated external study programs that apply towards a student's academic career, such as study abroad.
Demographics/Last Action	STDNT_CONS_STATS6	Records and Enrollment > Enrollment Reporting > Consolidated Statistics > Student Consolidated Stats > Demographics/ Last Action	View a student's age category, ethnic group, primary cohort, and latest consolidation status for the academic statistics period.
NSC Data Elements	SSR_STDNT_CONS_ST2	Records and Enrollment > Enrollment Reporting > Consolidated Statistics > Student Consolidated Stats > NSC Data Elements	View and edit a student's NSC program data for a statistics period.

Viewing Basic Data

Access the Student Consolidated Stats - Basic Data page (**Records and Enrollment > Enrollment Reporting > Consolidated Statistics > Student Consolidated Stats > Basic Data**).

This example illustrates the fields and controls on the Student Consolidated Stats - Basic Data page. You can find definitions for the fields and controls later on this page.

<i>Field or Control</i>	<i>Description</i>
Academic Institution	Select the academic institution that contains the consolidated academic statistics of the student.
Academic Statistics Period	The page displays the student's consolidated academic statistics for each applicable academic statistics period that you have run.

Calculated Values and Overrides

Click the arrow on the left of the **Calculated Values and Overrides** group box title bar to display the calculated statistical results of the Consolidate Academic Statistics process (SRPCCONP) for various types of statistics. Select the **Override** check box next to each type of statistic to change the calculated results. The corresponding field becomes available. Enter the new value. The calculated results of

the process itself always appear, unaltered on this page so that you can compare the original process calculation to your changes.

Field or Control	Description
Calculate	<p>If the academic statistics period for which you have calculated the student's consolidated academic statistics has <i>As of Date</i> or <i>As of Today</i> for its consolidation trigger, you can recalculate the student's consolidated statistics. Click this button to have the system rerun the Consolidate Academic Statistics process for this student's academic record in the academic institution and academic statistics period that you specify.</p> <p>If the academic statistics period has <i>Consolidate Date</i> for its consolidation trigger, then rerunning the Consolidate Academic Statistics process with the Calculate button has no bearing on the student's calculated results. This is because the process is retrieving statistics from the temporary holding table populated by either the Take Term Statistics Snapshot process (SRPCCONA) or the Recurring Term Snapshot process (SRPCCONU) rather than retrieving data from the student's records. The only way to recalculate a student's academic statistics in such a case is to first retake the term snapshots through the Term Statistics Snapshot process or the Recurring Term Snapshot process.</p>

Note: For NSC Reporting, using grade exclusions impacts how the Consolidate Academic Statistics process calculates ACADEMIC_LOAD. It is likely that some students—those with units excluded from calculation based on a grade (or grades)—will have a different academic load reported in Consolidated Statistics than the load calculated for the same term in STDNT_CAR_TERM.

See [Understanding Consolidated Statistics Processes](#).

See [Setting Up Statistic Period Types](#).

Viewing Statistics

Access the Student Consolidated Stats - Statistics page (**Records and Enrollment > Enrollment Reporting > Consolidated Statistics > Student Consolidated Stats > Statistics**).

Field or Control	Description
Reset Cum Stats at Term Start (reset cumulative statistics at term start)	<p>If this check box is selected, all statistics have been reset to zero at the start of the given term. If this check box is cleared, statistics have been accumulated from previous terms and added to the given term. This check box is set on the Cumulative Statistics page of the Term History component.</p>

Viewing Withdrawal and External Study Information

Access the Withdrawal/External Study page (**Records and Enrollment > Enrollment Reporting > Consolidated Statistics > Student Consolidated Stats > Withdrawal/External Study**).

The system displays the student's withdrawal and external study statistics for an academic statistics period based on the student's primary academic career, primary academic program, and last term within the academic statistics period.

Viewing and Editing NSC Data Elements

Access the NSC Data Elements page (**Records and Enrollment > Enrollment Reporting > Consolidated Statistics > Student Consolidated Stats > NSC Data Elements**).

This example illustrates the fields and controls on the NSC Data Elements page. You can find definitions for the fields and controls later on this page.

*Seq Nbr	Student Plan	*CIP Code	CIP Code Description	*Year CIP Code Published	Classification Code	Classification Description	*Program Length	*Length Code	Length Code Description	Program Weeks in Title IV Year
1	Business Management	52.02	Business Administration, Manag	2020	03	Bachelor's Degree	4.000	Y	Years	
2	Economics	45.0601	Economics, General	2020	03	Bachelor's Degree	4.000	Y	Years	

Field or Control	Description
Process Status	Indicates the status of the Consolidated Statistics period.
Override NSC Data Elements	When selected, you can edit the fields on the Statistics grid.
Updated by/Last Update Time	Indicates who and when a last update was made.
NSC Program Indicator	This check box is always selected where there is data in NSC Data Elements.

NSC Data Elements History by CIP Code

These grids include a row for each distinct NSC program that's reported for the statistics period (up to a maximum of 6 rows).

The General Information grid displays identifier data for the NSC program.

Field or Control	Description
Seq Nbr	A sequence number will be listed for each set of NSC program data that's reported for the student in the statistics period (SSR_SSR_STD_CON_ST2.SSR_NSC_PRG1_ through PRG6_).
Student Plan	Shows the description for the student's plan. If multiple plans have been reported/merged under one CIP code, there will be multiple entries.
CIP Code	Shows the CIP code associated with Plan (value from ACAD_PLAN_TBL.CIP_CODE).
CIP Code Description	Shows the description for the CIP code from CIP Code table (CIP_CODE_TBL).
Year CIP Code Published	Shows the value from the Statistics Type definition (ACAD_STAT_TP_TBL.SSR_NSC_PRG_CIPYR).
Classification Code	Shows the mapped value from the Credential Level Cross Reference table (SFA_CRDLVL_XREF.SSR_NSC_CRD_LVL) need path.
Program Length	Shows the value from ACAD_PLAN_TBL.SSR_PROG_LENGTH.
Length Code	Shows the value from ACAD_PLAN_TBL.SSR_PROG_LEN_TYPE.
Program Weeks in Title IV Year	This value is reported if the length code is Weeks or Months.

The Statistics grid shows NSC program-level data that's calculated for the statistics period.

Field or Control	Description
Program Begin Date	Shows the value from ACAD_PLAN.DECLARE DT for the student's max.
SULA Special Program Indicator	Shows the value from ACAD_PLAN_TBL.SFA_SPEC_PROG_FLAG for the reported plan.

<i>Field or Control</i>	<i>Description</i>
SULA Special Program Description	Shows the description for the SULA special program indicator
Enrollment Status Code	Shows value from SSR_STD_CON_ST2.SSR_NSC_PRGn_ENRST.
Enrollment Status Description	Shows the description for the reported enrollment status.
Enrollment Status Date	Shows the value from SSR_STD_CON_ST2.SSR_NSC_PRGn_ENRDT.
Enrollment Data Adjusted	If this check box is selected, it means the enrollment status date has been adjusted based on an evaluation of the student's consolidated statistics history. That is, the date has been determined not only by the statistics periods that were run but also any prior statistics period data generated for the student.

Field or Control	Description
Process Message	<p>These are the possible values:</p> <ul style="list-style-type: none"> • Legacy Data: This status appears if statistics were generated prior to enabling the code changes that were implemented in Update Image 28. • Success: This indicates the process completed successfully—no adjustments were made to the enrollment status effective date. • Same CIP Merged: This status appears if Consolidate by NSC Five-Point Match Criteria is enabled and two or more plans are matched. • Incomplete Data: This status appears if enrollment status effective data was recalculated but the student’s career term data includes a term row (STDNT_CAR_TERM) with a term value that is less than the earliest available row of data for the student in historical student consolidated statistics data (STDNT_CONS_STAT, SSR_STD_CON. • Same CIP Found: This status appears if Consolidate by NSC Five-Point Match Criteria isn't enabled. This serves as a warning message to alert the user of possible duplicates. • Date Based On Enrollment Data: This status appears when the process finds discrepancies in the historical statistics data and used STDNT_CAR_TERM or STDNT_ENRL data to calculate a revised enrollment status effective date. • Date Based on As Of Date: This status indicates the process was unable to calculate a revised enrollment status date using historical statistics data or by evaluating STDNT_CAR_TERM or STDNT_ENRL data and therefore used the Statistics Period.
Show History	<p>Click to access the National Student Clearinghouse (NSC) History by CIP Keys page. That page displays all available consolidated statistics historical data for this combination of Plan CIP code, Plan Credential Level, Program Published Length, Program Published Length Measurement, and Program Weeks in Title IV Academic Year.</p>

History by CIP Keys

This example illustrates the fields and controls on the National Student Clearinghouse (NSC) History by CIP Keys page.

NSC Data Elements History By CIP Keys							
As of Date	Academic Statistics Period	Program Begin Date	Enrollment Status Code	Enrollment Status Description	Enrollment Status Date	Enrollment Date Adjusted	Process Message
09/15/2022	NSC0890-02	08/30/2018	F	Full Time	08/29/2022	<input checked="" type="checkbox"/>	Success
09/09/2022	NSC0890-01	08/30/2018	F	Full Time	08/29/2022	<input type="checkbox"/>	
06/09/2022	NSC0885-01	08/30/2018			05/22/2022	<input type="checkbox"/>	
02/17/2022	NSC0880-02	08/30/2018	H	Half Time	01/23/2022	<input type="checkbox"/>	
02/02/2022	NSC0880-01	08/30/2018	H	Half Time	01/23/2022	<input type="checkbox"/>	
09/15/2021	NSC0870-02	08/30/2018	H	Half Time	08/29/2021	<input type="checkbox"/>	
09/09/2021	NSC0870-01	08/30/2018	H	Half Time	08/29/2021	<input type="checkbox"/>	
02/17/2021	NSC0860-02	08/30/2018	F	Full Time	01/23/2021	<input type="checkbox"/>	
02/02/2021	NSC0860-01	08/30/2018	F	Full Time	01/23/2021	<input type="checkbox"/>	
09/09/2020	NSC0850-01	08/30/2018	L	Less Than Half Time	08/29/2020	<input type="checkbox"/>	

This page provides a view of enrollment status/status date that's reported for this program for all available statistics periods.

The plan description and keys for the selected row are displayed in the header—CIP Code, Classification Code, Program Length/Measurement, and Title IV Year.

The NSC Data Elements History table provides a view of all available consolidated statistics for the student with this combination of NSC attributes, in descending “As of Date” order, and includes the following data:

- As of Date
- Academic Statistics Period
- Program Begin Date
- Enrollment Status Code
- Enrollment Status Description
- Enrollment Status Date
- Enrollment Date Adjusted
- Process Message

Viewing Consolidated Academic Statistics for Groups of Students

This section discusses how to view mass consolidated academic statistics.

Related Links

[Understanding Consolidate Academic Statistics Process Calculations](#)

Page Used to View Consolidated Academic Statistics for Groups of Students

<i>Page Name</i>	<i>Definition Name</i>	<i>Navigation</i>	<i>Usage</i>
Mass Consolidated Statistics	STDNT_CONS_MASS0	Records and Enrollment > Enrollment Reporting > Consolidated Statistics > Mass Consolidated Statistics > Mass Consolidated Statistics	Search for and view groups of students and update their consolidated academic statistics.

Viewing Mass Consolidated Academic Statistics

Access the Mass Consolidated Statistics page (**Records and Enrollment > Enrollment Reporting > Consolidated Statistics > Mass Consolidated Statistics > Mass Consolidated Statistics**).

By searching for statistics on groups of students within an academic statistics period, you can easily override the results of the Consolidate Academic Statistics process for every student in the group. The system retrieves the consolidated academic statistics for the students that meet your selection criteria and displays these statistics in the grid in the lower portion of the component. For example, perhaps your institution had consolidated academic statistics yesterday for a particular academic statistics period but discovers today that a group of law students need to enroll in a new class. This changes their academic load. To correct the inconsistency in their academic statistics, you can use the Mass Consolidated Statistics component to override the academic load that the Consolidate Academic Statistics process calculated for the law students.

Searching for Statistics on Groups of Students

Select the search criteria to find and display consolidated academic statistics for a student or group of students within an academic statistics period.

<i>Field or Control</i>	<i>Description</i>
Multiple Academic Career	Select to have the system retrieve only those students who have multiple academic careers and also meet your search criteria.

<i>Field or Control</i>	<i>Description</i>
Excluded Eligible Term Warn	Select to have the system retrieve only those students who meet your search criteria and also have been excluded from financial aid eligibility due to an insufficient number of units.
Search	Click to have the system retrieve and display the results meeting your selection criteria. The system pulls the statistics from the consolidated statistics table (PS_STDNT_CONS_STAT) and displays the results in the grid in the lower portion of the component. Select the tabs to move from one set of statistics to the next.

Viewing Statistics for Groups of Students

The system retrieves the statistics that meet your criteria from the consolidated statistics table (PS_STDNT_CONS_STAT) and displays the search results in the grid in the lower portion of the component. The system displays each student's consolidated academic statistics on a separate row. Use the horizontal tabs to move from one set of statistics to the next.

To override a student's calculated results, select the **Overrides** tab, select the check boxes that pertain to the statistics to override, then move to the applicable tab to change the statistics to override. The system always displays the unaltered process results on the various tabs of this component so that you can compare the process calculation to your changes.

After you update the consolidated academic statistics, click the **Save** button and the system stores your changes. The changes also appear in the Student Consolidated Stats component.

Note: For NSC Reporting, using grade exclusions impacts how the Consolidate Academic Statistics process calculates ACADEMIC_LOAD. It is likely that some students—those with units excluded from calculation based on a grade (or grades)—will have a different academic load reported in Consolidated Statistics than the load calculated for the same term in STDNT_CAR_TERM.

See [Understanding Consolidated Statistics Processes](#).

See [Setting Up Statistic Period Types](#).

Producing NSC Extracts

This section discusses how to run the National Student Clearinghouse (NSC) Report process (SRNSLCEX.SQR) to produce an NSC extract.

Page Used to Produce an NSC Extract

Page Name	Definition Name	Navigation	Usage
NSC Report	RUNCTL_SRNSLC	Records and Enrollment > Enrollment Reporting > NSC Report > NSC Report	Run the NSC Report process to generate a flat file extract of students enrolled during a specific period of time that you can then send electronically to the NSC.

Running the NSC Report Process

Access the NSC Report page (**Records and Enrollment > Enrollment Reporting > NSC Report > NSC Report**).

This example illustrates the fields and controls on the NSC Report page. You can find definitions for the fields and controls later on this page.

NSC Report

Run Control ID: PS [Report Manager](#) [Process Monitor](#) Run

*Academic Institution: PeopleSoft University

*Academic Statistics Period: Spring 2005 Report 1

SSN Exclusions:

*Branch Code:

*Report Type:

*Address Usage: Home, Mailing, Permanent, Work

*FICE Code:

*Output File:

Note: For information about the impact of grade exclusions on Academic Load calculation and Enrollment Status Change Date in NSC Reporting:

See [Understanding Consolidated Statistics Processes](#).

See [Setting Up Statistic Period Types](#).

The NSC Extract report lists all students who have been enrolled at your academic institution during an academic statistics period. The NSC Extract process compiles the students' enrollment statuses based on the statistics that the system saves in the consolidated statistics table (PS_STDNT_CONS_STAT) and in the SSR_STD_CON_ST2 table (for program level data) when you run the Consolidate Academic Statistics process. A single row of data per student is reported.

See [Setting Up For NSC Program Level Reporting](#)

See [Understanding Consolidate Academic Statistics Process Calculations](#)

If a student has been withdrawn from an academic career (through the Term History - Withdrawal page), the system sets the WITHDRAWAL_CODE field on the student's career term record (STDNT_CAR_TERM) to WDR. Because the consolidated statistics processes gather students' career term data, the processes are able to include this withdrawal information in the consolidated statistics table. The NSC Extract process is thus able to include the academic career data for these withdrawn students in the extract. The NSC Extract process uses the status date of the withdrawal from the **Last Date of Attendance** field on the Term History - Withdrawal page.

In addition to the extract, the NSC Extract process produces a report (in pdf format). The report includes a header record identifying the institution (Federal Interagency Committee on Education code and branch code), date of file, term of reporting, and whether the report is standard, nonstandard, or graduate only; a detail record (by student ID) listing informational messages describing any error or warning conditions that may need to be corrected. The trailer record includes the total number of student records in the extract file, a list of the students not included in the extract file, and messages stating why the process has not included these students (such as missing addresses, blank or invalid Social Security numbers, and invalid enrollment status). You can then fix the errors at the source.

Run the NSC Report process (SRNSLCEX.SQR) on a timeline that your institution determines in agreement with NSC.

Field or Control	Description
Academic Institution	Select the academic institution for which you are producing the report.
Academic Statistics Period	Select the academic statistics period for which you are producing the report.
SSN Exclusions (social security number exclusions)	Use these fields to exclude school-generated Social Security numbers and identification numbers from the NSC Extract report, as required by the NSC. Enter into each field the first three digits of the series you want to exclude, such as the 000 series and the 999 series. The NSC Extract process excludes all Social Security numbers within the series. You can list anywhere from zero to five series.
Branch Code	Select the branch code for the NSC extract.

Field or Control	Description
Report Type	<p>Select from the following choices the report type for the NSC extract. Values for this field are delivered with your system as translate values. Do not modify these values in any way. Any modifications to these values require a substantial programming effort.</p> <p><i>Graduates Only:</i> The process includes only graduated students.</p> <p><i>Non-Standard Report:</i> The process includes only academic sessions not considered <i>regular</i> academic sessions, such as summer session.</p> <p><i>Standard Report:</i> The process includes only <i>regular</i> academic sessions.</p>
Address Usage	<p>Select the address usage that the NSC Extract process should follow. Address usage is how the process locates the address of students included in the extract.</p>
FICE Code (Federal Interagency Committee on Education code)	<p>Enter the FICE code to appear in the NSC extract for this academic institution. This value appears by default from the Academic Institution 3 page.</p>
Output File	<p>In addition to sending report output for this process to a file (through setting preferences in the Process Monitor), you can also send any additional output files created by this process to a file directory. To send the extract output to a file directory, enter a valid directory path that maps to a folder with appropriate read and write permission. If you cannot locate such a folder, consult your system administrator.</p>

Setting Up and Managing Veterans Benefit Reporting

Setting Up Veterans Benefit Reporting

This section discusses how to set up:

- Instruction mode mapping.
- Payment mapping.
- Net tuition and fees calculation.

Pages Used to Set Up Veterans Benefit Reporting

<i>Page Name</i>	<i>Definition Name</i>	<i>Navigation</i>	<i>Usage</i>
Instruction Mode Mapping	SSR_VB_INSTR_MAP	Records and Enrollment > Enrollment Reporting > Veterans Benefit Reporting > Veterans Benefit Setup > Veterans Instruction Mode Map > Instruction Mode Mapping	Map class instruction modes with Veterans Instruction modes of Distance Learning and Residential.
Payment Mapping	SSR_VB_PAY_MAP	Records and Enrollment > Enrollment Reporting > Veterans Benefit Reporting > Veterans Benefit Setup > Payment Mapping	Identify Veterans Benefit payment item type groups for Federal, State and Yellow Ribbon funding.
Net Tuition and Fees Setup	SSR_VB_TF_SETUP	Records and Enrollment > Enrollment Reporting > Veterans Benefit Reporting > Veterans Benefit Setup > Net Tuition and Fees Setup	Identify eligible tuition, fees, financial aid and waivers for the Veterans Net Tuition and Fees calculation.

Setting Up Instruction Mode Mapping

Access the Instruction Mode Mapping page (**Records and Enrollment > Enrollment Reporting > Veterans Benefit Reporting > Veterans Benefit Setup > Veterans Instruction Mode Map > Instruction Mode Mapping**).

This example illustrates the fields and controls on the Instruction Mode Mapping page . You can find definitions for the fields and controls later on this page.

Instruction Mode Mapping

Academic Institution PSUNV PeopleSoft University

Personalize Find First 1-8 of 8 Last					
	Instruction Mode		Veterans Instruction Mode		
1	CO <input type="text"/>	Correspondence	Distance Learning <input type="text"/>	+	-
2	CT <input type="text"/>	Closed Circuit TV	Residential <input type="text"/>	+	-
3	IN <input type="text"/>	Internet	Distance Learning <input type="text"/>	+	-
4	IS <input type="text"/>	Independent Studies	Distance Learning <input type="text"/>	+	-
5	P <input type="text"/>	In Person	Residential <input type="text"/>	+	-
6	TV <input type="text"/>	Television	Residential <input type="text"/>	+	-
7	VT <input type="text"/>	Videotape	Distance Learning <input type="text"/>	+	-
8	WW <input type="text"/>	World Wide Web	Distance Learning <input type="text"/>	+	-

Use this page to map the instruction mode of a class to a veterans instruction mode.

The Enrollment Certification page uses this mapping to categorize class units taken as Residential or Distance Learning.

See [Certifying Student Enrollment](#)

Field or Control	Description
Instruction Mode	Select an instruction mode. Values are inherited from the Instruction Mode field on the Components page (Curriculum Management > Course Catalog > Course Catalog > Components). See Defining Course Components
Veterans Instruction Mode	Map a class instruction mode to a veterans instruction mode of either <i>Residential</i> or <i>Distance Learning</i> , but not both.

Setting Up Payment Mapping

Access the Payment Mapping page (**Records and Enrollment > Enrollment Reporting > Veterans Benefit Reporting > Veterans Benefit Setup > Payment Mapping**).

This example illustrates the fields and controls on the Payment Mapping page. You can find definitions for the fields and controls later on this page.

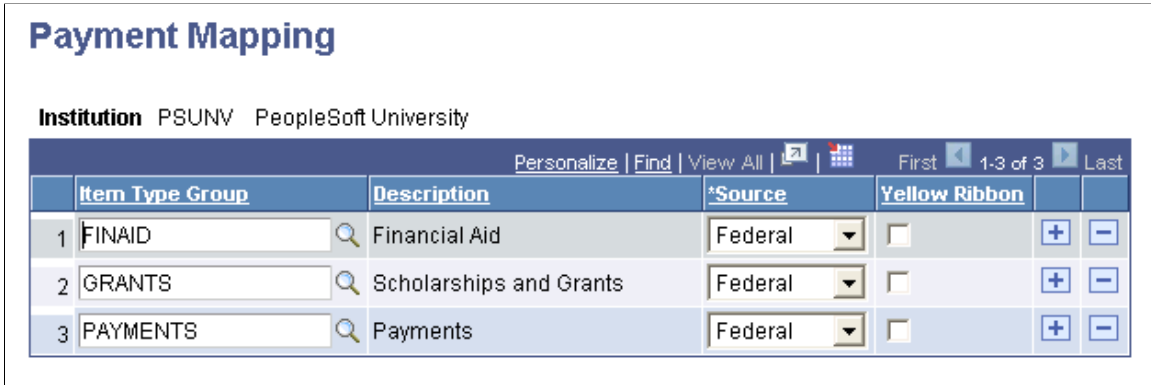

Use this component to map veterans payments with their source of funds.

Field or Control	Description
Item Type Group	Select an item type group to map with its funding source. Item type groups are defined on the Item Types Group page and in the Tree Manager. See “Defining Item Type Groups” (Student Financials) See <i>PeopleTools: Tree Manager</i>
Source	Select a funding source to correspond with the particular item type group. Select either <i>Federal</i> or <i>State</i> as the source.
Yellow Ribbon	Select the Yellow Ribbon check box if the particular item type group is funded through the Yellow Ribbon program. The check box is available only if the source is Federal.

The setup on this page defines the Source and Yellow Ribbon data that appear on the Payment History page.

See [Viewing Veterans Payment History](#)

Setting up Net Tuition and Fees

Access the Net Tuition and Fees Setup page (**Records and Enrollment > Enrollment Reporting > Veterans Benefit Reporting > Veterans Benefit Setup > Net Tuition and Fees Setup**).

This example illustrates the fields and controls on the Net Tuition and Fees Setup page. You can find definitions for the fields and controls later on this page.

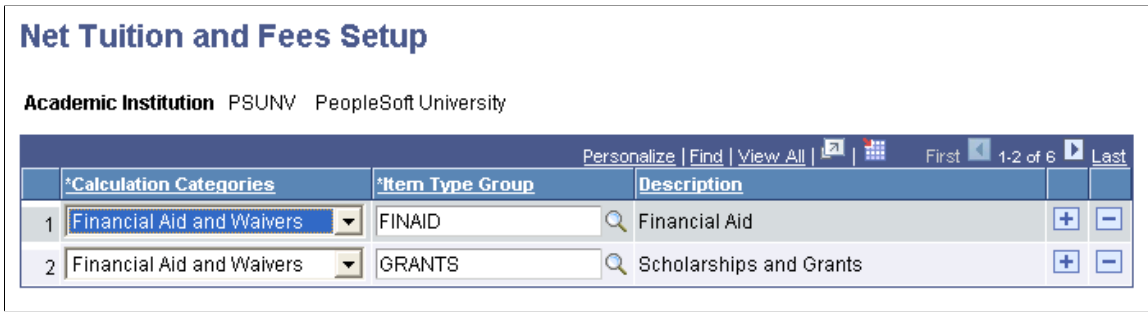

Use this component to define eligible item type groups to be used to calculate the Veterans' Net Tuition and Fees as tuition, fees, financial aid and waivers. The Veterans Tuition Worksheet page inherits item type groups for calculation from this page.

See [Calculating Net Tuition and Fees](#)

Field or Control	Description
Calculation Categories	Select a calculation category from the list to map it with a particular item type group. You can select either <i>Tuition and Fees</i> or <i>Financial Aid and Waivers</i> .
Item Type Group	Select an item type group to map it with a calculation category.

Managing a Student's Veterans Benefit Information

This section discusses how to define and maintain Veterans Benefit information for a student.

Pages Used to Manage a Student's Veterans Benefit Information

Page Name	Definition Name	Navigation	Usage
Veterans Benefit Summary	SSR_VB_DATA	Records and Enrollment > Enrollment Reporting > Veterans Benefit Reporting > Veterans Benefit Summary	Define and maintain a summary of a student's Veterans Benefit.
Attachments	SSR_VB_ATTACH	Records and Enrollment > Enrollment Reporting > Veterans Benefit Reporting > Veterans Benefit Summary > Attachments	Attach Veterans Benefit-related documents.

Defining and Maintaining Veterans Benefit Information for a Student

Access the Veterans Benefit Summary page (**Records and Enrollment > Enrollment Reporting > Veterans Benefit Reporting > Veterans Benefit Summary**).

This example illustrates the fields and controls on the Veterans Benefit Summary page (1 of 2). You can find definitions for the fields and controls later on this page.

James Estevez ID AD6047
 Academic Institution PSUNV PeopleSoft University
 Term 2160 Acad year 2016-2017

Benefits Summary

Bio Demo Details

SSN *****
 Active Duty
 VA Spouse
 VA Dependent
 Yellow Ribbon

Military Branch

Army
 Air Force
 Coast Guard
 Marine Corps
 Navy

Person Record

Academic Details

Personalize | Find | View All | 1 of 1 | First | Last

Academic Summary	Residency, GPA and Acad Standing	Effective Date	Academic Load	Academic Program	Academic Plan	Academic Sub-Plan
1				Academic Program		

This example illustrates the fields and controls on the Veterans Benefit Summary page (2 of 2). You can find definitions for the fields and controls later on this page.

Federal Benefit Details Find | View All | First | 1 of 1 | Last

Federal Benefit Fields Find | First | 1 of 1 | Last

*Attribute

Comments

254 characters remaining

Last Update Date/Time
Updated By

State Benefit Details Find | View All | First | 1 of 1 | Last

State Benefit Fields Find | First | 1 of 1 | Last

*Attribute

Comments

254 characters remaining

Last Update Date/Time
Updated By

Bio Demo Details

Enter or update the student's biographical details.

For information on how to mask the social security number:

See “Applying Demographic Data Access Security” (Campus Solutions Application Fundamentals)

For information about service indicators:

See “Setting Up Service Indicator Codes and Reasons” (Campus Community Fundamentals)

Field or Control	Description
Yellow Ribbon	Select this check box if the student is enrolled in the Yellow Ribbon program. If the check box is selected, the system displays the Yellow Ribbon section on the Tuition Worksheet.
Person Record	Select this link to access the student's biographical and demographic data. Use the Addresses page to indicate the address to which the Veterans Benefit check is to be sent. The Veterans Administration verifies that the recipient's address they have matches the address that your institution indicates.

Federal Benefit Details and State Benefit Details

The attributes available here are those that you define on the Common Attribute page (Set Up SACR, Common Definitions, Common Attributes Setup, Common Attribute).

After you define attributes, associate attributes with a record context on the Record Context page (Set Up SACR, Common Definitions, Common Attributes Setup, Record Context).

The delivered record contexts are SSR_VB_FED_AUD and SSR_VB_STA_AUD.

See “Understanding Common Attribute Framework” (Campus Community Fundamentals)

See “Defining a Common Attribute” (Campus Community Fundamentals)

See “Associating a Common Attribute to a Record” (Campus Community Fundamentals)

Creating and Updating Terms

This section discusses how to create and update terms.

Page Used to Create or Update Terms

Page Name	Definition Name	Navigation	Usage
Create/Update Term Process	SSR_VB_RC_UPDTRM	Records and Enrollment > Enrollment Reporting > Veterans Benefit Reporting > Create/Update Term Process	Create the Net Tuition and Fees page and the Enrollment Certification page; and update records.

Creating and Updating Terms

Access the Create/Update Term Process page (**Records and Enrollment > Enrollment Reporting > Veterans Benefit Reporting > Create/Update Term Process**).

This example illustrates the fields and controls on the Create/Update Term Process page. You can find definitions for the fields and controls later on this page.

Create/Update Term Process

Run Control ID: PS [Report Manager](#) [Process Monitor](#) [Run](#)

*Academic Institution: PSUNV PeopleSoft University

*Term: 0730 2014 Fall

*Mode: Update Tuition Worksheet

Include Federal

Include State

Include Both Federal and State

Population Selection

Population Selection

Selection Tool: PS Query

Query Name: SSR_VB_POP_UPDTERM

[Launch Query Manager](#) [Preview Selection Results](#)

Update Enrollment Mode

Depending on the status of the record, the system performs various tasks when you run the Create/Update Term process:

- **New Records:** If no enrollment certification record exists for the student and the term, the system creates a record. For a student's enrolled units and academic history, it populates fields on the Enrollment Certification page. The new record is set to *In review* status and is listed in the log as a new record with the student name and EMPLID. If the class status is *Dropped*, the system populates the **Drop Date** field; and if the attendance roster is used, the **Last Date Attended** field. The system also calculates the number of units taken for *Residential* and *Distance Learning* classes.
- **In Review Records:** For records with an *In review* status, the system overrides any manual changes made to the record and updates the term Enrollment Information.
- **Reported Records:** For records with a *Reported* status, the system versions the existing record and creates a new record for the student with the *In review* status. The system logs all records sequenced by this process with the Student Name and EMPLID information.

Update Tuition Worksheet Mode

When you select this mode, the following options become available on the page:

- Include Federal
- Include State

- Include Both Federal and State

Depending on the status of the record and the option selected, the system performs various tasks when you run the Create/Update Term process:

- New Records: If no Tuition Worksheet exists for the student for the term, the system creates a record.
- In Review Records: If a record exists with an *In review* status, the Tuition Worksheet replaces the In Review record, assigning it an *In review* status. The system logs all records created by this process with the Student Name and EMPLID information.

If **Both Federal and State** is selected, both State and Federal Tuition Worksheets are updated. If the Benefit Summary page contains information related to the State, then the system creates a State Tuition Worksheet with an *In review* status.

- Reported Records: If a record exists with the *Reported* status and you run the Create/Update Term Process, the system creates a new incremental record for the student with an *In review* status.

The system updates both Federal and State Tuition Worksheets if **Both State and Federal** is selected. If a State Tuition Worksheet does not exist, the system creates it if the Benefit Summary page has any fields defined for the term. The system logs all records sequenced by this process with the Student Name and EMPLID information.

Population Selection

The Population Selection group box is a standard group box that appears on run control pages when the Population Selection process is available or required for the transaction. Selection tools are available based on the selection tools that your institution selected in the setup of the Population Selection process for the application process and on your user security. Fields in the group box appear based on the selection tool that you select. The fields behave the same way from within the group box on all run control pages and application processes. If your institution uses a specific delivered selection tool to identify IDs for a specific transaction, you must use it.

Field or Control	Description
Selection Tool	Select <i>PS Query</i> .
Query Name	The <i>SSR_VB_POP_UPDTERM</i> query is delivered. If you create your own query, you must use the following bind record: <i>SSR_VB_UPDT_BND</i> .

See “Using the Population Selection Process” (Campus Community Fundamentals)

Certifying Student Enrollment

This section discusses how to certify a student's enrollment for a reporting period.

Page Used to Certify Student Enrollment

Page Name	Definition Name	Navigation	Usage
Enrollment Certification	SSR_VB_ENRL_CERT	Records and Enrollment > Enrollment Reporting > Veterans Benefit Reporting > Enrollment Certification	Review and certify student enrollment.

Certifying Student Enrollment For a Reporting Period

Access the Enrollment Certification page (**Records and Enrollment > Enrollment Reporting > Veterans Benefit Reporting > Enrollment Certification**).

This example illustrates the fields and controls on the Enrollment Certification page. You can find definitions for the fields and controls later on this page.

The screenshot shows the 'Enrollment Certification' page for student ID SFRP0001, Name Cole Powell, at PSUNV PeopleSoft University, Term 0700 2013 Spring. The page is in 'In Review' status. It features a 'Term Enrollment Details' section with a table of class certifications. Below the table are sections for 'Federal Certified Units' and 'State Certified Units'.

Class Nbr	Subject Area	Catalog Nbr	Section	Location	Zip Code	Career	Primary Academic Program	Federal Cert	Federal Review Date	Federal Review By	State Cert	State Review Date	State Review By
1210	ART	112	1			Undergraduate	LAU						
1293	ENGLCOMP	10	1			Undergraduate	LAU						
1342	BIOLOGY	140	1			Undergraduate	LAU						
1396	BIOLOGY	140	1A			Undergraduate	LAU						

Field or Control	Description
Status	<p><i>In Review:</i> The page can be updated by the Create/Update Term process.</p> <p><i>Reported:</i> The page is display only. Any updates that result from the Create/Update Term process create another page with an <i>In Review</i> status for the term.</p>

Term Enrollment Certification

Select the Class Certification tab.

Certify the eligible classes where the student has enrollment. Some fields in this group box inherit their values from the Enrollment Summary page. Select the certification of the class—Federal or State— if

applicable. You may leave **State Cert** blank if there is no State-level Veterans Administration for the institution; in which case, the corresponding units do not reflect in the total **State Certified Units**. On save, the **Review Date** and **Review By** fields are updated and totals displayed.

Select the Class Detail tab:

View details about the student's class activity during the term. If a class is dropped, the **Drop Date** field is populated. If the attendance roster is being used, the **Last Date Attended** is calculated. You can override or manually enter the date.

Select the Unit Detail tab:

View details about residential, distance learning units, and remedial clock hours and units, if applicable. If the class is **Remedial**, and the indicator is set to *Yes*, then the **Remedial Units** field is populated. If applicable, enter the number of clock hours per week for the student in the **Clock Hrs/Week** field.

Calculating Certified Units

Review information about **Federal Certified Units** and **State Certified Units**. Based on information entered in the **Class Certification** fields, the system calculates the total of Federal-certified and State-certified units. It provides details of residential, distance learning and remedial units, and the total number of clock hours, if applicable, for Federal-certified classes.

Calculating Net Tuition and Fees

This section discusses how use the Tuition Worksheet to calculate net tuition and fees for a student. It discusses:

- Calculating Federal Net Tuition and Fees
- Calculating State Net Tuition and Fees

Pages Used to Calculate Net Tuition and Fees

Page Name	Definition Name	Navigation	Usage
Federal Benefit Details	SSR_VB_TUI_WRK_FED	Records and Enrollment > Enrollment Reporting > Veterans Benefit Reporting > Veterans Tuition Worksheet > Federal Benefit Details	Calculate net tuition and fees for Federal reporting.
State Benefit Details	SSR_VB_TUI_WRK_STA	Records and Enrollment > Enrollment Reporting > Veterans Benefit Reporting > Veterans Tuition Worksheet > State Benefit Details	Calculate net tuition and fees for State reporting.

Calculating Federal Net Tuition and Fees

Access the Federal Benefit Details page (**Records and Enrollment > Enrollment Reporting > Veterans Benefit Reporting > Veterans Tuition Worksheet > Federal Benefit Details**).

Use this page to calculate net tuition and fees eligible for Federal benefit from the Veterans Administration.

Summary

<i>Field or Control</i>	<i>Description</i>
Use Actual	Select this calculation method to view the Actual Tuition and Fees section details.
Use Rate Per Unit	Select this calculation method to view the Rate Per Unit Tuition and Fees section details. Based on the Benefit Type selected— <i>Federal</i> or <i>State</i> —the Certified Units field displays the sum of certified units.
Use Equation	Select this calculation method to view the Tuition and Fees Equation section details.
Anticipated Payment	Enter the benefit amount anticipated from the Veterans Administration, if any. The maximum value is 99,999.99.

Actual Tuition and Fees

<i>Field or Control</i>	<i>Description</i>
Item Type	This field derives its values from the Tuition and Fees item type groups defined in the Net Tuition and Fees Setup page, with the amount assessed on the student's account for that term.
Override	Enter the amount to be overridden. Click Update to revise totals.

Rate Per Unit Tuition and Fees

Enter the rate per unit and click **Update** for the system to calculate the total tuition and fees.

Tuition and Fees Equation

Select an available Tuition and Fees equation to calculate the total tuition and fees. Click **Calculate** to return the Total Tuition and Fees. Click **Update** to revise Net Tuition and Fees.

See “Understanding Equation Engine” (Campus Solutions Application Fundamentals)

See “Defining an Equation” (Campus Solutions Application Fundamentals)

Financial Aid and Waivers

This displays the Financial Aid and Waivers actually disbursed on to the student accounts for the term. Eligible item type groups are defined on the Net Tuition and Fees Calculation Setup page. You can override an actual amount, add or delete an item type.

Yellow Ribbon

This section is visible only if the Yellow Ribbon option was selected on the Benefit Summary Page. Enter **Out of State** and **In State** tuition and fees and click **Update** to return the **Unmet Tuition and Fees** and **Veterans Payment**. You can store a predetermined amount from the Yellow Ribbon program for a student.

See [Setting Up Veterans Benefit Reporting](#)

Calculating State Net Tuition and Fees

Access the State Benefit Details page (**Records and Enrollment > Enrollment Reporting > Veterans Benefit Reporting > Veterans Tuition Worksheet > State Benefit Details**).

For information about the State Benefit Details page, refer to the section on Federal Benefit Details. It contains all the information required for this page.

Viewing Veterans Payment History

This section discusses how to view a student's Veterans payments.

Pages Used to View Veterans Payment History

<i>Page Name</i>	<i>Definition Name</i>	<i>Navigation</i>	<i>Usage</i>
Veterans Payment History	SSR_VB_PAY_HIST	Records and Enrollment > Enrollment Reporting > Veterans Benefit Reporting > Veterans Payment History	View a student's veterans payment history.

Viewing a Student's Veterans Payments

Access the Veterans Payment History page (**Records and Enrollment > Enrollment Reporting > Veterans Benefit Reporting > Veterans Payment History**).

Use the **Veterans Payment History** page to view the actual veterans payments applied to a student account and adjustments to the payments, if any. Click **Save** and reenter the page to view payments within the defined term range.

The Yellow Ribbon section appears only if the Yellow Ribbon check box is selected for an item type group in the Payment Mapping page.

<i>Field or Control</i>	<i>Description</i>
Comments	Use this field to save information relevant to the veterans benefit payments received.

Rolling Over a Student's Benefit Summary Information

This section discusses how to roll over a benefit summary.

Page Used to Roll Over a Student's Benefit Summary

<i>Page Name</i>	<i>Definition Name</i>	<i>Navigation</i>	<i>Usage</i>
Rollover Benefit Summary	SSR_VB_RUN_SUMM	Records and Enrollment > Enrollment Reporting > Veterans Benefit Reporting > Rollover Benefit Summary.	Transfer a student's benefit information from one term to another.

Rolling Over a Benefit Summary

Access the Rollover Benefit Summary page (**Records and Enrollment > Enrollment Reporting > Veterans Benefit Reporting > Rollover Benefit Summary**).

<i>Field or Control</i>	<i>Description</i>
Selection Tool	Select <i>PS Query</i> .
Query Name	The <i>SSR_VB_POP_ROLL_BNSUMM</i> query is delivered. If you create your own query, you must use the following bind record: <i>SSR_VB_ROLL_BND</i> .

See “Using the Population Selection Process” (Campus Community Fundamentals)

Viewing Student Records Process Messages

Viewing System Messages for Student Records COBOL Processes

You can view system messages for certain COBOL processes within Student Records that are specifically coded to use this message log. These processes log all messages to the student records message log table whenever you run them. The messages include successful completions of the process and errors that the process encounters. When you run one of these processes, the system displays a message indicating that you can view messages for the process on the Message Log page. Depending on the commit frequency of the process, you can usually view messages in this catalog only after the process finishes.

This section discusses how to view system messages.

Page Used to View System Messages for Student Records COBOL Processes

<i>Page Name</i>	<i>Definition Name</i>	<i>Navigation</i>	<i>Usage</i>
Message Log	MESSAGE_LOG_SR	Curriculum Management > Schedule of Classes > Review Message Log > Message Log	View system messages.

Viewing System Messages

Access the Message Log page (**Curriculum Management > Schedule of Classes > Review Message Log > Message Log**).

<i>Field or Control</i>	<i>Description</i>
Process Instance	A number that uniquely identifies each process request and its position in the queue. The system automatically increments and assigns a process instance value to each process request.

Field or Control	Description
Job ID	Multiple process definitions can be logically linked to a job request to process each request serially or in parallel, and optionally to initiate subsequent processes based on the return code from each prior request. If applicable, the system displays the identification code for the PSJob.
Program Name	If applicable, the system displays the name of the program within the PSJob to which the messages relate.
Message Sequence	Each individual message has a sequence in relation to the others, revealing the order in which the process wrote the messages to the log.
Severity	The system displays the severity of the message, such as <i>Error</i> .
Last Update Date Time	The date and time that the system last updated the message appears here.
Message Text	Information about the process status appears here. Typically, this field displays messages that describe the status of the program that you are running.
Explanation	A more detailed explanation of the message text appears here.

(AUS) Managing Enrollment Feedback

Understanding Enrollment Feedback

Each state in Australia has access to a Tertiary Admissions Centre (TAC) that makes offers of admission on behalf of participating institutions. After TAC makes the offers, each institution becomes responsible for recording all acceptances of offers and all subsequent enrollments.

The four TACs in Australia that make offers are the University Admissions Centre-NSW & ACT (UAC), South Australian Tertiary Admissions Centre (SATAC), Victorian Tertiary Admissions Centre (VTAC), and Queensland Tertiary Admissions Centre (QTAC).

The final phase of the main TAC admissions period is known generically as enrollment feedback and involves the return of statistical information about applicants to the relevant TAC. In this phase, it is verified whether or not those applicants who accepted offers are in fact enrolled at the institution as of the census date of 31 March.

The principal purpose of the Enrollment Feedback file is to collect enrollment information about applicants who have been made an offer of admission through a TAC. The information is used by the TACs, participating institutions, Department of Industry, Innovation, Science, Research and Tertiary Education (TCSI), New South Wales Vice Chancellors Committee (NSWVCC), Australian Vice Chancellors Committee (AVCC), and other organizations for statistical purposes and future TAC application processing.

Each TAC has an enrollment feedback file that differs in format and field type; however, three of the TACs just require a file to be created in their own specified format. These files all get processed through different software. The other TAC (QTAC) delivers two files that must have fields appended.

Note: Only students loaded into your system using the TAC Load process (SAD_TACLDANZ) appear on the Enrollment Feedback reports.

Common Elements Used to Manage Enrollment Feedback

<i>Field or Control</i>	<i>Description</i>
Admit Term	Enter the admit term for which you are reporting your students. The process captures and reports on any student loaded through the TAC Load process whose admit term matches the term you specify.
File Output	Enter the directory location and name for the enrollment feedback output files. The system displays one or more file output fields based on the TAC that you process.

Field or Control	Description
Input File Path	For QTAC and VTAC, enter the file name and directory location where your institution has put the files received from the TAC. The file name is determined as delivered by the TAC.
Institution	Enter the academic institution for which you want to generate an enrollment feedback report.
Run Date	Enter the date you want to use for the run date on the enrollment feedback report. The run date is usually 31 March each year. The system populates this field with today's date by default.

Processing Enrollment Feedback for QTAC

This section provides an overview of QTAC enrollment feedback processing and discusses how to report enrollment for QTAC.

Understanding QTAC Enrollment Feedback Processing

The final phase of the main QTAC admissions period involves a verification of whether applicants who accepted offers are in fact enrolled as of the census date of 31 March.

Two files are placed in the institution's account on the QTAC FTP server. The account name is identical to that used for the offer files.

As of 31 March, the following information is returned to QTAC:

- Names of individuals who are enrolled or not enrolled.
- Names of individuals who are enrolled in the same QTAC programs or a different QTAC program.
- Names of individuals who are now deferred.
- Names of individuals who are not on the acceptance list.

These individuals have lapsed offers that have been reinstated by the institution.

- Mode of attendance of each enrolled student.
- Type of attendance of each enrolled student.
- Student identification number of each enrolled student.

The institution may report this information to QTAC in one of two ways—as a bulk update or through the online system.

Reviewing Data Mapping for the QTAC Output File

This table lists the data mapping for the QTAC Enrollment Feedback files:

QTAC Field	PeopleSoft Field
QTAC Reference Number	ADM_APPL_DATA.Ext_adm_appl_nbr
Family_Name	NAMES.LAST_NAME
Given_Name_1	NAMES.FIRST_NAME
Given_Name_2	NAMES.MIDDLE_NAME
Date_of_Birth	PERSONAL_DATA.BIRTHDATE
Course_Code	ACAD_PROG_TBL.Program_cd
Final_Response	A,D,I,K
Final_Enrolment_Status	Y,N,Z
Inst_Student_Num	ADM_APPL_DATA.Emplid
Attendance Type	F,P, or blk
Attendance Mode	I,E,M or blk

Page Used to Create a QTAC Enrollment Feedback Report

Page Name	Definition Name	Navigation	Usage
Enrollment Feedback QTAC	SSR_RUN_QTACENRFLD	Records and Enrollment > Enrollment Reporting > Enrollment Feedback QTAC AUS > Enrollment Feedback QTAC	Generate enrollment feedback reports for QTAC.

Processing Enrollment Feedback for SATAC

This section provides an overview of SATAC enrollment feedback processing and discusses how to report enrollment for SATAC.

Understanding SATAC Enrollment Feedback Processing

Your reconciliation should ensure that the enrollment record and the SATAC acceptance record (response codes A & AB) are identical for all students new to each of your programs offered through SATAC.

The basic codes are shown in the following table:

SATAC Response Code	Definition
A or AB	Enrolled
F or FB	Deferred
K or KB	Withdrawn

The four distinct phases of the reconciliation process are:

1. SATAC data extract.

SATAC extracts the most up-to-date applicant information from its database and forwards it to its member institutions around the 31 March census date. Offer data can be then used by the member institution to add or update its information about SATAC applicants.

2. Reconciliation file prepared by institution.

Each member institution extracts information from its own enrollment records and creates a file of reconciliation data to return to SATAC. This file should contain data about all new course students whose application should be processed by SATAC.

3. SATAC edit, edit correction, and update process.

SATAC processes the reconciliation file returned from the member institutions in an iterative process. The process begins by running the edit program and reporting any validation errors in the data, then analyzing and correcting those errors (if possible). The next step is rerunning the edit program, reporting any errors, analyzing and correcting errors until all differences in the SATAC database and institutional files can be reconciled, and updating the SATAC database with the correct institutional data.

4. Reconciliation reporting.

Reports that summarize the results are prepared by SATAC for the member institutions. Any issues that need addressing are highlighted.

Reviewing Data Mapping for the SATAC Output File

The following table lists the data mapping for the SATAC Enrollment Feedback files:

SATAC Field	PeopleSoft Field
INST_Ref_Num	ADM_APPL_DATA.Ext_adm_appl_nbr
INST_Family_Name	NAMES.LAST_NAME
INST_Given_Name_1	NAMES.FIRST_NAME
INST_Given_Name_2	NAMES.MIDDLE_NAME
INST_Student_Number	ADM_APPL_DATA.Emplid
INST_Gender	PERSONAL_DATA.SEX
INST_Date_of_Birth	PERSONAL_DATA.BIRTHDATE
INST_Offer_Course_Code	ACAD_PROG_TBL.Program_cd
INST_Enrolment_Status	'A','F','K'
Filler	spaces

Page Used to Produce a SATAC Enrollment Feedback Report

Page Name	Definition Name	Navigation	Usage
Enrollment Feedback SATAC	SSR_RUN_ENROLFEED	Records and Enrollment > Enrollment Reporting > Enrollment Feedback SATAC AUS > Enrollment Feedback SATAC	Generate enrollment feedback reports for SATAC.

Processing Enrollment Feedback for UAC

This section provides an overview of UAC enrollment feedback processing and discusses how to report enrollment for UAC.

Understanding UAC Enrollment Feedback Processing

During UAC enrollment feedback processing, the system produces a data set for each offer extended through UAC. Each data set contains the following:

- Enrollment code.
- Student number.
- Attendance type.
- Attendance mode.

Each institution has its own connection to the UAC system and generates its own data set. This data set can be updated in two ways, either through a file upload or manual update. This data set contains all offers for a given institution and also provides several empty columns as placeholders to receive information supplied by the institution.

Reviewing Data Mapping for the UAC Output File

The following table lists the data mapping for the UAC Enrollment Feedback files. The file created is a comma delimited file. Numeric fields should be zero justified.

UAC Field	PeopleSoft Field
UAC Reference Number	ADM_APPL_DATA.Ext_adm_appl_nbr
UAC Course	ACAD_PROG_TBL.Program_cd
Emplid	ADM_APPL_DATA.Emplid
Enrolment	E,D,N
Attendance Type	F,P, or blk
Attendance Mode	I,E,M or blk

Page Used to Create a UAC Enrollment Feedback Report

Page Name	Definition Name	Navigation	Usage
Enrollment Feedback UAC	SSR_RUN_ENROLFEED	Records and Enrollment > Enrollment Reporting > Enrollment Feedback UAC AUS > Enrollment Feedback UAC	Generate enrollment feedback reports for UAC.

Processing Enrollment Feedback for VTAC

This section provides an overview of VTAC enrollment feedback processing and discusses how to report enrollment for VTAC.

Understanding VTAC Enrollment Feedback Processing

Enrollment feedback is also generated for the Victorian Tertiary Admissions Centre (VTAC).

Reviewing Data Mapping for the VTAC Output File

This table lists the data mapping for the VTAC Enrollment Feedback files:

<i>VTAC Field</i>	<i>PeopleSoft Field</i>
VTAC Application number	ADM_APPL_DATA.Ext_adm_appl_nbr
Surname	NAMES.LAST_NAME
First Given Name	NAMES.FIRST_NAME
Second Given Name	NAMES.MIDDLE_NAME
Category	TAC_SPS_VIC_ANZ.VIC_CATEGORY
Offered Course	ACAD_PROG_TBL.PROGRAM_CD
Street Name	ADDRESSES.ADDRESS1
Suburb	ADDRESSES.CITY
State	ADDRESSES.STATE
Postcode	ADDRESSES.POSTAL
Country	ADDRESSES.COUNTRY
Overseas Zip/Postcode	TAC_SPS_ANZ.OVERSEAS_ZIP

VTAC Field	PeopleSoft Field
Enrolment Indicator	Derived from PS_ADM_APPL_PROG.PROG_ACTION or PS_ACAD_PROG.PROG_ACTION depending if the student has been matriculated
Round number	TAC_SPS_ANZ.OFFER_ROUND_NUM
Acceptance Indicator	Provided by VTAC
Date of Birth	PERSONAL_DATA.BIRTHDATE

Page Used to Create a VTAC Enrollment Feedback Report

Page Name	Definition Name	Navigation	Usage
Enrollment Feedback VTAC	SSR_RUN_VTACENRLFD	Records and Enrollment > Enrollment Reporting > Enrollment Feedback VTAC AUS > Enrollment Feedback VTAC	Generate enrollment feedback reports for VTAC.

(AUS) Managing the Automated Results Transfer System

Understanding ARTS

ARTS is a national system that electronically distributes academic record information for current and former students who have applied for admission to an institution through a Tertiary Admissions Centre (TAC). The ARTS system enables the TAC to obtain academic records quickly and securely, in order to support the applications for students applying to programs of study at other institutions.

The ARTS process is initiated by the target institution's TAC, which sends a request for academic information to the target institution. The institution acknowledges the TAC request through an acknowledgment file and creates a result file with the student's academic record information. The institution then sends the result file to the TAC. When the TAC receives the results file, they send an acknowledgment file to the institution. The request file, the result file, and the acknowledgment file, are all transferred electronically between the TAC and the institution. The details of how this works are:

1. A TAC initiates a request for academic record information about a current or past student of an institution by creating a request file containing identifying information supplied by the student.
2. The admissions center encrypts the request file using a standard encryption process.
3. The admissions center transfers the encrypted request file to a target directory on the institution's system.
4. The institution renames and copies the request file to a working directory, decrypts and validates the request, and places an encrypted request acknowledgment file on the target directory.
5. The institution retrieves the academic record information and constructs and encrypts a result file.
6. The institution copies the encrypted result file back to the target directory.
7. The admissions center continually checks the institution target directory to determine the state of requests.

The admissions center retrieves the result file and deletes the request and acknowledgment files from the target directory.

8. The admission center decrypts and validates the result file and places an encrypted result acknowledgment file on the target directory.

If the result file does not validate, the system places a copy of the original encrypted request file on the target directory.

9. The institution continually monitors the target directory for the existence of result acknowledgment files.

- a. If no error records are reported, the acknowledgment file is deleted by the institution.
- b. If error records are reported, the institution takes action to rectify the cause of the invalid data or result file format before deleting the acknowledgment file.

PeopleSoft Campus Solutions is designed to perform the following tasks for ARTS processing:

- Read all ARTS request files in a target directory, after the file is decrypted.
- Create acknowledgment files for each request file.
- Retrieve academic information for a student in a request file, including notes.
- Produce a result file for each individual request.

Note: The system does not process students who have their results blocked by user-defined service indicators.

Additional detail about specific requirements for ARTS processing, file formats, data reporting guidelines, and technical information for ARTS is available.

See Automated Results Transfer System Users Guide published by the Australasian Conference of Tertiary Admissions Centres.

Understanding ARTS File Naming Conventions

PeopleSoft Campus Solutions creates all acknowledgement and results files and names them in accordance with a specific file naming convention, which is also used by all TACs.

The naming convention for ARTS files is *XAAAAAAA.YYY*, where each of the alphanumeric characters is defined as:

Term	Definition
X	The Admissions Centre code: <ul style="list-style-type: none"> • <i>Q</i>: Queensland Tertiary Admissions Centre. • <i>S</i>: South Australian Tertiary Admissions Centre. • <i>T</i>: Tertiary Institutions Service Centre (Western Australia). • <i>U</i>: Universities Admissions Centre (New South Wales). • <i>V</i>: Victorian Tertiary Admissions Centre.
AAAAAAA	A unique seven digit alphanumeric code identifying either the applicant or the transaction.

Term	Definition
YYY	<p>The file extension that identifies the type of the file:</p> <ul style="list-style-type: none"> • <i>REQ</i>: Request file. • <i>ACK</i>: Request Acknowledgment file. • <i>RLT</i>: Result file. • <i>ACS</i>: Result Acknowledgment file. • <i>CPD</i>: Request file after processing.

Note: The file name must be in upper case and contain no special (nonalphanumeric) characters.

File Naming Examples

For example, a request file generated by South Australia TAC for applicant 12BC567 would be named S12BC567.REQ.

The request acknowledgment file generated by Campus Solutions corresponding to the request file would be named S12BC567.ACK.

The result file generated by Campus Solutions corresponding to the request file would be named S12BC567.RLT.

The acknowledgment file generated by South Australia TAC for applicant 12BC567 corresponding to the request file would be named S12BC567.ACS.

Preparing for ARTS Processing

To prepare for ARTS processing, use these components: Academic Program Table (ACADEMIC_PROG_TBL), ARTS Institution Mapping AUS (SSR_ARTS_INST_MAP), Service Indicator Data (SERVICE_IND_PERS), ARTS Student Program Notes AUS (SSR_PROG_NOTES), Honors and Awards (HNR_AWD_EXT_PERS), Person Comment Entry (CMNT_ENTRY), and Communication Management (COMM_MANAGEMENT).

This section provides an overview of ARTS processing and discusses how to:

- Enter field of study values.
- Enter data mapping specifications.
- Assign service indicators.
- Enter student program notes.
- Enter honors and awards.
- Enter comments.

- Enter communications.

Understanding ARTS Processing

To prepare for ARTS processing, ensure that:

- Fields of study have been populated on the Acad Prog AUS (Academic Program AUS) page.
- Data mapping specifications have been completed on the ARTS Institution Mapping page.
- Service indicators are assigned to students that you want the system to exclude from ARTS processing on the Service Indicator Data page.

In addition to reporting traditional personal data and course data that resides in your system for students, the ARTS process can also report:

- Honors and awards information.
- Program notes.
- Comments.
- Communications.

Therefore, prior to running the ARTS process, add:

- Program notes to student records.
- Honors and awards information to student records.
- Comments to student records.
- Communications to student records.

Pages Used to Prepare for ARTS Processing

<i>Page Name</i>	<i>Definition Name</i>	<i>Navigation</i>	<i>Usage</i>
Acad Prog AUS (academic program Australia)	SSR_ACAD_PROG_AUS	Set Up SACR > Foundation Tables > Academic Structure > Academic Program Table > Acad Prog AUS	Assign a field of study value for each program that can be processed by ARTS.
ARTS Institution Mapping	SSR_ARTS_INST_MAP	Set Up SACR > Product Related > Student Records > Transcript > ARTS Institution Mapping AUS > ARTS Institution Mapping	Map PeopleSoft campus codes to the Department of Education institution codes, which the system uses in the ARTS transcripts.

Page Name	Definition Name	Navigation	Usage
Manage Service Indicators	SRVC_IND_SUMRY	Campus Community > Service Indicators (Student) > Manage Service Indicators > Manage Service Indicators	Assign or release a service indicator. Students with service indicators that match one or both of the service indicators entered on the Arts Parameters 1 page at runtime will be excluded from ARTS processing.
ARTS Student Program Notes	SSR_PROG_NOTES	Records and Enrollment > Transcripts > ARTS Student Program Notes AUS > ARTS Student Program Notes	Add notes to a student's program in order for notes to appear on the ARTS transcript.
Honors and Awards	HONORS_AWARDS_CS	Records and Enrollment > Graduation > Honors and Awards > Honors and Awards	Track student honors and awards. The Honors/Awards process populates the page according to the rules you set on the Honors/Awards Rule page. You can also manually enter information on this page.
Person Comment Entry	CMNT_ENTRY1	Campus Community > Comments > Comments - Person > Person Comment Entry > Person Comment Entry	Enter comments about an individual.
Person Communication	COMM_MGMT1	Campus Community > Communications > Person Communications > Communication Management > Person Communication	Assign a communication to an individual.

Entering Field of Study Values

Access the Acad Prog AUS page (**Set Up SACR > Foundation Tables > Academic Structure > Academic Program Table > Acad Prog AUS**).

This example illustrates the fields and controls on the Acad Prog AUS page (1 of 2).

The screenshot shows the 'Acad Prog AUS' page with the following fields and controls:

- Academic Institution:** PSUNV PeopleSoft University
- Academic Program:** LAU Liberal Arts Undergraduate
- Effective Date:** 01/01/1900
- Status:** Active
- *Field of Study:** 030101 Arts, Humanities, Social Sc.
- Field of Education Code:** 091523 Literature
- Program Type Code:** 10 Bachelor's Pass
- Special Program Type:** 00 Not Course of Special Interest
- Aggregated EFTSL:** 30 3 Years
- Minimum Units:** 360.00
- Program Eligibility:** PELS Elig
- CRICOS Code:** (empty)
- Combined Course Indicator**
- Supplementary FOS:** 000000 Non-Award
- Supplementary FOE:** 010101 Mathematics

At the bottom, there is a table for 'DEST Related Programs':

Related Academic Program	*Status
1	Active

This example illustrates the fields and controls on the Acad Prog AUS page (2 of 2). You can find definitions for the fields and controls later on this page.

The screenshot shows the 'TAC Program Mapping' section with the following fields and controls:

- Program Code:** (text input)
- TAC Stream Code:** (text input)
- Academic Load:** (dropdown menu)
- Academic Plan:** (text input)
- Mode of Attendance:** (dropdown menu)
- Campus:** (text input)

Enter a field of study value for each program that you process as part of ARTS.

Related Links

“Defining Academic Programs” (Campus Solutions Application Fundamentals)

Entering Data Mapping Specifications

Access the ARTS Institution Mapping page (**Set Up SACR > Product Related > Student Records > Transcript > ARTS Institution Mapping AUS > ARTS Institution Mapping**).

This example illustrates the fields and controls on the ARTS Institution Mapping page. You can find definitions for the fields and controls later on this page.

<i>Field or Control</i>	<i>Description</i>
Version ID	<p>Enter the Version ID. The ARTS version number represents the specification number applicable to the request/return. The system includes this number on the Request file header record, Result file header record, Request acknowledgement file header record and Result acknowledgement file header record.</p> <p>Except for a short period of time during change over from one version to the next, this number will be the same for all request/results records—the current version. However during changeover periods and for testing, multiple versions may coexist for short periods.</p>
Main	Select this check box to indicate the main campus for the institution.
IP Address	An IP address can be assigned to the campus for which you select the Main check box. The system includes this on the ARTS transcript header record.

Assigning Service Indicators

Access the Manage Service Indicators page (**Campus Community > Service Indicators (Student) > Manage Service Indicators > Manage Service Indicators**).

Assign service indicators to students that you want to exclude from ARTS processing. At runtime, you can specify up to two (2) service indicators which, if assigned to a student, will exclude the student from ARTS processing.

See [Performing ARTS Processing](#).

Related Links

“Viewing, Assigning, or Removing Service Indicators” (Campus Community Fundamentals)

Entering Student Program Notes

Access the ARTS Student Program Notes page (**Records and Enrollment > Transcripts > ARTS Student Program Notes AUS > ARTS Student Program Notes**).

Enter any notes that you want to include in the ARTS process.

<i>Field or Control</i>	<i>Description</i>
Sequence Nbr (sequence number)	If you have multiple notes per program, enter a sequence value to control the order of the notes.
Include Program Description	Select to include the program description in the report.
ARTS Program Notes	Enter notes for the student's program.

Entering Honors and Awards

Access the Honors and Awards page (**Records and Enrollment > Graduation > Honors and Awards > Honors and Awards**).

Enter any honors and awards information that you want to include in the ARTS process. You specify the honors and awards that you want to report during ARTS processing on the Honors/Awards page.

See [Entering ARTS Honors and Awards Parameters](#).

Related Links

“Entering Honors and Awards Data” (Campus Community Fundamentals)

Entering Comments

Access the Person Comment Entry page (**Campus Community > Comments > Comments - Person > Person Comment Entry > Person Comment Entry**).

Enter any comments that you want to include in the ARTS process. You specify the comments that you want to report during ARTS processing on the Comments/Communications page.

See [Entering Comment and Communication Parameters](#).

Related Links

“Entering Comments About an Individual” (Campus Community Fundamentals)

Entering Communications

Access the Communication Management 1 page (**Campus Community > Communications > Person Communications > Communication Management > Person Communication**).

Enter any communications that you want to include in the ARTS process. You specify the communications that you want to report during ARTS processing on the Comments/Communications page.

See [Entering Comment and Communication Parameters](#).

Related Links

“Assigning Communications” (Campus Community Fundamentals)

Performing ARTS Processing

You can schedule ARTS processing to run routinely using the Process Scheduler. After you set up the process pages in this section and specify a processing frequency, you need only monitor the system.

The processing program operates under the assumption that the request files have been decrypted and placed into the appropriate directory, which the institution specifies in the **Input File Path** field.

This section discusses how to:

- Enter ARTS processing parameters.
- Enter ARTS honors and awards parameters.
- Enter comment and communication parameters.

Pages Used to Run the ARTS Process

<i>Page Name</i>	<i>Definition Name</i>	<i>Navigation</i>	<i>Usage</i>
Arts Parameters 1	SSR_RUN_SRARTS	Records and Enrollment > Transcripts > ARTS Results AUS > Arts Parameters 1	Provide parameters for ARTS processing. Specify where the system shall retrieve and place the ARTS files, and indicate what service indicators (if present for a student) prevent a student's academic record from being released.

Page Name	Definition Name	Navigation	Usage
Honors/Awards	SSR_RUN_SRARTS2	Records and Enrollment > Transcripts > ARTS Results AUS > Honors/Awards	Enter the codes you have set up in your system for the various types of honors and awards that you want to report in the results file. Honors categories are used to determine the honors flag in the course attempt record. Careers are used to select honor details in the result file.
Comments/Communications	SSR_RUN_SRARTS3	Records and Enrollment > Transcripts > ARTS Results AUS > Comments/Communications	Enter the codes that you set up in your system for the various types of comments and communications that you want to report as notes in the result file.

Entering ARTS Processing Parameters

Access the ARTS Parameters 1 page (**Records and Enrollment > Transcripts > ARTS Results AUS > Arts Parameters 1**).

Field or Control	Description
Input File Path	Enter the complete file path to the ARTS request files.
Output File Path	Enter the complete file path to where you want to post the ARTS results and request acknowledgment files.
Academic Institution	Enter the academic institution that you want to process. If you have more than one institution, you may need to set up multiple run control IDs.
Service Indicator - Fees and Service Indicator Reason - Fees	Select a service indicator code and reason in order to identify students whose academic records should not be released due to unpaid fees. You can leave these fields blank.
Service Indicator - Other and Service Indicator Reason - Other	Select a service indicator code and reason in order to identify students whose academic records should not be released due to other reasons. You can leave these fields blank.

Entering ARTS Honors and Awards Parameters

Access the Honors/Awards page (**Records and Enrollment > Transcripts > ARTS Results AUS > Honors/Awards**).

This example illustrates the fields and controls on the Honors/Awards page. You can find definitions for the fields and controls later on this page.

The screenshot shows the 'Honors/Awards' configuration page. At the top, there are three tabs: 'ARTS Parameters 1', 'Honors/Awards', and 'Comments/Communications'. The 'Honors/Awards' tab is selected. Below the tabs, there is a 'Run Control ID' field with the value 'ABC'. To the right of this field are two links: 'Report Manager' and 'Process Monitor', and a yellow 'Run' button. Below this is a section titled 'Honors Award Categories' with a blue header. This section contains five rows, each representing a different honors category. Each row has a label (e.g., 'Honors Category 1 (Lvl I)'), a search box containing a value (e.g., 'DEANLS'), a magnifying glass icon, and a description (e.g., 'Dean's List'). Below this section is a table with a blue header. The table has two rows. Each row has a 'Career' label, a search box containing a value (e.g., 'MEDS'), a magnifying glass icon, and a description (e.g., 'Medical School'). To the right of each row are two buttons: a plus sign and a minus sign. At the top right of the table area, there are navigation controls: 'Find', 'First', '1-2 of 2', and 'Last'.

The Course Attempt record is written out in the ARTS Results File extract. The Result File Course Attempt record is a type of record in the output file. The Honours flag is a field in this record.

In the **Honors Award Categories** group box, select the honors categories that you want to include in students' academic records for ARTS. Any honors or awards in a student's record that have an honors category listed on this page will cause the Honours Flag field to be set in the Result Output File produced for the Course Attempt record. The input parameters include up to five honors code categories that may be used when building the Honours Flag field value in the Result File Course Attempt record. For example, if a student has *NHS* as an award code, then the system will code the Honours flag as 3, which specifies Lvl IIA.

Use the **Career** field to identify the careers to which honors details should be associated. Add rows to include additional careers.

The ARTS Honour Flag is described in the ARTS user guide.

See Automated Results Transfer System Users Guide published by the Australasian Conference of Tertiary Admissions Centres.

Entering Comment and Communication Parameters

Access the Comments/Communications page (**Records and Enrollment > Transcripts > ARTS Results AUS > Comments/Communications**).

This example illustrates the fields and controls on the Comments/Communications page. You can find definitions for the fields and controls later on this page.

Comments/Notes Categories			
Comment Category 1:	<input type="text" value="ALEVNT"/>		Alumni Events
Comment Category 2:	<input type="text" value="AWRDGS"/>		Awarding General Secured
Comment Category 3:	<input type="text"/>		
Comment Category 4:	<input type="text"/>		
Comment Category 5:	<input type="text"/>		

Communication/Notes Categories			
Communication Category 1:	<input type="text" value="ADMORG"/>		Admissions Organization Comm
Communication Category 2:	<input type="text" value="AWARD"/>		Financial Aid Award Notificatr
Communication Category 3:	<input type="text"/>		
Communication Category 4:	<input type="text"/>		
Communication Category 5:	<input type="text"/>		

In the **Comments/Notes Categories** group box, select the comment categories that you want to include in the student's academic records for ARTS. Any comment in a student's record that has a comment category listed on this page is included in the results file as part of the student note record. The input parameters include up to five categories of comments to look for when building the relevant student note records.

In the **Communication/Notes Categories** group box select the communication categories that you want to be included in student's academic records for ARTS. Any communication in the student's record that has a communication category listed on this panel is included on the Results files part of the student note record. The input parameters include up to five communication categories to look for when building the relevant student note records.

Click **Run** to run the ARTS (SRARTS) process. PeopleSoft Process Scheduler runs the ARTS process at user-defined intervals.

Note: You should schedule the ARTS process to run at intervals that enable the system to promptly respond to ARTS requests.

(AUS) Generating Government Reports

Understanding TCSI Reporting

Transforming the Collection of Student Information (TCSI) is a new Australian regulatory and legislative feature that replaces the old HEIMS file-based product.

Although the data being reported through TCSI is mostly the same as that reported through HEIMS, the structure of the records and the method of continuously reporting and updating the data required the creation of a new solution. This TCSI solution uses many of the existing setup pages created for HEIMS reporting.

The delivered TCSI processes will identify when a record hasn't been previously reported to TCSI. Using the APIs, the record with the data for each element is then posted to TCSI, and a unique ID (UID) is created for this data in the TCSI system. The TCSI APIs return this UID to Campus Solutions (CS), acting as a link between the data held by TCSI and the data in Campus Solutions.

CS stores the UID along with the details of the data sent to TCSI in a transaction record which is dated. The transaction record can then be compared to the current CS data (as it changes over time) to determine if it needs to be patched. When patching data, the process uses the stored UID to identify the TCSI record being updated and then sends the elements that have changed from those previously reported.

The process may encounter errors from TCSI during the posting or patching of data. CS stores these errors in a table that's linked to the transaction record to allow institutions to troubleshoot any issues.

There are a number of transaction pages that allow you to view current CS data, previous transaction data, and the current TCSI data, along with the error messages and transaction history. Institutions could use PeopleSoft Analytics to manage the error messages and direct them to the appropriate data experts.

Note: Before your organization can connect to TCSI through the APIs, you must register your organization for provider digital access ([PRODA](#)). PRODA is a system that verifies and authenticates your organization's identity so that you can securely access online government services. For FAQs about PRODA, go to the [HEIMSHelp](#) website.

Related Links

[Connecting to the TCSI System](#)

TCSI Reporting

Education providers and universities that previously report data through the HEPCAT system and CART should now use the TCSI system to report data to the Australian government.

To submit new data as well as update existing data in TCSI, Campus Solutions (CS) uses the RESTful APIs that TCSI provides.

This section discusses:

- [Importing Existing Data From TCSI](#)
- [Reporting Campus and Program Data](#)
- [Reporting Student Data](#)
- [Reporting Scholarships](#)
- [Identifying New or Updated Application Records](#)
- [Deleting Old TCSI Transaction Data](#)

Related Links

[Connecting to the TCSI System](#)

Pages Used to Report to TCSI

<i>Page Name</i>	<i>Definition Name</i>	<i>Navigation</i>	<i>Usage</i>
TCSI Data Migration	SSR_HM_DATAMIGR	Records and Enrollment > Enrollment Reporting > AUS Regulatory Reporting > TCSI > TCSI Data Migration Process	Import existing data from TCSI.
TCSI Campus/Program Process	SSR_HM_PRCS	Records and Enrollment > Enrollment Reporting > AUS Regulatory Reporting > TCSI > TCSI Campus/Program Process	Report campus and program data.
Student/Course Admissions/ Unit Enrolments Data Transfer	SSR_HM_STDNT_PRCS	Records and Enrollment > Enrollment Reporting > AUS Regulatory Reporting > TCSI > TCSI Student Data Process	Report student data.
TCSI Commonwealth Scholarships	SSR_TCSI_CWS	Records and Enrollment > Enrollment Reporting > AUS Regulatory Reporting > TCSI Commonwealth Scholarships	Submit new or update existing scholarships after 01/01/2019.

Page Name	Definition Name	Navigation	Usage
TCSI Higher Degree By Research	SSR_HM_RSRCH	Records and Enrollment > Enrollment Reporting > AUS Regulatory Reporting > TCSI Higher Degree By Research	Record research engagements.
TCSI Research Scholarships	SSR_HM_RSRCH_SCH	Records and Enrollment > Enrollment Reporting > AUS Regulatory Reporting > TCSI Research Scholarships	Record research scholarships. Records of the same scholarship type can't have overlapping start and end dates.
TCSI Apps/Offers/Prefs Process	SSR_HM_APOFP	Records and Enrollment > Enrollment Reporting > AUS Regulatory Reporting > TCSI > TCSI Apps/Offers/Prefs Process	Identify new or updated application records.
TCSI Purge Transactions	SSR_HM_PURGE_TXN	Records and Enrollment > Enrollment Reporting > AUS Regulatory Reporting > TCSI > TCSI Purge Transactions	Delete old TCSI transaction data.

Importing Existing Data From TCSI

Access the TCSI Data Migration page (**Records and Enrollment > Enrollment Reporting > AUS Regulatory Reporting > TCSI > TCSI Data Migration Process**).

Use the TCSI Data Migration page to retrieve information from TCSI about records you have previously submitted to HEIMS. A TCSI record has a unique identifier (UID), which is used to identify a record. When you know a record's UID, you can use the UID to update or delete a record.

Note: It is likely that institutions will only migrate campus and course of study data during their TCSI implementation. After the initial implementation, you can continue to migrate students, course admissions, and unit enrolments for groups of students as needed.

The migration process looks at each data in TCSI and tries to find a matching record in Campus Solutions (CS). If there's a match, the process collects the UIDs of the existing records in TCSI, then creates a record in the CS UID table. The UID links TCSI and CS records. The migration process also creates a transaction match record to store a copy of the data that's in TCSI. The match transaction record allows the TCSI Campus/Program and TCSI Student Data processes to determine if the data has changed since it was last reported to HEIMS.

You can use the transaction tables to troubleshoot any error that appears when you're submitting or updating records in TCSI. See [Reviewing Transaction Data From TCSI](#).

Field or Control	Description
Transaction Date	<p>The TCSI Student Data process uses this date to compare when CS student data has been added or updated, and determines if any changes have been made since the transaction date.</p> <p>For example, you want to mark records retrieved from TCSI as records dated 01/01/2020 because you know you haven't reported any updates to your records since then. When you run the migration process, the transaction records that are stored in CS will be dated 01/01/2020. When you run the TCSI Student Data process, it determines if there have been changes to CS records since the transaction date. If there are changes, the process compares the CS record with the transaction record, then it updates (patches) the record in TCSI.</p>

Include in Processing

Use this region to identify the records you want to import from TCSI. When you select TCSI Course of Study or TCSI Course, the process retrieves all records from TCSI. These elements don't have a high volume of records and you can't retrieve this data individually. The TCSI Course records are dependent on the TCSI Course of Study records, so those must be migrated either in the same process run or in a previous run.

When you select Students, Course Admissions, and Unit Enrolments, you must select Population Selection so you can identify a smaller set of data to import. Because of the sheer volume of records for students, courses, and unit enrolments, processing them would take a longer time. It's recommended to identify a smaller set of records to facilitate a quicker processing and to allow a subset of students to be targeted. For example, organizations may choose to migrate only students who were active in the last two years and defer migrating other historic student data until it is needed.

Field or Control	Description
Use Short description to match	<p>Select to match the data for TCSI Course of Study based on the program's short description.</p> <p>Use this option only with TCSI Course of Study. The data is based on the short description instead of the program code. This may vary for each institution, so select this option to indicate that the process should match TCSI data with CS data based on either program code or short description.</p>

Population Selection

Population selection is a method for selecting the IDs to process for a specific transaction. The Population Selection group box is a standard group box that appears on run control pages when the Population Selection process is available or required for the transaction. See "Understanding the Population Selection Group Box" (Campus Community Fundamentals).

Use this group box to select a PS query to specify a set of records for migration together with this bind record: SSR_HM_BND_STU - Data Migration Bind Record.

Use a query when importing data about students, course admissions, and unit enrolments. This allows institutions to run the migration process against smaller chunks of data. You can also use a query to identify students using a specific set of criteria. For example, import data only for students who are currently active or those who have been active for the last three years.

Reporting Campus and Program Data

Access the TCSI Campus/Program Process page (**Records and Enrollment > Enrollment Reporting > AUS Regulatory Reporting > TCSI > TCSI Campus/Program Process**).

Note: Most institutions will run the migration process first. See [Importing Existing Data From TCSI](#). You must run this process before running the student data process. The campus and course elements must exist before student records can be created.

Use the TCSI Campus/Program Process page to submit new or update existing campus, course of study, course, or course on campus records to TCSI. Courses are called programs in CS.

The data transfer process goes through all the records you include in the processing. Each record has a related view that maps CS data to the HEIMS record. For each record, the process looks at the related view to determine if there are new or updated rows.

When a new row is found, a POST call is made using the data in the view. This creates an entry for the record in TCSI. When posting is:

- *Successful*, TCSI responds with the UID that it assigned to the record. CS stores this UID in a table and the data that was submitted is written to the transaction data table for that record.
- *Unsuccessful*, the record you submitted is still written to the transaction data table, but no UID is stored. The accompanying error message is stored in the error table.

When an updated row is found, a PATCH call is made using the data from the view and the UID from the UID table. This updates the existing record in TCSI. When patching is:

- *Successful*, the data you submitted is written to the transaction data table.
- *Unsuccessful*, the data you submitted is still written to the transaction data table and an error message is written to the error table.

Field or Control	Description
Records per POST Request	<p>Enter the number of records you want to submit to TCSI. It's recommended that you limit this to 1 record per transaction to maintain performance.</p> <hr/> <p>Note: While you can enter a number greater than one, doing so may result in performance issues. If you enter 1000, for example, it may take too long for a response from TCSI to come back. Between updating records and waiting for responses, failures may also occur.</p> <hr/>

Include in Processing

Use this region to select the entities you want to submit or update. While you can choose one or more entities, there's an order to how submissions or updates are processed. For example, in order to submit new or update existing TCSI Course of Study records, the TCSI Campus must exist. The same is true when processing TCSI Courses: the TCSI Course of Study and TCSI Campus must exist before courses can be created, and so on.

If you process other elements without processing records for the elements that precede it, you will get an error because the records don't exist. For example, if you select TCSI Course without selecting TCSI Campus and TCSI Course of Study, and then you run the process, you will get an error.

Reporting Student Data

Access the TCSI Student Data Process page (**Records and Enrollment > Enrollment Reporting > AUS Regulatory Reporting > TCSI > TCSI Student Data Process**).

Use the TCSI Student Data Process page to submit new or update existing student records as well as other information like Commonwealth scholarships, academic load, research scholarships, and so on.

The data transfer process goes through all the records you include in the processing. If a transaction record and UID does not exist for the record, the element values are derived from CS and posted to TCSI. If a transaction record and UID exist and if there have been updates to the CS records after the transaction date, the element values are derived from CS and any updated element values are submitted to TCSI.

Note: Student processing doesn't use views like the Course/Campus Process because the data derivation is too complex.

When a new row is found, a POST call is made using the data derived from CS. This creates an entry for the record in TCSI. When posting is:

- *Successful*, TCSI responds with the UID that it assigned to the record. CS stores this UID in a table and the data that was submitted is written to the transaction data table for that record.
- *Unsuccessful*, the data you submitted is still written to the transaction data table, but no UID is stored. The accompanying error message is stored in the error table.

When an updated row is found, a PATCH call is made using the data derived from CS and the UID from the UID table. When patching is:

- *Successful*, the data you submitted is written to the transaction data table.
- *Unsuccessful*, the data you submitted is still written to the transaction data table and an error message is written to the error table.

Field or Control	Description
Academic Institution	Students are selected from the institution you have selected.

Field or Control	Description
Provider Type	<p>The value you select, HEP or VET, controls what endpoints and data are included. For dual sector providers, you need to run the processes separately for your HEP and VET students.</p> <p>The CS TCSI process determines if a student is HEP, VET, or not reported based on what's indicated on the Academic Career AUS page (Set Up SACR > Foundation Tables > Academic Structure > Academic Career Table > Academic Career AUS).</p>
Records Per POST Request	Enter the number of records you want to submit to TCSI. It's recommended that you limit this to 1 record per transaction to avoid issues with dropping large TCSI transactions.
Update All Records	<p>When you select this check box, the current CS data is derived and compared to the last transaction data to determine if any changes need to be patched. This process skips the logic that looks for records based on whether the CS record has a more recent add, update date/time than the last transaction date/time.</p> <p>Select this option if you believe some updates to local CS data may have been missed, or if the CS and TCSI data may have become out of sync.</p>
Census Start Date, Census End Date	The census date range can be whatever dates are required to target the data your institution wants to report to TCSI. For nightly runs, it's expected that this would cover the current term and next term. When reporting changes to specific data that were previously reported (revisions), this date range could span several years, and you can select the student population using PS Query.

Population Selection

Population selection is a method for selecting the IDs to process for a specific transaction. The Population Selection group box is a standard group box that appears on run control pages when the Population Selection process is available or required for the transaction. See "Understanding the Population Selection Group Box" (Campus Community Fundamentals).

Use this group box to select the population of student careers to narrow down the number of records the process considers. The initial student population is based on the student EMPLIDs, Academic Careers, and Career Numbers that the query selects.

If you don't use population selection, the student data process finds the student career population using Census Start Date and Census End Date. A student career is included in the process if it falls under one of these conditions:

- A related enrolment with a census date that falls between the census start and end dates.
- An admit term with a start date that falls within the census start and end dates, and has a program action of ACTV or MATR.

- An effective date that falls within the census start and end dates.

Field or Control	Description
Selection Tool	Select PS Query .

In creating either a query to use in this process, the bind record SSR_HM_STDT_BND must be included in the query. If the bind record is not included, then the query will not appear as prompt value for the Query Name field.

After selecting the student population, you need to choose the TCSI packets, which contains additional logic to determine whether any data must be posted or patched.

Include in Processing

Select the TCSI packets you want to submit or update. While you can choose one or more packets, there's an order to how submissions or updates are processed. For example, in order to submit new or update existing Commonwealth scholarships, the student must exist. The same is true when processing course admissions: you can't create these without a student record. Course admissions must exist before you can create research scholarships.

When you select any one of these packets, records are:

- Posted if there's no UID for the EMPLID in the UID mapping table.
- Patched if there's an existing UID for the EMPLID in the UID mapping table, and there was an update to one of the CS records (there's an add/update date after the most recent successful transaction record).

Field or Control	Description
Students	<p>Records are processed if the student is in the selected population.</p> <p>The process considers the standard SCC_ROW_ADD_DTTM and SCC_ROW_UPD_DTTM columns in most tables, such as PS_SSR_STDNT_DATA. For Person data, it also uses PS_PERSON.LAST_CHILD_UPDDTM to identify updates to the person and child records.</p> <p>This packet contains Disability and Citizenship child records.</p>

Field or Control	Description
Commonwealth Scholarships	<p>Note: After 01/01/2019, TCSI will use the TCSI Commonwealth Scholarships page (SSR_HM_TCSI_CWS). This page is designed so that there's one record created for each record that's sent to TCSI. See Reporting Scholarships. Records are processed if the student is in the selected population and if any part of the year/period falls between the census start and end dates. For example, for census dates 15/03/2021 to 15/09/2021, the process reports both 2021/1 and 2021/2.</p>
Course Admissions	<p>Records are processed if the student program EMPLID/Academic Career/Career Number is in the selected population.</p> <p>This packet contains Basis of Admission, Course Prior Credit, Specialisations child records.</p>
HDR End-User Engagements	<p>Records are processed if the student program EMPLID/Academic Career/Career Number is in the selected population.</p>
Research Scholarships / RTP	<p>Records are processed if the student program EMPLID/Academic Career/Career Number is in the selected population.</p>
Unit Enrolments	<p>Records are processed if the student program EMPLID/Academic Career/Career Number is in the selected population.</p> <p>This packet contains AOU child records.</p>
OS-HELP Loans	<p>Records are processed if the student program EMPLID/Academic Career/Career Number is in the selected population and if the incurred date falls between the census start and end dates.</p>
SA-HELP Loans	<p>Records are processed if the student program EMPLID/Academic Career/Career Number is in the selected population and if the incurred date falls between the census start and end dates.</p>

Field or Control	Description
Aggregated Awards	<p>Records are processed if the:</p> <ul style="list-style-type: none"> • Student program EMPLID/Academic Career/Career Number is in the selected population. • Aggregate Award check box is selected in the academic program. • Aggregate Award student program has an effective date that falls between the census start and end dates.
Exit Awards	<p>Records are processed if the:</p> <ul style="list-style-type: none"> • Student program EMPLID/Academic Career/Career Number is in the selected population. • Exit Award check box is selected in the Exit Award student program. • The Source Award student program is selected in the Source Award field on the Exit Award student program. • Exit Award student program has an effective date that falls between the census start and end dates.

Reporting Scholarships

Access the TCSI Commonwealth Scholarships page (**Records and Enrollment > Enrollment Reporting > AUS Regulatory Reporting > TCSI Commonwealth Scholarships**).

Use the TCSI Commonwealth Scholarships page to report scholarships after 01/01/2019. The process creates one record for each student record that's reported to TCSI.

Once a scholarship is current, a record is created for each current period with the reporting year, period, and amount. If a scholarship is terminated, a new offer record must be created in the next active reporting year and period.

Here are examples of a scholarship being initially offered in 2019/1, made current with a scholarship amount in 2019/1, terminated in 2019/2, then re-offered in 2020/1.

Identifying New or Updated Application Records

Access the TCSI Apps/Offers/Prefs Process page (**Records and Enrollment > Enrollment Reporting > AUS Regulatory Reporting > TCSI > TCSI Apps/Offers/Prefs Process**).

Use the TCSI Apps/Offers/Prefs Process page to run a process that identifies new and updated application records, then posts new records or patches existing ones.

This process uses the same profile records and mapping pages as the HEIMS process that it replaces.

Population Selection

Population selection is a method for selecting the IDs to process for a specific transaction. The Population Selection group box is a standard group box that appears on run control pages when the Population Selection process is available or required for the transaction. See “Understanding the Population Selection Group Box” (Campus Community Fundamentals).

Use this group box to find a student population. If you don’t use a PS query, the student is selected based on institution, profile, and admit term.

Parameters

<i>Field or Control</i>	<i>Description</i>
Profile	Use this to specify parameters that determine which students are chose. Examples of these parameters are: Application Center, Admit Type, Application Method, Citizenship, and Course of Study Type Code.
Reference Date	The date you specify is used to determine which effective-dated rows should be used in processing.
Current Year 12 Year	The year you specify is used to find related records based on the year the student finished their previous studies.
Admit Term	The term you specify allows applications for processing to be selected across one or more admit terms.

Deleting Old TCSI Transaction Data

Access the TCSI Purge Transactions page (**Records and Enrollment > Enrollment Reporting > AUS Regulatory Reporting > TCSI > TCSI Purge Transactions**).

Use the TCSI Purge Transactions page to permanently delete old CS TCSI transaction data and related CS TCSI records that are no longer required. The most recent successful transaction record is always retained for each posted TCSI record to allow comparison and ongoing patching of data when required.

Purge Transactions By

<i>Field or Control</i>	<i>Description</i>
Count	When selected, the oldest transaction records are deleted when they're greater than the value in Transactions delete more than .

<i>Field or Control</i>	<i>Description</i>
Days	When selected, the oldest transaction records are deleted when they're older than the value in Transactions older than days .

Include in Processing

Use this region to select the groups of TCSI records you want to process. This section is similar to the ones in the other TCSI processes.

Reviewing Transaction Data From TCSI

During the initial data migration or later, during day-to-day operations of the TCSI Campus/Program and TCSI Student Data processes, you may experience issues with your TCSI transactions.

Note: Only experienced users should use the Transaction Maintenance pages to troubleshoot any issues or errors. These aren't for day-to-day use by untrained users.

With these pages, you can view transaction data, see the element data that's derived for individual records, and view any error messages from TCSI. You can also perform some maintenance tasks such as getting the current data for the record from TCSI, posting or patching the data immediately to TCSI, and deleting individual records from TCSI. Due to the technical nature of these pages, data that's normally hidden—such as the TCSI UIDs and the CS mapping and transaction sequence numbers—are exposed to let you troubleshoot issues.

Some entities have child records. When the child records have values, links to child record pages appear on the parent record's page. You can use the child record pages to troubleshoot any errors you encounter when submitting or updating records in TCSI. Entities with child records are:

- Courses. See [Viewing Program Transaction Records](#).
- Students. See [Viewing Student Transaction Records](#).
- Courses on Campus. See [Viewing Program on Campus Transaction Records](#).

Here's an example of a Transaction Maintenance page.

This example illustrates the fields and controls on a TCSI Transaction Maintenance page. You can find definitions for the fields and controls later on this page.

TCSI Campus Transactions

Academic Institution PSAUS Location Code MELB Provider Type HEP

TCSI Data Find | View All First 1 of 1 Last

Campus UID 554 Transaction Sequence Number 8

Mapping Sequence Number 165 Last Transaction Datetime 21 Sep 2023 at 01:33:38

HEIMS Transaction Type POST

Elements	Current Data	Last Transaction Data	Data from HEIMS
E525 Campus Suburb	Melbourne	Melbourne	
E644 Campus Country Code	1101	1101	
E559 Campus Postcode	3001	3001	
E609 Campus Effective From Date	01/01/1900	01/01/1900	
E610 Campus Effective To Date			

Delete
Get

Response

Transaction Details Personalize | Find | View All | First 1 of 1 Last

Transaction ID	Sequence Number	Transaction Datetime	HEIMS Transaction Type	Error Identifier	Error Category	Error Description	Error Details
18	1	21 Sep 2023 at 01:33:38	POST	10018CURLOG	Error	The Campus Suburb (E525)/Campus Postcode (E559) combination already exists for a campus at the Higher Education Provider.	

Here are descriptions of some of the common fields on the Transaction Maintenance pages.

Field or Control	Description
Mapping Sequence Number	This is the sequence number across all records in all mapping tables.
Transaction Sequence Number	This is the sequence number for the records in this transaction table.
Last Transaction Datetime	This is the date and time when you last initiated a data transfer process. The transaction could be a delete, post, patch, or get.
HEIMS Transaction Type	This identifies the type of transaction you recently initiated: POST, PATCH, MATCH, or DELETE.
Elements	<p>These are the elements that make up the record. For example, if you're viewing the TCSI Campus Transactions page, this column shows the elements that make up the campus record.</p> <p>If you have submitted data to TCSI, a Delete button appears. If you click this button, the record in TCSI is deleted, and the record in CS is marked as deleted. When you run the TCSI data process, the process skips this record (it isn't sent to TCSI) because it has been marked as deleted.</p>

Field or Control	Description
Current Data	Here, you see the data that's currently in CS. If you have run the migration process, but never submitted nor updated your records in TCSI, a Post button appears. Click Post to submit this record to TCSI.
Last Transaction Data	<p>If you initiated a data transfer process, this column shows the data that was imported from the TCSI system. It's the latest version of the data that's stored in TCSI.</p> <p>When you send data to TCSI either by running the migration process or initiating a Get call on this page and there's a discrepancy between the values of the elements in CS (shown in the Current Data column) and TCSI (shown in this column), a Patch button appears. If you click Patch, CS updates the record in TCSI. The record that appears in the Current Data column is used to update the record in TCSI.</p>
Data for HEIMS	When the Get button is available and you click it, an API call is made to retrieve the campus record that's in the TCSI system. That data appears here.
Response	This field shows the response from TCSI when you click any one of these: Delete , Post , Patch , or Get .
Transaction Details	<p>This grid shows the processing actions you've done, whether it's a delete, post, patch, or get. Here, you will also see any errors that occur when you initiated any one of those actions. An example of an error is one where you're attempting to create an element that already exists, which means it will be a duplicate entry. The system prevents you from creating a duplicate entry.</p>

Pages Used to Review Transaction Data From TCSI

Page Name	Definition Name	Navigation	Usage
TCSI Campus Transactions	SSR_HM_CAMPUS	Records and Enrollment > Enrollment Reporting > AUS Regulatory Reporting > TCSI > Transaction Maintenance > TCSI Campus	View campus transaction records.

Page Name	Definition Name	Navigation	Usage
TCSI Program of Study Transactions	SSR_HM_PROG_STUDY	Records and Enrollment > Enrollment Reporting > AUS Regulatory Reporting > TCSI > Transaction Maintenance > TCSI Program of Study	View program or course of study transaction records.
TCSI Program Transactions	SSR_HM_PROGRAM	Records and Enrollment > Enrollment Reporting > AUS Regulatory Reporting > TCSI > Transaction Maintenance > TCSI Program	View program or course transaction records.
TCSI Program on Campus Transactions	SSR_HM_PROG_CAMPUS	Records and Enrollment > Enrollment Reporting > AUS Regulatory Reporting > TCSI > Transaction Maintenance > TCSI Program on Campus	View program or course on campus transaction records.
TCSI Student Transactions	SSR_HM_STUDENT	Records and Enrollment > Enrollment Reporting > AUS Regulatory Reporting > TCSI > Transaction Maintenance > TCSI Student	View student transaction records.
TCSI Course Admission Transactions	SSR_HM_CAD_TRANS	Records and Enrollment > Enrollment Reporting > AUS Regulatory Reporting > TCSI > Transaction Maintenance > TCSI Course Admissions	View course admission transaction records.
TCSI Unit Enrolment Transactions	SSR_HM_UNIT_ENRLMT	Records and Enrollment > Enrollment Reporting > AUS Regulatory Reporting > TCSI > Transaction Maintenance > TCSI Unit Enrolment	View unit enrollment transaction records.

<i>Page Name</i>	<i>Definition Name</i>	<i>Navigation</i>	<i>Usage</i>
TCSI Application Transactions	SSR_HM_CRSEAPPL	Records and Enrollment > Enrollment Reporting > AUS Regulatory Reporting > TCSI > Transaction Maintenance > TCSI Apps/Offers/Preferences	View application transaction records.

Viewing Campus Transaction Records

Access the TCSI Campus Transactions page (**Records and Enrollment > Enrollment Reporting > AUS Regulatory Reporting > TCSI > Transaction Maintenance > TCSI Campus**).

<i>Field or Control</i>	<i>Description</i>
Campus UID (Unique Identifier)	This shows the ID that TCSI assigned to this record. When this field has a value, it means you have run the migration process or the TCSI data process and successfully posted a record. The former retrieves information about your existing records in TCSI (such as a record's UID), and the latter submits new or updates existing information in TCSI.

Viewing Program of Study Transaction Records

Access the TCSI Program of Study Transactions page (**Records and Enrollment > Enrollment Reporting > AUS Regulatory Reporting > TCSI > Transaction Maintenance > TCSI Program of Study**).

<i>Field or Control</i>	<i>Description</i>
UID (Unique Identifier)	This shows the ID that TCSI assigned to this record. When this field has a value, it means you have run the migration process or the TCSI data process. The former retrieves information about your existing records in TCSI (such as a record's UID), and the latter submits new or updates existing information in TCSI.

Viewing Program Transaction Records

Access the TCSI Program Transactions page (**Records and Enrollment > Enrollment Reporting > AUS Regulatory Reporting > TCSI > Transaction Maintenance > TCSI Program**).

Field or Control	Description
Course of Study UID Course UID	<p>This shows the unique ID (UID) that TCSI assigned to the course/program of study and course/program records.</p> <p>When these fields have values, it means you have run the migration process or the TCSI data process. The former retrieves information about your existing records in TCSI (such as a record's UID), and the latter submits new or updates existing information in TCSI.</p>
Field of Education	<p>Click to view the pages for the child record.</p> <p>The campus/program record has these child records: field of education and special interest course. When there are values for the child records, links to the child record pages appear on this page. On these child pages, you can troubleshoot errors relating to the child records as well as process the child records, whether it's to delete, post, update, or get data.</p>

Viewing Program on Campus Transaction Records

Access the TCSI Program on Campus Transactions page (**Records and Enrollment > Enrollment Reporting > AUS Regulatory Reporting > TCSI > Transaction Maintenance > TCSI Program on Campus**).

Field or Control	Description
CRICOS Code	<p>This is the seven-digit CRICOS code that's associated with this academic program. The Department of Immigration uses this code to identify valid programs for international students.</p>
Campus UID Course on Campus UID Course UID	<p>This shows the unique identifier (UID) that TCSI assigned to the parent campus, the parent course, and this course on campus records.</p> <p>When these fields have values, it means you have run the migration process or the TCSI data process. The former retrieves information about your existing records in TCSI (such as a record's UID), and the latter submits new or updates existing information in TCSI.</p>
Campus Course Fee TAC Offer Code	<p>Click to view the pages for these child records.</p> <p>The program/course on campus record has these child records: campus course fee and TAC offer. When there are values for the child records, links to the child record pages appear on this page. On these child pages, you can troubleshoot errors relating to the child records as well as process the child records, whether it's to delete, post, update, or get data.</p>

Viewing Student Transaction Records

Access the TCSI Student Group Transactions page (**Records and Enrollment > Enrollment Reporting > AUS Regulatory Reporting > TCSI > Transaction Maintenance > TCSI Student**).

<i>Field or Control</i>	<i>Description</i>
Student ID	This is the employee ID (EMPLID) that identifies a student in CS. The process uses the EMPLID to get the student UID.
Student UID (Unique Identifier)	This shows the UID that TCSI assigned to the student When this field has values, it means you have run the migration process or the TCSI data process. The former retrieves information about your existing records in TCSI (such as a record's UID), and the latter submits new or updates existing information in TCSI.
Citizenship Extension	Click to view the pages for the child record. The student record has these child records: disability extension, citizenship extension, and Commonwealth scholarship. When there are values for the child records, links to the child record pages appear on this page. On these child pages, you can troubleshoot errors relating to the child records as well as process the child records, whether it's to delete, post, update, or get data.

Viewing Course Admission Transaction Records

Access the TCSI Course Admission Transactions page (**Records and Enrollment > Enrollment Reporting > AUS Regulatory Reporting > TCSI > Transaction Maintenance > TCSI Course Admissions**).

<i>Field or Control</i>	<i>Description</i>
Student ID	This is the employee ID (EMPLID) that identifies a student in CS. The process uses the EMPLID to get the student UID.
Student UID (Unique Identifier)	This shows the UID that TCSI assigned to the student. When this field has values, it means you have run the migration process or the TCSI data process. The former retrieves information about your existing records in TCSI (such as a record's UID), and the latter submits new or updates existing information in TCSI.

<i>Field or Control</i>	<i>Description</i>
Specialisation	<p>Click to view the page for the child record.</p> <p>The course admission record has these child records: basis for admission, course prior credit, specialisation, HDR, and scholarship. When there are values for the child records, links to the child record pages appear on this page. On these child pages, you can troubleshoot errors relating to the child records as well as process the child records, whether it's to delete, post, update, or get data.</p>

Viewing Unit Enrolment Transaction Records

Access the TCSI Unit Enrolment Transactions page (**Records and Enrollment > Enrollment Reporting > AUS Regulatory Reporting > TCSI > Transaction Maintenance > TCSI Unit Enrolment**).

<i>Field or Control</i>	<i>Description</i>
AOU Extension	Click to view the page for the child record.

Viewing Application Transaction Records

Access the TCSI Application Transactions page (**Records and Enrollment > Enrollment Reporting > AUS Regulatory Reporting > TCSI > Transaction Maintenance > TCSI Apps/Offers/Preferences**).

<i>Field or Control</i>	<i>Description</i>
Preferences	Click to view the child record with preference data.
Offers	Click to view the child record with offers data.

Chapter 59

(CAN) Generating Canadian Government Reports

Understanding Canadian Government Report Generation

Generating Canadian government reports is a multiple step process. An overview of the process is as follows:

1. Set up all of your government reporting data and populate the Student List table.
2. (Optional) Generate a report of students.
3. (Optional) Freeze the student list.
4. Run the extract process.
5. Review the report data.
6. (Optional) Correct the source pages or online pages and rerun the extract process.
Or, correct the data directly in the extract table.
7. Generate the flat file.
8. Deliver the flat file to the federal or provincial government.
9. Archive the extract data table file.

These steps are discussed in the following sections.

Prerequisites for Generating Canadian Government Reports

Before you can generate extract reports and flat files you must:

- Set up your system for Canadian Government reporting.
- Populate the Student List.

Related Links

[Understanding the Canadian Government Reporting Process](#)

[Loading the Student ID Table](#)

(Optional) Generating a Report of Selected Students

The Student Selection report contains a list of students that correspond to those on the Student List page. You can generate the report before you run the reports extract program.

Page Used to Generate the Student Selection Report

<i>Page Name</i>	<i>Definition Name</i>	<i>Navigation</i>	<i>Usage</i>
Selected Student Report	RUNCTL_CAN_SRSTSEL	Records and Enrollment > Government Reporting Canada > Reports > Selected Student Report > Selected Student Report	Define run parameters for the Student Selection report (SRSTSEL).

Generating a Student List Report

Access the Selected Student Report page (**Records and Enrollment > Government Reporting Canada > Reports > Selected Student Report > Selected Student Report**).

<i>Field or Control</i>	<i>Description</i>
Academic Institution	Enter the institution for which you want to generate a student selection report.
Report Type	Select the report type for which you want to generate a student selection report.
Report Period	Enter the report period for which you want to generate a student selection report. This field prompts against the report period table.

Click **Run** to run this request. PeopleSoft Process Scheduler runs the SRSTSEL process at user-defined intervals.

(Optional) Freezing a Student List

Campus Solutions provides you with the ability to "freeze" the student list.

Running the freeze process is optional. As a result of running the freeze process, the system prevents you from making changes or additions to the CAN_STDNT_LST table after the freeze date you specify. You can change key information after you run the freeze process. The business processes of your institution determine the timing of this process.

Page Used to Freeze a Student List

<i>Page Name</i>	<i>Definition Name</i>	<i>Navigation</i>	<i>Usage</i>
Freeze Student List	RUNCTL_CAN_FRZE	Records and Enrollment > Government Reporting Canada > Processes > Freeze Student List > Freeze Student List	Define run parameters for the Student ID Freeze report (SRFREEZE).

Running the Student List Freeze Process

Access the Freeze Student List page (**Records and Enrollment > Government Reporting Canada > Processes > Freeze Student List > Freeze Student List**).

<i>Field or Control</i>	<i>Description</i>
Academic Institution	Enter the institution for which you want to freeze a student list.
Report Type	Select the report type for which you want to freeze a student list.
Report Period	Enter the report period for which you want to freeze a student list. This field prompts against the report period table.
Student ID Freeze Date	Enter the date on which you want to freeze student list records.

Click **Run** to run this request. PeopleSoft Process Scheduler runs the SRFREEZE process at user-defined intervals.

Running the PSIS Extract Process

This section discusses how to:

- Run the PSIS Institution process.
- Run the PSIS Student process.

Pages Used to Run the PSIS Extract Process

<i>Page Name</i>	<i>Definition Name</i>	<i>Navigation</i>	<i>Usage</i>
PSIS Institution Process	RUNCTL_CAN_ESIS_I	Records and Enrollment > Government Reporting Canada > Processes > PSIS Institution Process > PSIS Institution Process	Define run parameters for the Create Extract for PSIS Instit process (SRXTRESI) and the Create Flat file for PSIS Inst process (SRCRFESI).
PSIS Student Process	RUNCTL_CAN_ESIS_S	Records and Enrollment > Government Reporting Canada > Processes > PSIS Student Process > PSIS Student Process	Define run parameters for the Create Extract for PSIS Stdnt process (SRXTRESS) and the Create Flat file for PSIS Std process (SRCRFESS).

Running the PSIS Institution Process

Access the PSIS Institution Process page (**Records and Enrollment > Government Reporting Canada > Processes > PSIS Institution Process > PSIS Institution Process**).

The PSIS Institution flat file process generates the following three flat files:

- The PSIS ID (institution description) file lists all unique terms and sessions in the term group table.
- The PSIS IP (institution program) file lists all the plans and programs mapped in the Canadian Program and Plan mapping tables.
- The PSIS IC (institution course) file lists all the courses for which classes have been scheduled during the terms and sessions included in the term group table, for the selected reporting period.

<i>Field or Control</i>	<i>Description</i>
Academic Institution	Enter the institution for which you are running the process.
Report Period	Select the period for which you are running the process. This field prompts against the report period table.
File Path	To send the extract output to a file directory, enter a valid directory path that maps to a folder with appropriate read/write permission. If you cannot locate such a folder, consult your system administrator. Note: The file path must have a "\" (backslash symbol) at the end of the path (for example, c:\temp\).

Click **Run** to run this request and select **Create Extract for PSIS Instit**. Click **OK**. After the extract process finishes, return to the Process Scheduler Request page and select **Create Flat file for PSIS Inst**. Click **OK**.

Running the PSIS Student Process

Access the PSIS Student Process page (**Records and Enrollment > Government Reporting Canada > Processes > PSIS Student Process > PSIS Student Process**).

<i>Field or Control</i>	<i>Description</i>
Academic Institution	Enter the institution for which you are running the process.
Report Period	Select the period for which you are running the process. This field prompts against the report period table.
File Path	<p>To send the extract output to a file directory, enter a valid directory path that maps to a folder with appropriate read/write permission. If you cannot locate such a folder, consult your system administrator.</p> <hr/> <p>Note: The file path must have a "/" (slash symbol) at the end of the path (for example, c:\temp\).</p> <hr/>
Student Selection	<p>To define the group of students that you want to process, select one of the following options:</p> <p><i>Process All Students:</i> Select to generate the extract and flat file for all students in the student list table.</p> <p><i>Process Selected Students:</i> Select this option in conjunction with using the Select check box on the Student List Table page. The reports extract process adds data for a new student or replaces reporting data for an existing student. The reporting information for the students who do not have the Select check box selected remains unchanged by the process.</p>

Click **Run** to run this request and select **Create Extract for PSIS Std.** Click **OK**. After the extract process finishes, return to the Process Scheduler Request page and select **Create Flat file for PSIS Stdnt.** Click **OK**.

Running the USISE Extract Process

This section discusses how to run the USISE extract process and generate a corresponding flat file. Run the USISE extract process if you submit your reporting file directly to the federal government.

Follow these steps to run the USISE extract process and flat file generation for all provinces except Ontario:

1. Access the USISE Extract Process page and run the USISE extract process.
2. Access the USISE Extract Process page and run the USISE flat file process.

Note: For Ontario Fall USISE reporting, where the FALL USIS Enrollment reporting submission includes the OUAC elements, running the extract process is a two-step process.

Follow these steps to run the USISE extract process for Ontario *Fall* USISE reporting:

1. Access the MET Extract Process page and run the MET extract process.
2. Access the OUAC Extract Process page and run the OUAC extract process.
3. Access the OUAC Extract Process page and run the OUAC flat file process.

When you run the OUAC flat file generation process, the system generates two files. One file contains only OUAC elements. The second file is a combined file that contains the USISE, MET, and OUAC elements.

To run the USISE extract process for Ontario USISE reporting *not* in Fall:

1. Access the MET Extract Process page and run the MET extract process.
2. Access the MET Extract Process page and run the MET flat file process.

Related Links

[Running the MET Extract Process](#)

[Running the OUAC Extract Process](#)

Page Used to Run the USISE Extract Process

<i>Page Name</i>	<i>Definition Name</i>	<i>Navigation</i>	<i>Usage</i>
USISE Extract Process	RUNCTL_CAN_USE	Records and Enrollment > Government Reporting Canada > Processes > USISE Report Process > USISE Report Process	Define run parameters for the Create Extract for USISE process (SRXTRUSE) and the Create Flat file for USISE process (SRCRFUSE).

Entering USISE Extract Process Parameters

Access the USISE Extract Process page (**Records and Enrollment > Government Reporting Canada > Processes > USISE Report Process > USISE Report Process**).

<i>Field or Control</i>	<i>Description</i>
Academic Institution	Enter the institution for which you are running the process.
Report Period	Select the period for which you are running the process. This field prompts against the report period table.

Field or Control	Description
File Path	<p>To send the extract output to a file directory, enter a valid directory path that maps to a folder with appropriate read/write permission. If you cannot locate such a folder, consult your system administrator.</p> <hr/> <p>Note: The file path must have a "\" (slash symbol) at the end of the path (for example, c:\temp\).</p> <hr/>
Student Selection	<p>To define the group of students that you want to process, select one of the following options:</p> <p><i>Process All Students:</i> Select to generate the extract and flat file for all students in the student list table.</p> <p><i>Process Selected Students:</i> Select this option in conjunction with using the Select check box on the Student List Table page. The reports extract process adds data for a new student or replaces reporting data for an existing student. The reporting information for the students who do not have the Select check box selected remains unchanged by the process.</p>
Data Type	Enter the DATYPE element.
Reporting Type	Enter the INSTYP element.

Click **Run** to run this request and select **Create Extract for USISE**. Click **OK**. After the extract process finishes, return to the Process Scheduler Request page and select **Create Flat file for USISE**. Click **OK**.

Running the CIS Extract Process

This section discusses how to run the CIS extract process and generate a corresponding flat file. Run the CIS extract process if you submit your reporting file directly to the federal government.

Page Used to Run the CIS Extract Process

Page Name	Definition Name	Navigation	Usage
CIS Extract Process	RUNCTL_CAN_CIS	Records and Enrollment > Government Reporting Canada > Processes > CIS Report Process > CIS Extract Process	Define run parameters for the Create Extract for CIS process (SRXTRCIS) and the Create Flat file for CIS process (SRCRFCIS).

Entering CIS Extract Process Parameters

Access the CIS Extract Process page (**Records and Enrollment > Government Reporting Canada > Processes > CIS Report Process > CIS Extract Process**).

<i>Field or Control</i>	<i>Description</i>
Academic Institution	Enter the institution for which you are running the process.
Report Period	Select the period for which you are running the process. This field prompts against the report period table.
File Path	<p>To send the extract output to a file directory, enter a valid directory path that maps to a folder with appropriate read/write permission. If you cannot locate such a folder, consult your system administrator.</p> <hr/> <p>Note: The file path must have a "/" (slash symbol) at the end of the path (for example, c:\temp\).</p>
Student Selection	<p>To define the group of students that you want to process, select one of the following options:</p> <p><i>Process All Students:</i> Select to generate the extract and flat file for all students in the student list table.</p> <p><i>Process Selected Students:</i> Select this option in conjunction with using the Select check box on the Student List Table page. The reports extract process adds data for a new student or replaces reporting data for an existing student. The reporting information for the students who do not have the Select check box selected remains unchanged by the process.</p>

Click **Run** to run this request and select **Create Extract for CIS**. Click **OK**. After the extract process finishes, return to the Process Scheduler Request page and select **Create Flat file for CIS**. Click **OK**.

Running the MET Extract Process

This section discusses how to run the MET extract process and generate a corresponding flat file.

Page Used to Run the MET Extract Process

<i>Page Name</i>	<i>Definition Name</i>	<i>Navigation</i>	<i>Usage</i>
MET Extract Process	RUNCTL_CAN_MET	Records and Enrollment > Government Reporting Canada > Processes > MET Report Process > MET Extract Process	Define run parameters for the Create Extract for MET process (SRXTRMET) and the Create Flat file for MET process (SRCRFMET).

Entering MET Extract Process Parameters

Access the MET Extract Process page (**Records and Enrollment > Government Reporting Canada > Processes > MET Report Process > MET Extract Process**).

<i>Field or Control</i>	<i>Description</i>
Academic Institution	Enter the institution for which you are running the process.
Report Period	Select the period for which you are running the process. This field prompts against the report period table.
File Path	To send the extract output to a file directory, enter a valid directory path that maps to a folder with appropriate read/write permission. If you cannot locate such a folder, consult your system administrator. Note: The file path must have a "/" (slash symbol) at the end of the path (for example, c:\temp\).
Student Selection	To define the group of students that you want to process, select one of the following options: <i>Process All Students:</i> Select to generate the extract and flat file for all students in the student list table. <i>Process Selected Students:</i> Select this option in conjunction with using the Select check box on the Student List Table page. The reports extract process adds data for a new student or replaces reporting data for an existing student. The reporting information for the students who do not have the Select check box selected remains unchanged by the process.
Data Type	Enter the DATYPE element.
Reporting Type	Enter the INSTYP element.

Click **Run** to run this request and select **Create Extract for MET**. Click **OK**. After the extract process finishes, return to the Process Scheduler Request page and select **Create Flat file for MET**. Click **OK**.

Running the OUAC Extract Process

In Ontario, running the MET extract process and generating the MET flat file will satisfy most of your reporting.

However, in Ontario, where the FALL USIS Enrollment reporting submission includes the OUAC elements, the process is more complex.

Follow these steps to generate the OUAC report for Ontario Fall USIS Enrollment reporting:

1. Run the MET extract process.
2. Run the OUAC extract process.
3. Run the OUAC flat file generation process.

When you run the flat file process for OUAC, it generates two files. One file contains just the OUAC elements, and the second file is a combined file that contains the USISE, MET, and OUAC elements.

Related Links

[Running the MET Extract Process](#)

Page Used to Run the OUAC Extract Process

<i>Page Name</i>	<i>Definition Name</i>	<i>Navigation</i>	<i>Usage</i>
OUAC Extract Process	RUNCTL_CAN_OUAC	Records and Enrollment > Government Reporting Canada > Processes > OUAC Report Process > OUAC Extract Process	Define run parameters for the Create Extract for OUAC process (SRXTROUC) and the Create Flat file for OUAC process (SRCRFOUC).

Entering OUAC Extract Process Parameters

Access the OUAC Extract Process page (**Records and Enrollment > Government Reporting Canada > Processes > OUAC Report Process > OUAC Extract Process**).

<i>Field or Control</i>	<i>Description</i>
Academic Institution	Enter the institution for which you are running the process.
Report Period	Select the period for which you are running the process. This field prompts against the report period table.
File Path	To send the extract output to a file directory, enter a valid directory path that maps to a folder with appropriate read/write permission. If you cannot locate such a folder, consult your system administrator. Note: The file path must have a "/" (slash symbol) at the end of the path (for example, c:\temp\).

Field or Control	Description
Student Selection	<p>To define the group of students that you want to process, select one of the following options:</p> <p><i>Process All Students:</i> Select to generate the extract and flat file for all students in the student list table.</p> <p><i>Process Selected Students:</i> Select this option in conjunction with using the Select check box on the Student List Table page. The reports extract process adds data for a new student or replaces reporting data for an existing student. The reporting information for the students who do not have the Select check box selected remains unchanged by the process.</p>

Click **Run** to run this request and select **Create Extract for OUAC**. Click **OK**. After the extract process finishes, return to the Process Scheduler Request page and select **Create Flat file for OUAC**. Click **OK**.

Verifying Report Results and Viewing the Audit Reports

After you run the extract process, you can run a number of audit reports to verify that the system generated reporting data for all students in the student list table. This section discusses how to:

- Run the Student Description Audit.
- Run the Student Program Audit.
- Run the Student Course Audit.

Pages Used to Verify Report Results

Page Name	Definition Name	Navigation	Usage
Student Description Audit	RUNCTL_CAN_SDAUD	Records and Enrollment > Government Reporting Canada > Reports > Student Description Audit > Student Description Audit	PSIS: Verify that the system reported all students in the student list table. This report compares the students reported in the SD file to each unique student ID in the CAN_STDNT_LST table and reports the differences.

Page Name	Definition Name	Navigation	Usage
Student Program Audit	RUNCTL_CAN_SPAUD	Records and Enrollment > Government Reporting Canada > Reports > Student Program Audit > Student Program Audit	<p>PSIS: Verify that there is a corresponding record in the CAN_RPT_ESIS_SP table for all entries in the CAN_STDNT_LST table. Specifically, verify that the career, program, and plan entered for the student in the student list table are valid. If they are not, then the extract program does not produce a record on the SP, SC, and ST files. Invalid students will also be included in the report if the career, program, or plan entered for the student is not valid.</p> <p>CIS, MET, OUAC, USISE: Verify report discrepancies such as an invalid EMPLID, career, program, or plan.</p>
Student Course Audit	RUNCTL_CAN_SCAUD	Records and Enrollment > Government Reporting Canada > Reports > Student Course Audit > Student Course Audit	<p>PSIS: Identify students who are enrolled in duplicate course IDs during the reporting period. If you find duplicate course IDs, you must manually delete one of the classes from the Student Course 1 page, as this condition will fail the Stats Canada audit.</p> <p>See Reviewing Report Data.</p>

Running the Student Description Audit

Access the Student Description Audit page (**Records and Enrollment > Government Reporting Canada > Reports > Student Description Audit > Student Description Audit**).

Field or Control	Description
Academic Institution	Enter the institution for which you want to audit.
Report Period	Select the report period for which you want to audit.

Click **Run** to run the SRSDAUD report using PeopleSoft Process Scheduler.

Running the Student Program Audit

Access the Student Program Audit page (**Records and Enrollment > Government Reporting Canada > Reports > Student Program Audit > Student Program Audit**).

<i>Field or Control</i>	<i>Description</i>
Academic Institution	Enter the institution that you want to audit.
Report Type	Select the report type that you want to audit.
Report Period	Select the report period that you want to audit.

Click **Run** to run the SRSPAUD report using PeopleSoft Process Scheduler.

Running the Student Course Audit

Access the Student Course Audit page (**Records and Enrollment > Government Reporting Canada > Reports > Student Course Audit > Student Course Audit**).

<i>Field or Control</i>	<i>Description</i>
Academic Institution	Enter the institution that you want to audit.
Report Period	Select the report period that you want to audit.

Click **Run** to run the SRSCAUD report using PeopleSoft Process Scheduler.

Reviewing Report Data

After you run the extract process, you can view and edit the results by navigating to online pages that display the extract report results. However, you cannot add a new row of information for a student. If you need to add a row of data, you must add another line in the CAN_STDNT_LST table with its associated key field values and rerun the extract report.

Pages Used to Review Report Data

<i>Page Name</i>	<i>Definition Name</i>	<i>Navigation</i>	<i>Usage</i>
PSIS Institution Description	CAN_RPT_ESIS_ID	Records and Enrollment > Government Reporting Canada > Suspense Tables > PSIS Institution Description > PSIS Institution Description	PSIS: Review institution term data.
Institution Program 1	CAN_RPT_ESIS_IP	Records and Enrollment > Government Reporting Canada > Suspense Tables > PSIS Institution Program > Institution Program 1	PSIS: Review institution and program code data.
Institution Program 2	CAN_RPT_ESIS_IP3	Records and Enrollment > Government Reporting Canada > Suspense Tables > PSIS Institution Program > Institution Program 2	PSIS: Review additional institution and program code data.
PSIS Institution Course	CAN_RPT_ESIS_IC	Records and Enrollment > Government Reporting Canada > Suspense Tables > PSIS Institution Course > PSIS Institution Course	PSIS: Review additional institution and program code data.
Student Descr 1 (student description 1)	CAN_RPT_ESIS_SD	Records and Enrollment > Government Reporting Canada > Suspense Tables > PSIS Student Description > Student Descr 1	PSIS: Review descriptive data for a student.
Student Descr 2 (student description 2)	CAN_RPT_ESIS_SD2	Records and Enrollment > Government Reporting Canada > Suspense Tables > PSIS Student Description > Student Descr 2	PSIS: Review additional descriptive data for a student.
Student Descr 3 (student description 3)	CAN_RPT_ESIS_SD1	Records and Enrollment > Government Reporting Canada > Suspense Tables > PSIS Student Description > Student Descr 3	PSIS: Review additional descriptive data for a student.

Page Name	Definition Name	Navigation	Usage
Student Descr 4 (student description 4)	CAN_RPT_ESIS_SD3	Records and Enrollment > Government Reporting Canada > Suspense Tables > PSIS Student Description > Student Descr 4	PSIS: Review additional descriptive data for a student.
Student Descr 5 (student description 5)	CAN_RPT_ESIS_SD6	Records and Enrollment > Government Reporting Canada > Suspense Tables > PSIS Student Description > Student Descr 5	PSIS: Review additional descriptive data for a student.
Student Program 1	CAN_RPT_ESIS_SP	Records and Enrollment > Government Reporting Canada > Suspense Tables > PSIS Student Program > Student Program 1	PSIS: Review program related data for a student.
Student Program 2	CAN_RPT_ESIS_SP2	Records and Enrollment > Government Reporting Canada > Suspense Tables > PSIS Student Program > Student Program 2	PSIS: Review additional program related data for a student.
Student Program 3	CAN_RPT_ESIS_SP3	Records and Enrollment > Government Reporting Canada > Suspense Tables > PSIS Student Program > Student Program 3	PSIS: Review additional program related data for a student.
Student Program 4	CAN_RPT_ESIS_SP4	Records and Enrollment > Government Reporting Canada > Suspense Tables > PSIS Student Program > Student Program 4	PSIS: Review additional program related data for a student.
Student Course 1	CAN_RPT_ESIS_SC	Records and Enrollment > Government Reporting Canada > Suspense Tables > PSIS Student Course > Student Course 1	PSIS: Review course related data for a student.

Page Name	Definition Name	Navigation	Usage
Student Course 2	CAN_RPT_ESIS_SC2	Records and Enrollment > Government Reporting Canada > Suspense Tables > PSIS Student Course > Student Course 2	PSIS: Review additional course related data for a student.
Student Course 3	CAN_RPT_ESIS_SC3	Records and Enrollment > Government Reporting Canada > Suspense Tables > PSIS Student Course > Student Course 3	PSIS: Review additional course related data for a student.
Student Trans Cred 1	CAN_RPT_ESIS_ST	Records and Enrollment > Government Reporting Canada > Suspense Tables > PSIS Student Transfer Credits > Student Trans Cred 1	PSIS: Review receiving institution transfer coursework for a student.
Student Trans Cred 2	CAN_RPT_ESIS_ST2	Records and Enrollment > Government Reporting Canada > Suspense Tables > PSIS Student Transfer Credits > Student Trans Cred 2	PSIS: Review external institution transfer coursework for a student.
USISE Elements 1	CAN_USISE	Records and Enrollment > Government Reporting Canada > Suspense Tables > USISE Elements > USISE Elements 1	USISE: Review USISE elements data for a student.
USISE Elements 2	CAN_USISE_2	Records and Enrollment > Government Reporting Canada > Suspense Tables > USISE Elements > USISE Elements 2	USISE: Review additional USISE elements data for a student.
CIS Elements 1	CAN_CIS	Records and Enrollment > Government Reporting Canada > Suspense Tables > CIS Elements > CIS Elements 1	CIS: Review CIS elements for a student.

Page Name	Definition Name	Navigation	Usage
CIS Elements 2	CAN_CIS2	Records and Enrollment > Government Reporting Canada > Suspense Tables > CIS Elements > CIS Elements 2	CIS: Review additional CIS elements for a student.
CIS Elements 3	CAN_CIS1	Records and Enrollment > Government Reporting Canada > Suspense Tables > CIS Elements > CIS Elements 3	CIS: Review additional CIS elements for a student.
MET Elements 1	CAN_USMET	Records and Enrollment > Government Reporting Canada > Suspense Tables > MET Elements > MET Elements 1	MET: Review MET elements for a student.
MET Elements 2	CAN_USMET_2	Records and Enrollment > Government Reporting Canada > Suspense Tables > MET Elements > MET Elements 2	MET: Review additional MET elements for a student.
MET Elements 3	CAN_USMET1	Records and Enrollment > Government Reporting Canada > Suspense Tables > MET Elements > MET Elements 3	MET: Review additional MET elements for a student.
OUAC Elements	CAN_OUAC	Records and Enrollment > Government Reporting Canada > Suspense Tables > OUAC Elements > OUAC Elements	OUAC: Review OUAC Elements for a student.

(Optional) Correcting Report Data

Before you send your report to the government, you may want to correct the reporting data. You can correct reporting data in one of two ways:

1. Campus Solutions source pages (student data or setup data).
2. Report data pages (for example, the Student Course 1 page).

When you rerun the report, the system reprocesses any changes that you make using method one, as long as the effective date of the change is less than or equal to the value in the **Report Due Date** field on the Can Report Period page. This implies that you must rerun the extract program. If you do not enter a date in the **Report Due Date** field, the system references the system date to determine what to include in the report.

Note: You will make most corrections using method number one. You should correct data using method two only if you are certain that you will not be required to rerun the reports extract program. The extract program will overwrite any corrections you make in method two when you rerun the process. Changes made through method two are best used for updating the flat file.

Archiving Extract Table Data

After you submit the flat files to the government, you can archive the data in the reports extract archive tables. This process takes the data in the extract tables and saves it to archive tables. The report date acts as an effective date; so you can store multiple report periods in the applicable archive tables. After you run the archive process for a particular report and report period, you cannot run the archive process again. If you attempt to do so, the archive program writes a message in the log file.

The system archives your data in the following tables:

- CAN_ARC_ESIS_IC
- CAN_ARC_ESIS_ID
- CAN_ARC_ESIS_IP
- CAN_ARC_ESIS_SC
- CAN_ARC_ESIS_SD
- CAN_ARC_ESIS_SP
- CAN_ARC_ESIS_ST
- CAN_ARCH_USISE
- CAN_ARCH_USMET
- CAN_ARCH_CIS
- CAN_ARCH_OUAC

Page Used to Archive Extract Data

<i>Page Name</i>	<i>Definition Name</i>	<i>Navigation</i>	<i>Usage</i>
Archive Extract File	RUNCTL_CAN_ARCHIVE	Records and Enrollment > Government Reporting Canada > Processes > Archive Extract File > Archive Extract File	All: Define run parameters for the Canada Report Archive process (SRARCH).

Running the Archive Process

Access the Archive Extract File page (**Records and Enrollment > Government Reporting Canada > Processes > Archive Extract File > Archive Extract File**).

<i>Field or Control</i>	<i>Description</i>
Academic Institution	Enter the institution that you want to archive.
Report Type	Enter the report type that you want to archive.
Report Period	Enter the report period that you want to archive.

Click **Run** to run the SRARCH report using PeopleSoft Process Scheduler.

(GBR) Managing HESA Returns

Understanding HESA Returns

Government-funded academic institutions in the United Kingdom (UK) must submit student related returns of data to HESA. Institutions must submit the returns as an Extensible Markup Language (XML) file that conforms to the HESA schema definition.

A return is composed of various data fields. Specifications for each return and its data fields are available from the [HESA website](#). HESA periodically amends the return specifications.

PeopleSoft Campus Solutions enables you to generate the Student, Aggregate Offshore, and Initial Teacher Training (ITT) returns for the 2008–09 reporting period onwards. In addition, you can generate a Destinations of Leavers from Higher Education (DLHE) return from the 2009–10 reporting period onwards and the Unistats (formerly Key Information Set – KIS) return for 2013–14 onwards.

To generate returns for submission:

1. Select the **HESA, UCAS** check box on the SA Features page.
2. Select the **HESA, UCAS** check box on the Academic Institution 6 page to enable the UK-specific regions in the system for an institution.
3. Set up the valid HESA field codes.
4. Enter HESA-specific data into your system.
5. Generate the HESA extract data.
6. Generate the XML file for the returns.
7. Validate the XML file for any schema errors.

Plan how you want the system to derive the return field values. Oracle recommends that you review the return type specification that is available from the HESA website to review the field descriptions, validations, and the valid field values. To understand how the system derives the fields, see [Understanding HESA Derivation Steps](#).

Fields not included in Unistats/KIS

The system includes all the entities and fields for the Unistats/KIS return in the return except for the following:

- Fields specific to institutions in Wales:
 - Location.ACCOMURLW
 - Location.LOCNAMEW

- KISCourse.ASSURLW
 - KISCourse.CRSEURLW
 - KISCourse.EMPLOYERURLW
 - KISCourse.LTURLW
 - KISCourse.SUPPORTURLW
 - KISCourse.TITLEW
 - Accreditation.ACCDEPENDURLW
-
- Field specific to Further Education colleges (FEC): KISCourse.LDCS
 - Field specific to 4 joint medical and pharmaceutical schools: HESACourse.JOINTUKPRN

Importing and Mapping HESA Codes

First, you import HESA field codes into your system. These codes are the valid values that the system can assign to a field in a return. For example, the **Student.NATION** field has HESA codes such as *DE* for Germany and *AU* for Australia.

To import HESA codes:

1. Place the HESA code list XSD file in a local directory before you access the Import HESA Codes page.
2. Use the Import HESA Codes page to load the HESA codes from the XSD file to your system.

After importing the codes, you can use the Codes page to search and view the imported codes. Also, you can use the Codes page to manually add new codes for fields.

In some cases, you must use the Code Mapping pages to map the HESA codes with the Campus Solutions codes. For example, you must map Campus Solutions marital status codes to the HESA marital status codes. You can delete a mapping by clicking the **Delete Row** button or inactivate a mapping by clearing the **Active** check box in all the Code Mapping pages.

On all the Mapping pages, such as the Ethnicity page, the drop-down fields display both the inactive and active Campus Solutions codes. For example, if you use the Ethnic Groups page (**Set Up Common Objects > Product Related > Workforce Administration > Ethnic Groups**) to set the *ABC* ethnic group as inactive, the system continues to display *ABC* as the drop-down value for the Ethnic Group field on the Ethnicity page.

This section discusses how to:

- Import HESA codes.
- Search for the imported HESA codes.
- Map ethnic codes.

- Map campus codes.
- Map marital status codes.
- Map religion codes.
- Map qualification codes.
- Map nationality codes.
- Map fee eligibility codes.
- Map mode of study codes.
- Map classification codes.
- Map disability codes.
- Map module outcome codes.
- Map orientation codes.
- Map entry qualifications.

Note: For Aggregate Offshore return, the mapping for campus codes is required. For ITT return, the mappings for ethnicity, nationality, mode of study, and disability codes are required.

Note for Unistats/KIS

Some codes are not provided in Cnn061CodeLists.xsd and you need to manually add them via the Codes page. The codes that you need to manually add are:

- ACCTYPE
- ILRAIMID
- KISAIM

Pages Used to Import and Map HESA Codes

<i>Page Name</i>	<i>Definition Name</i>	<i>Navigation</i>	<i>Usage</i>
Import HESA Codes	SSR_HE_RUNCNTL	Records and Enrollment > HESA Reporting > Codes and Mappings > Import HESA Codes	Import HESA codes from the XML Schema Definition (XSD) file. The code list XSD file is available from the HESA website.
Codes	SSR_HE_CODES	Records and Enrollment > HESA Reporting > Codes and Mappings > Codes	View the codes that you have imported from the code list XSD file. If required, add new codes for fields.

Page Name	Definition Name	Navigation	Usage
Ethnicity	SCC_HE_ETHNIC	Records and Enrollment > HESA Reporting > Codes and Mappings > Code Mappings > Ethnicity	Map Campus Solutions regulatory region and ethnic group codes to the HESA ethnicity codes.
Campus	SSR_HE_CAMPUS	Records and Enrollment > HESA Reporting > Codes and Mappings > Code Mappings > Campus	Map Campus Solutions campus codes to the HESA campus and Institution's Own Campus codes.
Marital Status	SCC_HE_MARITAL	Records and Enrollment > HESA Reporting > Codes and Mappings > Code Mappings > Marital Status	Map Campus Solutions marital status codes to the HESA marital status codes.
Religion	SCC_HE_RELIGION	Records and Enrollment > HESA Reporting > Codes and Mappings > Code Mappings > Religion	Map Campus Solutions religious preference codes to the HESA belief and religion codes.
Qualification	SSR_HE_QUALIFIC	Records and Enrollment > HESA Reporting > Codes and Mappings > Code Mappings > Qualification	Map Campus Solutions degree codes to the HESA qualification codes.
Nationality	SCC_HE_NATIONALITY	Records and Enrollment > HESA Reporting > Codes and Mappings > Code Mappings > Nationality	Map Campus Solutions country codes to the HESA nationality codes.
Fee Eligibility	SSR_HE_FEE_ELIG	Records and Enrollment > HESA Reporting > Codes and Mappings > Code Mappings > Fee Eligibility	Map Campus Solutions residency codes to the HESA fee eligibility codes.
Mode of Study	SSR_HE_MODE_STD	Records and Enrollment > HESA Reporting > Codes and Mappings > Code Mappings > Mode of Study	Map Campus Solutions academic load codes to the HESA mode of study codes.
Classification	SSR_HE_CLASSIFI	Records and Enrollment > HESA Reporting > Codes and Mappings > Code Mappings > Classification	Map Campus Solutions honors type and honors codes to the HESA classification codes.

Page Name	Definition Name	Navigation	Usage
Disability	SCC_HE_DISABILITY	Records and Enrollment > HESA Reporting > Codes and Mappings > Code Mappings > Disability	<p>Map Campus Solutions type of impairment and support services request codes to the HESA disability codes.</p> <p>Note that the system creates disability records as part of Universities & Colleges Admissions Service (UCAS) processing.</p> <p>For information on how to assign impairment codes to students and specify whether or not support services have been requested, refer to “Identifying Regional Impairment and Support Services” (Campus Community Fundamentals)</p>
Module Outcome	SSR_HE_MODULE	Records and Enrollment > HESA Reporting > Codes and Mappings > Code Mappings > Module Outcome	Map Campus Solutions grading scheme, grading basis, grade input, and grade category codes to the HESA module outcome codes.
Gender	SCC_HE_GENDER	Records and Enrollment > HESA Reporting > Codes and Mappings > Code Mappings > Gender	Map Campus Solutions gender values to HESA gender identifiers.
Orientation	SSR_HE_ORIENT	Records and Enrollment > HESA Reporting > Codes and Mappings > Code Mappings > Orientation	Map Campus Solutions orientation values to HESA orientation identifiers.
Entry Qualification Mapping	SSR_HE_QOE_MAP	Records and Enrollment > HESA Reporting > Codes and Mappings > Entry Qualification Mapping	Map a qualification type to a list of valid grades for that qualification. If grades are not mapped to a particular qualification type, then all the grades are available for a qualification type on the Entry Profile page. If you do this mapping, the Entry Profile page displays only the mapped grades for a type.

Importing HESA Codes

Access the Import HESA Codes page (**Records and Enrollment > HESA Reporting > Codes and Mappings > Import HESA Codes**).

Field or Control	Description
Add Attachment	<p>Click to browse to the CodeLists.xsd file that HESA delivers, and click Upload. You can browse your local drive and select a file.</p> <hr/> <p>Note: The upload process creates a files subdirectory to store and process the XSD file. This subdirectory is created in the server directory location that is specified in the PS_SERVDIR system parameter in the Application Server/Process Scheduler configuration file psappsrv.cfg/psprcs.cfg. Ensure that PS_SERVDIR is set up with an appropriate value in the configuration file and that users have the correct permission to access the files subdirectory.</p> <hr/>
XSD File Path	<p>Enter the path and file name of the HESA codes XSD file. You must store this XSD file on an application server that the import process can access.</p>

Warning! For the import process to run properly, the CodeLists.xsd file should not be renamed. The import process uses the CodeLists xsd file name to determine the return type. For example, in C08053CodeLists.xsd, 053 indicates that the file is the xsd for the ITT return. If the file is renamed, the position of substring "053" might be changed or deleted. If it is not present in the filename, then it will not be correctly decoded as the ITT return. In addition, if the institution imports the Codelists for both the ITT and the Student returns, then import the ITT Codelist file first and then import the Student Codelist.

Note that institutions need to handle the deletion of processed files from the application server. Therefore, after using a CodeLists.xsd file, you will need to handle the deletion of this file from the application server.

For Unistats/KIS return, the process imports:

- LEVEL values to the LEVELK field rather than the LEVEL field which is for the Aggregate Offshore return.
- JACS values to the JACSA field rather than the JACS field which is for the DLHE return.

Notes

The import process does not import codes for fields that are not required by the system, for example EMPFEES. The log file for the process includes messages for codes that are not imported.

When there are multiple fields with the same HESA data type, the process will create the codes for each of the fields. For example, when importing codes for MOBTYP, the process imports the same codes and descriptions for MOBTYP2 and MOBTYP3.

The codes for some fields in the ITT return are either identical to, or a subset of, the codes in the Student return. For such fields, the process does not import the codes for the ITT return. The process does not import the following codes for an ITT code list (Cnn053CodeLists.xsd):

- DISABLE
- DISALL

- ENTRYRTE
- ETHNIC
- FUNDCODE
- ITTPHSC
- ITTSCHMS
- MODE
- MSTUFEE
- PGCECLSS
- PGCESBJ
- RSNEND
- SBJCA
- SEXID
- TTCID
- UNITLGTH

From a Unistats/KIS code list file (Cnn061CodeLists.xsd), codes for this field are not imported: TTCID (same codes as Student return).

For the Graduate Outcomes return, existing COUNTRY codes (used in the DFSTDNT return) are not inactivated by the import process.

If any of the codes that the process does not import for ITT or Unistats/KIS are required by your institution before the code list for the Student return is imported, then you can add such codes manually through the Codes page.

Searching for the Imported HESA Codes

Access the Codes search page (**Records and Enrollment > HESA Reporting > Codes and Mappings > Codes**).

This example illustrates the fields and controls on the Codes search page. You can find definitions for the fields and controls later on this page.

Codes
Enter any information you have and click Search. Leave fields blank for a list of all values.

[Find an Existing Value](#) [Add a New Value](#)

Field: begins with

Code: begins with

Case Sensitive

[Basic Search](#)

Search Results

View All First 1-2 of 2 Last

Field	Code	Description
ACCESS	1	Entered HE via the SWAP
ACCESS	2	Entered HE via other access pr

Use the Codes search page to search for all the codes of a specific field. If required, click the **Add a New Value** link to manually add a code for a field.

Click the **Add a New Value** link or click a link in the **Search Results** group box to access the Codes page.

This example illustrates the fields and controls on the Codes page. You can find definitions for the fields and controls later on this page.

Codes

Field: ACCESS Access programmes

Code: 1

Code

Description:

Long Description:

Imported Active

The text in the **Description** field can accept a maximum of 30 characters. Note that when you select a code on a data capture page, the page displays the text from the **Description** field. If the Import HESA Codes Application Engine (SSR_HE_IMPCD) process has cut a description text that extends beyond

30 characters, you can modify the description text so that a meaningful description appears on the data capture pages.

The "Setting Up and Entering Data for HESA Reporting" section discusses the data capture pages.

Mapping Ethnic Codes

Access the Ethnicity page (**Records and Enrollment > HESA Reporting > Codes and Mappings > Code Mappings > Ethnicity**).

This example illustrates the fields and controls on the Ethnicity page. You can find definitions for the fields and controls later on this page.

*Regulatory Region	*Ethnic Group	Description	HESA Ethnicity	Description	ETHNIC	Active
1 GBR	ASNIND	Asian British/Indian		31 Asian or Asian British - India	<input checked="" type="checkbox"/>	
2 GBR	ASNPKN	Asian British/Pakistani		32 Asian or Asian British - Pakis	<input checked="" type="checkbox"/>	
3 GBR	BLKAFR	Black British/African		22 Black or Black British - Afric	<input checked="" type="checkbox"/>	
4 GBR	BLKCAR	Black British/Caribbean		21 Black or Black British - Carib	<input checked="" type="checkbox"/>	
5 GBR	CHINESE	Chinese		34 Chinese	<input checked="" type="checkbox"/>	
6 GBR	REFUSE	Information Refused		98 Information refused	<input checked="" type="checkbox"/>	
7 GBR	WHITE	White		10 White	<input checked="" type="checkbox"/>	

Map Campus Solutions regulatory region and ethnic group codes to the HESA ethnicity codes. The system uses this mapping to derive the Student.ETHNIC field values (for both Student and ITT returns), and the Student.ETHNICS field for the Data Futures return.

Mapping Campus Codes

Access the Campus page (**Records and Enrollment > HESA Reporting > Codes and Mappings > Code Mappings > Campus**).

This example illustrates the fields and controls on the Campus page. You can find definitions for the fields and controls later on this page.

*Campus	Description	Venue ID	Venue Name	Campus ID	Own Campus ID	Active
LEEDS	Leeds Campus			L	L	<input checked="" type="checkbox"/>
MAIN	Main Campus	A	Main City Campus	M	M	<input checked="" type="checkbox"/>

Map the Campus Solutions campus codes to the (HESA) **Venue ID**, **Campus ID** and (HESA) **Own Campus ID** codes. The system uses this mapping to derive the Instance.CAMPID, Instance.INSTCAMP, and Provision.INSTCAMP field values.

Mapping Marital Status Codes

Access the Marital Status page (**Records and Enrollment > HESA Reporting > Codes and Mappings > Code Mappings > Marital Status**).

This example illustrates the fields and controls on the Marital Status page. You can find definitions for the fields and controls later on this page.

*Marital Status	HESA Marital Status	Description	MARSTAT	Description	Active
Common-Law			06	Co-habiting	<input checked="" type="checkbox"/>
Divorced			04	Divorced	<input checked="" type="checkbox"/>
Separated			03	Separated (but still legally m	<input checked="" type="checkbox"/>
Married			02	Married	<input checked="" type="checkbox"/>
Single			01	Single (never married)	<input checked="" type="checkbox"/>
Widowed			05	Widowed	<input checked="" type="checkbox"/>

Map the Campus Solutions marital status codes to the HESA marital status codes. The system uses this mapping to derive the EntryProfile.MARSTAT field value.

Mapping Religion Codes

Access the Religion page (**Records and Enrollment > HESA Reporting > Codes and Mappings > Code Mappings > Religion**).

This example illustrates the fields and controls on the Religion page. You can find definitions for the fields and controls later on this page.

*Religious Preference	Description	HESA Religion	Description	RELBLF	Description	RELIGION	Description	Active
BDHS	Buddhist			02	Buddhist	3	Other	<input checked="" type="checkbox"/>
CHRS	Christian			03	Christian	1	Protestant	<input checked="" type="checkbox"/>
CTLC	Catholic			05	Christian - Roman Catholic	2	Roman Catholic	<input checked="" type="checkbox"/>
HNDU	Hindu			10	Hindu	3	Other	<input checked="" type="checkbox"/>
ISLM	Islamic			12	Muslim	3	Other	<input checked="" type="checkbox"/>
JWSH	Jewish			11	Jewish	3	Other	<input checked="" type="checkbox"/>

Map the Campus Solutions religious preference codes to the HESA belief and religion codes. The system uses this mapping to derive the Student.RELBLF, EntryProfile.RELIGION field values, and the Student.RELIGIONS field values in the Data Futures return.

Mapping Qualification Codes

Access the Qualification page (**Records and Enrollment > HESA Reporting > Codes and Mappings > Code Mappings > Qualification**).

This example illustrates the fields and controls on the Qualification page. You can find definitions for the fields and controls later on this page.

*Degree	Description	Type	Description	QUAL	Active
BA	Bachelor of Arts			H00	<input checked="" type="checkbox"/>

The system uses this mapping to derive the Entry Qualification Award entities from External Degrees.

Mapping Nationality Codes

Access the Nationality page (**Records and Enrollment > HESA Reporting > Codes and Mappings > Code Mappings > Nationality**).

This example illustrates the fields and controls on the Nationality page . You can find definitions for the fields and controls later on this page.

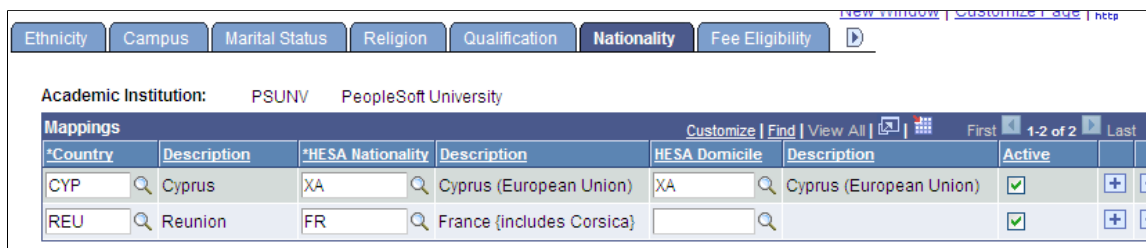

Map the Campus Solutions country codes to the HESA nationality codes. The system uses this mapping to derive the Student return's Student.NATION and EntryProfile.DOMICILE field values and ITT return's Student.DEGCTRY field value.

You map only certain Campus Solutions country codes to the HESA codes for Nationality. In most cases, the system can use the two-character Campus Solutions country code (COUNTRY_2CHAR) from the Country table (PS_COUNTRY_TBL).

Field or Control	Description
HESA Nationality	Enter a value only if the two-character Campus Solutions country code is not a valid value for Student.NATION and Student.DEGCTRY. For example, the French territory of Reunion Island has its own country code <i>RE</i> but the academic institution must report the value as France <i>FR</i> in Student.NATION and Student.DEGCTRY. If you do not select a value, the system uses the default two-character country code.
HESA Domicile	Enter a value only if the two-character Campus Solutions country code is not a valid value for EntryProfile.DOMICILE. If you do not select a value, the system uses the default two-character country code.

In the above exhibit example, the institution has mapped both Nationality and Domicile to *XA* for Cyprus. Therefore, if a student's record in Campus Solutions has a country code of *CYP*, the system uses the *XA* value for Student.NATION and Student.DEGCTRY, and uses the same value *XA* for EntryProfile.DOMICILE. Also, in the second row of the exhibit example, the setup indicates that if the student's record in Campus Solutions has a country code of *REU* (Reunion Island), then the system uses the value of *FR* for Student.NATION and Student.DEGCTRY. In such a case, because the HESA Domicile field has been left blank, the system uses the default two-character country code of *RE* for reporting EntryProfile.DOMICILE of the student.

See [Nationality \(NATION\)](#)

See [Domicile \(DOMICILE\)](#)

Mapping Fee Eligibility Codes

Access the Fee Eligibility page (**Records and Enrollment > HESA Reporting > Codes and Mappings > Code Mappings > Fee Eligibility**).

This example illustrates the fields and controls on the Fee Eligibility page. You can find definitions for the fields and controls later on this page.

*Residency	Description	HESA Fee Eligibility	Description	HESA Fee Status	Description	FEELIG	Description	Active
EU	Home/European Union					1	Eligible to pay home fees	<input checked="" type="checkbox"/>
HOME	Home/United Kingdom					1	Eligible to pay home fees	<input checked="" type="checkbox"/>
OVS	Overseas					2	Not eligible to pay home fees	<input checked="" type="checkbox"/>

Map Campus Solutions residency codes to the HESA fee eligibility codes. The system uses this mapping to derive the Instance.FEELIG field value, and the Engagement.FEELIGE and FEESTATUS field values in the Data Futures return.

Mapping Mode of Study Codes

Access the Mode of Study page (**Records and Enrollment > HESA Reporting > Codes and Mappings > Code Mappings > Mode of Study**).

This example illustrates the fields and controls on the Mode of Study page. You can find definitions for the fields and controls later on this page.

*Academic Load	Session Mode	Description	Session Status	Description	MODE	Active
Full-Time	01	Full time	01	Active	01	<input checked="" type="checkbox"/>
Part-Time	31	Part time	01	Active	31	<input checked="" type="checkbox"/>

Map the Campus Solutions academic load codes to the (HESA) Session and (HESA) Mode of Study codes. The system uses this mapping to derive the Student return's Instance.MODE ITT return's Student.MODE field values, and the Data Futures return's StudentCourseSession.SCSMODE and SessionStatus.STATUSCHANGEDTO.

Mapping Classification Codes

Access the Classification page (**Records and Enrollment > HESA Reporting > Codes and Mappings > Code Mappings > Classification**).

This example illustrates the fields and controls on the Classification page. You can find definitions for the fields and controls later on this page.

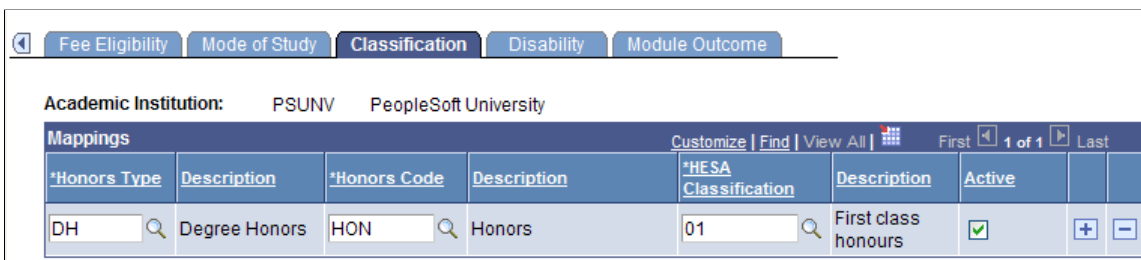

Map the Campus Solutions honors code and type codes to the HESA classification codes. The system uses this mapping to derive the QualificationAwarded.QUALRESULT field value.

Mapping Disability Codes

Access the Disability page (**Records and Enrollment > HESA Reporting > Codes and Mappings > Code Mappings > Disability**).

This example illustrates the fields and controls on the Disability page. You can find definitions for the fields and controls later on this page.

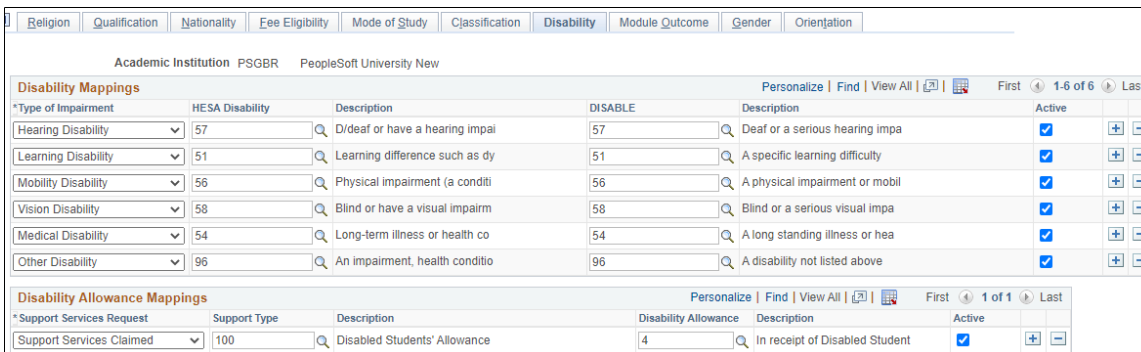

Disability Mappings

Use this region to map the Campus Solutions type of Impairment codes to the HESA disability codes. The system uses this mapping to derive the Student.DISABLE field value (for both Student and ITT returns), and the Disability entity in the Data Futures return.

Disability Allowance Mappings

Use this region to map the Campus Solutions support services request codes to the HESA disability allowance codes. The system uses this mapping to derive the DISALL field value (for both Student and ITT returns).

Mapping Module Outcome Codes

Access the Module Outcome page (**Records and Enrollment > HESA Reporting > Codes and Mappings > Code Mappings > Module Outcome**).

This example illustrates the fields and controls on the Module Outcome page. You can find definitions for the fields and controls later on this page.

Map the Campus Solutions grade input and grade category codes to the HESA module outcome codes. The system uses this mapping to derive the Student On Module.MODOUT field value.

Mapping Gender Codes

Access the Gender page (**Records and Enrollment > HESA Reporting > Codes and Mappings > Code Mappings > Gender**).

This example illustrates the fields and controls on the Gender page. You can find definitions for the fields and controls later on this page.

*Gender	HESA Sex Identifier	Description	SEXID	Description	Active
Female			2	Female	<input checked="" type="checkbox"/>
Male			1	Male	<input checked="" type="checkbox"/>

The system uses this mapping to derive the Student.SEXID field values for the Student and ITT returns, and the Student.SEXIDS field values in the Data Futures return.

Mapping Orientation Codes

Access the Orientation page (**Records and Enrollment > HESA Reporting > Codes and Mappings > Code Mappings > Orientation**).

This example illustrates the fields and controls on the Orientation page. You can find definitions for the fields and controls later on this page.

*Sexual Orientation	HESA Sexual Orientation	Description	SEXORT	Description	Active
Other	16	Other	05	Other	<input checked="" type="checkbox"/>
Prefer not to say	98	Information refused	98	Information refused	<input checked="" type="checkbox"/>
Unknown	99	Not available	99	Not available	<input checked="" type="checkbox"/>

The system uses this mapping to derive the Student.SEXORT field values for the Student and ITT returns, and the Student.SEXORTS field values in the Data Futures return.

Note: This page is available only in Campus Solutions 9.2 and is used to derive values from the Person Biographic record.

Mapping Entry Qualification

Access the Entry Qualification Mapping page (**Records and Enrollment > HESA Reporting > Codes and Mappings > Entry Qualification Mapping**).

This example illustrates the fields and controls on the Entry Qualification Mapping page. You can find definitions for the fields and controls later on this page.

Entry Qualification Mapping				
Academic Institution: PSUNV		PeopleSoft University		
Qualification Type: A		GCE A Level		
Mappings Customize Find View All First 1-2 of 2 Last				
	*Qualification Grade	Active		
1	16	<input checked="" type="checkbox"/>	+	-
2	17	<input checked="" type="checkbox"/>	+	-

An institution can only return specific Grades (QUALGRADE) for a Qualification Type to HESA. If an invalid Grade is returned, then validation errors will occur at HESA. Use the Entry Qualification Mapping page to define which Grade values are appropriate for a particular Qualification Type. The system then uses this mapping to ensure that only valid Grade values are entered for the selected Qualification Type on the Entry Profile page. The Import Applicant Data process also uses this mapping when importing ivStarJ records to report invalid grade values.

Setting Up a HESA Return

This section discusses how to:

- Set up a HESA return.
- Set up HESA fields.
- Set up HESA types.
- Set up HESA action reasons.
- Configure HESA.
- Generating student identifiers (SIDs or HUSIDs) during registration or enrollment.
- Define session year records.

Pages Used to Set Up a HESA Return

<i>Page Name</i>	<i>Definition Name</i>	<i>Navigation</i>	<i>Usage</i>
Reporting Periods	SSR_HE_REP_PERIODS	Records and Enrollment > HESA Reporting > HESA Returns Setup > Reporting Periods	View or create a reporting period. Reporting periods from 2000 onwards are delivered with your system.
Returns	SSR_HE_RETURNS	Records and Enrollment > HESA Reporting > HESA Returns Setup > Returns	View or create a return type. The STUDENT, OFFSHORE, DLHE, GRADOUT, Unistats/KIS, Data Futures, and ITT return types are delivered with your system.
Entities	SSR_HE_ENTITIES	Records and Enrollment > HESA Reporting > HESA Returns Setup > Entities	View or create an entity for a return type. The entities for Student, Offshore, DLHE, GRADOUT, Unistats/KIS, Data Futures, and ITT returns are delivered with your system. When you do a search, selecting the Active check box returns only active entities in the results.
Fields	SSR_HE_FIELDS	Records and Enrollment > HESA Reporting > HESA Returns Setup > Fields	View or create return fields. For Student, Offshore, DLHE, GRADOUT, Unistats/KIS, Data Futures, and ITT returns, the HESA fields are delivered with your system.
HESA Returns	SSR_HE_HESA_RETURN	Records and Enrollment > HESA Reporting > HESA Returns Setup > Returns Setup > HESA Returns	Create a return for a reporting period. To create a return, you can copy return setup data (such as the return fields) from another return you previously created.
HESA Fields	SSR_HE_HESA_FIELDS	Records and Enrollment > HESA Reporting > HESA Returns Setup > Returns Setup > HESA Fields	Add, edit, or view HESA fields in a return. If required, specify default and constant values for the HESA return fields.

Page Name	Definition Name	Navigation	Usage
HESA Types	SSR_HE_HESA_TYPES	Records and Enrollment > HESA Reporting > HESA Returns Setup > Returns Setup > HESA Types	For the Student return, map HESA fields to the Campus Solutions name, address and external ID types. The system uses this mapping to derive HESA return field values. Also, define the program statuses that the system uses to determine which Instances records to include in the return.
HESA Action Reasons	SSR_HE_HESA_ACTN	Records and Enrollment > HESA Reporting > HESA Returns Setup > Returns Setup > HESA Action Reasons	For the Student return, map HESA field codes to the Campus Solutions Program Action and Action Reason values. The system uses this mapping to derive HESA return field values.
HESA Configuration	SSR_HE_CONFIG	Records and Enrollment > HESA Reporting > HESA Returns Setup > Configuration > HESA Configuration	Configure the system for Create Extract and Create HUSID processing. Control validation for DLHE survey.
Create Student Identifiers	SSR_HE_CRTHUSID	Records and Enrollment > HESA Reporting > HESA Returns Setup > Create Student Identifiers	Create SID or HUSID for students during the registration or enrollment period.
Session Years	SSR_HE_SESS_YR	Records and Enrollment > HESA Reporting > HESA Returns Setup > Session Years	Define new session year records for an academic institution.

Setting Up a HESA Return

Access the HESA Returns page (**Records and Enrollment > HESA Reporting > HESA Returns Setup > Returns Setup > HESA Returns**).

When adding a new return, you have to enter an academic institution and a return name. You must enter a unique return name for an academic institution.

Note: To test the Create Extract Application Engine (SSR_HE_DATA) process, you can define multiple returns for the same institution, return type, and reporting period.

Note: For the Data Futures return, the field derivation logic uses the Rules Engine. Rules are delivered for each field, and to activate the rules for the return you must run the Build Rules process for HESA DF Field Derivation Rules and HESA Derivation Steps Rule Categories. Make sure you have the appropriate security access to both categories. To run the process, go to **Set Up SACR > System Administration > Rules Engine > Setup > Build Rules**.

When you access the HESA Returns page in add mode, the **Copy Return Setup Data From** group box appears.

To create a return using the **Copy Return Setup Data From** group box:

1. Select a previously defined return name from which you want to copy the setup data.
2. Select a reporting period for which you want to create the return.
3. Click Copy.

The other tabs in the page appear when you copy a return or click the **Skip Copy** button. If you want to manually create a return, if you are creating a return for the first time, or if no appropriate records are available to copy from, click the **Skip Copy** button.

The **Create Fields** button is available only when you click the **Skip Copy** button.

After selecting a return type, you can click the **Create Fields** button to have the system automatically create all the entities and the associated fields for the return. The system displays the created fields on the HESA Fields page.

Field or Control	Description
Return Type	<p>Select any one of the following: <i>STUDENT, OFFSHORE, DLHE, GRADOUT, ITT</i> or <i>KIS (Unistats)</i>.</p> <p>You can also select a return type that you have defined in the Returns page.</p> <hr/> <p>Note: The system displays the HESA Types tab only for the Student and ITT returns. The system displays the HESA Action Reasons tab only for the Student, ITT and DLHE returns.</p>
Reporting Period	Select the reporting period for which you want to create the return.
Country	Select a country code that the system uses to determine which fields to include in the return. Values for this field are delivered with your system as translate values. Values are <i>England, Northern Ireland, Scotland, and Wales</i> . This field is not applicable for the Aggregate Offshore return.
INSTAPP	Enter a value that you want the system to return in the Institution.INSTAPP field of the return. This field is not applicable for the Aggregate Offshore, DLHE, GRADOUT, Unistats/KIS and ITT, and Data Futures returns.

Field or Control	Description
Enable Sub-Plan Reporting	Select if you want to enter the reporting data in the Sub-Plan HESA and the Sub-Plan Offering/Year HESA pages. Selecting this check box enables the system to use the entered subplan level data to generate the HESA return. This is not enabled for Graduate Outcomes (GRADOUT) return.
Include FE (Include further education)	Select to have the system derive fields relevant to further education (FE) students. This check box is not applicable for the Aggregate Offshore, DLHE, and GRADOUT returns.
Active	Clear this check box if you want to prevent old test returns from being displayed in the search results.

For more information about the **HUSID**, **INSTAPP**, and **UKPRN** fields, refer to the HESA Student Record specification available from the HESA website. Specification for the HUSID digit structure can also be found on the HESA website.

Program Statuses

Select program statuses that the system can use for creating Instance entities.

See [Student Record Return: Instance Entity](#)

See [ITT Return: Student Entity](#)

Survey Details

The system enables the Survey Details region when you select the DLHE return type. Use this region to define the details of the two surveys (April and January) for each DLHE reporting period.

Field or Control	Description
Survey	<p>For DLHE, select the survey translate values: <i>1</i> for the April survey or <i>2</i> for the January survey.</p> <p>For Graduate Outcomes, select the survey translate values:</p> <ul style="list-style-type: none"> • <i>A</i> for December. • <i>B</i> for March. • <i>C</i> for June. • <i>D</i> for September. <hr/> <p>Note: Because the CENSUS value is returned at the Provider rather than the Graduate level, it is expected that separate returns are defined for each of the survey populations. This allows the extracted data to be retained and not overwritten when the extract is run for a subsequent survey. The setup also allows a single return to be defined for multiple surveys where an institution does not want to retain the extract data.</p> <hr/>
Qualifying Start Date	<ul style="list-style-type: none"> • For DLHE, select the start date to be used when identifying students who qualify for the survey. If the Survey value is April, the value defaults to the reporting period start date. If the Survey value is January, the value defaults to 01-JAN-YYYY where the year value is the year value of the reporting period end date. • For Graduate Outcomes, students who belong to cohort: <ul style="list-style-type: none"> • <i>A</i>, the value defaults to 01-AUG-YYYY, where the year value is the record year. • <i>B</i>, the value defaults to 01-NOV-YYYY, where the year value is the record year. • <i>C</i>, the value defaults to 01-FEB-YYYY, where the year value is the record year plus 1. • <i>D</i>, the value defaults to 01-MAY-YYYY, where the year value is the record year plus 1.

Field or Control	Description
Qualifying End Date	<ul style="list-style-type: none"> • For DLHE, select the end date to be used when identifying students who qualify for the survey. If the Survey value is April, the value defaults to 31-Dec-YYYY, where the YYYY value is the year of the reporting period start date. If the Survey value is January, the value defaults to the reporting period end date. • For Graduate Outcomes, students who belong to cohort: <ul style="list-style-type: none"> • A, the value defaults to 31-OCT-YYYY, where the year value is the record year. • B, the value defaults to 31-JAN-YYYY, where the year value is the record year plus 1. • C, the value defaults to 30-APR-YYYY, where the year value is the record year plus 1. • D, the value defaults to 31-JUL-YYYY, where the year value is the record year plus 1.
Census Date	<p>Select the census date for the survey. This system also displays the date to the student on the Survey questionnaire</p> <p>For Graduate Outcomes, this field is optional.</p>
Survey Start Date	<p>Select the date when the survey is available for completion by the student.</p> <p>For Graduate Outcomes, this field is optional. But if you define a start date, then you must also define an end date.</p>
Survey End Date	<p>Select the date when the survey is no longer available for completion by the student.</p> <p>For Graduate Outcomes, this field is optional.</p>

Survey Statuses

The system enables the Survey Statuses region when you select the DLHE and GRADOUT return type. Use this region to define which surveys, based on the survey status, should be included by the Create Extract process.

Note: Unless other survey status values are set in Survey Management that should be included in the extract, you should define only *New* for a GRADOUT return.

Field or Control	Description
Survey Status	Select the translate values of the statuses to be included in the HESA extract.

Account Types

The system enables the Account Types region when you select the Student return type. Use this region to specify the account types that your institution uses for tuition and waiver charges. The system uses the values that you enter in this region to derive Instance.GROSSFEE and Instance.NETFEE.

Research Options

This region appears only when the Return Type is STUDENT.

Field or Control	Description
Primary Advisor Only	By default, this check box is not selected. Use this check box to determine which student advisor records are used to create REF Data entities.
Primary Supervisor Only	By default, this check box is not selected. Use this check box to determine which supervisor records are used to create REF Data entities.
Advisor Roles	Select the advisor role.
Supervisor Roles	Optional. Use this field to define one or more roles to determine which supervisor records are used to create REF Data entities. If you do not define a role, supervisor records with any role value will be considered.
Supervisor Statuses	Use the Status field to define one ore more status values to determine which supervisor records are used to create REF Data entities.

See [Student Record Return: REF Data Entity](#).

Research Attributes

Use this grid to map research fields to Common Attributes. This grid is hidden for Data Futures returns.

Field or Control	Description
Field	Select a Research field (ORCID, RCSTDID, RCSTDNT) to map to a single Common Attribute.
Common Attribute	Select a Common Attribute for mapping. Common Attributes are limited to the attributes defined for the Research Consumption record (SSR_RS_CONSMPTN).

Common Attributes

Use this grid to map a field to a combination of record and Common Attributes for the Data Futures return. This grid is hidden for other HESA Return types.

Field or Control	Description
Field	<p>Select a field to map to a record and attribute.</p> <ul style="list-style-type: none"> ENGEXPECTEDENDDATE — a date attribute for end of assessment (as distinct from end of teaching or end of term) can be defined for Engagement. For ITT returns, this is the only field available. MODINSTENDDATE – a date attribute that overrides the end date of the class section. ORCID — an ID attribute for research consumption for Student.ORCID for the Student return. QUALAWARDDATE – a date attribute that records the graduation ceremony date. This is used in cases where the award is made in the reporting period but the Confer Date is in a later period. RCSTDID — an ID attribute for research consumption for Instance.RCSTDID for the Student return and Engagement.RCSTDID for the Data Futures return. RCSTDNT — a research council attribute for research consumption for Instance.RCSTDNT for the Student return. RCSTDNTE — a research council attribute for research consumption for Engagement.RCSTDNTE for the Data Futures return.
Record Name	Select the Record (table) that includes the Common Attribute field to which you wish to map.

Field or Control	Description
Common Attribute	Select a Common Attribute for mapping. Available Common Attributes are limited to the Record Name (table) selected.

Setting Up HESA Fields

Access the HESA Fields page (**Records and Enrollment > HESA Reporting > HESA Returns Setup > Returns Setup > HESA Fields**).

This example illustrates the fields and controls on the HESA Fields page. You can find definitions for the fields and controls later on this page.

The screenshot displays the HESA Fields configuration interface. At the top, there are navigation tabs: HESA Returns, HESA Fields (selected), HESA Types, and HESA Action Reasons. Below the tabs, the following information is displayed:

- Academic Institution:** PSUNV PeopleSoft University
- Return Name:** AT Return
- Return Type:** STUDENT

The main section is titled "Entities" and contains a table for the "MODULE" entity. The table has the following columns: Field, Description, Constant Value, and Default Value. The table lists the following fields:

Field	Description	Constant Value	Default Value
CRDTPTS	Credit value of module		999
CRDTSCM	Credit transfer scheme	9	
FTE	Module FTE		
LANGPCNT	Percentage of module taught in		
LEVLPTS	Level of credit points		
MODID	Module identifier		
MODLANG	Module available in a Celtic I		
MTITLE	Module title		
PCOLAB	Percentage not taught by this		
TINST	Other institution providing te		

Use a field constant when your institution wants to return the same value for an entity. For example, if you want the system to derive the Credit transfer scheme as No Scheme for all modules in the Student return 2008/09, set the Module.CRDTSCM constant value to 9.

Use the field default to reduce the amount of data entry by defining a default value to be used when no value is derived for a mandatory field. For example, if a default value of 999 is defined for the Module.CRDTPTS field, and no data is found for a module, then 999 is used.

Note that you must enter the value *NULL* if you want to define a null constant or default.

Note: The Constant Value field or the Default Value field can accept a maximum of 30 characters. Therefore, the system does not use these two fields in the derivation of the Unistats/KIS fields that exceed 30 characters (for example, the URL fields).

Note: For Unistats/KIS: The LEVELK field has K appended to distinguish it from the LEVEL field in the Aggregate Offshore return. The TITLEK field has K appended to distinguish it from the TITLE field in the ITT return. JACSA, JACSB and JACSC fields have A, B and C appended to allow three values to be returned and to distinguish the fields from the JACS field in the DLHE return.

Setting Up HESA Types

Access the HESA Types page (**Records and Enrollment > HESA Reporting > HESA Returns Setup > Returns Setup > HESA Types**).

This example illustrates the fields and controls on the HESA Types page. You can find definitions for the fields and controls later on this page.

HESA Returns		HESA Fields		HESA Types	
Academic Institution		PSGBR		PeopleSoft University UK	
Return Name		GRAD2021			
Address Types		Personalize Find [?] [x]		First	1 of 1
*Field	Description	*Address Type	Description		
COUNTRY	Country	HOME	Home	+	-
Email Types		Personalize Find [?] [x]		First	1-3 of 3
*Field	Description	*Email Type			
EMAIL	Email address	Business		+	-
EMAIL	Email address	Campus		+	-
EMAIL	Email address	Home		+	-
Phone Types		Personalize Find [?] [x]		First	1-5 of 5
*Field	Description	*Phone Type			
INTEL	International telephone	Home		+	-
INTEL	International telephone	Work		+	-
UKMOB	UK Mobile	Mobile		+	-
UKTEL	UK Telephone	Home		+	-
UKTEL	UK Telephone	Work		+	-

Name Types

The system uses the Name Types mapping to derive Student.SNAME16 for ITT, Data Futures, and Student returns.

This region does not appear for Graduate Outcomes return. Name details are derived from Primary name records as per Student return.

Address Types

The system uses the Address Types mapping to derive the following fields:

- EntryProfile.POSTCODE

- Student.TTPCODE
- EntryProfile.PERMADDCOUNTRY for the Data Futures return

For Graduate Outcomes, only the COUNTRY field is available. Users can define one or more address types that are considered when deriving the COUNTRY field and the Postal Address entity. If users do not define a type, all active address are considered during derivation.

Note: The Address Types region is not applicable for the ITT return.

External ID Types

The system uses the External ID Types mapping to derive the following fields for the Student return:

- Instance.DHREGREF
- Student.HUSID
- Instance.RCSTDID
- Student.SCN
- Instance.TREFNO
- Student.UCASPERID
- Student.ULN

The system uses the External ID Types mapping to derive the following fields for the ITT return:

- Student.HUSID
- Student ISANUM
- Student.NIN
- Student.SKILLTEST
- Student.TREFNO
- Student.ULN

The system uses the External ID Types mapping to derive the following fields for the Data Futures return:

- Engagement.RCSTDID
- Engagement.TRN
- Student.SCN
- Student.UCASPERID
- Student.ULN

For information about defining external systems and entering external system IDs for a person or an organization, see:

- “Defining External Systems” (Campus Community Fundamentals)
- “Entering External System IDs” (Campus Community Fundamentals)

Email Types

Use this region to define one or more email types for the Graduate Outcomes return EMAIL field and for the ITT return NQTEMAIL field.

If you do not define a type, all emails are considered during derivation.

The system uses Email Types to derive the following fields for Graduate Outcomes return:

- GRADUATE.EMAIL
- GRADUATE.EMAIL2
- GRADUATE.EMAIL3

Person ID Type

Use this region to define one or more ID types for the Data Futures return. The system uses the Person ID Type to derive PersonIdentifier.IDTYPECODE.

Phone Types

Use this region to define one or more phone types for the Graduate Outcomes return INTTEL, UKMOB, and UKTEL fields. If you do not define a type, all phone numbers are considered during derivation. The system uses Phone Types to derive the following fields for Graduate Outcomes return:

- GRADUATE.INTTEL
- GRADUATE.INTTEL2
- GRADUATE.INTTEL3
- GRADUATE.UKMOB
- GRADUATE.UKMOB2
- GRADUATE.UKMOB3
- GRADUATE.UKTEL
- GRADUATE.UKTEL2
- GRADUATE.UKTEL3

Setting Up HESA Action Reasons

Access the HESA Action Reasons page (**Records and Enrollment > HESA Reporting > HESA Returns Setup > Returns Setup > HESA Action Reasons**).

This example illustrates the fields and controls on the HESA (Higher Education Statistics Agency) Action Reasons page. You can find definitions for the fields and controls later on this page.

The screenshot shows the 'HESA Action Reasons' page for 'Academic Institution PSGBR' and 'Return Name DFE2122'. It contains five mapping sections, each with a table of mappings and search controls.

- Phd Submission Mapping:** Shows a mapping for 'Data Change' (Program Action) to 'PHDS' (Action Reason) with the description 'PHDS Submission'. It is currently active.
- Reason for Ending Mapping:** Shows two mappings: 'Completion of Program' to 'SUCC' (Successful Completion) and 'Discontinuation' to 'PERS' (Personal Reasons).
- Change of Mode Mapping:** Shows three mappings: 'Data Change' to 'DMFT' (Dormant to Full Time), 'Data Change' to 'DMPT' (Dormant to Part Time), and 'Data Change' to 'DMWU' (Dormant to Writing Up).
- Suspension of Active Studies Mapping:** This section is currently empty.
- Award Only Mapping:** This section is currently empty.

At the bottom of the page are navigation buttons: Save, Return to Search, Previous in List, Next in List, Notify, Add, and Update/Display.

Use this page to define the combinations of program action and action reason that the system uses to indicate PHD submission for research students, reason for ending studies, mode change, suspension of active studies, and award-only mapping.

For each region, if you edit the Program Action values the corresponding Action Reason fields are cleared to prevent an invalid combination from being saved.

Note: The Phd Submission Mapping and Suspension of Active Studies Mapping regions are not applicable for the ITT return.

Phd Submission Mapping

The system uses this mapping to derive the Instance.PHDSUB and StudentCourseSession.PHDSUB fields.

Reason for Ending Mapping

Map the program action and action reason values to the (HESA) **Session Reason**, **Leaver Reason**, and **Instance Reason** codes.

The system uses this mapping to derive Data Futures return Leaver.RSNREGEND field and StudentCourseSession.RSNSENSEND.

Change of Mode Mapping

Map the program action and action reason values to the HESA Session Status and HESA Session Mode codes.

The system uses this mapping to derive StudentCourseSession.SCSMODE and SessionStatus entities, and to determine the mode of study during the calculation of FTE.

Suspension of Active Studies Mapping

Note: If the return type is DFSTDNT, this region is hidden.

Map the program action and action reason values to the HESA Suspension of Studies codes. Click the Suspension of Studies tab to enter the HESA Suspension of Studies codes.

The system uses this mapping to derive the Instance.NOTACT field.

Award Only Mapping

The mapping in this grid is used in cases where the student's program or plan is changed in order to make an intermediate award. When this happens, you must define the combinations of program action and reason that are used to make the change and complete the program. For example, Program Change/AWDP followed by Completion of Program/SUCC and those rows in Student Program/Plan are not considered when determining the COURSEID for the instance. This ensures continuity with what has been previously reported to HESA for that instance. The new program or plan is considered for the derivation of Qualifications Awarded. If you do not set a mapping as active, the program action and reason mapping continues to be considered.

This grid appears only for Student and ITT returns.

<i>Field or Control</i>	<i>Description</i>
Action Reason	(Optional) If you do not define a value, all action reasons (including blanks) are considered for the Program Action.
Active	By default, this check box is selected. You can deselect this check box to indicate that the mapping row is considered.

Configuring HESA

Access the HESA Configuration page (**Records and Enrollment > HESA Reporting > HESA Returns Setup > Configuration > HESA Configuration**).

Institution Details

<i>Field or Control</i>	<i>Description</i>
UKPRN	Enter a value that you want the system to return in the Institution.UKPRN field of the return.
Show Further Education page	<p>Select to enable the Further Education page on the HESA Instance Details component (SSR_HE_INSTANCE).</p> <p>If this check box is deselected, you cannot access the Further Education page.</p> <hr/> <p>Note: The fields on the Further Education page are relevant only to institutions in England and Wales.</p>
Show Financial Support region	Select to enable the Financial Support region in HESA Instance Details component. Institutions in England can select this check box and institutions in Scotland, Northern Ireland and Wales can deselect this check box.
Show ITT Placement region	Select to enable the ITT Placement records in the HESA Instance Details component.

Student Identifier Generation

Use this region to configure HUSID before running the Create HUSID process or the Create Extract process.

Note: For students without HUSIDs, the system creates HUSIDs when you run the Create Extract process for the Student return. However, if you want to create these IDs at the point of registration or enrollment for new students and before running the Create Extract process, run the Create HUSID process.

For information about defining external systems and entering external system IDs for a person or an organization, see:

- “Defining External Systems” (Campus Community Fundamentals)
- “Entering External System IDs” (Campus Community Fundamentals)

<i>Field or Control</i>	<i>Description</i>
HESA Institution Identifier	(Optional) Set the institution identifier. This value is used to generate part of the HUSID.

Field or Control	Description
Sequence Number	Enter the starting number for the system-assigned six-digit number included in the 13-digit HUSID number. For each student without an existing HUSID, the Create HUSID process or the Create Extract process assigns a unique 13-digit HUSID value in the return.
HUSID External System	(Optional) Select the ID type that the Create HUSID or Create Extract process uses for HUSID value.
SID External System	(Optional) Select the ID you want to use to generate SID records for the Data Futures return.

Grading Basis Inclusion and Repeat Code Exclusion

These regions enable you to specify which Grading Basis values to include and which Repeat Codes to exclude in the Create Extract, Calculate Full-Time Equivalence, and Calculate Year of Student processes.

In the Grading Basis Inclusion region, when you select a Grading Basis and select a check box for the Extract, FTE, or the Year of Student process, the selected Grading Basis is considered by the selected process. In the Repeat Code Exclusion region, when you select a Repeat Code and select a check box for the Extract, FTE or Year of Student process, the selected process excludes class enrollments for the selected Repeat Code.

See [Setting Up Your System for Grading](#)

See [Understanding Repeat Checking Functionality](#)

Drop Reason Exclusion

Use this region to define one or more reasons for dropping an enrollment. The Create Extract process for the Data Futures return, Calculate Full-Time Equivalence (FTE), and Calculate Year of Student processes utilizes the reasons you select to determine which records are excluded.

Entity Status Inclusion

Use this region to define one or more entity statuses. The statuses you define determines which records are included in the Create XML or Extract Synch processes. By default, the Create XML and Extract Synch checkboxes are selected. Typically, New, Amended, and Identify would be defined for both processes.

Field Status Inclusion

Use this region to define one or more field statuses. The statuses you define determines which records are included in the Create XML and Extract Synch processes. By default, the Create XML and Extract Synch checkboxes are selected. Typically, New and Amended would be defined for both processes.

Related Links

[Creating an XML Return File](#)

Generating Student Identifiers During Registration or Enrollment

Access the Create Student Identifiers page (**Records and Enrollment > HESA Reporting > HESA Returns Setup > Create HUSID**).

Use this page if you want to create Student identifiers (SIDs) or HUSIDs when registering or enrolling new students and before running the Create Extract process.

To create a HUSID, the process selects a student's earliest MATR Student Program record . If the MATR record is not available, then it selects the student's earliest ACTV record. If a record is found, the process uses the record's effective date for the entry year element. Then, the Create HUSID process uses the following logic to generate the HUSID value for a student who does not have a HUSID:

- The first two digits of HUSID represent the year the student entered the Institution (for example, 08 for 2008). The entry year is determined as the final two digits of the year element of the effective date of the selected Student Program record.
- The next four digits represent the institution identifier.
 - The process calculates the institution identifier as Institution Code plus 1000 (for example, 0184 is calculated as 1184)
 - Note that the process picks the Institution Code value from the HESA Configuration page.
- The next six digits represent the system assigned sequence number.
 - Note that the starting number is defined in the HESA Configuration page. The process assigns this number for the first student for whom calculation is done.
 - The system automatically increases the starting number by one when it assigns a new sequence number.
- The final digit is a check digit based on the existing ten digits. See the HESA website for details on check digit calculation.

<i>Field or Control</i>	<i>Description</i>
ID Type	Select: <ul style="list-style-type: none"> • HUSID external system, if you are creating a HUSID. • SID external system, if you are creating a student identifier (SID) for Data Futures return. If you select an SID external system, the Create from HUSID and Create New check boxes appear.

Field or Control	Description
Create from HUSID	<p>Select this check box to create SID records for students who don't have SIDs by using their existing HUSID records. Students must also have an active Student Program record for the institution.</p> <p>By default, this check box is deselected.</p>
Create New	<p>Select this check box to create new SID records. By default, this check box is selected.</p> <p>To create an SID, the system uses a similar logic when creating a HUSID. However, the system formats the SID according to the UKPRN and SID external system values from the HESA configuration instead of the institution identifier and HUSID external system. For SIDs, the:</p> <ul style="list-style-type: none"> • first two digits are the last two digits of the year of entry into the institution • next eight digits are the institution's UKPRN • next six digits represent the six-digit reference number internally allocated by the institution • last digit is a check digit, which provides a way to detect errors in transcription. This is calculated using the first 16 digits of the SID. <hr/> <p>Note: If you select this check box <i>and</i> the Create from HUSID check box, the system first creates SIDs from existing HUSIDs before creating new SIDs.</p> <hr/>
Start Date	<p>Specify a date if you want the process to only examine Student Program records that are active or matriculated on or after the specified date. For example, if you enter January 5, 2009, the process creates HUSIDS or SIDs for students who have records that have a program action of MATR or ACTV with an effective date of January 5, 2009 or later.</p>

Define Session Year

Access the Session Years page (**Records and Enrollment > HESA Reporting > HESA Returns Setup > Session Years**).

Use this page to define session year records for an academic institution. Academic Career, Term, and Session are optional. If required, these fields allow you to define non-standard years that aren't aligned with a term.

Field or Control	Description
Own Identifier	Optional. You can enter a maximum of 50 uppercase alphanumeric characters.
Academic Career	Optional. Select an active academic career for the selected academic institution.
Term	Optional. This is enabled only when you select an academic career.
Session	Optional. This is enabled only when you select a term.
Start Date	If you select a term, this value defaults to the Term Begin Date, but you can update it if necessary.
End Date	When you select a start date, this value defaults to Start Date plus 1 year, minus 1 day. For example, if your start date is 25 September 2021, the end date defaults to 24 September 2022. You can update this if necessary.
Active	By default, this is selected for new records. You can deselect this for obsolete records that don't need to be included in the Data Futures extract.

Setting Up and Entering Data for HESA Reporting

This section provides an overview of setting up and entering data for HESA reporting and discusses how to:

- Set up data capture rules.
- Enter HESA Data for an institution.
- Enter qualifications for Data Futures.
- Enter HESA data for an academic program.
- Enter HESA data for a program offering and program year.
- Enter HESA data for an academic plan.
- Enter HESA data for a plan offering and plan year.
- Enter HESA data for a subplan.
- Enter HESA data for a subplan offering and subplan year.
- Create HESA modules.

- Create qualification records.
- Enter HESA data for a module.
- Enter HESA data for a dummy module.
- Create HESA Instance and Person HESA Data Records for students.
- Restrict access to person HESA data fields.
- Enter HESA data for a person.
- Enter restricted HESA data for a person.
- Enter HESA Instance data for a student.
- Entering mobility data for a student.
- Enter HESA Entry Profile data for a student.
- Calculate Year of Student values for students.
- Calculate Full-Time Equivalence for students.
- Enter HESA advisor data for a student.
- Enter HESA Data for an external organization.
- Enter DEGTYPE value.

Understanding Setting Up and Entering Data for HESA Reporting

To derive a field, the system checks each data capture level to find out whether a field value has been defined. Each level is associated with a Campus Solution page or a group box. For example, to derive the Instance.EXCHANGE field, after checking if a constant value exists for a field, the system first looks at the Instance level to see if the field value has been defined on the HESA Instance page. If it doesn't find a value at the Instance level, then it checks whether a value has been defined on the following pages and group boxes:

1. **Sub-Plan Year HESA Data** group box in the Sub-Plan Offering/Year HESA page (Subplan Year level).

You can define field values at this level when different values are required for different years of program and the subplan is being reported to HESA. For example, if students in year three of a full-time offering undertake an exchange year away from the home institution, then the appropriate Instance.EXCHANGE value can be defined for that offering year at the Subplan Year level.

2. Sub-Plan HESA Data page (Subplan level)

The system looks at this level only if the Course entity is based on a subplan.

3. **Plan Year HESA Data** group box in the Plan Offering/Year HESA page (Plan Year level)
4. Plan HESA Data page (Plan level)

5. **Program Year HESA Data** group box in the Program Offering/Year HESA page (Program Year level)
6. Program HESA Data page (Program level)

Although the system derives Course records from either plans or subplans, you can define values at the program level if required. Typically, you would define a field value at the program level when you want the system to derive the same HESA field value for all the child plans, subplans, or both child plans and subplans of a program. For example, if a program exists specifically for incoming exchange students, define the appropriate Instance.EXCHANGE value only at the program level. The system includes this program level field value in the return for all the Instances associated with the plans or subplans of the program.

The system looks at the Subplan Year and Subplan levels only if the course entity is based on a subplan. For Subplan Year and Plan Year levels, the system uses the field values defined for the combination of Academic Load and Year of Program of the student instance.

The pages and group boxes for other levels include:

- **Program Offering HESA Data** group box in the Program Offering/Year HESA page (Program Offering level)
- **Plan Offering HESA Data** group box in the Plan Offering/Year HESA page (Plan Offering level)

You can define field values at the Plan Offering level when you want to report different field values for different offerings. For example, the expected length of study (Instance.SPLENGTH) for students studying a full-time offering will typically be different from that of a part-time offering. In this case, you can define different values at plan offering level for each offering.

- **Sub-Plan Offering HESA Data** group box in the Sub-Plan Offering/Year HESA page (Subplan offering level)
- Module HESA Data and HESA Dummy Module Data pages (Module level). Module level is equivalent to the Course Offering level. The system uses the field values entered at the Module level to create the Module, Module Subject, and Student On Module entities.
- HESA Student Data page (Student level).

The system uses the field values entered at the Student level to create the Student entity.

- Advisor HESA Data page (Advisor level)

Use this page to define research units of assessment for an instructor or an advisor. The system uses the values entered at this level to create the RAE Data entity.

- Institution HESA Data page (Institution level)

Use this page to capture data for Unistats/KIS fields and Unistats/KIS location data for the academic institution.

After you import the HESA codes and define the data capture rules in the Institution Data Capture page, you can:

- Enter return field values at the institution and academic program, plan, and subplan levels.

- Enter return field values at the program, plan and subplan offering levels. An *offering* is a program, plan, or subplan associated with an academic load.
- Enter return field values at the program, plan, and subplan program year levels. A *program year* is a program associated with an academic load and year of program.
- Enter return field values for modules and module subjects for course offerings.
- Review and edit return field values for student personal attributes such as nationality and ethnicity. Some of the data that the system uses for HESA reporting, such as addresses, will already be in your database.
- Use the Create HESA Instance Application Engine (SSR_HE_CRTHE) process to specify the student data you want to report.
- Review and enter Instance-specific return field values, such as entry qualifications, year of program, and qualifications awarded.

You can decide at which levels the system should capture data for HESA reporting. For example, you can decide not to enter a Course.CLSDCRS value in the Program HESA Data page but enter it in the Plan HESA Data page. You can decide to enter the Instance.FEEELIG value in the HESA Instance page for each student rather than storing the Instance.FEEELIG data in the Program HESA Data page.

The system can create Course entities from either plans or subplans, depending on your academic structure setup. For example, you can either select the Biology plan for reporting to HESA or select its subplans, such as Molecular Biology and Marine Biology, for reporting to HESA, but you cannot select both.

The pages you use for entering HESA data at various levels are available only if you select the **HESA**, **UCAS** check boxes on the SA Features and the Academic Institution 6 pages.

Note: For information about the delivered functionality for deriving the HESA return fields, see [Understanding HESA Derivation Steps](#).

You can use the Institution Data Capture page to determine at which level the system should derive the fields.

Other than the various data capture levels, the system may use a constant or a default value set up on the HESA Fields page based on the derivation logic.

Deriving FTE Calculation Type and FTE Load

On each data capture page (which corresponds to a data capture level), optional Full-Time Equivalence (FTE) Calculation Type and FTE Load fields are available. The Calculate Full-Time Equivalence process uses the field values to determine which FTE calculation type to use for each student. If you select *Derive load from Program* as the calculation type, the process uses the FTE Load value for calculation.

Pages Used to Set Up and Enter Data for HESA Reporting

<i>Page Name</i>	<i>Definition Name</i>	<i>Navigation</i>	<i>Usage</i>
Institution Data Capture	SSR_HE_INST_DATA	Records and Enrollment > HESA Reporting > HESA Returns Setup > Data Capture Setup	<p>Create and maintain the rules to capture HESA data in the system.</p> <p>Use this page to control which fields are available on the various HESA data capture pages.</p> <p>Use this page to make any new fields (that are delivered with a Campus Solutions update) available on the HESA data capture pages.</p>
Institution HESA Data	SSR_HE_INST_HEDATA	Records and Enrollment > HESA Reporting > HESA Returns Setup > Institution Data	Enter or modify values that the system can use for creating Unistats/KIS return's Institution and Location entity data at the institution level.
Qualification Setup	SSR_HE_QUAL_SETUP	Records and Enrollment > HESA Reporting > Codes and Mappings > Qualification Setup	Enter or modify qualifications for inclusion in the Data Futures return.
Program HESA Data	SSR_HE_PROG	Set Up SACR > Foundation Tables > Academic Structure > Academic Program Table > Program HESA Data	<p>Enter or modify values that the system can use for creating Student return's Course, Course Subject, and Instance entity data at the program level.</p> <p>Indicate the HESA subjects that the system can use for creating ITT return's Course Subject entity data (SBJCA field) at the program level.</p> <p>Enter values for Unistats/KIS entities (KISCourse, CourseStage and Accreditation entities).</p>
Program Offering/Year HESA	SSR_HE_PROG_OFFRYR	Set Up SACR > Foundation Tables > Academic Structure > Academic Program Table > Program Offering/Year HESA	Enter or modify values that the system can use for creating Student return's Instance entity data at the program offering and program year levels.

Page Name	Definition Name	Navigation	Usage
Plan HESA Data	SSR_HE_PLAN	Set Up SACR > Foundation Tables > Academic Structure > Academic Plan Table > Plan HESA Data	<p>Enter or modify values that the system can use for creating the following at the plan level:</p> <p>Student return's Course, Course Subject, and Instance entity data.</p> <p>Aggregate Offshore return's Provision entity data.</p> <p>ITT return's Course Subject entity data (SBJCA field).</p> <p>Unistats/KIS return's KISCourse, CourseStage, Accreditation, HESACourse and ILRAims entities.</p>
Plan Offering/Year HESA	SSR_HE_PLAN_OFFRYR	Set Up SACR > Foundation Tables > Academic Structure > Academic Plan Table > Plan Offering/Year HESA	<p>Enter or modify values that the system can use for creating Student return's Instance entity data at the plan offering and plan year levels.</p>
Sub-Plan HESA	SSR_HE_SUBPLAN	Set Up SACR > Foundation Tables > Academic Structure > Academic SubPlan Table > Sub-Plan HESA	<p>Enter or modify values that the system can use for creating the following at the subplan level:</p> <p>Student return's Course, Course Subject, and Instance entity data.</p> <p>Aggregate Offshore return's Provision entity data.</p> <p>ITT return's Course Subject entity data (SBJCA field).</p> <p>Unistats/KIS return's KISCourse, CourseStage, Accreditation, HESACourse and ILRAims entities.</p>
Sub-Plan Offering/Year HESA	SSR_HE_SPLN_OFFRYR	Set Up SACR > Foundation Tables > Academic Structure > Academic SubPlan Table > Sub-Plan Offering/Year HESA	<p>Enter or modify values that the system can use for creating Student return's Instance entity data at the subplan offering and subplan year levels.</p>

Page Name	Definition Name	Navigation	Usage
Create HESA Module Data	SSR_HE_CREATECRSE	Records and Enrollment > HESA Reporting > HESA Returns Setup > Create Module	Create HESA module data records for an academic institution.
Create Qualifications	SSR_HE_QUAL_RC	Records and Enrollment > HESA Reporting > HESA Returns Setup > Create Qualifications	Generate qualification records based on existing Plan and Sub-Plan HESA records.
HESA Module Data	SSR_HE_CRSE	Curriculum Management > Course Catalog > HESA Module Details	Update a HESA module data record that the Create HESA Module Data created or manually create a HESA Module Data record. Enter or modify values that the system can use for creating Student return's Module, ModuleSubject, and Student on Module entity data at the module level.
HESA Dummy Module Data	SSR_HE_CRSE_DUMMY	Curriculum Management > Course Catalog > HESA Dummy Module Details	Manually create a HESA dummy module data record. Enter HESA field and Module Subject values for the dummy Module record.
Create HESA Instance	SSR_HE_CREATEHESA	Records and Enrollment > HESA Reporting > HESA Returns Setup > Create Instance	Run the process to create HESA instance and Person HESA Data records for new matriculated students. You can specify whether you want to create records for matriculated students of a particular academic institution, program, plan, or subplan. In addition, you can specify a date to have the process generate records of students who matriculated on or after the specified date.
Fields	SSR_HE_FIELDS	Records and Enrollment > HESA Reporting > HESA Returns Setup > Fields	Restrict access to Person HESA Data fields on the HESA Student Data page. The system uses the values for the Person HESA Data fields to create Student entity.

Page Name	Definition Name	Navigation	Usage
HESA Student Data	SCC_HE_PERSON	Campus Community > Personal Information > Add/Update a Person > HESA Student Data	Update a Person HESA Data record that the Create HESA Instance created or manually create a Person HESA Data record. View, enter or modify values for a person that the system can use for creating Student entity data at the student level (for the Student and ITT returns).
HESA Restricted Data	SCC_HE_PERSON_RES	Campus Community > Personal Information > Add/Update a Person > HESA Restricted Data	View, enter or modify Person HESA Data record values for fields that are restricted through the Fields page. The system can use these values for creating Student entity data at the student level (for the Student and ITT returns).
HESA Instance	SSR_HE_INSTANCE	<p>Records and Enrollment > Career and Program Information > HESA Instance Details > HESA Instance</p> <p>Alternatively, access Records and Enrollment > Career and Program Information > Student Program/Plan > Student Program and click the HESA Instance link.</p>	<p>Update a HESA instance record that the Create HESA Instance created or manually create a HESA instance record.</p> <p>Enter or modify values that the system can use for creating Instance, Qualifications Awarded, and RAE entity data at the instance level (for the Student return).</p> <p>Enter or modify values that the system can use for creating Student entity data (for the ITT return)</p> <p>View or edit the Year of Student value that the Calculate Year of Student process has calculated.</p> <p>View or override the FTE value that the Calculate Full-Time Equivalence process has calculated.</p>
Mobility	SSR_HE_INST_MOB	Records and Enrollment > Career and Program Information > HESA Instance Details > Mobility	Enter or modify values that the system can use to create Mobility entity data.

Page Name	Definition Name	Navigation	Usage
Entry Profile	SSR_HE_ENTRPROFL	Records and Enrollment > Career and Program Information > HESA Instance Details > Entry Profile	Enter or modify values that the system can use for creating Student return's Entry Profile and Qualifications entity data.
Further Education	SSR_HE_FUR_EDU	Records and Enrollment > Career and Program Information > HESA Instance Details > Further Education	Enter or modify values that the system can use for creating FE-specific entities and fields.
Calculate Year of Student	SSR_HE_CALC_YRSTU	Records and Enrollment > HESA Reporting > Extract Processing > Calculate Year of Student	Calculate the Year of Student values of all the active HESA instance records for a particular reporting period. The system uses the calculated value to derive the Instance.YEARSTU field.
Calculate Full-Time Equivalence	SSR_HE_CALC_FTE	Records and Enrollment > HESA Reporting > Extract Processing > Calculate FTE	Calculate the FTE value that represents the student's academic load for the reporting period. The system uses the calculated value to derive the Instance.STULOAD field.
Advisor HESA Data	SSR_HE_INST_ADV	Curriculum Management > Instructor/Advisor Information > Instructor/Advisor Table > Advisor HESA Data	For an advisor, enter or modify values that the system can use for creating the Student return's RAE Data entity.
Regional	EXT_ORG_TBL_REG	Campus Community > Organization > Create/Maintain Organizations > Organization Table > Regional	Enter or modify the value that the system can use to derive the Student.DEGEST value (ITT return).
Degree Table	SA_DEGREE_TABLE	Set Up SACR > Foundation Tables > Academic Structure > Degree Table	Enter or modify the value that the system can use to derive the Student.DEGTYPE value (ITT return).

Setting Up Data Capture Rules

Access the Institution Data Capture page (**Records and Enrollment > HESA Reporting > HESA Returns Setup > Data Capture Setup**).

This example illustrates the fields and controls on the Institution Data Capture page. You can find definitions for the fields and controls later on this page.

Institution Data Capture

Academic Institution: PSGBR PeopleSoft University UK Create Fields

Find | View 100
First ◀ 166 of 369 ▶ Last

Field: + -

Description:

Long Description:

Fixed

Available at:	Include at:
<input checked="" type="checkbox"/>	<input checked="" type="checkbox"/> Institution
<input type="checkbox"/>	<input type="checkbox"/> Student
<input type="checkbox"/>	<input type="checkbox"/> Instance
<input type="checkbox"/>	<input type="checkbox"/> Advisor
<input type="checkbox"/>	<input type="checkbox"/> Program
<input type="checkbox"/>	<input type="checkbox"/> Program Offering
<input type="checkbox"/>	<input type="checkbox"/> Program Offering Year
<input type="checkbox"/>	<input type="checkbox"/> Plan
<input type="checkbox"/>	<input type="checkbox"/> Plan Offering
<input type="checkbox"/>	<input type="checkbox"/> Plan Offering Year
<input type="checkbox"/>	<input type="checkbox"/> Subplan
<input type="checkbox"/>	<input type="checkbox"/> Sub-Plan Offering
<input type="checkbox"/>	<input type="checkbox"/> Sub-Plan Offering Year
<input type="checkbox"/>	<input type="checkbox"/> Module

<i>Field or Control</i>	<i>Description</i>
Create Fields	<p>Click to create a data capture record from the delivered data. When you click this button, the system creates all the fields and, for each field, selects the check boxes to indicate at which level the system captures data to derive the field.</p> <p>After you have created a data capture record, use the Create Fields button to add new fields that you have created using the Fields page. For example, you have clicked the Create Fields button to create a data capture record. After creating the data capture record, you create a new field using the Fields page. To add this new field to the data capture record, click the Create Fields button.</p> <hr/> <p>Note: You must click the Create Fields button to add any new fields that have been added as part of a Campus Solutions update to make them available in data capture.</p>

Copyright © 1988, 2024, Oracle and/or its affiliates.

2043

Field or Control	Description
Fixed	<p>Indicates whether you can configure the data capture levels or if the levels are non-configurable (fixed).</p> <p>You cannot select or clear the Fixed check box. If the system has not selected the Fixed check box, you can clear or select the Include At check boxes.</p>
Available At	<p>Indicates the level at which the system can derive the field value. You cannot select or clear the Available At check boxes.</p>
Include At	<p>Select or clear to indicate the level at which you want the system to capture the field value.</p> <p>As an initial default, the Include At check box appears selected for each level where the field value can be captured. You can clear the Include At check box to ensure that the field value cannot be entered at the corresponding page of that level.</p> <p>You can select or clear an Include At check box only if the corresponding Available At check box is selected by the system. However, if the system has selected the Fixed check box, you cannot select or clear the Include At check boxes for the field.</p>

Entering HESA Data for an Institution

Access the Institution HESA Data page (**Records and Enrollment > HESA Reporting > HESA Returns Setup > Institution Data**).

This example illustrates the fields and controls on the Institution HESA Data page 1 of 2. You can find definitions for the fields and controls later on this page.

Institution HESA Data
 Academic Institution PSGBR PeopleSoft University New

Institution Data Find | View All First 1 of 1 Last

*Effective Date 01/01/1900
 Student Union URL www.psgbr.ac.uk/suurl
 233 characters remaining

Unistats Fields Find First 1-2 of 2 Last

*Field	Description	Code	Description
NSP		1	Participating in NSP
OTHERINST	Franchise UKPRN	12347000	

Locations Find | View All First 1 of 3 Last

*Location ID 1
 *Location Name Main Campus
 Accommodation Cost URL www.psgbr.ac.uk/main/accomcost
 224 characters remaining
 Student Union URL
 254 characters remaining

Location Fields Find First 1-8 of 8 Last

*Field	Description	*Code	Description
INSTBEDS		2000	
INSTLOWER		650	
INSTUPPER		950	
LATITUDE	Location latitude	54	
LOCUKPRN	Location UKPRN	12345000	
LONGITUDE	Location longitude	12	
PRIVATELOWER		700	
PRIVATEUPPER		1200	

This example illustrates the fields and controls on the Institution HESA Data page 2 of 2. You can find definitions for the fields and controls later on this page.

Venues Find | View All First 1 of 2 Last

*Venue ID V0001
 Own Venue ID
 *Venue Name Main Campus
 239 characters remaining
 *Postcode N1 2RG
 UKPRN 5043

The following table describes the type of data that you can enter in each group box of this page:

Group Box	Used for Entering
Unistats Fields	Institution entity fields and their associated values for the Unistats return.

Group Box	Used for Entering
Locations	KIS location records for the institution for the Unistats return. A maximum of 50 records can be entered.
Location Data	Location entity fields and their associated values for each KIS location record for the Unistats return.
Venues	Venue entity fields and their associated values for the Data Futures return.

The Field prompt values in these group boxes are restricted to fields that are defined in the Institution Data Capture page as *Include at* Institution level.

Entering HESA Data for Qualifications

Access the Qualification Setup page (**Records and Enrollment > HESA Reporting > Codes and Mappings > Qualification Setup**).

This example illustrates the fields and controls on the Qualification Setup page. You can find definitions for the fields and controls later on this page.

Qualification Setup

Institution PSGBR PeopleSoft University UK

Degree BS Bachelor of Science

Primary Plan IFS Financial Services

Secondary Plan

Sub-Plan RISK Risk & Insurance Management

Details Find | View All First 1 of 1 Last

Effective Date Status

*Title

*Category First degree with honours

*Qualification ID

HECoS Subjects Personalize | Find | View All | First 1-2 of 2 Last

*Subject	Description	*Percentage	ITT	Subject	
<input type="text" value="100107"/> <input type="button" value="Q"/>	finance	<input type="text" value="50"/>	<input type="checkbox"/>	<input type="text"/>	<input type="button" value="+"/> <input type="button" value="-"/>
<input type="text" value="100835"/> <input type="button" value="Q"/>	financial risk	<input type="text" value="50"/>	<input type="checkbox"/>	<input type="text"/>	<input type="button" value="+"/> <input type="button" value="-"/>

Awarding Body

Award Accreditation

Use this page to define qualifications to include in the Data Futures return. The Qualification ID values are available for selection in the Program, Plan and Sub-Plan HESA pages.

HECoS Subjects

<i>Field or Control</i>	<i>Description</i>
Subject	Select a value that the system will use to derive the QualificationSubject.QUALSUBJECT field.
Percentage	Enter a value that the system will use to derive the QualificationSubject.QUALPROPORTION field.

Awarding Body

<i>Field or Control</i>	<i>Description</i>
Awarding Body	Select a value that the system will use to derive the AwardingBodyRole.AWARDINGBODYID field.

Award Accreditation

<i>Field or Control</i>	<i>Description</i>
Accreditation ID	Select a value that the system will use to derive the QualificationAwardAccreditation.ACCREDITATIONIDQAA field.

Entering HESA Data for an Academic Program

Access the Program HESA Data page (**Set Up SACR > Foundation Tables > Academic Structure > Academic Program Table > Program HESA Data**).

This example illustrates the fields and controls on the Program HESA Data page (1 of 2). You can find definitions for the fields and controls later on this page.

The screenshot shows the 'Program HESA Data' page for PSGBR, PeopleSoft University UK, Academic Program BA, Bachelor of Arts. The page is divided into several sections:

- Details:** Effective Date: 01/01/1900, Status: Active, FTE Calculation Type: Derive load from Modules, Qualification ID: [Searchable field].
- Program HESA Data:** A table with columns for *Field, Description, *Code, and Description.

*Field	Description	*Code	Description
COURSEAIM	Course Qualification Aim	H00	First degree with honours
REDUCEDC	Reduced course return indicato	00	Not a reduced return
- Program HESA Subjects:** A table with columns for *Subject, Description, JACS2, Description, *Percentage, and ITT Subject.
- Program HECoS Subjects:** A table with columns for *Subject, Description, CAH3, Description, *Percentage, and ITT Subject.
- Program HESA Instance Data:** A table with columns for *Field, Description, *Code, and Description.

*Field	Description	*Code	Description
EXCHANGE	Exchange programmes	0	Not an exchange student

This example illustrates the fields and controls on the Program HESA Data page (2 of 2). You can find definitions for the fields and controls later on this page.

The screenshot shows the continuation of the 'Program HESA Data' page:

- Accreditation:** Accreditation Type: [Searchable], Accreditation ID: 00102, Valid From: 01/01/2011, Valid To: [Searchable]. Note: Prescribed by the Architects Registration Board (ARB) at Part 1 level for the purpose of registration in the UK.
- Initiatives:** A table with columns for Initiative, Description, *Valid From, and Valid To.

Initiative	Description	*Valid From	Valid To
1 020	HEFCW funded degree apprentice	07/05/2001	12/31/2019
2 020	HEFCW funded degree apprentice	01/01/2021	
- Roles:** A table with columns for *Type, Description, *Identifier, Postcode, and *Percentage.

*Type	Description	*Identifier	Postcode	*Percentage
1 202	Delivery organisation	12345678	SE6 7HJ	67
2 401	Funder	22334455		100
3 202	Delivery organisation	23456789		33
- KIS Course Data:** Includes expandable sections for KIS Course Links, Stage Modules, and Course Stages.

Field or Control	Description
Qualification ID	Use this field to indicate the ID that links Course Delivery and Qualification.

The following table describes the type of data that you can enter in each group box:

Group Box	Used for Entering
Program HESA Data	Student and Data Futures returns' Course entity fields and their associated values. Unistats/KIS return's KISCourse entity fields and their associated values.
Program HESA Subjects	Student and Data Futures returns' CourseSubject entity field values. KISCourse entity's JACSA, JACSB and JACSC fields and their associated values.
Program HECoS Subjects	Student and Data Futures returns' CourseSubject entity field values.
Program HESA Instance Data	Instance entity fields and their associated values.
Accreditation	Unistats/KIS Accreditation entity fields and their associated values. Data Futures return's CurriculumAccreditation entity field values
Initiatives	Data Futures return's CourseInitiatives entity field values.
Roles	Data Futures return's CourseRole entity field values.
KIS Course Data	KISCourse entity fields and their associated values.
KIS Course Links	Values for URL fields of KISCourse entity, such as the CRSEURL field.
Stage Modules and Course Stages	Unistats/KIS CourseStage entity fields and their associated values.

Program HESA Subjects

You can define a maximum of three subjects. The total percentage for the three subjects must equal 100.

Field or Control	Description
Subject	Enter a value that the system will use to derive the CourseSubject.SBJCA field.

Field or Control	Description
JACS2	Enter a value only if the JACS3 value entered in the Subject field is not valid in JACS2 (that is, the value entered in the Subject field is a JACS3 code that does not appear in JACS2 prompt).
Percentage	Enter a value that the system will use to derive the CourseSubject.SBJPCNT field.
ITT Subject (Initial Teacher Training subject)	Select to indicate that the subject is an ITT subject. The system uses this check box setting to derive the CourseSubject.ITTSUBJECT field. The system enables the check box only if the HESA Subject is valid for the ITT return. The valid SBJCA values for ITT return are available on the HESA web site.

Program HECos Subjects

You can define a maximum of five subjects for the Student and Data Futures returns. The total percentage for all five subjects must equal 100.

Field or Control	Description
Subject	Enter a value that the system will use to derive the CourseSubject.SBJCA field.
Percentage	Enter a value that the system will use to derive the CourseSubject.SBJPCNT field.
ITT Subject (Initial Teacher Training subject)	Select to indicate that the subject is an ITT subject. The system uses this check box setting to derive the CourseSubject.ITTSUBJECT field.

Accreditation

Field or Control	Description
Accreditation Type	<p>(Optional) Enter a value that the system will use to derive the Accreditation.ACCTYPE field.</p> <p>Each row on the Accreditation group box must have a unique accreditation type. If codes are not provided in the Cnn061CodeLists.xsd file, then you manually add the codes for this field through the Codes page.</p>
Accreditation ID	<p>(Optional) Select an accreditation ID. This ID is used to determine which records are considered for the Curriculum Accreditation entity in the Data Futures return.</p>
Valid From	<p>Select the date from which records are valid. You need to select a date if you provide a value in Accreditation ID.</p>
Valid To	<p>(Optional) Select the date that the records are valid until.</p>
Dependency	<p>If you select this check box, the system derives the Accreditation.ACCDEPEND as <i>I</i>.</p> <p>When you select this check box, the Accreditation Dependency URL field appears.</p> <p>This field is applicable only to Unistats.</p>
Accreditation Dependency URL	<p>Enter a value that the system uses to derive the Accreditation.ACCDEPENDURL field.</p> <p>This field is applicable only to Unistats.</p>

Stage Modules

Note: This data is no longer required because the Course Stages entity has been removed from the Unistats return.

This group box enables you to define the course offerings associated with each stage of the course and displays the FTE and assessment and teaching/learning values defined for each course offering in the HESA Module Data record.

Course Stages

Note: This data is no longer required because the Course Stages entity has been removed from the Unistats return.

The read-only row in this group box displays the weighted averages (by FTE) for the six % percentage fields based on any records added to the Stage Modules group box.

For example, based on the modules defined in the Stage Modules group box of the example graphic, the row for Stage 1 in the Course Stages grid would include read-only percentage fields below the updatable fields for Coursework, Written Exam, Practical Exam, Scheduled Study, Independent Study and Placement Study.

Each of the fields contains the average weighted by FTE for that element to 2 decimal places, for example, the weighted average value for Coursework from the records shown below would be FTE of each module multiplied by the Coursework value for each module. The total for all the modules would then be divided by the total FTE to get the average:

$$\text{FTE for 666683} * \text{Cwk} = 20 * 70 = 1400$$

+

$$\text{FTE for 666684} * \text{Cwk} = 15 * 20 = 300$$

+

$$\text{FTE for 666685} * \text{Cwk} = 25 * 40 = 1000$$

+

$$\text{Total} = 2700$$

The total 2700 would then be divided by the total FTE of all the modules, that is 65.

$$= 2700/60 = 45$$

The same applies to each of the six fields to give the totals shown above.

You could then decide to (a) add percentage integer values in the updatable fields using the module averages as a guide, example, for Stage 1 add values 43, 39, 18 for Scheduled Study, Independent Study and Placement Study as the module averages rounded to make 100 total, and those values would be derived in the extract or (b) leave all the updatable fields as zero, in which case, if Stage Modules records had been defined, then the values would be derived based on the weighted averages from the modules rounded to the nearest integer with some adjustment to ensure that the total of each group of three fields equals 100. If the updatable fields were all zero and no Stage Modules were defined then each of the fields would be derived as zero.

Entering HESA Data for a Program Offering and Program Year

Access the Program Offering/Year HESA page (**Set Up SACR > Foundation Tables > Academic Structure > Academic Program Table > Program Offering/Year HESA**).

This example illustrates the fields and controls on the Program Offering/Year HESA page . You can find definitions for the fields and controls later on this page.

The screenshot shows the 'Program Offering/Year HESA' page with the following sections:

- Navigation:** Enrollment, Course, Dynamic Date, Program HESA Data, Program Offering/Year HESA
- Academic Institution:** PSUNV PeopleSoft University
- Academic Program:** FAU Fine Arts
- Effective Date:** 03/09/2009
- Status:** Active
- Program Offering HESA Data:**
 - *Academic Load: Full-Time
 - FTE Calculation Type: Derive load from Program
 - FTE Load: 100

*Field	Description	*Code	Description
FEELIG	Fee eligibility	1	Eligible to pay home fees
IMPRATE	Implied rate of council partia	20	
- Program Year HESA Data:**
 - *Academic Load: Full-Time
 - FTE Calculation Type: Derive load from Program
 - FTE Load: 100
 - *Year of Program: 1

*Field	Description	*Code	Description
DESTOCM	Destination of outward credit	AD	Andorra
FUNDLEV	Level applicable to funding co	10	Undergraduate

You can enter Instance entity field values in the **Program Offering HESA Data** and **Program Year HESA Data** group boxes.

Entering HESA Data for an Academic Plan

Access the Plan HESA Data page (**Set Up SACR > Foundation Tables > Academic Structure > Academic Plan Table > Plan HESA Data**).

Group boxes on this page are similar to the group boxes on the Program HESA Data page (except that the Offshore Provision, HESA Course and ILR Aims group boxes do not appear on the Program HESA Data page).

You can use this page to enter return fields and corresponding values which you have not defined at the program level. For example, you can use the **Plan Subject HESA Data** group box to define course subjects at the Biology plan level instead of at the BS program level.

<i>Field or Control</i>	<i>Description</i>
Qualification ID	Use this field to indicate the ID that links Course Delivery and Qualification.

Field or Control	Description
Course Title	Optionally, enter a value that the system uses to derive the Course.CTITLE field for the Student return and the KISCourse.TITLEK field for the Unistats/KIS return. If you do not enter a value, the system derives the Course.CTITLE value from the plan description.
KIS Title	<p>Enter a value if the KISCourse.TITLEK value should be different from the value required for the Student return's Course.CTITLE. If both KIS Title and Course Title fields are left blank, the system derives the KISCourse.TITLEK value from the plan description.</p> <p>The system enables this KIS Title field only if KIS Type has a value or at least one of the child subplans has a KIS Type value.</p>
Report to HESA	<p>Select to include the plan in the Course or Provision entity. If you select this check box for a plan, you cannot report data for its subplans.</p> <p>The system enables this check box only if the Report to HESA check boxes of all the subplans associated with the plan are deselected.</p>
Offshore Plan	Select to display the Offshore Provision group box. If you select this check box, the system includes the plan in the Aggregate Offshore return but does not include the plan in the Student return.
KIS Type	<p>The system enables this field only if KIS Type values of all the subplans associated with the plan are blank. This KIS Type field value is used to determine whether the plan should be included in the KISCourse entity. Blank indicates that the plan is not included in the Unistats/KIS return.</p> <p>The system enables the KIS Course Data, KIS Course Links, Stage Modules, Course Stages, Accreditation, HESA Course and ILR Aims group boxes and the KIS Title field only if KIS Type has a value or at least one of the child subplans has a KIS Type value.</p>

The system enables the ITT Subject check box only if the HESA Subject is valid for the ITT return. The valid SBJCA values for ITT return are available on the HESA web site.

Offshore Provision

Use the **Offshore Provision** group box to enter field values for the Provision entity (Aggregate Offshore return).

HESA Course

The system uses the values that you enter in this group box to derive the field values for the Unistats/KIS HESACourse entity.

You can add any number of rows but the HESA Year and Course ID combination must be unique for each row in this group box.

ILR Aims

The system uses the values that you enter in this group box to derive the field values for the Unistats/KIS ILRAims entity.

You can add a maximum of 25 records. The ILR Year and ILR Aim combination for each row must be unique.

Entering HESA Data for a Plan Offering and Plan Year

Access the Plan Offering/Year HESA page (**Set Up SACR > Foundation Tables > Academic Structure > Academic Plan Table > Plan Offering/Year HESA**).

This example illustrates the fields and controls on the Plan Offering/Year HESA page.

Group boxes on this page are similar to the group boxes on the Program Offering/Year HESA page.

Use the Plan Offering/Year HESA page to enter fields and corresponding values that you did not define at the subplan offering/year or program offering/year levels.

Entering HESA Data for a Subplan

Access the Sub-Plan HESA page (**Set Up SACR > Foundation Tables > Academic Structure > Academic SubPlan Table > Sub-Plan HESA**).

The fields on this page are similar to the fields on the Plan HESA Data page. Like the Plan HESA Data page, the Unistats/KIS group boxes on the Sub-Plan HESA page (KIS Course Data, KIS Course Links, Stage Modules, Course Stages, HESA Course, and ILR Aims) appear only if KIS Type field has a value.

The system disables the **Report to HESA** check box on the Sub-Plan HESA page if you selected the **Report to HESA** check box for the parent plan on the Plan HESA Data page. Similarly, the system disables the **KIS Type** field on the Sub-Plan HESA page if you selected a value for the KIS Type field for the parent plan on the Plan HESA Data page. That is, the system enables the KIS Type field on the Sub-Plan HESA page only if the KIS Type value of the parent plan is blank. The KIS Type field value on the Sub-Plan HESA page is used to determine whether the subplan should be included in the KIS Course entity. Blank indicates that the subplan is not included in the Unistats/KIS return.

If you want to report values from the subplan level, use the Sub-Plan HESA page to enter the fields and their corresponding values. For example, you can use the **Sub-Plan HESA Data** group box to define the Course.COURSEAIM value at the Molecular Biology subplan level rather than defining the Course.COURSEAIM value at the Biology plan level or the BS program level.

Select the **Offshore Sub-Plan** check box to display the **Offshore Provision** group box. If you select this check box, the system includes the subplan in the Aggregate Offshore return but does not include the subplan in the Student return.

The system enables the ITT Subject Flag check box only if the HESA Subject is valid for the ITT return. The valid SBJCA values for ITT return are available on the HESA web site.

Entering HESA Data for a Subplan Offering and Subplan Year

Access the Sub-Plan Offering/Year HESA page (**Set Up SACR > Foundation Tables > Academic Structure > Academic SubPlan Table > Sub-Plan Offering/Year HESA**).

This example illustrates the fields and controls on the Sub-Plan Offering/Year HESA page. You can find definitions for the fields and controls later on this page.

The screenshot shows a web application interface with several tabs at the top: Academic Sub-Plan Table, Academic Sub-Plan Taxonomy, Sub-Plan HESA, Sub-Plan Offering/Year HESA (selected), and Advisement. Below the tabs, there is a header area with the following information: Academic Institution PSGBR, PeopleSoft University New; Academic Plan BIO, Biology, Major; Academic Sub-Plan BIOCHEM, Biological Chemistry. Below this is a 'Details' section with 'Effective Date 01/08/2018' and 'Status Active'. There are two main data entry sections: 'Sub-Plan Offering HESA Data' and 'Sub-Plan Year HESA Data'. Each section contains a dropdown for '*Academic Load', a dropdown for 'FTE Calculation Type', and a text input for 'FTE Load' (both set to 0). Below each data section are expandable sections for 'Field Details' and 'Venues'. Navigation controls like 'Find | View All', 'First', '1 of 1', and 'Last' are present for each section.

Group boxes on this page are similar to the group boxes on the Plan Offering/Year HESA page and Program Offering/Year HESA page.

Use the Sub-Plan Offering/Year HESA page to enter fields and corresponding values that you did not define at the plan offering/year or program offering/year levels.

Creating HESA Modules

Access the Create HESA Module Data page (**Records and Enrollment > HESA Reporting > HESA Returns Setup > Create Module**).

The Create HESA Module Data process creates HESA Module Data records for active course offerings. The HESA Module Data record is created with an effective date equal to the latest effective date of the course offering record and the Report to HESA column set to *Yes*.

The process ignores course offerings that already have a corresponding HESA Module Data record.

Note: The Create HESA Module Data process does not allow you to create dummy module data records. Use the HESA Dummy Module Data page to manually create a dummy module data record.

Processing Steps

The Create HESA Module Data process examines each distinct course offering record of the institution.

If you do not select a Reporting Period parameter, the process creates HESA Module Data records as described in the following steps:

1. The process selects the current effective dated record of the course offering (that is, the process selects the most recent effective dated record on or before system date). This is to check whether the course offering is active at the time the process is run. For example, let us suppose two effective dated records exist for a course offering CALCULUS 1. One is dated August 01, 2008 and the other is dated August 01, 2009. If you run the Create HESA Module Data process on August 03, 2009, the process selects the CALCULUS 1 course offering record dated August 01, 2009.
2. If the selected course offering record status is inactive, the process does not create HESA Module Data records.
3. If the selected course offering record is active:
 - a. The process selects the earliest active effective dated record for the course offering. For example, in step 1 the process had selected a course offering record dated 02, August, 2009. If we assume that the course offering CALCULUS 1 has also got effective dated records dated 01 July, 2008 and 01, July 2009, the process selects the record dated 01 July, 2008.
 - b. If a HESA Module Data record does not exist for the selected record, the process creates a new record using the selected record. The process sets the Report to HESA value to *Y*.
 - c. If a HESA Module Data record exists, the process stops processing that course offering record.

If you select a Reporting Period parameter, the process creates new HESA Module Data records and new effective dated rows for the reporting period as described in the following steps:

1. The process selects the earliest effective dated record relevant to the reporting period for the course offering (that is, the process selects the earliest effective dated record between the reporting period start and end dates). For example, let us suppose that the reporting period is 2008-09 and for a course offering General Accounting, two effective dated records exist. One is August 01, 2008 and the other is November 01, 2008. In this case, the process selects the course offering record dated August 01, 2008.

If an effective dated course offering record does not exist in the reporting period, then the process does not process the record.

2. If the selected course offering record is active and:
 - a. If an existing HESA Module Data record does not exist, the process creates a new record using the effective date of the selected course offering record. The process sets the Report To HESA value to *Y*.
 - b. If a HESA Module Data record exists with an effective date in the reporting period, the process stops processing that record.
 - c. If a HESA Module Data record with an effective date after the reporting period exists, the process updates the effective date of that record and any child field records using the effective date of the selected course offering record.
 - d. If a HESA Module Data record with an effective date before the reporting period exists, the process creates a new effective dated row using the HESA Module Data record and the effective date of the selected course offering record. The process also copies any existing child Module field records of the HESA Module Data record to the new effective dated HESA Module Data record.
3. If the selected course offering record is inactive, the process stops processing. Note that the process derives the active and inactive status value from the parent Course Catalog record of the course offering.

Creating Qualification Records

Access the Create Qualifications page (**Records and Enrollment > HESA Reporting > HESA Returns Setup > Create Qualifications**).

This example illustrates the fields and controls on the Create Qualifications page. You can find definitions for the fields and controls later on this page.

Use this page to create qualification records for plans and sub-plans that are reported to HESA when a qualification hasn't already been defined for them. After a new qualification record is created, the most recent plan or sub-plan HESA record is updated to add the newly created qualification ID.

For new qualifications, the process sets the Qualification Category (QUALCAT) to the QUALCAT value defined for the plan or sub-plan. If a QUALCAT value isn't defined for the plan or sub-plan, COURSEAIM values from the legacy Student return are used to create QUALCAT values.

- If QUALCAT is defined in the most recent HESA Academic Sub-Plan record, that value is used
- If COURSEAIM is defined in the most recent HESA Academic Sub-Plan record, then if it's mapped to a QUALCAT code, SSR_HE_QUALCAT is set to the mapped value. Otherwise, set SSR_HE_QUALCAT = ZZZZZ.
- If QUALCAT is defined in the most recent HESA Academic Plan record, that value is used.
- If COURSEAIM is defined in the most recent HESA Academic Plan record, then if it's mapped to a QUALCAT code, SSR_HE_QUALCAT is set to the mapped value. Otherwise, set SSR_HE_QUALCAT = ZZZZZ.
- If QUALCAT is defined in the most recent parent HESA Academic Program record, that value is used.
- If COURSEAIM is defined in the most recent parent HESA Academic Program record, then if it's mapped to a QUALCAT code, SSR_HE_QUALCAT is set to the mapped value. Otherwise, set SSR_HE_QUALCAT = ZZZZZ.
- If QUALCAT or COURSEAIM isn't defined at any level, set SSR_HE_QUALCAT = ZZZZZ.

Field or Control	Description
Include Plans	<p>By default, this check box is selected. This creates qualifications for combinations of degree and plan.</p> <p>Records are selected from the Academic Plan table where the most recent effective-dated record fulfills these conditions:</p> <ul style="list-style-type: none"> • Effective Status is "Active." • Degree Offered is defined. • Report to HESA is selected in Plan HESA Data. • Offshore Plan isn't selected in Plan HESA Data. • Qualification ID is blank in Plan HESA Data. <p>If an academic career is selected as a parameter, plans are only considered if they are directly associated with the career or with the career via the parent program.</p>
Include Sub-Plans	<p>If you select this check box, records are selected from the Academic Sub-Plan table for the institution where the most recent effective-dated academic plan record fulfills these conditions:</p> <ul style="list-style-type: none"> • Degree Offered is defined. • Report to HESA is selected in Sub-Plan HESA Data. • Offshore Plan isn't selected in Sub-Plan HESA Data. • Qualification ID is blank in Sub-Plan HESA Data. • Effective Status of the sub-plan is "Active."
Include Subjects	<p>By default, this check box is selected. This creates HECoS subjects for the qualification from either Plan or Sub-Plan HECoS Subjects for the most recent effective-dated Plan or Sub-Plan HESA Data. Or if the plan is associated with an academic program, HECoS Subjects are created from the most recent effective-dated Program HESA Data.</p>
Include Accreditation	<p>By default, this check box is selected. This creates award accreditation records from either the distinct accreditation IDs from the most recent effective-dated Plan or Sub-Plan HESA Data where Valid To is blank or a future date and the accreditation ID is an active code for ACCREDITATIONIDQAA. Or if the plan is associated with an academic program, distinct accreditation IDs are created from the most recent-effective dated Program HESA Data where Valid To is blank or a future date and the accreditation ID is an active code for ACCREDITATIONIDQAA.</p>

Field or Control	Description
Default Awarding Body	By default, this check box is selected. When selected, an awarding body is created for each qualification based on the UKRPN that's defined for the academic institution in HESA Configuration .

Entering HESA Data for a Module

Access the HESA Module Data page (**Curriculum Management > Course Catalog > HESA Module Details**).

On the HESA Module Data page:

- Use the **Module Data** group box to enter Module and Student on Module entity fields and their associated values.
- Use the **HESA Subjects** group box to enter values that the system uses for deriving HESA Subject entity fields. You can enter a maximum of 16 subjects. The Subject/Cost Centre Percentage for all module subject records must equal 100.

You can manually add a HESA Module Data record for a course offering using the HESA Module Data page in add mode. However, if you want to create multiple HESA module data records for course offerings, use the Create HESA Module Data process.

HECoS Subjects

This group box is the same as the group box in Plan HESA Data page, except it does not have the ITT Subject field.

You can define a maximum of three subjects.

Entering HESA Data for a Dummy Module

Access the HESA Dummy Module Data page (**Curriculum Management > Course Catalog > HESA Dummy Module Details**).

You can manually add a HESA dummy module data record using the HESA Dummy Module Data page in add mode. The system uses the HESA dummy module data record to create a dummy module in the Student On Module entity. This dummy module represents the year of program for active Research and Placement students who do not have any class enrollments

Field or Control	Description
Always Include	Select this check box to report the dummy module in the Student on Module entity together with any eligible class enrollments for the students. If this check box is not selected, the dummy module is reported <i>only</i> if the student does not have any class enrollments being reported in the Student on Module entity.

HECoS Subjects

This group box is the same as the group box in HESA Module Data. You can define a maximum of 16 subjects.

Creating HESA Instance and Person HESA Data Records for Students

Access the Create HESA Instance page (**Records and Enrollment > HESA Reporting > HESA Returns Setup > Create Instance**).

The Create HESA Instance process examines student program/plan records and determines whether there is a related HESA Instance record for a student. If a student does not have an Instance record, the process creates a new HESA Instance record using the Effective Date of the MATR or ACTV row in the Student Program/Plan stack record and sets the Report to HESA internal setting to *Yes* for the student. The process first selects the MATR row and creates a HESA record with that effective date. If a MATR row does not exist, the process selects the row with program action ACTV and creates a HESA record with that effective date.

The process automatically populates the **Instance Identifier** field value to the HESA Instance record. The NUMHUS derivation logic considers the Instance Identifier value. The process also creates the Person HESA Data record if it does not already exist for the student.

The process generates the Instance Identifier based on the Academic Career, Student Career Number, and Entry Year of the student. The system determines the Entry Year based on the reporting period and the effective date that is used to create the HESA Instance record. The system selects the Reporting Year value of the HESA reporting period that the effective date falls within and uses the year value for Entry Year. For example, an effective date of September 20, 2008 falls within the 2008/09 reporting period, which has a reporting year value of 2008, so Entry Year would be 2008. If the student's career details are Career = UGRD, Career Number = 0, and effective date = September 20, 2008, then the process creates an Instance Identifier of UGRD02008.

Year of Student (YEARSTU) defaults to 1, and Year of Program is set to either the Year of Program value in the same Student Program/Plan record used for Effective Date or a default value of 1.

Field or Control	Description
Academic Career, Academic Program, Academic Plan, Academic Sub-Plan	Select values as needed to generate the HESA Instance records for students with the selected career, program, plan, or subplan.
Start Date	Enter a date so that only students who matriculated on and after this date are included by the process. If the Update Registration Number check box is selected, you must enter a Start Date.
Update Registration Number	Select to update existing HESA instance records where the Registration Number is zero and the earliest effective-dated row is on or after the Start Date. The system updates the registration number to 1 for the most recent effective-dated record.

Student Override

<i>Field or Control</i>	<i>Description</i>
Student Override	<p>Select if you want to generate HESA Instance records for the IDs selected in the EmplID field.</p> <p>If you select the Student Override check box, the process ignores any values entered in the Academic Career, Academic Program, Academic Plan , Academic Sub-Plan, and Start Date fields.</p>
EmplID (employee ID)	Enter the IDs of one or more students for whom the process must create the Instance data.

Restricting Access to Person HESA Data Fields

Access the Fields page (**Records and Enrollment**, > **HESA Reporting** > **HESA Returns Setup** > **Fields**).

This example illustrates the fields and controls on the Fields page. You can find definitions for the fields and controls later on this page.

Fields

Field: RELBLF

Description:	<input type="text" value="Religion or belief"/>
Long Description:	<input type="text" value="Religion or belief"/>
HESA Data Type:	RELBLFCodeType
Field Type:	Text Text Data Type
Field Length:	2.0
Source:	Seeded
*Display Region:	<input type="text" value="Restricted"/> <input checked="" type="checkbox"/> Active

Fixed

Available at

- Institution
- Student
- Instance
- Advisor
- Program
- Program Offering
- Program Offering Year
- Plan
- Plan Offering
- Plan Offering Year
- Subplan
- Sub-Plan Offering
- Sub-Plan Offering Year
- Module

To restrict access, select a value for the Display Region field if the system has selected the Available at check box for Student. The Display Region field remains read-only for all other fields.

Field or Control	Description
Display Region	<p>This field is available for edit only if the system has selected the Available at check box for Student level data capture. Three values are delivered: <i>Restricted</i>, <i>Other</i> and <i>Not Displayed</i>.</p> <p>If you select <i>Other</i>, the field will be available only on the HESA Student Data page where you can capture the field's value.</p> <p>If you select <i>Restricted</i>, the field will be available only on the HESA Restricted Data page where you can capture the field's value.</p> <p>If you select <i>Not Displayed</i>, you cannot capture any new values for the field on the HESA Student Data page but the page will continue to display any existing values for the field.</p> <p>You can restrict the following delivered fields: DISABLE, ETHNIC, GENDERID, NATION, NATIOND, RELBLF, SDEPEND, SEXORT, TTACCOM, TTPCODE and WELSSP.</p>

Entering HESA Data for a Person

Access the HESA Student Data page (**Campus Community > Personal Information > Add/Update a Person > HESA Student Data**).

This example illustrates the fields and controls on the HESA Student Data page. You can find definitions for the fields and controls later on this page.

The screenshot shows the HESA Student Data page for James Barret (SRGBR001). The page includes navigation tabs for Biographical Details, Addresses, Regional, HESA Student Data, and HESA Restricted Data. The student's name and ID are displayed at the top. Below this, there are search and navigation options. The main section is titled "HESA Student Fields" and contains a table with the following data:

Field	Description	Code	Description
DISABLE	Disability	00	No known disability
NATION	Nationality	GB	United Kingdom
NATIOND	National identity	E	English
SDEPEND	Dependants in reporting year	03	No dependents
TTACCOM	Term-time accommodation	8	Other rented accommodation
WELSSP	Welsh speaker indicator	3	Not Welsh speaker

Use the HESA Student Data page to enter fields and their corresponding values at the student level.

You can manually add a Person HESA Data record using the HESA Student Data page in add mode. However, if you want to create multiple Person HESA Data records with instance records, use the Create HESA Instance process.

Note: On this page, you can select only those fields for which the Display Region is set up as *Other* on the Fields page. The fields that have Display Region as blank will be displayed on this page if they have any values but you cannot select those fields.

Entering Restricted HESA Data for a Person

Access the HESA Restricted Data page (**Campus Community > Personal Information > Add/Update a Person > HESA Restricted Data**).

This example illustrates the fields and controls on the HESA Restricted Data. You can find definitions for the fields and controls later on this page.

The screenshot shows the 'HESA Restricted Data' page for a person named James Barret (ID: SRGBR001). The page has several tabs: Biographical Details, Addresses, Regional, HESA Student Data, and HESA Restricted Data. The 'HESA Restricted Data' tab is active. Below the header, there are fields for '*Effective Date:' (01/01/1960) and 'Status:' (Active). A table titled 'HESA Student Fields' contains the following data:

Field	Description	Code	Description
GENDERID	Gender identity	01	Yes
RELBLF	Religion or belief	03	Christian
SEXORT	Sexual orientation	04	Heterosexual

On this page, you can select only those fields for which the Display Region is set up as *Restricted* on the Fields page.

Access to the HESA Restricted Data page can be controlled through the PeopleTools Permission List setup:

- Menu Name: CC_BIO_DEMO_DATA – Bio/Demographic Data
- Component Name: SCC_BIO_DEMO – Add/Update a Person

Entering HESA Instance Data for a Student

Access the HESA Instance page (**Records and Enrollment > Career and Program Information > HESA Instance Details > HESA Instance**).

This example illustrates the fields and controls on the HESA Instance page . You can find definitions for the fields and controls later on this page.

HESA Instance Details

HESA Instance
Mobility
Entry Profile
Further Education
Qualification Awarded

Name Sally Watkins	ID ADGBR001
Academic Career Undergraduate	Career Number 0 Student Program
Academic Institution PeopleSoft University UK	Status Completed
Academic Program Bachelor of Science	Academic Plan Biology
Academic Load Full-Time	Admit Term 2016-17 Academic year

Student Identifier

Instance HESA Data Find | View All | First 1 of 1 Last

*Effective Date <input type="text" value="08/01/2019"/>	Instance Identifier <input type="text" value="UGRD02016"/>
Reported Plan <input type="text"/>	Registration Number <input type="text" value="1"/>
Linked Career <input type="text"/>	Start Date of Instance <input type="text" value="09/26/2016"/>
Linked Career Number <input type="text"/>	Year of Student <input type="text" value="4"/>
HIN Population Year <input type="text"/>	Year of Program <input type="text" value="4"/>
Instance Load <input type="text"/>	Session Start Date <input type="text"/>
Current Term <input type="text"/>	Expected Session End <input type="text"/>
Current Session Year <input type="text"/>	Actual Session End <input type="text"/>

Report to HESA

▶ Instance Details

▶ Financial Support

▶ ITT Placement

▶ Research Data

▶ Thesis Details

FTE Details Personalize | Find | First 1 of 1 Last

*Reporting Period	Calculated FTE	Override FTE	Report Zero
<input type="text" value="2019/20"/>	50.0	<input type="text"/>	<input type="checkbox"/>

This page is available for a student if you have created a HESA Instance record for the student. Use the Create HESA Instance page to create HESA Instance records for a group of students. You can also manually create a HESA Instance record for a student using the HESA Instance page in add mode.

Field or Control	Description
Student Identifier	<p>This is a read-only field that displays either the student’s current SID or HUSID.</p> <p>The combination of this value and Instance Identifier (NUMHUS) is used as the unique key for the Engagement entity.</p>

Instance HESA Data

Field or Control	Description
Instance Identifier	Displays the value generated by the Create HESA Instance process when it creates a HESA Instance record. You can manually enter or modify this value. The system uses this value to derive NUMHUS.
Reported Plan	Select the primary plan to be used for HESA reporting if the student has more than one active plan.
Registration Number	This field displays 1 for new instance records. The system uses the value in this field and Instance Identifier to ensure the combination is a unique ID for the institution.
Start Date of Instance	Displays the date generated by the Create HESA Instance process. You can manually enter or modify this value. The system uses this value to derive the Instance.COMDATE (Student return) and Student.COMDATE (ITT return).
Year of Student	Displays the value generated by the Calculate Year of Student process. You can manually enter or modify this value. The system uses this value to derive the Instance.YEARSTU field (Student return) and Student.YEARSTU field (ITT return).
Year Of Program	Enter a value that the system uses to derive the Instance.YEARPRG field (Student return) and Student.YEARPRG field (ITT return).
Linked Career and Linked Career Number	Select a career to link this Instance to previous careers. The system treats all the linked careers for a student as a single Instance for HESA reporting.
HIN Population Year	Displays the value entered by the Import HIN Target List process. You can edit the value, if required. The Create Extract process uses the HIN Population Year value to determine which Instance entities to include in the return. If the HIN Population Year matches the reporting year of the reporting period, then the process automatically includes the Instance entity of the student regardless of other criteria (such as whether the Report To HESA is selected). Examples of valid HIN Population Year values include <i>2008</i> (for 2008/09 reporting) and <i>2009</i> (for 2009/10 reporting).

Field or Control	Description
Instance Load	(Optional) Use this field to override the academic load value from Student Program. For example, if the student a repeating part-time student but is still on a full-time program <i>and</i> the Academic Load in Student Program is set to part-time, the Instance Load field can be set to full-time to ensure the student is still associated with a full-time Course Delivery.
Expected End Date	(Optional) Use this field to allow a specific end date to be defined where the date is different from the expected end date that is reported for the student's Course Delivery.
Current Term	(Optional) Use this field to override the current term that is selected from the term activation records.
Current Session Year	(Optional) Define a student's session year directly in HESA Instance. You can select an active session year that's defined for the institution.
Report To HESA	Select to report the Instance to HESA. If the check box is cleared, the Create Extract process does not create a return extract for the instance.

Financial Support

The page displays the Financial Support region if you have selected the Show Financial Support region check box on the HESA Configuration page. The system uses the values that you enter in this region to create the Financial Support entity.

The combination of Support Type, FINTYPE, and Access Spending must be unique.

ITT Placement

This region appears if you select the **Show ITT Placement region** check box on the HESA Configuration page. You can define a maximum of five records. The School and Start Date combination must be unique.

Research Data

In the Research Data group box, the combination of REF Unit, RAE Unit, and Collaborating Provider must be unique and at least one value must be defined (either REF Unit or RAE Unit) along with Percentage to save a record.

<i>Field or Control</i>	<i>Description</i>
Collaborating Provider	To record the same REF Unit for your institution as well as a collaborating provider, leave this field blank for your institution's records, and enter a value for the collaborating provider's records.

FTE Details

<i>Field or Control</i>	<i>Description</i>
Calculated FTE	Displays the value calculated by the Calculate Full-Time Equivalence process.
Override FTE	Enter a value to override the Calculated FTE.
Report Zero	Select to report zero in STULOAD rather than the Calculated FTE or Override FTE values

Entering Mobility Data for a Student

Access the Mobility page (**Records and Enrollment > Career and Program Information > HESA Instance Details > Mobility**).

This example illustrates the fields and controls on the Mobility page. You can find definitions for the fields and controls later on this page.

The screenshot shows a web interface for managing HESA returns. At the top, there are tabs for 'HESA Instance', 'Mobility', 'Entry Profile', 'Further Education', and 'Qualification Awarded'. The 'Mobility' tab is active.

Below the tabs, student information is displayed in two columns:

- Name:** Sally Watkins
- Academic Career:** Undergraduate
- Academic Institution:** PeopleSoft University New
- Academic Program:** Bachelor of Science
- ID:** ADGBR001
- Student Career Nbr:** 0
- Status:** Completed

The main content area has two expandable sections:

Details (Expanded):

- *Effective Date: 08/01/2019

Off Venue Activity (Expanded):

- *Activity Type: [Searchable]
- *Mobility Scheme: [Searchable]
- External Org ID: [Searchable]
- Host ID Type: [Searchable]
- Country: [Searchable]
- *Duration Type: [Searchable]
- Start Date: [Date Picker]
- Host ID: [Text Field]
- *Duration: [Text Field]
- End Date: [Date Picker]
- Module Instance: [Text Field]

Mobility (Expanded):

- *Location: [Searchable]
- *Scheme: [Searchable]
- *Start Date: [Date Picker]
- *Type 1: [Searchable]
- Type 2: [Text Field]
- Type 3: [Text Field]
- External Org ID: [Searchable]
- *End Date: [Date Picker]

Off Venue Activity

The combination of Activity Type, Mobility Scheme, External Org ID, Host Name, Host ID Type, Host ID, and Start Date must be unique.

If there are multiple records with the same Activity Type, Scheme, and Host, then you must specify a Start Date.

Field or Control	Description
External Org ID	<p>(Optional) The values that appear on the list are organizations that have one of the following values defined in Regional: UKPRN, Unique Reference Number, Companies House Number, National Health Service ID, Host ID.</p> <p>If you select an external organization, then these fields are disabled:</p> <ul style="list-style-type: none"> • Host Name • Host ID Type • Host ID • Country • Postcode • Lead School
Host ID Type Host ID	(Optional) You must provide a value when Activity Type is 0 or 1 <i>and</i> External Org ID is blank.

Mobility

The combination of Location, Scheme and Start Date must be unique.

Field or Control	Description
External Org ID	You can enter an External Organization ID if you want to record the exact location of the student.
Type 1	Select a MOBTYPED code.
Type 2	<p>Select a MOBTYPED2 code.</p> <p>This field becomes available only if you have selected a value for the Type 1 field. The Type 2 and Type 1 values cannot be the same.</p>
Type 3	<p>Select a MOBTYPED3 code.</p> <p>This field becomes available only if you have selected a value for the Type 2 field. The Type 3, Type 2 and Type 1 values cannot be the same.</p>

Entering HESA Entry Profile Data for a Student

Access the Entry Profile page (**Records and Enrollment > Career and Program Information > HESA Instance Details > Entry Profile**).

This example illustrates the fields and controls on the Entry Profile page. You can find definitions for the fields and controls later on this page.

The screenshot shows the 'Entry Profile' tab selected. Student details include Name: James Barret, ID: SRGBR001, Academic Career: Undergraduate, Academic Institution: PeopleSoft University UK, and Academic Program: Bachelor of Arts. The Effective Date is 01/08/2011. The 'Include Entry Profile' checkbox is unchecked. Below, the 'Entry Profile' table shows one entry with Field: DOMICILE, Description: Domicile, Code: BE, and Description: Belgium. The 'Entry Qualifications' table below it has columns for Type, Description, Subject, Description, Year, Sitting, Grade, Imported, and Report to HESA.

Field or Control	Description
Include Entry Profile	Select if want an entry profile to be created when the Start Date of Instance is before the start of the reporting period. If the Start Date of Instance is in the reporting period, you need not select this checkbox. The Extract process automatically creates an entry profile when the Start Date of Instance is equal to or after the start date of the reporting period, regardless of whether you select or clear this checkbox. Note: The Create HESA Instance process clears the Include Entry Profile checkbox, when it creates a new HESA instance record.
Imported	Indicates whether the data was imported from UCAS.
Report To HESA	Select to include the record in the Qualifications On Entry entity.

Note: If grades are not mapped to a particular qualification type on the Entry Qualification Mapping page, then all the grades are available for a qualification type. If you have done a Entry Qualification mapping, the lookup for the Grade field displays only the mapped grades for a type.

Entering Further Education Data for a Student

Access the Further Education page (**Records and Enrollment > Career and Program Information > HESA Instance Details > Further Education**).

This example illustrates the fields and controls on the Further Education page (1 of 2). You can find definitions for the fields and controls later on this page.

The screenshot shows the 'Further Education' page for student James Barret (ID: SRGBR001). The page is divided into several sections:

- Header:** Name: James Barret, ID: SRGBR001, Academic Career: Undergraduate, Academic Institution: PeopleSoft University UK, Academic Program: Bachelor of Arts, Student Career Nbr: 0, Status: Active, Description: Acad year 2006-2007.
- Details:** *Effective Date: 08/01/2016.
- Instance Details:** A table with columns for *Field, Description, *Code, and Description.
- Employment Status:** Record Number: 1, *Employment Status, *Status Date, Employer ID, Workplace Postcode.
- Employment Monitoring:** A table with columns for Record Number, *Type, Description, and *Code.

This example illustrates the fields and controls on the Further Education page (2 of 2). You can find definitions for the fields and controls later on this page.

The screenshot shows the 'Funding and Monitoring' section of the Further Education page:

- Learner:** A table with columns for Type, Description, and *Code.
- Learning Delivery:** A table with columns for Type, Description, *Code, Date From, and Date To.
- Work Placement:** A table with columns for *Mode, Description, Employer ID, *Start Date, End Date, and Hours.

The system displays this page only if you have selected the Enable Further Education page check box on the HESA Configuration page.

Work Placement

The values in this region are used to derive the Learning Delivery Work Placement entity in the Student Return.

Field or Control	Description
Mode	Select the type of work placement.

Field or Control	Description
Employer ID	Optional. The value is derived from the Employer ID field in the Employment Status region. Alternatively, you can use this field to record the employer number from the Employer Data Service (EDS).
Start Date	Select the date that the work placement started.
End Date	Select the date that the work placement ended.

Note: The combination of Mode, Employer ID, and Start Date must be unique. Employer ID can be blank.

Calculating Year of Student Values for Students

Access the Calculate Year of Student page (**Records and Enrollment > HESA Reporting > Extract Processing > Calculate Year of Student**).

Field or Control	Description
Increment Year of Program	Select to increment the Year of Program value by one when the Calculate Year of Student process creates a new effective dated HESA Instance record for the reporting period.
Student Override	Select to specify single or multiple students for whom the process should calculate YEARSTU.
Copy Instance Details	Select to have the process copy instance records from the previous effective-dated HESA Instance record.
Copy Qualifications Awarded	Select to have the process copy qualifications awarded records from the previous effective-dated HESA Instance record.
Copy Research Data	Select to have the process copy research records from the previous effective-dated HESA Instance record.
Copy FTE Details	Select to have the process copy FTE records from the previous effective-dated HESA Instance record.

The process calculates the value that the system uses to derive the Instance.YEARSTU (Year of student on this instance) field in the Student Return. The Instance.YEARSTU value is the number of reporting periods that the student has been active in the instance (including linked previous instances).

The process examines student class enrollments and calculates the number of distinct reporting periods covered by the enrollments. The process creates new effective dated HESA Instance records for the

specified reporting period. For example, if a student has a HESA Instance record with an effective date of August 1, 2007 and the process runs for the 2008/09 reporting period, then the system creates a row with a new calculated YEARSTU value and an effective date of August 1, 2008. This enables you to roll forward the HESA Instance records to a new reporting period. If the student already has an effective dated record in the reporting period, then the process updates the YEARSTU value of that record.

Note: The HESA Instance page displays the value that the Calculate Year of Student process has calculated.

Calculation Steps

The following steps describe how the Calculate Year of Student process selects records and calculates YEARSTU from the selected records:

Step 1: Initial Selection of Records

The process selects HESA Instance records that match the run parameters. For each distinct student career in the HESA Instance records, it selects the latest record with an effective date on or before the reporting period end date only if the Report to HESA setting = Y. If the selected record has Report to HESA setting = N, then the process does not include the record in the calculation even if there are previous effective dated records with the Report To HESA setting = Y. This means, the process selects HESA Instance records that either (a) started prior to the reporting period and there is no effective dated row starting in the reporting period, or (b) started in the reporting period. Depending on the calculated YEARSTU value, it treats the records differently for update in the following steps.

If the latest student program record has a status of COMP and the effective date of that record is before the beginning of the reporting period, then the process assumes that the career has been completed before the reporting period (and has not been reactivated since completion) and the calculation of the YEARSTU for the selected HESA Instance record is skipped.

The process logs a message for each record that is selected.

Step 2: Filter for Active Students

The Calculate Year of Student process calculates and stores a YEARSTU value only if the student has been active in the current reporting period.

To determine the student has been active in the current reporting period, the process performs the following steps:

- The process selects all activated terms for the student career.
- The process determines that the student is active in the current reporting period if there is at least one class for any of the selected terms that satisfies the following conditions:
 - Class Start Date is within the reporting period, or Class End Date is within the reporting period, or Class Start Date is prior to the reporting period and Class End Date is after the reporting period.
 - Status = *Enrolled* or *Dropped*.
 - Units Taken value is greater than zero.
 - Grading basis value matches one of the values defined in the Grading Basis Inclusion region with the Year of Student check box selected on the HESA Configuration page.

- Repeat Code value is null or does not match a value defined in the Repeat Code Exclusion region with the Year of Student check box selected on the HESA Configuration page.
- If the student has multiple careers with the same Academic Career value as the career being processed (that is, the same career value with different career numbers), then the process applies a further filter to the class enrollments. In that case, the process selects the class only if the program value of the enrollment record matches one of the program values in the Student Program records for that career and career number.

When the process considers class start and end dates for class enrollments where the Session = *OEE* (open entry/exit), rather than selecting the class start/end dates, the process selects the values from the Student OEE Enrollment Data record for the class enrollment. If the end date is not defined in Student OEE Enrollment Data then the process uses the class end date. The start date is mandatory for a Student OEE Enrollment Data record. Note that the process uses this same OEE logic when it examines class enrollments in the next step (the next step is Step 3, Calculate YEARSTU).

The process does not consider previous linked careers because it assumes that linked careers will only have been active prior to the current reporting period.

In cases where the student has multiple careers, the process does not consider class enrollments that occur before the effective date of the HESA Instance record unless the Instance is linked to a previous career. The selection of activated terms considers only those terms that overlap the Instance, that is where the term begin date is greater than the earliest effective date of the HESA Instance record. The only exception to this rule is where a Linked Career and Career Number are defined for the HESA Instance record in which case the process also considers terms related to that other career.

For each Instance where the student has not been active for the reporting period, the process logs a message and the process skips to the next selected record.

For each active Instance, the process logs a message and calculates the total YEARSTU.

Note that this method of selection does not include active students who do not have any class enrollments (for example, research students).

Step 3: Calculate YEARSTU

For each student who is active in the reporting period, the Calculate Year of Student process uses the following selection method to calculate the year of student value: The process selects distinct activated terms for the Student Career. If the Instance has been linked to a prior Student Career using the Linked Career and Linked Career Number fields in the HESA Instance record, then the process also selects activated terms for the previous career with enrollments.

From the selected terms, the student must have at least one class enrollment that satisfies the following conditions:

- Class Start Date is within the reporting period, or Class End Date is within the reporting period, or Class Start Date is prior to the reporting period and Class End Date is after the reporting period.
- Status = *Enrolled* or *Dropped*.
- Units Taken value is greater than zero.
- Grading basis value matches one of the values defined in the Grading Basis Inclusion region with the Year of Student check box selected on the HESA Configuration page.

- Repeat Code value is null or does not match a value defined in the Repeat Code Exclusion region with the Year of Student check box selected on the HESA Configuration page.
- If the student has multiple careers with the same Academic Career value as the career being processed (that is, the same career value with different career numbers), then the process applies a further filter to the class enrollments. In that case, the process selects the class only if the program value of the enrollment record matches one of the program values in the Student Program records for that career and career number.

The process then finds out the distinct reporting periods where the class enrollment overlaps (the process considers all delivered active or inactive reporting periods but does not consider any manually added reporting periods). The count of these reporting periods is the year of student value. The process ignores any future reporting periods, that is periods subsequent to the period selected as the run parameter. For example, if the student has only been active in the current (that is, the period selected as the parameter) reporting period then the YEARSTU value is 1, if the student has been active in 2 distinct reporting periods the YEARSTU value is 2.

Step 4: Store the Calculated YEARSTU

The Calculate Year of Student process stores the calculated YEARSTU value in the HESA Instance record as follows.

If the most recent effective dated HESA Instance record has an effective date before the reporting period start date:

1. The process creates a new effective dated record using the reporting period start date. It copies all the data from the following records to the new effective dated record: Header record (SSR_HE_INSTANCE), Entry Profile fields (SSR_HE_INST_FLD where SSR_HE_ENTR_FLAG = Y), Entry Qualifications (SSR_HE_QUAL_ENT), Employment Status (SSR_HE_INST_EST), Employment Monitoring (SSR_HE_INST_MON), Learner (SSR_HE_INST_LRN) and Learning Delivery (SSR_HE_INST_LDL). The Instance Details fields (SSR_HE_INST_FLD where SSR_HE_ENTR_FLAG = N), including the Further Education Instance fields, are copied only if you have selected the Copy Instance Details check box. The Qualifications Awarded (SSR_HE_QUAL_AWD) records are copied only if you have selected the Copy Qualifications Awarded check box. The Research Data (SSR_HE_INST_RES) records are copied only if you have selected the Copy Research Data check box. The FTE Details (SSR_HE_INST_FTE) records are copied only if you have selected the Copy FTE Details check box.
2. The process sets the YEARSTU value to the calculated value.
3. If the Increment Year of Program parameter check box is selected and the existing record has a Year of Program value greater than zero, the process increments the value by one in the new record.

If the HESA Instance record starts within the reporting period, the process inserts the calculated YEARSTU value to the existing record.

The process logs a message to confirm the value has been calculated and stored.

Calculating Full-Time Equivalence for Students

Access the Calculate Full-Time Equivalence page (**Records and Enrollment > HESA Reporting > Extract Processing > Calculate FTE**).

Student return's Instance.STULOAD is expressed as a percentage of FTE. A student who has been studying full-time for the reporting period has an FTE of 100. A student studying part-time has a value of less than 100 to represent the proportion of full-time study they have undertaken. For example, a student with half the load of a full-time student has a FTE of 50.

An institution can calculate the FTE based on either class enrollments or program load depending on its requirements.

An institution can define a calculation type of either *Derive load from Modules* (that is, calculation based on the student's class enrollments) or *Derive load from Program* (that is, calculation based on the FTE load defined for the year or for the program, plan, and subplan) at each data capture level (for example, the Plan HESA Data page for plan level). A default calculation type run parameter is also available to enable institutions to apply the same calculation type to all students of a particular institution, career, or program without the need for defining the calculation type against each program, plan, or subplan.

Field or Control	Description
Academic Career	<p>Select a value to run the calculation process individually for each academic career. This enables your institution to apply a different FTE calculation type, academic calendars and full-time load to each distinct career.</p> <p>Required to select an academic calendar or academic program.</p> <hr/> <p>Note: Do not select a value if you want to run the process for all academic careers in an institution. You should run the process for all academic careers only when the FTE Calculation Type is <i>Derive load from Modules</i> for all records. If the FTE Calculation Type is <i>Derive load from Program</i> for any record, then you must select both academic career and academic calendar as the run parameters.</p>
Academic Calendar	<p>Select a value that the process uses for program calculation to determine the start and end dates of terms associated with the calendar that fall within the reporting period. The process uses these dates to apportion load for discontinued students.</p> <p>Required if the Default Calculation Type is <i>Derive load from Program</i>.</p>
Return Name	<p>This field is used to calculate the FTE load for postgraduate research (PGR) students.</p> <p>If you select a value, the HESA Action Reason setup for Change of Mode and Reason for Ending is used when deriving load based on program or mode of study periods.</p> <p>If you don't set a value, the default FTE calculation type is used.</p>

Field or Control	Description
Default FTE Calculation Type	Select a default value that the process uses if a calculation type is not defined for the program, plan, or subplan related to the HESA Instance record. Values include <i>Derive load from Modules</i> and <i>Derive load from Program</i> . If the value is Derive load from Program , then you must set values for Academic Career and Academic Calendar.
Maximum Calculated Value	Enter the maximum FTE value that the process can calculate. This field enables you to cap the calculated value to a maximum value, typically 100 for full-time students.
Consider Sub-Plans	Select to have the process consider subplan HESA records to determine FTE calculation type and FTE load. You can select a calculation type and enter an FTE load in the Sub-Plan HESA Data page or the Sub-Plan Offering/Year HESA page.
Include Dropped Classes	Select to have the process consider class enrollments with a status of <i>Dropped</i> along with class enrollments with a status of <i>Enrolled</i> .
Increment Year of Program	Select to have the existing Year of Program value increase by one when the Calculate Full-Time Equivalence process creates a new effective dated HESA Instance record for the reporting period.
Apportion Module Load	Select to have the process reduce the load of class enrollments for students who have discontinued, left, or cancelled. The process considers the selection or de-selection of this check box only when the derived calculation type is <i>Derive Load from Modules</i> . The process always reduces the load for discontinuation if the calculation type is <i>Derive load from Program</i> .
Student Override	Select to specify single or multiple students for whom the process should calculate FTE.

Note: If you want to use calculation type or FTE load values at *Offering* or *Year* levels, then you must ensure that the Year of Program values in HESA Instance records are verified and updated before the FTE calculation process is run.

The process determines the calculation type from the student's year, program, plan, or subplan. If no values exist in the data capture pages, it uses the default calculation type run parameter. After the process determines the calculation type, the calculation is done based on either the FTE Load defined in the data capture pages or class enrollments. For calculation based on program load, an adjustment is made if the student has discontinued before the end of the academic calendar.

The process initially selects each HESA Instance record that matches the process parameters. It selects the latest effective dated record with an Effective Date on or before the reporting period end date only if the

Report to HESA setting = Y. If the selected record has Report to HESA setting = N, then the process does not include the record in the calculation even if previous effective dated records exist with the Report To HESA setting = Y. For each selected Instance, the process determines if the related Academic Career has at least one activated term overlapping the reporting period or at least one class enrollment overlapping the reporting period. If the relevant activated term or class enrollment does not exist for the student, then the process logs a message and skips processing the instance.

While determining if any classes overlap the reporting period, if the class enrollment has a Session = *OEE* (open entry/exit), rather than selecting the class start/end dates, the process selects the values from the Student OEE Enrollment Data record for the class enrollment. If the end date is not defined in Student OEE Enrollment Data then the process uses the class end date. The start date is mandatory for a Student OEE Enrollment Data record. Note that the process uses this same OEE logic when it examines class enrollments in the following step 3, *If the FTE calculation type is Derive load from Modules*.

Calculation Steps

The following steps describe how for each selected instance the Calculate Full-Time Equivalence process calculates the FTE for the specified reporting period run parameter.

Step 1: Determine the academic career details

The process selects the following values from the associated academic career by selecting the most recent effective dated Student Program/Plan records that start on or before the reporting period end date:

- Academic Program
- Academic Load (Approved Academic Load)
- Academic Plan
- Academic Subplan

If multiple plans exist, then the process refers to the HESA Instance record to determine which plan to use. If plan is not defined, then it uses the plan with the lowest Plan Sequence value.

If multiple subplans exist with the Report to HESA setting = Y, then the process selects the subplan with the most recent Declare Date within the reporting period. If multiple records exist with the same Declare Date, then the process selects the record with the lowest subplan code ordered alphabetically.

Step 2: Determine the FTE calculation type and FTE load

After selecting the program, academic load, plan, and subplan, the Calculate Full-Time Equivalence process selects the Year of Program (YEARPRG) value from the HESA Instance record. The process determines the FTE Calculation Type and FTE Load in the following sequence:

1. If Consider Sub-Plans run parameter is selected and the HESA Sub-Plan Offering Year contains the selected subplan, academic load, and year of program, then the process selects the FTE values from the HESA Sub-Plan Offering Year. Only records in SSR_HE_SPLNOYR where Offering Start Term, Offering Start Session, Campus, Year Term and Year Session are all blank are considered.
2. If Consider Sub-Plans run parameter is selected and the HESA Sub-Plan Offering contains the selected subplan and academic load, then the process selects the FTE values from the HESA Sub-Plan Offering. Only records in SSR_HE_SPLNOFR where Offering Start Term, Offering Start Session and Campus are all blank are considered.

3. If Consider Sub-Plans run parameter is selected and the HESA Sub-Plan contains the selected subplan, then the process selects FTE values from the HESA Sub-Plan.
4. If the HESA Plan Offering Year contains the selected plan, academic load and year of program, then the process selects the FTE values from the HESA Plan Offering Year. Only records in SSR_HE_PLNOFRYR where Offering Start Term, Offering Start Session, Campus, Year Term and Year Session are all blank are considered.
5. If the HESA Plan Offering contains the selected plan and academic load, then the process selects FTE values from the HESA Plan Offering. Only records in SSR_HE_PLNOFR where Offering Start Term, Offering Start Session and Campus are all blank are considered.
6. If the HESA Plan contains the selected plan, then the process selects FTE values from the HESA Plan.
7. If the HESA Program Offering Year contains the selected program, academic load, and year of program, then the process selects FTE values from the HESA Program Offering Year.
8. If the HESA Program Offering contains the selected program and academic load, then the process selects FTE values from the HESA Program Offering.
9. If the HESA Program contains the selected program, then the process selects the FTE values from the HESA Program.
10. The process selects the Default Calculation Type run parameter value and sets the FTE Load to either 100 (if the calculation type is *Derive load from Program*) or zero (if calculation type is *Derive load from Modules*).

The following validations apply to the sequence of steps:

- If the process finds the FTE Calculation Type in any of the steps, it stops processing the subsequent steps. If the FTE Load is not defined, then the process retrieves the Calculation Type from that step, and load is set to zero. For example, in step 3, if the process finds out that the FTE Calculation Type value exists but the FTE Load value does not exist on the HESA Sub-Plan page, then it sets the FTE Load value as zero.
- If YEARPG value is zero or null in the HESA Instance record, then the process does not perform steps that match to Offering Years (Steps 1, 4, and 7).
- The FTE Load value is only required if the calculation type is *Derive load from Program*. If you selected the calculation type as *Derive load from Modules* on the data capture page, then the process automatically sets the FTE Load value as zero.

For each record, the process logs a message indicating the derived FTE Calculation Type and the step that derived the value.

Step 3: If the FTE calculation type is "Derive load from Modules"

The Calculate Full-Time Equivalence process selects class enrollments for the student.

1. The process selects activated terms for the Student Career.
2. From each selected term, it selects classes that satisfy the following conditions:
 - Class Start Date is within the reporting period, or Class End Date is within the reporting period, or Class Start Date is prior to the reporting period and Class End Date is after the reporting period.

- Status = Enrolled or Status = Dropped (if the Include Dropped Modules check box is selected on the Calculate Full-Time Equivalence page).
- Units Taken value is greater than zero.
- Grading basis value matches one of the values defined in the Grading Basis Inclusion region with the FTE check box selected on the HESA Configuration page.
- Repeat Code value is null or does not match a value defined in the Repeat Code Exclusion region with the FTE check box selected on the HESA Configuration page.
- If the student has multiple careers with the same Academic Career value as the career being processed (that is, the same career value with different career numbers), then the process applies a further filter to the class enrollments. In that case, the process selects the class only if the program value of the enrollment record matches one of the program values in the Student Program records for that career and career number.

For each class enrollment, the process finds the associated Module HESA Data record that contains the relevant Course ID/Course Offering Number. The process considers the most recent effective dated record where the effective date is not after the reporting period end date.

The process determines the FTE field value for the Module (from Module HESA Data). This value is the class FTE value (that is, Module FTE = Class FTE). If the FTE field value for the Module is not defined, then the process determines the value as zero (that is, Class FTE = 0).

If the Class Start Date is before the Reporting Period Start Date or if the Class End Date is after the Reporting Period End Date (that is, class overlaps more than one reporting period):

1. Determine the total class days from Class Start Date to Class End Date.
2. Determine the total student days for the reporting period as the number of days from the Class Start Date or Reporting Period Start Date (whichever is the latest) until the Class End Date or Reporting Period End Date (whichever is the earliest).
3. Updated Class FTE = (student days in reporting period / total class days) * Class FTE
4. If the load has been reduced (that is, total student days is less than total class days), log a message indicating that the load for that Course Offering has been reduced.

If the class enrollment status = Enrolled, then the process reduces module load where the student has discontinued or withdrawn, as described in the following steps:

1. The process selects the most recent effective dated row in the Student Program record with effective date on or before the reporting period end date.
2. If the Apportion Module Load run parameter is selected and the Student Program status is Discontinued (DC) or Leave of Absence (LA) or Cancelled (CN), then the process reduces the module FTE as described in the following steps to reflect an early leaving date:
 - a. The process determines the Student Leave Date as the effective date of the selected Student Program plan record.
 - b. The process determines the Term End Date of the class enrollment.

- c. If the Student Leave Date is null or on or after the Term End Date, then the process does not reduce the load. The process includes the full load in the total calculation.
- d. If the Student Leave Date is before the Class End Date, the process reduces the load described as follows:
 - Determine the total student days in the reporting period from Class Start Date or Reporting Period Start Date (whichever is the latest) until the Student Leave Date (not including the day of the leave date in the total).
 - Determine the total class days in the reporting period from the Class Start Date or the reporting period start date (whichever is the latest) to Class End Date or Reporting Period End Date (whichever is the earliest) .
 - Determine the Class FTE = (student days / class days) * Class FTE.
 - If the load has been reduced (that is, total student days is less than total class days), then log a message to indicate that the load for that Course Offering has been reduced.

If the parameter Apportion Module Load is not selected or status is not DC, LA, or CN, adjustment to the load for the class enrollment is not required.

If the class enrollment status = Dropped, then the process reduces module load for dropped classes based on drop date as described in the following steps:

1. The process determines the Class Drop Date from the class enrollment record.
2. If the Class Drop Date is in the reporting period and before the Class End Date, the process reduces the load described as follows:
 - a. Determine the total student days from Class Start Date or Reporting Period Start Date (whichever is the latest) until the Class Drop Date (not including the day of the drop date in the total).
 - b. Determine the total class days from Class Start Date or Reporting Period Start Date (whichever is the latest) to Class End Date or Reporting Period End Date (whichever is the earliest)
 - c. Determine the Class FTE = (student days / class days) * Class FTE

If the Class Drop Date is not in the reporting period and before the Class End Date, no reduction is required. Note that the process reduces the load for dropped classes regardless of whether the Apportion Module Load run parameter is selected or cleared. If the Class Drop Date is before the reporting period start date, update Class FTE to zero.

Calculated FTE = total of the individual module FTE values for each class enrollment (that is, FTE for each Module HESA Data record) with adjustments for discontinuation as mentioned above.

The process logs a message confirming the calculated FTE values.

Step 4: If FTE Calculation Type is "Derive load from Program," there's a Return Name, and the derived QUALCAT starts with D or L

The Calculate Full-Time Equivalence process calculates FTE load from study periods.

QUALCAT is derived in one of these ways. These are similar to some of the steps used to initially determine the FTE Calculation Type.

- If Consider Sub-Plans is Y, select QUALCAT from HESA Sub-Plan.
- Select QUALCAT from HESA Plan.
- Select QUALCAT from HESA Program.
- Derive as null.

Note: This does not consider Category values defined in Qualification Setup. For research programs, QUALCAT needs to be defined in the academic structure.

The reporting period is split into multiple periods for the student as required.

1. Period 1: Derived for all students.

a. Derive the Period Start Date in the reporting period as the most recent:

- Start Date of Instance from HESA Instance.
- Begin Date of Research Candidature (derived as per entity selection logic for Engagement).
- Reporting period start date.

The Period End Date is initially set to the reporting period end date.

b. Determine Period Mode and Status.

a. Select the latest Student Program row on or before Period Start Date that has action/reason mapped in Change of Mode mapping. Period Mode is set to the mapped Session Mode, and Period Status is set to the mapped Session Status.

b. If there's no Student Program row on or before Period Start Date that has action/reason mapped in Change of Mode mapping, the load from one of the following steps is used to set the Period Mode and Period Status values. Once the values are set, subsequent steps are not followed.

- Map the Instance Load (if defined) in the most recent HESA Instance row one or before the Period Start Date to the Session Mode and Session in Mode of Study Mapping for the Institution.
- Map the Approved Academic Load from the most recent Student Session record by session begin date for sessions that begin on or before the Period Start Date to the Session Mode and Session in Mode of Study Mapping for the Institution.
- Map the Approved Academic Load from the most recent Student Term record by term begin date for terms that begin on or before the Period Start Date to the Session Mode and Session in Mode of Study Mapping for the Institution.
- Map the Approved Academic Load from the most recent Student Program record on or before the Period Start Date to the Session Mode and Session in Mode of Study Mapping for the Institution.

- Set Session Mode to 01 (full time) and Session Status to 01 (active) as default.
- c. Assign Period 1 FTE based on Period Status and Period Mode values.
- If Status is 01 (active) and Mode is 01, 02, 03 (full time), FTE = 100.
 - If Status is 01 (active) and Mode is 31, 38 or 39 (part time), FTE = 50.
 - If Status is 04 (writing up), FTE = 10.
 - If Status is 02 (dormant), FTE = zero.
 - If Status is blank or any other value, FTE = zero.

Succeeding periods are then created in effective date order for each subsequent Student Program row where (a) the action/reason is mapped in either the Change of Mode mapping or the Reason for Ending mapping, and (b) the effective date is on or before the reporting period end date.

2. Period 2

- a. Derive Period 2 Start Date = effective date of the Student Program row.
- b. Derive Period 2 End Date = reporting period end date.
- c. Update Period 1 End Date to the day before Period 2 Start Date.
- d. If the action/reason is mapped in Change of Mode mapping:
- a. Set Period 2 Status to mapped Session Status.
 - b. Set Period 2 Mode to mapped Session Mode.
- e. If the action/reason is mapped in Reason for Ending mapping:
- a. Set Period 2 Status to 02 (dormant).
 - b. Set Period 2 Mode to blank (not needed).
- f. Assign Period 2 FTE based on Period Status and Period Mode values.
- a. If Status is 01 (active) and Mode is 01, 02, 03 (full time), FTE = 100.
 - b. If Status is 01 (active) and Mode is 31, 38 or 39 (part time), FTE = 50.
 - c. If Status is 04 (writing up), FTE = 10.
 - d. If Status is 02 (dormant), FTE = zero.
 - e. If Status is blank or any other value, FTE = zero.

The same processing is then done for any subsequently mapped Student Program rows to create Period 3, Period 4, and so on. In each case, the previous period end date is updated to be the day before the next period start date.

The Calculated FTE for the reporting period is then determined by apportioning the FTE for each period based on the start/end dates.

- Reporting period days, for example: 366 for 2023/24, 365 for 2024/25
- Period Days = days from Period Start Date to Period End Date inclusive
- Adjusted Period FTE = (Period Days/Reporting Period Days) * FTE

The Calculated FTE is then the total of all the Adjusted Period FTE values. The following tables show examples of the calculation.

This table shows the calculation for a new student moving from full time to part-time to writing up and then suspending studies.

Period	Start Date	End Date	Status	Mode	FTE	Days	Adjusted FTE
1	01-Sep-2023	30-Nov-2024	01 (active)	01 (FT)	100	91	$91/366 * 100 = 24.86339$
2	01-Dec-2023	31-Jan-2024	01 (active)	31 (PT)	50	62	$62/366 * 50 = 8.468845$
3	01-Feb-2024	31-Mar-2024	04 (writing up)	31 (PT)	10	60	$60/366 * 10 = 1.639344$
4	01-Apr-2024	31-Jul-2024	02 (dormant)	-	0	121	$121/366 * 0 = 0$
							FTE 2023/24 = 35.0

This table shows the calculation for a continuing PT student completing on November 23, 2023.

Period	Start Date	End Date	Status	Mode	FTE	Days	Adjusted FTE
1	01-Aug-2023	22-Nov-2023	01 (active)	31 (PT)	50	114	$114/366 * 50 = 15.57377$
2	23-Nov-2023	31-Jul-2024	02 (dormant)	-	0	252	$252/366 * 0 = 0$

Period	Start Date	End Date	Status	Mode	FTE	Days	Adjusted FTE
							FTE 2023/24 = 15.6

This table shows the calculation for a new 2-year FT student starting in November and continuing into the subsequent reporting periods.

Period	Start Date	End Date	Status	Mode	FTE	Days	Adjusted FTE
1	01-Nov-2023	31-Jun-2024	01 (active)	01 (FT)	100	274	$274/366*100$ = 74.86339
							FTE 2023/24 = 74.9
1	01-Aug-2024	31-Jul-2025	01 (active)	01 (FT)	100	365	$365/365*100$ = 100
							FTE 2024/25 = 100
1	01-Aug-2025	30-Oct-2025	01 (active)	01 (FT)	100	91	$91/365*100$ = 24.93151
2	01-Nov-2025	31-Jul-2026	04 (dormant)	-	-	-	0
							FTE 2025/26 = 24.9

Step 5: If FTE Calculation Type is "Derive load from Program"

If the FTE Calculation Type = Derive load from Program and FTE has *not* been calculated from study periods (step 4), the Calculate Full-Time Equivalence process uses the FTE Load derived from the academic structure.

1. The process selects the most recent effective-dated row in the Student Program record whose effective date is on or before the reporting period end date.
2. If the status is not Discontinued (DC), Leave of Absence (LA) or Cancelled (CN), then the Calculated FTE = FTE Load.

3. If the status is Discontinued (DC), Leave of Absence (LA), or Cancelled (CN), the process apportions the load according to date of discontinuation/leave/withdrawal.
 - a. The process determines the full teaching period for the Academic Calendar with reference to each of the terms associated with the calendar and the reporting period (that is the term is associated with Academic Calendar run parameter and the Term Begin Date falls in the reporting period). Then, the process sets Teaching Start Date = the earliest Term Begin Date and Teaching End Date = the latest Term End Date.
 - b. The process determines the Student Days as being from the Teaching Start Date until the Effective Date of the discontinuation, leave of absence or withdrawal.
 - c. The process determines the Teaching Days as being from the Teaching Start Date to the Teaching End Date
 - d. Calculated FTE = FTE Load * (Student Days / Teaching Days)
 - e. The process logs a message indicating the calculated FTE value after discontinuation or leave of absence.

Step 6: Store the calculated FTE

The Calculate Full-Time Equivalence process stores the calculated FTE in the HESA Instance record.

1. If the Maximum Calculated Value run parameter value is specified and the Calculated FTE value is greater than the parameter value, then the process replaces the Calculated FTE value with the Maximum Calculated Value when the value is stored in the HESA Instance record.
2. If the most recent effective-dated HESA Instance record has an effective date before the reporting period start date and that effective date is before January 1 of the start year of the reporting period (for example, prior to 1-Jan-2023 for the 2023/24 calculation), the process performs the following steps:
 - a. The process creates a new effective dated-record using the Reporting Period Start Date.
 - b. The process copies all the fields and child entities from the previous row except for these items:
 - These header record fields (SSR_HE_INSTANCE):
 - Current Term (STRM)
 - Session Start Date (SSR_HE_SESS_START)
 - Current Session Year (SSR_HE_SESYR_ID)
 - Actual Session End (SSS_HE_ACT_SESEND)
 - Expected Session End (SSR_HE_EXP_SESEND)
 - FTE Details records (SSR_HE_INST_FTE)
 - c. If the Increment Year of Program run parameter is selected and the existing record has a Year of Program value less than 99, then the process increments the Year of Program value by one in the new record.

3. The process selects the most recent effective dated HESA Instance record that starts on or before the reporting period end date (that is, the process selects either the newly created record above or the existing record that starts within the reporting period).
4. If the effective date is before January 1 of the end year of the reporting period (for example, prior to 1-Jan-2024 for the 2023/24 calculation) or the effective date is January 1 or later (e.g. 01-Jan-2024 onwards for 2023/24), and there is no previous HESA Instance row (i.e. new mid-year student):
 - If there is an existing FTE record for the reporting period (in PS_SSR_HE_INST_FTE), the process updates the Calculated FTE value of the existing record.
 - If FTE record does not exist for the reporting period, the process creates a new FTE record using the Reporting Period and Calculated FTE values.
5. If the effective date is January 1 or later and there's a previous HESA Instance row, the process splits the calculated FTE between the 2 HESA Instance records based on the number of days in the reporting period.
 - For the HESA Instance with effective date in the reporting period (i.e. the current SCS), the number of days between the effective date and the reporting period end date (for example, 12-Feb-2024 to 31-Jul-2024 = 171 days) is divided by the total number of days in the reporting period, and the Calculated FTE is then split between the current and previous SCS.
 - Current SCS FTE = (number of days in reporting period/reporting period days) * Calculated FTE.

For example, the HESA Instance for the current SCS starts on 12-Feb-2024, then 171 days are in the 2023/24 reporting period till 31-July-2024. There are 366 days in the 23/24 reporting period.

 $171/366 * 100 = 46.72131$
 - Previous SCS FTE = Calculated FTE – Current SCS FTE

Example: The FTE for the current SCS is subtracted from the 100 total of the previous SCS.

 $100 - 46.72131 = 53.27869$
 - For the HESA Instance with effective date in the reporting period (i.e. Current SCS), if there's an existing FTE record for the reporting period (in SSR_HE_INST_FTE), the process updates the Calculated FTE value of the existing record to the Current SCS FTE. Otherwise, it creates a new FTE record using the Reporting Period and Current SCS FTE.
 - For the HESA Instance with effective date prior to the reporting period (i.e. Previous SCS), if there's an existing FTE record for the reporting period (in SSR_HE_INST_FTE), the process updates the Calculated FTE value of the existing record to the Previous SCS FTE. Otherwise, it creates a new FTE record using the Reporting Period and Previous SCS FTE.
6. If the most recent effective-dated HESA Instance record has an effective date before the reporting period start date, and the effective date is January 1 or later for the start year of the reporting period (e.g. 01-Jan-2023 onwards for 2023/24), if there's an existing FTE record for the reporting period (in SSR_HE_INST_FTE), the process updates the Calculated FTE value of the existing record. Otherwise, it creates a new FTE record using the Reporting Period and Calculated FTE value.

When existing FTE records are updated, the process retains any existing Override FTE and Report Zero setting values.

When new FTE records are created, the process sets the Override FTE value to zero and the Report Zero setting is not selected. The process uses the Override FTE value only if the value is greater than zero. The Report Zero check box is provided in the HESA Instance page to allow a zero override to be applied to the extract. If the calculated FTE values is greater than 100 and the institution wants the return STULOAD as 100, then you can use the HESA Instance page to manually add an Override FTE value of 100.

Entering HESA Advisor Data for a Student

Access the Advisor HESA Data page (**Curriculum Management > Instructor/Advisor Information > Instructor/Advisor Table > Advisor HESA Data**).

This example illustrates the fields and controls on the Advisor HESA Data page. You can find definitions for the fields and controls later on this page.

You can enter a maximum of six units. The total percentage for the six subjects must equal 100.

The combination of REF Unit and RAE Unit must be unique and at least one value must be defined along with Percentage to save a record.

Field or Control	Description
Collaborating Provider	This field is optional. Use this field to record a UKPRN value or one of the generic codes provided by HESA. For example, 4002,4003, or 4004. Note: HESA does not provide the UKPRN code in the CodeLists.xsd so a prompt is not available for this field.

Entering HESA Data for an External Organization

Access the Regional page (**Campus Community > Organization > Create/Maintain Organizations > Organization Table > Regional**).

Field or Control	Description
Previous Degree Establishment	Enter a value that the system can use derive the Student. DEGEST value for ITT Return

Entering DEGTYPE Value

Access the Degree Table page (**Set Up SACR > Foundation Tables > Academic Structure > Degree Table**).

<i>Field or Control</i>	<i>Description</i>
Previous Degree Type	Enter a value that the system can use to derive the Student. DEGTYPE value for ITT return.

Preparing for Generating Graduate Outcomes Return

This section provides an overview of processing Graduate Outcomes return and discusses how to:

- Import the target population
- Review and update imported survey data in staging table
- Add, view, and update surveys

Pages Used to Prepare for Generating Graduate Outcomes Return

<i>Page Name</i>	<i>Definition Name</i>	<i>Navigation</i>	<i>Usage</i>
Import Target Population	SSR_HE_IMP_TPOP	Records and Enrollment > HESA Reporting > Graduate Outcomes > Import Target Population	Run the process to import the target population.
Survey Management	SSR_HE_SURV_MGMT	Records and Enrollment > HESA Reporting > Graduate Outcomes > Survey Management	Allows users to retrieve existing records, update the record, navigate to further detailed page, or navigate to add a new survey.
Add a Survey	SSR_HE_SURV_ADD	Click the Add Survey button on the Survey Management page.	Supplementary page to allow users to manually add a new survey record.
Survey Details	SSR_HE_SURV_DTLS	Click the Details button on the Survey Management page.	Supplementary page to view further details of a survey and to add or update coded values required for the HESA extract.

Importing the Survey Target Population

Access the Import Survey Target Population page (**Records and Enrollment > HESA Reporting > Graduate Outcomes > Import Target Population**).

<i>Field or Control</i>	<i>Description</i>
Return Name	Select a return.
Survey	<p>(Optional) For Graduate Outcomes, select any one of the following:</p> <ul style="list-style-type: none"> • December Survey • March Survey • June Survey • September Survey
XML Path/File Name	Enter the file path and file name that you want the system to import.
Add Attachment	<p>Click to browse to the XML file that HESA provides, and click Upload. You can browse your local drive and select a file.</p> <hr/> <p>Note: The upload process creates a files subdirectory to store and process the XML file. This subdirectory is created in the server directory location that is specified in the PS_SERVDIR system parameter in the Application Server/Process Scheduler configuration file psappsrv.cfg/psprcs.cfg. Ensure that PS_SERVDIR is set up with an appropriate value in the configuration file and that users have the correct permission to access the files subdirectory.</p>
Create New Surveys	<p>Select if you want the import process to create blank survey records for students in the population file who do not currently have a survey record.</p> <p>For Graduate Outcomes return, this check box is selected by default.</p>
Exclude Surveys	<p>Select if you want the process, at the end of processing the incoming population file, to set the Survey Status to <i>Excluded</i> for any existing survey records where the student is not included in the population.</p> <p>For Graduate Outcomes return, this check box is selected by default.</p>

Field or Control	Description
Overwrite Values	<p>Select if you want the process to overwrite key values in the survey with the incoming values when the incoming student is matched to an existing survey record. These key values are HUSID, NUMHUS, COURSEID, MODE and TTCID.</p> <p>For Graduate Outcomes return, this check box is selected by default.</p>

Use the Student Override region to specify single or multiple students for whom the process imports the record and creates a survey.

Processing Steps

The import process can use the population file for the Graduate Outcomes Contact Details return.

The process clears existing staging table records, opens the XML file and imports records into the staging table.

If you provide the Student Override parameter value, then the process imports into the staging table only the records where the OWNSTU value matches one of the specified EMPLID (person ID) values.

If the Survey field is blank, all the records in the XML file are imported to the staging record. Otherwise, records where the CENSUS value matches the Survey parameter are imported into the staging record.

For each staging record, the process matches to a single HESA Instance record based upon the following values:

- Academic Institution
- EMPLID: from OWNSTU in the target list record.
- Instance Identifier: from NUMHUS in the target list record.

If the process finds multiple HESA instance records, it selects the most recent effective dated record. For each HESA instance record, it selects the most recent effective dated record on or before the reporting period end date. If there is no existing survey for the combination of Institution, EMPLID, Academic Career, Student Career Number, Return Name and Survey, then the process creates a new record. The process then sets the Survey Source to *P*. If there is an existing survey, it updates the record. If any of the values for HUSID, NUMHUS, COURSEID, MODE and TTCID are different in the staging record from the existing survey record then if the Overwrite Values check box is selected, the process updates those values in the survey record.

Create New Surveys check box processing: If there is no existing survey for the combination of Institution, EMPLID, Academic Career, Student Career Number, Return Name and Survey, then the process creates a new survey record for the student using the values described in the following table:

Column Name	Value
INSTITUTION	Academic institution from the HESA instance record.

Column Name	Value
EMPLID	EMPLID from imported OWNSTU value.
ACAD_CAREER	Academic Career from the HESA Instance record.
STDNT_CAR_NBR	Student Career Number from the HESA Instance record.
SSR_HE_RET_NAME	HESA return name from the process parameter.
SSR_HE_APRJAN	<p>Imported CENSUS values are converted to translate field value by matching the translate short name:</p> <ul style="list-style-type: none"> • Dec = <i>A</i> • Mar = <i>B</i> • Jun = <i>C</i> • Sep = <i>D</i> <p>If a translate does not match with a short translate value, the default value becomes X. If multiple translate values are set up with the same short translate value, one is randomly selected.</p>
SSR_HE_SURV_STATUS	Set to <i>N</i> for new survey records.
SSR_HE_SOURCE	Set to <i>P</i> for Import Survey Target Population process.
SSR_HE_HUSID	HUSID value from the import file.
SSR_HE_NUMHUS	NUMHUS value from the import file.
SSR_HE_COURSEID	COURSEID value from the import file.
SSR_HE_MODE	MODE value from the import file.
SSR_HE_TTCID	TTCID value from the import file.
SSR_HE_QTS_FLAG	If the imported TTCID = 1, 8, or G, then set to <i>Y</i> , else set to <i>N</i> .
SSR_HE_GRADSTATUS	If Date of Death is populated for the EMPLID (PERSON.DT_OF_DEATH), the field is set to 01, else set to blank.

Column Name	Value
SSR_HE_FNAMES	FNAMES value from the import file.
SSR_HE_SURNAME	SURNAME value from the import file.
SSR_HE_HOMEEUOS	HOMEEUOS value from the import file. The value is used to identify overseas students in some of the field derivations.
SSR_HE_METHOD	Set to blank.
All other surveys fields	Set to blank or zero.

If the Create New Surveys check box isn't selected, then the process doesn't create a new survey and logs a *survey not created* message.

Exclude Surveys check box processing: For each survey record for the Academic Institution, Return Name and Survey where Source (SSR_HE_SOURCE) is *I* or *M* (Identify Target Population or manually added) and Survey Status is not *E* or *D* (excluded or duplicate) and EMPLID doesn't appear in the staging records for the institution/survey, the process updates the Survey status to *E* (excluded) and logs an excluded survey message.

For Graduate Outcomes, because the Survey parameter can be blank and the staging table can include records for different surveys, the exclude processing is done for each distinct survey value that appears at least once in the staging record. For example, if the staging records contain just surveys for “Dec” and APRJAN = A, then only existing surveys for APRJAN = A that don't also appear in the staging record with APRJAN = A are excluded. Processing isn't done for existing survey records with any other APRJAN value. If the staging records contain surveys for “Mar” and “Jun,” then the exclude processing is done for existing survey records with APRJAN = B and C, but not for existing survey records for APRJAN = A or D and so on.

Note: The exclude survey processing ignores surveys that have already been created or updated by the Import Survey Target Population process where the source has been set to *P* and surveys that have been created by the Import Survey Data process where source has been set to *H*. The check on the EMPLID in the staging records is included to ensure surveys are not excluded where there is a pending staging record and the source has not yet been updated to *P* (for example, when the HESA Instance record is not found).

Adding, Viewing, and Updating Surveys

Access the Survey Management page (**Records and Enrollment > HESA Reporting > Graduate Outcome > Survey Management**).

The Survey Management page enables users to retrieve existing survey records and either update the record on the page, navigate to a further detailed survey update page, navigate to the self-service DLHE Survey pages, or navigate to add a new survey. You can also use this page to view records created from the Graduate Outcomes population file as well as excluding records from the extract by setting the field **Survey Status** to *Excluded*.

Field or Control	Description
Survey Status	Select the current status value of the survey from the possible translate values defined as Coded, Duplicate, Excluded, New, Saved or Submitted.
Add Survey	Click to access the Add a Survey page where you can add a new survey record.
Details	Click to access the Survey Details page where you can review further details of the survey and add codes where required.

You can use the Survey Management page to edit the surveys created by the Import Survey Target Population process or manually created.

Adding a Survey

Access the Add a Survey page (Click the **Add Survey** button on the Survey Management page).

Field or Control	Description
Survey	Select the survey translate value for Graduate Outcomes: <ul style="list-style-type: none"> • December Survey • March Survey • June Survey • September Survey
ID	Select person ID of the student for which the survey should be created.
Academic Career	Select the career for the selected person ID.
Mode of Study	Select an Instance.MODE code.

You can use this page to create a new survey rather than using the Import Survey Target Population process. The student must have an SID external system ID before you can add a survey. An SID ID type must be entered in the External System field of the HESA Configuration page.

Viewing or Updating Survey Details

Access the Survey Details page (Click the **Details** button on the Survey Management page).

You can use the Survey Details page to view further details of a particular survey record and to add or update coded values required for the HESA extract of survey data.

Field or Control	Description
Survey Status	Select the current status value of the survey from the possible translate values defined as <i>Coded</i> , <i>Duplicate</i> , <i>Excluded</i> , <i>New</i> , <i>Saved</i> or <i>Submitted</i> .
Graduate Status	By default, this field is blank or set to <i>01</i> . You can add or update the value for the extract. If a graduate doesn't have any email or phone records in Contact details, you can set this field to <i>02</i> .
Delete	<p>Click to delete the survey.</p> <p>The system enables this button only if the Survey Status is <i>New</i>. If the status isn't <i>New</i> and you want to delete a survey record: change the status to <i>New</i>, save the record, return to the Survey Management page, click the Details button to access the same record, and then click the Delete button.</p> <p>When you delete a survey, the Survey Management page appears with the search results. The deleted survey will remain in these search results until you click the Search Surveys button again.</p>

Supplied Fields

This region displays the imported values from the Graduate Outcomes survey record. You can edit this region to add missing values for survey records that are manually added.

Contact Details

This region displays email addresses, telephone, and address records from the Graduate Outcomes survey record. Use this region to review data that may be extracted. This view is not filtered so all current records for the graduate appear.

Generating a HESA Return and Creating a Return File

This section provides an overview of generating a HESA return and creating a return file and discusses how to:

- Import the HIN Target List.
- Generate a HESA extract.
- Review the extract data.
- Create a XML return file.
- Validate a XML return file.
- Review submitted data.

Understanding Generating a HESA Return and Creating a Return File

After entering the data that you want to report to HESA at the various data capture levels, use the Create Extract process to generate the HESA return data. The return data is composed of extracts of various entities.

Before you generate the return data file, you can use the Extract Data pages to review and edit the HESA extracts that the Create Extract process generates.

After reviewing the data for the Student, Offshore, ITT, Unistats/KIS, or DLHE return, use the Create XML Application Engine (SSR_HE_GXML) process to generate the XML file for the return. After the process generates the XML file, validate the file against the schema (not including the HESA business rules) using the Validate XML Application Engine (SSR_HE_VXML) process. You can review the errors reported by the Validate XML process, correct the errors, and rerun the extract process using the same or revised extract criteria.

You can validate the XML files both against the schema and the HESA business rules using the HESA Validation Kit. The HESA Validation Kit generates an error file that you can import into a Campus Solutions staging table. Once the records are imported, re-run the Create Extract process just for those records with validation errors. You can review these error records using the Extract Data pages, correct the errors, and rerun the extract process using the same or revised extract criteria.

When the full return passes the HESA validation, submit the XML file to HESA.

Note: You must run the Create HESA Instance process before running the Create Extract process.

After the academic institution has submitted the Student return, HESA provides a target list for the next reporting period. This target list includes all instances that are incomplete or not reported as dormant in the current reporting period. HESA requires that an Instance entity be reported for all these students in the next reporting period. Use the Import HIN Target List Application Engine (SSR_HE_IMPFI) process to import the target list and select the HESA Instance records that must be included in the next year's Student return.

Pages Used to Generate a HESA Return and Create a Return File

<i>Page Name</i>	<i>Definition Name</i>	<i>Navigation</i>	<i>Usage</i>
Import Target Population	SR_HE_HIN_RC	Records and Enrollment > HESA Reporting > Extract Processing > Import Target Population	Import the target population and select the HESA Instance records that the institution must include in the next year's Student return.
Create Extract Data	SSR_HE_EXT_PRC_RC	Records and Enrollment > HESA Reporting > Extract Processing > Create Extract	Generate return data. See Understanding HESA Derivation Steps

Page Name	Definition Name	Navigation	Usage
Institution Extract Data	SSR_HE_INSTITU_EXT	Records and Enrollment > HESA Reporting > Extract Data > Institution Extract Data	Review the Institution entity data that the Create Extract process generates. You can review the Institution entity data for Aggregate Offshore, Student, DLHE, Unistats/KIS and ITT returns.
DLHE Extract Data	SSR_HE_DLHE_EXT	Records and Enrollment > HESA Reporting > Extract Data > DLHE Survey Data	Review the Survey entity data that the Create Extract process generates.
Module Extract Data	SSR_HE_MOD_EXT	Records and Enrollment > HESA Reporting > Extract Data > Module Extract Data	Review the Module and Module Subject entity data that the Create Extract process generates.
Course Extract Data	SSR_HE_CRS_EXT	Records and Enrollment > HESA Reporting > Extract Data > Course Extract Data	Review the Course and Course Subject entity data and the KISCourse entity data that the Create Extract process generates.
Student Extract Data	SSR_HE_STUD_EXT	Records and Enrollment > HESA Reporting > Extract Data > Student Extract Data	Review the data that the Create Extract process generates for a student.
Instance Extract Data	SSR_HE_INST_EXT	Records and Enrollment > HESA Reporting > Extract Data > Student Extract Data > Instance Extract Data	Review the Instance, Student On Module, Entry Profile, Qualifications On Entry, Qualifications Awarded, and RAE entity data that the Create Extract process generates for a student.
Provision Extract Data	SSR_HE_PROV_EXT	Records and Enrollment > HESA Reporting > Extract Data > Provision Extract Data	Review the Provision entity data that the Create Extract process generates for a student's Aggregate Offshore return.
ITT Extract Data	SR_HE_ISTUD_EX	Records and Enrollment > HESA Reporting > Extract Data > ITT Extract Data	Review the Student and Course Subject entity data that the Create Extract process generates for a student's ITT return.

Page Name	Definition Name	Navigation	Usage
Course Submitted Data	SSR_HE_MST_CRSE	Records and Enrollment > HESA Reporting > Submitted Data > Course Submitted Data	Review submitted data.
Institution Submitted Data	SSR_HE_MST_INST	Records and Enrollment > HESA Reporting > Submitted Data > Institution Submitted Data	Review submitted data.
Module Submitted Data	SSR_HE_MST_MODE	Records and Enrollment > HESA Reporting > Submitted Data > Module Submitted Data	Review submitted data.
Purge Submitted Data	SSR_HE_DELM_RC	Records and Enrollment > HESA Reporting > Submitted Data > Purge Submitted Data	Purge older records of submitted data.
Qualification Submitted Data	SSR_HE_MST_QUAL	Records and Enrollment > HESA Reporting > Submitted Data > Qualification Submitted Data	Review submitted data.
Session Year Submitted Data	SSR_HE_MST_SESS	Records and Enrollment > HESA Reporting > Submitted Data > Session Year Submitted Data	Review submitted data.
Student Submitted Data	SSR_HE_MST_STDN	Records and Enrollment > HESA Reporting > Submitted Data > Student Submitted Data	Review submitted data.
Venue Submitted Data	SSR_HE_MST_VENU	Records and Enrollment > HESA Reporting > Submitted Data > Venue Submitted Data	Review submitted data.

Page Name	Definition Name	Navigation	Usage
Create XML	SSR_HE_GXML_RC	Records and Enrollment > HESA Reporting > Extract Processing > Create XML	Create the XML file for HESA submission.
HESA Validate XML	SSR_HE_VXML_RC	Records and Enrollment > HESA Reporting > Extract Processing > Validate XML	Validate the XML file generated by the Create XML process.

Importing the Target Population

Access the Import Target Population page (**Records and Enrollment** > **HESA Reporting** > **Extract Processing** > **Import Target Population**).

Before you run the process, ensure the following exist:

- HESA Instance records. These record contain the Population Year field to store the reporting year value.
- Instance Identifier values in the HESA Instance records must match the NUMHUS values in the target list file.
- EMPLID values must match the OWNSTU values in the target list.

Field or Control	Description
Increment Year of Program	Select to increment the Year of Program value by one when the Import Target List process creates a new effective dated HESA Instance record for the reporting period.

The Add Attachment button and XML Path/File Name field are similar to the same button and field on the [Import Survey Target Population](#) page. You can now import CSV files. The import process ignores the header row of the CSV file. Take note that the file name character limit is 60, so you might have to edit the file name before importing.

The other actions on this page (other than the Increment Year of Program checkbox) are similar to the check boxes on the [Calculate Year of Student](#) page. Qualifications Awarded, Award Accreditation, and Off Venue Activity have been added for Data Futures.

The Import Target List process sets the Population Year of the instance records to the reporting year value of the reporting period parameter. This enables the Create Extract process to identify the instance records for the next reporting year. For example, when you run the Import Target List process with a reporting period parameter set to 2023/24, the process sets a student's Population Year to 2023. Subsequently, when you run the Create Extract process for the reporting period 2023/24, the Population Year of the student matches the reporting year of the reporting period, and therefore the Create Extract process automatically includes the Instance entity of the student regardless of other criteria.

The following steps describe the Import Target List process:

1. The Import Target List process imports the target list into the staging tables.
2. For each staging record, the process finds HESA Instance records in Campus Solutions database by matching the academic institution (provided as the run parameter), EMPLID (provided as OWNSTU in the target list record), and Instance Identifier (provided as NUMHUS in the target list record). This may mean multiple records are picked up for the same Instance Identifier.
3. The process logs messages for those records that do not have a matching HESA Instance record. The process retains the unmatched record in the staging table.
4. If the most recent effective dated HESA Instance record has an effective date before the reporting period start date:
 - a. The Import Target List process creates a new effective-dated record using the reporting period start date. It copies all the data from the following records to the new effective dated record: Header record (SSR_HE_INSTANCE), Entry Profile fields (SSR_HE_INST_FLD where SSR_HE_ENTR_FLAG = Y), Entry Qualifications (SSR_HE_QUAL_ENT), Employment Status (SSR_HE_INST_EST), Employment Monitoring (SSR_HE_INST_MON), Learner (SSR_HE_INST_LRN), and Learning Delivery (SSR_HE_INST_LDL). But these fields aren't copied: Session Start Date, Current Term, Current Session Year, Actual Session End, and Expected Session End.

The Instance Details fields (SSR_HE_INST_FLD where SSR_HE_ENTR_FLAG = N), including the Further Education Instance fields, are copied only if you have selected the Copy Instance Details check box.

The Qualifications Awarded (SSR_HE_QUAL_AWD) records are copied only if you have selected the Copy Qualifications Awarded check box.

The Research Data (SSR_HE_INST_RES) records are copied only if you have selected the Copy Research Data check box.

The FTE Details (SSR_HE_INST_FTE) records are copied only if you have selected the Copy FTE Details check box.
 - b. The process sets the Population Year to the reporting year value of the reporting period parameter.
 - c. If the Increment Year of Program run parameter is selected and the existing record has a Year of Program value greater than zero, then the process increments the year of program by one in the new record.
5. If a HESA Instance record starts within the reporting period, the process sets the Population Year of the existing record to the reporting year value of the reporting period parameter.

Generating a HESA Extract

Access the Create Extract Data page (**Records and Enrollment > HESA Reporting > Extract Processing > Create Extract**).

This example illustrates the fields and controls on the Create Extract Data page. You can find definitions for the fields and controls later on this page.

Create Extract Data

Run Control ID: DF
Report Manager Process Monitor
Run

Return

*Academic Institution PeopleSoft University UK

Return Type Student Return (Data Futures)

*Return Name

Retain Data from Previous Run

Compare Extract with Submitted

Course/Module

Academic Career

Include Course Entities

Flag Unused Courses

Flag Unused Session Years

Null Errors Only

Flag Unused Qualifications

Flag Unused Venues

Validation Errors Only

Academic Plan

Academic Sub-Plan

Include Module Entities

Flag Unused Modules

Null Errors Only

Validation Errors Only

Course ID

Course Offering Nbr

Student

Include Student Entities

HIN Population Only

Null Errors Only

Validation Errors Only

Student Override

Student Override

Field or Control	Description
Return Type	Enter a return type to filter the list of available returns in the Return Name field.
Return Name	Enter the return for which the process should generate the reporting data. You set up a return using the Returns Setup component.
Retain Data from Previous Run	Select to have the Create Extract process delete the existing inactive data, update the existing active data to inactive, and to extract new data. If the check box is deselected, then the process deletes all the existing data (both active and inactive) records and extracts the new data.

Field or Control	Description
Compare Extract with Submitted Data	<p>When you select this checkbox, the Create Extract Data process compare extract records with the most recent set of submitted data records. And then the process updates the Entity Status and Field Status values.</p> <p>You can skip the comparison by deselecting the checkbox. When the derived value in the extract is NULL ERROR, Field Status is set to ERROR. When the derived value is not blank, then Field Status is set to New. The Entity Status is set to ERROR when there's at least one field whose Field Status in the extract is also "Error." Otherwise, Entity Status is set to New.</p>

The fields on this page are available for entry depending on the return you select. For example, the system disables the Course/Module, Student, and Student Override regions for an Aggregate Offshore return. If the return is Graduate Outcomes, only the Null Errors Only and Validation Errors Only check boxes in the Student region and the Student Override region are available.

Survey Details

Use this region to select which survey records are included in the extract. Each check box is enabled only if the corresponding Survey value is defined for the return. You can run the extract process for only one Graduate Outcomes survey at a time.

If only one survey is defined for the return, that survey check box is selected by default and the other check boxes are disabled. If more than one survey is defined, then all the check boxes are enabled and default to the deselected state. You must select at least one check box to run the process. When you select a check box, other check boxes that are currently selected are automatically deselected.

Course/Module

Use this region to include or exclude the Course and Module entity data in the Student return. Also, you can use the region to restrict the Course and Module entity data in the Student return. For example, you can specify that the process should create Course data for all the courses in the undergraduate career and Module data for a Biochemistry course offering in the undergraduate career.

Also, use this region to include or exclude the KISCourse entity data in the Unistats/KIS return.

You can use this region only for Student and Unistats/KIS returns. It's not applicable to ITT, Offshore, and Graduate Outcomes returns.

Field or Control	Description
Academic Career	<p>Select to restrict the Course and Module extracts of the Student return to a particular career.</p> <p>This check box is not applicable for Unistats/KIS return.</p> <hr/> <p>Note: If you select an academic career, the process will restrict the Instance extract in the Student return based on the selected career because the process creates Instance records only if the plan or subplan is already included in the Course extract.</p> <hr/> <p>The system enables the Academic Career field only if you select either the Include Course Entities check box or the Include Module Entities check box. However, if you select either the Null Errors Only check box or the Validation Errors Only check box, the system disables this field.</p>
Include Course Entities	<p>Select to include the Course and Course Subject extracts in the Student return.</p> <p>Select to include KISCourse extract in the Unistats/KIS return.</p>
<p>Flag Unused Courses</p> <p>Flag Unused Session Years</p> <p>Flag Unused Qualifications</p> <p>Flag Unused Venues</p>	<p>These options are available only when the return type is Data Futures.</p> <p>If Include Course Entities is selected, then these options are also selected by default.</p> <p>These are the conditions that the Create Extract Data process follows to update the Entity Status to <code>Unused</code>. This applies to records that aren't being used in the corresponding student extract data.</p> <ul style="list-style-type: none"> • If Flag Unused Courses is selected and the Course ID doesn't exist in the Student Course Session extract data. • If the Flag Unused Qualifications is selected and the Qualification ID doesn't exist in either the Course extract data (when the Entity Status isn't <code>Unused</code>) or the Qualification Awarded extract data. • If the Flag Unused Session Years is selected and the Session Year ID doesn't exist in the Student Course Session extract data. • If the Flag Unused Venues is selected and the Venue ID doesn't exist in the Study Location extract data. <p>Note that for entities that have data errors and aren't used, the process will update the Entity Status from <code>Error</code> to <code>Unused</code>.</p>

Field or Control	Description
Null Errors Only	<p>Select to restrict the Course or KISCourse extract to those records where a <i>NULL ERROR</i> value has been derived in the previous run of the process.</p> <p>You cannot select both the Null Errors Only and Validation Errors Only check boxes for the Course entity.</p>
Validation Errors Only	<p>Select to restrict the Course or KISCourse extract to those records where the HESA Validation Kit has identified a validation error and the error details have been imported to the validation staging table.</p>
Academic Plan	<p>Select to restrict Course or KISCourse extract to a particular plan.</p> <p>The system enables this field only if the Include Course Entities check box is selected and both the Null Errors Only and Validation Errors Only check boxes are cleared.</p> <p>All active academic plans are available for selection. Ensure that the Report to HESA check box is selected on the Plan HESA Data page for the plan you have selected.</p>
Academic Sub-Plan	<p>Select to restrict Course or KISCourse extract to a particular subplan.</p> <p>The system enables this field only if the Include Course Entities check box is selected and both the Null Errors Only and Validation Errors Only check boxes are cleared.</p> <p>All active academic subplans are available for selection. Ensure that the Report to HESA check box is selected on the Sub-Plan HESA Data page for the subplan you have selected. Also, select the Enable Sub-Plan Reporting check box on the HESA Returns page if you want to report subplan data.</p>
Include Module Entities	<p>Select to include the Module and Module Subject extracts.</p> <p>This check box is not applicable for Unistats/KIS return.</p>
Flag Unused Modules	<p>This option is available only when the return type is Data Futures.</p> <p>If Include Module Entities is selected, then this option is also selected by default. When Flag Unused Modules is selected and the Module ID doesn't exist in the Module Instance extract data, the Entity Status is updated to <i>Unused</i>.</p>

Field or Control	Description
Null Errors Only	<p>Select to restrict the Module extract to those records where a <i>NULL ERROR</i> value has been derived in the previous run of the process.</p> <p>You cannot select both the Null Errors Only and Validation Errors Only check boxes for the Module entity.</p>
Validation Errors Only	<p>Select to restrict the Module extract to those records where the HESA Validation Kit has identified a validation error and the error details have been imported to the validation staging table.</p>
Course ID and Course Offering Nbr	<p>Select to restrict the Course entity data to a particular course.</p> <p>If you select a Course ID or Course Offering Number, the process creates Module and StudentOnModule data for only the selected values.</p> <p>All active courses are available for selection. Ensure that the Report to HESA check box is selected on the HESA Module Data page for the course ID and course offering number you have selected.</p> <p>The system enables this field only if the Include Module Entities check box is selected and both the Null Errors Only and Validation Errors Only check boxes are cleared.</p>

Student

Use this region to include or exclude the student-related entity data in the return. Also, you can use the region to restrict the student-related entity data. Examples of student-related entities include Instance, Student, and Entry Profile entities.

This region is not applicable for Unistats/KIS return.

Field or Control	Description
Include Student Entities	<p>Select to include the student-related extracts.</p> <p>The system enables this check box for only Student returns. For DLHE and ITT, the Create Extract process automatically includes the student-related entity data.</p>

Field or Control	Description
HIN Population Only	<p>Select to restrict the Instance extract to only those continuing students whose HIN Population Year value in the HESA Instance record matches the Reporting Period Year.</p> <p>The system enables this check box for only Student returns.</p> <p>Note that this check box affects only continuing students and does not affect new students.</p>
Null Errors Only	<p>Select to restrict returns to those students where a <i>NULL ERROR</i> value has been derived in one of the student-related entities during a previous run of the process.</p> <p>You cannot select all three check boxes — Null Errors Only, Validation Errors Only, and Student Overrides — for the student-related entities. Only one check box can be selected.</p> <p>The system enables this check box for only Student, ITT, and DLHE returns.</p>
Validation Errors Only	<p>Select to restrict the student-related entities in the extract to those records where the HESA Validation Kit has identified a validation error and the error details have been imported to the validation staging table.</p> <p>You cannot select all three check boxes — Null Errors Only, Validation Errors Only, and Student Overrides — for the student-related entities. Only one check box can be selected.</p> <p>The system enables this check box for only Student and ITT returns.</p>

Student Override

Use this region to specify a single or multiple students for whom the process should generate the return data.

The system enables the Student Override check box for only Student, ITT, and DLHE returns.

Processing Diagram

The following diagram describes how the Create Extract process creates the entities for a student return:

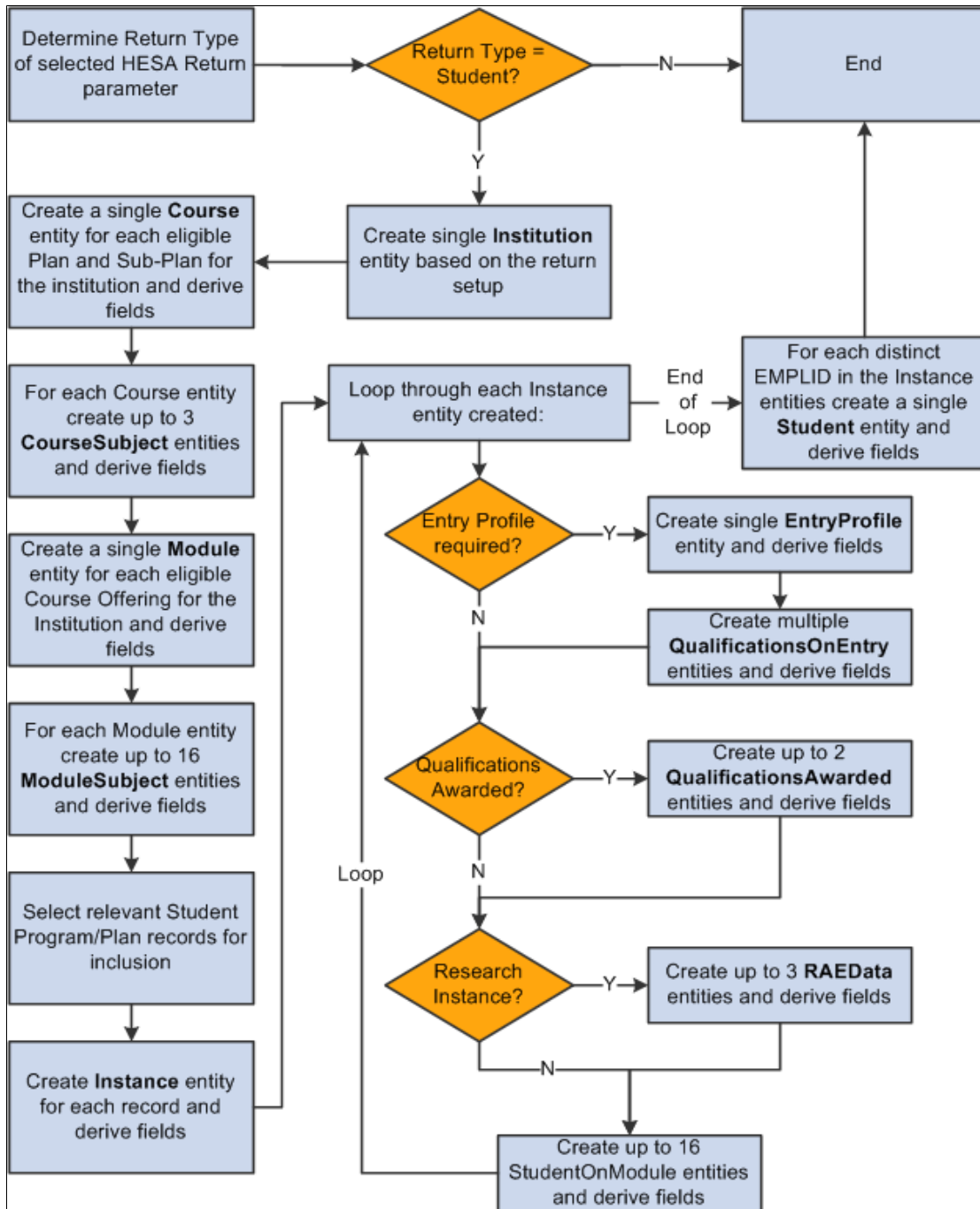

When the process creates an entity record, it sets the record to *active*. The records it created previously are set to *inactive* or deleted depending on whether or not the Retain Data from Previous Run check box is selected. The process deletes the records it created before the previous run.

Refer to the documentation sections of each entity (for example, the “Student Record Return: Course Entity” section), for information about how the system includes records for each entity.

Also, specifically, refer to the following documentation sections for information about how the entities are processed when you select the validation only and null only check boxes:

- [Student Record Return: Course Entity](#)
- [Student Record Return: Module Entity](#)
- [Student Record Return: Instance Entity](#)
- [ITT Return: Student Entity](#)
- [DLHE Return: Study Entity](#)

HESA Validation Errors

To run the Create Extract process for records with validation errors:

1. Use the File Parser utility to import the errors, reported by the HESA Validation Kit, into a staging table (PS_SSR_HE_VAL_STG)
2. Run the Create Extract process just for those records with validation errors. You must select at least one of the Validation Errors Only check boxes for the process to select error records from the PS_SSR_HE_VAL_STG table.
3. Use the Extract Data page to review the extract records with errors.

Note: You should ensure that all previous validation error records, including the header record, have been processed and deleted from the validation staging table before importing a new validation errors file to the staging table using the File Parser process.

Using File Parser to import HESA Validation Kit errors

When you use the HESA Validation Kit to process an XML file, the kit reports errors with an option to save the error details as a text (.txt) file. To import the records from the text file into the PS_SSR_HE_VAL_STG staging table, you can use File Parser process. For more information about setting up and running the File Parser process, refer to the File Parser documentation:

See “Understanding the File Parser Process” (Campus Community Fundamentals)

See “Running the File Parser Process” (Campus Community Fundamentals)

Note that the Field Conversion Definition setup is required only if the file data needs to be converted before inserting into the staging table. Therefore, this setup is not required for HESA validation error processing.

The following is an example of the context definition setup for HESA Validation error processing:

This example illustrates Context Definition setup for HESA error processing (1 of 2). You can find definitions for the fields and controls later on this page.

*Context Name: HESA Validation Import

Conversion Definition: [Dropdown]

Staging Table Records: Find | View All | First | 1 of 1 | Last

*Record: SSR_HE_VAL_STG | Staging Tbl for HESA Validate | Sort Order: 1

Parent Record: [Search]

Synchronize Record Fields

Staging Table Fields: Customize | Find | View 10 | First | 1-18 of 18 | Last

	Field Name	Field Type	*Mapping Action	Visible for Mapping
1	SSR_HE_LEVEL	Char	No Default	<input checked="" type="checkbox"/>
2	SSR_HE_RULE_NUM	Char	No Default	<input checked="" type="checkbox"/>
3	SSR_HE_RULE_DESC	Char	No Default	<input checked="" type="checkbox"/>
4	SSR_HE_COLUMN1	Char	No Default	<input checked="" type="checkbox"/>
5	SSR_HE_COLUMN2	Char	No Default	<input checked="" type="checkbox"/>
6	SSR_HE_COLUMN3	Char	No Default	<input checked="" type="checkbox"/>
7	SSR_HE_COLUMN4	Char	No Default	<input checked="" type="checkbox"/>
8	SSR_HE_COLUMN5	Char	No Default	<input checked="" type="checkbox"/>
9	SSR_HE_COLUMN6	Char	No Default	<input checked="" type="checkbox"/>
10	SSR_HE_COLUMN7	Char	No Default	<input checked="" type="checkbox"/>
11	SSR_HE_COLUMN8	Char	No Default	<input checked="" type="checkbox"/>

This example illustrates Context Definition setup for HESA error processing (2 of 2). You can find definitions for the fields and controls later on this page.

12	SSR_HE_COLUMN9	Char	No Default	<input checked="" type="checkbox"/>
13	SSR_HE_COLUMN10	Char	No Default	<input checked="" type="checkbox"/>
14	SSR_HE_COLUMN11	Char	No Default	<input checked="" type="checkbox"/>
15	SSR_HE_COLUMN12	Char	No Default	<input checked="" type="checkbox"/>
16	SSR_HE_COLUMN13	Char	No Default	<input checked="" type="checkbox"/>
17	SSR_HE_COLUMN14	Char	No Default	<input checked="" type="checkbox"/>
18	SSR_HE_LINE_NUM	Char	No Default	<input checked="" type="checkbox"/>

Click the Refresh Layout Tree link on the Record Tree page to view the staging table (SSR_HE_VAL_STG) that holds the imported validation errors.

The following is an example of the Record Tree page for SSR_HE_VAL_STG:

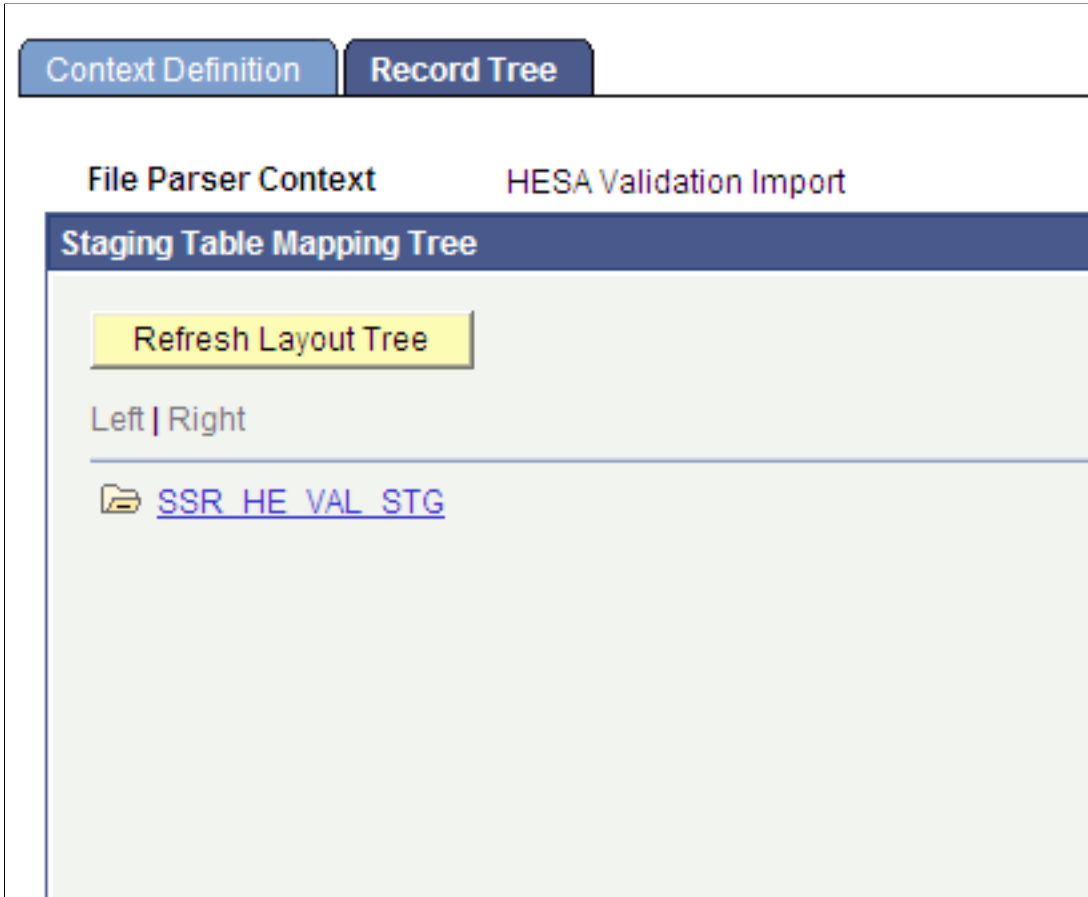

Campus Solutions delivers an example definition that includes the possible validation error values that you can import:

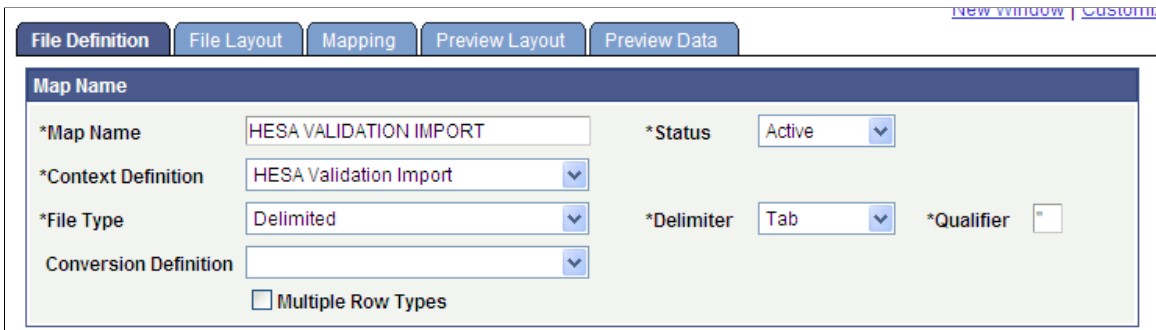

The delivered definition is based on an assumed error file structure:

The screenshot shows a software interface for defining file mappings. At the top, there are tabs for 'File Definition', 'File Layout', 'Mapping', 'Preview Layout', and 'Preview Data'. Below these is a 'Map Name' field containing 'HESA VALIDATION IMPORT'. Underneath is a 'Row Types' section with a dropdown menu set to 'HESA VALIDATION IMPORT Staging Table' and a 'Load Fields' button. The main area is a 'File Fields' table with columns for 'Location', 'Format', 'Propagate', '*Sort Order', '*File Field Name', 'Field Number', 'Field Type', and two empty columns with '+' and '-' icons. The table contains 17 rows of field definitions.

Location	Format	Propagate	*Sort Order	*File Field Name	Field Number	Field Type		
1			10	Level	1	Character	+	-
2			20	Rule number	2	Character	+	-
3			30	Rule description	3	Character	+	-
4			40	COURSEID	4	Character	+	-
5			50	SBJCA	5	Character	+	-
6			60	MODID	6	Character	+	-
7			70	MODSBJ	7	Character	+	-
8			80	COSTCN	8	Character	+	-
9			90	OWNSTU	9	Character	+	-
10			100	HUSID	10	Character	+	-
11			110	OWNINST	11	Character	+	-
12			120	NUMHUS	12	Character	+	-
13			130	QUALSBJ	13	Character	+	-
14			140	QUALTYPE	14	Character	+	-
15			150	QUAL	15	Character	+	-
16			160	UOA2008	16	Character	+	-
17			170	Line Number	17	Character	+	-

The header row for the file would contain the field names, indicated in the preceding example, without the Line Number.

You can copy an existing File Mapping Definition (Set Up SACR, System Administration, Utilities, File Parser, Copy File Map Definition) and then edit the copied version to create different mappings that match the fields in the error file.

Map the key fields of COURSEID, MODID, and OWNSTU to a staging table column if the values for the fields are provided in the errors file. Also, map the Level, Rule Number, and Rule Description values.

The following is an example of the Mapping page with the mappings for these fields:

The screenshot shows the 'Mapping' tab for 'HESA VALIDATION MIN'. The 'Field Mapping Detail' table is as follows:

Field Name	Field Type	Required	*Mapping Action	File Field Name	Sub Parse Field	Skip if Blank
1 SSR_HE_LEVEL	Char	No	Direct from File	Level	<input type="checkbox"/>	<input type="checkbox"/>
2 SSR_HE_RULE_NUM	Char	No	Direct from File	Rule number	<input type="checkbox"/>	<input type="checkbox"/>
3 SSR_HE_RULE_DESC	Char	No	Direct from File	Rule description	<input type="checkbox"/>	<input type="checkbox"/>
4 SSR_HE_COLUMN1	Char	No	Direct from File	COURSEID	<input type="checkbox"/>	<input type="checkbox"/>
5 SSR_HE_COLUMN2	Char	No	Direct from File	MODID	<input type="checkbox"/>	<input type="checkbox"/>
6 SSR_HE_COLUMN3	Char	No	Direct from File	OWNSTU	<input type="checkbox"/>	<input type="checkbox"/>
7 SSR_HE_COLUMN4	Char	No	None			
8 SSR_HE_COLUMN5	Char	No	None			
9 SSR_HE_COLUMN6	Char	No	None			
10 SSR_HE_COLUMN7	Char	No	None			

Example of mapping for the minimum fields (continued):

11 SSR_HE_COLUMN8	Char	No	None			
12 SSR_HE_COLUMN9	Char	No	None			
13 SSR_HE_COLUMN10	Char	No	None			
14 SSR_HE_COLUMN11	Char	No	None			
15 SSR_HE_COLUMN12	Char	No	None			
16 SSR_HE_COLUMN13	Char	No	None			
17 SSR_HE_COLUMN14	Char	No	None			
18 SSR_HE_LINE_NUM	Char	No	Direct from File	Line Number	<input type="checkbox"/>	<input type="checkbox"/>

To process the staging table records, the Create Extract process does not rely on values existing in a particular column but the process will select the key COURSEID, MODID and OWNSTU values based on the header row value for the column in the error file. Therefore, you must include the header row in the error file being imported.

Other than the key and Level, Rule Number and Rule Description values, you can map the remaining fields to import the full details of the errors into the staging table record. This step is optional because the non-key values are not required for the subsequent processing of the staging table records by the Create Extract process.

This is the mapping for the full Student return error file:

File Definition | File Layout | **Mapping** | Preview Layout | Preview Data

Map Name HESA VALIDATION IMPORT

Row Types Find First 1 of 1 Last

Row Type HESA VALIDATION IMPORT

Field Mapping Find View All First 1 of 1 Last

*Record SSR_HE_VAL_STG Row 1 Force Insert Auto Map Synchronize to Context

Field Mapping Detail Personalize Find View 10 First 1-18 of 18 Last

Field Name	Field Type	Required	*Mapping Action	File Field Name	Sub Parse Field	Skip if Blank
1 SSR_HE_LEVEL	Char	No	Direct from File	Level	<input type="checkbox"/>	<input type="checkbox"/>
2 SSR_HE_RULE_NUM	Char	No	Direct from File	Rule number	<input type="checkbox"/>	<input type="checkbox"/>
3 SSR_HE_RULE_DESC	Char	No	Direct from File	Rule description	<input type="checkbox"/>	<input type="checkbox"/>
4 SSR_HE_COLUMN1	Char	No	Direct from File	COURSEID	<input type="checkbox"/>	<input type="checkbox"/>
5 SSR_HE_COLUMN2	Char	No	Direct from File	SBJCA	<input type="checkbox"/>	<input type="checkbox"/>
6 SSR_HE_COLUMN3	Char	No	Direct from File	MODID	<input type="checkbox"/>	<input type="checkbox"/>
7 SSR_HE_COLUMN4	Char	No	Direct from File	MODSBJ	<input type="checkbox"/>	<input type="checkbox"/>
8 SSR_HE_COLUMN5	Char	No	Direct from File	COSTCN	<input type="checkbox"/>	<input type="checkbox"/>
9 SSR_HE_COLUMN6	Char	No	Direct from File	OWNSTU	<input type="checkbox"/>	<input type="checkbox"/>
10 SSR_HE_COLUMN7	Char	No	Direct from File	HUSID	<input type="checkbox"/>	<input type="checkbox"/>

Mapping for the full Student return error file (continued):

11 SSR_HE_COLUMN8	Char	No	Direct from File	OWNINST	<input type="checkbox"/>	<input type="checkbox"/>
12 SSR_HE_COLUMN9	Char	No	Direct from File	NUMHUS	<input type="checkbox"/>	<input type="checkbox"/>
13 SSR_HE_COLUMN10	Char	No	Direct from File	QUALSBJ	<input type="checkbox"/>	<input type="checkbox"/>
14 SSR_HE_COLUMN11	Char	No	Direct from File	QUALTYPE	<input type="checkbox"/>	<input type="checkbox"/>
15 SSR_HE_COLUMN12	Char	No	Direct from File	QUAL	<input type="checkbox"/>	<input type="checkbox"/>
16 SSR_HE_COLUMN13	Char	No	Direct from File	UOA2008	<input type="checkbox"/>	<input type="checkbox"/>
17 SSR_HE_COLUMN14	Char	No	None			
18 SSR_HE_LINE_NUM	Char	No	Direct from File	Line Number	<input type="checkbox"/>	<input type="checkbox"/>

As with the Student return, for the ITT return, you must map the Level, Rule Number and Rule Description values along with the key OWNSTU value. The File Parser process uses these mappings to identify the extract records that are to be re-processed by the Create Extract process.

This example illustrates the mapping for the minimum fields — ITT.

Field Name	Field Type	Required	*Mapping Action	File Field Name	Sub Parse Field	Skip if Blank
1 SSR_HE_LEVEL	Char	No	Direct from File	Level	<input type="checkbox"/>	<input type="checkbox"/>
2 SSR_HE_RULE_NUM	Char	No	Direct from File	Rule number	<input type="checkbox"/>	<input type="checkbox"/>
3 SSR_HE_RULE_DESC	Char	No	Direct from File	Rule description	<input type="checkbox"/>	<input type="checkbox"/>
4 SSR_HE_COLUMN1	Char	No	Direct from File	OWNSTU	<input type="checkbox"/>	<input type="checkbox"/>
5 SSR_HE_COLUMN2	Char	No	None			
6 SSR_HE_COLUMN3	Char	No	None			
7 SSR_HE_COLUMN4	Char	No	None			
8 SSR_HE_COLUMN5	Char	No	None			
9 SSR_HE_COLUMN6	Char	No	None			
10 SSR_HE_COLUMN7	Char	No	None			

Mapping for the minimum fields — ITT (continued).

11 SSR_HE_COLUMN8	Char	No	None			
12 SSR_HE_COLUMN9	Char	No	None			
13 SSR_HE_COLUMN10	Char	No	None			
14 SSR_HE_COLUMN11	Char	No	None			
15 SSR_HE_COLUMN12	Char	No	None			
16 SSR_HE_COLUMN13	Char	No	None			
17 SSR_HE_COLUMN14	Char	No	None			
18 SSR_HE_LINE_NUM	Char	No	Direct from File	Line Number	<input type="checkbox"/>	<input type="checkbox"/>

This is the mapping for the full ITT error file:

This example illustrates the mapping for the full error file — ITT.

Field Name	Field Type	Required	*Mapping Action	File Field Name	Sub Parse Field	Skip if Blank
1 SSR_HE_LEVEL	Char	No	Direct from File	Level	<input type="checkbox"/>	<input type="checkbox"/>
2 SSR_HE_RULE_NUM	Char	No	Direct from File	Rule number	<input type="checkbox"/>	<input type="checkbox"/>
3 SSR_HE_RULE_DESC	Char	No	Direct from File	Rule description	<input type="checkbox"/>	<input type="checkbox"/>
4 SSR_HE_COLUMN1	Char	No	Direct from File	OWNSTU	<input type="checkbox"/>	<input type="checkbox"/>
5 SSR_HE_COLUMN2	Char	No	Direct from File	HUSID	<input type="checkbox"/>	<input type="checkbox"/>
6 SSR_HE_COLUMN3	Char	No	Direct from File	RECID	<input type="checkbox"/>	<input type="checkbox"/>
7 SSR_HE_COLUMN4	Char	No	Direct from File	UKPRN	<input type="checkbox"/>	<input type="checkbox"/>
8 SSR_HE_COLUMN5	Char	No	Direct from File	SBJCA	<input type="checkbox"/>	<input type="checkbox"/>
9 SSR_HE_COLUMN6	Char	No	None			
10 SSR_HE_COLUMN7	Char	No	None			

Mapping for the full error file — ITT (continued).

11	SSR_HE_COLUMN8	Char	No	None			
12	SSR_HE_COLUMN9	Char	No	None			
13	SSR_HE_COLUMN10	Char	No	None			
14	SSR_HE_COLUMN11	Char	No	None			
15	SSR_HE_COLUMN12	Char	No	None			
16	SSR_HE_COLUMN13	Char	No	None			
17	SSR_HE_COLUMN14	Char	No	None			
18	SSR_HE_LINE_NUM	Char	No	Direct from File	Line Number	<input type="checkbox"/>	<input type="checkbox"/>

On the Preview Data page, you can attach an error file and generate a preview based on the first row in the error file. This lets you check whether the values will populate the correct columns in the staging table.

The following is an example of the Preview Data page:

[File Definition](#)
[File Layout](#)
[Mapping](#)
[Preview Layout](#)
[Preview Data](#)
[New window](#) | [Customize Page](#)

Map Name HESA VALIDATION IMPORT A [Preview Data](#)

Attached File ST0910A_Errors.txt
[Add Attachment](#)
[Delete Attachment](#)
[View Attachment](#)

Row Types [Find](#) First **1 of 1** Last

Row Type HESA VALIDATION IMPORT A

Field Mapping [Find](#) | [View All](#) First **1 of 1** Last

Record SSR_HE_VAL_STG **Row** 1 [+](#) [-](#)

Field Values		Customize Find View 10 [?] [X]	First 1-16 of 16 Last
Field Name	Value		
1 SSR_HE_LEVEL	Level		
2 SSR_HE_RULE_NUM	Rule number		
3 SSR_HE_RULE_DESC	Rule description		
4 SSR_HE_COLUMN1	COURSEID		
5 SSR_HE_COLUMN2			
6 SSR_HE_COLUMN3	MODID		
7 SSR_HE_COLUMN4	MODSBJ		
8 SSR_HE_COLUMN5	COSTCN		
9 SSR_HE_COLUMN6	OWNSTU		
10 SSR_HE_COLUMN7	HUSID		
11 SSR_HE_COLUMN8	OWNINST		
12 SSR_HE_COLUMN9	NUMHUS		
13 SSR_HE_COLUMN10			
14 SSR_HE_COLUMN11			
15 SSR_HE_COLUMN12			
16 SSR_HE_LINE_NUM			

In the preceding example, note that because the header row does not included a label for Line Number that value is blank in the preview.

Reviewing the Extract Data

Access the extract data pages (**Records and Enrollment > HESA Reporting > Extract Data**).

Use the Institution Extract, Module Extract Data, Course Extract Data, Student Extract Data, and Instance Extract Data pages to review the Student return extract data.

Use the Institution Extract and Provision Extract Data pages to review the Aggregate Offshore return data.

Use the Institution Extract and ITT Extract Data pages to review the ITT return data.

Use the Graduate Outcomes Extract Data page to review the Graduate Outcomes return data.

For the Unistats/KIS return, use the Institution Extract page to review institution level fields and fields of Location entities. Use the Course Extract Data page to review the KIS Course records.

The following example shows an extract data page:

Module Extract Data

Academic Institution: PSGBR

Return Name: ST1213

Module ID: 6666841

Return Type: STUDENT

Reporting Period: 2012/13

Module Title: Introductory Accounting II

Module Details Find | View All | First 1 of 1 Last

Field Details Personalize Find View All First 1-10 of 10 Last					
Field	Derived Value	Description	Derivation Step	Reported Value	Derived Value Overriden
CRDTPTS	15		3	15	<input type="checkbox"/>
CRDTSCM	NULL ERROR		4	NULL ERROR	<input type="checkbox"/>
FRANIND					<input type="checkbox"/>
FTE	12		2	12	<input type="checkbox"/>
LEVLPTS	NULL ERROR		4	NULL ERROR	<input type="checkbox"/>
MODID	6666841			6666841	<input type="checkbox"/>
MODLANG					<input type="checkbox"/>
MTITLE	Introductory Accounting II			Introductory Acc	<input type="checkbox"/>
PCOLAB	NULL ERROR		4	NULL ERROR	<input type="checkbox"/>
TINST					<input type="checkbox"/>

Module Subjects Find | View All | First 1-2 of 2 Last

Field Details Personalize Find View All First 1-3 of 3 Last					
Field	Derived Value	Description	Derivation Step	Reported Value	Derived Value Overriden
COSTCN	114	Physics	2	114	<input type="checkbox"/>
MODSBJ	B230	Pharmacy	2	B230	<input type="checkbox"/>
MODSBJP	50		2	50	<input type="checkbox"/>

Field Details Personalize Find View All First 1-3 of 3 Last					
Field	Derived Value	Description	Derivation Step	Reported Value	Derived Value Overriden
COSTCN	113	Chemistry	2	113	<input type="checkbox"/>
MODSBJ	B110	Anatomy	2	B110	<input type="checkbox"/>
MODSBJP	50		2	50	<input type="checkbox"/>

You can use the Extract Data pages to override the derived field value. For example, you can enter a different value for ModuleSubject.COSTCN in the **Reported Value** field and click the **Save** button. When you click the **Save** button, the **Derived Value Overridden** check box appears as selected for ModuleSubject.COSTCN. The Extract Data pages also display the sequence number of the step that derives the field value.

The documentation sections for entities list the derivation steps for each field. For an example of such a section, see Student Record Return: Course Entity.

You can review only the most recent data for a particular return. When you run the Create Extract process, the system automatically deletes any data previously generated for a return.

Null Error check box on the Instance Extract Data page

The Create Extract process selects this check box if any field in the student's extract data has a *NULL ERROR* value. The Null Error check box is applicable for only Student return.

Creating an XML Return File

Access the Create XML page (**Records and Enrollment > HESA Reporting > Extract Processing > Create XML**).

After you review the return data using the Extract Data pages, use the Create XML page to run the Create XML File process.

<i>Field or Control</i>	<i>Description</i>
Return Name	Enter the return that you want to process.
XML Path/File Name	Enter the file path and file name that you want the system to use to save the XML file. You must enter a valid directory path that maps to a folder with appropriate Read/Write permission. If you cannot locate such a folder, consult your system administrator.
Exclude Null Error tags	This field isn't displayed for Data Futures returns. Select this check box if you want the process to exclude fields with a Reported Value of <i>NULL ERROR</i> from the XML file. If you do not select this check box, then the process includes the fields with Reported Value of <i>NULL ERROR</i> .

The Create XML process automatically excludes from the XML file:

- A field that does not have a value (null).
- An entity in which all fields have no values.

After running the process, you can use the View Log/Trace page to download the generated XML file to your computer.

Note for Data Futures Return

Entity Statuses and Field Statuses regions appear for the Data Futures return. If you selected the Create XML checkbox on the [HESA Configuration](#) page, these regions list the statuses you defined on that page.

Entities are included in the Create XML process if the status was defined on the HESA Configuration page and the corresponding XML checkbox was also selected.

Fields are included for each entity if any one of these conditions is true:

- The Field Status was defined on the HESA Configuration page and the corresponding XML checkbox was also selected.
- Field Type in Entity/Fields is *Key*.
- Field Type is *Required* in Entity Fields.

Each field element is populated with the Reported Value. If the Reported Value is null, an empty element is included in the XML. Note: Typically required fields without a value will be derived as NULL ERROR and the corresponding Entity Status will be set to Error so the entity will not be included in the XML.

There are some non-unique identifier fields that are required in the schema when any of the other fields in the sequence are being returned. Those fields are always included where the action is upsert.

Note for Student Return

The Create XML File process includes the RAEData element as <REFData> in the XML file. The MOBTYP2 and MOBTYP3 fields are included in the XML as <MOBTYP>. NATIOND2 is included as <NATIOND>, REGBODY2 as <REGBODY>, and TQGSUB2 and TQGSUB3 as <TQGSUB>.

Note for ITT Return

- Blank NQTEMAIL values are included as empty tags, that is, <NQTEMAIL/>
- PGCECLSS – included in the XML as <DEGCLSS>
- PGCEOBJ – included in the XML as <DEGSBJ>
- PGCEOBJ2 – included in the XML as <DEGSBJ>
- PGCEOBJ3 – included in the XML as <DEGSBJ>

Note for Unistats/KIS Return

The Create XML File process converts the tags for the following field names:

- OTHERINST2 to OTHERINST9 converted to <OTHERINST>
- SSR_HE_COURSEID converted to <KISCOURSEID>
- SSR_HE_CTITLE is converted to <TITLE>
- JACSA, JACSB and JACSC converted to <JACS>
- TEACHUKPRN2 and TEACHUKPRN3 converted to <TEACHUKPRN>

Note for DLHE Return

The Create XML File process includes the PREVEMP field as <PREVEM> in the XML file.

Validating an XML Return File

Access the HESA Validate XML page (**Records and Enrollment > HESA Reporting > Extract Processing > Validate XML**).

Run the HESA Validate XML process to validate the XML file generated by the Create XML File process. The HESA Validate XML process validates against the schema, it does not validate against the HESA business rules. You can validate the XML file against both the schema and the HESA business rules by using the HESA Validation Kit. After you run the HESA Validate XML process, refer to the log file to check for any validation errors.

<i>Field or Control</i>	<i>Description</i>
XML Path/File Name	Enter the path and file name of the XML file that you want to validate.
Add Attachment	<p>Click to browse to the XML file that you want to validate. You can browse your local drive and select a file.</p> <hr/> <p>Note: The upload process creates a files subdirectory to store and process the XML file. This subdirectory is created in the server directory location that is specified in the PS_SERVDIR system parameter in the Application Server/Process Scheduler configuration file psappsrv.cfg/pspres.cfg. Ensure that PS_SERVDIR is set up with an appropriate value in the configuration file and that users have the correct permission to access the files subdirectory.</p>
XSD Path/File Name	<p>Enter the complete path and file name of the XSD file. The process uses the XSD file to validate your XML file.</p> <p>The XSD file is available from the HESA website.</p> <hr/> <p>Note: You must place the two related XSD files for CodeLists and DataTypes in the same directory as the XSD file being used for the XML validation. For example, if C08051.xsd is being used to validate the XML file and you have stored the C08051.xsd in /bur/hesa/psoft/shared/, then you must place C08051DataTypes.xsd and C08051CodeLists.xsd in the same directory /bur/hesa/psoft/shared/ because C08051.xsd references these two files.</p>

<i>Field or Control</i>	<i>Description</i>
Add Attachment	<p>Click to browse to the XSD file. You can browse your local drive and select a file.</p> <hr/> <p>Note: The upload process creates a files subdirectory to store and process the XSD file. This subdirectory is created in the server directory location that is specified in the PS_SERVDIR system parameter in the Application Server/Process Scheduler configuration file psappsrv.cfg/psprcs.cfg. Ensure that PS_SERVDIR is set up with an appropriate value in the configuration file and that users have the correct permission to access the files subdirectory.</p> <hr/> <p>Note: If you are adding an XSD file using the Add Attachment button you must also ensure that any related XSD files (for example, Code Lists and Data Types) have also been added to the same location using the Add Attachment button.</p> <hr/>

Reviewing Submitted Data

Access the Institution Submitted Data pages (**Records and Enrollment > HESA Reporting > Submitted Data > Institution Submitted Data**)

Use the Institution Submitted Data page to review submitted extract data that has been created or updated by the Extract Synch process. In Correct History mode, a new set of submitted data records can be added for a new effective date and effective sequence, or an existing set of submitted data records can be deleted.

You can add or delete only one record at a time. To add a record, click the plus (+) button, and then select the Insert button to launch the synch process that copies all of the existing entity and fields records for the current date/sequence to the new date/sequence. To delete, make sure you're on the correct record, then click the minus (-) button, and then select the Delete button to launch the synch process to delete all the existing entity and fields records for the selected date/sequence. To delete a record, there must be more than one effective-dated or sequence record. Otherwise, the minus (-) button isn't displayed. For new records, the effective date defaults to the current date and the effective sequence defaults to the next value in the sequence. You won't be able to set the effective date to a future date.

<i>Field or Control</i>	<i>Description</i>
Source	Indicates whether the effective date and sequence is derived from the Extract Synch process or was entered by a user.

Synch Details

The Processing Details grid shows a list of sync processes. This grid appears when there's at least one process that has been run or is being run.

Field or Control	Description
Synch	<p>The label for this button changes depending on the situation.</p> <ul style="list-style-type: none"> • Synch is displayed when there aren't any records being inserted or deleted. <p>When you add or delete a new record and the synch process is completed, this label appears but isn't enabled.</p> <ul style="list-style-type: none"> • Insert is displayed when a new row is added. • Delete is displayed when a row is going to be deleted. • Refresh is displayed when there's an ongoing synch process. You can click this button while the synch process is running to check the process status.
Insert	This check box appears as selected and inactive when a record has been added.
Delete	This check box appears as selected and inactive when a record has been deleted.
Process Instance	This field is populated only after the synch process is run successfully.
User ID	Indicates the user that ran a synch process. This field is populated only after the process is run successfully.

Purge Submitted Data

Access the Purge Submitted Data page (**Records and Enrollment > HESA Reporting > Submitted Data > Purge Submitted Data**).

Over time, the data set in the submitted records becomes large and may impact the performance of the extract compare processing as well as the extract synch process. You can use this page to delete older records of submitted data based on a specified effective date range.

If you want to delete submitted data given a specific date and effective sequence, you should use the delete process on the [Institution Submitted Data](#) page.

Parameters

Field or Control	Description
Return Type	Only the Data Futures type is supported.

Institution Submitted Data Information

This region displays information based on the academic institution and return type you specify as parameters. This information should help you determine which date range to use in identifying the records you want to delete.

Understanding Compare Processing for Data Futures

To compare the extract records with the corresponding extract records after the initial extract of data for all entities and fields, compare processing is performed.

The entity extract records are keyed on Institution, Return Type, Effective Date, Effective Sequence and then the unique keys for the particular entity record, for example, Module ID for Module. The related extract fields records also include Field (SSR_HE_FIELD) in the key. The comparison is done against the most recent effective-dated/sequenced record for the Institution and Return Type (i.e. DFSTDNT) in extract for the keys values for each entity.

For some parent entities, there is logic to set the Entity Status to *Identify* in cases where there is no change to the entity itself or its fields, but the entity needs to be included in the XML because a child entity has been added or amended. The logic for each entity is described in the following sections.

In cases where there are more than 2 entity levels, the check on Entity Status for child entities also includes a check on whether the value is *Identify* for updates to grandchild (level 3) or great-grandchild (level 4) entities. For example, for Student, if there are no changes to the Student entity or its fields, the entity status will be set to *Identify* if any child entity has entity status of *Identify* as well as *New* or *Amended*. This handles cases where an unchanged child entity (for example, Engagement) has an entity status of *Identify* because a child of that entity (for example, Student Course Session) has an entity status of *New* or *Amended*. Similarly, if Student Course Session has an entity status of *Identify* because there is a change to a child entity (like Module Instance), then each of the parent entities need to be set to *Identify* to include the entity in the XML.

For some entities, if a previously reported record exists in extract that isn't included in the extract, depending on the entity structure either one of these scenarios occur:

- A new extract record is created with an entity status of *Amended* and a Valid To date populated for inclusion in the XML file (Course Initiative, for example)
- An extract record is created with an entity status of *Delete* (Course Role, for example) to allow the entity status of the corresponding extract record to be updated to *Delete* when the Extract Synch process is run

Note that extract records with Entity Status of *Delete* aren't included in the XML file.

The logic works through the different groups of related entities from the lowest level in the schema (level 4) upwards. The processing order takes into account the parent/child entity structure.

Course

Child Entities: [Course Initiative](#), [Course Reference](#), [Course Role](#), [Curriculum Accreditation](#)

Fields

For each Course field extract record for the return with a Derived Value, the record is compared with the corresponding submitted data (MST) record:

- If the Derived Value of the field is NULL ERROR, set Field Status to *Error*.
- If the combination of Institution, Course ID, and Field doesn't exist in the submitted data record, set Field Status to *New*.
- If the Reported Value in the extract is different from the Reported Value in the most recent submitted data record, set Field Status to *Amended*.
- Set Field Status to *Unchanged*, that is, Reported Value in the extract is the same as in the most recent submitted data record

Entities

For each Course entity extract record for the return, the record is compared with the corresponding submitted data (MST) record:

- If at least one field has Field Status of Error in the extract, set Entity Status to *Error*.
- If the combination of Institution, and Course ID doesn't exist in the submitted data record, set Entity Status to *New*.
- If there are one or more Field extract records with Field Status = N (New) or A (Amended), set Entity Status to *Amended*.
- If there are one or more child Entity extract records with Entity Status of New, Amended, Identify, Delete, set Entity Status to *Identify*.
- Set Entity Status to *Unchanged*, that is, there are no child entities or fields with status New or Amended that need to be reported

Course Initiative

Child Entities: None

Each entity is uniquely identified by Initiative ID. Although Valid From is part of the key, this is not used in the comparison. The check is to determine whether or not the Initiative ID has already been reported. In cases where entities were previously reported and one or more no longer apply, extract entities are created with Entity Status of Amended and Valid To populated.

Fields

For each Course Initiative field extract record for the return with a Derived Value, the record is compared with the corresponding submitted data (MST) record:

- If the Derived Value of the field is NULL ERROR, set Field Status to *Error*.
- If the combination of Course ID, Initiative ID and Field doesn't exist in the submitted data record, set Field Status to *New*.

- If the Reported Value in the extract is different from Reported Value in the most recent submitted data record, set Field Status to *Amended*.
- Set Field Status to *Unchanged*, that is, Reported Value in the extract is the same as in the most recent submitted data record.

Entities

For each Course Initiative entity extract record for the return, the record is compared with the corresponding submitted data (MST) record:

- If the combination of Course ID, and Initiative ID doesn't exist in the submitted data record, set Entity Status to *New*.
- Set Entity Status and Field Status to *Unchanged*, that is, the Initiative ID already exists in extract.
- For any existing entities in extract where the Initiative ID for the entity doesn't appear in the submitted data record and Valid To is blank, create a new entity in the extract using the Initiative ID with Entity Status of *Amended*.

New field extract records are created for COURSEINITID and COURSEVALIDFROM using the values from extract with Field Status of Unchanged. A field extract record is created for COURSEVALIDTO with Derived Value set to the reporting period start date in YYYY-MM-DD format and Field Status of *New*. If the derived COURSEVALIDTO date is before the COURSEVALIDFROM date, the value is set to the same value as COURSEVALIDFROM. The derivation step is set to 99 for each field.

Course Reference

Child Entities: None

Each entity is uniquely identified by the combination of Course Reference ID Type and Course Reference ID. The only fields in the entity are the key fields. Multiple records can be returned for the same Course Reference ID Type with different Course Reference ID values. This means different UCAS course codes for the same course.

The extract records include Course Reference ID Type (SSR_HE_CREPID_TYPE) and Line Number (SSR_HE_LN_NBR) in the key.

Entities

For each Course Reference entity extract record for the return, the record is compared with the corresponding submitted data (MST) record:

- If at least one field has Field Status of Error, set Entity Status to *Error*.
- If the combination of Course ID and Course Reference ID Type and Course Reference ID doesn't exist in the submitted data record, set Entity Status and Field Status for each field to *New*.
- Set Entity Status and Field Status for each field to *Unchanged*.

Course Role

Child Entities: None

The combination of Role Type and HESA Identifier is the unique identifier. In cases where multiple entities were previously reported and one or more no longer apply, extract entities are created with Entity Status of *Delete*.

Fields

For each Course Role field extract record for the return with a Derived Value, the record is compared with the corresponding submitted data (MST) record:

- If the Derived Value of the field is NULL ERROR, set Field Status to *Error*.
- If the combination of Institution, Course ID, Role Type, HESA Identifier and Field doesn't exist in the submitted data record, set Field Status to *New*.
- If the combination exists in the extract record and the Entity Status in the most recent submitted data record is *Delete*, set Field Status to *New*.
- If the Reported Value in the extract is different from the Reported Value in the most recent submitted data record, set Field Status to *Amended*.

Proportion may be set to Amended if the role has previously been reported but the proportion has changed.

- Set Field Status to *Unchanged*, that is, Reported Value in the extract is the same as in the most recent submitted data record

Entities

For each Course Delivery Role entity extract record for the return, the record is compared with the corresponding submitted data (MST) record:

- If at least one field has Field Status of Error, set Entity Status to *Error*.
- If the combination of Institution, Course ID, Role Type and HESA Identifier doesn't exist in the submitted data record, set Entity Status to *New*.
- If the combination exists in the extract record and the Entity Status in the most recent submitted data record is *Delete*, set Entity Status to *New*.
- If there are one or more Field extract records with Field Status of *New* or *Amended*, set Entity Status to *Amended*.
- Set Entity Status to *Unchanged*, that is, either there are no fields or all the fields have Field Status of *Unchanged*.
- For any existing entities in extract where the combination of Role Type and HESA Identifier for the entity doesn't appear in the submitted data record, create a new entity using the Role Type and HESA Identifier with Entity Status of *Delete*.

New field extract records ROLETYPECDR and COURSEROLEHESAID are created with Field Status of *Delete*.

Curriculum Accreditation

Child Entities: None

Each entity is uniquely identified by the Accreditation ID. Although Valid From is part of the key, this is not used in the comparison.

In cases where multiple entities were previously reported and one or more no longer apply, extract entities are created with Entity Status of *Amended* and Valid To populated.

Fields

For each Curriculum Accreditation field extract record for the return with a Derived Value, the record is compared with the corresponding submitted data (MST) record:

- If the Derived Value of the field is NULL ERROR, set Field Status to *Error*.
- If the combination of Institution, Course ID, Accreditation ID and Field doesn't exist in the submitted data record, set Field Status to *New*.
- If the Reported Value in the extract is different from the Reported Value in the most recent submitted data record, set Field Status to *Amended*.
- Set Field Status to *Unchanged*, that is, Reported Value in the extract is the same as in the most recent submitted data record.

Entities

For each Curriculum Accreditation entity extract record for the return, the record is compared with the corresponding submitted data (MST) record:

- If at least one field has Field Status of Error, set Entity Status to *Error*.
- If the combination of Institution, Course ID, and Accreditation ID doesn't exist in the submitted data record, set Entity Status to *New*.
- If there are one or more Field extract records with Field Status of New Amended, set Entity Status to *Amended*.
- set Entity Status to *Unchanged*, that is, either there are no fields or all the fields have Field Status of Unchanged.
- For any existing entities in extract where the Initiative ID for the entity doesn't appear in the submitted data record and Valid To is blank, create a new entity using the Accreditation ID with entity status of *Amended*.

New field extract records are created for CURACCID and CURACCVALIDFROM using the values from extract with Field Status of *Unchanged*. A field extract record is created for CURACCVALIDTO with Derived Value set to the reporting period start date in YYYY-MM-

DD format and Field Status of *New*. If the derived CURACCVALIDTO date is before the CURACCVALIDFROM date, the value is set to the same value as CURACCVALIDFROM.

Module

Child Entities: Module Cost Centre, Module Delivery Role, Module Subject

Each entity is uniquely identified by the Module ID that is derived as either Course ID + Course Offering Number for courses, or Academic Plan + Year for dummy modules.

Fields

For each Module field extract record for the return with a Derived Value, the record is compared with the corresponding submitted data (MST) record:

- If the Derived Value of the field is NULL ERROR, set Field Status to *Error*.
- If the combination of Institution, Module ID and Field doesn't exist in the submitted data record, set Field Status to *New*.
- If the Reported Value in the extract is different to the Reported Value in the most recent submitted data record, set Field Status to *Amended*.
- Set Field Status to *Unchanged*, that is, Reported Value in the extract is the same as in the most recent submitted data record.

Entities

For each Module entity extract record for the return, the record is compared with the corresponding submitted data (MST) record:

- If at least one field has Field Status of Error, set Entity Status to *Error*.
- If the combination of Institution and Module ID doesn't exist in the submitted data record, set Entity Status to *New*.
- If there are one or more child Field extract records with Field Status of *New* or *Amended*, set Entity Status to *Amended*.
- If there are one or more child Entity extract records with Entity Status of *New*, *Amended*, *Identify* or *Delete*, set Entity Status to *Identify*.
- Set Entity Status to *Unchanged*, that is, there are no child entities or fields with status *New* or *Amended* that need to be reported.

Module Cost Centre

Child Entities: None

Each entity is uniquely identified by the Cost Centre code. In cases where multiple entities were previously reported and one or more no longer apply, extract entities are created with Entity Status of *Delete*.

Fields

For each Module Cost Centre field extract record for the return with a Derived Value, the record is compared with the corresponding submitted data (MST) record:

- If the Derived Value of the field is NULL ERROR, set Field Status to *Error*.
- If the combination of Institution, Module ID, Cost Centre and Field doesn't exist in the submitted data record, set Field Status to *New*.
- If the combination exists in the extract record and the Entity Status in the most recent submitted data record is Delete, set Field Status to *New*.
- If the Reported Value in the extract is different to the Reported Value in the most recent submitted data record, set Field Status to *Amended*.

Proportion may be set to *Amended* if the cost extract has previously been reported but the proportion has changed.

- Set Field Status to *Unchanged*, that is, set Field Status to *Amended*.

Entities

For each Module Cost Centre entity extract record for the return, the record is compared with the corresponding submitted data (MST) record:

- If at least one field has Field Status of Error, set Entity Status to *Error*.
- If the combination of Institution, Module ID and Cost Centre doesn't exist in the submitted data record, set Entity Status to *New*.
- If the combination exists in the extract record and the Entity Status in the most recent submitted data record is Delete, set Entity Status to *New*.
- If there are one or more Field extract records with Field Status of *New* or *Amended*, set Entity Status to *Amended*.
- Set Entity Status to *Unchanged*, that is, either there are no fields or all the fields have Field Status of *Unchanged*.
- For any existing entities in extract where the Cost Centre for the entity doesn't appear in the submitted data record, create a new entity using the Cost Centre with Entity Status of *Delete*.

A new field extract record for the COSTCN is created with Field Status of *Delete* and Derivation Step of 99.

Module Delivery Role

Child Entities: None

Each entity is uniquely identified by HESA identifier. In cases where entities were previously reported and one or more no longer apply, extract entities are created with Entity Status of *Delete*.

Fields

For each Module Delivery Role field extract record for the return with a Derived Value, the record is compared with the corresponding submitted data (MST) record:

- If the Derived Value of the field is NULL ERROR, set Field Status to *Error*.
- If the combination of Institution, Module ID, HESA ID and Field doesn't exist in the submitted data record, set Field Status to *New*.
- If the combination exists in the extract record and the Entity Status in the most recent submitted data record is Delete, set Field Status to *New*.
- If the Reported Value in the extract is different to the Reported Value in the most recent submitted data record, set Field Status to *Amended*.
- Set Field Status to *Unchanged*, that is, Reported Value in the extract is the same as in the most recent submitted data record

Entities

For each Module Delivery Role entity extract record for the return, the record is compared with the corresponding submitted data (MST) record:

- If at least one field has Field Status of Error, set Entity Status to *Error*.
- If the combination of Institution, Module ID and HESA ID doesn't exist in the submitted data record, set Entity Status to *New*.
- If the combination exists in the extract record and the Entity Status in the most recent submitted data record is Delete, set Entity Status to *New*.
- If there are one or more Field extract records with Field Status of *New* or *Amended*, set Entity Status to *Amended*.
- Set Entity Status to *Unchanged*, that is, either there are no fields or all the fields have Field Status of *Unchanged*.
- For any existing entities in extract where the Role ID for the entity doesn't appear in the submitted data record, create a new entity using the Role ID with Entity Status of *Delete*.

A new field extract record for MDRHESAID is created with Field Status of *Delete* and Derivation Step of 99.

Module Subject

Child Entities: None

Each entity is uniquely identified by the HECOS subject code. In cases where multiple entities were previously reported and one or more no longer apply, extract entities are created with Entity Status of *Delete*.

Fields

For each Module Subject field extract record for the return with a Derived Value, the record is compared with the corresponding submitted data (MST) record:

- If the Derived Value of the field is NULL ERROR, set Field Status to *Error*.
- If the combination of Institution, Module ID, Subject and Field doesn't exist in the submitted data record, set Field Status to *New*.
- If the combination exists in the extract record and the Entity Status in the most recent submitted data record is *Delete*, set Field Status to *New*.
- If the Reported Value in the extract is different from the Reported Value in the most recent submitted data record, set Field Status to *Amended*. Proportion may be set to *Amended* if the subject has previously been reported but the proportion has changed.
- Set Field Status to *Unchanged*, that is, Reported Value in the extract is the same as in the most recent submitted data record.

Entities

For each Module Subject entity extract record for the return, the record is compared with the corresponding submitted data (MST) record:

- If at least one field has Field Status of Error, set Entity Status to *Error*.
- If the combination of Institution, Module ID and Subject doesn't exist in the submitted data record, set Entity Status to *New*.
- If the combination exists in the extract record and the Entity Status in the most recent submitted data record is *Delete*, set Entity Status to *New*.
- If there are one or more child Field extract records with Field Status of *New* or *Amended*, set Entity Status to *Amended*.
- Set Entity Status to *Unchanged*, that is either there are no child fields extract or all the fields have Field Status of *Unchanged*.
- For any existing entities in extract where the subject for the entity doesn't appear in the submitted data record, create a new entity using the Subject with Entity Status of *Delete*. Create a new field extract record for MODSBJ with Field Status of *Delete*.

Qualification

Child Entities: Awarding Body Role, Qualification Subject

Each entity is uniquely identified by Qualification ID that is derived from the HESA Qualification record.

Field

For each Qualification field extract record for the return with a Derived Value, the record is compared with the corresponding submitted data (MST) record:

- If the Derived Value of the field is NULL ERROR, set Field Status to *Error*.

- If the combination of Institution, Qualification ID and Field doesn't exist in the submitted data record, set Field Status to *New*.
- If the Reported Value in the extract is different to the Reported Value in the most recent submitted data record, set Field Status to *Amended*.
- Set Field Status to *Unchanged*, that is, Reported Value in the extract is the same as in the most recent submitted data record.

Entities

For each Qualification entity extract record for the return, the record is compared with the corresponding submitted data (MST) record:

- If at least one field has Field Status of Error, set Entity Status to *Error*.
- If the combination of Institution and Qualification ID doesn't exist in the submitted data record, set Entity Status to *New*.
- If there are one or more child Field extract records with Field Status of *New* or *Amended*, set Entity Status to *Amended*.
- If there are one or more child Entity extract records with Entity Status of *New*, *Amended*, *Identify*, or *Delete*, set Entity Status to *Identify*.
- Set Entity Status to *Unchanged*, that is, there are no child entities or fields with status *New* or *Amended* that need to be reported.

Awarding Body Role

Child Entities: None

Each entity is uniquely identified by the single Awarding Body ID field. In cases where multiple entities were previously reported and one or more no longer apply, extract entities are created with Entity Status of *Delete*.

Field

For each Awarding Body Role field extract record for the return with a Derived Value, the record is compared with the corresponding submitted data (MST) record:

- If the Derived Value of the field is NULL ERROR, set Field Status to *Error*.
- If the combination of Institution, Qualification ID, Awarding Body ID and Field doesn't exist in the submitted data record, set Field Status to *New*.
- If the combination exists in the extract record and the Entity Status in the most recent submitted data record is *Delete*, set Field Status to *New*.
- If the Reported Value in the extract is different to the Reported Value in the most recent submitted data record, set Field Status to *Amended*.
- Set Field Status to *Unchanged*, that is, Reported Value in the extract is the same as in the most recent submitted data record.

Entities

For each Awarding Body Role entity extract record for the return, the record is compared with the corresponding submitted data (MST) record:

- If at least one field has Field Status of *Error*, set Entity Status to *Error*.
- If the combination of Institution, Qualification ID and Awarding Body ID doesn't exist in the submitted data record, set Entity Status to *New*.
- If the combination exists in the extract record and the Entity Status in the most recent submitted data record is *Delete*, set Entity Status to *New*.
- If there are one or more Field extract records with Field Status of *New* or *Amended*, set Entity Status to *Amended*.
- Set Entity Status to *Unchanged*, that is, either there are no fields or all the fields have Field Status of *Unchanged*.
- For any existing entities in extract where the Awarding Body ID for the entity doesn't appear in the submitted data record, create a new entity using the Awarding Body ID with Entity Status of *Delete*. Create a new field extract record for AWARDINGBODYID with Field Status of *Delete*.

Qualification Subject

Child Entities: None

Each entity is uniquely identified by the HECOS subject code. In cases where multiple entities were previously reported and one or more no longer apply, extract entities are created with Entity Status of *Delete*.

Field

For each Qualification Subject field extract record for the return with a Derived Value, the record is compared with the corresponding submitted data (MST) record:

- If the Derived Value of the field is NULL ERROR, set Field Status to *Error*.
- If the combination of Institution, Qualification ID, Subject and Field doesn't exist in the submitted data record, set Field Status to *New*.
- If the combination exists in the extract record and the Entity Status in the most recent submitted data record is *Delete*, set Field Status to *New*.
- If the Reported Value in the extract is different to the Reported Value in the most recent submitted data record, set Field Status to *Amended*. Proportion may be set to *Amended* if the subject has previously been reported but the proportion has changed.
- If the field is QUALITT and the Reported Value in the extract is not null and any of the other fields for the entity (i.e. QUALPROPORTION) have been set to a Field Status of *Amended*, set Field Status to *Amended*. This condition is included to ensure values for QUALITT are always included in the XML when the Proportion has changed.

- Set Field Status to *Unchanged*, that is, Reported Value in the extract is the same as in the most recent submitted data record.

Entities

For each Qualification Subject entity extract record for the return, the record is compared with the corresponding submitted data (MST) record:

- If at least one field has Field Status of Error, set Entity Status to *Error*.
- If the combination of Institution, Qualification ID and Subject doesn't exist in the submitted data record, set Entity Status to *New*.
- If the combination exists in the extract record and the Entity Status in the most recent submitted data record is *Delete*, set Entity Status to *New*.
- If there are one or more Field extract records with Field Status of *New* or *Amended*, set Entity Status to *Amended*.
- Set Entity Status to *Unchanged*, that is, either there are no fields or all the fields have Field Status of *Unchanged*.
- For any existing entities in extract where the subject for the entity doesn't appear in the submitted data record, create a new entity using Subject with Entity Status of *Delete*. Create a new field extract record QUALSUBJECT with Field Status of *Delete*.

Session Year

Child Entity: None

Each entity is uniquely identified by Session Year ID.

Fields

For each Session Year field extract record for the return with a Derived Value, the record is compared with the corresponding submitted data (MST) record:

- If the Derived Value of the field is NULL ERROR, set Field Status to *Error*.
- If the combination of Institution, Session Year ID and Field doesn't exist in the submitted data record, set Field Status to *New*.
- If the Reported Value in the extract is different to the Reported Value in the most recent submitted data record, set Field Status to *Amended*.
- Set Field Status to *Unchanged*, that is, Reported Value in the extract is the same as in the most recent submitted data record.

Entities

For each Session Year entity extract record for the return, the record is compared with the corresponding submitted data (MST) record:

- If at least one field has Field Status of Error, set Entity Status to *Error*.

- If the combination of Institution and Session Year ID doesn't exist in the submitted data record, set Entity Status to *New*.
- If there are one or more Field extract records with Field Status of *New* or *Amended*, set Entity Status to *Amended*.
- Set Entity Status to *Unchanged*, that is, either there are no fields or all the fields have Field Status to *Unchanged*.

Venue

Child Entity: None

Each entity is uniquely identified by Venue ID.

Fields

For each Venue field extract record for the return with a Derived Value, the record is compared with the corresponding submitted data (MST) record:

- If the Derived Value of the field is NULL ERROR, set Field Status to *Error*.
- If the combination of Institution, Venue ID and Field doesn't exist in the submitted data record, set Field Status to *New*.
- If the Reported Value in the extract is different to the Reported Value in the most recent submitted data record, set Field Status to *Amended*.
- Set Field Status to *Unchanged*, that is, Reported Value in the extract is the same as in the most recent submitted data record.

Entities

For each Venue entity extract record for the return, the record is compared with the corresponding submitted data (MST) record:

- If at least one field has Field Status of Error, set Entity Status to *Error*.
- If the combination of Institution and Venue ID doesn't exist in the submitted data record, set Entity Status to *New*.
- If there are one or more Field extract records with Field Status of *New* or *Amended*, set Entity Status to *Amended*.
- Set Entity Status to *Unchanged*, that is, either there are no fields or all the fields have Field Status to *Unchanged*.

Student Course Session

Child Entities: Funding and Monitoring, Funding Body, Module Instance, Off Venue Activity, Reference Period Student Load, Session Status, Student Financial Support, Study Location, Supervisor Allocation

Each entity is uniquely identified by the Student Course Session Identifier.

Fields

For each Student Course Session field extract record for the return with a Derived Value, the record is compared with the corresponding submitted data (MST) record:

- If the Derived Value of the field is NULL ERROR, set Field Status to *Error*.
- If the combination of INSTITUTION, SID, NUMHUS, SC Session ID, and FIELD doesn't exist in the submitted data record, set Field Status to *New*.
- If the Reported Value in the extract is different to the Reported Value in the most recent submitted data record, set Field Status to *Amended*.
- Set Field Status to *Unchanged*, that is, Reported Value in the extract is the same as in the most recent submitted data record.

Entities

For each Student Course Session entity extract record for the return, the record is compared with the corresponding submitted data (MST) record:

- If at least one field has Field Status of *Error*, set Entity Status to *Error*.
- If the combination of INSTITUTION, SID, NUMHUS, and SC Session ID doesn't exist in the submitted data record, set Entity Status to *New*.
- If there are one or more Field extract records with Field Status of *New* or *Amended*, set Entity Status to *Amended*.
- If there are one or more child Entity extract records with Entity Status of *New*, *Amended*, *Identify*, or *Delete*, set Entity Status to *Identify*.
- Set Entity Status to *Unchanged*, that is, there are no child entities or fields with status *New* or *Amended* that need to be reported.

Funding and Monitoring

Child Entities: None

Fields

For each Funding and Monitoring field extract record for the return with a Derived Value, the record is compared with the corresponding submitted data (MST) record:

- If the Derived Value of the field is NULL ERROR, set Field Status to *Error*.
- If the combination of Institution, SID, NUMHUS, SC Session ID and Field doesn't exist in the submitted data record, set Field Status to *New*.
- If the Reported Value in the extract is different to the Reported Value in the most recent submitted data record, set Field Status to *Amended*.
- Set Field Status to *Unchanged*, that is, Reported Value in the extract is the same as in the most recent submitted data record.

Entities

For each Funding and Monitoring entity extract record for the return, the record is compared with the corresponding submitted data (MST) record:

- If at least one field has Field Status of *Error*, set Entity Status to *Error*.
- If the combination of Institution, SID, NUMHUS, and SC Session ID doesn't exist in the submitted data record, set Entity Status to *New*.
- If there are one or more Field extract records with Field Status of *New* or *Amended*, set Entity Status to *Amended*.
- Set Entity Status to *Unchanged*, that is, either there are no child fields extract or all the fields have Field Status of *Unchanged*.

Funding Body

Child Entities: None

Each entity is uniquely identified by the single Funding Body field. In cases where multiple entities were previously reported and one or more no longer apply, extract entities are created with Entity Status of *Delete*.

Fields

For each Funding Body field extract record for the return with a Derived Value, the record is compared with the corresponding submitted data (MST) record:

- If the Derived Value of the field is NULL ERROR, set Field Status to *Error*.
- If the combination of Institution, SID, NUMHUS, SC Session ID, Funding Body and Field doesn't exist in the submitted data record, set Field Status to *New*.
- If the combination exists in the extract record and the Entity Status in the most recent submitted data record is *Delete*, set Field Status to *New*.
- If the Reported Value in the extract is different to the Reported Value in the most recent submitted data record, set Field Status to *Amended*.
- Set Field Status to *Unchanged*, that is, Reported Value in the extract is the same as in the most recent submitted data record.

Entities

For each Funding Body entity extract record for the return, the record is compared with the corresponding submitted data (MST) record:

- If at least one field has Field Status of *Error*, set Entity Status to *Error*.
- If the combination of Institution, SID, NUMHUS, SC Session ID and Funding Body doesn't exist in the submitted data record, set Entity Status to *New*.
- If the combination exists in the extract record and the Entity Status in the most recent submitted data record is *Delete*, set Entity Status to *New*.

- If there are one or more Field extract records with Field Status of *New* or *Amended*, set Entity Status to *Amended*.
- Set Entity Status to *Unchanged*, that is, either there are no child fields extract or all the fields have Field Status of *Unchanged*.
- For any existing entities in extract where the Funding Body for the entity doesn't appear in the submitted data record for the Student Course Session, create a new entity using the Funding Body with Entity Status of *Delete*. A new field extract record for FUNDINGBODY is created with Field Status of *Delete*.

Module Instance

Child Entities: None

Each entity is uniquely identified by the Module Instance Identifier for the Student Course Session that is derived as Student Course Session ID + Module ID.

Fields

For each Module Instance field extract record for the return with a Derived Value, the record is compared with the corresponding submitted data (MST) record:

- If the Derived Value of the field is NULL ERROR, set Field Status to *Error*.
- If the combination of Institution, SID, NUMHUS, SC Session ID, Module Instance ID and Field doesn't exist in the submitted data record, set Field Status to *New*.
- If the Reported Value in the extract is different to the Reported Value in the most recent submitted data record, set Field Status to *Amended*.
- Set Field Status to *Unchanged*, that is, Reported Value in the extract is the same as in the most recent submitted data record.

Entities

For each Module Instance entity extract record for the return, the record is compared with the corresponding submitted data (MST) record:

- If at least one field has Field Status of *Error*, set Entity Status to *Error*.
- If the combination of Institution, SID, NUMHUS, SC Session ID and Module Instance ID doesn't exist in the submitted data record, set Entity Status to *New*.
- If there are one or more Field extract records with Field Status of *New* or *Amended*, set Entity Status to *Amended*.
- If there are one or more child Entity extract records with Entity Status of *New*, *Amended*, *Identify*, or *Delete*, set Entity Status to *Identify*.
- Set Entity Status to *Unchanged*, that is, there are no child entities or fields with status *New* or *Amended* that need to be reported.

Off Venue Activity

Child Entities: None

Each entity is uniquely identified by Off Venue Activity ID that is derived as Student Course Session ID + Sequence Number defaulting to 1 for the first entity and incremented for subsequent entities.

Fields

For each Off Venue Activity field extract record for the return with a Derived Value, the record is compared with the corresponding submitted data (MST) record:

- If the Derived Value of the field is NULL ERROR, set Field Status to *Error*.
- If the combination of Institution, SID, NUMHUS, SC Session ID, Activity ID and Field doesn't exist in the submitted data record, set Field Status to *New*.
- If the Reported Value in the extract is different to the Reported Value in the most recent submitted data record, set Field Status to *Amended*.
- Set Field Status to *Unchanged*, that is, Reported Value in the extract is the same as in the most recent submitted data record.

Entities

For each Off Venue Activity entity extract record for the return, the record is compared with the corresponding submitted data (MST) record:

- If at least one field has Field Status of *Error*, set Entity Status to *Error*.
- If the combination of Institution, SID, NUMHUS, SC Session ID and Activity ID doesn't exist in the submitted data record, set Entity Status to *New*.
- If there are one or more Field extract records with Field Status of *New* or *Amended*, set Entity Status to *Amended*.
- Set Entity Status to *Unchanged*, that is, either there are no child fields extract or all the fields have Field Status of *Unchanged*.

Reference Period Student Load

Child Entities: None

Each entity is uniquely identified by a combination of Year and Reference Period for the Student Course Session.

Fields

For each Full Time Equivalence field extract record for the return with a Derived Value, the record is compared with the corresponding submitted data (MST) record:

- If the Derived Value of the field is NULL ERROR, set Field Status to *Error*.

- If the combination of Institution, SID, NUMHUS, SC Session ID, Year, Reference Period and Field doesn't exist in the submitted data record, set Field Status to *New*.
- If the Reported Value in the extract is different to the Reported Value in the most recent submitted data record, set Field Status to *Amended*.
- Set Field Status to *Unchanged*, that is, Reported Value in the extract is the same as in the most recent submitted data record.

Entities

For each Full Time Equivalence entity extract record for the return, the record is compared with the corresponding submitted data (MST) record:

- If at least one field has Field Status of *Error*, set Entity Status to *Error*.
- If the combination of Institution, SID, NUMHUS, SC Session ID, Year and Reference Period doesn't exist in the submitted data record, set Entity Status to *New*.
- If there are one or more Field extract records with Field Status of *New* or *Amended*, set Entity Status to *Amended*.
- Set Entity Status to *Unchanged*, that is, either there are no child fields extract or all the fields have Field Status of *Unchanged*.

Session Status

Child Entities: None

Each entity is uniquely identified by the combination of SC Session ID and Status Valid From date. If the derived value for STATUSVALIDFROM is after the SCSSTARTDATE (that is, the second or subsequent entity), the Entity Status and Field Status for each non-null field is set to *New*. Otherwise, the following processing is done:

If there are no existing Session Status entities in extract for the Student Course Session (matched on INSTITUTION, SID, NUMHUS, and SC Session ID), then:

- If the Derived Value for STATUSCHANGEDTO is 01 (Active), the Entity Status and Field Status for each non-null field is set to *Unchanged*.

An entity does not need to be reported for Active students that have not previously been reported as dormant/writing up.

- If the Derived Value for STATUSCHANGEDTO is any other value, the Entity Status and Field Status for each non-null field is set to *New*.
- If the Derived Value for STATUSVALIDFROM is the same or later than the SCSSTARTDATE, the derived values are not changed.

If there is at least one existing Session Status entity in extract for the Student Course Session, then:

- If the Derived Value for STATUSCHANGEDTO is the same as the reported value in extract for the existing entity with the latest STATUSVALIDFROM date (i.e. the most recently reported previous entity), the Entity Status and Field Status for each non-null field is set to *Unchanged*.

- If the Derived Value for STATUSCHANGEDTO is different to the reported value in extract for the existing entity with the latest STATUSVALIDFROM date (i.e. the most recently reported previous entity), then:
 - If the Derived Value for STATUSVALIDFROM in the extract is later than the latest reported STATUSVALIDFROM date in extract, in the extract the Entity Status and Field Status for each non-null field is set to *New*.

No changes are made to the derived STATUSVALIDFROM date.

- If the Derived Value for STATUSVALIDFROM in the extract is on or before the most recently reported STATUSVALIDFROM date in extract, the new entity is updated as an amendment to the previously reported entity. The Entity Status and the Field Status for STATUSCHANGEDTO are set to *Amended*. The Derived Value and Reported Value for STATUSVALIDFROM in the extract are updated to the latest Reported Value for STATUSVALIDFROM from extract along with the key SSR_HE_VALID_FROM. The derivation step is set to 99 and Field Status is set to *Unchanged*.

Student Financial Support

Child Entities: None

Each entity is uniquely identified by Financial Support Type. In cases where multiple entities were previously reported and one or more no longer apply, extract entities are created with Entity Status of Delete.

Fields

For each Student Financial Support field extract record for the return with a Derived Value, the record is compared with the corresponding submitted data (MST) record:

- If the Derived Value of the field is NULL ERROR, set Field Status to *Error*.
- If the combination of Institution, SID, NUMHUS, Financial Support Type and Field doesn't exist in the submitted data record, set Field Status to *New*.
- If the combination exists in the extract record and the Entity Status in the most recent submitted data record is *Delete*, set Field Status to *New*.
- If the Reported Value in the extract is different to the Reported Value in the most recent submitted data record, set Field Status to *Amended*.
- Set Field Status to *Unchanged*, that is, Reported Value in the extract is the same as in the most recent submitted data record.

Entities

For each Student Initiatives entity extract record for the return, the record is compared with the corresponding submitted data (MST) record:

- If at least one field has Field Status of Error, set Entity Status to *Error*.

- If the combination of Institution, SID, NUMHUS, and Financial Support Type doesn't exist in the submitted data record, set Entity Status to *New*.
- If the combination exists in the extract record and the Entity Status in the most recent submitted data record is *Delete*, set Entity Status to *New*.
- If there are one or more Field extract records with Field Status of *New* or *Amended*, set Entity Status to *Amended*.
- Set Entity Status to *Unchanged*, that is, either there are no child fields extract or all the fields have Field Status of *Unchanged*.
- For any existing entities in extract where the FINSUPID for the entity doesn't appear in the submitted data record, create a new entity using the FINSUPID with Entity Status of *Delete*. A new field extract record for FINSUPID is created with Field Status of *Delete*. SID, NUMHUS and NUMREG are not included for a delete.

Study Location

Child Entities: None

Each entity is uniquely identified by Study Location Identifier that is derived using the SCSESSIONID of the parent Student Course Session entity and a sequence number that defaults to 1 for the first extract record and is then incremented for subsequent records in the extract. As the ID includes a sequence number delete processing is not included.

Fields

For each Study Location field extract record for the return with a Derived Value, the record is compared with the corresponding submitted data (MST) record:

- If the Derived Value of the field is NULL ERROR, set Field Status to *Error*.
- If the combination of Institution, SID, NUMHUS, SC Session ID, Study Location ID and Field doesn't exist in the submitted data record, set Field Status to *New*.
- If the Reported Value in the extract is different to the Reported Value in the most recent submitted data record, set Field Status to *Amended*.
- Set Field Status to *Unchanged*, that is, Reported Value in the extract is the same as in the most recent submitted data record.

Entities

For each Study Location entity extract record for the return, the record is compared with the corresponding submitted data (MST) record:

- If at least one field has Field Status of Error, set Entity Status to *Error*.
- If the combination of Institution, SID, NUMHUS, SC Session ID and Study Location ID doesn't exist in the submitted data record, set Entity Status to *New*.
- If there are one or more Field extract records with Field Status of *New* or *Amended*, set Entity Status to *Amended*.

- Set Entity Status to *Unchanged*, that is, either there are no child fields extract or all the fields have Field Status of *Unchanged*.

Supervisor Allocation

Child Entities: None

Each entity is uniquely identified by the Supervisor Allocation Identifier that is derived as SCSESSIONID of the parent Student Course Session + Sequence Number defaulting to 1 for the first entity and incrementing for subsequent entities. As the ID includes a sequence number delete processing is not included.

Fields

For each Supervisor Allocation field extract record for the return with a Derived Value, the record is compared with the corresponding submitted data (MST) record:

- If the Derived Value of the field is NULL ERROR, set Field Status to *Error*.
- If the combination of Institution, SID, NUMHUS, SC Session ID, Supervisor Allocation ID and Field doesn't exist in the submitted data record, set Field Status to *New*.
- If the Reported Value in the extract is different to the Reported Value in the most recent submitted data record, set Field Status to *Amended*.
- Set Field Status to *Unchanged*, that is, Reported Value in the extract is the same as in the most recent submitted data record.

Entities

For each Supervisor Allocation entity extract record for the return, the record is compared with the corresponding submitted data (MST) record:

- If at least one field has Field Status of *Error*, set Entity Status to *Error*.
- If the combination of Institution, SID, NUMHUS, SC Session ID and Supervisor Allocation ID doesn't exist in the submitted data record, set Entity Status to *New*.
- If there are one or more Field extract records with Field Status of *New* or *Amended*, set Entity Status to *Amended*.
- Set Entity Status to *Unchanged*, that is, either there are no child fields extract or all the fields have Field Status of *Unchanged*.

Engagement

Child Entities: Collaborative Provision,Entry Qualification Award,Entry Profile,Leaver,Qualification Awarded,Student Accreditation Aim,Student Initiatives,Student Course Session

Each entity is uniquely identified by Student Identifier (SID) and Engagement Number (NUMHUS).

Fields

For each Engagement field extract record for the return with a Derived Value, the record is compared with the corresponding submitted data (MST) record:

- If the Derived Value of the field is NULL ERROR, set Field Status to *Error*.
- If the combination of Institution, SID, NUMHUS and Field doesn't exist in the submitted data record, set Field Status to *New*.
- If the Reported Value in the extract is different to the Reported Value in the most recent submitted data record, set Field Status to *Amended*.
- Set Field Status to *Unchanged*, that is, Reported Value in the extract is the same as in the most recent submitted data record.

Entities

For each Engagement entity extract record for the return, the record is compared with the corresponding submitted data (MST) record:

- If at least one field has Field Status of *Error*, set Entity Status to *Error*.
- If the combination of Institution, SID and NUMHUS doesn't exist in the submitted data record, set Entity Status to *New*.
- If there are one or more Field extract records with Field Status of *New* or *Amended*, set Entity Status to *Amended*.
- If there are one or more child Entity extract records with Entity Status of *New*, *Amended*, *Identify*, or *Delete*, set Entity Status to *Identify*.
- Set Entity Status to *Unchanged*, that is, either there are no child fields extract or all the fields have Field Status of *Unchanged*.

Collaborative Provision

Child Entities: None

Each entity is uniquely identified using the key values of the parent entity (SID, NUMHUS) since only one entity can be reported for each Engagement entity.

Fields

For each Collaborative Provision field extract record for the return with a Derived Value, the record is compared with the corresponding submitted data (MST) record:

- If the Derived Value of the field is NULL ERROR, set Field Status to *Error*.
- If the combination of Institution, SID, NUMHUS and Field doesn't exist in the submitted data record, set Field Status to *New*.
- If the Reported Value in the extract is different to the Reported Value in the most recent submitted data record, set Field Status to *Amended*.

- Set Field Status to *Unchanged*, that is, Reported Value in the extract is the same as in the most recent submitted data record.

Entities

For each Collaborative Provision entity extract record for the return, the record is compared with the corresponding submitted data (MST) record:

- If at least one field has Field Status of *Error*, set Entity Status to *Error*.
- If the combination of Institution, SID and NUMHUS doesn't exist in the submitted data record, set Entity Status to *New*.
- If there are one or more Field extract records with Field Status of *New* or *Amended*, set Entity Status to *Amended*.
- Set Entity Status to *Unchanged*, that is, either there are no fields or all the fields have Field Status of *Unchanged*.

Entry Qualification Award

Child Entities: Entry Qualification Subject

Each entity is uniquely identified by Entry Qualification Awarded Identifier that is derived as SID and a Sequence Number that defaults to 1 and is incremented for each new entity. In cases where multiple entities were previously reported and one or more no longer apply, extract entities are created with Entity Status of *Delete*.

Fields

For each Entry Qualification Award field extract record for the return, the record is compared with the corresponding submitted data (MST) record:

- If the Derived Value of the field is NULL ERROR, set Field Status to *Error*.
- If the combination of Institution, SID, Entry Qualification ID and Field doesn't exist in the submitted data record, set Field Status to *New*.
- If the Reported Value in the extract is different to the Reported Value in the most recent submitted data record, set Field Status to *Amended*.
- Set Field Status to *Unchanged*, that is, Reported Value in the extract is the same as in the most recent submitted data record.

Entities

For each Entry Qualification Award entity extract record for the return, the record is compared with the corresponding submitted data (MST) record:

- If at least one field has Field Status of *Error*, set Entity Status to *Error*.
- If the combination of Institution, SID and Entry Qualification ID doesn't exist in the submitted data record, set Entity Status to *New*.

- If there are one or more child Field extract records with Field Status of *New* or *Amended*, set Entity Status to *Amended*.
- If there are one or more child Entity extract records with Entity Status of *New*, *Amended*, *Identify*, or *Delete*, set Entity Status to *Identify*.
- Set Entity Status to *Unchanged*, that is, there are no child entities or fields with status *New* or *Amended* that need to be reported.

Entry Qualification Subject

Child Entities: None

The entity only has a single Subject Identifier. In cases where multiple entities were previously reported and one or more no longer apply, extract entities are created with Entity Status of *Delete*.

Fields

For each Entry Qualification Subject field extract record for the return, the record is compared with the corresponding submitted data (MST) record:

- If the Derived Value of the field is NULL ERROR, set Field Status to *Error*.
- If the combination of Institution, SID, Entry Qualification ID, Subject ID and Field doesn't exist in the submitted data record, set Field Status to *New*.
- If the combination exists in the extract record and the Entity Status in the most recent submitted data record is *Delete*, set Field Status to *New*.
- If the Reported Value in the extract is different to the Reported Value in the most recent submitted data record, set Field Status to *Amended*.

Note: As there is currently only one key field for the entity this step will not be followed

- Set the Field Status to *Unchanged*, that is, Reported Value in the extract is the same as in the most recent submitted data record.

Entities

For each Entry Qualification Subject entity extract record for the return, the record is compared with the corresponding submitted data (MST) record:

- If at least one field has Field Status of *Error*, set Entity Status to *Error*.
- If the combination of Institution, SID, Entry Qualification ID and Subject ID doesn't exist in the submitted data record, set Entity Status to *New*.
- If the combination exists in the extract record and the Entity Status in the most recent submitted data record is *Delete*, set Entity Status to *New*.
- If there are one or more child Field extract records with Field Status of *New* or *Amended*, set Entity Status to *Amended*.
- Set Entity Status to *Unchanged*, that is, either there are no child fields extract or all the fields have Field Status of *Unchanged*.

- For any existing entities in extract where the Subject for the entity doesn't appear in the submitted data record, create a new entity using the Subject with Entity Status of *Delete*. A new field extract record for the SUBJECTID is created with Field Status of *Delete*.

Entry Profile

Child Entities: None

Each entity is uniquely identified using the key values of the Engagement (SID, NUMHUS) since only one entity can be reported for each Engagement entity.

Fields

For each Entry Profile field extract record for the return with a Derived Value, the record is compared with the corresponding submitted data (MST) record:

- If the Derived Value of the field is NULL ERROR, set Field Status to *Error*.
- If the combination of Institution, SID, NUMHUS and Field doesn't exist in the submitted data record, set Field Status to *New*.
- If the Reported Value in the extract is different to the Reported Value in the most recent submitted data record, set Field Status to *Amended*.
- Set Field Status to *Unchanged*, that is, Reported Value in the extract is the same as in the most recent submitted data record.

Entities

For each Entry Profile entity extract record for the return, the record is compared with the corresponding submitted data (MST) record:

- If at least one field has Field Status of *Error*, set Entity Status to *Error*.
- If the combination of Institution, SID and NUMHUS doesn't exist in the submitted data record, set Entity Status to *New*.
- If there are one or more Field extract records with Field Status of *New* or *Amended*, set Entity Status to *Amended*.
- Set Entity Status to *Unchanged*, that is, either there are no child fields extract or all the fields have Field Status of *Unchanged*.

Leaver

Child Entities: None

Each entity is uniquely identified using the key values of the Engagement entity (SID, NUMHUS) since only one entity can be reported for each Engagement entity.

Fields

For each Leaver field extract record for the return with a Derived Value, the record is compared with the corresponding submitted data (MST) record:

- If the Derived Value of the field is NULL ERROR, set Field Status to *Error*.
- If the combination of Institution, SID, NUMHUS, and Field doesn't exist in the submitted data record, set Field Status to *New*.
- If the Reported Value in the extract is different to the Reported Value in the most recent submitted data record, set Field Status to *Amended*.
- Set Field Status to *Unchanged*, that is, Reported Value in the extract is the same as in the most recent submitted data record

Entities

For each Leaver entity extract record for the return, the record is compared with the corresponding submitted data (MST) record:

- If at least one field has Field Status of Error, set Entity Status to *Error*.
- If the combination of Institution, SID, and NUMHUS doesn't exist in the submitted data record, set Entity Status to *New*.
- If there are one or more Field extract records with Field Status of *New* or *Amended*, set Entity Status to *Amended*.
- Set the Entity Status to *Unchanged*, that is, either there are no child fields extract or all the fields have Field Status of *Unchanged*.

Qualification Awarded

Child Entities: Qualification Award Accreditation

Each entity is uniquely identified by Qualification Awarded Identifier that is derived as the same value as QUALID (unique identifier for qualification).

Fields

For each Qualification Awarded field extract record for the return with a Derived Value, the record is compared with the corresponding submitted data (MST) record:

- If the Derived Value of the field is NULL ERROR, set Field Status to *Error*.
- If the combination of Institution, SID, NUMHUS, Qualification Award ID, Accreditation ID and Field doesn't exist in the submitted data record, set Field Status to *New*.
- If the Reported Value in the extract is different to the Reported Value in the most recent submitted data record, set Field Status to *Amended*.
- Set Field Status to *Unchanged*, that is, Reported Value in the extract is the same as in the most recent submitted data record.

Entities

For each Qualification Awarded entity extract record for the return, the record is compared with the corresponding submitted data (MST) record:

- If at least one field has Field Status of Error, set Entity Status to *Error*.
- If the combination of Institution, SID, NUMHUS, and Qualification Award ID doesn't exist in the submitted data record, set Entity Status to *New*.
- If there are one or more child Field extract records with Field Status of New or Amended, set Entity Status to *Amended*.
- If there are one or more child Entity extract records with Entity Status of *New*, *Amended*, *Identify*, or *Delete*, set Entity Status to *Identify*.
- Set Entity Status to *Unchanged*, that is, there are no child entities or fields with status *New* or *Amended* that need to be reported.

Qualification Award Accreditation

Child Entities: None

The entity only has a single Accreditation Identifier. In cases where multiple entities were previously reported and one or more no longer apply, extract entities are created with Entity Status of *Delete*.

Fields

For each Qualification Award Accreditation field extract record for the return with a Derived Value, the record is compared with the corresponding submitted data (MST) record:

- If the Derived Value of the field is NULL ERROR, set Field Status to *Error*.
- If the combination of Institution, SID, NUMHUS, Qualification Award ID, Accreditation ID and Field doesn't exist in the submitted data record, set Field Status to *New*.
- If the combination exists in the extract record and the Entity Status in the most recent submitted data record is *Delete*, set Field Status to *New*.
- If the Reported Value in the extract is different to the Reported Value in the most recent submitted data record, set Field Status to *Amended*.
- Set Field Status to *Unchanged*, that is, Reported Value in the extract is the same as in the most recent submitted data record.

Entities

For each Qualification Award Accreditation entity extract record for the return, the record is compared with the corresponding submitted data (MST) record:

- If at least one field has Field Status of *Error*, set Entity Status to *Error*.
- If the combination of Institution, SID, NUMHUS, Qualification Award ID and Accreditation ID doesn't exist in the submitted data record, set Entity Status to *New*.

- If the combination exists in the extract record and the Entity Status in the most recent submitted data record is *Delete*, set Entity Status to *New*.
- If there are one or more Field extract records with Field Status of *New* or *Amended*, set Entity Status to *Amended*.
- Set the Entity Status to *Unchanged*, that is, either there are no child fields extract or all the fields have Field Status to *Unchanged*.
- For any existing entities in extract where the Accreditation ID for the entity doesn't appear in the submitted data record, create a new entity using the Accreditation ID with Entity Status of *Delete*. A new field extract record for QUALAWARDACCID is created with Field Status of *Delete*.

Student Accreditation Aim

Child Entities: None

Each entity is uniquely identified by the single Accreditation Identifier. Up to 3 entities can be returned for each Student Course Session. In cases where multiple entities were previously reported and one or more no longer apply, extract entities are created with Entity Status of *Delete*.

Fields

For each Student Accreditation Aim field extract record for the return with a Derived Value, the record is compared with the corresponding submitted data (MST) record:

- If the Derived Value of the field is NULL ERROR, set Field Status to *Error*.
- If the combination of Institution, SID, NUMHUS, Accreditation ID and Field doesn't exist in the submitted data record, set Field Status to *New*.
- If the combination exists in the extract record and the Entity Status in the most recent submitted data record is *Delete*, set Field Status to *New*.
- If the Reported Value in the extract is different to the Reported Value in the most recent submitted data record, set Field Status to *Amended*.
- Set Field Status to *Unchanged*, that is, Reported Value in the extract is the same as in the most recent submitted data record.

Entities

For each Student Accreditation Aim entity extract record for the return, the record is compared with the corresponding submitted data (MST) record:

- If at least one field has Field Status of *Error*, set Entity Status to *Error*.
- If the combination of Institution, SID, NUMHUS, and Accreditation ID doesn't exist in the submitted data record, set Entity Status to *New*.
- If the combination exists in the extract record and the Entity Status in the most recent submitted data record is *Delete*, set Entity Status to *New*.
- If there are one or more Field extract records with Field Status of *New* or *Amended*, set Entity Status to *Amended*.

- Set Entity Status to *Unchanged*, that is, either there are no child fields extract or all the fields have Field Status of *Unchanged*.
- For any existing entities in extract where the Accreditation ID for the entity doesn't appear in the submitted data record, create a new entity using the Accreditation ID with Entity Status of *Delete*. A new field extract record for STUACCID is created with Field Status of *Delete*.

Student Initiatives

Child Entities: None

Each entity is uniquely identified by the single Student Initiative. In cases where multiple entities were previously reported and one or more no longer apply, extract entities are created with Entity Status of *Delete*.

Fields

For each Student Initiatives field extract record for the return with a Derived Value, the record is compared with the corresponding submitted data (MST) record:

- If the Derived Value of the field is NULL ERROR, set Field Status to *Error*.
- If the combination of INSTITUTION, SID, NUMHUS, Initiative ID and Field doesn't exist in the submitted data record, set Field Status to *New*.
- If the combination exists in the extract record and the Entity Status in the most recent submitted data record is *Delete*, set Field Status to *New*.
- If the Reported Value in the extract is different to the Reported Value in the most recent submitted data record, set Field Status to *Amended*.
- Set Field Status to *Unchanged*, that is, Reported Value in the extract is the same as in the most recent submitted data record.

Entities

For each Student Initiatives entity extract record for the return, the record is compared with the corresponding submitted data (MST) record:

- If at least one field has Field Status of *Error*, set Entity Status to *Error*.
- If the combination of INSTITUTION, SID, NUMHUS, and Initiative ID doesn't exist in the submitted data record, set Entity Status to *New*.
- If the combination exists in the extract record and the Entity Status in the most recent submitted data record is *Delete*, set Entity Status to *New*.
- If there are one or more Field extract records with Field Status of *New* or *Amended*, set Entity Status to *Amended*.
- Set Entity Status to *Unchanged*, that is, either there are no child fields extract or all the fields have Field Status of *Unchanged*.

- For any existing entities in extract where the Initiative ID for the entity doesn't appear in the submitted data record, create a new entity using the Initiative ID with Entity Status of *Delete*. A new field extract record for STUINITID is created with Field Status of *Delete*.

Student

Child Entities: Engagement, Disability, Language Proficiency

Each entity is uniquely identified by Student Identifier (SID).

Fields

For each Student field extract record for the return, the record is compared with the corresponding submitted data (MST) record:

- If the Derived Value of the field is NULL ERROR, set Field Status to *Error*.
- If the combination of INSTITUTION, SID and FIELD doesn't exist in the submitted data record, set Field Status to *New*.
- If the Reported Value in the extract is different to the Reported Value in the most recent submitted data record, set Field Status to *Amended*.
- Set Field Status to *Unchanged*, that is, Reported Value in the extract is the same as in the most recent submitted data record.

Entities

For each Student entity extract record for the return, the record is compared with the corresponding submitted data (MST) record:

- If the combination of INSTITUTION and SID doesn't exist in the submitted data record, set Entity Status to *New*.
- If there are one or more child Field extract records with Field Status of *New* or *Amended*, set Entity Status to *Amended*.
- If there are one or more child Entity extract records with Entity Status of *New*, *Amended*, *Identify*, or *Delete*, set Entity Status to *Identify*.
- Set Entity Status to *Unchanged*, that is, there are no child entities or fields with status *New* or *Amended* that need to be reported.

Disability

Each entity is uniquely identified by the single Disability field. In cases where entities were previously reported and no longer apply, extract entities are created with Entity Status of *Delete*.

Fields

For each Disability field extract record for the return, the record is compared with the corresponding submitted data (MST) record:

- If the Derived Value of the field is NULL ERROR, set Field Status to *Error*.
- If the combination of Institution, SID, Disability, and Field doesn't exist in the submitted data record, set Field Status to *New*.
- If the combination exists in the extract record and the Entity Status in the most recent submitted data record is *Delete*, set Field Status to *New*.
- If the Reported Value in the extract is different to the Reported Value in the most recent submitted data record, set Field Status to *Amended*.
- Set Field Status to *Unchanged*, that is, Reported Value in the extract is the same as in the most recent submitted data record.

Entities

For each Disability entity extract record for the return, the record is compared with the corresponding submitted data (MST) record:

- If at least one field has Field Status of *Error*, set Entity Status to *Error*.
- If the combination of Institution, SID and Disability doesn't exist in the submitted data record, set Entity Status to *New*.
- If the combination exists in the extract record and the Entity Status in the most recent submitted data record is *Delete*, set Entity Status to *New*.
- If there are one or more child Field extract records with Field Status of *New* or *Amended*, set Entity Status to *Amended*.
- Set Entity Status to *Unchanged*, that is, there are no child entities or fields with status *New* or *Amended* that need to be reported.
- For any existing entities in extract where the Disability does not appear in the extract, create a new entity using the Disability value with Entity Status of *Delete*. A new field extract record for DISABILITY is created with Field Status of *Delete*.

Language Proficiency

Child Entities: None

Each entity is uniquely identified by Language Identifier that is derived as the language code from Person HESA Data. In cases where entities were previously reported and no longer apply, extract entities are created with Entity Status of *Delete*.

Fields

For each Language Proficiency field extract record for the return, the record is compared with the corresponding submitted data (MST) record:

- If the Derived Value of the field is NULL ERROR, set Field Status to *Error*.
- If the combination of Institution, SID, Language ID and Field doesn't exist in the submitted data record, set Field Status to *New*.

- If the combination exists in the extract record and the Entity Status in the most recent submitted data record is *Delete*, set Field Status to *New*.
- If the Reported Value in the extract is different to the Reported Value in the most recent submitted data record, set Field Status to *Amended*.
- Set Field Status to *Unchanged*, that is, Reported Value in the extract is the same as in the most recent submitted data record.

Entities

For each Language Proficiency entity extract record for the return, the record is compared with the corresponding submitted data (MST) record:

- If at least one field has Field Status of *Error*, set Entity Status to *Error*.
- If the combination of Institution, SID and Language ID doesn't exist in the submitted data record, set Entity Status to *New*.
- If the combination exists in the extract record and the Entity Status in the most recent submitted data record is *Delete*, set Entity Status to *New*.
- If there are one or more child Field extract records with Field Status of *New* or *Amended*, set Entity Status to *Amended*.
- Set Entity Status to *Unchanged*, that is, there are no child entities or fields with status *New* or *Amended* that need to be reported.
- For any existing entities in extract where the Language ID for the entity doesn't appear in the submitted data record, create a new entity using the Language ID with Entity Status of *Delete*. New field extract records for LANGPROFICIENCYID and PROFICIENCYTYPE is created with Field Status of *Delete*.

Understanding Extract Synch for Data Futures

Once an extract is completed and reported to HESA via a successful XML file, the data set can be copied to the extract records. You shouldn't run extract synch until you resolve the errors in the extract data and the extract is submitted to HESA.

The first step of the process is to copy extract records. This creates a full set of new effective-dated/sequenced extract records by copying from the most recent effective-dated rows for all the extract records for the Data Futures (DF) return type. The synch process can run for multiple extracts on the same day so effective sequence is used to track the history of changes.

The Institution extract record is used to find the most recent effective-dated records that need to be copied. To copy extract records:

1. Select the most recent effective date and effective sequence from Institution extract for the Institution where Return Type is DFSTDNT.
2. Find the new effective date as the current date, and the new effective sequence as the highest existing effective sequence for the current date + 1 (or as 1, if the most recent record is for an earlier date).

3. Copy the existing Institution extract record using the new date/sequence from step 2.
4. For each extract entity and field record with return type = DFSTDNT:
 - Rows for the existing date/sequence selected in step 1 where the Entity or Field Status is *not* Delete are copied to new rows using the new effective date/sequence in step 2.
 - The Entity Status and Field Status values for all the new records is initially set to Unchanged.

Note: Any rows for earlier effective dates that have been deleted before the most recent record and any records that were marked as *Delete* in the most recent record aren't copied to the new record.

If there's no existing Institution extract record for the DFSTDNT return type, the copy extract step is skipped. This will happen the first time the extract synch process is run.

Next is to copy the extract records.

If the extract Entity Status isn't one of the values in Entity Status Inclusion, the entity extract record, any child field records, and any child entities are skipped. These records aren't included in the XML and no updates are required to the corresponding extract records.

If the extract Entity Status is *Identify*, *Delete*, *Unchanged*, or *Unused* the Entity Status of the corresponding new extract record is updated to the new value. Any child field extract records are skipped. If there's no corresponding submitted data record, the record is skipped.

If the extract Entity Status is any of the values in Entity Status Inclusion (like Amended, Error, or New) and there's a corresponding submitted data record:

- The Entity Status of the corresponding new extract record is updated to the extract entity value.
- For each field record where the Field Status isn't one of the values in Field Status Inclusion, the field is skipped.
- If the field record already exists in submitted data, the Field Status of the submitted data record is updated to the extract field value and the other values (Derived Value, Derived Step, Reported Value, Override Flag) are also updated.
- If the field record doesn't already exist in submitted data, a new submitted data record is created using the new date/sequence and the Field Status is set to the extract field value.

If the extract Entity Status is any of the values in Entity Status Inclusion and there's no corresponding submitted data record, a new entity record is created in submitted data using the new date/sequence with Entity Status of the extract entity value. For each child field record where the Field Status is *not* one of the values in Field Status Inclusion, the field is skipped. A new submitted data field record is created with the same date/sequence as the parent entity and Field Status is set to the extract field value.

Active entity extract records are deleted along with related child field extract records if:

- The extract Entity Status is one of the values in Entity Status Inclusion and where the Synch checkbox is selected.
- All the field extract records have a Field Status that's either blank or is one of the values in Field Status Inclusion and where the Synch checkbox is selected.

- Any child entities have an Entity Status that's one of the values in Entity Status Inclusion and where the Synch checkbox is selected.
- Any child entity field extract records have a Field Status that's either blank or is one of the values in Field Status Inclusion and where the Synch checkbox selected

Note: This doesn't check whether the entity exists in submitted data to allow Unused entities that haven't been copied to submitted data to be deleted.

The Institution Extract record is also not deleted.

(GBR) HESA Field Derivation

Understanding HESA Derivation Steps

Academic institutions submit the student-based statistical returns to HESA as an XML file. The XML file is composed of entities. Each entity, in turn, is composed of data fields. For example, the Institution entity in the student return has three data fields: INSTAPP, RECID, and UKPRN. The specifications for HESA returns are available from the HESA website. The specifications on the HESA website also include field validations and the valid field values for the various returns.

See also [Understanding HESA Returns](#)

This documentation discusses the:

- Campus Solution pages that the Create Extract Application Engine (SSR_HE_DATA) process uses to derive each field.
- Steps that the Create Extract process performs to derive each field.

This documentation does not list the **Constant** and **Default** fields on the HESA Fields page that the Create Extract process uses for derivation. However, it does note the step where the Create Extract process uses a constant and default value for derivation. For information about the HESA Fields page, see [Setting Up a HESA Return](#)

The Create Extract process performs a sequence of steps to derive a field. If the process finds a value in a certain step, it does not perform the next step. For example, the process performs the following steps to derive the Course.BITTM field value:

1. Use constant.
2. If Course entity is based on a subplan, derive from the Sub-Plan HESA page.
3. Derive from the Plan HESA Data page.
4. Derive from the Program HESA Data page.
5. Use default.
6. Derive as *NULL ERROR*.

If a constant value exists for Course.BITTM, then the process uses the constant value in the return and does not perform Step 2 and the remaining steps. If a constant value does not exist, the process performs the next step in the sequence, which Step 2. If the process is not able to derive the value after performing Steps 1 through 5, it performs the last step and sets the Course.BITTM value to *NULL ERROR* in the HESA return.

The last derivation step for most fields is to either assign the value as *NULL ERROR* or not to derive a value and leave the field as blank. If HESA requires a value for a field, the last derivation step is to

assign the field a value of *NULL ERROR*. Conversely, if HESA does not require a value for a field, the last derivation step is to not derive a value and leave the field value as blank. For example, if the Create Extract process cannot derive a Course.FEQAIMC value, it leaves the Course.FEQAIMC value as blank because HESA does not require a value for Course.FEQAIMC for a Course entity.

In some cases, before executing the derivation steps, the Create Extract process checks the Field Derivation Rule to determine whether a value should be derived. If a value should not be derived, the process leaves the field value as blank. For example, before performing the derivation steps for Course.BITTM, the process first checks whether:

- Country = Wales, Scotland, or Northern Ireland
- Course.REDUCEDC = 00, 01, or 04
- Course.TTCID = 1 or 2

The process starts performing the derivation steps for Course.BITTM only if all three conditions are met. If all three conditions are not met, the process leaves the field value as blank.

Important! Oracle recommends that you use the Extract Data pages to review and correct all the values that are derived as *NULL ERROR* before submission to HESA. .

For information about the Extract Data pages, see [Understanding Generating a HESA Return and Creating a Return File](#)

Note: To derive a field value, the Create Extract process uses the most recent effective-dated record that falls on or before the end of the reporting period. Exceptions to this rule are noted in this HESA field derivation documentation.

The following table lists the navigation paths for the pages mentioned throughout the HESA field derivation documentation:

Page	Navigation
Program HESA Data	Set Up SACR > Foundation Tables > Academic Structure > Academic Program Table > Program HESA Data
Program Offering/Year HESA	Set Up SACR > Foundation Tables > Academic Structure > Academic Program Table > Program Offering/Year HESA
Plan HESA Data	Set Up SACR > Foundation Tables > Academic Structure > Academic Plan Table > Plan HESA Data
Plan Offering/Year HESA	Set Up SACR > Foundation Tables > Academic Structure > Academic Plan Table > Plan Offering/Year HESA

Page	Navigation
Sub-Plan HESA	Set Up SACR > Foundation Tables > Academic Structure > Academic SubPlan Table > Sub-Plan HESA
Sub-Plan Offering/Year HESA	Set Up SACR > Foundation Tables > Academic Structure > Academic SubPlan Table > Sub-Plan Offering/Year HESA
HESA Module Data	Curriculum Management > Course Catalog > HESA Module Details
HESA Returns	Records and Enrollment > HESA Reporting > HESA Returns Setup > Returns Setup > HESA Returns
Student Program	Records and Enrollment > Career and Program Information > Student Program/Plan
HESA Instance	Records and Enrollment > Career and Program Information > HESA Instance Details > HESA Instance
Entry Profile	Records and Enrollment > Career and Program Information > HESA Instance Details > Entry Profile
HESA Action Reasons	Records and Enrollment > HESA Reporting > HESA Returns Setup > Returns Setup > HESA Action Reasons
HESA Types	Records and Enrollment > HESA Reporting > HESA Returns Setup > Returns Setup > HESA Types
External System ID	Campus Community > Personal Information (Student) > Identification (Student) > External System ID
Person HESA Data	Campus Community > Personal Information > Add/Update a Person > Person HESA Data
Enter DLHE Survey (self-service)	Click the Enter Survey button on the Survey Management page (Records and Enrollment > HESA Reporting > Destination of Leavers > Survey Management). Click the Enter DLHE Survey link on the Student Center page (Self Service, Student Center).
Survey Details	Click the Details button on the Survey Management page.

For information about these pages and how to generate HESA Returns, see

- [Setting Up a HESA Return](#)
- [Setting Up and Entering Data for HESA Reporting](#)
- [Preparing for Generating Graduate Outcomes Return](#)
- [Generating a HESA Return and Creating a Return File](#)

Note: This documentation about HESA field derivation describes the delivered functionality for deriving the HESA return fields. You can use the Institution Data Capture page to determine at which level you can enter data for field derivation. For more information about the Institution Data Capture page see: [Setting Up and Entering Data for HESA Reporting](#)

Oracle recommends that you review the return type specification that is available from the HESA website for field descriptions, validations, and valid field values.

See <http://www.hesa.ac.uk>.

Student Record Return: Institution Entity

The Create Extract process creates a single Institution entity. The Institution entity is composed of three fields.

Indicator for HEFCE Funding Approximations (INSTAPP)

Return: Student Record

Entity: Institution

Page Used:

<i>Page</i>	<i>Page Element</i>
HESA Returns	INSTAPP

Field Derivation Rule: If the country is England or Northern Ireland, derive a value. Otherwise, do not derive a value and leave the field blank.

Derivation Steps:

1. Derive from the HESA Returns page.
2. Derive as *NULL ERROR*.

Record Type Indicator (RECID)

Return: Student Record

Entity: Institution

Pages Used:

Page	Page Element
Reporting Periods (Records and Enrollment > HESA Reporting > HESA Returns Setup > Reporting Periods)	Record Year
Returns (Records and Enrollment > HESA Reporting > HESA Returns Setup > Returns)	Record ID

Field Derivation Rule: Include for all Institution entities.

Derivation Steps:

1. Derive as YYNNN, where *YY* is the final two digits of the Record Year (for example, 09 for 2009) and *NNN* is the 3-digit Record ID for the seeded return.
2. Derive as *NULL ERROR*.

For Student Return 2009/10, the Record ID must be 051 and the Record Year for the Reporting Period must be 2009. The correct Record ID and Record Year for Student Return 2009/10 are delivered with your system.

UK Provider Reference Number (UKPRN)

Return: Student Record

Entity: Institution

Page Used:

Page	Page Element
HESA Configuration	UKPRN

Field Derivation Rule: Include for all Institution entities.

Derivation Steps:

1. Derive from the HESA Returns page.
2. Derive as *NULL ERROR*.

Student Record Return: Course Entity

If you select the **Include Course Entities** check box on the Create Extract Data page, the Create Extract process creates Course entities based on the academic plans and academic subplans of the institution that are active and have been set up as eligible for reporting to HESA on the Plan HESA Data or the Sub-Plan HESA page.

If you select the **Enable Sub-Plan Reporting** check box on the HESA Returns page, the Create Extract process looks at both subplans and plans with the **Report to HESA** check box selected. If you did not select the **Enable Sub-Plan Reporting** check box on the HESA Returns page or if no subplan records are marked for reporting to HESA, then the extract process looks at only plan records for deriving the **Course** fields.

Note: You can specify an academic subplan, academic plan, or both on the Create Extract Data page to test the Create Extract process for a single plan or subplan. The process then uses the specified subplan or plan to create the Course entities. You must select the **Enable Sub-Plan Reporting** check box on the HESA Returns page if you want to specify a subplan on the Create Extract Data page.

If you have specified an academic career on the Create Extract Data page and no plan, the process includes only those plans that are related to the specified academic career either by looking at the Academic Career field on the Academic Plan Table page or by looking at the parent Academic Program settings (Academic Program field on the Academic Plan Table page and then Academic Career field on the Academic Program Table page).

If you have specified an academic career on the Create Extract Data page and no subplan, the process includes only those subplans whose parent Academic Plan is related to the Academic Career either directly (Academic Career field on the Academic Plan Table page) or by looking at the parent Academic Program settings (Academic Program field on the Academic Plan Table page, and then the Academic Career field on the Academic Program Table page).

If you have specified an academic plan on the Create Extract Data page and no subplan, the process includes only those subplans that are related to the specified plan by looking at the Academic Plan field on the Academic Sub-Plan Table page.

If you have selected the Null Errors Only check box for the Include Course Entities on the Create Extract Data page, the process selects distinct COURSEID values from the existing active Course extract data, where at least one field in the Course or Course Subject extract data has a Derived Value of *NULL ERROR*. The process then selects Course entity records for these COURSEIDs.

If you have selected the Validation Errors Only check box for the Include Course Entities, the process first deletes any Validation Error staging records where all of the COURSEID, MODID and EMPLID fields are blank. Then, it selects distinct COURSEID values from the Validation Error staging table for rows where COURSEID is not blank and EMPLID is blank. The process selects Course entity records for these COURSEIDs. Finally, it deletes records from the Validation Error staging table where COURSEID is populated and EMPLID is blank.

Awarding Body 1 (AWARDBOD)

Return: Student Record

Entity: Course

Pages Used:

Page	Page Element
Program HESA Data	AWARDBOD
Plan HESA Data	AWARDBOD
Sub-Plan HESA	AWARDBOD

Field Derivation Rule: Include for all entities

Derivation Steps:

1. Use constant.
2. If Course entity is based on a subplan, derive from the Sub-Plan HESA page.
3. Derive from the Plan HESA Data page.
4. Derive from the Program HESA Data page.
5. Default to the derived Institution.UKPRN value.

Awarding Body 2 to 8 (AWARDBOD2 to 8)

Return: Student Record

Entity: Course

Pages Used:

Page	Page Element
Program HESA Data	AWARDBOD2 to 8
Plan HESA Data	AWARDBOD2 to 8
Sub-Plan HESA	AWARDBOD2 to 8

Field Derivation Rule: Include for all entities

Derivation Steps:

1. If Course.AWARDBOD was derived from a subplan (derivation step 2 in the previous subsection), derive from the Sub-Plan HESA page.
2. If Course.AWARDBOD was derived from a plan (derivation step 3 in the previous subsection), derive from the Plan HESA Data page.

3. If Course.AWARDBOD was derived from a program (derivation step 4 in the previous subsection), derive from the Program HESA Data page.
4. Do not derive a value and leave the field blank.

Bilingual ITT Marker (BITTM)

Return: Student Record

Entity: Course

Pages Used:

Page	Page Element
Program HESA Data	BITTM
Plan HESA Data	BITTM
Sub-Plan HESA	BITTM

Field Derivation Rule: Derive a value only if the following conditions are met:

- Country = Wales, Scotland, or Northern Ireland
- Course.REDUCEDC = 00, 01, or 04
- Course.TTCID = 1 or 2

Do not derive a value and leave the field blank, if the conditions are not met.

Derivation Steps:

1. Use constant.
2. If Course entity is based on a subplan, derive from the Sub-Plan HESA page.
3. Derive from the Plan HESA Data page.
4. Derive from the Program HESA Data page.
5. Use default.
6. Derive as *NULL ERROR*.

Closed Course (CLSDCRS)

Return: Student Record

Entity: Course

Pages Used:

Page	Page Element
Program HESA Data	CLSDCRS
Plan HESA Data	CLSDCRS
Sub-Plan HESA	CLSDCRS

Field Derivation Rule: Derive a value only if the following conditions are met:

- Country = England
- Course.REDUCEDC = 00
- Course.COURSEAIM is not Z99

Do not derive a value and leave the field blank, if the conditions are not met.

Derivation Steps:

1. Use constant.
2. If Course entity is based on a subplan, derive from the Sub-Plan HESA page.
3. Derive from the Plan HESA Data page.
4. Derive from the Program HESA Data page.
5. Use default.
6. Derive as 0.

Collaborating Organization (COLLORG)

Return: Student Record

Entity: Course

Pages Used:

Page	Page Element
Program HESA Data	COLLORG
Plan HESA Data	COLLORG
Sub-Plan HESA	COLLORG

Field Derivation Rule: Derive a value only if the following conditions are met:

- Country = England
- Course.REDUCEDC = 00
- Course.COURSEAIM does not equal D00, D01, D90, L00, L80, L90, L91, L99, or Z99

Do not derive a value and leave the field blank, if the conditions are not met.

Derivation Steps:

1. Use constant.
2. If Course entity is based on a subplan, derive from the Sub-Plan HESA page.
3. Derive from the Plan HESA Data page.
4. Derive from the Program HESA Data page.
5. Use default.
6. Derive as *NULL ERROR*.

General Qualification Aim of Course (COURSEAIM)

Return: Student Record

Entity: Course

Pages Used:

Page	Page Element
Program HESA Data	COURSEAIM
Plan HESA Data	COURSEAIM
Sub-Plan HESA	COURSEAIM

Field Derivation Rule: Include for all Course entities.

Derivation Steps:

1. Use constant.
2. If Course entity is based on a subplan, derive from the Sub-Plan HESA page.
3. Derive from the Plan HESA Data page.
4. Derive from the Program HESA Data page.
5. Use default.
6. Derive as *NULL ERROR*.

Course Identifier (COURSEID)

Return: Student Record

Entity: Course

Pages Used: None

Field Derivation Rule: Include for all Course entities.

Derivation Steps:

1. If the Course entity is based on a subplan, derive from the Academic Sub-Plan Table record.
2. Derive from the Academic Plan Table record.

Course Title (CTITLE)

Return: Student Record

Entity: Course

Pages Used:

<i>Page</i>	<i>Page Element</i>
Plan HESA Data	Course Title
Sub-Plan HESA	HESA Course Title
Academic Plan Table (Set Up SACR > Foundation Tables > Academic Structure > Academic Plan Table)	Academic Plan
Academic Sub-Plan Table (Set Up SACR > Foundation Tables > Academic Structure > Academic SubPlan Table)	Academic Subplan

Field Derivation Rule: Include for all Course entities.

Derivation Steps:

1. If the Course entity is based on a subplan, derive from the Sub-Plan HESA page.

If the **Course Title** field does not have a value, use a combination of the plan and subplan descriptions from the Academic Plan Table and Academic Sub-Plan Table pages.

2. Derive from the Plan HESA Data page.

If the **Course Title** field does not have a value, use the plan description from the Academic Plan Table page.

FE General Qualification Aim (FEQAIMC)

Return: Student Record

Entity: Course

Pages Used:

Page	Page Element
Program HESA Data	FEQAIMC
Plan HESA Data	FEQAIMC
Sub-Plan HESA	FEQAIMC

Field Derivation Rule: Include for all Course entities.

Derivation Steps:

1. Use constant.
2. If Course entity is based on a subplan, derive from the Sub-Plan HESA page.
3. Derive from the Plan HESA Data page.
4. Derive from the Program HESA Data page.
5. Use default.
6. Do not derive a value and leave the field blank.

Major Source of Funding (MSFUND)

Return: Student Record

Entity: Course

Pages Used:

Page	Page Element
Program HESA Data	MSFUND
Plan HESA Data	MSFUND
Sub-Plan HESA	MSFUND

Field Derivation Rule: Derive a value if Course.REDUCEDC = 00, 01 or 04. Otherwise, do not derive a value and leave the field blank.

Derivation Steps:

1. Use constant.
2. If Course entity is based on a subplan, derive from the Sub-Plan HESA page.
3. Derive from the Plan HESA Data page.
4. Derive from the Program HESA Data page.
5. Use default.
6. If Country = Scotland, Northern Ireland or Wales, derive as *NULL ERROR*.
7. Do not derive a value and leave the field blank.

NHS Bursaries (NHSBURSARY)

Return: Student Record

Entity: Course

Pages Used:

Page	Page Element
Program HESA Data	NHSBURSARY
Plan HESA Data	NHSBURSARY
Sub-Plan HESA	NHSBURSARY

Field Derivation Rule: Derive a value if Country = Northern Ireland, England or Wales and REDUCEDC = 00

Derivation Steps:

1. Use Constant.
2. If the Course entity is based on a sub-plan, derive from the Sub-Plan HESA page.
3. Derive from Plan HESA Data.
4. Derive from Program HESA Data
5. Use default.
6. Derive as *NULL ERROR*.

Own Course Identifier (OWNCOURSEID)

Return: Student Record

Entity: Course

Pages Used:

Page	Page Element
Plan HESA Data	OWNCOURSEID
Sub-Plan HESA Data	OWNCOURSEID

Field Derivation Rule: Include for all Course entities.

Derivation Steps:

1. If Course entity is based on a subplan, derive from the Sub-Plan HESA Data page.
2. Derive from the Plan HESA Data page.
3. Do not derive a value and leave the field blank.

Reduced Course Return Indicator (REDUCEDC)

Return: Student Record

Entity: Course

Pages Used:

Page	Page Element
Program HESA Data	REDUCEDC
Plan HESA Data	REDUCEDC
Sub-Plan HESA	REDUCEDC

Field Derivation Rule: Include for all Course entities.

Derivation Steps:

1. Use constant.
2. If Course entity is based on a subplan, derive from the Sub-Plan HESA page.
3. Derive from the Plan HESA Data page.
4. Derive from the Program HESA Data page.
5. Use default.

6. Derive as *NULL ERROR*.

Regulatory Body for Health and Social Care Students (REGBODY)

Return: Student Record

Entity: Course

Pages Used:

Page	Page Element
Program HESA Data	REGBODY
Plan HESA Data	REGBODY
Sub-Plan HESA	REGBODY

Field Derivation Rule: Derive a value if the following conditions are met:

- Course.COURSEAIM = M16, M26, M76, M86, H16, H62, H76, I16, I76, J26, or J76
- Course.REDUCEDC = 00 or 01

Do not derive a value and leave the field blank, if the conditions are not met.

Derivation Steps:

1. Use constant.
2. If Course entity is based on a subplan, derive from the Sub-Plan HESA page.
3. Derive from the Plan HESA Data page.
4. Derive from the Program HESA Data page.
5. Use default.
6. Derive as *NULL ERROR*.

Regulatory Body for Health and Social Care Students 2 (REGBODY2)

Return: Student Record

Entity: Course

Pages Used:

Page	Page Element
Program HESA Data	REGBODY
Plan HESA Data	REGBODY
Sub-Plan HESA	REGBODY

Field Derivation Rule: Derive a value if the following conditions are met:

- Course.COURSEAIM = M16, M26, M76, M86, H16, H62, H76, I16, I76, J26, or J76
- Course.REDUCEDC = 00 or 01

Do not derive a value and leave the field blank, if the conditions are not met.

Derivation Steps:

1. Use constant.
2. If Course entity is based on a subplan, derive from the Sub-Plan HESA page.
3. Derive from the Plan HESA Data page.
4. Derive from the Program HESA Data page.
5. Use default.
6. Derive as *NULL*.

Subject Knowledge Enhancement Units (SKEUNITS)

Return: Student Record

Entity: Course

Pages Used:

Page	Page Element
Program HESA Data	SKEUNITS
Plan HESA Data	SKEUNITS
Sub-Plan HESA	SKEUNITS

Field Derivation Rule: Derive a value if the following conditions are met:

- Country = England

- Course.REDUCEDC = 07 (SKE) or Course.TTCID = F (SKE)

Do not derive a value and leave the field blank, if the conditions are not met.

Derivation Steps:

1. Use Constant.
2. If the Course entity is based on a sub-plan, derive from the Sub-Plan HESA page.
3. Derive from Plan HESA Data.
4. Derive from Program HESA Data
5. Use default.
6. Derive as *NULL ERROR*.

Subject Knowledge Enhancement Placement (SKEOS)

Return: Student Record

Entity: Course

Pages Used:

Page	Page Element
Program HESA Data	SKEOS
Plan HESA Data	SKEOS
Sub-Plan HESA	SKEOS

Field Derivation Rule: Derive a value if the following conditions are met:

- Country = England
- Course.REDUCEDC = 07 (SKE) or Course.TTCID = F (SKE)

Do not derive a value and leave the field blank, if the conditions are not met.

Derivation Steps:

1. Use Constant.
2. If the Course entity is based on a sub-plan, derive from the Sub-Plan HESA page.
3. Derive from Plan HESA Data.
4. Derive from Program HESA Data
5. Use default.

6. Derive as *NULL ERROR*.

Teaching Qualification Sought Sector (TQSSEC)

Return: Student Record

Entity: Course

Pages Used:

Page	Page Element
Program HESA Data	TQSSEC
Plan HESA Data	TQSSEC
Sub-Plan HESA	TQSSEC

Field Derivation Rule: Derive a value if the following conditions are met:

- Country = Scotland or Northern Ireland
- Course.REDUCEDC = 00
- Course.TTCID = 1 or 2

Do not derive a value and leave the field blank, if the conditions are not met.

Derivation Steps:

1. Use constant.
2. If Course entity is based on a subplan, derive from the Sub-Plan HESA page.
3. Derive from the Plan HESA Data page.
4. Derive from the Program HESA Data page.
5. Use default.
6. Derive as *NULL ERROR*.

Teaching Qualification Sought Subject (TQSSUB)

Return: Student Record

Entity: Course

Pages Used:

Page	Page Element
Program HESA Data	TQSSUB, TQSSUB2, TQSSUB3
Plan HESA Data	TQSSUB, TQSSUB2, TQSSUB3
Sub-Plan HESA	TQSSUB, TQSSUB2, TQSSUB3

Field Derivation Rule: Derive a value if the following conditions are met:

- Country = Scotland
- Course.REDUCEDC = 00
- Course.TQSSEC = 2

Do not derive a value and leave the field blank, if the conditions are not met.

Derivation Steps:

1. Use constant to create a single **TQSSUB** field.
2. If Course entity is based on a subplan, derive from the Sub-Plan HESA page.
3. Derive from the Plan HESA Data page.
4. Derive from the Program HESA Data page.
5. Use default to create a single **TQSSUB** field.
6. Derive a single **TQSSUB** field as *NULL ERROR*.

Note: The system can derive up to three values. Each of the values is included as a separate **TQSSUB** field in the XML file.

Teacher Training Course (TTCID)

Return: Student Record

Entity: Course

Pages Used:

Page	Page Element
Program HESA Data	TTCID
Plan HESA Data	TTCID

Page	Page Element
Sub-Plan HESA	TTCID

Field Derivation Rule: Derive a value if one of the following conditions is met:

- Country = England, Northern Ireland or Scotland AND Course.REDUCEDC = 00, 01, 04, 07 or 09 AND Course.COURSEAIM is not Z99
- Country = Wales AND Course.COURSEAIM does not begin with P, Q, R, S or X and is not Z99 AND Course.REDUCEDC = 00, 01, 04, 07 or 09.

Do not derive a value and leave the field blank, if the conditions are not met.

Derivation Steps:

1. Use constant.
2. If Course entity is based on a subplan, derive from the Sub-Plan HESA page.
3. Derive from the Plan HESA Data page.
4. Derive from the Program HESA Data page.
5. Use default.
6. Derive as *NULL ERROR*.

Student Record Return: Delivery and Organisation Location

For each Course extract record, an entity is created for each Role defined at the Sub-Plan, Plan or Program level, where the Type is defined as code 202 (delivery organisation). In each case, the latest record where the effective date falls on or before the reporting period end date is considered.

Entities are derived in one of the following steps:

1. If the Course entity is based on a sub-plan and at least one Role is defined Sub-Plan HESA Data with Type = 202, an entity is derived for each Role defined as Type = 202 and an Identifier value that's not the same as the UKPRN of the reporting institution defined in HESA Configuration. The derivation step for each field is set to 1.
2. If at least one Role is defined in Plan HESA Data with Type = 202, an entity is derived for each Role with Type = 202 and an Identifier value that's not the same as the UKPRN of the reporting institution defined in HESA Configuration. The derivation step for each field is set to 2. For Course entities based on sub-plans, the parent plan is considered.
3. If at least one Role is defined in Program HESA Data for the parent program with Type = 202, an entity is derived for each Role defined with Type = 202 and an Identifier value that is not the same as the UKPRN of the reporting institution defined in HESA Configuration. The derivation step for each field is set to 3.

Delivery Organisation (DELORG)

Return: Student Record

Entity: Delivery Organisation and Location

Pages Used:

Page	Page Element
Program HESA Data — Roles	Identifier
Plan HESA Data — Roles	Identifier
Sub-Plan HESA — Roles	Identifier

Field Derivation Rule: Include for all entities

Derivation Steps:

1. If parent Course Delivery is based on a sub-plan, derive from Sub-Plan HESA Data.
2. Derive from Plan HESA Data.
3. Derive from Program HESA Data.

Delivery Organisation Proportion (DELORGPROP)

Return: Student Record

Entity: Delivery Organisation and Location

Pages Used:

Page	Page Element
Program HESA Data — Roles	Percentage
Plan HESA Data — Roles	Percentage
Sub-Plan HESA — Roles	Percentage

Field Derivation Rule: Include for all entities

Derivation Steps:

1. If parent Course Delivery is based on a sub-plan, derive from Sub-Plan HESA Data.
2. Derive from Plan HESA Data.

3. Derive from Program HESA Data.

Postcode (PCODELOC)

Return: Student Record

Entity: Delivery Organisation and Location

Pages Used:

Page	Page Element
Program HESA Data — Roles	Postcode
Plan HESA Data — Roles	Postcode
Sub-Plan HESA — Roles	Postcode

Field Derivation Rule: Include for all entities

Derivation Steps:

1. If parent Course Delivery is based on a sub-plan, derive from Sub-Plan HESA Data.
2. Derive from Plan HESA Data.
3. Derive from Program HESA Data.
4. Derive as null.

Student Record Return: Course Subject Entity

If you select the **Include Course Entities** check box on the Create Extract Data page, the Create Extract process creates Course Subject entity records for each Course entity. The process can create a maximum of three Course Subject entity records for each Course entity.

The derivation of **Course Subject** fields may vary depending on whether the parent Course entity is based on a subplan or plan record.

Subject of ITT Specialism Indicator (ITTSUBJECT)

Return: Student Record

Entity: Course Subject

Pages Used:

Page	Page Element
Program HESA Data — HECoS Subjects	ITT Subject
Plan HESA Data — HECoS Subjects	ITT Subject
Sub-Plan HESA — HECoS Subjects	ITT Subject

Note: The system identifies a HESA subject as an ITT subject only if the ITT Subject Flag check box is selected for the HESA subject.

Field Derivation Rule: Derive a value if the following conditions are met:

- Country = England
- Course.TTCID = 1

Do not derive a value and leave the field blank, if the conditions are not met.

Derivation Steps:

1. If Course entity is based on a subplan, derive from the Sub-Plan HESA — HECoS Subjects page.
2. Derive from the Plan HESA Data page — HECoS Subjects.
3. Derive from the Program HESA Data page — HECoS Subjects.

Subject of Course (SBJCA)

Return: Student Record

Entity: Course Subject

Pages Used:

Page	Page Element
Program HESA Data — HECoS Subjects	Subject
Plan HESA Data — HECoS Subjects	Subject
Sub-Plan HESA — HECoS Subjects	Subject

Field Derivation Rule: Include for all Course Subject entities.

Derivation Steps:

1. If Course entity is based on a subplan, derive from the Sub-Plan HESA — HECoS Subjects page.

2. Derive from the Plan HESA Data — HECoS Subjects page.
3. Derive from the Program HESA Data — HECoS Subjects page.

Subject Percentage (SBJPCNT)

Return: Student Record

Entity: Course Subject

Pages Used:

Page	Page Element
Program HESA Data — HECoS Subjects	Percentage
Plan HESA Data — HECoS Subjects	Percentage
Sub-Plan HESA — HECoS Subjects	Percentage

Field Derivation Rule: Include for all Course Subject entities.

Derivation Steps:

1. If Course entity is based on a subplan, derive from the Sub-Plan HESA — HECoS Subjects page.
2. Derive from the Plan HESA Data — HECoS Subjects page.
3. Derive from the Program HESA Data — HECoS Subjects page.

Student Record Return: Module Entity

If you select the **Include Module Entities** check box on the Create Extract Data page, the Create Extract process creates the Module entities. To create Module entities, the process uses the institution's Course Offering records that are active and have been set up as eligible for reporting to HESA. You must select the **Report to HESA** check box on the HESA Module Data page to make a course offering record eligible for HESA reporting.

If HESA Module Data records do not exist, the process does not include the course offerings in the Module entity. The process includes dummy modules in the module entity.

Note: When you run the Create Extract process, you can choose to enter the course ID or course offering number as a run parameter for testing purposes. The Create Extract process then uses the specified course ID or course offering number to create the Module entities.

If you have selected an academic career and no course offering on the Create Extract Data page, then the process selects only those course offerings that are related to the selected career.

If you have selected the Null Errors Only check box for the Include Module Entities on the Create Extract Data page, the Create Extract process selects distinct MODID values from the existing active Module extract data, where at least one field in the Module or Module Subject extract data has a Derived Value of *NULL ERROR*. The process then selects Module entity records for these MODIDs.

If you have selected the Validation Errors Only check box for the Include Module Entities, the Create Extract process first deletes any Validation Error staging records where all of the COURSEID, MODID and EMPLID fields are blank. Then, it selects distinct MODID values from the Validation Error staging table for rows where MODID is not blank and EMPLID is blank. The process selects Module entity records for these MODIDs. Note that the File Parser process removes the leading zeroes from MODID, therefore, the comparison of MODID with Course ID and Course Offering Number includes the logic to correctly match the values. The system makes an assumption that the Course Offering Number is a single digit. Finally, the Create Extract process deletes records from the Validation Error staging table where MODID is populated and EMPLID is blank.

Credit Value of Module (CRDTPTS)

Return: Student Record

Entity: Module

Page Used:

Page	Page Element
HESA Module Data	CRDTPTS
Catalog Data (Curriculum Management, Course Catalog, Catalog Data)	Maximum Units, Academic Progress Units, Enrollment Unit Load Calc Type

Field Derivation Rule: Include for all Module entities.

Derivation Steps:

1. Use constant.
2. Derive from the HESA Module Data page.
3. Select the Course Catalog record for the Course ID. If the Enrollment Unit Load Calc Type value is *Academic Progress Units*, derive from the Academic Progress Units value. If the Enrollment Unit Load Calc Type value is any other value, derive from the Maximum Units value. Round off the fractional values to the nearest whole number. This step is not performed for dummy modules.
4. Use default.
5. Derive as *NULL ERROR*.

Credit Transfer Scheme (CRDTSCM)

Return: Student Record

Entity: Module

Page Used:

Page	Page Element
HESA Module Data	CRDTSCM

Field Derivation Rule: Include for all Module entities.

Derivation Steps:

1. Use constant.
2. Derive from the HESA Module Data page.
3. Use default.
4. Derive as *NULL ERROR*.

Module Franchise Indicator (FRANIND)

Return: Student Record

Entity: Module

Page Used:

Page	Page Element
HESA Module Data	FRANIND

Field Derivation Rule: If Country = Wales, derive a value. Otherwise, do not derive a value and leave the field blank.

Derivation Steps:

1. Use constant.
2. Derive from the HESA Module Data page.
3. Use default.
4. Do not derive a value and leave the field blank.

Note: The HESA specification indicates that the Module.FRANIND coverage also includes Course.COURSEAIM that begins with D, E, L, M, H, I, J or C, however, the extract process cannot check this as there is no direct link to the Course entity.

Module FTE (FTE)

Return: Student Record

Entity: Module

Page Used:

Page	Page Element
HESA Module Data	FTE

Field Derivation Rule: Include for all Module entities.

Derivation Steps:

1. Use constant.
2. Derive from the HESA Module Data page.
3. Use default.
4. Derive as *NULL ERROR*.

Level of Credit Points (LEVLPTS)

Return: Student Record

Entity: Module

Page Used:

Page	Page Element
HESA Module Data	LEVLPTS

Field Derivation Rule: If Module.CRDTPTS does not equal 999, derive a value. Otherwise, do not derive a value and leave the field blank.

Derivation Steps:

1. Use constant.
2. Derive from the HESA Module Data page.
3. Use default.
4. Derive as *NULL ERROR*.

Module Identifier (MODID)

Return: Student Record

Entity: Module

Page Used:

Page	Page Element
HESA Module Data	Course ID Course Offering Nbr

Field Derivation Rule: Include for all Module entities.

Derivation Steps:

Derive as combination of Course ID plus Course Offering Number (CRSE_ID and CRSE_OFFER_NBR column values from PS_CRSE_OFFER), or the combination of Academic Plan and Year for dummy modules. For example, if Course ID = 001248 and Offering Number = 2, then MODID = 0012482.

Module Taught in a Celtic Language (MODLANG)

Return: Student Record

Entity: Module

Page Used:

Page	Page Element
HESA Module Data	MODLANG

Field Derivation Rule: If Country = Northern Ireland, Scotland, or Wales, derive a value. Otherwise, do not derive a value and leave the field blank.

Derivation Steps:

1. Use constant.
2. Derive from the HESA Module Data page.
3. Use default.
4. Derive as *NULL ERROR*.

Module Title (MTITLE)

Return: Student Record

Entity: Module

Page Used:

Page	Page Element
HESA Module Data	Short description that appears on the right of Course ID page element
HESA Dummy Module Data	Year

Field Derivation Rule: Include for all Module entities.

Derivation Steps:

1. Use constant.
2. Derive from the HESA Module Data page for standard modules. If short description is unavailable on the HESA Module Data page, derive as the description of the parent Course Catalog record.

For dummy modules, the MTITLE is derived as a combination of the Plan description, the text *Year*, and the year value of the dummy module record separated by spaces. For example, for Academic Plan = BA ENG with description BA English and Year = 2, MTITLE is derived as *BA English Year 2*.

3. Use default.
4. Derive as *NULL ERROR*.

Percentage Not Taught By This Institution (PCOLAB)

Return: Student Record

Entity: Module

Page Used:

Page	Page Element
HESA Module Data	PCOLAB

Field Derivation Rule: Include for all Module entities.

Derivation Steps:

1. Use constant.
2. Derive from the HESA Module Data page.
3. Use default.
4. Derive as *NULL ERROR*.

Other Institution Providing Teaching (TINST)

Return: Student Record

Entity: Module

Page Used:

Page	Page Element
HESA Module Data	TINST

Field Derivation Rule: If Module.PCOLAB is greater than zero, derive a value. Otherwise, do not derive a value and leave the field blank.

Derivation Steps:

1. Use constant.
2. Derive from the HESA Module Data page.
3. Use default.
4. Derive as *NULL ERROR*.

Student Record Return: Module Subject Entity

If you select the **Include Module Entities** check box on the Create Extract Data page, the Create Extract process creates a maximum of 16 Module Subject entity records for each Module entity. To create the Module Subject entity records, the process uses the subject records for each Module record. Each module subject is a combination of Cost Centre and Subject. The Module HESA Data page ensures that each combination of Cost Center and Subject is unique and the total percentage equals 100.

To allow up to 16 combinations of Cost Centre and Subject to be returned in Module Subject, the HECoS Subjects grid is updated to change the maximum number of records from 3 to 16. This doesn't impact the Module Cost Centre in the Data Futures return because that entity is unbounded.

If you have not defined subjects on the Module Subjects region of the HESA Module Data page, then the process creates a single Module Subject entity record. The process derives the values for each field within the entity using the constant or default value defined on the HESA Fields page (Records and Enrollment, HESA Reporting, HESA Returns Setup, Returns Setup, HESA Fields). If a constant or default is not available, the process derives the value as *NULL ERROR*. Note that if you have defined a constant, the process does not examine any subjects defined on the HESA Module Data page (that is, the process does not run derivation step 2 for the Module Subject fields).

Cost Centre (COSTCN)

Return: Student Record

Entity: Module Subject

Page Used:

Page	Page Element
HESA Module Data — HECoS Subjects	Cost Centre
HESA Dummy Module Data — HECoS Subjects	

Field Derivation Rule: Include for all Module Subject entities.

Derivation Steps:

1. Use constant.
2. Derive from the HESA Module Data — HECoS Subjects page.
3. Use Default.
4. Derive as *NULL ERROR*.

Subject of Module (MODSBJ)

Return: Student Record

Entity: Module Subject

Page Used:

Page	Page Element
HESA Module Data — HECoS Subjects	Subject
HESA Dummy Module Data — HECoS Subjects	

Field Derivation Rule: Include for all Module Subject entities.

Derivation Steps:

1. Use constant.
2. Derive from the HESA Module Data — HECoS Subjects page.
3. Use default.
4. If Country = Scotland or Northern Ireland, derive as *NULL ERROR*.
5. Derive as null.

Subject/Cost Centre Percentage (MODSBJP)

Return: Student Record

Entity: Module Subject

Page Used:

Page	Page Element
HESA Module Data — HECoS Subjects	Percentage
HESA Dummy Module Data — HECoS Subjects	

Field Derivation Rule: Include for all Module Subject entities.

Derivation Steps:

1. Use constant.
2. Derive from the HESA Module Data — HECoS Subjects page.
3. Use default.
4. Derive as *NULL ERROR*.

Student Record Return: Student Entity

The Create Extract process creates a single Student entity for each student included in the Instance entity. However, it is possible for a student to have multiple distinct Instances for a particular return. In this case, only one Student entity will be created.

The process creates the Student entities only if the **Include Student Entities** check box is selected on the Create Extract Data page.

The process uses each distinct HESA unique student identifier (HUSID) to create a Student entity. The process also uses the student's EMPLID to link the HUSID with the person data to derive fields within the Student entity. The process creates the Student entity after creating all the other entities because of the dependency on values derived for the **Course**, **Instance**, and **Entry Profile** fields.

Date of Birth (BIRTHDTE)

Return: Student Record

Entity: Student

Page Used:

Page	Page Element
Biographical Details (Campus Community > Personal Information (Student) > Add/Update a Person > Biographical Details)	Date of Birth

Field Derivation Rule: Include for all Student entities.

Derivation Steps:

1. Derive from the Biographical Details page in the format YYYY-DD-MM.
2. Derive as null.

British Sign Language User (BSLUSER)

Return: Student Record

Entity: Student

Page Used:

<i>Page</i>	<i>Page Element</i>
Person HESA Data	BSLUSER

Field Derivation Rule: Derive a value if all conditions are met:

- Country = Scotland
- Student has one of these:
 - Any EntryProfile in the extract with DOMICILE = XF, XG, XH, XI, XK, XL, GG, JE or IM
 - Any HESA Entry Profile record with DOMICILE = XF, XG, XH, XI, XK, XL, GG, JE or IM. This includes consideration of all non-future effective-dated records for the student (based on EMPLID) irrespective of career/instance.
 - Any Residency Self-Report record where the 2-character country code is XF, XG, XH, XI, XK, XL, GG, JE or IM. This includes consideration of all non-future-effective-dated records for the student (based on EMPLID).

Derivation Steps:

1. Derive from Person HESA Data.
2. Use default.
3. Derive as NULL ERROR.

Carer (CARER)

Return: Student Record

Entity: Student

Page Used:

Page	Page Element
Person HESA Data	CARER

Field Derivation Rule: If all the following conditions are met, a value is derived:

- Country = Scotland
- Student has any one of the following:
 - An EntryProfile in the extract with DOMICILE = XH
 - Any HESA Entry Profile record with DOMICILE = XH. Consider all records for the student (based on EMPLID), regardless of effective date or career or instance.
 - A Residency Self-Report record where the mapped two-character country code is XH. All student records are considered, based on EMPLID, regardless of effective date.

Derivation Steps:

1. Derive from Person HESA Data.
2. Use default.
3. Derive as NULL ERROR.

Disability (DISABLE)

Return: Student Record

Entity: Student

Pages Used:

Page	Page Element
Person HESA Data	DISABLE
Impairment AUS (Campus Community > Personal Information > Health Information > Impairment AUS)	Type of Impairment
Disability (Records and Enrollment > HESA Reporting > Codes and Mappings > Code Mappings > Disability)	HESA Disability Code

Field Derivation Rule: If the student has at least one Instance with REDUCEDI = 00, 01 or 07, derive a value. Otherwise, do not derive a value and leave the field blank.

Derivation Steps:

1. Derive from the Person HESA Data page.
2. If the student has a single impairment record, use the HESA Disability code from the mapping between the impairment type and the HESA disability code.
3. If the student has multiple mapped impairment records and all the records are mapped to a single HESA disability code, derive the HESA code.
4. If the student has multiple mapped impairment records and the records are mapped to more than one HESA disability code other than 00, 97, 98, or 99, then derive '08' (multiple disabilities).
5. If the student has multiple mapped impairment records and only one record is mapped to a HESA disability code other than 00, 97, 98, or 99, then derive as *NULL ERROR*.
6. If the student has multiple mapped impairment records and the records are all mapped to HESA disability codes 00, 97, 98, or 99, then derive the lowest mapped HESA code.

Note: Note: If all records are mapped to the same code, it is derived in step 3.

7. Use default.
8. Derive as *NULL ERROR*.

You can define a default as either *00* (no known disability) or *99* (not known).

Ethnicity (ETHNIC)

Return: Student Record

Entity: Student

Pages Used:

Page	Page Element
Person HESA Data	ETHNIC
Ethnicity (Campus Community > Personal Information (Student) > Biographical (Student) > Personal Attributes > Ethnicity)	Regulatory Region, Ethnic Group
Ethnicity (Records and Enrollment > HESA Reporting > Codes and Mappings > Code Mappings > Ethnicity)	HESA Ethnic Code

Page	Page Element
Country Description (Set Up Common Objects > Install > Country Table > Country Description) See: <ul style="list-style-type: none"> • “Administering Country Codes” (Campus Community Fundamentals) • “Understanding CS-to-HCM Integration” (Campus Solutions Application Fundamentals) 	2-Char Country Code

Field Derivation Rule: Derive a value if the following conditions are met:

- Student has at least one Instance with REDUCED = 00, 01, 07 or 08.
- One of the following is true (a, b, c or d):
 - a. Student has a related Entry Profile in the extract with DOMICILE = XF, XG, XH, XI, XK, XL, GG, JE, or IM.
 - b. Student has a HESA Entry Profile record with DOMICILE = XF, XG, XH, XI, XK, XL, GG, JE, or IM. All student records are considered, based on EMPLID, irrespective of effective date or career/instance.
 - c. Student has a Residency Self-Report record where Country = GBR or the mapped 2-character country code is XF, XG, XH, XI, XK, XL, GG, JE, or IM. All student records are considered, based on EMPLID, irrespective of effective date.
 - d. Country = England and Course.TTCID is 1

Do not derive a value and leave the field blank, if the conditions are not met.

Derivation Steps:

1. Derive from the Person HESA Data page.
2. Select Person Ethnicity records as follows:
 - If a single record exists, use that record.
 - If multiple records exist and one is marked as Primary on the Campus Community Ethnicity page, use that record.
 - If multiple records exist and none are marked as Primary, select the record with the highest Percentage defined in the Ethnicity Detail page.
 - If multiple records are indistinguishable, select the the most recent record based on last updated date (LASTUPDDTTM from ETHNICITY_DTL).

- For the selected record, use the HESA Ethnic code from the mapping between the Ethnic Group, Regulatory Region, and the HESA Ethnic code. If no mapping exists, log an error message and skip to next step.
3. Use default.
 4. Derive as *NULL ERROR*.

Forenames (FNAMES)

Return: Student Record

Entity: Student

Page Used:

Page	Page Element
Names (Campus Community > Personal Information (Student) > Add/Update a Person > Biographical Details > Names)	First Name Middle Name

Field Derivation Rule: If a student has at least one Instance with REDUCEDI = 00, 01, 04, or 08 derive a value. Otherwise, do not derive a value and leave the field blank.

Derivation Steps:

1. Use the First Name and Middle Name values from the Primary Name record.
2. Derive as null.

Gender (GENDER)

Return: Student Record

Entity: Student

Page Used:

Page	Page Element
Biographical Details (Campus Community , Personal Information (Student), Add/Update a Person, Biographical Details)	Gender

Field Derivation Rule: Include for all Student entities.

Derivation Steps:

1. Use the Gender value from the Biographical History record.

If the gender value is Male, derive as 1.

If the gender value is Female, derive as 2.

If the gender value is unknown, derive as 9.

2. Use default.

3. Derive as *NULL ERROR*.

Note: The GENDER field has been replaced with SEXID for 2012/13 onwards.

Gender Identity (GENDERID)

Return: Student Record

Entity: Student

Page Used:

<i>Page</i>	<i>Page Element</i>
Person HESA Data	GENDERID

Field Derivation Rule: Include for all entities.

Derivation Steps:

1. Derive from the Person HESA Data page.
2. Use default.
3. If Country = England or Northern Ireland, derive as NULL ERROR.
4. Derive as null.

HESA Unique Student Identifier (HUSID)

Return: Student Record

Entity: Student

Page Used:

<i>Page</i>	<i>Page Element</i>
External System ID	External System ID

Field Derivation Rule: Include for all Student entities.

Derivation Step:

1. Select External System ID records for the person with the External ID Type defined for HUSID in the HESA Types page.

Validate that the derived value is in the correct format (refer to the Notes section for HUSID available on the HESA website). If the value is invalid, log an error message.

Nationality (NATION)

Return: Student Record

Entity: Student

Pages Used:

Page	Page Element
Person HESA Data	NATION
Citizenship and Passport (Campus Community , Personal Information (Student), Identification (Student), Citizenship, Citizenship and Passport)	Country
Nationality (Records and Enrollment, HESA Reporting, Codes and Mappings, Code Mappings, Nationality)	HESA Nationality Code

Field Derivation Rule: Include for all Student entities.

Derivation Steps:

1. Derive from the Person HESA Data page.
2. Select person citizenship records and retrieve the related two-character code (COUNTRY_2CHAR) from the Country table (PS_COUNTRY_TBL). If a mapping exists in the HESA Nationality Code page for the Campus Solutions Country code, use the mapped HESA value else use the COUNTRY_2CHAR value.

If a single record exists, derive the Campus Solutions country code or HESA country code.

3. If multiple person citizenship records are found and a record has a value of *GB*, derive as *GB*.
4. If multiple records are found, and none have the *GB* country value but a minimum one record has a country value that is marked as European Union (EU) country then derive the EU country. If there are multiple EU countries report the one with the lowest alphabetic HESA code. Note that the PS_COUNTRY_TBL contains an indicator (EU_MEMBER_STATE) to specify if the country is a member of the EU.
5. If multiple records are found and none have the UK or EU value, select the lowest alphabetic code
6. Use default.

- 7. If the student has at least one Instance with REDUCEDI = 00 or 03, COMDATE is on or after 2007-08-01, and Country is not Northern Ireland, derive as *NULL ERROR* else do not derive a value and leave the field blank.

In most cases, you can use the Campus Solutions two-character country code to report the NATION value. However, some Campus Solutions country codes are not valid for HESA reporting. For example, the Campus Solutions Cyprus code (CY) cannot be reported. Cyprus has to be reported as *XA*, *XB*, or *XC*. In these cases, you must use the Nationality code mapping page to ensure the correct NATION values are reported to HESA.

National Identity (NATIOND)

Return: Student Record

Entity: Student

Page Used:

<i>Page</i>	<i>Page Element</i>
Person HESA Data	NATIOND

Field Derivation Rule: Derive a value if the following conditions are met.

For Country = Wales:

- Student has at least one Instance with REDUCEDI = 00.
- Any one of the following:
 - Student has a related EntryProfile in the extract with DOMICILE = XI (Wales)
 - Student has any HESA Entry Profile record with DOMICILE = XI. Consider all records for the student (based on EMPLID), irrespective of effective date or career/instance.
 - Student has any Residency Self-Report record where country = GBR and the combination of Country and State is mapped to a HESA Country Code = XI in the UCAS Area of Permanent Residence page. Consider all records for the student (based on EMPLID), irrespective of effective date.

For Country = England: include for all students

Derivation Steps:

1. Derive from the Person HESA Data page.
2. Use default.
3. If Country = Wales, derive as NULL ERROR
4. Derive as NULL.

National Identity (NATIOND2)

Return: Student Record

Entity: Student

Page Used:

<i>Page</i>	<i>Page Element</i>
Person HESA Data	NATIOND2

Field Derivation Rule: Derive a value if the following conditions are met.

For Country = Wales:

- Student has at least one Instance with REDUCEDI = 00.
- Any one of the following:
 - Student has a related EntryProfile in the extract with DOMICILE = XI (Wales)
 - Student has any HESA Entry Profile record with DOMICILE = XI. Consider all records for the student (based on EMPLID), irrespective of effective date or career/instance.
 - Student has any Residency Self-Report record where country = GBR and the combination of Country and State is mapped to a HESA Country Code = XI in the UCAS Area of Permanent Residence page. Consider all records for the student (based on EMPLID), irrespective of effective date.

For Country = England: include for all students

Derivation Steps:

1. Derive from the Person HESA Data page.
2. Use default.
3. Derive as NULL.

ORCID Identifier (ORCID)

Return: Student Record

Entity: Student

Page Used:

Page	Page Element
External System ID (Campus Community, Personal Information (Student), Identification (Student), External System ID)	External System ID
Additional Information (Records and Enrollment, Graduate Research Management, Candidate Management, Consumption and Submission, Additional Information)	UK Research ORCID
HESA Types (Records and Enrollment, HESA Returns Setup, Returns Setup, HESA Types)	External ID Types

Field Derivation Rule: Include for all Student entities.

Derivation Step:

1. If there is a Research Candidate record for the instance, select the value of the CAF attribute defined for ORCID in Returns Setup from the most recent active consumption record, where the effective date is on or before the reporting period end date.
2. Select External System ID records for the person with the External System ID Type defined for ORCID in the HESA Return Setup record.
3. Derive as null.

Note: Although the **ORCID** field is optional for HESA reporting, the system derives this field value for research council students to assist with record identification.

Institution's Own Identifier for Student (OWNSTU)

Return: Student Record

Entity: Student

Pages Used: None

Field Derivation Rule: Include for all Student entities.

Derivation Step:

1. Derive as EMPLID.

Note: Although the **OWNSTU** field is optional for HESA reporting, the system derives this field value for all students to assist with record identification.

Religion or Belief (RELBLF)

Return: Student Record

Entity: Student

Pages Used:

Page	Page Element
Person HESA Data	RELBLF
Religious Preference (Campus Community, Personal Information, Biographical, Personal Attributes, Religious Preferences).	Religious Preference
Religion (Records and Enrollment, HESA Reporting, Codes and Mappings, Code Mappings, Religion)	HESA Belief

Field Derivation Rule: Include for all entities

Derivation Steps:

1. Derive from the Person HESA Data page.
2. Select the religious preference from the personal information record. Use the mapping on the Religion page to derive the RELBLF code.
3. Use default.
4. Derive as NULL ERROR.

Service Leaver (SERLEAVE)

Return: Student Record

Entity: Student

Pages Used:

Page	Page Element
Person HESA Data	SERLEAVE

Field Derivation Rule: Derive a value if all conditions are met:

- Country = Scotland
- Student has one of these:
 - Any EntryProfile in the extract with DOMICILE = XH
 - Any HESA Entry Profile record with DOMICILE = XH. This includes consideration of all non-future-effective-dated records for the student (based on EMPLID) irrespective of career/instance

- Any Residency Self-Report record where the 2-character country code is XH. This includes consideration of all non-future-effective-dated records for the student (based on EMPLID).

Derivation Steps:

1. Derive from the Person HESA Data page.
2. Use default.
3. If the student has an Instance related to a Course entity that has COURSEAIM beginning with H, I, J, or C, or is M22, M26, or M28, derive as NULL ERROR
4. Derive as null.

Service Student (SERSTU)

Return: Student Record

Entity: Student

Pages Used:

<i>Page</i>	<i>Page Element</i>
Person HESA Data	SERSTU

Field Derivation Rule: Derive a value if all conditions are met:

- Country = Scotland
- EntryProfile.DOMICILE = XH (Scotland)

Derivation Steps:

1. Derive value from the most recent effective-dated Person HESA Data page, where the effective date is on or before the reporting period end date.
2. Use default.
3. Derive as NULL ERROR.

Sex Identifier (SEXID)

Return: Student Record

Entity: Student

Page Used:

Page	Page Element
Biographical Details (Campus Community , Personal Information (Student), Add/Update a Person, Biographical Details)	Gender
Gender (Records and Enrollment, HESA Reporting, Codes and Mappings, Code Mappings, Gender)	HESA Identifier
Campus Community, Personal Information, Add/Update a Person, HESA Student Data	SEXID
Campus Community, Personal Information, Add/Update a Person, HESA Restricted Data	SEXID

Field Derivation Rule: Include for all Student entities.

Derivation Steps:

1. Derive from Person HESA Data.
2. Select the Gender value from the Biographical History record. Derive as the mapped HESA value for the selected Gender value.
3. If no mapping is found, then derive as:
 - If the gender value is Male, derive as *1*.
 - If the gender value is Female, derive as *2*.
4. Use default.
5. Derive as *NULL ERROR*.

Sexual Orientation (SEXORT)

Return: Student Record

Entity: Student

Page Used:

Page	Page Element
Person HESA Data	SEXORT
Personal (Campus Community, Personal Information, Add/Update a Person)	Sexual Orientation

Field Derivation Rule: Include for all entities.

Derivation Steps:

1. Derive from the Person HESA Data page.
2. (Applies only to Campus Solutions 9.2) If a coded value exists in the Person Biographic record and the value is mapped to a HESA code in the Orientation mapping, derive the HESA code.
3. Use default.
4. If Country = England or Northern Ireland, derive as NULL ERROR.
5. Derive as null.

Scottish Candidate Number (SCN)

Return: Student Record

Entity: Student

Page Used:

Page	Page Element
External System ID	External System ID

Field Derivation Rule: Derive a value if the following conditions are met:

- Student has an Instance related to a Course entity that has Course.COURSEAIM beginning with H, I, J, C, P, Q, R, or S
- Either EntryProfile.UCASAPPID exists or Country = Scotland
EntryProfile.UCASAPPID exists if one of the following is found:
 - Student has an Entry Profile in the extract with an EntryProfile.UCASAPPID value.
 - Student has a HESA Entry Profile record with an EntryProfile.UCASAPPID value.
 - An External Application Number exists in the Campus Solutions admission application record and this record is related to the student program record for an Instance being reported for the student.
- One of the following is true (a, b, or c):
 - a. Student has a related EntryProfile in the extract with EntryProfile.DOMICILE = XH (Scotland).
 - b. Student has any HESA Entry Profile record with EntryProfile.DOMICILE = XH. Consider all records for the student (based on EMPLID) irrespective of effective date or career/instance.
 - c. Student has any Residency Self-Report record where the country = XH. Or the student has any Residency Self-Report record where the country = GBR and the combination of Country and

State is mapped to a HESA Country Code = XH in the UCAS Area of Permanent Residence page. Consider all records for the student (based on EMPLID) irrespective of effective date.

Do not derive a value and leave the field blank, if the conditions are not met.

Derivation Steps:

1. Select External System ID records for the person with the External ID Type defined for SCN in the HESA Types page. Value should not be 999999999.
2. Derive as null.

Dependants in Reporting Year (SDEPEND)

Return: Student Record

Entity: Student

Page Used:

Page	Page Element
Person HESA Data	SDEPEND

Field Derivation Rule: Derive a value if the following conditions are met:

- Country = Scotland
- Student has at least one Instance with REDUCEDI = 00

Do not derive a value and leave the field blank, if the conditions are not met.

Derivation Steps:

1. Derive from the Person HESA Data page.
2. Use default.
3. Derive as *NULL ERROR*.

Family Name on 16th Birthday (SNAME16)

Return: Student Record

Entity: Student

Page Used:

Page	Page Element
Names (Campus Community, Personal Information (Student), Add/Update a Person, Biographical Details, Names)	Last Name

Note: The Last Name page element can accept a maximum of thirty characters.

Field Derivation Rule: Include for all Student entities.

Derivation Steps:

1. Use the Last Name value from the Primary Name record. The last name must have a Type of Name value that corresponds with the Name Type set for SNAME16 in the HESA Types page.
2. Do not derive a value and leave the field blank.

Student Support Number (SSN)

Return: Student Record

Entity: Student

Pages Used:

Page	Page Element
SSAR (Financial Aid, Student Loans Company, View SLC Student Data, SSAR)	Student Support Nbr
HESA Instance	SSN

Field Derivation Rule: Derive a value if the student has at least one instance where the related Course.COURSEAIM does not end in 90 or 99.

Derivation Steps:

1. Derive from the HESA Instance page for each related Instance that meets the COURSEAIM condition.

If different multiple SSN values are found, select the value from the HESA instance with the most recent COMDATE.

2. Derive the SSN from the most recent Attendance Confirmation Report (ACR) record (that is, highest sequence number) for the EMPLID and Institution where:
 - The Aid Year start date falls on or before the reporting period end date.
 - The Aid Year end date is not before the reporting period start date for the reporting period in which Instance.COMDATE falls.

- At least one row exists for the ACR with Attendance Indicator set to any value other than *S* or *X*.

This derivation also looks for an SSN from the ACR record when there is no SSAR record. This is because only students who apply for Maintenance Loans and Grants get SSAR records; and only students who apply for Tuition Loan and Grants get ACR records – so students will have one and not the other.

- Derive the SSN from the most recent SSAR record (that is, highest sequence number) for the EMPLID and institution where:
 - The Aid Year start date falls on or before the reporting period end date.
 - The Aid Year end date is not before the reporting period start date for the reporting period in which Instance.COMDATE falls.
 - A related first attendance confirmation record exists.
 - If the UCAS Course Code is defined in the SSAR, then the UCAS Course Code should be linked via a UCAS Course Mapping to the same career and program as an Instance being reported for the student. If the UCAS Course code is not defined in the SSAR, or if there are no UCAS Course Mapping records for the UCAS Course Code, then the SSAR record is assumed to be relevant to the Instance. You perform UCAS CourseMapping on the UCAS Courses page (Set Up SACR, Product Related, Recruiting and Admissions, UCAS, Mappings, UCAS Course).
- Do not derive a value and leave the field blank.

Note: The SSN derivation does not currently consider whether Instance.MSTUFEE is reported as SLC full or partly funded (02, 03, 04, 52, 53 or 54).

Family Name (SURNAME)

Return: Student Record

Entity: Student

Page Used:

Page	Page Element
Names (Campus Community, Personal Information (Student), Add/Update a Person, Biographical Details, Names)	Last Name

Note: The Last Name page element can accept a maximum of thirty characters.

Field Derivation Rule: Include for all entities

Derivation Steps:

- The Last Name value of the most recent effective dated name record with a name type defined for the return for SNAMECHNGE is selected.

2. Derive as *NULL ERROR*.

Term-time Accommodation (TTACCOM)

Return: Student Record

Entity: Student

Page Used:

Page	Page Element
Person HESA Data	TTACCOM

Field Derivation Rule: Derive a value if the following conditions are met:

- The student has at least one Instance with REDUCEDI = 00
- LOCSDY does not equal S
- MODE = 01, 02, 23, 24, or 25

Do not derive a value and leave the field blank, if the conditions are not met.

Derivation Steps:

1. Derive from the Person HESA Data page.
2. Use default
3. Derive as *NULL ERROR*.

Term-time Postcode (TTPCODE)

Return: Student Record

Entity: Student

Page Used:

Page	Page Element
Person HESA Data	TTPCODE
Addresses (Campus Community, Personal Information (Student), Biographical (Student), Addresses/Phones, Addresses)	Postal

Field Derivation Rule: Derive a value if one of the following conditions is met:

- Country = England, Northern Ireland, or Scotland, the student has at least one Instance with Instance.REDUCEDI = 00 or 07, AND Instance.LOCSYD is blank or does not equal 6, 9, D, S or T.
- Country = Wales, the student has at least one Instance with Instance.REDUCEDI = 00 or 07, Instance.LOCSYD does not equal 6, 9, D, S or T AND Course.COURSEAIM does not begin with P, Q, R, S or X.

Do not derive a value and leave the field blank, if the conditions are not met.

Derivation Steps:

1. Derive from the Person HESA Data page.
2. Select the most recent address record (exclude records with an effective date greater than the end date of the reporting period) that has one of the UK-related country codes. The record must have an Address Type that corresponds with the Address Type set for TTPCODE in the HESA Types page.

The following country codes are considered as UK-related for the purposes of this derivation: GBR (United Kingdom), ENG (England), XF (England), NIR (Northern Ireland), XG (Northern Ireland), SCT (Scotland), XH (Scotland), WAL (Wales), XI (Wales), XK (UK not otherwise specified), XL (Channel Islands not otherwise specified), GG (Guernsey), GGY (Guernsey), JE (Jersey), JEY (Jersey), IM (Isle of Man), or IMN (Isle of Man).

3. Use default.
4. Derive as null.

For steps 1 and 2, the system validates that the derived post code value is in the correct format (refer to the examples for TTPCODE available on the HESA website).

UCAS Personal Identifier (UCASPERID)

Return: Student Record

Entity: Student

Page Used:

Page	Page Element
External System ID	External System ID

Field Derivation Rule: Derive a value if the following conditions are met:

- The student has an Instance with Instance.COMDATE after 2007-07-31 and
- Either EntryProfile.UCASAPPID value exists on the Entry Profile page (any effective-dated row) or the External Application Number associated with the Instance begins UC. Use the Student Program record of the instance to find the admission application number (ADM_APPL_NBR). Use this admission application number to find the Admissions Data record (PS_ADM_APPL_DATA). Then, from the Application Data page for this record, find the External Application Number. The External Application Number holds the UCAS Application Code plus Choice Number for a UCAS application.

Do not derive a value and leave the field blank, if the conditions are not met.

Derivation Steps:

1. Select External System ID records for the person with the External ID Type defined for UCASPERID in the HESA Types page.
2. Derive as *NULL ERROR*.

Unique Learner Number (ULN)

Return: Student Record

Entity: Student

Page Used:

<i>Page</i>	<i>Page Element</i>
External System ID	External System ID

Field Derivation Rule: Include for all Student entities.

Derivation Steps:

1. Select External System ID records for the person with the External ID Type defined for ULN in the HESA Types page.

Validate the derived value using the checksum method. For information on the checksum method, refer to the Notes section for the ULN field available on the HESA website.
2. If Country = England and there is any instance for the student with Instance.FESTUMK = 1, 3, or 5 derive as *NULL ERROR*.
3. Do not derive a value and leave the field blank.

Welsh Speaker Indicator (WELSSP)

Return: Student Record

Entity: Student

Page Used:

<i>Page</i>	<i>Page Element</i>
Person HESA Data	WELSSP

Field Derivation Rule: Derive a value if the following conditions are met:

- Country = Wales

- The student has an Instance with REDUCEDI = 00
- One of the following is true (a, b, or c):
 - (a) The student has a related EntryProfile in the extract with DOMICILE = XI
 - (b) The student has any HESA Entry Profile record with DOMICILE = XI. This includes consideration of all records for the student (based on EMPLID) irrespective of effective date or career/instance.
 - (c) The student has any Residency Self-Report record where the country = GBR and the combination of Country and State is mapped to a HESA Country Code = XI in the UCAS Area of Permanent Residence page. This includes consideration of all records for the student (based on EMPLID) irrespective of effective date.

Do not derive a value and leave the field blank, if the conditions are not met.

Derivation Steps:

1. Use constant.
2. Derive from the Person HESA Data page.
3. Use default.
4. Derive as *NULL ERROR*.

Student Record Return: Instance Entity

If you select the **Include Student Entities** check box on the Create Extract Data page, the Create Extract process creates Instance entities based on distinct student careers and the related HESA Instance.

The process includes a student career as an Instance entity if the following three conditions are met:

- The process has included the plan (or the subplan if the subplan rather than the plan is being reported) of the student program record as a Course entity in the extract. Note that if the student has multiple active plans the process considers the plan defined in the HESA Instance record.
- The plan or subplan is selected for COURSEID based on the most recent Student Program/Plan record on or before the reporting period end date where the program action/reason is not defined in the Award Only Mapping for the return.
- A related HESA Instance record exists for the career and academic institution with the **Report To HESA** check box selected.
- The student must be a *continuing student* (that is, the derived commencement date is prior to the start of the reporting period) or a *new student* (that is, the derived commencement date falls on or after the start of the reporting period).

If the student is a *continuing student*, then one of the following conditions must be satisfied:

- The student is in the HIN Population. That is, a HIN Population Year value exists in the HESA Instance record that matches the Reporting Period Year.

- You have not selected the HIN Population Only check box and the student has not left or completed prior to the reporting period. To determine whether the student has not left or completed prior to the reporting period, the process first selects the Student Program record that has an effective date nearest to the Reporting Period Start Date. Then, it checks whether the selected record has a Program Status that matches one of the eligible Program Statuses defined for the return on the HESA Returns page.

Note: If you have selected the check box, for each student career, the process only evaluates whether the first condition is met (that is, student is in the HIN population) and does not evaluate the second condition (that is, the student has not left or completed prior to the reporting period). In other words, if you select the check box and if the first condition is not met, the student career is not included.

If the student is a *new student*, then one of the following conditions must be satisfied:

- The student is in the HIN Population.
- The student has been term activated for at least one term that begins within the reporting period and the student has at least one enrolled class related to that term.
- The student has an FTE of greater than zero for the reporting period.

Note: The HIN Population Year value in the HESA Instance record may not exist for new students. Therefore, the process does not consider the HIN Population Only check box for selection of new students. It includes a new student based on either the class enrollment condition or the FTE condition, if the student is not in the HIN population.

The Create Extract process uses the following fields set up on the HESA Instance page for a student career:

- Academic Plan: Indicates the plan to report if the student has multiple active plans.
- Linked Career and Linked Career Number: Indicates that the student instance is associated with another instance.
- Report To HESA: If the check box is cleared, the process does not include the instance data.
- Start Date of Instance: The system calculates a value but you can use this field to override the calculated value.
- Population Year: Indicates the reporting year for which the system should include the Instance in the return. You must manually enter the Population Year on the HESA Instance page or import the values using the Import Target Population process.
- Year of Course: Indicates the year of course the student is undertaking for reporting in Instance.YEARPRG. You must update this value for each subsequent reporting period when the student has progressed to the next year of the program.
- Year of Student: Indicates the number of years the student has been undertaking the program for reporting in Instance.YEARSTU. You must update this value for each subsequent reporting period when the student has progressed to the next year of the program.

The system does not automatically calculate the Year of Course and Year of Student values on the HESA Instance page. You must use the HESA Instance page to manually enter the Year of Course and Year of Student values.

The Create Extract process derives the fields relevant to further education (FE) students only if the Include FE check box is selected on the HESA Returns page. Although you can include or exclude individual FE fields using the derived value for FESTUMK, the Include FE check box enables you to skip derivation of FE fields completely.

While creating Instance entities, the process checks if the student's External System ID records has a HUSID. If no records are found, the process creates a HUSID External System ID for the student with an Effective Date of the reporting period start date.

If you have selected the Null Errors Only check box for the Include Student Entities on the Create Extract Data page, the Create Extract process selects distinct EMPLIDs from the existing active extract data, where at least one field in the Instance, EntryProfile, QualificationsOnEntry, QualificationsAwarded, RAEDData, StudentOnModule or Student extract data has a derived value of *NULL ERROR*. The process then selects all the Instance entity records for these EMPLIDs (if an EMPLID has multiple instances and if at least one instance has a *NULL ERROR*, then all the instances are selected).

If you have selected the Validation Errors Only check box for the Include Student Entities, the Create Extract process first deletes any Validation Error staging records where all of the COURSEID, MODID and EMPLID fields are blank. Then, it selects distinct EMPLIDs from the Validation Error staging table where the EMPLID is not blank. The process selects Instance entity records for these EMPLIDs. Finally, the process deletes records from the Validation Error staging table where EMPLID is populated.

Actual Progression Route (ACTPROGROUTE)

Return: Student Record

Entity: Instance

Page Used:

<i>Page</i>	<i>Page Element</i>
HESA Instance	ACTPROGROUTE

Field Derivation Rule: Derive only if the **Include FE** check box is selected.

Derive a value if the following conditions are met:

- Country = England
- Instance.REDUCEDI = 00 or 01
- Instance.FESTUMK = 1, 3, or 4
- Instance.ENDDATE value exists
- Instance.PROGTYPE = 02, 03, 10, 19, 20 or 21
- Instance.AIMTYPE = 1

Do not derive a value and leave the field blank, if the conditions are not met.

Derivation Steps:

1. Use constant.
2. Derive from the HESA Instance page.
3. Use default.
4. Derive as *NULL ERROR*.

Learning Support Cost (ADDSUPCT)

Return: Student Record

Entity: Instance

Page Used:

<i>Page</i>	<i>Page Element</i>
HESA Instance	ADDSUPCT

Field Derivation Rule: Derive only if the **Include FE** check box is selected.

Derive a value if the following conditions are met:

- Country = England
- Instance.FESTUMK = 1, 3, or 4
- Instance.REDUCEDI = 00 or 01
- Instance.FUNDMODEL = 25 or 82
- LearnerFAM.LEARNFAMTYPE = HNS

Do not derive a value and leave the field blank, if the conditions are not met.

Derivation Steps:

1. Use constant.
2. Derive from the HESA Instance page.
3. Use default.
4. Derive as *NULL ERROR*.

The Type of Aim Recorded (AIMTYPE)

Return: Student Record

Entity: Instance

Pages Used:

Page	Page Element
Program HESA Data	AIMTYPE
Plan HESA Data	AIMTYPE
Sub-Plan HESA	AIMTYPE
HESA Instance	AIMTYPE

Field Derivation Rule: Derive only if the Include FE check box is selected.

Derive a value if the following conditions are met:

- Country = England
- Instance.REDUCEDI = 00 or 01
- Instance.FESTUMK = 1, 3, 4, or 5

Do not derive a value and leave the field blank, if the conditions are not met.

Derivation Steps:

1. Use constant.
2. Derive from the HESA Instance page.
3. If Instance.COURSEID is based on a subplan, derive from the Sub-Plan HESA page.
4. Derive from the Plan HESA Data page.
5. Derive from the Program HESA Data page.
6. Use default.
7. Derive as *NULL ERROR*.

Foundation Degree to Degree Bridging Course (BRIDGE)

Return: Student Record

Entity: Instance

Pages Used:

Page	Page Element
Program HESA Data	BRIDGE

Page	Page Element
Plan HESA Data	BRIDGE
Sub-Plan HESA	BRIDGE

Field Derivation Rule: Derive a value if one of the following conditions is met:

- Country = England, Northern Ireland, or Scotland AND Instance.REDUCEDI = 00 AND Related Course.COURSEAIM is not Z99
- Country = Wales, REDUCEDI = 00, AND COURSEAIM does not begin with P, Q, R, S, or X, and is not Z99.

Derivation Steps:

1. Use constant.
2. If Instance.COURSEID is based on a subplan, derive from the Sub-Plan HESA page.
3. Derive from the Plan HESA Data page.
4. Derive from the Program HESA Data page.
5. Use default.
6. Derive as *NULL ERROR*.

Campus Identifier (CAMPID)

Return: Student Record

Entity: Instance

Pages Used:

Page	Page Element
Student Program	Campus
Campus (Records and Enrollment > HESA Reporting > Codes and Mappings > Code Mappings > Campus)	HESA Campus

Field Derivation Rule: Include for all Instance entities.

Derivation Steps:

1. Use constant.
2. Use the mapping to derive the HESA Campus code for the Campus value entered in the Student Program page.

3. Use default.
4. Derive as *NULL ERROR*.

Completion Status (CSTAT)

Return: Student Record

Entity: Instance

Page Used:

<i>Page</i>	<i>Page Element</i>
HESA Instance	CSTAT

Field Derivation Rule: Derive only if the **Include FE** check box is selected.

Derive a value if the following conditions are met:

- Country = England or Wales
- Instance.FESTUMK = 1, 3, 4, or 5
- Instance.REDUCEDI = 00 or 01

Do not derive a value and leave the field blank, if the conditions are not met.

Derivation Steps:

1. Use constant.
2. Derive from the HESA Instance page.
3. Use default.
4. Derive as *NULL ERROR*.

Provider Transfer From Date (COLFROMDATE)

Return: Student Record

Entity: Instance

Page Used:

<i>Page</i>	<i>Page Element</i>
HESA Instance	COLFROMDATE

Field Derivation Rule: Derive a value if related Course.COURSEAIM = D00, D01, L00, or L80.

Derivation Steps:

1. Derive from the HESA Instance page.
2. Derive as *NULL*.

Provider Transferred From (COLFROMPROV)

Return: Student Record

Entity: Instance

Page Used:

<i>Page</i>	<i>Page Element</i>
HESA Instance	COLFROMPROV

Field Derivation Rule: Derive a value if related Course.COURSEAIM = D00, D01, L00, or L80.

Derivation Steps:

1. Derive from the HESA Instance page.
2. Derive as *NULL*.

Provider Transfer to Date (COLTODATE)

Return: Student Record

Entity: Instance

Page Used:

<i>Page</i>	<i>Page Element</i>
HESA Instance	COLTODATE

Field Derivation Rule:

Derive a value if the following conditions are met:

- Instance.RSEND = 12
- Related Course.COURSEAIM = D00, D01, L00, or L80

Derivation Steps:

1. Derive from the HESA Instance page.
2. Derive as *ENDDATE*.

Provider Transferred To (COLTOPROV)

Return: Student Record

Entity: Instance

Page Used:

Page	Page Element
HESA Instance	COLTOPROV

Field Derivation Rule:

Derive a value if the following conditions are met:

- Instance.RSEND = 12
- Related Course.COURSEAIM = D00, D01, L00, or L80

Derivation Steps:

1. Derive from the HESA Instance page.
2. Derive as *NULL*.

Start Date of Instance (COMDATE)

Return: Student Record

Entity: Instance

Page Used:

Page	Page Element
HESA Instance	Start Date of Instance Effective Date

Field Derivation Rule: Include for all Instance entities.

Derivation Steps:

1. Derive as the Start Date of Instance from the HESA Instance page.
2. If there is a Research Candidate record for the instance:
 - a. Select the Begin Date (SSR_RS_BEGIN_DT) from the most recent active Consumption record where the effective date is on or before the reporting period end date.
 - b. Derive the Begin Date formatted to YYYY-MM-DD.

- c. Match the Research Candidate record (SSR_RS_CAND_HDR) to the instance on EMPLID, Institution, Career and Career Number to find the Research Candidate Number (SSR_RS_CANDIT_NBR). If multiple records are found, the record with the highest candidate number is selected.
- d. Associate consumption records (SSR_RS_CONSMPTN) with the Research Candidate record by EMPLID, Institution and Research Candidate Number.

The calculated value is stored in the HESA Instance Data record.

3. Use the following process to calculate the earliest class start date for enrolled classes related to the Instance being reported. This selection is similar to that done for StudentOnModule except that it is not restricted to classes overlapping the reporting period and considers enrollments for linked careers.
 - a. Select all activated terms for the student career of the Instance.
 - b. From each activated term, select classes that satisfy the following conditions:
 - Status = *Enrolled*
 - Units Taken value is greater than zero.
 - Grading basis value matches one of the values defined in the Grading Basis Inclusion region with the Extract check box selected on the HESA Configuration page.
 - Repeat Code value does not exist or does not match a value defined in the Repeat Code Exclusion region with the Extract check box selected on the HESA Configuration page.
 - If the student has multiple careers with the same Academic Career value as the career being processed (that is, the same career value with different career numbers), then apply a further filter to the class enrollments. In such a case, select the class only if the program value of the enrollment record is does not exist or matches one of the program values in the Student Program records for that career and career number.
 - c. If the Instance has been linked to a prior student career using the **Linked Career** and **Linked Career Number** fields in the HESA Instance record, then also consider classes for the previous career.
 - d. Derive the earliest Class Start Date from all the selected classes as COMDATE.
4. The earliest Effective Date of the HESA Instance records.

For steps 2 and 3, the system stores the derived date as the Start Date of Instance value in the HESA Instance record.

Course Identifier (COURSEID)

Return: Student Record

Entity: Instance

Pages Used: None

Field Derivation Rule: Include for all Instance entities.

Derivation Steps:

1. If the student's subplan is reported in the Course extract, derive from the student's subplan.
2. Derive from the student's plan.

Destination (DESTIN)

Return: Student Record

Entity: Instance

Page Used:

<i>Page</i>	<i>Page Element</i>
HESA Instance	DESTIN

Field Derivation Rule: Derive only if the **Include FE** check box is selected.

Derive a value if the following conditions are met:

- Country = Wales
- Instance.FESTUMK = 1, 3, or 4
- Instance.REDUCEDI = 00 or 01
- Course.COURSEAIM begins with P, Q, R, S or X.

Do not derive a value and leave the field blank, if the conditions are not met.

Derivation Steps:

1. Use constant.
2. Derive from the HESA Instance page.
3. Use default.
4. Derive as *NULL ERROR*.

Destination of Outward Credit Mobile Students (DESTOCM)

Return: Student Record

Entity: Instance

Pages Used:

Page	Page Element
Program Offering/Year HESA	DESTOCM, DESTOCM2, DESTOCM3 (Program Year HESA Data group box)
Plan Offering/Year HESA	DESTOCM, DESTOCM2, DESTOCM3 (Plan Year HESA Data group box)
Sub-Plan Offering/Year HESA	DESTOCM, DESTOCM2, DESTOCM3 (Sub-Plan Year Data group box)
HESA Instance	DESTOCM, DESTOCM2, DESTOCM3

Field Derivation Rule: Derive a value if the following conditions are met:

- Country = England, Wales, or Northern Ireland
- Instance.REDUCEDI = 00
- (Instance.EXCHANGE = 7, B, C, D, or E) or (Instance.LOCSDY = F, G or S)

Do not derive a value and leave the field blank, if the conditions are not met.

Derivation Steps:

1. Use constant to create a single **DESTOCM** field.
2. Derive from the HESA Instance page.
3. If Instance.COURSEID is based on a subplan, derive from the Sub-Plan Offering/Year HESA page for the combination of academic load and YEARPRG of the student instance.
4. Derive from the Plan Offering/Year HESA page for the combination of academic load and YEARPRG of the student instance.
5. Derive from the Program Offering/Year HESA page for the combination of academic load and YEARPRG of the student instance.
6. Use default to create a single **DESTOCM** field.
7. Derive a single **DESTOCM** field as *NULL ERROR*.

Note: The system can derive up to three values. Each of the values is included as a separate **DESTOCM** field in the XML file.

Department of Health Funding Body (DHFUND)

Return: Student Record

Entity: Instance

Pages Used:

Page	Page Element
Program HESA Data	DHFUND
Plan HESA Data	DHFUND
Sub-Plan HESA	DHFUND
HESA Instance	DHFUND

Field Derivation Rule: Derive a value if the following conditions are met:

- Country = England
- Instance.REDUCEDI = 00 or 01
- Related Course.MSFUND = 37 or 38

Do not derive a value and leave the field blank, if the conditions are not met.

Derivation Steps:

1. Use constant.
2. Derive from the HESA Instance page.
3. If Instance.COURSEID is based on a subplan, derive from the Sub-Plan HESA page.
4. Derive from the Plan HESA Data page.
5. Derive from the Program HESA Data page.
6. Use default.
7. Derive as *NULL ERROR*.

Regulatory Body Reference Number (DHREGREF)

Return: Student Record

Entity: Instance

Page Used:

Page	Page Element
External System ID	External System ID

Field Derivation Rule: Derive a value if the following conditions are met:

- Instance.REDUCEDI = 00 or 01

- Related Course.REGBODY = 06 or 07 or is in the range 40 to 55 inclusive or is in the range 60 to 65 inclusive
- Related Course.COURSEAIM = M16, M26, M76, M86, H16, H62, H76, I16, I76, J26 or J76

Do not derive a value and leave the field blank, if the conditions are not met.

Derivation Steps:

1. Select External System ID records for the person with the External ID Type defined for DHREGREF in the HESA Types page.
2. Use default.
3. Derive as *NULL ERROR*.

You can define a default of 99999999 for this field.

Disabled Student Allowance (DISALL)

Return: Student Record

Entity: Instance

Page Used:

Page	Page Element
HESA Instance	DISALL
Impairment AUS (Campus Community > Personal Information > Health Information > Impairment AUS)	Support Services Request
Disability (Records and Enrollment, HESA Reporting, Codes and Mappings, Code Mappings, Disability)	HESA Disability Allowance

Field Derivation Rule: Derive a value if one of the following conditions is met:

- Country = England, Northern Ireland, or Scotland, Instance.REDUCEDI = 00 AND Student.DISABLE = 08 to 96 inclusive.
- Country = Wales, Instance.REDUCEDI = 00, Student.DISABLE = 08 to 96 inclusive, AND Course.COURSEAIM does not begin with P, Q, R, S or X.

Do not derive a value and leave the field blank, if the conditions are not met.

Derivation Steps:

1. Use constant.
2. Derive from the HESA Instance page.

3. If the student has a Support Services Request value defined on the Impairment AUS page, use the mapped HESA Disability Allowance code from the Disability page.
4. Use default.
5. Derive as *NULL ERROR*.

Note: The system derives Student.DISABLE before creating the Student entity in order to derive the Student.DISALL field.

Disadvantage Uplift Factor (DISUPFAC)

Return: Student Record

Entity: Instance

Pages Used:

<i>Page</i>	<i>Page Element</i>
HESA Instance	DISUPFAC

Field Derivation Rule: Derive only if the **Include FE** check box is selected.

Derive a value if the following conditions are met:

- Country = England
- Instance.FESTUMK = 1, 3, or 4
- Instance.REDUCEDI = 00 or 01

Do not derive a value and leave the field blank, if the conditions are not met.

Derivation Steps:

1. Use constant.
2. Derive from the HESA Instance page.
3. Use default.
4. Derive as *NULL ERROR*.

Distance Learning SLN (DISTLEARNSLN)

Return: Student Record

Entity: Instance

Pages Used:

Page	Page Element
Program HESA Data	DISTLEARNSLN
Plan HESA Data	DISTLEARNSLN
Sub-Plan HESA	DISTLEARNSLN
HESA Instance	DISTLEARNSLN

Field Derivation Rule: Derive only if the Include FE check box is selected.

Derive a value if the following conditions are met:

- Country = England
- Instance.REDUCEDI = 00 or 01
- Instance.FESTUMK = 1 or 3
- Instance.AIMTYPE = 2, 3 or 4

Do not derive a value and leave the field blank, if the conditions are not met.

Derivation Steps:

1. Use constant.
2. Derive from the HESA Instance page.
3. If Instance.COURSEID is based on a subplan, derive from the Sub-Plan HESA page.
4. Derive from the Plan HESA Data page.
5. Derive from the Program HESA Data page.
6. Use default.
7. If Instance.FUNDMODEL = 21 or 22, derive as *NULL ERROR*.
8. Do not derive a value and leave the field blank.

Eligibility for Disadvantaged Uplift (ELIDISUP)

Return: Student Record

Entity: Instance

Page Used:

Page	Page Element
HESA Instance	ELIDISUP

Field Derivation Rule: Derive only if the **Include FE** check box is selected.

Derive a value if the following conditions are met:

- Country = England
- Instance.FESTUMK = 1, 3, or 4
- Instance.REDUCEDI = 00

Do not derive a value and leave the field blank, if the conditions are not met.

Derivation Steps:

1. Use constant.
2. Derive from the HESA Instance page.
3. Use default.
4. Derive as *NULL ERROR*.

Eligibility for Enhanced Funding (ELIGENFD)

Return: Student Record

Entity: Instance

Page Used:

Page	Page Element
HESA Instance	ELIGENFD

Field Derivation Rule: Derive only if the **Include FE** check box is selected.

Derive a value if the following conditions are met:

- Country = England
- Instance.FESTUMK = 1, 3, or 4
- Instance.REDUCEDI = 00

Do not derive a value and leave the field blank, if the conditions are not met.

Derivation Steps:

1. Use constant.

2. Derive from the HESA Instance page.
3. Use default.
4. Derive as *NULL ERROR*.

Aiming for an Equivalent or Lower Qualification (ELQ)

Return: Student Record

Entity: Instance

Page Used:

Page	Page Element
HESA Instance	ELQ

Field Derivation Rule: Derive a value if the following conditions are met:

- Country = England
- Instance.REDUCEDI = 00 or 01
- Instance.FEEELIG = 1
- Instance.FESTUMK = 2 or 3
- Related Course.COURSEAIM begins E, M, H, I, J or C

Do not derive a value and leave the field blank, if the conditions are not met.

Derivation Steps:

1. Derive from the HESA Instance page.
2. Use default.
3. Derive as *NULL ERROR*.

Employer Role (EMPROLE)

Return: Student Record

Entity: Instance

Page Used:

Page	Page Element
HESA Instance	EMPROLE

Field Derivation Rule: Derive only if the **Include FE** check box is selected.

Derive a value if the following conditions are met:

- Country = Wales
- Instance.FESTUMK = 1, 3, or 4
- Instance.REDUCEDI = 00 or 01

Do not derive a value and leave the field blank, if the conditions are not met.

Derivation Steps:

1. Use constant.
2. Derive from the HESA Instance page.
3. Use default.
4. Do not derive a value and leave the field blank.

End Date of Instance (ENDDATE)

Return: Student Record

Entity: Instance

Pages Used:

Page	Page Element
Student Program	Program Action Action Reason Effective Date
HESA Instance	ENDDATE
HESA Action Reasons	Reason for Ending Instance Mapping

Field Derivation Rule: Include for all Instance entities.

Derivation Steps:

1. Derive from the HESA Instance page.
2. Derive the effective date of the record formatted to YYYY-MM-DD if the most recent effective dated Student Program record has Program Action/Reason values mapped to a HESA Reason for Ending Instance code on the HESA Action Reasons page and, either Instance.INTERCALATE is not 01, or the mapped HESA RSNEND value is not 01.

3. Derive as null.

Highest Grade GCSE English (ENGGRADE)

Return: Student Record

Entity: Instance

Pages Used:

Page	Page Element
Further Education (Records and Enrollment, Career and Program Information, HESA Instance Details, Further Education)	ENGGRADE

Field Derivation Rule: Derive a value if all the following conditions are met.

- Country = England
- Instance.FESTUMK = 1, 3, or 4
- Instance.REDUCEDI = 00 or 01
- Instance.FUNDMODEL = 25 or 82

Derivation Steps:

1. Derive from the Further Education page.
2. Derive as *NONE*.

ITT Entry Route (ENTRYRTE)

Return: Student Record

Entity: Instance

Pages Used:

Page	Page Element
Program HESA Data	ENTRYRTE
Plan HESA Data	ENTRYRTE
Sub-Plan HESA	ENTRYRTE
HESA Instance	ENTRYRTE

Field Derivation Rule: Derive a value if all the following conditions are met.

- Country = England
- Instance.REDUCEDI = 00, 01, or 04
- Related Course.TTCID = 1

Derivation Steps:

1. Use constant.
2. Derive from HESA Instance page.
3. If Instance.COURSEID is based on a sub-plan, derive value from the Sub-Plan HESA page.
4. Derive value from Plan HESA Data page.
5. Derive value from Program HESA Data page.
6. Use default.
7. Derive as NULL ERROR.

Exchange Programmes (EXCHANGE)

Return: Student Record

Entity: Instance

Pages Used:

Page	Page Element
Program HESA Data	EXCHANGE
Program Offering/Year HESA	EXCHANGE (Program Year HESA Data group box)
Plan HESA Data	EXCHANGE
Plan Offering/Year HESA	EXCHANGE (Plan Year HESA Data group box)
Sub-Plan HESA	EXCHANGE
Sub-Plan Offering/Year HESA	EXCHANGE (Sub-Plan Year HESA Data group box)
HESA Instance	EXCHANGE
HESA Instance	Year of Program

Field Derivation Rule: Derive a value if one of the following conditions is met:

- Country = England, Northern Ireland, or Scotland AND Instance.REDUCEDI = 00, 03 or 09 AND Instance.FESTUMK is not 5
- Country = Wales, Instance.REDUCEDI = 00, 03 or 09 AND Instance.FESTUMK is not 5 AND Course.COURSEAIM does not begin with P, Q, R, S or X.

Derivation Steps:

1. Use constant.
2. Derive from the HESA Instance page.
3. If Instance.COURSEID is based on a subplan, derive from the Sub-Plan Offering/Year HESA page for the combination of academic load and YEARPRG of the student instance. Only records where Offering Start Term, Offering Start Session, Campus, Year Term and Year Session are all blank are considered.
4. If Instance.COURSEID is based on a subplan, derive from the Sub-Plan HESA page.
5. Derive from the Plan Offering/Year HESA page for the combination of academic load and YEARPRG of the student instance. Only records where Offering Start Term, Offering Start Session, Campus, Year Term and Year Session are all blank are considered.
6. Derive from the Plan HESA Data page.
7. Derive from the Program Offering/Year HESA page for the combination of academic load and YEARPRG of the student instance.
8. Derive from the Program HESA Data page.
9. Use default.
10. Derive as *NULL ERROR*.

Fee Eligibility (FEEELIG)

Return: Student Record

Entity: Instance

Pages Used:

Page	Page Element
Residency Official 1 (Campus Community, Personal Information (Student), Identification (Student), Residency Data, Residency Official 1)	Residency
Program HESA Data	FEEELIG
Program Offering/Year HESA	FEEELIG (Program Offering HESA Data group box)

Page	Page Element
Plan HESA Data	FEEELIG
Plan Offering/Year HESA	FEEELIG (Plan Offering HESA Data group box)
Sub-Plan HESA	FEEELIG
Sub-Plan Offering/Year HESA	FEEELIG (Sub-Plan Offering HESA Data group box)
HESA Instance	FEEELIG
Fee Eligibility (Records and Enrollment, HESA Reporting, Codes and Mappings, Code Mappings, Fee Eligibility)	HESA Fee Eligibility

Field Derivation Rule: Derive a value if the following conditions are met.

- Instance.REDUCEDI = 00 or 01
- Instance.FESTUMK is not 5

Derivation Steps:

1. Use constant.
2. Derive from the HESA Instance page.
3. Select the residency records for the EMPLID, institution, and academic career combination for the most recent effective term that starts on or before the end of the reporting period. Use the HESA Fee Eligibility code mapped to the selected residency value. If the mapping does not exist, log an error message and skip to the next step.
4. If Instance.COURSEID is based on a subplan, derive from the Sub-Plan Offering/Year HESA page for the academic load of the student instance. Only records where Offering Start Term, Offering Start Session, and Campus are all blank are considered.
5. If Instance.COURSEID is based on a subplan, derive from the Sub-Plan HESA page.
6. Derive from the Plan Offering/Year HESA page for the academic load of the student instance. Only records where Offering Start Term, Offering Start Session, and Campus are all blank are considered.
7. Derive from the Plan HESA Data page.
8. Derive from the Program Offering/Year HESA page for the academic load of the student instance.
9. Derive from the Program HESA Data page.
10. Use default.
11. Derive as *NULL ERROR*.

Fee Regime Indicator (FEEREGIME)

Return: Student Record

Entity: Instance

Page Used:

<i>Page</i>	<i>Page Element</i>
HESA Instance	FEEREGIME

Field Derivation Rule: Derive a value if one of the following sets of conditions is met. Otherwise, do not derive a value and leave the field blank.

<i>Set</i>	<i>Conditions</i>
Northern Ireland Postgraduate	<ul style="list-style-type: none"> • Country = Northern Ireland, and • Related Course.COURSEAIM is M71, M73, or M88 • Instance.REDUCEDI = 00 or 01, and • Instance.FEEELIG = 1 or 3, and • Instance.EXCHANGE is not 4 or G, and • Instance.SSN value does not exist, and • (Instance.MODE = 01, 02, 23, 24, or 25) or (Instance.MODE = 43 and Instance.MCDATE is in the reporting period)
Northern Ireland Undergraduate	<ul style="list-style-type: none"> • Country = Northern Ireland, and • Related Course.COURSEAIM begins with H, I, J, C or is M22, M26 or M28 • Instance.REDUCEDI = 00 or 01, and • Instance.FEEELIG = 1 or 3, and • Instance.EXCHANGE is not 4 or G, and • Instance.SSN value does not exist, and • Instance.MODE = 01, 02, 23, 24, 25, or 43

Set	Conditions
Scotland	<ul style="list-style-type: none"> • Country = Scotland, and • Instance.REDUCEDI = 00 or 01, and • Instance.FEEELIG = 1 or 3, and • Instance.EXCHANGE is not 4, G, Y or Z, and • Instance.MODE = 01, 02, 23, 24, or 25, and • Related Course.COURSEAIM is C20, C30, H00, H11, H16, H18, H22, H23, H50, H88, I00, I11, I16, J20, J26, J30, M22, M26, M28, M71, M73, or M88

Derivation Steps:

1. Derive from the HESA Instance page.
2. If Instance.COMDATE is before *01-SEP-2012*, derive as *10*.
3. If Instance.COMDATE is on or after *01-SEP-2012* and Country = Scotland and either DOMICILE is Scotland (XH) or DOMICILE is European Union (excluding England, Northern Ireland and Wales), derive as *10*.

The DOMICILE value is derived in the same way as EntryProfile.DOMICILE and is derived even if an EntryProfile is not being included in the extract (that is, for new and continuing students).

The check on European Union includes countries where the EU Member State check box is selected in the Country Table plus also the generic *EU* code (European Union not otherwise specified) and specifically excludes the individual country codes for England (XF), Northern Ireland (XG), Wales (XI) and UK not specified (XK).

4. If COMDATE is on or after *01-SEP-2012* and Country = Northern Ireland and either DOMICILE is Northern Ireland (XG) or DOMICILE is European Union (excluding England, Scotland and Wales), derive as *10*.
5. If Instance.COMDATE is on or after *01-SEP-2012*, derive as *20*.

Outcome (FEOUTCOME)

Return: Student Record

Entity: Instance

Page Used:

Page	Page Element
HESA Instance	FEOUTCOME

Field Derivation Rule: Derive only if the **Include FE** check box is selected.

Derive a value if the following conditions are met:

- Country = England
- Instance.REDUCEDI = 00 or 01
- Instance.FESTUMK = 1, 3, 4, or 5

Do not derive a value and leave the field blank, if the conditions are not met.

Derivation Steps:

1. Use constant.
2. Derive from the HESA Instance page.
3. Use default.
4. Derive as *NULL ERROR*.

FE Student Marker (FESTUMK)

Return: Student Record

Entity: Instance

Pages Used:

<i>Page</i>	<i>Page Element</i>
Program HESA Data	FESTUMK
Plan HESA Data	FESTUMK
Sub-Plan HESA	FESTUMK
HESA Instance	FESTUMK
HESA Returns	Include FE

Field Derivation Rule: Derive a value if the following conditions are met:

- Country = England or Wales
- Instance.REDUCEDI is 00, 01, 03 or 04

Do not derive a value and leave the field blank, if the conditions are not met.

Derivation Steps:

1. Derive as 2 if **Include FE** check box is not selected on the HESA Returns page.

2. Derive from the HESA Instance page.
3. If Instance.COURSEID is based on a subplan, derive from the Sub-Plan HESA page.
4. Derive from the Plan HESA Data page.
5. Derive from the Program HESA Data page.
6. Use default.
7. Derive as *NULL ERROR*.

Other Funding Adjustment (FUNDADJOTH)

Return: Student Record

Entity: Instance

Page Used:

Page	Page Element
HESA Instance	FUNDADJOTH

Field Derivation Rule: Derive a value if the following conditions are met:

- Country = England
- Instance.FESTUMK = 1, 3, 4, or 5
- Instance.REDUCEDI = 00 or 01
- Either (Instance.AIMTYPE = 1, 3, or 4 and Instance.FUNDMODEL = 35 or 81) OR (Instance.AIMTYPE = 4 and LearningDeliveryFAM.LEARNDELTYPE = ADL)

Do not derive a value and leave the field blank, if the conditions are not met.

Derivation Steps:

1. Use constant.
2. Derive from the HESA Instance page.
3. Use default.
4. Derive as *NULL ERROR*.

Funding Adjustment for Prior Learning (FUNDADJPRIOR)

Return: Student Record

Entity: Instance

Page Used:

Page	Page Element
HESA Instance	FUNDADJPRIOR

Field Derivation Rule: Derive a value if the following conditions are met:

- Country = England
- Instance.FESTUMK = 1, 3, 4, or 5
- Instance.REDUCEDI = 00 or 01
- Either (Instance.AIMTYPE = 1, 3, or 4 and Instance.FUNDMODEL = 35 or 81) OR (Instance.AIMTYPE = 4 and LearningDeliveryFAM.LEARNDELTYPE = ADL)

Do not derive a value and leave the field blank, if the conditions are not met.

Derivation Steps:

1. Use constant.
2. Derive from the HESA Instance page.
3. Use default.
4. Derive as *NULL ERROR*.

Franchise Partner (FRANPART)

Return: Student Record

Entity: Instance

Pages Used:

Page	Page Element
Program HESA Data	FRANPART
Plan HESA Data	FRANPART
Sub-Plan HESA	FRANPART
HESA Instance	FRANPART

Field Derivation Rule: Derive only if the **Include FE** check box is selected.

Derive a value if the following conditions are met:

- Country = Wales

- Instance.FESTUMK = 1, 3, or 4
- Instance.REDUCEDI = 00

Do not derive a value and leave the field blank, if the conditions are not met.

Derivation Steps:

1. Use constant.
2. Derive from the HESA Instance page.
3. If Instance.COURSEID is based on a subplan, derive from the Sub-Plan HESA page.
4. Derive from the Plan HESA Data page.
5. Derive from the Program HESA Data page.
6. Use default.
7. Derive as *NULL ERROR*.

Franchised Out Arrangements (FROUTARR)

Return: Student Record

Entity: Instance

Pages Used:

<i>Page</i>	<i>Page Element</i>
Program HESA Data	FROUTARR
Plan HESA Data	FROUTARR
Sub-Plan HESA	FROUTARR
HESA Instance	FROUTARR

Field Derivation Rule: Derive only if the **Include FE** check box is selected.

Derive a value if the following conditions are met:

- Country = England
- Instance.FESTUMK = 1, 3, or 4
- Instance.REDUCEDI = 00 or 01

Do not derive a value and leave the field blank, if the conditions are not met.

Derivation Steps:

1. Use constant.
2. Derive from the HESA Instance page.
3. If Instance.COURSEID is based on a subplan, derive from the Sub-Plan HESA page.
4. Derive from the Plan HESA Data page.
5. Derive from the Program HESA Data page.
6. Use default.
7. Derive as *NULL ERROR*.

FTE Method (FTEMETHOD)

Return: Student Record

Entity: Instance

Pages Used:

Page	Page Element
Program HESA Data	FTEMETHOD
Program Offering/Year HESA	FTEMETHOD (Program Offering HESA Data group box)
Plan HESA Data	FTEMETHOD
Plan Offering/Year HESA	FTEMETHOD (Plan Offering HESA Data group box)
Sub-Plan HESA	FTEMETHOD
Sub-Plan Offering/Year HESA	FTEMETHOD (Sub-Plan Offering HESA Data group box)
HESA Instance	FTEMETHOD

Field Derivation Rule: Derive a value if the following conditions are met:

- Country = Scotland
- Instance.REDUCEDI = 00, 01, or 03

Do not derive a value and leave the field blank, if the conditions are not met.

Derivation Steps:

1. Use constant.
2. Derive from the HESA Instance page.

3. If Instance.COURSEID is based on a subplan, derive from the Sub-Plan Offering/Year HESA page for the academic load of the student instance. Only records where Offering Start Term, Offering Start Session, and Campus are all blank are considered.
4. If Instance.COURSEID is based on a subplan, derive from the Sub-Plan HESA page.
5. Derive from the Plan Offering/Year HESA page for the academic load of the student instance. Only records where Offering Start Term, Offering Start Session, and Campus are all blank are considered.
6. Derive from the Plan HESA Data page.
7. Derive from the Program Offering/Year HESA page for the academic load of the student instance.
8. Derive from the Program HESA Data page.
9. Use default.
10. Derive as *NULL ERROR*.

Fundability Code (FUNDCODE)

Return: Student Record

Entity: Instance

Pages Used:

Page	Page Element
Program HESA Data	FUNDCODE
Plan HESA Data	FUNDCODE
Sub-Plan HESA	FUNDCODE
HESA Instance	FUNDCODE

Field Derivation Rule: Derive a value if one of the following conditions is met:

- Country is Northern Ireland, Scotland or Wales, and Instance.REDUCEDI = 00 or 01
- Country is England, and Instance.REDUCEDI = 00 or 01, and Instance.FESTUMK is not 1 or 4

Do not derive a value and leave the field blank, if the condition is not met.

Derivation Steps:

1. Use constant.
2. Derive from the HESA Instance page.
3. If Instance.COURSEID is based on a subplan, derive from the Sub-Plan HESA page.

4. Derive from the Plan HESA Data page.
5. Derive from the Program HESA Data page.
6. Use default.
7. Derive as *NULL ERROR*.

Completion of Year of Instance (FUNDCOMP)

Return: Student Record

Entity: Instance

Page Used:

Page	Page Element
HESA Instance	FUNDCOMP

Field Derivation Rule: Derive a value if the following conditions are met:

- Country = England, Wales, or Northern Ireland
- Instance.REDUCEDI = 00 or 01
- Instance.FESTUMK is not 5

Do not derive a value and leave the field blank, if the conditions are not met.

Derivation Steps:

1. Use constant.
2. Derive from the HESA Instance page.
3. Use default.
4. Derive as *NULL ERROR*.

Level Applicable to Funding Council HESES (FUNDLEV)

Return: Student Record

Entity: Instance

Pages Used:

Page	Page Element
Program HESA Data	FUNDLEV

Page	Page Element
Program Offering/Year HESA	FUNDLEV (Program Year HESA Data group box)
Plan HESA Data	FUNDLEV
Plan Offering/Year HESA	FUNDLEV (Plan Year HESA Data group box)
Sub-Plan HESA	FUNDLEV
Sub-Plan Offering/Year HESA	FUNDLEV (Sub-Plan Year HESA Data group box)
HESA Instance	FUNDLEV

Field Derivation Rule: Derive a value if the following conditions are met:

- Country = England or Northern Ireland
- Instance.REDUCEDI = 00 or 01
- Instance.FESTUMK is not 5

Do not derive a value and leave the field blank, if the conditions are not met.

Derivation Steps:

1. Use constant.
2. Derive from the HESA Instance page.
3. If Instance.COURSEID is based on a subplan, derive from the Sub-Plan Offering/Year HESA page for the combination of academic load and YEARPRG of the student instance. Only records where Offering Start Term, Offering Start Session, Campus, Year Term and Year Session are all blank are considered.
4. If Instance.COURSEID is based on a subplan, derive from the Sub-Plan HESA page.
5. Derive from the Plan Offering/Year HESA page for the combination of academic load and YEARPRG of the student instance. Only records where Offering Start Term, Offering Start Session, Campus, Year Term and Year Session are all blank are considered.
6. Derive from the Plan HESA Data page.
7. Derive from the Program Offering/Year HESA page for the combination of academic load and YEARPRG of the student instance.
8. Derive from the Program HESA Data page.
9. Use default.
10. Derive as *NULL ERROR*.

Funding Model (FUNDMODEL)

Return: Student Record

Entity: Instance

Pages Used:

Page	Page Element
Program HESA Data	FUNDMODEL
Plan HESA Data	FUNDMODEL
Sub-Plan HESA	FUNDMODEL
HESA Instance	FUNDMODEL

Field Derivation Rule: Derive only if the **Include FE** check box is selected.

Derive a value if the following conditions are met:

- Country = England
- Instance.REDUCEDI = 00 or 01
- Instance.FESTUMK = 1, 3, 4, or 5

Do not derive a value and leave the field blank, if the conditions are not met.

Derivation Steps:

1. Use constant.
2. Derive from the HESA Instance page.
3. If Instance.COURSEID is based on a subplan, derive from the Sub-Plan HESA page.
4. Derive from the Plan HESA Data page.
5. Derive from the Program HESA Data page.
6. Use default.
7. Derive as *NULL ERROR*.

Framework Code (FWORKCODE)

Return: Student Record

Entity: Instance

Page Used:

Page	Page Element
HESA Instance	FWORKCODE

Field Derivation Rule: Derive only if the Include FE check box is selected.

Derive a value if the following conditions are met:

- Country = England
- Instance.REDUCEDI = 00 or 01
- Instance.FESTUMK = 1, 3, 4, or 5
- Instance.PROGTYPE = 02, 03, 20, 21, 22 or 23

Do not derive a value and leave the field blank, if the conditions are not met.

Derivation Steps:

1. Use constant.
2. Derive from the HESA Instance page.
3. Use default.
4. Derive as *NULL ERROR*.

Guided Learning Hours (GLHRS)

Return: Student Record

Entity: Instance

Pages Used:

Page	Page Element
Program HESA Data	GLHRS
Program Offering/Year HESA	GLHRS (Program Offering HESA Data group box)
Plan HESA Data	GLHRS
Plan Offering/Year HESA	GLHRS (Plan Offering HESA Data group box)
Sub-Plan HESA	GLHRS
Sub-Plan Offering/Year HESA	GLHRS (Sub-Plan Offering HESA Data group box)

Page	Page Element
HESA Instance	GLHRS

Field Derivation Rule: Derive only if the **Include FE** check box is selected.

Derive a value if the following conditions are met:

- Country = England or Wales
- Instance.FESTUMK = 1, 3, or 4
- Instance.REDUCEDI = 00 or 01

Do not derive a value and leave the field blank, if the conditions are not met.

Derivation Steps:

1. Use constant.
2. Derive from the HESA Instance page.
3. If Instance.COURSEID is based on a subplan, derive from the Sub-Plan Offering/Year HESA page for the academic load of the student instance.
4. If Instance.COURSEID is based on a subplan, derive from the Sub-Plan HESA page.
5. Derive from the Plan Offering/Year HESA page for the academic load of the student instance.
6. Derive from the Plan HESA Data page.
7. Derive from the Program Offering/Year HESA page for the academic load of the student instance.
8. Derive from the Program HESA Data page.
9. Use default.
10. Derive as *NULL ERROR*.

Government Initiatives (GOVINIT)

Return: Student Record

Entity: Instance

Pages Used:

Page	Page Element
Program HESA Data	GOVINIT
Plan HESA Data	GOVINIT

Page	Page Element
Sub-Plan HESA	GOVINIT
HESA Instance	GOVINIT

Field Derivation Rule: Derive only if the **Include FE** check box is selected.

Derive a value if the following conditions are met:

- Country = England
- Instance.FESTUMK = 1, 3, or 4
- Instance.REDUCEDI = 00

Do not derive a value and leave the field blank, if the conditions are not met.

Derivation Steps:

1. Use constant.
2. Derive from the HESA Instance page.
3. If Instance.COURSEID is based on a subplan, derive from the Sub-Plan HESA page.
4. Derive from the Plan HESA Data page.
5. Derive from the Program HESA Data page.
6. Use default.
7. Derive as *NULL ERROR*.

Gross Fee (GROSSFEE)

Return: Student Record

Entity: Instance

Pages Used:

Page	Page Element
HESA Returns	Account Type Tuition
Fees After Calculation (Student Financials, Tuition and Fees, Review Fees After Calculation)	Amount

Page	Page Element
Program HESA Data	GROSSFEE
Program Offering/Year HESA	GROSSFEE (Program Offering HESA Data group box)
Plan HESA Data	GROSSFEE
Plan Offering/Year HESA	GROSSFEE (Plan Offering HESA Data group box)
Sub-Plan HESA	GROSSFEE
Sub-Plan Offering/Year HESA	GROSSFEE (Sub-Plan Offering HESA Data group box)
HESA Instance	GROSSFEE

Field Derivation Rule: Derive a value if these conditions are met:

- Country is Northern Ireland or Scotland
- Instance.FEEREGIME = 20

Or derive a value if one of these sets of conditions is met:

Set	Conditions to be Met
England Postgraduate	<ul style="list-style-type: none"> • Country = England • Instance.INITIATIVES, INITIATIVES, and INITIATIVES3 are <i>not</i> K • Instance.FEEELIG = 1 or 3 • Instance.EXCHANGE = N, Y, Z, or null • Either Instance.MODE = 01, 02, 23, 24, 25, 31, 73, or 74 <i>or</i> Instance.MODE = 43 or 44 and Instance.MCDATE is in the reporting period • Course.TTCID is <i>not</i> Q • Instance.REDUCEDI = 00 or 01 • Course.COURSEAIM begins with E or M excluding M16, M22, M26, M28, M71, M73, M86, or M88

Set	Conditions to be Met
England Undergraduate	<ul style="list-style-type: none"> • Country = England • Instance.INITIATIVES, INITIATIVES, and INITIATIVES3 are <i>not</i> K • Instance.FEEELIG = 1 or 3 • Instance.EXCHANGE = N, Y, Z, or null • Instance.MODE = 01, 02, 23, 24, 25, 31, 43, or 44 • Related Course.TTCID is not Q • Instance.REDUCEDI = 00 or 01 • Related Course.COURSEAIM begins with H, I, J, C or is M22, M26, M28, M71, or M73

Otherwise, derive as null.

Derivation Steps:

1. Derive from the HESA Instance page.
2. Derive as total of all the tuition fee charges for the student career for terms that start within the reporting period. Fee records where the Item Type Code is *Charge* and the Account Type is one of those defined with the Tuition check box selected on the HESA Returns page. The derived value is rounded to the nearest pound.
3. If Instance.COURSEID is based on a subplan, derive from the Sub-Plan Offering/Year HESA page for the academic load of the student instance. Only records where Offering Start Term, Offering Start Session, and Campus are all blank are considered.
4. If Instance.COURSEID is based on a subplan, derive from the Sub-Plan HESA page.
5. Derive from the Plan Offering/Year HESA page for the academic load of the student instance. Only records where Offering Start Term, Offering Start Session, and Campus are all blank are considered.
6. Derive from the Plan HESA Data page.
7. Derive from the Program Offering/Year HESA page for the academic load of the student instance.
8. Derive from the Program HESA Data page.
9. Use default.
10. Do not derive a value and leave the field blank.

Implied Rate of Council Partial Funding (IMPRATE)

Return: Student Record

Entity: Instance

Pages Used:

Page	Page Element
Program HESA Data	IMPRATE
Program Offering/Year HESA	IMPRATE (Program Offering HESA Data group box)
Plan HESA Data	IMPRATE
Plan Offering/Year HESA	IMPRATE (Plan Offering HESA Data group box)
Sub-Plan HESA	IMPRATE
Sub-Plan Offering/Year HESA	IMPRATE (Sub-Plan Offering HESA Data group box)
HESA Instance	IMPRATE

Field Derivation Rule: Derive only if the **Include FE** check box is selected.

Derive a value if the following conditions are met:

- Country = England
- Instance.FESTUMK = 1, 3, or 4
- Instance.REDUCEDI = 00
- Related Course.MSFUND = 86, 87, 88, AA, AB, AC, or AD

Do not derive a value and leave the field blank, if the conditions are not met.

Derivation Steps:

1. Use constant.
2. Derive from the HESA Instance page.
3. If Instance.COURSEID is based on a subplan, derive from the Sub-Plan Offering/Year HESA page for the academic load of the student instance.
4. If Instance.COURSEID is based on a subplan, derive from the Sub-Plan HESA page.
5. Derive from the Plan Offering/Year HESA page for the academic load of the student instance.
6. Derive from the Plan HESA Data page.
7. Derive from the Program Offering/Year HESA page for the academic load of the student instance.
8. Derive from the Program HESA Data page.
9. Use default.

10. Derive as *NULL ERROR*.

Institution's Own Campus Identifier (INSTCAMP)

Return: Student Record

Entity: Instance

Pages Used:

Page	Page Element
Student Program	Campus
Campus (Records and Enrollment, HESA Reporting, Codes and Mappings, Code Mappings, Campus)	HESA Campus

Field Derivation Rule: Include for all Instance entities.

Derivation Steps:

1. Use constant.
2. Use the mapping to derive the HESA Campus code for the Campus value entered in the Student Program page.
3. Use default.
4. If Country = Wales and Course.COURSEAIM = X41, X42, X43, X44, X45 or X46 then derive as *NULL ERROR*.
5. Do not derive a value and leave the field blank.

Initiatives (INITIATIVES, INITIATIVES2, INITIATIVES3)

Return: Student Record

Entity: Instance

Pages Used:

Page	Page Element
Program HESA Data	INITIATIVES, INITIATIVES2, INITIATIVES3
Plan HESA Data	INITIATIVES, INITIATIVES2, INITIATIVES3
Sub-Plan HESA	INITIATIVES, INITIATIVES2, INITIATIVES3

Page	Page Element
HESA Instance	INITIATIVES, INITIATIVES2, INITIATIVES3

Field Derivation Rule: Include for all entities

Do not derive a value and leave the field blank, if the condition is not met.

Derivation Steps:

1. Derive from the HESA Instance page.
2. If Instance.COURSEID is based on a subplan, derive from the Sub-Plan HESA page.
3. Derive from the Plan HESA Data page.
4. Derive from the Program HESA Data page.
5. Do not derive a value and leave the field blank.

Intended Level of MPhil/PhD Studies (INTENTLEV)

Return: Student Record

Entity: Instance

Pages Used:

Page	Page Element
Program HESA Data	INTENTLEV
Plan HESA Data	INTENTLEV
Sub-Plan HESA	INTENTLEV
HESA Instance	INTENTLEV

Field Derivation Rule: Derive a value if the following conditions are met:

- Country = England
- Related Course.COURSEAIM = L99
- Instance.REDUCEDI = 00, 01, 03 or 04

If the conditions are not met, do not derive a value and leave the field blank.

Derivation steps:

1. Use constant.

2. Derive from the HESA Instance page.
3. If Instance.COURSEID is based on a sub-plan, derive value from Sub-Plan HESA.
4. Derive value from Plan HESA Data.
5. Derive value from Program HESA Data.
6. Use default.
7. Derive as null.

Intercalation (INTERCALATE)

Return: Student Record

Entity: Instance

Pages Used:

Page	Page Element
Program HESA Data	INTERCALATE
Program Offering/Year HESA	INTERCALATE (Program Year HESA Data group box)
Plan HESA Data	INTERCALATE
Plan Offering/Year HESA	INTERCALATE (Plan Year HESA Data group box)
Sub-Plan HESA	INTERCALATE
Sub-Plan Offering/Year HESA	INTERCALATE (Sub-Plan Year HESA Data group box)
HESA Instance	INTERCALATE

Field Derivation Rule: If Instance.REDUCEDI = 00, 01 or 03 derive a value. Otherwise, do not derive a value and leave the field blank.

Derivation Steps:

1. Derive from the HESA Instance page.
2. If Instance.COURSEID is based on a subplan, derive from the Sub-Plan Offering/Year HESA page for the combination of academic load and YEARPRG of the student instance. Only records where Offering Start Term, Offering Start Session, Campus, Year Term and Year Session are all blank are considered.
3. If Instance.COURSEID is based on a subplan, derive from the Sub-Plan HESA page.

4. Derive from the Plan Offering/Year HESA page for the combination of academic load and YEARPRG of the student instance. Only records where Offering Start Term, Offering Start Session, Campus, Year Term and Year Session are all blank are considered.
5. Derive from the Plan HESA Data page.
6. Derive from the Program Offering/Year HESA page for the combination of academic load and YEARPRG of the student instance.
7. Derive from the Program HESA Data page.
8. Use default.
9. Do not derive a value and leave the field blank.

ITT Qualification Aim (ITTAIM)

Return: Student Record

Entity: Instance

Pages Used:

Page	Page Element
Program HESA Data	ITTAIM
Plan HESA Data	ITTAIM
Sub-Plan HESA	ITTAIM

Field Derivation Rule: Derive a value if all the conditions are met.

- Country = England
- Instance.REDUCEDI = 00, 01 or 04
- Related Course.TTCID = 1

Derivation Steps:

1. Use constant.
2. If a sub-plan is reported, derive value from Sub-Plan HESA page.
3. Derive value from Plan HESA Data page.
4. Derive value from Program HESA Data page.
5. Use default.
6. Derive as NULL ERROR.

ITT Phase/Scope (ITTPHSC)

Return: Student Record

Entity: Instance

Pages Used:

Page	Page Element
Program HESA Data	ITTPHSC
Plan HESA Data	ITTPHSC
Sub-Plan HESA	ITTPHSC
HESA Instance	ITTPHSC

Field Derivation Rule: Derive a value if the following conditions are met:

- Country = England or Wales
- Related Course.TTCID = 1 or 2
- Related Course.REDUCEDC = 00, 01, 04 or 07

Do not derive a value and leave the field blank, if the conditions are not met.

Derivation Steps:

1. Use constant.
2. Derive from the HESA Instance page.
3. If Instance.COURSEID is based on a subplan, derive from the Sub-Plan HESA page.
4. Derive from the Plan HESA Data page.
5. Derive from the Program HESA Data page.
6. Use default.
7. Derive as *NULL ERROR*.

ITT Schemes (ITTSCHMS)

Return: Student Record

Entity: Instance

Pages Used:

Page	Page Element
Program HESA Data	ITTSCHMS
Plan HESA Data	ITTSCHMS
Sub-Plan HESA	ITTSCHMS
HESA Instance	ITTSCHMS

Field Derivation Rule: Derive a value if the following conditions are met:

- Country = England
- Instance.REDUCEDI = 00, 01, or 04
- Related Course.TTCID = 1, 2, 8, or G

Do not derive a value and leave the field blank, if the conditions are not met.

Derivation Steps:

1. Use constant.
2. Derive from the HESA Instance page.
3. If Instance.COURSEID is based on a subplan, derive from the Sub-Plan HESA page.
4. Derive from the Plan HESA Data page.
5. Derive from the Program HESA Data page.
6. Use default.
7. Derive as *NULL ERROR*.

Learning Difficulty (LEARNDIF)

Return: Student Record

Entity: Instance

Page Used:

Page	Page Element
HESA Instance	LEARNDIF

Field Derivation Rule: Derive only if the **Include FE** check box is selected.

Derive a value if the following conditions are met:

- Country = England
- Instance.FESTUMK = 1, 3, or 4
- Instance.REDUCEDI = 00 or 01

Do not derive a value and leave the field blank, if the conditions are not met.

Derivation Steps:

1. Use constant.
2. Derive from the HESA Instance page.
3. Use default.
4. Derive as *NULL ERROR*.

Learning Planned End Date (LEARNPLANENDDATE)

Return: Student Record

Entity: Instance

Page Used:

<i>Page</i>	<i>Page Element</i>
HESA Instance	LEARNPLANENDDATE

Field Derivation Rule: Derive only if the **Include FE** check box is selected.

Derive a value if the following conditions are met:

- Country = England
- Instance.REDUCEDI = 00 or 01
- Instance.FESTUMK = 1, 3, 4 or 5

Do not derive a value and leave the field blank, if the conditions are not met.

Derivation Steps:

1. Use constant.
2. Derive from the HESA Instance page (in YYYY-MM-DD format).
3. End Date of the Expected Graduation Term defined for the Student Program, converted to YYYY-MM-DD format
4. Use default.
5. Derive as *NULL ERROR*.

FTE in Year A (LOADYRA)

Return: Student Record

Entity: Instance

Pages Used: None

Field Derivation Rule: Derive a value if the following conditions are met:

- Country = England or Northern Ireland
- Instance.INSTAPP = 1
- Instance.TYPEYR = 2, 3, 4, or 5
- Instance.REDUCEDI = 00 or 01
- Course.COURSEAIM does not begin D, L, P, Q, R, S or X

Do not derive a value and leave the field blank, if the conditions are not met.

Derivation Step:

Note: For this release, this field is derived as *NULL ERROR*.

FTE in Year B (LOADYRB)

Return: Student Record

Entity: Instance

Pages Used: None

Field Derivation Rule: Derive a value if the following conditions are met:

- Country = England or Northern Ireland
- Instance.INSTAPP = 1
- Instance.TYPEYR = 2, 3, 4, or 5
- Instance.REDUCEDI = 00 or 01
- Course.COURSEAIM does not begin D, L, P, Q, R, S or X

Do not derive a value and leave the field blank, if the conditions are not met.

Derivation Step:

Note: For this release, this field is derived as *NULL ERROR*.

Location of Study (LOCSDY)

Return: Student Record

Entity: Instance

Pages Used:

Page	Page Element
Program HESA Data	LOCSDY
Program Offering/Year HESA	LOCSDY (Program Year HESA Data group box)
Plan HESA Data	LOCSDY
Plan Offering/Year HESA	LOCSDY (Plan Year HESA Data group box)
Sub-Plan HESA	LOCSDY
Sub-Plan Offering/Year HESA	LOCSDY (Sub-Plan Year HESA Data group box)
HESA Instance	LOCSDY
HESA Instance	Year of Program

Field Derivation Rule: If Instance.REDUCEDI = 00, 01 or 09 derive a value. Otherwise, do not derive a value and leave the field blank.

Derivation Steps:

1. Use constant.
2. Derive from the HESA Instance page.
3. If Instance.COURSEID is based on a subplan, derive from the Sub-Plan Offering/Year HESA page for the combination of academic load and YEARPRG of the student instance. Only records where Offering Start Term, Offering Start Session, Campus, Year Term and Year Session are all blank are considered.
4. If Instance.COURSEID is based on a subplan, derive from the Sub-Plan HESA page.
5. Derive from the Plan Offering/Year HESA page for the combination of academic load and YEARPRG of the student instance. Only records where Offering Start Term, Offering Start Session, Campus, Year Term and Year Session are all blank are considered.
6. Derive from the Plan HESA Data page.
7. Derive from the Program Offering/Year HESA page for the combination of academic load and YEARPRG of the student instance.
8. Derive from the Program HESA Data page.
9. Use default.

10. Derive as *NULL ERROR*.

Math Grade for GCSE (MATHGRADE)

Return: Student Record

Entity: Instance

Pages Used:

Page	Page Element
Further Education (Records and Enrollment, Career and Program Information, HESA Instance Details, Further Education)	MATHGRADE

Field Derivation Rule: Derive a value if all the following conditions are met.

- Country = England
- Instance.FESTUMK = 1, 3, or 4
- Instance.REDUCEDI = 00 or 01
- Instance.FUNDMODEL = 25 or 82

Derivation Steps:

1. Derive value from the Further Education page.
2. Derive as *NONE*.

Change of Mode Date (MCDATE)

Return: Student Record

Entity: Instance

Pages Used:

Page	Page Element
Student Program	Program Action Action Reason
HESA Instance	MCDATE
HESA Action Reasons	HESA Mode Direction (Change of Mode Mapping group box)

Field Derivation Rule: Derive a value if the following conditions are met:

- Country = England or Northern Ireland
- Instance.REDUCEDI = 00 or 04
- Related Course.COURSEAIM begins with D, E, L, or M (excluding M22, M26 or M28)

Do not derive a value and leave the field blank, if the conditions are not met.

Derivation Steps:

1. If MODE derivation step = 1 (that is derived from HESA Instance page), then derive MCDATE from HESA Instance page.
2. If MODE derivation step = 2 and the most recent record was selected to derive MODE, select any other earlier change of mode from the Student Program records where effective end date is within the reporting period.

For each record, determine from the Mode Direction mapping whether the MODE changed from Active to Inactive or vice versa.

If any one of the following three conditions is met, derive MCDATE as the effective date of the record that was used to derive MODE, formatted to YYYY-MM-DD:

- The earliest Mode Direction From = *Active* and the latest Mode Direction To = *Inactive*.
- The earliest Mode Direction From = *Inactive* and the latest Mode Direction To = *Active*.
- The earliest Mode Direction From = *Inactive*, the latest Mode Direction To = *Inactive*, and a minimum of one of the selected records for the reporting period has a Mode Direction To = *Active* (that is, student was active at some point).

3. Derive as null.

Mode of Study (MODE)

Return: Student Record

Entity: Instance

Pages Used:

Page	Page Element
Program Offering/Year HESA	MODE (Program Year HESA Data group box)
Program Offering/Year HESA	MODE (Program Offering HESA Data group box)
Program HESA Data	MODE (Program HESA Data group box)
Plan Offering/Year HESA	MODE (Plan Year HESA Data group box)

Page	Page Element
Plan Offering/Year HESA	MODE (Plan Offering HESA Data group box)
Plan HESA Data	MODE (Plan HESA Data group box)
Sub-Plan Offering/Year HESA	MODE (Sub-Plan Year HESA Data group box)
Sub-Plan Offering/Year HESA	MODE (Sub-Plan Offering HESA Data group box)
Sub-Plan	MODE (Sub-Plan HESA Data group box)
Student Program	Program Action Action Reason
Student Program	Acad Load
HESA Instance	MODE
HESA Instance	Year of Program
Mode of Study (Records and Enrollment > HESA Reporting > Codes and Mappings > Code Mappings > Mode of Study)	HESA Mode of Study
HESA Action Reasons	Change of Mode Mapping
Term/Session Table (Set up SACR, Foundation Table, Term Setup, Term/Session Table)	Term
Enrollment Limit (Records and Enrollment, Student Term Information, Term Activate a Student, Enrollment Limit)	Approved Academic Load

Field Derivation Rule: Include for all Instance entities.

Derivation Steps:

1. Derive from the HESA Instance page.
2. Select the Student Program record that has Program Action/Reason values mapped to a HESA Mode in the HESA Action Reasons page. Derive the mapped HESA mode value. If the derived value is 73 or 74 and the effective date of the record is prior to the reporting period start date, convert 73 to 63 and 74 to 64.
3. If Instance.COURSEID is based on a subplan and the MODE value from the Sub-Plan Offering/Year HESA page for the combination of Academic Load and YEARPRG of the student instance is defined,

then derive the Sub-Plan Offering/Year HESA MODE value. Only records where Offering Start Term, Offering Start Session, Campus, Year Term and Year Session are all blank are considered.

4. If Instance.COURSEID is based on a subplan and MODE is defined in Sub-Plan Offering HESA Data for the academic load of the student instance, then derive the Sub-Plan Offering HESA Data MODE value. Only records where Offering Start Term, Offering Start Session, and Campus are all blank are considered.
5. If Instance.COURSEID is based on a subplan and MODE is defined in Sub-Plan HESA page, then derive the Sub-Plan HESA MODE value.
6. If the MODE value from the Plan Offering/Year HESA page for the combination of Academic Load and YEARPRG of the student instance is defined, then derive the Plan Offering/Year HESA MODE value. Only records where Offering Start Term, Offering Start Session, Campus, Year Term and Year Session are all blank are considered.
7. If the MODE value is defined in Plan Offering HESA Data for the academic load of the student instance, then derive Plan Offering HESA Data MODE value. Only records where Offering Start Term, Offering Start Session, and Campus are all blank are considered.
8. If MODE is defined in Plan HESA Data page, then derive that value.
9. If the MODE value from the Program Offering/Year HESA page for the combination of Academic Load and YEARPRG of the student instance is defined, then derive the Program Offering/Year HESA MODE value.
10. If the MODE value is defined in Program Offering HESA Data for the academic load of the student instance, then derive the Program Offering HESA Data MODE value.
11. If MODE is defined in Program HESA Data, then derive that value.
12. Map the Approved Academic Load from the most recent activated student term record that overlaps the reporting period to a HESA code value using the HESA Mode mapping. A term is considered to overlap if the begin date or end date falls within the reporting period.
13. Map the Academic Load for the most recent effective-dated record in the Student Program/Plan stack that has an Effective Date on or before the reporting period end date to a HESA code using the HESA Mode mapping.
14. Derive as *NULL ERROR*.

Major Source of Tuition Fees (MSTUFEE)

Return: Student Record

Entity: Instance

Pages Used:

Page	Page Element
Program HESA Data	MSTUFEE

Page	Page Element
Program Offering/Year HESA	MSTUFEE (Program Offering HESA Data group box)
Plan HESA Data	MSTUFEE
Plan Offering/Year HESA	MSTUFEE (Plan Offering HESA Data group box)
Sub-Plan HESA	MSTUFEE
Sub-Plan Offering/Year HESA	MSTUFEE (Sub-Plan Offering HESA Data group box)
HESA Instance	MSTUFEE

Field Derivation Rule: Derive a value if all the conditions are met:

- Instance.REDUCEDI = 00 or 01
- Instance.MODE is not 63 or 64
- Instance.EXCHANGE is not 4 or G

Derivation Steps:

1. Use constant.
2. Derive from the HESA Instance page.
3. If Instance.COURSEID is based on a subplan, derive from the Sub-Plan Offering/Year HESA page for the academic load of the student instance. Only records where Offering Start Term, Offering Start Session, and Campus are all blank are considered.
4. If Instance.COURSEID is based on a subplan, derive from the Sub-Plan HESA page.
5. Derive from the Plan Offering/Year HESA page for the academic load of the student instance. Only records where Offering Start Term, Offering Start Session, and Campus are all blank are considered.
6. Derive from the Plan HESA Data page.
7. Derive from the Program Offering/Year HESA page for the academic load of the student instance.
8. Derive from the Program HESA Data page.
9. Use default.
10. Derive as *NULL ERROR*.

Net Fee (NETFEE)

Return: Student Record

Entity: Instance

Pages Used:

Page	Page Element
HESA Returns	Account Type Waiver
Fees After Calculation (Student Financials, Tuition and Fees, Review Fees After Calculation)	Amount
Program HESA Data	NETFEE
Program Offering/Year HESA	NETFEE (Program Offering HESA Data group box)
Plan HESA Data	NETFEE
Plan Offering/Year HESA	NETFEE (Plan Offering HESA Data group box)
Sub-Plan HESA	NETFEE
Sub-Plan Offering/Year HESA	NETFEE (Sub-Plan Offering HESA Data group box)
HESA Instance	NETFEE

Field Derivation Rule: Derive a value if these conditions are met:

- Country is Northern Ireland or Scotland
- Instance.FEEREGIME = 20

Or derive a value if one of these sets of conditions is met:

Set	Conditions to be Met
England Postgraduate	<ul style="list-style-type: none"> • Country = England • Instance.INITIATIVES, INITIATIVES, and INITIATIVES3 are <i>not</i> K • Instance.FEEELIG = 1 or 3 • Instance.EXCHANGE = N, Y, Z, or null • Either Instance.MODE = 01, 02, 23, 24, 25, 31, 73, or 74 <i>or</i> Instance.MODE = 43 or 44 and Instance.MCDATE is in the reporting period • Course.TTCID is <i>not</i> Q • Instance.REDUCEDI = 00 or 01 • Course.COURSEAIM begins with E or M excluding M16, M22, M26, M28, M71, M73, M86, or M88
England Undergraduate	<ul style="list-style-type: none"> • Country = England • Instance.INITIATIVES, INITIATIVES, and INITIATIVES3 are <i>not</i> K • Instance.FEEELIG = 1 or 3 • Instance.EXCHANGE = N, Y, Z, or null • Instance.MODE = 01, 02, 23, 24, 25, 31, 43, or 44 • Related Course.TTCID is not Q • Instance.REDUCEDI = 00 or 01 • Related Course.COURSEAIM begins with H, I, J, C or is M22, M26, M28, M71, or M73

Otherwise, derive as null.

Derivation Steps:

1. Derive from the HESA Instance page.
2. If Instance.GROSSFEE is derived from Step 2, NETFEE is derived as the rounded GROSSFEE minus the total of all waivers for the Student Career for terms that start within the reporting period. Fee records where the Item Type Code is *Waiver* and the Account Type is one of those defined with the Waiver check box selected in HESA Returns page. The derived value is then rounded to the nearest pound.
3. If Instance.COURSEID is based on a subplan, derive from the Sub-Plan Offering/Year HESA page for the academic load of the student instance. Only records where Offering Start Term, Offering Start Session, and Campus are all blank are considered.
4. If Instance.COURSEID is based on a subplan, derive from the Sub-Plan HESA page.
5. Derive from the Plan Offering/Year HESA page for the academic load of the student instance. Only records where Offering Start Term, Offering Start Session, and Campus are all blank are considered.

6. Derive from the Plan HESA Data page.
7. Derive from the Program Offering/Year HESA page for the academic load of the student instance.
8. Derive from the Program HESA Data page.
9. Use default.
10. Derive as null.

NHS Employer (NHSEMP)

Return: Student Record

Entity: Instance

Pages Used:

<i>Page</i>	<i>Page Element</i>
Program HESA Data	NHSEMP
Plan HESA Data	NHSEMP
Sub-Plan HESA	NHSEMP
HESA Instance	NHSEMP

Field Derivation Rule: Derive a value if the following conditions are met:

- Country = England
- Instance.REDUCEDI = 00 or 01
- Related Course.COURSEAIM = M76, H76, I76, or J76

Do not derive a value and leave the field blank, if the conditions are not met.

Derivation Steps:

1. Use constant.
2. Derive from the HESA Instance page.
3. If Instance.COURSEID is based on a subplan, derive from the Sub-Plan HESA page.
4. Derive from the Plan HESA Data page.
5. Derive from the Program HESA Data page.
6. Use default.

7. Derive as *NULL ERROR*.

Reason for Partial and Full Non-payment of Tuition (NONPAY)

Return: Student Record

Entity: Instance

Page Used:

Page	Page Element
HESA Instance	NONPAY

Field Derivation Rule: Derive only if the **Include FE** check box is selected.

Derive a value if the following conditions are met:

- Country = England
- Instance.FESTUMK = 1, 3, or 4
- Instance.REDUCEDI = 00
- Course.MSFUND does not equal 91

Do not derive a value and leave the field blank, if the conditions are not met.

Derivation Steps:

1. Use constant.
2. Derive from the HESA Instance page.
3. Use default.
4. Derive as *NULL ERROR*.

Suspension of Active Studies (NOTACT)

Return: Student Record

Entity: Instance

Pages Used:

Page	Page Element
Student Program	Program Action Action Reason

Page	Page Element
HESA Instance	NOTACT
HESA Action Reasons	Suspension of Active Studies Mapping

Field Derivation Rule: If Instance.RSNEND and Instance.ENDDATE values do not exist, derive a value. Otherwise, do not derive a value and leave the field blank.

Derivation Steps:

1. Derive from the HESA Instance page.
2. If the most recent effective dated Student Program record has Program Action/Reason values mapped to the a HESA Suspension of Studies code on the HESA Action Reasons page, then derive the mapped HESA code value.
3. If Instance.MODE = 73 or 74, derive as *1*.
4. Do not derive a value and leave the field blank.

Note: For correct derivation, ensure that if you have mapped a Program Action/Reason to a MODE of 73 or 74, map the same Program Action/Reason to a NOTACT value of *1* on the HESA Action Reasons page.

Number of Units to Achieve Full Qualification (NOUNTACH)

Return: Student Record

Entity: Instance

Pages Used:

Page	Page Element
Program HESA Data	NOUNTACH
Plan HESA Data	NOUNTACH
Sub-Plan HESA	NOUNTACH
HESA Instance	NOUNTACH

Field Derivation Rule: Derive only if the **Include FE** check box is selected.

Derive a value if the following conditions are met:

- Country = Wales

- Instance.FESTUMK = 1, 3, or 4
- Instance.REDUCEDI = 00

Do not derive a value and leave the field blank, if the conditions are not met.

Derivation Steps:

1. Use constant.
2. Derive from the HESA Instance page.
3. If Instance.COURSEID is based on a subplan, derive from the Sub-Plan HESA page.
4. Derive from the Plan HESA Data page.
5. Derive from the Program HESA Data page.
6. Use default.
7. Derive as *NULL ERROR*.

Student Instance Identifier (NUMHUS)

Return: Student Record

Entity: Instance

Page Used:

<i>Page</i>	<i>Page Element</i>
HESA Instance	Instance Identifier Linked Career Linked Career Number Academic Career Student Career Nbr

Field Derivation Rule: Include for all Instance entities.

Derivation Steps:

1. Derive from HESA Instance page as Instance Identifier.
2. Derive from HESA Instance page as Linked Career and Linked Career Number.
3. Derive from HESA Instance page as Academic Career and Student Career Nbr, for example, UGRD1.

Previous Student Instance Identifier (NUMHUSPREV)

Return: Student Record

Entity: Instance

Page Used:

Page	Page Element
HESA Instance	NUMHUSPREV

Field Derivation Rule: Derive a value if related Course.COURSEAIM = D00, D01, L00, or L80.

Derivation Steps:

1. Derive from the HESA Instance page.
2. Derive as *NULL*.

Number of Units Completed (NUMUNITS)

Return: Student Record

Entity: Instance

Page Used:

Page	Page Element
HESA Instance	NUMUNITS

Field Derivation Rule: Derive only if the **Include FE** check box is selected.

Derive a value if the following conditions are met:

- Country = Wales
- Instance.FESTUMK = 1, 3, or 4
- Instance.REDUCEDI = 00

Do not derive a value and leave the field blank, if the conditions are not met.

Derivation Steps:

1. Derive from the HESA Instance page.
2. Use default.
3. Derive as *NULL ERROR*.

Institution's Own Instance Identifier (OWNINST)

Return: Student Record

Entity: Instance

Page Used:

Page	Page Element
HESA Instance	OWNINST

Field Derivation Rule: Include for all Instance entities.

Derivation Steps:

1. Derive from the HESA Instance page.
2. Use default.
3. Do not derive a value and leave the field blank.

Subcontracted or Partnership UKPRN (PARTNERUKPRN)

Return: Student Record

Entity: Instance

Page Used:

Page	Page Element
HESA Instance	PARTNERUKPRN

Field Derivation Rule: Derive a value if the following conditions are met:

- Country = England
- Instance.FESTUMK = 1, 3, or 4
- Instance.REDUCEDI = 00 or 01 and Instance.AIMTYPE is not 1

Do not derive a value and leave the field blank, if the conditions are not met.

Derivation Steps:

1. Derive from the HESA Instance page.
2. Use default.
3. Derive as *NULL ERROR*.

PhD Submission Date (PHDSUB)

Return: Student Record

Entity: Instance

Pages Used:

Page	Page Element
Student Program	Program Action Action Reason
HESA Instance	PHDSUB
HESA Action Reasons	Phd Submission Action Reason Mapping

Field Derivation Rule: Derive a value if the following conditions are met:

- Instance.REDUCEDI = 00, 01, or 04
- Related Course.COURSEAIM = D00 or D01

Do not derive a value and leave the field blank, if the conditions are not met.

Derivation Steps:

1. Derive from the HESA Instance page.
2. If there is a Research Candidate record for the instance, select the earliest effective dated thesis record where Actual Submission Date has a value and the effective date is on or before the reporting period end date. Derive as the Actual Submission Date formatted to YYYY-MM-DD.

Note: The process matches the Research Candidate record (SSR_RS_CAND_HDR) to the instance on EMPLID, Institution, Career and Career Number to find the Research Candidate Number (SSR_RS_CANDIT_NBR). The process associates the thesis records (SSR_RS_THESIS) with the Research Candidate record by EMPLID, Institution and Research Candidate Number. It selects the earliest Research Candidate record (by EFFDT, EFFSEQ) that has an Actual Submission Date (SSR_RS_ACT_SUB_DT).

3. Select the earliest Student Program record (exclude records with an effective date greater than the end date of the reporting period) that has Program Action/Reason values mapped in the Phd Submission Action Reason Mapping group box. Derive as the effective date of the record formatted to YYYY-MM-DD.
4. Derive as null.

Planned Employability, Enrichment and Pastoral Hours (PLANEEPHOURS)

Return: Student Record

Entity: Instance

Page Used:

Page	Page Element
HESA Instance	PLANEAPHOURS

Field Derivation Rule: Derive a value if the following conditions are met:

- Country = England
- Instance.FESTUMK = 1, 3, 4, or 5
- Instance.REDUCEDI = 00 or 01
- Instance.FUNDMODEL = 10, 25, 35, 81, 82 or 99 and Instance.PROGTYPE is not 20, 21, 22, 23 or 25

Do not derive a value and leave the field blank, if the conditions are not met.

Derivation Steps:

1. Derive from the HESA Instance page.
2. Use default.
3. Derive as *NULL ERROR*.

Planned Learning Hours (PLANLEARNHOURS)

Return: Student Record

Entity: Instance

Page Used:

Page	Page Element
HESA Instance	PLANLEARNHOURS

Field Derivation Rule: Derive a value if the following conditions are met:

- Country = England AND Instance.FESTUMK = 1, 3, 4, or 5 AND Instance.REDUCEDI = 00 or 01
- Instance.FUNDMODEL = 10, 25, 35, 81, 82 or 99 AND Instance.PROGTYPE is not 20, 21, 22, 23 or 25

Do not derive a value and leave the field blank, if the conditions are not met.

Derivation Steps:

1. Derive from the HESA Instance page.
2. Use default.

3. Derive as *NULL ERROR*.

Good Standing Marker (PROGRESS)

Return: Student Record

Entity: Instance

Page Used:

Page	Page Element
HESA Instance	PROGRESS

Field Derivation Rule: Derive only if the **Include FE** check box is selected.

Derive a value if the following conditions are met:

- Country = Wales
- Instance.FESTUMK = 1, 3, or 4
- Instance.REDUCEDI = 00

Do not derive a value and leave the field blank, if the conditions are not met.

Derivation Steps:

1. Use constant.
2. Derive from the HESA Instance page.
3. Use default.
4. Derive as *NULL ERROR*.

Programme Type (PROGTYPE)

Return: Student Record

Entity: Instance

Pages Used:

Page	Page Element
Program HESA Data	PROGTYPE
Plan HESA Data	PROGTYPE

Page	Page Element
Sub-Plan HESA	PROGTYPE
HESA Instance	PROGTYPE

Field Derivation Rule: Derive only if the **Include FE** check box is selected.

Derive a value if the following conditions are met:

- Country = England
- Instance.FESTUMK = 1, 3, 4, or 5
- Instance.REDUCEDI = 00 or 01

Do not derive a value and leave the field blank, if the conditions are not met.

Derivation Steps:

1. Use constant.
2. Derive from the HESA Instance page.
3. If Instance.COURSEID is based on a subplan, derive from the Sub-Plan HESA page.
4. Derive from the Plan HESA Data page.
5. Derive from the Program HESA Data page.
6. Use default.
7. If Instance.AIMTYPE = 1 or 3, derive as *NULL ERROR*.
8. Do not derive a value and leave the field blank.

Proportion of Funding Remaining (PROPFUNDREMAIN)

Return: Student Record

Entity: Instance

Pages Used:

Page	Page Element
Program HESA Data	PROPFUNDREMAIN
Plan HESA Data	PROPFUNDREMAIN
Sub-Plan HESA	PROPFUNDREMAIN

Page	Page Element
HESA Instance	PROPFUNDREMAIN

Field Derivation Rule: Derive only if the **Include FE** check box is selected.

Derive a value if the following conditions are met:

- Country = England
- Instance.FESTUMK = 1 or 3
- Instance.REDUCEDI = 00 or 01
- Instance.AIMTYPE = 2, 3 or 4
- Instance.FUNDMODEL = 21, 22 or 45

Do not derive a value and leave the field blank, if the conditions are not met.

Derivation Steps:

1. Use constant.
2. Derive from the HESA Instance page.
3. If Instance.COURSEID is based on a subplan, derive from the Sub-Plan HESA page.
4. Derive from the Plan HESA Data page.
5. Derive from the Program HESA Data page.
6. Use default.
7. Derive as *NULL ERROR*.

Apprenticeship Pathway (PWAYCODE)

Return: Student Record

Entity: Instance

Pages Used:

Page	Page Element
Program HESA Data	PWAYCODE
Plan HESA Data	PWAYCODE
Sub-Plan HESA	PWAYCODE

Page	Page Element
HESA Instance	PWAYCODE

Field Derivation Rule: Derive only if the **Include FE** check box is selected.

Derive a value if the following conditions are met:

- Country = England
- Instance.FESTUMK = 1, 3, 4, or 5
- Instance.REDUCEDI = 00 or 01
- Instance.PROGTYPE = 02, 03, 20, 21, 22 or 23

Do not derive a value and leave the field blank, if the conditions are not met.

Derivation Steps:

1. Use constant.
2. Derive from the HESA Instance page.
3. If Instance.COURSEID is based on a subplan, derive from the Sub-Plan HESA page.
4. Derive from the Plan HESA Data page.
5. Derive from the Program HESA Data page.
6. Use default.
7. Derive as *NULL ERROR*.

Qualified Teacher Status (QTS)

Return: Student Record

Entity: Instance

Pages Used:

Page	Page Element
Program HESA Data	QTS
Plan HESA Data	QTS
Sub-Plan HESA	QTS
HESA Instance	QTS

Field Derivation Rule: Derive a value if the following conditions are met:

- Country = England or Northern Ireland
- Instance.REDUCEDI = 00, 01, or 04
- Related Course.TTCID = 5

Do not derive a value and leave the field blank, if the conditions are not met.

Derivation Steps:

1. Use constant.
2. Derive from the HESA Instance page.
3. If Instance.COURSEID is based on a subplan, derive from the Sub-Plan HESA page.
4. Derive from the Plan HESA Data page.
5. Derive from the Program HESA Data page.
6. Use default.
7. Derive as *NULL ERROR*.

Research Council Student Identifier (RCSTDID)

Return: Student Record

Entity: Instance

Page Used:

Page	Page Element
External System ID	External System ID

Field Derivation Rule: Derive a value if the following conditions are met:

- Instance.REDUCEDI = 00, 01, or 04
- Instance.RCSTDNT is not 99

Do not derive a value and leave the field blank, if the conditions are not met.

Derivation Steps:

1. If there is a Research Candidate record for the instance, select the value of the CAF attribute defined for RCSTDID in Returns Setup from the most recent active consumption record where the effective date is on or before the reporting period end date.
2. Select External System ID records for the person with the External ID Type defined for RCSTDID in the HESA Types page.

- Do not derive a value and leave the field blank.

Research Council Student (RCSTDNT)

Return: Student Record

Entity: Instance

Pages Used:

Page	Page Element
Program HESA Data	RCSTDNT
Plan HESA Data	RCSTDNT
Sub-Plan HESA	RCSTDNT
HESA Instance	RCSTDNT

Field Derivation Rule: Derive a value if the following conditions are met:

- Instance.REDUCEDI = 00, 01, or 04
- Related Course.COURSEAIM begins D, E, L, or M (except M22, M26, M28, M71, or M73)

Do not derive a value and leave the field blank, if the conditions are not met.

Derivation Steps:

- Use constant.
- Derive from the HESA Instance page.
- If there is a Research Candidate record for the instance, select the value of the CAF attribute defined for RCSTDNT in Returns Setup from the most recent active consumption record where the effective date is on or before the reporting period end date.
- If Instance.COURSEID is based on a subplan, derive from the Sub-Plan HESA page.
- Derive from the Plan HESA Data page.
- Derive from the Program HESA Data page.
- Use default.
- Derive as *NULL ERROR*.

Amount of Tuition Fees Received/Expected for the Student (RECFEE)

Return: Student Record

Entity: Instance

Page Used:

Page	Page Element
HESA Instance	RECFEE

Field Derivation Rule: Derive a value only if the **Include FE** check box is selected.

Derive a value if the following conditions are met:

- Country = England
- Instance.FESTUMK = 1, 3, or 4
- Instance.REDUCEDI = 00 or 01

Do not derive a value and leave the field blank, if the conditions are not met.

Derivation Steps:

1. Use constant.
2. Derive from the HESA Instance page.
3. Use default.
4. Derive as *NULL ERROR*.

Reduced Instance Return Indicator (REDUCEDI)

Return: Student Record

Entity: Instance

Page Used:

Page	Page Element
HESA Instance	REDUCEDI

Field Derivation Rule: Include for all Instance entities.

Derivation Steps:

1. Use constant.
2. Derive from the HESA Instance page.
3. If Country = England, Scotland, or Northern Ireland and Instance.STULOAD is *10.0* or less, derive as *01*.

4. If Instance.EXCHANGE is 2, 4, 8, 9, A or G, derive as 03.
5. If Instance.MODE = 63 or 64, derive as 04.
6. Derive as 00.

Reason for Engagement Ending (RSNENGEND)

Return: Student Record

Entity: Instance

Pages Used:

Page	Page Element
Student Program	Program Action Registration Reason
HESA Instance Data	RSNENGEND

Field Derivation Rule: Derive a value if the following conditions are met:

- Instance.REDUCEDI = 00, 01, 04, 07, 08 or 09
- Instance.ENDDATE is completed.

Do not derive a value and leave the field blank, if the conditions are not met.

Derivation Steps:

1. Derive value from the HESA Instance page.
2. If the most recent effective dated Student Program record has Program Action/Reason values mapped to a HESA Reason for Ending Instance code on the HESA Action Reasons page, then derive the mapped HESA code value.
3. Derive as *NULL ERROR*.

Number of Student Associates Scheme Days Completed (SASDAYS)

Return: Student Record

Entity: Instance

Page Used:

Page	Page Element
HESA Instance	SASDAYS

Field Derivation Rule: Derive a value if the following conditions are met:

- Country = England
- Course.REDUCEDC = 06 (SAS) or Course.TTCID = E (SAS)

Do not derive a value and leave the field blank, if the conditions are not met.

Derivation Steps:

1. Use constant.
2. Derive from the HESA Instance page.
3. Use default.
4. Derive as *NULL ERROR*.

Student Associates Scheme Placement (SASSCHL)

Return: Student Record

Entity: Instance

Page Used:

Page	Page Element
HESA Instance	SASSCHL

Field Derivation Rule: Derive a value if the following conditions are met:

- Country = England
- Course.REDUCEDC = 06 (SAS) or Course.TTCID = E (SAS)

Do not derive a value and leave the field blank, if the conditions are not met.

Derivation Steps:

1. Use constant.
2. Derive from the HESA Instance page.
3. Use default.
4. Derive as *NULL ERROR*.

School Direct Employing School (SDEMPLOY)

Return: Student Record

Entity: Instance

Page Used:

Page	Page Element
Program HESA Data	SDEMPLOY
Plan HESA Data	SDEMPLOY
Sub-Plan HESA	SDEMPLOY
HESA Instance	SDEMPLOY

Field Derivation Rule: Derive a value if the following conditions are met:

- Instance.ENTRYRTE = 03 or 10
- Instance.MODE is not 63 or 64

Derivation Steps:

1. Use constant.
2. Derive from HESA Instance page.
3. If Instance.COURSEID is based on a sub-plan, derive value from the Sub-Plan HESA page.
4. Derive value from Plan HESA Data page.
5. Derive value from Program HESA Data page.
6. Use default.
7. Derive as NULL ERROR.

School Direct Lead School (SDLEAD)

Return: Student Record

Entity: Instance

Page Used:

Page	Page Element
Program HESA Data	SDLEAD
Plan HESA Data	SDLEAD
Sub-Plan HESA	SDLEAD

<i>Page</i>	<i>Page Element</i>
HESA Instance	SDLEAD

Field Derivation Rule: Derive a value if the following conditions are met:

- Instance.ENTRYRTE = 02, 03, or 10
- Instance.MODE is not 63 or 64

Derivation Steps:

1. Use constant.
2. Derive from HESA Instance page.
3. If Instance.COURSEID is based on a sub-plan, derive value from the Sub-Plan HESA page.
4. Derive value from Plan HESA Data page.
5. Derive value from Program HESA Data page.
6. Use default.
7. Derive as NULL ERROR.

Subject Knowledge Enhancement Institution (SKEITT)

Return: Student Record

Entity: Instance

Page Used:

<i>Page</i>	<i>Page Element</i>
HESA Instance	SKEITT

Field Derivation Rule: Derive a value if the following conditions are met:

- Country = England
- Course.REDUCEDC = 07 (SKE) or Course.TTCID = F (SKE)

Do not derive a value and leave the field blank, if the conditions are not met.

Derivation Steps:

1. Use constant.
2. Derive from the HESA Instance page.
3. Use default.

4. Derive as *NULL ERROR*.

Special Fee Indicator (SPECFEE)

Return: Student Record

Entity: Instance

Pages Used:

Page	Page Element
Program Offering/Year HESA	SPECFEE (Program Year HESA Data group box)
Plan Offering/Year HESA	SPECFEE (Plan Year HESA Data group box)
Sub-Plan Offering/Year HESA	SPECFEE (Sub-Plan Year HESA Data group box)
HESA Instance	SPECFEE

Field Derivation Rule: Derive a value if Instance.REDUCEDI = 00.

Derivation Steps:

1. Use constant.
2. Derive from the HESA Instance page.
3. If Instance.COURSEID is based on a subplan, derive from the Sub-Plan Offering/Year HESA page for the combination of academic load and YEARPRG of the student instance. Only records where Offering Start Term, Offering Start Session, Campus, Year Term and Year Session are all blank are considered.
4. Derive from the Plan Offering/Year HESA page for the combination of academic load and YEARPRG of the student instance. Only records where Offering Start Term, Offering Start Session, Campus, Year Term and Year Session are all blank are considered.
5. Derive from the Program Offering/Year HESA page for the combination of academic load and YEARPRG of the student instance.
6. Use default.
7. Derive as *NULL ERROR*.

Expected Length of Study (SPLENGTH)

Return: Student Record

Entity: Instance

Pages Used:

Page	Page Element
Program HESA Data	SLENGTH
Program Offering/Year HESA	SLENGTH (Program Offering HESA Data group box)
Plan HESA Data	SLENGTH
Plan Offering/Year HESA	SLENGTH (Plan Offering HESA Data group box)
Sub-Plan HESA	SLENGTH
Sub-Plan Offering/Year HESA	SLENGTH (Sub-Plan Offering HESA Data group box)
HESA Instance	SLENGTH

Field Derivation Rule: Derive a value if the following conditions are met.

- Instance.REDUCEDI = 00 or 01
- Instance.FESTUMK is not 5

Derivation Steps:

1. Use constant.
2. Derive from the HESA Instance page.
3. If Instance.COURSEID is based on a subplan, derive from the Sub-Plan Offering/Year HESA page for the academic load of the student instance. Only records where Offering Start Term, Offering Start Session, and Campus are all blank are considered.
4. If Instance.COURSEID is based on a subplan, derive from the Sub-Plan HESA page.
5. Derive from the Plan Offering/Year HESA page for the academic load of the student instance. Only records where Offering Start Term, Offering Start Session, and Campus are all blank are considered.
6. Derive from the Plan HESA Data page.
7. Derive from the Program Offering/Year HESA page for the academic load of the student instance.
8. Derive from the Program HESA Data page.
9. Use default.
10. Derive as null.

SLDD-Discrete Provision (ST13)

Return: Student Record

Entity: Instance

Page Used:

Page	Page Element
HESA Instance	ST13

Field Derivation Rule: Derive a value only if the **Include FE** check box is selected.

Derive a value if the following conditions are met:

- Country = Wales
- Instance.FESTUMK = 1 or 3
- Instance.REDUCEDI = 00

Do not derive a value and leave the field blank, if the conditions are not met.

Derivation Steps:

1. Use constant.
2. Derive from the HESA Instance page.
3. Use default.
4. Derive as *NULL ERROR*.

Student Instance FTE (STULOAD)

Return: Student Record

Entity: Instance

Page Used:

Page	Page Element
HESA Instance	Calculated FTE Report Zero Override FTE

Field Derivation Rule: Derive a value if the following conditions are met.

- Instance.REDUCEDI = 00, 01, or 03
- Instance.FESTUMK is not 5

Derivation Steps:

1. Derive as zero, if the Report Zero check box is selected on the HESA Instance page for the reporting period.
2. Derive as the Override FTE value on the HESA Instance page for the reporting period.
3. Derive as the Calculated FTE value on the HESA Instance page for the reporting period.
4. Use default.
5. Derive as *NULL ERROR*.

Teacher Reference Number (TREFNO)

Return: Student Record

Entity: Instance

Page Used:

<i>Page</i>	<i>Page Element</i>
External System ID	External System ID

Field Derivation Rule: Derive a value if the following conditions are met:

- Country = England or Wales
- Instance.REDUCEDI = 00 or 01, or 04 or 08
- Related Course.TTCID = 1

Do not derive a value and leave the field blank, if the conditions are not met.

Derivation Steps:

1. Select External System ID records for the person with the External ID Type defined for TREFNO in the HESA Types page.
2. Use default.
3. If Country = England, derive NULL ERROR.
4. Do not derive a value and leave the field blank.

Type of Instance Year (TYPEYR)

Return: Student Record

Entity: Instance

Pages Used:

Page	Page Element
Program HESA Data	TYPEYR
Program Offering/Year HESA	TYPEYR (Program Year HESA Data group box)
Plan HESA Data	TYPEYR
Plan Offering/Year HESA	TYPEYR (Plan Year HESA Data group box)
Sub-Plan HESA	TYPEYR
Sub-Plan Offering/Year HESA	TYPEYR (Sub-Plan Year Data group box)
HESA Instance	TYPEYR

Field Derivation Rule: Derive a value if the following conditions are met.

- Instance.REDUCEDI = 00 or 01
- Instance.FESTUMK is not 5

Derivation Steps:

1. Use constant.
2. Derive from the HESA Instance page.
3. Derive as 1 if COMDATE is in the range 01-AUG to 31-DEC (any year) and ENDDATE is in the range 01-JAN to 31-JUL (any year) and RSNEND = 01 or 98.
4. Derive as 1 if Instance.COURSEID is based on a subplan, and a TYPEYR value of 1 is defined on the Sub-Plan Offering/Year HESA page for the combination of academic load and YEARPRG of the student instance. Only records where Offering Start Term, Offering Start Session, Campus, Year Term and Year Session are all blank are considered.
5. Derive as 2 if Instance.COURSEID is based on a subplan, a TYPEYR value of 2, 3, 4, or 5 is defined on the Sub-Plan Offering/Year HESA page for the combination of academic load and YEARPRG of the student instance, and COMDATE is within the reporting period. Only records where Offering Start Term, Offering Start Session, Campus, Year Term and Year Session are all blank are considered.
6. Derive as 3 if Instance.COURSEID is based on a subplan, a TYPEYR value of 2, 3, 4, or 5 is defined on the Sub-Plan Offering/Year HESA page for the combination of academic load and YEARPRG of the student instance, COMDATE is prior to the reporting period, ENDDATE value does not exist or is not within the reporting period, and Country is “England”. Else, derive as 2 if Country is Scotland, Northern Ireland, or Wales. Only records where Offering Start Term, Offering Start Session, Campus, Year Term and Year Session are all blank are considered.
7. Derive as 4 if Instance.COURSEID is based on a subplan, a TYPEYR value of 2, 3, 4, or 5 is defined on the Sub-Plan Offering/Year HESA page for the combination of academic load and YEARPRG of

- the student instance, COMDATE is prior to the reporting period, ENDDATE is within the reporting period, and Country is “England”. Else, derive as 2 if Country is Scotland, Northern Ireland, or Wales. Only records where Offering Start Term, Offering Start Session, Campus, Year Term and Year Session are all blank are considered.
8. Derive as 1 if Instance.COURSEID is based on a subplan and a TYPEYR value of 1 is defined on the Sub-Plan HESA page.
 9. Derive as 2 if Instance.COURSEID is based on a subplan, a TYPEYR value of 2, 3, 4, or 5 is defined on the Sub-Plan HESA page, and COMDATE is within the reporting period.
 10. Derive as 3 if Instance.COURSEID is based on a subplan, a TYPEYR value of 2, 3, 4, or 5 is defined on the Sub-Plan HESA page, COMDATE is prior to the reporting period, ENDDATE value does not exist or is not within the reporting period, and Country is “England”. Else, derive as 2 if Country is Scotland, Northern Ireland, or Wales.
 11. Derive as 4 if Instance.COURSEID is based on a subplan, a TYPEYR value of 2, 3, 4, or 5 is defined on the Sub-Plan HESA page, COMDATE is prior to the reporting period, ENDDATE is within the reporting period, and Country is “England”. Else, derive as 2 if Country is Scotland, Northern Ireland, or Wales..
 12. Derive as 1 if a TYPEYR value of 1 is defined on the Plan Offering/Year HESA page for the combination of academic load and YEARPRG of the student instance. Only records where Offering Start Term, Offering Start Session, Campus, Year Term and Year Session are all blank are considered.
 13. Derive as 2 if a TYPEYR value of 2, 3, 4, or 5 is defined on the Plan Offering/Year HESA page for the combination of Academic Load and YEARPRG of the student instance, and COMDATE is within the reporting period. Only records where Offering Start Term, Offering Start Session, Campus, Year Term and Year Session are all blank are considered.
 14. Derive as 3 if a TYPEYR value of 2, 3, 4, or 5 is defined on the Plan Offering/Year HESA page for the combination of Academic Load and YEARPRG of the student instance, COMDATE is prior to the reporting period, ENDDATE value does not exist or is not within the reporting period, and Country is “England”. Else, derive as 2 if Country is Scotland, Northern Ireland, or Wales. Only records where Offering Start Term, Offering Start Session, Campus, Year Term and Year Session are all blank are considered.
 15. Derive as 4 if a TYPEYR value of 2, 3, 4, or 5 is defined on the Plan Offering/Year HESA page for the combination of Academic Load and YEARPRG of the student instance, COMDATE is prior to the reporting period, ENDDATE is within the reporting period, and Country is “England”. Else, derive as 2 if Country is Scotland, Northern Ireland, or Wales. Only records where Offering Start Term, Offering Start Session, Campus, Year Term and Year Session are all blank are considered.
 16. Derive as 1 if a TYPEYR value of 1 is defined on the Plan HESA Data page.
 17. Derive as 2 if a TYPEYR value of 2, 3, 4, or 5 is defined on the Plan HESA Data page, and COMDATE is within the reporting period.
 18. Derive as 3 if a TYPEYR value of 2, 3, 4, or 5 is defined on the Plan HESA Data page, COMDATE is prior to the reporting period, ENDDATE value does not exist or is not within the reporting period, and Country is “England”. Else, derive as 2 if Country is Scotland, Northern Ireland, or Wales.

19. Derive as 4 if a TYPEYR value of 2, 3, 4, or 5 is defined on the Plan HESA Data page, COMDATE is prior to the reporting period, ENDDATE is within the reporting period, and Country is “England”. Else, derive as 2 if Country is Scotland, Northern Ireland, or Wales.
20. Derive as 1 if a TYPEYR value of 1 is defined on the Program Offering/Year HESA page for the combination of Academic Load and YEARPRG of the student instance.
21. Derive as 2 if a TYPEYR value of 2, 3, 4, or 5 is defined on the Program Offering/Year HESA page for the combination of Academic Load and YEARPRG of the student instance, and COMDATE is within the reporting period.
22. Derive as 3 if a TYPEYR value of 2, 3, 4, or 5 is defined on the Program Offering/Year HESA page for the combination of Academic Load and YEARPRG of the student instance, COMDATE is prior to the reporting period, ENDDATE value does not exist or is not within the reporting period, and Country is “England”. Else, derive as 2 if Country is Scotland, Northern Ireland, or Wales.
23. Derive as 4 if a TYPEYR value of 2, 3, 4, or 5 is defined on the Program Offering/Year HESA page for the combination of Academic Load and YEARPRG of the student instance, COMDATE is prior to the reporting period, ENDDATE is within the reporting period, and Country is “England”. Else, derive as 2 if Country is Scotland, Northern Ireland, or Wales.
24. Derive as 1 if a TYPEYR value of 1 is defined on the Program HESA Data page.
25. Derive as 2 if a TYPEYR value of 2, 3, 4, or 5 is defined on the Program HESA Data page and COMDATE is within the reporting period.
26. Derive as 3 if a TYPEYR value of 2, 3, 4, or 5 is defined on the Program HESA Data page, COMDATE is prior to the reporting period, ENDDATE value does not exist or is not within the reporting period, and Country is “England”. Else, derive as 2 if Country is Scotland, Northern Ireland, or Wales.
27. Derive as 4 if a TYPEYR value of 2, 3, 4, or 5 is defined on the Program HESA Data page, COMDATE is prior to the reporting period, ENDDATE is within the reporting period, and Country is “England”. Else, derive as 2 if Country is Scotland, Northern Ireland, or Wales..
28. Use default.
29. Derive as *NULL ERROR*.

The derivation logic can use the TYPEYR values of 3, 4, or 5 set up for year, program, plan, or subplan. However, it is expected that only values 1 (Course academic year contained within the HESA reporting year 1 August - 31 July) or 2 (Course academic year not contained within the HESA reporting year 1 August - 31 July) are relevant because the remaining values of 3, 4, and 5 apply to the student instance rather than the year as a whole.

The system repeats Steps 3 to 6, depending on the level at which the TYPEYR value is defined in the academic structure.

Units of Length (UNITLGTH)

Return: Student Record

Entity: Instance

Pages Used:

Page	Page Element
Program HESA Data	UNITLGTH
Program Offering/Year HESA	UNITLGTH (Program Offering HESA Data group box)
Plan HESA Data	UNITLGTH
Plan Offering/Year HESA	UNITLGTH (Plan Offering HESA Data group box)
Sub-Plan HESA	UNITLGTH
Sub-Plan Offering/Year HESA	UNITLGTH (Sub-Plan Offering HESA Data group box)
HESA Instance	UNITLGTH

Field Derivation Rule: Derive a value if the following conditions are met. If 09, derive a value. Otherwise, do not derive a value and leave the field blank.

- Instance.REDUCEDI = 00 or 01
- Instance.FESTUMK is not 5

Derivation Steps:

1. Use constant.
2. Derive from the HESA Instance page.
3. If Instance.COURSEID is based on a subplan, derive from the Sub-Plan Offering/Year HESA page for the academic load of the student instance. Only records where Offering Start Term, Offering Start Session, and Campus are all blank are considered.
4. If Instance.COURSEID is based on a subplan, derive from the Sub-Plan HESA page.
5. Derive from the Plan Offering/Year HESA page for the academic load of the student instance. Only records where Offering Start Term, Offering Start Session, and Campus are all blank are considered.
6. Derive from the Plan HESA Data page.
7. Derive from the Program Offering/Year HESA page for the academic load of the student instance.
8. Derive from the Program HESA Data page.
9. Use default.
10. Derive as *NULL ERROR*.

Withdrawal Reason (WITHDRAWREASON)

Return: Student Record

Entity: Instance

Page Used:

Page	Page Element
HESA Instance	WITHDRAWNREASON

Field Derivation Rule: Derive only if the Include FE check box is selected.

Derive a value if the following conditions are met:

- Country = England
- Instance.CSTAT = 3 (withdrawn)

Do not derive a value and leave the field blank, if the conditions are not met.

Derivation Steps:

1. Use constant.
2. Derive from the HESA Instance page.
3. Use default.
4. Derive as *NULL ERROR*.

Length of Current Year of Instance (YEARLGTH)

Return: Student Record

Entity: Instance

Pages Used:

Page	Page Element
Program HESA Data	YEARLGTH
Program Offering/Year HESA	YEARLGTH (Program Year HESA Data group box)
Plan HESA Data	YEARLGTH
Plan Offering/Year HESA	YEARLGTH (Plan Year HESA Data group box)

Page	Page Element
Sub-Plan HESA	YEARLGTH
Sub-Plan Offering/Year HESA	YEARLGTH (Sub-Plan Year Data group box)
HESA Instance	YEARLGTH

Field Derivation Rule: Derive a value if one of the the following conditions is met:

- Country = Scotland AND Instance.REDUCEDI = 00.
- Country = Wales, Instance. REDUCEDI= 00 AND Course.COURSEAIM does not begin with P, Q, R, S or X

Do not derive a value and leave the field blank, if the conditions are not met.

Derivation Steps:

1. Use constant.
2. Derive from the HESA Instance page.
3. If Instance.LOCSDY = *D*, *F* or *T*, derive as null.
4. If Instance.COURSEID is based on a subplan, derive from the Sub-Plan Offering/Year HESA page for the combination of Academic Load and YEARPRG of the student instance. Only records where Offering Start Term, Offering Start Session, Campus, Year Term and Year Session are all blank are considered.
5. If Instance.COURSEID is based on a subplan, derive from the Sub-Plan HESA page.
6. Derive from the Plan Offering/Year HESA page for the combination of Academic Load and YEARPRG of the student instance. Only records where Offering Start Term, Offering Start Session, Campus, Year Term and Year Session are all blank are considered.
7. Derive from the Plan HESA Data page.
8. Derive from the Program Offering/Year HESA page for the combination of Academic Load and YEARPRG of the student instance.
9. Derive from the Program HESA Data page.
10. Use default.
11. Derive as *NULL ERROR*.

Year of Program (YEARPRG)

Return: Student Record

Entity: Instance

Page Used:

Page	Page Element
HESA Instance	Year of Program

Field Derivation Rule: Derive a value if one of the following conditions is met:

- Country = England, Northern Ireland, or Scotland AND Instance.REDUCEDI = 00 or 01 AND Instance.FESTUMK is not 5
- Country = Wales, Instance.REDUCEDI = 00 or 01 AND Instance.FESTUMK is not 5 AND Course.COURSEAIM does not begin with P, Q, R, S or X

Derivation Steps:

1. Derive from the HESA Instance page.
2. Use default.
3. Derive as *NULL ERROR*.

Year of Student on This Instance (YEARSTU)

Return: Student Record

Entity: Instance

Page Used:

Page	Page Element
HESA Instance	Year of Student

Field Derivation Rule: Derive a value if one of the following conditions is met:

- Country = England, Northern Ireland, or Scotland AND Instance.REDUCEDI = 00 AND Instance.FESTUMK is not 5
- Country = Wales, Instance.REDUCEDI = 00 or 01 AND Instance.FESTUMK is not 5 AND Course.COURSEAIM does not begin with P, Q, R, S or X

Derivation Steps:

1. Derive from the HESA Instance page.
2. Use default.
3. Derive as *NULL ERROR*.

Student Record Return: Entry Profile Entity

If you select the **Include Student Entities** check box on the Create Extract Data page, the Create Extract process creates a Entry Profile entity. The process creates a Entry Profile entity for each Instance entity if either the Instance.COMDATE is within the reporting period or if the Include Entry Profile check box is selected on the Entry Profile page. The process creates a single Entry Profile entity using the same key structure as the Instance record.

Access Programmes (ACCESS)

Return: Student Record

Entity: Entry Profile

Page Used:

Page	Page Element
Entry Profile	ACCESS

Field Derivation Rule: Derive a value if the following conditions are met:

- Country = Scotland
- EntryProfile.QUALENT3 = X00 or X01

Do not derive a value and leave the field blank, if the conditions are not met.

Derivation Steps:

1. Use constant.
2. Derive from the Entry Profile page.
3. Use default.
4. Derive as *NULL ERROR*.

APEL Credits (APELCRD)

Return: Student Record

Entity: Entry Profile

Page Used:

Page	Page Element
Entry Profile	APELCRD

Field Derivation Rule: Derive a value if the following conditions are met:

- Country = England
- EntryProfile.CRDPTSTU is not null

Derivation Steps:

1. Derive from the Entry Profile page.
2. Use default.
3. Derive as null.

Articulation (ARTICLN)

Return: Student Record

Entity: Entry Profile

Page Used:

Page	Page Element
Entry Profile	ARTICLN

Field Derivation Rule: Derive a value if the following conditions are met:

- Country = Scotland
- Entry Profile.DOMICILE = XF, XG, XH, XI, XK, XL, GG, JE, or IM
- Related Instance.REDUCEDI = 00 or 04
- Related Course.COURSEAIM = M22, M26, M28, H00, H11, H16, H18, H22, H23, I00, I11, or I16
- Instance.COMDATE is after 2007-07-31
- Instance.INTERCALATE is not 01

Do not derive a value and leave the field blank, if the conditions are not met.

Derivation Steps:

1. Use constant.
2. Derive from the Entry Profile page.
3. Use default.
4. Derive as *NULL ERROR*.

Care Leaver / Looked After Status (CARELEAVER)

Return: Student Record

Entity: Entry Profile

Page Used:

Page	Page Element
Entry Profile	CARELEAVER

Field Derivation Rule: Derive a value if one of the following sets of conditions is met.

Set	Conditions to be Met
Set 1	<ul style="list-style-type: none"> • Country = England • Instance.REDUCEDI = 00 or 01 • Course.COURSEAIM begins with H (except for H50, H60, H61, H62, H78 or H81), I (except I60, I61 or I81), J or C or is M22, M26, M28, M71, M73, or M88 • Instance.FUNDCODE = 1 or 7 • Instance.COMDATE is greater than 2013-07-31 • Instance.EXCHANGE is not 4, G or Z • Course.TTCID is not F
Set 2	<ul style="list-style-type: none"> • Country = England • Instance.REDUCEDI = 08 • Course.COURSEAIM begins with H (except for H50, H60, H61, H62, H78 or H81), I (except I60, I61 or I81), J or C or is M22, M26, M28, M71, M73, or M88 • Course.MSFUND is not 37
Set 3	<ul style="list-style-type: none"> • Country = Scotland • Instance.REDUCEDI = 00, 01 or 04 • EntryProfile.DOMICILE = XF, XG, XH, XI or XK • Instance.COMDATE is greater than 2013-07-31

Set	Conditions to be Met
Set 4	<ul style="list-style-type: none"> • Country = Northern Ireland • EntryProfile.DOMICILE = XF, XG, XH, XI or XK • Course.COURSEAIM begins with H, I, J or C or is M22, M26, M28, M71, M73, or M88 • EntryProfile.DOMICILE = XF, XG, XH, XI, XK, XL, GG, JE, IM • Instance.COMDATE is greater than 2013-07-31

Derivation Steps:

1. Use constant.
2. Derive from the Entry Profile page.
3. Use default.
4. Derive as *NULL ERROR*.

Credit Points Counted Towards Study (CRDPTSTU)

Return: Student Record

Entity: Entry Profile

Pages Used:

Page	Page Element
Entry Profile	CRDPTSTU

Field Derivation Rule: Derive a value if Country = England.

Derivation Steps:

1. Derive from the Entry Profile page.
2. Use default.
3. Derive as null.

Credit Scheme (CRDSCM)

Return: Student Record

Entity: Entry Profile

Pages Used:

Page	Page Element
Entry Profile	CRDSCM

Field Derivation Rule: Derive a value if all the conditions are met:

- Country = England
- EntryProfile.CRDPTSTU is not null

Derivation Steps:

1. Derive from the Entry Profile page.
2. Use default.
3. Derive as NULL ERROR.

Domicile (DOMICILE)

Return: Student Record

Entity: Entry Profile

Pages Used:

Page	Page Element
Residency Self-Report (Campus Community > Personal Information (Student) > Identification (Student) > Residency Data > Residency Self-Report)	State Country
Entry Profile	DOMICILE
Nationality (Records and Enrollment > HESA Reporting > Codes and Mappings > Code Mappings > Nationality)	HESA Domicile
Area of Permanent Residence (Set Up SACR > Product Related > Recruiting and Admissions > UCAS > Mappings > Area of Permanent Residence)	HESA Code

Field Derivation Rule: Include for all Entry Profile entities.

Derivation Steps:

1. Derive from the Entry Profile page.
2. Select the Residency Self-Report record with the latest Date Reported before the Instance.COMDATE. If no record is found, then select the record with the earliest Date Reported date on or after Instance.COMDATE.

If a Residency Self-Report record is found and the Country value is not *GBR*, retrieve the related two-character code (COUNTRY_2CHAR) from the Country table (PS_COUNTRY_TBL). If the mapping to a HESA Domicile exists on the Nationality page for the Campus Solutions country code, use the mapped HESA Domicile value; otherwise, use the COUNTRY_2CHAR value.

3. If the Residency Self-Report record is found, the Country value is *GBR*, and a State value exists, select the country and state values. If a mapping exists on the Area of Permanent Residence page between a HESA country code and the selected country and state values, use the mapped HESA Country code. If no mapping is found, log an error message and derive *XX*.
4. If a Residency Self-Report record is found, the Country value is *GBR*, and a State value does not exist, derive *XX*.
5. Use default.
6. Derive as *NULL ERROR*.

Note that some Campus Solutions country codes are invalid for HESA reporting. Use the Nationality page to map the valid HESA codes with the Campus Solutions country codes.

Estranged Student (ESTRANGED)

Return: Student Record

Entity: Entry Profile

Pages Used:

Page	Page Element
Entry Profile	ESTRANGED

Field Derivation Rule: Derive a value if all the conditions are met:

- Country = Scotland
- EntryProfile.DOMICILE = XF, XG, XH, XI, XK, XL, GG, JE, or IM
- Course.COURSEAIM starts with H, I, J or C or is M22, M26 or M28

Derivation Steps:

1. Derive from the Entry Profile page.
2. Use default.
3. Derive as *NULL ERROR*.

Marital Status (MARSTAT)

Return: Student Record

Entity: Entry Profile

Pages Used:

Page	Page Element
Biographical Details (Campus Community > Personal Information (Student) > Add/Update Person > Biographical Details)	Marital Status
Entry Profile	MARSTAT
Marital Status (Records and Enrollment > HESA Reporting > Codes and Mappings > Code Mappings > Marital Status)	HESA Marital Status

Field Derivation Rule: Derive a value if the following conditions are met:

- Country = Northern Ireland
- EntryProfile.DOMICILE = XG (Northern Ireland)
- Related Instance.REDUCEDI = 00 or 04

Do not derive a value and leave the field blank, if the conditions are not met.

Derivation Steps:

1. Derive from the Entry Profile page.
2. Select the Marital Status value from the Biographical History record. Use the mapping on the Marital Status page to derive the HESA Martial Status code.
3. Derive as *NULL ERROR*.

New Entrant to Higher Education (NEWENT)

Return: Student Record

Entity: Entry Profile

Page Used:

Page	Page Element
Entry Profile	NEWENT

Field Derivation Rule: Derive a value if the following conditions are met:

- Related Instance.REDUCEDI = 00

- Related Course.COURSEAIM begins with D, E, L, M, H, I, J, or C

Do not derive a value and leave the field blank, if the conditions are not met.

Derivation Steps:

1. Use constant.
2. Derive from the Entry Profile page.
3. Use default.
4. Do not derive a value and leave the field blank.

Dependents on Entry (NIDEPEND)

Return: Student Record

Entity: Entry Profile

Page Used:

Page	Page Element
Entry Profile	NIDEPEND

Field Derivation Rule: Derive a value if the following conditions are met:

- Country = Northern Ireland
- EntryProfile.DOMICILE = XG (Northern Ireland)
- Related Instance.REDUCEDI = 00 or 04

Do not derive a value and leave the field blank, if the conditions are not met.

Derivation Steps:

1. Use constant.
2. Derive from the Entry Profile page.
3. Use default.
4. Derive as *NULL ERROR*.

Parental Education (PARED)

Return: Student Record

Entity: Entry Profile

Page Used:

Page	Page Element
Entry Profile	PARED

Field Derivation Rule: Derive a value if one of the following sets of conditions is met.

Set	Conditions to be Met
Set 1	<ul style="list-style-type: none"> • Country = England • Instance.REDUCEDI = 00 or 01 • Course.COURSEAIM begins with H, I, J, or C, or is M22, M26, M28, M71, M73, or M88 (excluding for H50, H60, H61, H62, H78, H81, I60, I61 or I81) • Instance.COMDATE is greater than 2007-07-31 • Instance.EXCHANGE is N, Y, or null
Set 2	<ul style="list-style-type: none"> • Country = England • Instance.REDUCEDI = 08 • Course.COURSEAIM begins with H, I, J, or C, or is M22, M26, M28, M71, M73, or M88 (excluding for H50, H60, H61, H62, H78, H81, I60, I61 or I81) • Course.MSFUND is not 37 • Instance.COMDATE is greater than 2007-07-31
Set 3	<ul style="list-style-type: none"> • Country = Northern Ireland • EntryProfile.DOMICILE = XF, XG, XH, XI, XK, XL, GG, JE, or IM • Course.COURSEAIM begins with H, I, J or C or is M22, M26, M28, M71, M73, or M88 • Instance.COMDATE is greater than 2008-07-31
Set 4	<ul style="list-style-type: none"> • Country = Scotland • EntryProfile.DOMICILE = XF, XG, XH, XI, XK, XL, GG, JE, or IM • Course.COURSEAIM is M22, M26, M28, H00, H11, H16, H18, H22, H23, I00, I11, I16, J10, J16, J20, J26, J30, C20, or C30 • Instance.REDUCEDI = 00 or 04 • Instance.COMDATE is greater than 2007-07-31 • Instance.INTERCALATE is not 01

Derivation Steps:

1. Use constant.

- 2. Derive from the Entry Profile page.
- 3. Use default.
- 4. Derive as *NULL ERROR*.

PGCE Class of Undergraduate Degree (PGCECLSS)

Return: Student Record

Entity: Entry Profile

Page Used:

<i>Page</i>	<i>Page Element</i>
Entry Profile	PGCECLSS

Field Derivation Rule: Derive a value if the following conditions are met:

- Related Instance.REDUCEDI = 00 or 04
- Related Course.COURSEAIM = M71, M73, or H71

Do not derive a value and leave the field blank, if the conditions are not met.

Derivation Steps:

- 1. Use constant.
- 2. Derive from the Entry Profile page.
- 3. Use default.
- 4. Derive as *NULL ERROR*.

PGCE Subject of Undergraduate Degree (PGCESBJ, PGCESBJ2, PGCESBJ3, PGCESBJ4, PGCESBJ5)

Return: Student Record

Entity: Entry Profile

Page Used:

Page	Page Element
Entry Profile	PGCESBJ PGCESBJ2 PGCESBJ3 PGCESBJ4 PGCESBJ5

Field Derivation Rule: Derive a value if the following conditions are met:

- Related Instance.REDUCEDI = 00 or 04
- Related Course.COURSEAIM = M71, M73, or H71

Do not derive a value and leave the field blank, if the conditions are not met.

Derivation Steps:

1. Use constant to create a single **PGCESBJ** field.
2. Derive from the Entry Profile page.
3. Use default to create a single **PGCESBJ** field.
4. Derive a single **PGCESBJ** field as *NULL ERROR*.

Note: The system can derive up to three values. Each of the values is included as a separate **PGCESBJ** field in the XML file.

Postcode (POSTCODE)

Return: Student Record

Entity: Entry Profile

Pages Used:

Page	Page Element
Addresses (Campus Community > Personal Information (Student) > Biographical (Student) > Addresses/Phones > Addresses)	Postal
Entry Profile	POSTCODE

Field Derivation Rule: Derive a value if the following conditions are met:

- EntryProfile.DOMICILE = XF, XG, XH, XI, XK, XL, GG, JE, or IM

- Related Instance.REDUCEDI = 00, 01, 04, 07 or 08

Do not derive a value and leave the field blank, if the conditions are not metPREVINST.

Derivation Steps:

1. Derive from the Entry Profile page.
2. Select the address record with the country code of GBR whose effective date is most recent and falls prior to Instance.COMDATE. The record must have an address type that matches the address type mapped with POSTCODE in the HESA Types page. Derive the post code from this record. If multiple valid addresses are found with the same effective date then one will be randomly picked.

If no addresses are found prior to COMDATE, then select the earliest effective dated record with an effective date on or after COMDATE (that is, closest to COMDATE) that has an Address Type that corresponds with those defined as the Address Types for POSTCODE in the HESA Return Setup record. If multiple valid addresses are found with the same effective date then one will be randomly picked

If the country of the selected address is one of the UK-related codes, the postcode is derived.

The following country codes are considered as UK-related for the purposes of this derivation: GBR (United Kingdom), ENG (England), XF (England), NIR (Northern Ireland), XG (Northern Ireland), SCT (Scotland), XH (Scotland), WAL (Wales), XI (Wales), XK (UK not otherwise specified), XL (Channel Islands not otherwise specified), GG (Guernsey), GGY (Guernsey), JE (Jersey), JEY (Jersey), IM (Isle of Man), or IMN (Isle of Man).

3. Derive as null.

For steps 1 and 2, the system validates that the derived post code value is in the correct format.

Last School Attended (PREVINST)

Return: Student Record

Entity: Entry Profile

Page Used:

Page	Page Element
Entry Profile	PREVINST

Field Derivation Rule: Derive a value if the following conditions are met:

- EntryProfile.DOMICILE = XF, XG, XH, XI, XK, XL, GG, JE, or IM
- Related Instance.REDUCEDI = 00 or 04
- Related Instance.INTERCALATE is not 01
- Related Course.COURSEAIM = M22, M26, M28, H00, H11, H12, H16, H18, H22, H23, I00, I11, I12, I16, I73, J10, J16, J20, J26, J30, C20, or C30

Do not derive a value and leave the field blank, if the conditions are not met.

Derivation Steps:

1. Derive from the Entry Profile page.
2. Use default.
3. Derive as *NULL ERROR*.

Highest Qualification On Entry (QUALENT3)

Return: Student Record

Entity: Entry Profile

Page Used:

Page	Page Element
Entry Profile	QUALENT3

Field Derivation Rule:

Derive a value if Instance.REDUCEDI = 00, 01, or 04.

Do not derive a value and leave the field blank, if the conditions are not met.

Derivation Steps:

1. Derive from the Entry Profile page.
2. Use default.
3. Derive as *NULL ERROR*.

Religion (RELIGION)

Return: Student Record

Entity: Entry Profile

Pages Used:

Page	Page Element
Religious Preference (Campus Community > Personal Information (Student) > Biographical (Student) > Personal Attributes > Religious Preference)	Religious Preference
Entry Profile	RELIGION

Page	Page Element
Religion (Records and Enrollment > HESA Reporting > Codes and Mappings > Code Mappings > Religion)	HESA Religion

Field Derivation Rule: Derive a value if the following conditions are met:

- Country = Northern Ireland
- EntryProfile.DOMICILE = XG (Northern Ireland)
- Related Instance.REDUCEDI = 00 or 04

Do not derive a value and leave the field blank, if the conditions are not met.

Derivation Steps:

1. Derive from the Entry Profile page.
2. Select the religious preference from the personal information record. Use the mapping on the Religion page to derive the HESA Religion code.

If the HESA religion code mapping does not exist, log an error message and skip to the next step.

3. Use default.
4. Derive as *NULL ERROR*.

Socio-Economic Classification (SEC)

Return: Student Record

Entity: Entry Profile

Page Used:

Page	Page Element
Entry Profile	SEC

Field Derivation Rule: Derive a value if the following conditions are met:

- A value for EntryProfile.UCASAPPID exists.
- EntryProfile.DOMICILE is XF, XG, XH, XI, XK, XL, GG, JE or IM
- Related Course.COURSEAIM begins with H, I, J, or C or is M22, M26 or M28.

Do not derive a value and leave the field blank, if the conditions are not met.

Derivation Steps:

1. Derive from the Entry Profile page.
2. Use default.
3. Derive as *NULL ERROR*.

Occupation Code (SOC2010)

Return: Student Record

Entity: Entry Profile

Page Used:

Page	Page Element
Entry Profile	SOC2010

Field Derivation Rule: Derive a value if the following conditions are met:

- A value for EntryProfile.UCASAPPID exists.
- EntryProfile.DOMICILE is XF, XG, XH, XI, XK, XL, GG, JE or IM
- Related Course.COURSEAIM begins with H, I, J, or C or is M22, M26 or M28.

Do not derive a value and leave the field blank, if the conditions are not met.

Derivation Steps:

1. Derive from the Entry Profile page.
2. Use default.
3. Derive as *NULL ERROR*.

UCAS Application Number (UCASAPPID)

Return: Student Record

Entity: Entry Profile

Page Used:

Page	Page Element
Application Data (Student Admissions > Application Maintenance > Maintain Applications > Application Data)	External Application Nbr
Entry Profile	UCASAPPID

Field Derivation Rule: Include for all Entry Profile entities.

Derivation Steps:

1. Derive from the Entry Profile page.
2. Use the Student Program record of the instance to find the admission application number (ADM_APPL_NBR). Use this admission application number to find the Admissions Data record (PS_ADM_APPL_DATA). Then, from the Application Data page for this record, find the External Application Number. The External Application Number is used to record the UCAS Application Number or Application Code plus Choice Number for UCAS applications.

If External Application Number exists and is a UCAS number — that is, the number is a 4-character application code that begins *UC*, plus -, plus single-digit choice number (for example, UC01-1), then the system derives the UCAS number value minus the - and choice elements (for example, UC01). Only values beginning *UC* are derived. If any other value is found, the derivation step is skipped.

3. Use default.
4. Do not derive a value and leave the field blank.

Welsh Baccalaureate Advanced Diploma (WELBACC)

Return: Student Record

Entity: Entry Profile

Page Used:

<i>Page</i>	<i>Page Element</i>
Entry Profile	WELBACC

Field Derivation Rule: Derive a value if the following conditions are met:

- EntryProfile.DOMICILE = XI (Wales)
- Related Instance.REDUCEDI = 00 or 04
- Related Course.COURSEAIM begins with H, I, J or C (that is, not FE)

Do not derive a value and leave the field blank, if the conditions are not met.

Derivation Steps:

1. Derive from the Entry Profile page.
2. Use default.
3. If Country is Wales on the HESA Returns page, derive as *NULL ERROR*.
4. If Country is not Wales on the HESA Returns page, do not derive a value and leave the field blank.

Year Left Last Institution (YRLLINST)

Return: Student Record

Entity: Entry Profile

Page Used:

<i>Page</i>	<i>Page Element</i>
Entry Profile	YRLLINST

Field Derivation Rule: Derive a value if the following conditions are met:

- Country = Scotland
- EntryProfile.ARTICLN = 1, 2, 3, or 4

Do not derive a value and leave the field blank, if the conditions are not met.

Derivation Steps:

1. Derive from the Entry Profile page.
2. Use default.
3. Derive as *NULL ERROR*.

Student Record Return: Qualifications On Entry Entity

The Create Extract process creates Qualifications On Entry entities for each Entry Profile entity in the return where the Instance.COMDATE falls within the reporting period and the related course entity has an undergraduate COURSEAIM that does not begin with D, E, L or M with the exceptions of M22, M26 and M28, which are included.

The process creates the Qualifications On Entry entities only if the **Include Student Entities** check box is selected on the Create Extract Data page. To create the Qualifications On Entry entities, the process selects entry qualifications that have the **Report To HESA** check box selected and the QUALTYPE code imported from HESA.

Qualification Grade (QUALGRADE)

Return: Student Record

Entity: Qualifications On Entry

Page Used:

Page	Page Element
Entry Profile	Grade

Field Derivation Rule: Include for all Qualifications On Entry entities.

Derivation Steps:

The system performs the following steps to derive the values:

1. Derive from the Entry Profile page.
2. Do not derive a value and leave the field blank.

Qualification Subject (QUALSBJ)

Return: Student Record

Entity: Qualifications On Entry

Page Used:

Page	Page Element
Entry Profile	Subject

Field Derivation Rule: Include for all Qualifications On Entry entities.

Derivation Steps:

1. Derive from the Entry Profile page.
2. Derive as *NULL ERROR*.

Qualification Sitting (QUALSIT)

Return: Student Record

Entity: Qualifications On Entry

Page Used:

Page	Page Element
Entry Profile	Sitting

Field Derivation Rule: Include for all Qualifications On Entry entities.

Derivation Steps:

1. Derive from the Entry Profile page.
2. Do not derive a value and leave the field blank.

Qualification Type (QUALTYPE)

Return: Student Record

Entity: Qualifications On Entry

Page Used:

Page	Page Element
Entry Profile	Type

Field Derivation Rule: Include for all Qualifications On Entry entities.

Derivation Steps:

1. Derive from the Entry Profile page.
2. Derive as *NULL ERROR*.

Qualification Year (QUALYEAR)

Return: Student Record

Entity: Qualifications On Entry

Page Used:

Page	Page Element
Entry Profile	Year

Field Derivation Rule: Include for all Qualifications On Entry entities.

Derivation Steps:

1. Derive from the Entry Profile page.
2. Derive as *NULL ERROR*.

Student Record Return: Qualifications Awarded Entity

The Create Extract process creates Qualifications Awarded entities for each Instance entity where the student has completed the course and the academic institution has awarded a qualification to the student.

The process uses the HESA Instance record for field derivation. If a field value does not exist in the HESA Instance record, the process uses the student degree records for derivation.

The process creates the Qualifications Awarded entities only if the **Include Student Entities** check box is selected on the Create Extract Data page. The selection logic for Qualifications Awarded that considers student degree records considers the completion term and confer dates when determining if the qualification should be included in the extract. That is, degrees should have status of *Awarded* with either a Confer Date that falls within the reporting period dates or a completion term that overlaps the reporting period (which means, the term end date is on or after the reporting period start date and the term begin date is on or before the reporting period end date).

The process selects Qualifications Awarded records for Instance records where:

- Instance.REDUCEDI = 00,01 or 04 (not Reduced FE or Incoming Visiting/Exchange), and
- Instance.ENDDATE is not null *or* Instance.INTERCALATE = 01

Classification (CLASS)

Return: Student Record

Entity: Qualifications Awarded

Pages Used:

Page	Page Element
HESA Instance	Classification (Qualifications Awarded group box)
Degree Honors (Records and Enrollment > Graduation > Student Degrees > Degree Honors)	Honors Code
Classification (Records and Enrollment, HESA Reporting, Codes and Mappings, Code Mappings, Classification)	Honors Code

Field Derivation Rule: Derive a value if one of the following conditions is met:

- Country = Northern Ireland or Scotland *and* QualificationsAwarded.QUAL = M22, M26, M28, H00, H11, H12, H16, H18, H22, H23, H24, H50, I00, I11, I12, or I16
- Country = England

Derivation Steps:

1. If the entity is derived from the HESA Instance - Qualifications Awarded record, derive as the Classification value.
2. If the entity is derived from Student Degrees record, use the mapping on the Classification page to derive as the HESA Honors Code. On the Classification page the HESA Honors Code must be mapped to a HESA classification and a Honors Type where the Honors Type must be *Degree Honors*.

3. Derive as *NULL ERROR*.

Outcome of ITT Instance (OUTCOME)

Return: Student Record

Entity: Qualifications Awarded

Pages Used:

Page	Page Element
HESA Instance	Outcome of ITT Instance (Qualifications Awarded group box)
HESA Instance	OUTCOME (Instance HESA Data group box)

Field Derivation Rule: Derive a value if the following conditions are met:

- Country = England or Wales
- Related Course.TTCID = 1 or Q

Do not derive a value and leave the field blank, if the conditions are not met.

Derivation Steps:

1. If the entity is derived from the HESA Instance - Qualifications Awarded record, derive as the Outcome of ITT Instance value.
2. If the entity is derived from Student Degrees record, derive as the OUTCOME value.
3. Use default.
4. Derive as *NULL ERROR*.

Qualification Awarded (QUAL)

Return: Student Record

Entity: Qualifications Awarded

Pages Used:

Page	Page Element
HESA Instance	Qualification Awarded (Qualifications Awarded group box)
Degree (Records and Enrollment > Graduation > Student Degrees > Degree)	Degree

Page	Page Element
Qualification (Records and Enrollment, HESA Reporting, Codes and Mappings, Code Mappings, Qualification)	Degree

Field Derivation Rule: Include for all Qualifications Awarded entities.

Derivation Steps:

1. If the entity is derived from the HESA Instance - Qualifications Awarded record, derive as the Qualification Awarded value.
2. If the entity is derived from Student Degrees record, use the mapping on the Qualification page to derive as the mapped HESA Degree code.
3. Derive as *NULL ERROR*.

Teaching Qualifications Gained Sector (TQGSEC)

Return: Student Record

Entity: Qualifications Awarded

Pages Used:

Page	Page Element
HESA Instance	Sector (Qualifications Awarded group box)
HESA Instance	TQGSEC (Instance HESA Data group box)
Program HESA Data	TQGSEC (Program HESA Instance Data group box)
Plan HESA Data	TQGSEC (Plan HESA Instance Data group box)
Sub-Plan HESA	TQGSEC (Sub-Plan HESA Instance Data group box)

Field Derivation Rule: Derive a value if the following conditions are met:

- Country = Scotland or Northern Ireland
- Related Course.TTCID = 1 or 2

Do not derive a value and leave the field blank, if the conditions are not met.

Derivation Steps:

1. If the entity is derived from the HESA Instance - Qualifications Awarded record, derive as the Sector value.

2. If the entity is derived from Student Degrees record, derive as the TQGSEC value. If two awards are reported, use this value for both entities.
3. If the related Instance.COURSEID is based on a sub-plan, derive value from Sub-Plan HESA.
4. Derive value from Plan HESA Data.
5. Derive value from Program HESA Data.
6. Use default.
7. Derive as *NULL ERROR*.

Teacher Qualification Gained Subject (TQGSUB)

Return: Student Record

Entity: Qualifications Awarded

Pages Used:

Page	Page Element
HESA Instance (Qualifications Awarded group box)	Subject 1, Subject 2, Subject 3
HESA Instance (Instance HESA Data group box)	TQGSUB, TQGSUB2, TQGSUB3
Program HESA Data (Program HESA Instance Data group box)	TQGSUB, TQGSUB2, TQGSUB3
Plan HESA Data (Plan HESA Instance Data group box)	TQGSUB, TQGSUB2, TQGSUB3
Sub-Plan HESA (Sub-Plan HESA Instance Data group box)	TQGSUB, TQGSUB2, TQGSUB3

Field Derivation Rule: Derive a value if the following conditions are met:

- Country = Scotland
- QualificationsAwarded.TQGSEC = 2

Do not derive a value and leave the field blank, if the conditions are not met.

Derivation Steps:

1. If the entity is derived from the HESA Instance - Qualifications Awarded record, derive as the Subject 1, Subject 2, and Subject 3 values.
2. If the entity is derived from Student Degrees record, derive as the TQGSUB, TQGSUB2, and TQGSUB3 values. Use these values for both entities if two awards are reported.
3. If the related Instance.COURSEID is based on a sub-plan and TQGSUB is defined, derive all values from Sub-Plan HESA.

4. If TQGSUB is defined, derive all values from Plan HESA Data.
5. If TQGSUB is defined, derive all values from Program HESA Data.
6. Derive single **TQGSUB** field as *NULL ERROR*.

Note: The system can derive up to three values. Each of the values is included as a separate **TQGSUB** field in the XML file.

Student Record Return: Student On Module Entity

The Create Extract process can create a maximum of 128 Student On Module records for each Instance in the return to indicate which modules (Campus Solutions courses) the student has been studying during the reporting period. The process selects Student On Module records based on the student's course enrollments and the course offering records included in the related Module entities of the return.

The process creates the Student On Module entities only if the Include Student Entities check box is selected on the Create Extract Data page.

HESA requires Student On Module records only if Instance.STULOAD is greater than zero. However, academic institutions can optionally include Student On Module records in the return when STULOAD = 0.

To choose student enrollment records for the Student on Module entity creation, the process:

- Selects all activated terms for the student career.
- From each activated term, selects classes that satisfy the following conditions:
 - Class Start Date is within the reporting period, or Class End Date is within the reporting period, or Class Start Date is prior to the reporting period and Class End Date is after the reporting period.
 - Status = *Enrolled* or *Dropped*.
 - Units Taken value is greater than zero.
 - Grading basis value matches one of the values defined in the Grading Basis Inclusion region with the Extract check box selected on the HESA Configuration page.
 - A Repeat Code value does not exist or does not match a value defined in the Repeat Code Exclusion region with the Extract check box selected on the HESA Configuration page.
 - If the student has multiple careers with the same Academic Career value as the career being processed (that is, the same career value with different career numbers), then the process applies a further filter to the class enrollments. In that case, the process selects the class only if the program value of the enrollment record does not exist or matches one of the program values in the Student Program records for that career and career number.

When the process considers class start and end dates for class enrollments where the Session = *OEE* (open entry/exit), rather than selecting the class start/end dates, the process selects the values from the Student OEE Enrollment Data record for the class enrollment. If the end date is not defined in Student OEE

Enrollment Data then the process uses the class end date. The start date is mandatory for a Student OEE Enrollment Data record. Note that the process does not consider linked careers for Student On Module.

For students with a STULOAD value of greater than zero, if there are no relevant class enrolments, the process creates a single Student On Module entity for the student. The process creates the single Student On Module entity only if the combination of Plan and Year has been defined as a dummy module and included in the Module entity.

If the **Always Include** check box is selected on the HESA Dummy Module Data page for the student's year of program, then a Student on Module entity is created together with any eligible class enrollments for the student.

APEL Indicator (APEL)

Return: Student Record

Entity: StudentOnModule

Page Used:

Page	Page Element
HESA Module Data	APEL

Field Derivation Rule: If Country = Wales, derive a value. Otherwise, do not derive a value and leave the field blank.

Derivation Steps:

1. Use constant.
2. Derive from the HESA Module Data page.
3. Use default.
4. Derive as *NULL ERROR*.

Note: You can define an APEL value at Course Offering/Module level if the module is an APEL module only.

Percentage of Module Taught in Celtic Language (LANGPCNT)

Return: Student Record

Entity: StudentOnModule

Page Used:

Page	Page Element
HESA Module Data	LANGPCNT

Field Derivation Rule: If Country = Northern Ireland, Scotland, or Wales, derive a value. Otherwise, do not derive a value and leave the field blank.

Derivation Steps:

1. Use constant.
2. Derive from the HESA Module Data page.
3. Use default.
4. Derive as *NULL ERROR*.

Module Identifier (MODID)

Return: Student Record

Entity: Student On Module

Pages Used: None

Field Derivation Rule: Include for all Student On Module entities.

Derivation Step:

1. For each student enrollment record valid for the reporting period, the process determines MODID as a combination of Course ID plus Course Offering Number from the related Course Offering record.

Module Countable (MODCOUNT)

Return: Student Record

Entity: Student On Module

Pages Used:

Page	Page Element
Module HESA Data	MODCOUNT

Field Derivation Rule: Derive a value if the following conditions are met:

- Country = Wales
- Course.COURSEAIM begins with C, D, E, L, M, H, I or J

Do not derive a value and leave the field blank, if the conditions are not met.

Derivation Steps:

1. Derive from the Module HESA Data page.
2. Use default.
3. Derive as *NULL ERROR*.

Module Outcome (MODOUT)

Return: Student Record

Entity: Student On Module

Pages Used:

Page	Page Element
Enrollment (Records and Enrollment > Enroll Students > Enrollment)	Grading Basis Grade In/Official
Module Outcome (Records and Enrollment > HESA Reporting > Codes and Mappings > Code Mappings > Module Outcome)	HESA Module Outcome

Field Derivation Rule: Include for all Student On Module entities.

Derivation Steps:

1. Derive as the mapped HESA Module Outcome for the grade selected in the enrollment record.
2. Use default.
3. Derive as *NULL ERROR*.

If HESA Module Data dummy module flag for MODID = Y, derive as *07*.

Module Status (MODSTAT)

Return: Student Record

Entity: Student On Module

Pages Used: None

Field Derivation Rule: Include for all Student On Module entities.

Derivation Steps:

1. Use constant.
2. Derive as *1* if the class start date is before the reporting period, and the class end date is within the reporting period.

3. Derive as 2 if the class start and end dates are within the reporting period.
4. Derive as 3 if the class start date is within the reporting period, and the class end date is after the reporting period.
5. Derive as 6 if the class start date is before the reporting period and the class end date is after the reporting period.

Note that the derivation logic compares class start and end dates with the reporting period dates to determine the status.

If HESA Module Data dummy module flag for MODID = Y, derive as 05.

When considering class start and end dates for class enrollments where the Session = OEE, rather than selecting the class start and end dates, the derivation logic selects values from the Student OEE Enrollment Data record for the class enrollment. If the end date is not defined in Student OEE Enrollment Data record, then the logic uses the class end date. The start date is mandatory in the Student OEE Enrollment Data record.

Module Year (MODYR)

Return: Student Record

Entity: Student On Module

Page Used:

<i>Page</i>	<i>Page Element</i>
Module HESA Data	MODYR

Field Derivation Rule: Derive a value if the following conditions are met:

- Country = England or Northern Ireland
- Instance.INSTAPP = 1
- Instance.TYPEYR = 2, 3, 4, or 5

Do not derive a value and leave the field blank, if the conditions are not met.

Derivation Steps:

1. Derive from the Module HESA Data page.
2. Use default.
3. Derive as *NULL ERROR*.

For dummy modules:

1. Derive from the HESA Dummy Module Data page.
2. Use default.

3. Derive as *NULL ERROR*.

Note: The field is only derived if INSTAPP = 1, therefore, usually this field will not have any value.

Student Record Return: REF Data Entity

The Create Extract process creates REF Data entities for each Instance entity where the student is studying a research program and the academic institution is creating a full return for the student.

The process:

- Selects REF Data entities records for the related course records that have a research COURSEAIM = *D00, L00, L80, or L99*, and Instance.REDUCEDI = *00, 01, or 04*.
- Creates entities based on one of the following steps. If a step does not have records, the derivation moves to the next step. If no records are found, then entities are not created.
 1. If values are defined in HESA Instance – Research Data, then use the records to create entities.
 2. If there is a Research Candidate record for the Instance, one or more supervisor records are selected and the associated Advisor HESA Data records are used to create entities.
 3. If advisor records exist for the student and a role is defined in HESA Returns Setup, one or more advisors are selected and the associated Advisor HESA Data records are used to create entities.
- Creates the REF Data entities only if the **Include Student Entities** check box is selected as a run parameter for the Create Extract process.

Deriving records from Research Supervisor/Advisor HESA Data (step 2)

1. Research supervisors are selected from the most recent effective dated record (linked to the instance via the research candidate record) where the date is on or before the reporting period end date, and all the following conditions are met:
 - If the Primary Supervisor Only option is selected in HESA Returns Setup, the primary flag of the Research Supervisor record is set.
 - If the Primary Supervisor Only option is *not* selected in HESA Returns Setup, the Supervision Percentage value is greater than zero.
 - If at least one Supervisor Role is defined in HESA Returns Setup, the Supervisor Role matches one of the setup values. If no Supervisor Roles are setup for the return, all roles are considered.
 - The supervisor status matches one of the values defined in HESA Returns Setup.
 - The end date of the supervisor record is not prior to the reporting period start date.
 - The begin date of the supervisor record is not after the reporting period end date.
 - At least one Advisor HESA Data record exists for the supervisor. If no records are found a message is logged.

2. For each selected advisor, the advisor percentage is adjusted to ensure that the total percentage for all selected advisors is 100.
3. Advisor HESA Data records are selected for each supervisor to create the REF Data entities:
 - If more distinct units are defined than allowed for the entity, a message is logged.
 - For each Advisor HESA Data record a weighted percentage is calculated based on the unit percentage and the supervisor's adjusted supervision percentage.
 - If the same REF Unit exists for more than one supervisor the records are merged into a single entity and the weighted percentages added together.
 - If the total of all the UAOPCNT values does not equal exactly 100 because of rounding during the calculation of adjusted and weighted percentages, the largest value is adjusted to ensure the total is 100.

Deriving records from Student Advisor/Advisor HESA data (step 3)

1. Student advisors are selected from the most recent effective dated record where the date is on or before the reporting period end date and all of the following conditions are met:
 - The Advisor Role defined matches one of the roles defined on the HESA Returns page.
 - The Academic Career and Academic Program match the career and program of the Instance being reported.
 - If the Primary Advisor Only option is selected in HESA Returns Setup, the advisor number is 1.
 - If the Primary Advisor Only option is NOT selected in HESA Returns Setup, the Percentage value is greater than zero.
 - At least one Advisor HESA Data record exists for the advisor. If no records are found a message is logged.
2. For each selected advisor, the advisor percentage is adjusted to ensure that the total percentage for all selected advisors is 100.
3. Advisor HESA Data records are selected for each advisor to create the REF Data entities:
 - If more distinct units are defined than allowed for the entity, a message is logged.
 - For each Advisor HESA Data record a weighted percentage is calculated based on the unit percentage and the advisor's adjusted percentage.
 - If the same REF Unit exists for more than one advisor the records are merged into a single entity and the weighted percentages added together.
 - If the total of all the UAOPCNT values does not equal exactly 100 because of rounding during the calculation of adjusted and weighted percentages, the largest value is adjusted to ensure the total is 100.

Collaborating Provider (COLPROV)

Return: Student Record

Entity: REF Data

Pages Used:

Page	Page Element
HESA Instance	Collaborating Provider (Research Data region)
Advisor HESA Data	Collaborating Provider

Field Derivation Rule: Include for all entities.

Derivation Steps:

1. If the entity is derived from HESA Instance Data and a collaborating provider is defined, derive the value.
2. If the entity is derived from Research Supervisor/Advisor HESA Data and a collaborating provider is defined, derive the value. However, if multiple Advisor HESA Data records with the same REF Unit are merged and different collaborating providers are defined, then derive the first code in alphabetic order.
3. If the entity is derived from Student Advisor/Advisor HESA Data, derive collaborating provider. However, if multiple Advisor HESA Data records with the same REF Unit are merged and different collaborating providers are defined, then derive the first code in alphabetic order.

RAE Unit of Assessment (OUA2008)

Return: Student Record

Entity: RAE Data

Pages Used:

Page	Page Element
HESA Instance	RAE Unit of Assessment
Advisor HESA Data (Curriculum Management, Instructor/Advisor Information, Instructor/Advisor Table, Advisor HESA Data)	RAE Unit of Assessment
Student Advisor (Records and Enrollment, Student Background Information, Student Advisor)	Academic Advisor

Field Derivation Rule: Include for all RAE Data entities.

Derivation Steps:

1. If the entity is derived from Instance HESA Data - Research Data record, derive from the HESA Instance page.
2. If the entity is derived from Advisor HESA Data record, derive from the Advisor HESA Data page.

REF Unit of Assessment (UOA2021)

Return: Student Record

Entity: REF Data

Pages Used:

Page	Page Element
HESA Instance	REF Unit 2021
Advisor HESA Data (Curriculum Management, Instructor/Advisor Information, Instructor/Advisor Table, Advisor HESA Data)	REF Unit 2021

Field Derivation Rule: Include for all entities.

Derivation Steps:

1. If the entity is derived from HESA Instance Data - Research Data record, derive as REF Unit 2021.
2. If the entity is derived from Advisor HESA Data record, derive as REF Unit 2021.
3. If the entity is derived from Student Advisor HESA Data record, derive as REF Unit 2021.
4. Derive as NULL ERROR.

Unit of Assessment Percentage (UOAPCNT)

Return: Student Record

Entity: REF Data

Pages Used:

Page	Page Element
HESA Instance	Unit Of Assessment Percentage
Advisor HESA Data (Curriculum Management > Instructor/Advisor Information > Instructor/Advisor Table > Advisor HESA Data)	Unit Of Assessment Percentage

Page	Page Element
Student Advisor (Records and Enrollment, Student Background Information, Student Advisor)	Academic Advisor

Field Derivation Rule: Include for all REF Data entities.

Derivation Steps:

1. If the entity is derived from Instance HESA Data - Research Data record, derive from the HESA Instance page.
2. If the entity is derived from Research Supervisor/Advisor HESA Data, derive from the Advisor HESA Data page weighted for multiple supervisors.
3. If the entity is derived from Student Advisor/Advisor HESA Data record, derive from the Advisor HESA Data page.

REF Unit of Assessment (UOA2014)

Return: Student Record

Entity: REF Data

Pages Used:

Page	Page Element
HESA Instance	REF Unit of Assessment
Advisor HESA Data (Curriculum Management, Instructor/Advisor Information, Instructor/Advisor Table, Advisor HESA Data)	REF Unit of Assessment

Field Derivation Rule: Include for all REF Data entities.

Derivation Steps:

1. If the entity is derived from Instance HESA Data - Research Data record, derive from the HESA Instance page.
2. If the entity is derived from Research Supervisor/Advisor HESA Data, derive from Advisor HESA Data page.
3. If the entity is derived from Student Advisor/Advisor HESA Data record, derive from the Advisor HESA Data page.

Student Record Return: Learner Employment Status Entity

For each Instance entity, the Create Extract process creates Learner Employment Status entities when all of the following conditions are met:

- Country = England
- You have selected the Include FE check box on the HESA Returns page
- Instance.FESTUMK = 1, 3 or 4 AND Instance.REDUCEDI = 00 or 01 AND Instance.FUNDMODEL is between 25 and 99 inclusive

The Learner Employment Status entities are created based on Employment Status records defined on the Further Education page, starting with the record with the lowest Record Number value. There is no limit on the number of entities. If records are not defined on the page, then the process does not create the entities.

Date Employment Status Applies To (DATEEMPSTATAPP)

Return: Student Record

Entity: Learner Employment Status

Page Used:

Page	Page Element
Further Education (Records and Enrollment, Career and Program Information, HESA Instance Details, Further Education)	Status Date

Field Derivation Rule: Include for all Instance entities.

Derivation Steps:

1. Derive from the Further Education page, converted to YYYY-MM-DD format.

Employer Identifier (EMPID)

Return: Student Record

Entity: Learner Employment Status

Page Used:

Page	Page Element
Further Education (Records and Enrollment, Career and Program Information, HESA Instance Details, Further Education)	Employer ID

Field Derivation Rule: Include for all Instance entities.

Derivation Steps:

1. Derive from the Further Education page.
2. Derive as *NULL ERROR* if one of the following conditions is met:
 - Instance.PROGTYPE = 02, 03, 20, 21, 22, 23, or 25
 - Instance.FUNDMODEL = 70 or 99
3. Do not derive a value and leave the field blank.

Employment Status (EMPSTAT)

Return: Student Record

Entity: Learner Employment Status

Page Used:

Page	Page Element
Further Education (Records and Enrollment, Career and Program Information, HESA Instance Details, Further Education)	Employment Status

Field Derivation Rule: Include for all Instance entities.

Derivation Steps:

1. Derive from the Further Education page.

ILR Agreement Identifier (ILRAGREEID)

Return: Student Record

Entity: Learner Employment Status

Page Used:

Page	Page Element
Further Education (Records and Enrollment, Career and Program Information, HESA Instance Details, Further Education)	Agreement ID

Field Derivation Rule: Derive a value if all conditions are met:

- Instance.FUNDMODEL = 36

- A LearningDeliveryFAM entity exists for the Instance with LEARNDELFAMTYPE = ACT and LEARNDELFAMCODE = 1

Derivation Steps:

1. Derive from the Further Education page.
2. Derive as NULL ERROR.

Workplace Location Postcode (WORKLOCPOSTCODE)

Return: Student Record

Entity: Learner Employment Status

Page Used:

Page	Page Element
Further Education (Records and Enrollment, Career and Program Information, HESA Instance Details, Further Education)	Workplace Postcode

Field Derivation Rule: Include for all Instance entities.

Derivation Steps:

1. Derive from the Further Education page.

Formatting: If the value is more than four continuous characters, add a space before the final three characters of the postcode.

2. If Instance.PROGTYPE = 02, 03, 10, 20 or 21 or Instance.FUNDMODEL = 45, do not derive a value, leave the field blank and set Reason For Null = 1.
3. Do not derive a value and leave the field blank.

Student Record Return: Employment Status Monitoring Entity

For each Employment Status entity created, the Create Extract process creates Employment Status Monitoring entities. The Employment Status Monitoring entities are created based on the Employment Monitoring records defined on the Further Education page, starting with the record with the lowest Record Number value. If records are not defined on the page, then the process does not create the entities.

Employment Status Monitoring Code (ESMCODE)

Return: Student Record

Entity: Employment Status Monitoring

Page Used:

<i>Page</i>	<i>Page Element</i>
Further Education (Records and Enrollment, Career and Program Information, HESA Instance Details, Further Education)	Code (in the Employment Monitoring region)

Field Derivation Rule: Include for all Employment Status entities.

Derivation Steps:

1. Derive from the Further Education page.

Employment Status Monitoring Type (ESMTYPE)

Return: Student Record

Entity: Employment Status Monitoring

Page Used:

<i>Page</i>	<i>Page Element</i>
Further Education (Records and Enrollment, Career and Program Information, HESA Instance Details, Further Education)	Type (in the Employment Monitoring region)

Field Derivation Rule: Include for all Employment Status entities.

Derivation Steps:

1. Derive from the Further Education page.

Student Record Return: Learner FAM Entity

For each Instance entity, the Create Extract process creates Learner Funding and Monitoring (FAM) entities when:

- Country = England
- Instance.FESTUMK = 1, 3, 4, or 5
- Instance.REDUCEDI = 00 or 01
- Include FE check box is selected on the HESA Returns page

The Learner Funding and Monitoring entities are created based on the Learner records defined on the Further Education page. A maximum of 15 records can be defined. If records are not defined on the page, then the process does not create the entities.

Learner Funding and Monitoring Code (LEARNFAMCODE)

Return: Student Record

Entity: Learner FAM

Page Used:

Page	Page Element
Further Education (Records and Enrollment, Career and Program Information, HESA Instance Details, Further Education)	Code (in the Learner region)

Field Derivation Rule: Include for all Instance entities.

Derivation Steps:

1. Derive from the Further Education page.

Learner Funding and Monitoring Type (LEARNFAMTYPE)

Return: Student Record

Entity: Learner FAM

Page Used:

Page	Page Element
Further Education (Records and Enrollment, Career and Program Information, HESA Instance Details, Further Education)	Type (in the Learner region)

Field Derivation Rule: Include for all Instance entities.

Derivation Steps:

1. Derive from the Further Education page.

Student Record Return: Learning Delivery FAM Entity

For each Instance entity, the Create Extract process creates Learner Delivery Funding and Monitoring entities when:

- Country = England
- Instance.FESTUMK = 1, 3, 4, or 5
- Instance.REDUCEDI = 00 or 01

- Include FE check box is selected on the HESA Returns page

The Learner Delivery Funding and Monitoring entities are created based on the Learning Delivery records defined on the Further Education page. A maximum of 15 records can be defined. If records are not defined on the page, then the process does not create the entities.

Student Record Return: Learning Delivery Funding and Monitoring Code (LEARNDELFAMCODE)

Return: Student Record

Entity: Learning Delivery FAM

Page Used:

Page	Page Element
Further Education (Records and Enrollment, Career and Program Information, HESA Instance Details, Further Education)	Code (in the Learning Delivery region)

Field Derivation Rule: Include for all Instance entities.

Derivation Steps:

1. Derive from the Further Education page.

Learning Delivery Funding and Monitoring Date Applies From (LEARNDELFAMFROM)

Return: Student Record

Entity: Learning Delivery FAM

Page Used:

Page	Page Element
Further Education (Records and Enrollment, Career and Program Information, HESA Instance Details, Further Education)	Date From (in the Learning Delivery region)

Field Derivation Rule: Derive a value if LearningDeliveryFAM.LEARNDELFAMTYPE = LSF, ACT, or ALB. Otherwise, do not derive a value and leave the field blank.

Derivation Steps:

1. Derive from the Further Education page in the format YYYY-MM-DD.
2. Derive as *NULL ERROR*.

Learning Delivery Funding and Monitoring Date Applies To (LEARNDELFACTO)

Return: Student Record

Entity: Learning Delivery FAM

Page Used:

Page	Page Element
Further Education (Records and Enrollment, Career and Program Information, HESA Instance Details, Further Education)	Date To (in the Learning Delivery region)

Field Derivation Rule: Derive a value if LearningDeliveryFAM.LEARNDELFACTOTYPE = LSF, ACT, or ALB. Otherwise, do not derive a value and leave the field blank.

Derivation Steps:

1. Derive from the Further Education page in the format YYYY-MM-DD.
2. Derive as *NULL ERROR*.

Learning Delivery Funding and Monitoring Type (LEARNDELFACTOTYPE)

Return: Student Record

Entity: Learning Delivery FAM

Page Used:

Page	Page Element
Further Education (Records and Enrollment, Career and Program Information, HESA Instance Details, Further Education)	Type (in the Learning Delivery region)

Field Derivation Rule: Include for all Instance entities.

Derivation Steps:

1. Derive from the Further Education page.

Student Record Return: Learning Delivery Work Placement Entity

For each Instance entity, the Create Extract process creates Learning Delivery Work Placement entities when:

- Country = England
- Instance.FESTUMK = 1, 3 or 4
- Instance.REDUCEDI = 00 or 01
- Instance.COMDATE is on or after 2014-08-01
- Instance.FUNDMODEL is not 99
- Include FE check box is selected on the HESA Returns page

Entities are created based on placement records defined in HESA Instance Data, Further Education, Work Placement.

Records are not considered if the end date is earlier than the reporting period start date or the start date is after the reporting period end date.

Work Placement Employer Identifier (LEARNWORKEMPID)

Return: Student Record

Entity: Learning Delivery Work Placement

Page Used:

<i>Page</i>	<i>Page Element</i>
Further Education (Records and Enrollment, Career and Program Information, HESA Instance Details, Further Education)	Employer ID (in the Work Placement region)

Field Derivation Rule: Include for all entities.

Derivation Steps:

1. Derive from Further Education.
2. Derive as null.

Work Placement End Date (LEARNWORKEND)

Return: Student Record

Entity: Learning Delivery Work Placement

Page Used:

Page	Page Element
Further Education (Records and Enrollment, Career and Program Information, HESA Instance Details, Further Education)	End Date (in the Work Placement region)

Field Derivation Rule: Include for all entities.

Derivation Steps:

1. Derive from Further Education, converted to YYYY-MM-DD.
2. Derive as null.

Work Placement End Date (LEARNWORKEND)

Return: Student Record

Entity: Learning Delivery Work Placement

Page Used:

Page	Page Element
Further Education (Records and Enrollment, Career and Program Information, HESA Instance Details, Further Education)	End Date (in the Work Placement region)

Field Derivation Rule: Include for all entities.

Derivation Steps:

1. Derive from Further Education, converted to YYYY-MM-DD.
2. Derive as null.

Work Placement Hours (LEARNWORKHOURS)

Return: Student Record

Entity: Learning Delivery Work Placement

Page Used:

Page	Page Element
Further Education (Records and Enrollment, Career and Program Information, HESA Instance Details, Further Education)	Hours (in the Work Placement region)

Field Derivation Rule: Include for all entities.

Derivation Steps:

1. Derive from Further Education.
2. Derive as NULL ERROR.

Work Placement Start Date (LEARNWORKSTART)

Return: Student Record

Entity: Learning Delivery Work Placement

Page Used:

Page	Page Element
Further Education (Records and Enrollment, Career and Program Information, HESA Instance Details, Further Education)	Start Date (in the Work Placement region)

Field Derivation Rule: Include for all entities.

Derivation Steps: Derive from Further Education, converted to YYYY-MM-DD.

Student Record Return: Financial Support Entity

For each Instance entity, the Create Extract process can create up to four Financial Support entities when Country = England.

The Financial Support entity depends on the following instance fields for selecting data:

- Instance.FEEELIG
- Instance.FUNDCODE
- Course.COURSEAIM

The process creates the extract records (SSR_HE_FS_EXT, SSR_HE_FS_EX_FL) only if you have selected the Include Student entities check box on the Create Extract Data page.

For each Instance (with a HUSID and NUMHUS) in the Instance Extract table that the process selects (that is, Instance with status of ACTIVE):

If the following conditions are all met, the process creates Financial Support entities based on the records defined in HESA Instance Data record:

- Country = England
- Instance.REDUCEDI = 00 or 01

- Instance.FEEELIG = 1
- Related Course.COURSEAIM begins with H, I, J C or is M22, M26, M28, M71, M73, or M88
- Instance.EXCHANGE is not 4, G or Z
- Instance.MODE is not 51, 63, or 64

If all the conditions are not met, a Financial Support entity is not required and the process skips to the next Instance.

Note: For England, the system derives the FUNDCODE only when Instance.FESTUMK is not 1 or 4. The system also checks whether the derived values are blank so that Financial Support entities can be derived when FESTUMK is 1 or 4.

Access and Participation Spending Commitment (APPSPEND)

Return: Student Record

Entity: Financial Support

Page Used:

Page	Page Element
HESA Instance (Financial Support region)	Access Spending

Field Derivation Rule: Include for all Instance entities.

Derivation Steps:

1. Derive from the HESA Instance page.
2. Derive as null.

Financial Support Amount (FINAMOUNT)

Return: Student Record

Entity: Financial Support

Page Used:

Page	Page Element
HESA Instance (Financial Support region)	Amount

Field Derivation Rule: Include for all Instance entities.

Derivation Steps:

1. Derive from the HESA Instance page.

Note: Values to be returned in pounds (£).

A FINAMOUNT value is required to define a Financial Support record in HESA Instance record.

Financial Support Type (FINTYPE)

Return: Student Record

Entity: Financial Support

Page Used:

<i>Page</i>	<i>Page Element</i>
HESA Instance (Financial Support region)	Type

Field Derivation Rule: Include for all Instance entities.

Derivation Steps:

1. Derive from the HESA Instance page.

Note: A FINTYPE value is required to define a Financial Support record in HESA Instance record.

Student Record Return: ITT Placement

The ITT Placement entity depends on the following instance fields to select data:

- Instance.ENTRYRTE
- Instance.REDUCEDI

The Create Extract process creates the extract records if you select the **Include Student Entities** check box on the Create Extract Data page.

If you do not select **Retain Data from Previous Run**, existing extract records are deleted regardless of their status.

For each instance (with a HUSID and NUMHUS) in the Instance Extract table that the process selects (that is, instance with status of ACTIVE), the following conditions must be met (Instance.ENTRYRTE is not null *and* Instance.REDUCEDI = 00, 01, or 04) so that:

- Placement entities are created based on the records defined for the most recent effective-dated HESA Instance Data record where the effective date is not after the reporting period end date, that is, not a future date.
- Only records with a Start Date that falls within the reporting period are selected.

If the conditions are not met, an ITT Placement entity is not required and the process skips to the next instance.

Number of days Spent in Placement School (PLMNTDYS)

Return: Student Record

Entity: ITT Placement

Page Used:

Page	Page Element
HESA Instance (ITT Placement region)	Days

Field Derivation Rule: Include for all Instance entities.

Derivation Steps: Derive value from HESA Instance page.

Placement School (PLMNTSCH)

Return: Student Record

Entity: ITT Placement

Page Used:

Page	Page Element
HESA Instance (ITT Placement region)	School URN

Field Derivation Rule: Include for all Instance entities.

Derivation Steps: Derive value from HESA Instance page.

Student Record Return: Placement

The ITT Placement entity depends on the Student entity. The Selection logic is as follows:

- If **Retain Data from Previous Run** is selected,
 - Delete any existing extract record for the Return with status *INACTIVE*.
 - Update any existing extract record for the Return with status of *ACTIVE*, then set its status to *INACTIVE*.
- If **Retain Data from Previous Run** is not selected, delete all existing extract records for the Return irrespective of status.
- For all Student entity records with status *ACTIVE*,

- Placement entities are created based on the ITT Placement records (SSR_HE_INST_PLC) defined for the most recent effective-dated HESA Instance Data record, where the effective date is not beyond the reporting period end date (not a future reporting period). A maximum of 5 ITT Placement records can be defined in a HESA instance.
- Only records with Start Dates that fall within the reporting period are selected.
- No entities are created if relevant Placements records are not found.

Note: In the Student return, ITT Placement is only reported where ENTRYRTE = 01. The ITT return allows ENTRYRTE a subset of the codes allowed for the Student return: 01 (Provider-led), 02 (School Direct tuition fee), 03 (School Direct salaried), 09 (Undergraduate Opt-in).

The ITT Placement entity contains two fields.

Placement School

Return: ITT

Entity: ITT Placement

Page Used:

Page	Page Element
HESA Instance Data (ITT Placement)	School URN

Field Derivation Rule: Include for all Instance entities.

Derivation Step: Derive the value from the HESA Instance Data – ITT Placement.

Derivation Note: A required field on the page. Valid values are 1 to 999999.

Number of Days Spent in Placement School

Return: ITT

Entity: ITT Placement

Page Used:

Page	Page Element
HESA Instance Data (ITT Placement)	Days

Field Derivation Rule: Include for all Instance entities.

Derivation Step: Derive the value from the HESA Instance Data – ITT Placement.

Derivation Note: A required field on the page. Valid values are 1 to 999.

Student Record Return: Mobility Entity

For each Instance entity, the Create Extract process can create unlimited number of Mobility entities.

The process creates the mobility extract records (SSR_HE_MB_EXT, SSR_HE_MB_EX_FL) only if you have selected the Include Student entities check box on the Create Extract Data page.

If the Retain Data from Previous Run check box is selected on the Create Extract Data page, the process:

- Deletes any existing extract records for the return with status of INACTIVE.
- Updates any existing extract records for the return with status of ACTIVE and sets status of these records to INACTIVE.

If Retain Data from Previous Run is not selected, the process deletes existing extract records of any status for the return.

For each Instance (with a HUSID and NUMHUS) in the Instance Extract table for this run of the return (that is, with status of ACTIVE), if Instance.LOCSDY = T, U, or Z and Instance.REDUCEDI = 00 or 01:

- The process creates Mobility entities based on the records defined for the most recent effective dated HESA Instance Data record where the effective date is not after the reporting period end date (that is, not in future).
- The process selects only records that cover some or all of this reporting period based on the Mobility Start and End, where either:

The Start Date or the End Date falls within the reporting period

Or the Start Date is before the reporting period start date and the End Date is after the reporting period end date.

- The process selects only non-UK records whose location code is *not* XF, XG, XH, XI, XK, XL, JE, GG or IM.
- If either the Start Date or the End Date is outside of the reporting period (that is, overlapping) the process includes the record only if one of these conditions is met:
 - The duration in this reporting period is 25 days or more (that is, 4 weeks or more)
 - The duration in this reporting period is less than 25 days and more than half of the total number of days are in this reporting period: That is, this is the major part of the duration, the minor part is in the next or previous period and will be added to this. If the major part is in the next or previous reporting period and the duration of this minor part is less than 24 days then the process does not include the record because those days will be added to the major part.
 - The duration in this reporting period is less than 25 days and exactly half of the days are in this reporting period and the start date is in this reporting period. That is, for an exact split between periods where both parts are less than 25 days, the record is included in the first period only and all the days reported there.

For each Instance (with a HUSID and NUMHUS) in the Instance Extract table for this run of the return (that is, with status of ACTIVE), if Instance.LOCSYD is not equal to T or U and Instance.REDUCEDI is not equal to 00 or 01, then process does not create the Mobility entity and skips to the next Instance.

Mobility Duration (MOBDURA)

Return: Student Record

Entity: Mobility

Page Used:

Page	Page Element
Mobility (Records and Enrollment, Career and Program Information, HESA Instance Details, Mobility)	Start Date and End Date

Field Derivation Rule: Include for all Instance entities.

Derivation Steps:

1. If the Start and End Date both fall within the reporting period (that is, not overlapping), derive as the total number of days converted to weeks. Days are converted to weeks by dividing by 7 and rounding to the nearest week; 4 days is rounded up; 3 days is rounded down.
2. For overlapping records the total number of days is calculated as:
 - Number of days that fall in this reporting period. That is, days from the Start Date or reporting period start (whichever is later) until the End Date or reporting period end (whichever is earlier).
 - If the Start Date is before the reporting period and the number of days in the preceding period is between 1 and 24 inclusive, those days are added to the total.
 - If the End Date is after the reporting period and the total number of days in the following period is between 1 and 24 inclusive, those days are added to the total.

Derive as total number of days converted to weeks

Mobility Location (MOBLOCA)

Return: Student Record

Entity: Mobility

Page Used:

Page	Page Element
Mobility (Records and Enrollment, Career and Program Information, HESA Instance Details, Mobility)	Location

Field Derivation Rule: Include for all Instance entities.

Derivation Steps:

1. Derive from the Mobility page.

Mobility Scheme (MOBScheme)

Return: Student Record

Entity: Mobility

Page Used:

<i>Page</i>	<i>Page Element</i>
Mobility (Records and Enrollment, Career and Program Information, HESA Instance Details, Mobility)	Scheme

Field Derivation Rule: Include for all Instance entities.

Derivation Steps:

1. Derive from the Mobility page.

Mobility Type (MOBTYPE)

Return: Student Record

Entity: Mobility

Page Used:

<i>Page</i>	<i>Page Element</i>
Mobility (Records and Enrollment, Career and Program Information, HESA Instance Details, Mobility)	Type 1

Field Derivation Rule: Include for all Instance entities.

Derivation Steps:

1. Derive from the Mobility page.

Mobility Type (MOBTYPE2, MOBTYPE3)

Return: Student Record

Entity: Mobility

Page Used:

Page	Page Element
Mobility (Records and Enrollment, Career and Program Information, HESA Instance Details, Mobility)	Type 2 and Type 3

Field Derivation Rule: Include for all Instance entities.

Derivation Steps:

1. Derive from the Mobility page.
2. Do not derive a value and leave the field blank.

Aggregate Offshore Return: Institution Entity

The Create Extract process creates a single entity record for the institution with the **RECID** and **UKRPN** fields.

Record Type Indicator (RECID)

Return: Aggregate Offshore

Entity: Institution

Pages Used:

Page	Page Element
Reporting Period	Record Year
Returns	Record ID

Field Derivation Rule: Include for all Institution entities.

Derivation Steps:

1. Derive as YYNNN, where *YY* is the final two digits of the Record Year (for example, 09 for 2009) and *NNN* is the 3-digit Record ID for the seeded return.
2. Derive as *NULL ERROR*.

For Aggregate Offshore Return, the Record ID must be 052. The Record ID is delivered with the CS updates of April 2009.

UK Provider Reference Number (UKPRN)

Return: Aggregate Offshore

Entity: Institution

Page Used:

Page	Page Element
HESA Configuration	UKPRN

Field Derivation Rule: Include for all Institution entities.

Derivation Steps:

1. Derive from the HESA Returns page.
2. Derive as *NULL ERROR*.

Aggregate Offshore Return: Provision Entity

The Create Extract process creates Provision entities for Offshore plans and Offshore subplans. That is, the process selects only those subplans for which the **Offshore Sub-Plan** check box is selected on the Sub-Plan HESA page. If you have selected the **Enable Sub-Plan Reporting** check box on the HESA Returns page, the process selects only those subplans for which you have selected the **Report to HESA** and **Offshore Sub-Plan** check boxes on the Sub-Plan HESA Data page. Also, the process selects only those plans for which the **Offshore Plan** check box is selected on the Plan HESA Data page. If you have not selected the **Enable Sub-Plan Reporting** check box, the process selects only those plans for which you have selected the **Report to HESA** and **Offshore Plan** check boxes on the Plan HESA Data page.

Country of Activity (COUNTRY)

Return: Aggregate Offshore

Entity: Provision

Pages Used:

Page	Page Element
Plan HESA Data	COUNTRY
Sub-Plan HESA	COUNTRY

Field Derivation Rule: Include for all Provision entities.

Derivation Steps:

1. Use constant.
2. If Provision entity is based on a subplan, derive from the Sub-Plan HESA page.

3. Derive from the Plan HESA Data page.
4. Use default.
5. Derive as *NULL ERROR*.

Institutions Own Campus Identifier (INSTCAMP)

Return: Aggregate Offshore

Entity: Provision

Pages Used:

Page	Page Element
Campus (Records and Enrollment > HESA Reporting > Codes and Mappings > Code Mappings > Campus)	HESA Institutions Own Campus
Taxonomy/Campus (Set Up SACR > Foundation Tables > Academic Structure > Academic Program Table > Taxonomy/Campus)	Campus

Field Derivation Rule: Include for all Provision entities.

Derivation Steps:

1. Use constant.
2. If Provision entity is based on a subplan, select the associated program's campus from the Taxonomy/Campus page. Use the HESA Institutions Own Campus value mapped to the selected campus.
3. If Provision entity is based on a plan, select the associated program's campus from the Taxonomy/Campus page. Use the HESA Institutions Own Campus value mapped to the selected campus.
4. Use default.
5. Do not derive a value and leave the field blank.

Level of Provision (LEVEL)

Return: Aggregate Offshore

Entity: Provision

Pages Used:

Page	Page Element
Plan HESA Data	LEVEL

<i>Page</i>	<i>Page Element</i>
Sub-Plan HESA	LEVEL

Field Derivation Rule: Include for all Provision entities.

Derivation Steps:

1. Use constant.
2. If Provision entity is based on a subplan, derive from the Sub-Plan HESA page.
3. Derive from the Plan HESA Data page.
4. Use default.
5. Derive as *NULL ERROR*.

Number of Students (HEADCOUNT)

Return: Aggregate Offshore

Entity: Provision

Field Derivation Rule: Include for all Provision entities.

Derivation Steps:

1. Derive this value by performing a similar selection as for the existing Instance return but restricting the selection to the plan and subplan of each Provision entity. The return will contain just the count. However, in the log file list each student included in the count including their EMPLID, and plan or subplan.
2. If students are not found, derive as *0*.

In the first step, the process includes students who have a plan or subplan that overlap the reporting period and have been enrolled; that is, the student either has a status of *Enrolled* or has an associated enrolled classes that the student enrolled on or before reporting period end date

Note: If the process does not return a HEADCOUNT value for the plan or subplan, include the student in the extract but do not include the student in the XML file.

Type of Activity (TYPE)

Return: Aggregate Offshore

Entity: Provision

Pages Used:

Page	Page Element
Plan HESA Data	TYPE
Sub-Plan HESA	TYPE

Field Derivation Rule: Include for all Provision entities.

Derivation Steps:

1. Use constant.
2. If Provision entity is based on a subplan, derive from the Sub-Plan HESA page.
3. Derive from the Plan HESA Data page.
4. Use default.
5. Derive as *NULL ERROR*.

ITT Return: Institution Entity

The Create Extract process creates a single entity record for the institution with the **RECID** and **UKRPN** fields.

Record Type Indicator (RECID)

Return: ITT

Entity: Institution

Pages Used:

Page	Page Element
Reporting Period	Record Year
Returns	Record ID

Field Derivation Rule: Include for all Institution entities.

Derivation Steps:

1. Derive as YYNNN, where *YY* is the final two digits of the Record Year (for example, 09 for 2009) and *NNN* is the 3-digit Record ID for the seeded return.
2. Derive as *NULL ERROR*.

For ITT Return, the Record ID is 053 which is delivered with Campus Solutions.

UK Provider Reference Number (UKPRN)

Return: ITT

Entity: Institution

Page Used:

Page	Page Element
HESA Configuration	UKPRN

Field Derivation Rule: Include for all Institution entities.

Derivation Steps:

1. Derive from the HESA Returns page.
2. Derive as *NULL ERROR*.

ITT Return: Student Entity

The Create Extract process creates ITT Student entities only if all the following conditions are satisfied:

- Report to HESA check box is selected on the HESA Instance page for the HESA Instance record.
- The student's program commencement date is before or within the reporting period.
- Either: (a) the student has been term activated for a term that begins within the reporting period and the student has at least one enrolled class related to that term or (b) the student has an FTE value of greater than zero for the reporting period. The process determines the FTE value for the reporting period from the HESA Instance record as either the Override FTE value or else the Calculated FTE value.
- The most recent effective dated Student Program stack record has a Program Status matching one of the Eligible Program Statuses defined for the return on the HESA Returns page.
- The Report to HESA check box is selected and either the derived TTCID value is 1, or the derived TTCIDC value is 01.

Note: Students are not included in the return if TTCID is 0 (zero) or is one of the codes only relevant to the Student return (5, 9, D, F, J, K) or is blank or is *NULL ERROR*.

If all the conditions are satisfied, then the process create a record in the ITT Student Extract table with status set to ACTIVE using the following values:

- EMPLID

- **HUSID:** The process determines this value from External System ID record for the EMPLID, where the ID type is the same as that defined for HUSID on the HESA Types page. If HUSID does not exist, the process creates a new HUSID.
- **NUMHUS (Student Instance Number):** The process determines this value from the HESA Instance record as either Linked Career and Linked Career Number (if defined). Otherwise, it uses a combination of Career and Career Number as the NUHMUS value, that is ACAD_CAREER and STDNT_CAR_NBR. For example, UGRD1.
- **COURSEID:** If a sub-plan is selected as the run parameter, the process uses the Sub-Plan code as the COURSEID, If the subplan is not selected, the process uses the plan code.

If you provided an EMPLID for the Student ID run parameter, the process creates ITT Student entity records for only the selected EMPLID.

The Create Extract process selects External Degree records to derive the degree fields (such as DEGENDDT and DEGEST). If the student has multiple records, the process selects the most recent record.

If you have selected the Null Errors Only check box for the Include Student Entities on the Create Extract Data page, the process selects distinct EMPLIDs from the existing active ITT extract data, where at least one field in the Student or Course Subject extract data has a derived value of *NULL ERROR*. The process then selects Student entity records for these EMPLIDs.

If you have selected the Validation Errors Only check box for the Include Student Entities, the process first deletes any Validation Error staging records where EMPLID is blank. Then, it selects distinct EMPLIDs from the Validation Error staging table. The process selects Student entity records for these EMPLIDs. Finally, it deletes records from the Validation Error staging table where EMPLID is populated.

Allocated Place (ALLPLACE)

Return: ITT

Entity: Student

Page Used:

Page	Page Element
HESA Instance	ALLPLACE

Field Derivation Rule: Include for all Student entities.

Derivation Steps:

1. Use constant.
2. Derive value from HESA Instance page.
3. Use default.
4. Derive as NULL ERROR.

Apply Application ID (APPLYAPPLICATIONID)

Return: ITT

Entity: Student

Pages Used:

Page	Page Element
HESA Instance Data - Entry Profile	APPLYAPPLICATIONID
Application Data (Student Admissions > Application Maintenance > Maintain Applications > Application Data)	External Application Nbr

Field Derivation Rule: Include for all students

Derivation Steps:

1. Derive from HESA Instance Data.
2. Reference the Student Program record for the related instance to find the admission application number (ADM_APPL_NBR). This is then used to reference the admissions data record (ADM_APPL_DATA) to find the external application number (EXT_ADM_APPL_NBR) that holds the application ID plus the choice number for Apply applications. For example, 60018-1.

If the external application number isn't null and doesn't start with UC or GT, then the ID value minus the dash '-' and choice elements is derived: 60018.

3. Derive as null.

Date of Birth (BIRTHDTE)

Return: ITT

Entity: Student

Page Used:

Page	Page Element
Biographical Details (Campus Community > Personal Information (Student) > Add/Update a Person > Biographical Details)	Date of Birth

Field Derivation Rule: Include for all Student entities.

Derivation Steps:

1. Derive from the Biographical Details page in the format YYYY-MM-DD.

2. Derive as *NULL ERROR*.

Bursary Level Award (BURSLEV)

Return: ITT

Entity: Student

Page Used:

Page	Page Element
HESA Instance	BURSLEV

Field Derivation Rule: Include for all Student entities.

Derivation Steps:

1. Use constant.
2. Derive from the HESA Instance page.
3. Use default.
4. Derive as *NULL ERROR*.

Start Date of Instance (COMDATE)

Return: ITT

Entity: Student

Page Used:

Page	Page Element
HESA Instance	Start Date of Instance

Note: This field is included as ITTSTARTDATE in the XML file.

Field Derivation Rule: Include for all Student entities.

Derivation Steps:

1. Derive from the HESA Instance page.
2. If there is a Research Candidate record for the instance:
 - a. Select the Begin Date (SSR_RS_BEGIN_DT) from the most recent active Consumption record where the effective date is on or before the reporting period end date.

- b. Derive the Begin Date formatted to YYYY-MM-DD.
- c. Match the Research Candidate record (SSR_RS_CAND_HDR) to the instance on EMPLID, Institution, Career and Career Number to find the Research Candidate Number (SSR_RS_CANDIT_NBR). If multiple records are found, the record with the highest candidate number is selected.
- d. Associate consumption records (SSR_RS_CONSMPTN) with the Research Candidate record by EMPLID, Institution and Research Candidate Number.

The calculated value is stored in the HESA Instance Data record.

3. Use the following process to calculate the earliest class start date for enrolled classes related to the Instance being reported. This selection is similar to that done for StudentOnModule except that it is not restricted to classes overlapping the reporting period and considers enrollments for linked careers.
 - a. Select all activated terms for the student career of the Instance.
 - b. From each activated term, select classes that satisfy the following conditions:
 - Status = *Enrolled*
 - Units Taken value is greater than zero.
 - Grading basis value matches one of the values defined in the Grading Basis Inclusion region with the Extract check box selected on the HESA Configuration page.
 - Repeat Code value does not exist or does not match a value defined in the Repeat Code Exclusion region with the Extract check box selected on the HESA Configuration page.
 - If the student has multiple careers with the same Academic Career value as the career being processed (that is, the same career value with different career numbers), then apply a further filter to the class enrollments. In such a case, select the class only if the program value of the enrollment record does not exist or matches one of the program values in the Student Program records for that career and career number.
 - c. If the Instance has been linked to a prior student career using the **Linked Career** and **Linked Career Number** fields in the HESA Instance record, then also consider classes for the previous career.
 - d. Derive the earliest Class Start Date from all the selected classes as COMDATE.
4. Derive as the earliest Effective Date of the HESA Instance records.

Course Identifier (COURSEID)

Return: ITT

Entity: Student

Pages Used: None

Field Derivation Rule: Include for all Student entities.

Derivation Steps:

1. If subplan is being reported to HESA, derive as COURSEID from the Academic Sub-Plan Table record.
2. If plan is being reported to HESA, derive as COURSEID from the Academic Plan Table record.

Course Title (CTITLE)

Return: ITT

Entity: Student

Pages Used:

Page	Page Element
Plan HESA Data	Course Title
Sub-Plan HESA	HESA Course Title
Academic Plan Table (Set Up SACR > Foundation Tables > Academic Structure > Academic Plan Table)	Academic Plan
Academic Sub-Plan Table (Set Up SACR > Foundation Tables > Academic Structure > Academic SubPlan Table)	Academic Subplan

Field Derivation Rule: Include for all Student entities.

Derivation Steps:

1. Derive as the HESA Course Title value from the Sub-Plan HESA page.
2. If the **Course Title** field does not have a value, use a combination of the plan and subplan descriptions from the Academic Plan Table and Academic Sub-Plan Table pages (that is, .DESCR from PS_ACAD_PLAN_TBL + space + DESCR from PS_ACAD_SUBPLN_TBL).
3. Derive as the Course Title value from the Plan HESA Data page.
4. If the **Course Title** field does not have a value, use the plan description from the Academic Plan Table page (that is, DESCR from PS_ACAD_PLAN_TBL).

Course Mode (CRMODE)

Return: ITT

Entity: Student

Page Used:

Page	Page Element
HESA Instance	CRMODE

Field Derivation Rule: Include for all Student entities.

Derivation Steps:

1. Derive from the HESA Instance page.
2. Convert the MODE value to a CRMODE value as follows: if MODE = 01, 02, 12, 13, 14, 23, 24, 25, 63 or 73, derive as 1 (full-time) else derive as 2 (part-time).
3. Do not derive a value and leave the field blank.

Disability (DISABILITY TO DISABILITY8)

Return: ITT

Entity: Student

Pages Used:

Page	Page Element
Person HESA Data	DISABILITY to DISABILITY 8
Impairment AUS (Campus Community > Personal Information > Health Information > Impairment AUS)	Type of Impairment
Disability (Records and Enrollment > HESA Reporting > Codes and Mappings > Code Mappings > Disability)	HESA Disability

Field Derivation Rule: Include for all entities.

Derivation Steps:

1. Derive from the Person HESA Data page.
2. If no values are defined in Person HESA Data, derive as the HESA code for each of the mapped Impairment record. Unmapped records aren't considered.
3. Use default, DISABILITY2 to 8 derive as null.
4. Derive as *NULL ERROR*.

Disabled Student Allowance (DISALL)

Return: ITT

Entity: Student

Page Used:

Page	Page Element
HESA Instance	DISALL
Impairment AUS (Campus Community, Personal Information, Health Information, Impairment AUS)	Support Services Request
Disability (Records and Enrollment, HESA Reporting, Codes and Mappings, Code Mappings, Disability)	HESA Disability Allowance

Field Derivation Rule: If related Student.DISABLE is between 02 and 96, derive a value. Otherwise, do not derive a value and leave the field blank.

Derivation Steps:

1. Use constant.
2. Derive from the HESA Instance page.
3. If the student has a Support Services Request value defined on the Impairment AUS page, use the mapped HESA Disability Allowance code from the Disability page.
4. Use default.
5. Derive as *NULL ERROR*.

Discretionary Funding (DISCFUND)

Return: ITT

Entity: Student

Page Used:

Page	Page Element
HESA Instance	DISCFUND

Field Derivation Rule: Include for all Student entities.

Derivation Steps:

1. Use constant.

2. Derive from the HESA Instance page.
3. Use default.
4. Derive as *NULL ERROR*.

Note: DISCFUND is not derived when TTCID = 2. Valid values for DISCFUND are 1 (Received) and 2 (Not received).

Domicile (DOMICILE)

Return: ITT

Entity: Student

Pages Used:

Page	Page Element
Campus Community > Personal Information (Student) > Identification (Student) > Residency Data > Residency Self-Report	Residency Self-Report — State and Country
Entry Profile	DOMICILE

Field Derivation Rule: Include for all Student entities.

Derivation Steps:

1. Derive from the Entry Profile page.
2. Select Residency Self-Report records. If the Country value is not GBR, then select the related two-character code (COUNTRY_2CHAR) from the Country table (PS_COUNTRY_TBL).

If a mapping exists in the HESA Nationality/Domicile Mapping for the Campus Solutions Country code, use the mapped HESA value. Otherwise, use the COUNTRY_2CHAR code.

3. If a Residency Self-Report record exists, Country value is GBR, and State is defined, then map the Country and State to a HESA Country Code in the UCAS APR Mapping. Otherwise, log an error message and derive *XX*.

If State is not defined, report *XX*.

4. Use default.
5. Derive as *NULL ERROR*.

Expected End Date (ENGEXPECTEDENDDATE)

Return: ITT

Entity: Student

Page Used:

Page	Page Element
HESA Instance Data	ENGEXPECTEDENDDATE
Student Program	Expected Graduation Term
Term Table — Attributes (Set Up SACR > Foundation Tables > Term Setup > Term/Session Table > Term Table)	Date attribute for ENGEXPECTEDENDDATE
HESA Returns Setup — Common Attributes	Common Attributes

Note: This is included as EXPECTEDENDDATE in the XML file in a similar way to PGCECLSS in Previous Qualification.

Field Derivation Rule: Include for all entities

Derivation Steps:

1. Derive from the HESA Instance page.
2. Derived as the date attribute for the Expected Graduation Term in the most recent Student Program record converted to the YYYY-MM-DD format.
3. Derive as the Term End Date for the Expected Graduation Term in the most recent Student Program record converted to the YYYY-MM-DD format.
4. Use default.
5. Derive as NULL ERROR.

ITT Entry Route (ENTRYRTEE)

Return: ITT

Entity: Student

Pages Used:

Page	Page Element
Program HESA Data	ENTRYRTEE
Plan HESA Data	ENTRYRTEE
Sub-Plan HESA	ENTRYRTEE

Page	Page Element
HESA Instance	ENTRYRTEE

Field Derivation Rule: Include for all entities

Derivation Steps:

1. Use constant.
2. Derive from HESA Instance page.
3. If Instance.COURSEID is based on a sub-plan, derive value from the Sub-Plan HESA page.
4. Derive value from Plan HESA Data page.
5. Derive value from Program HESA Data page.
6. Use default.
7. Derive as NULL ERROR.

Ethnicity (ETHNICS)

Return: ITT

Entity: Student

Pages Used:

Page	Page Element
Person HESA Data	ETHNICS
Ethnicity (Campus Community > Personal Information (Student) > Biographical (Student) > Personal Attributes > Ethnicity)	Regulatory Region, Ethnic Group
Ethnicity (Records and Enrollment > HESA Reporting > Codes and Mappings > Code Mappings > Ethnicity)	HESA Ethnicity

Field Derivation Rule: Include for all entities.

Derivation Steps:

1. Derive from the Person HESA Data page.
2. Select Person Ethnicity records as follows:
 - If a single record exists, use that record.

- If multiple records exist and one is marked as Primary on the Campus Community Ethnicity page, use that record.
- If multiple records exist and none are marked as Primary, select the record with the highest Percentage defined in the Ethnicity Detail page.
- If multiple records are indistinguishable, select the lowest alphabetic Ethnic Group code.

For the selected record, use the HESA Ethnic code from the mapping between the Ethnic Group, Regulatory Region, and the HESA Ethnic code. If no mapping exists, log an error message and skip to next step.

3. Use default.
4. Derive as *NULL ERROR*.

Forenames (FNAMES)

Return: ITT

Entity: Student

Page Used:

Page	Page Element
Names (Campus Community > Personal Information (Student) > Add/Update a Person > Biographical Details > Names)	First Name Middle Name

Note: The First Name page element can accept a maximum of 30 characters.

Field Derivation Rule: Include for all Student entities.

Derivation Steps:

1. Use the First Name and Middle Name values from the Primary Name record.
2. Derive as NULL.

Fundability Code (FUNDCODE)

Return: ITT

Entity: Student

Pages Used:

Page	Page Element
Program HESA Data	FUNDCODE
Plan HESA Data	FUNDCODE
Sub-Plan HESA	FUNDCODE
HESA Instance	FUNDCODE

Field Derivation Rule: Include for all Student entities.

Derivation Steps:

1. Use constant.
2. Derive from the HESA Instance page.
3. If Student.COURSEID is based on a subplan, derive from the Sub-Plan HESA page.
4. Derive from the Plan HESA Data page.
5. Derive from the Program HESA Data page.
6. Use default.
7. Derive as *NULL ERROR*.

HESA Unique Student Identifier (HUSID/SID)

Return: ITT

Entity: Student

Page Used:

Page	Page Element
External System ID	External System ID

Field Derivation Rule: Include for all students.

Derivation Step:

1. Derive from the most recent non-future external system ID records matched on EMPLID where the ID type is the same as that defined for SID in the HESA configuration record.
2. If an SID isn't found, a new SID is created according to the Create Student Identifiers process, and that value is derived.

If the student has an existing HUSID, that is used to create the SID. Otherwise, a new SID is created.

- a. First two digits: Last two digits of the year from earlier MATR or ACTV row in the student program.
- b. Next eight digits: The provider's UKPRN.
- c. Next 6 digits: The next 6-digit sequence number from HESA configuration. The sequence number is automatically incremented when a value is used.
- d. Last digit: Check digit.

The new SID is stored as an External System ID using the current effective date.

3. Derive as *NULL ERROR*.

Positive Indication that self-certification complete (INDSLFCRT)

Return: ITT

Entity: Student

Page Used:

<i>Page</i>	<i>Page Element</i>
Entry Profile	INDSLFCRT

Field Derivation Rule: If Student.COMDATE is in the current reporting period, derive a value. Otherwise, derive as *NULL ERROR*.

Derivation Step:

1. Derive from the Entry Profile page.
2. Use default.
3. Derive as *NULL ERROR*.

The system always returns a value, because the inclusion condition is always met and while selecting students for the extract, the system considers only those students for whom COMDATE is between reporting period start and end dates.

ITT Initiatives (INITIATIVES-ITT, INITIATIVES-ITT2)

Return: ITT

Entity: Student

Pages Used:

Page	Page Element
Program HESA Data (Program Instance HESA Data)	INITIATIVES-ITT, INITIATIVES-ITT2
Plan HESA Data (Plan Instance HESA Data)	INITIATIVES-ITT, INITIATIVES-ITT2
Sub-Plan HESA (Sub-plan Instance HESA Data)	INITIATIVES-ITT, INITIATIVES-ITT2
HESA Instance	INITIATIVES-ITT, INITIATIVES-ITT2

Field Derivation Rule: Include for all Student entities.

Derivation Steps:

1. Derive from the HESA Instance page.
2. If Instance.COURSEID is based on a subplan, derive from the Sub-Plan HESA page.
3. Derive from the Plan HESA Data page.
4. Derive from the Program HESA Data page.
5. Do not derive a value and leave the field blank.

Independent Safeguarding Authority Registration Number (ISANUM)

Return: ITT

Entity: Student

Page Used:

Page	Page Element
External System ID	External System ID

Field Derivation Rule: Include for all Student entities.

Derivation Steps:

1. Determine from the External System ID records for the person with the External ID Type defined for ISANUM in the HESA Types page.
2. Do not derive a value and leave the field blank.

ITT Qualification Aim (ITTAIM)

Return: ITT

Entity: Student

Pages Used:

Page	Page Element
Program HESA Data	ITTAIM
Plan HESA Data	ITTAIM
Sub-Plan HESA	ITTAIM

Field Derivation Rule: Include for all Student entities.

Derivation Steps:

1. Use constant.
2. If subplan is being reported, derive from the Sub-Plan HESA page.
3. Derive from the Plan HESA Data page.
4. Derive from the Program HESA Data page.
5. Use default.
6. Derive as *NULL ERROR*.

Start Date of ITT Course (ITTCOMDATE)

Return: ITT

Entity: Student

Page Used:

Page	Page Element
HESA Instance	ITTCOMDATE

Note: This field is included as TRAINEESTARTDATE in the XML file.

Field Derivation Rule: Include for all students.

Derivation Steps:

1. Derive from the HESA Instance page.
2. Derive as null.

ITT Phase/Scope (ITTPHSC)

Return: ITT

Entity: Student

Pages Used:

Page	Page Element
Program HESA Data	ITTPhase/Scope
Plan HESA Data	ITTPhase/Scope
Sub-Plan HESA	ITTPhase/Scope
HESA Instance	ITTPhase/Scope

Field Derivation Rule: Include for all Student entities.

Derivation Steps:

1. Use constant.
2. Derive from the HESA Instance page.
3. Derive from the Sub-Plan HESA page.
4. Derive from the Plan HESA Data page.
5. Derive from the Program HESA Data page.
6. Use default.
7. Derive as *NULL ERROR*.

ITT Schemes (ITTSCHMS)

Return: ITT

Entity: Student

Pages Used:

Page	Page Element
Program HESA Data	ITTSCHMS
Plan HESA Data	ITTSCHMS

Page	Page Element
Sub-Plan HESA	ITTSCHMS
HESA Instance	ITTSCHMS

Field Derivation Rule: Include for all Student entities.

Derivation Steps:

1. Use constant.
2. Derive from the HESA Instance page.
3. Derive from the Sub-Plan HESA page.
4. Derive from the Plan HESA Data page.
5. Derive from the Program HESA Data page.
6. Use default.
7. Derive as *NULL ERROR*.

Mode of Study (MODE)

Return: ITT

Entity: Student

Pages Used:

Page	Page Element
Program Offering/Year HESA	MODE (Program Year HESA Data group box)
Plan Offering/Year HESA	MODE (Plan Year HESA Data group box)
Sub-Plan Offering/Year HESA	MODE (Sub-Plan Year Data group box)
Student Program	Program Action Action Reason
Student Program	Acad Load
HESA Instance	MODE

Page	Page Element
Mode of Study (Records and Enrollment > HESA Reporting > Codes and Mappings > Code Mappings > Mode of Study)	HESA Mode of Study
HESA Action Reasons	Change of Mode Mapping

Field Derivation Rule: Include for all Student entities.

Derivation Steps:

1. Derive from the HESA Instance page.
2. Select the Student Program record that has Program Action/Reason values mapped to a HESA Mode in the HESA Action Reasons page. Derive the mapped HESA mode value.

If the derived value is 73 or 74, convert 73 to 63 and 74 to 64.

If the derived value is 01, 12, 13, 14, 23, 24 or 25 (that is, a sandwich placement year), 43, 65, 66, 67, 68, 69, then convert as 01.

If the derived value is 02, derive as 02.

If the derived value is 31, 32, 33, 34, 35, 36, 37, 38, 39, 44, then convert as 31.

3. Select the academic load from the Student Program record. Derive the mapped HESA code for the selected academic load from the Mode of Study page.

If the derived value is 73 or 74, convert 73 to 63 and 74 to 64.

If the derived value is 01, 12, 13, 14, 23, 24 or 25 (that is, a sandwich placement year), 43, 65, 66, 67, 68, 69, then convert as 01.

If the derived value is 02, derive as 02.

If the derived value is 31, 32, 33, 34, 35, 36, 37, 38, 39, 44, then convert as 31.

4. Derive as *NULL ERROR*.

Major Source of Tuition Fees (MSTUFEE)

Return: ITT

Entity: Student

Pages Used:

Page	Page Element
Program HESA Data	MSTUFEE

Page	Page Element
Program Offering/Year HESA	MSTUFEE (Program Offering HESA Data group box)
Plan HESA Data	MSTUFEE
Plan Offering/Year HESA	MSTUFEE (Plan Offering HESA Data group box)
Sub-Plan HESA	MSTUFEE
Sub-Plan Offering/Year HESA	MSTUFEE (Sub-Plan Offering HESA Data group box)
HESA Instance	MSTUFEE

Field Derivation Rule: If Student.TTCID = G or Q, derive a value. Otherwise, do not derive a value and leave the field blank.

Derivation Steps:

1. Use constant.
2. Derive from the HESA Instance page.
3. If Student.COURSEID is based on a subplan, derive from the Sub-Plan Offering/Year HESA page for the academic load of the student instance.
4. If Student.COURSEID is based on a subplan, derive from the Sub-Plan HESA page.
5. Derive from the Plan Offering/Year HESA page for the academic load of the student instance.
6. Derive from the Plan HESA Data page.
7. Derive from the Program Offering/Year HESA page for the academic load of the student instance.
8. Derive from the Program HESA Data page.
9. Use default.
10. Derive as *NULL ERROR*.

Nationality (NATION)

Return: ITT

Entity: Student

Pages Used:

Page	Page Element
Person HESA Data	NATION
Citizenship and Passport (Campus Community , Personal Information (Student), Identification (Student), Citizenship, Citizenship and Passport)	Country

Field Derivation Rule: Include for all Student entities.

Derivation Steps:

1. Derive from the Person HESA Data page.
2. Select person citizenship records and retrieve the related two-character code (COUNTRY_2CHAR) from the Country table (PS_COUNTRY_TBL). If a mapping exists in the HESA Nationality Code page for the Campus Solutions Country code, use the mapped HESA value else use the COUNTRY_2CHAR value.

If a single record exists, derive the Campus Solutions country code or HESA country code.

3. If multiple person citizenship records are found and a record has a value of *GB*, derive as *GB*.
4. If multiple records are found, and none have the *GB* country value but a minimum one record has a country value that is marked as European Union (EU) country then derive the EU country. If there are multiple EU countries report the one with the lowest alphabetic HESA code. Note that the PS_COUNTRY_TBL contains an indicator (EU_MEMBER_STATE) to specify if the country is a member of the EU.
5. If multiple records are found and none have the UK or EU value, select the lowest alphabetic code
6. Use default.
7. Derive as NULL.

In most cases, you can use the Campus Solutions two-character country code to report the NATION value. However, some Campus Solutions country codes are not valid for HESA reporting. For example, the Campus Solutions Cyprus code (CY) cannot be reported. Cyprus has to be reported as *XA*, *XB*, or *XC*. In these cases, you must use the Nationality code mapping page to ensure the correct NATION values are reported to HESA.

National Identity (NATIOND)

Return: Student Record

Entity: Student

Page Used:

Page	Page Element
Person HESA Data	NATIOND

Field Derivation Rule: Include for all Student entities.

Derivation Steps:

1. Derive from the Person HESA Data page.
2. Use default.
3. Derive as NULL.

National Identity (NATIOND2)

Return: Student Record

Entity: Student

Page Used:

Page	Page Element
Person HESA Data	NATIOND2

Field Derivation Rule: Include for all Student entities.

Derivation Steps:

1. Derive from the Person HESA Data page.
2. Use default.
3. Derive as NULL.

National Insurance Number (NIN)

Return: ITT

Entity: Student

Page Used:

Page	Page Element
External System ID	External System ID

Field Derivation Rule: Include for all Student entities.

Derivation Steps:

1. Determine from the External System ID records for the person with the External ID Type defined for NIN in the HESA Types page.
2. Do not derive a value and leave the field blank.

Email Addresses (NQTEMAIL)

Return: ITT

Entity: Student

Page Used:

Page	Page Element
Electronic Addresses	Email Address (preferred)

Field Derivation Rule: Include for all students.

Derivation Steps:

1. Derive from preferred email address defined for the student if the email type is defined in Email Types in HESA Returns Setup.
2. Derive from a non-preferred email address if the email type is defined in Email Types in HESA Returns Setup. If there's more than one record, the record with the lowest alpha type is derived.
3. Derive as null.

Student Instance Identifier (NUMHUS)

Return: ITT

Entity: Student

Page Used:

Page	Page Element
HESA Instance	Instance Identifier Linked Career Linked Career Number Academic Career Student Career Nbr

Field Derivation Rule: Include for all Student entities.

Derivation Steps:

1. Derive from HESA Instance page as Instance Identifier.
2. Derive from HESA Instance page as Linked Career + Linked Career Number.
3. Derive from HESA Instance page as Academic Career + Student Career Nbr, for example, UGRD1.

Institution's Own Identifier for Student (OWNSTU)

Return: ITT

Entity: Student

Pages Used: None

Field Derivation Rule: Include for all Student entities.

Derivation Step:

1. Derive as EMPLID.

Apprenticeship Start Date (PGAPPSTDT)

Return: ITT

Entity: Student

Pages Used:

Page	Page Element
Program HESA Data (Program Instance HESA Data)	PGAPPSTDT
Plan HESA Data (Plan Instance HESA Data)	PGAPPSTDT
Sub-Plan HESA Data (Sub-plan Instance HESA Data)	PGAPPSTDT
HESA Instance Data	PGAPPSTDT

Field Derivation Rule: Include for all entities.

Derivation Steps:

1. Use the value from HESA Instance Data.
2. If COURSEID is based on a sub-plan, use the value from Sub-Plan Instance HESA Data.
3. Derive the value from Plan Instance HESA Data.
4. Derive the value from Program Instance HESA Data

- 5. Use the default value.
- 6. Derive as null.

PGCE Class of Undergraduate Degree (PGCECLSS)

Return: ITT

Entity: Student

Page Used:

Page	Page Element
Entry Profile	PGCECLSS

Field Derivation Rule: Derive a value if the following conditions are met:

- Student.COMDATE is in the current reporting period
- Student.ITTAIM = 110,113, 020, 027 or 031

Derive as *NULL ERROR* if the conditions are not met.

Derivation Steps:

1. Use constant.
2. Derive from the Entry Profile page.
3. Use default.
4. Derive as *NULL ERROR*.

PGCE Subject of Undergraduate Degree (PGCESBJ)

Return: ITT

Entity: Student

Page Used:

Page	Page Element
Entry Profile	PGCESBJ
	PGCESBJ2
	PGCESBJ3

Field Derivation Rule: Derive a value if the following conditions are met:

- Student.COMDATE is in the current reporting period
- Student.ITTAIM = 110,113, 020, 027 or 031

Derive as *NULL ERROR* if the conditions are not met.

Derivation Steps:

1. Use constant to create a single **PGCESBJ** field.
2. Derive from the Entry Profile page.
3. Use default to create a single **PGCESBJ** field.
4. Derive a single **PGCESBJ** field as *NULL ERROR*.

Note: The system can derive up to three values. Each of the values is included as a separate **PGCESBJ** field in the XML file.

Immediately Prior Surname (PSURNAME)

Return: ITT

Entity: Student

Page Used:

Page	Page Element
Names (Campus Community, Personal Information (Student), Add/Update a Person, Biographical Details, Names)	Surname

Field Derivation Rule: If the student has at least one Instance with REDUCEDI = 00, 01, or 04 derive a value. Otherwise, do not derive a value and leave the field blank.

Derivation Steps:

1. Derive the previous Last Name from the Primary Name Type History table. This is done by finding the most recent end dated record in which last name is different from the current one.
2. Do not derive a value and leave the field blank.

Qualification Aim (QLAIM)

Return: ITT

Entity: Student

Page Used:

Page	Page Element
Program HESA Data	QLAIM
Plan HESA Data	QLAIM
Sub-Plan HESA	QLAIM

Field Derivation Rule: Derive a value if Student.ITTAIM = 202.

Derivation Steps:

1. Use constant.
2. If a sub-plan is reported, derive value from Sub-Plan HESA page.
3. Derive value from Plan HESA Data page.
4. Derive value from Program HESA Data page.
5. Use default.
6. Derive as NULL ERROR.

School Direct Employing School (SDEMPLOY)

Return: ITT

Entity: Student

Pages Used:

Page	Page Element
Program HESA Data (Program Instance HESA Data)	SDEMPLOY
Plan HESA Data (Plan Instance HESA Data)	SDEMPLOY
Sub-Plan HESA Data (Sub-plan Instance HESA Data)	SDEMPLOY
HESA Instance Data	SDEMPLOY

Field Derivation Rule: If all the following conditions are met, derive a value:

- Student.ENTRYRTEE = 03, 10, or 13
- Student.MODE isn't 63 or 64

All School Direct trainees should be associated with a lead school. When the lead school does not have a unique reference number (URN), these generic codes are used:

- 900000 — Establishments outside England and Wales
- 900010 — Not applicable nor available

Derivation Steps:

1. Use constant.
2. Derive from HESA Instance Data.
3. If COURSEID is based on a sub-plan, derive from Sub-Plan Instance HESA Data.
4. Derive from Plan Instance HESA Data.
5. Derive from Program Instance HESA Data.
6. Use default.
7. Derive as *NULL ERROR*.

School Direct Lead School (SDLEAD)

Return: ITT

Entity: Student

Pages Used:

Page	Page Element
Program HESA Data (Program Instance HESA Data)	SDLEAD
Plan HESA Data (Plan Instance HESA Data)	SDLEAD
Sub-Plan HESA Data (Sub-plan Instance HESA Data)	SDLEAD
HESA Instance Data	SDLEAD

Field Derivation Rule: If all the following conditions are met, derive a value:

- Student.ENTRYRTEE = 02, 03, 10, 12, or 13
- Student.MODE isn't 63 or 64

All School Direct trainees should be associated with a lead school. When the lead school does not have a unique reference number (URN), these generic codes are used:

- 900000 — Establishments outside England and Wales

- 900010 — Not applicable nor available

Derivation Steps:

1. Use constant.
2. Derive from HESA Instance Data.
3. If COURSEID is based on a sub-plan, derive from Sub-Plan Instance HESA Data.
4. Derive from Plan Instance HESA Data.
5. Derive from Program Instance HESA Data.
6. Use default.
7. Derive as *NULL ERROR*.

Service Leavers (SERLEAVE)

Return: ITT

Entity: Student

Page Used:

Page	Page Element
HESA Instance Data	SERLEAVE

Dependant Fields: **COMDATE, ITTCOMDATE**

Field Derivation Rule: Derive if either COMDATE or ITTCOMDATE is after 2018-07-31. If not, derive as null.

Derivation Steps:

1. Derive the value from the HESA Instance Data page.
2. Use the default.
3. Derive as null.

Sex Identifier (SEXIDS)

Return: ITT

Entity: Student

Page Used:

Page	Page Element
Biographical Details (Campus Community , Personal Information (Student), Add/Update a Person, Biographical Details)	Gender
Gender (Records and Enrollment, HESA Reporting, Codes and Mappings, Code Mappings, Gender)	HESA Sex Identifier
Campus Community, Personal Information, Add/ Update a Person, HESA Student Data Campus Community, Personal Information, Add/Update a Person, HESA Restricted Data	SEXIDS

Field Derivation Rule: Include for all entities.

Derivation Step:

1. Derive from Person HESA Data.
2. Select the Gender value from the Biographical History record. Derive as the mapped HESA value for the selected Gender value.
3. If no mapping is found, then derive as
 - If the gender value is Male, derive as *11*.
 - If the gender value is Female, derive as *10*.
4. Use default.
5. Derive as *NULL ERROR*.

Family Name on 16th Birthday (SNAME16)

Return: ITT

Entity: Student

Page Used:

Page	Page Element
Names (Campus Community, Personal Information (Student), Add/Update a Person, Biographical Details, Names)	Last Name

Note: The Last Name page element can accept a maximum of thirty characters.

Field Derivation Rule: Include for all Student entities.

Derivation Steps:

1. Use the Last Name value from the Primary Name record. The last name must have a Type of Name value that corresponds with the Name Type set for SNAME16 on the HESA Types page.
2. Do not derive a value and leave the field blank.

Expected Length of Study (SLENGTH)

Return: ITT

Entity: Student

Pages Used:

Page	Page Element
Program HESA Data	SLENGTH
Program Offering/Year HESA	SLENGTH (Program Offering HESA Data group box)
Plan HESA Data	SLENGTH
Plan Offering/Year HESA	SLENGTH (Plan Offering HESA Data group box)
Sub-Plan HESA	SLENGTH
Sub-Plan Offering/Year HESA	SLENGTH (Sub-Plan Offering HESA Data group box)
HESA Instance	SLENGTH

Field Derivation Rule: Include for all Student entities.

Derivation Steps:

1. Use constant.
2. Derive from the HESA Instance page.
3. If Student.COURSEID is based on a subplan, derive from the Sub-Plan Offering/Year HESA page for the academic load of the student instance. Only records where Offering Start Term, Offering Start Session and Campus are all blank are considered.
4. If Student.COURSEID is based on a subplan, derive from the Sub-Plan HESA page.
5. Derive from the Plan Offering/Year HESA page for the academic load of the student instance. Only records where Offering Start Term, Offering Start Session and Campus are all blank are considered.
6. Derive from the Plan HESA Data page.

7. Derive from the Program Offering/Year HESA page for the academic load of the student instance.
8. Derive from the Program HESA Data page.
9. Use default.
10. Do not derive a value, leave the field blank and set ReasonForNull = 9 .

Student Accreditation Aim Accreditation Identifier (STUACCID)

Return: ITT

Entity: Student

Pages Used:

<i>Page</i>	<i>Page Element</i>
Program HESA Data	STUACCID
Plan HESA Data	STUACCID
Sub-Plan HESA Data	STUACCID
HESA Instance	STUACCID

Note: This field is included as ITTPHSC in the XML file.

Field Derivation Rule: Include for all entities

Derivation Step:

1. Derive from HESA Instance Data.
2. Derive from Sub-Plan HESA Data.
3. Derive from Plan HESA Data.
4. Derive from Program HESA Data.
5. Derive as NULL ERROR.

Family Name (SURNAME)

Return: ITT

Entity: Student

Page Used:

Page	Page Element
Names (Campus Community, Personal Information (Student), Add/Update a Person, Biographical Details, Names)	Last Name

Note: The Last Name page element can accept a maximum of thirty characters.

Field Derivation Rule: Include for all Student entities.

Derivation Steps:

1. Use the Last Name value from the Primary Name record.
2. Derive as *NULL ERROR*.

Title (TITLE)

Return: ITT

Entity: Student

Page Used:

Page	Page Element
Names (Campus Community > Personal Information (Student) > Add/Update a Person > Biographical Details > Names)	Name Title

Field Derivation Rule: Include for all Student entities.

Derivation Steps:

1. Use the Name Title value from the Primary Name record.
2. Do not derive a value, leave the field blank, and set ReasonForNull = 9.

Teacher Reference Number (TREFNO)

Return: ITT

Entity: Student

Page Used:

Page	Page Element
External System ID	External System ID

Field Derivation Rule: Include for all Student entities.

Derivation Steps:

1. Select External System ID records for the person with the External ID Type defined for TREFNO in the HESA Types page.
2. Use default.
3. Do not derive a value and leave the field blank.

Teacher Training Course (TTCIDC)

Return: ITT

Entity: Student

Pages Used:

Page	Page Element
Program HESA Data	TTCIDC
Plan HESA Data	TTCIDC
Sub-Plan HESA	TTCIDC

Field Derivation Rule: Include for all entities.

Derivation Steps:

1. Derive from the Sub-Plan HESA page.
2. Derive from the Plan HESA Data page.
3. Derive from the Program HESA Data page.

Unique Learner Number (ULN)

Return: ITT

Entity: Student

Page Used:

Page	Page Element
External System ID	External System ID

Field Derivation Rule: Include for all Student entities.

Derivation Steps:

1. Select External System ID records for the person with the External ID Type defined for ULN in the HESA Types page.

Validate the derived value using the checksum method. For information on the checksum method, refer to the Notes section for the ULN field available on the HESA website.

2. Do not derive a value and leave the field blank.

Units of Length (UNITLGTH)

Return: ITT

Entity: Student

Pages Used:

Page	Page Element
Program HESA Data	UNITLGTH
Program Offering/Year HESA	UNITLGTH (Program Offering HESA Data group box)
Plan HESA Data	UNITLGTH
Plan Offering/Year HESA	UNITLGTH (Plan Offering HESA Data group box)
Sub-Plan HESA	UNITLGTH
Sub-Plan Offering/Year HESA	UNITLGTH (Sub-Plan Offering HESA Data group box)
HESA Instance	UNITLGTH

Field Derivation Rule: Include for all Student entities.

Derivation Steps:

1. Use constant.
2. Derive from the HESA Instance page.
3. If Student.COURSEID is based on a subplan, derive from the Sub-Plan Offering/Year HESA page for the academic load of the student instance. Only records where Offering Start Term, Offering Start Session and Campus are all blank are considered.
4. If Student.COURSEID is based on a subplan, derive from the Sub-Plan HESA page.
5. Derive from the Plan Offering/Year HESA page for the academic load of the student instance. Only records where Offering Start Term, Offering Start Session and Campus are all blank are considered.

6. Derive from the Plan HESA Data page.
7. Derive from the Program Offering/Year HESA page for the academic load of the student instance.
8. Derive from the Program HESA Data page.
9. Use default.
10. Do not derive a value, leave the field blank and set ReasonForNull = 9.

Year of Program (YEARPRG)

Return: ITT

Entity: Student

Page Used:

Page	Page Element
HESA Instance	Year of Program

Field Derivation Rule: Include for all Student entities.

Derivation Steps:

1. Derive from the HESA Instance page.
2. Use default.
3. Derive as *NULL ERROR*.

Year of Student on This Instance (YEARSTU)

Return: ITT

Entity: Student

Page Used:

Page	Page Element
HESA Instance	Year of Student

Include for all Student entities.

Derivation Steps:

1. Derive from the HESA Instance page.
2. Use default.

3. Derive as *NULL ERROR*.

ITT Return: Placement

The ITT Return Placement entity depends on the Student entity.

The Create Extract process creates the extract records if you select the **Include Student Entities** check box on the Create Extract Data page. If you do not select **Retain Data from Previous Run**, existing extract records are deleted regardless of their status.

The process creates up to five Placement entities for each Student entity based on the ITT Placement records defined for the HESA Instance Data record. Only records with a Start Date in the reporting period are reported.

If the conditions are not met, an ITT Placement entity is not required and the process skips to the next instance.

Note: In the Student Return, ITT Placement is only reported where ENTRYRTE = 01. In the ITT Return, ENTRYRTE allows a subset of codes: 01 (Provider-led), 02 (School Direct tuition fee), 03 (School Direct salaried), 09 (Undergraduate Opt-in).

Placement School (PLMNTSCH)

Return: Student Record

Entity: ITT Placement

Page Used:

<i>Page</i>	<i>Page Element</i>
HESA Instance (ITT Placement region)	School URN

Field Derivation Rule: Include for all Instance entities.

Derivation Steps: Derive value from HESA Instance page.

Number of days Spent in Placement School (PLMNTDYS)

Return: Student Record

Entity: ITT Placement

Page Used:

<i>Page</i>	<i>Page Element</i>
HESA Instance (ITT Placement region)	Days

Field Derivation Rule: Include for all Instance entities.

Derivation Steps: Derive value from HESA Instance page.

ITT Return: Course Subject Entity

The Create Extract process creates a maximum of five Course Subject entity records for each Student entity.

Subject of ITT Course (SBJCA)

Return: ITT

Entity: Course Subject

Pages Used:

Page	Page Element
Program HESA Data — HECoS Subjects	Subject ITT Subject
Plan HESA Data — HECoS Subjects	Subject ITT Subject
Sub-Plan HESA — HECoS Subjects	Subject ITT Subject

Field Derivation Rule: Include for all Course Subject entities.

Derivation Steps:

1. Use constant.
2. If Course entity is based on a sub-plan, derive from the Sub-Plan HESA — HECoS Subjects page.
3. Derive from the Plan HESA Data — HECoS Subjects page.
4. Derive from the Program HESA Data — HECoS Subjects page.
5. Use default.
6. Derive as *NULL ERROR*.

For steps 2, 3, or 4, the process:

- Chooses the records that have the ITT Subject check box selected.

- Determines the main subject by choosing the record with the greatest percentage, if multiple records have the ITT Subject check box selected.
- Determines the main subject by choosing the first record in the alphabetical code order, if multiple records have the ITT Subject check box selected and have the same percentage.

ITT Return: Previous Qualification

A Previous Qualification entity is created if any one of the following conditions is true:

- Student.QLAIM = 020, 021, 031, or 032
- Student.TTCID = 1 or Student.TTCID = 01 *and* Student.ITTAIM = 201

The most recent External Education Degree record that is associated with the current reporting period and whose status is *Complete* is used in the derivation.

When deriving fields, the values from the Apply Qualification record (SAD_UC_AQUAL) is considered. If an applicant has applied to the institution more than once, there may be multiple records, so the most recent application record is used. If an applicant has more than one degree record for the most recent application, the most recently completed degree is used.

Note: While five entities are allowed by the schema, only a single entry is created because only one value can be recorded for FIRSTDEG, PGCECLSS, and PGCESBJ in HESA Entry Profile.

Bursary Flag (BURSFLAG)

Return: ITT

Entity: Previous Qualification

Pages Used:

<i>Page</i>	<i>Page Element</i>
Entry Profile	BURSFLAG

Field Derivation Rule: Include for all Previous Qualification entities.

Derivation Steps:

1. Use constant.
2. Derive from the Entry Profile page.
3. Use default.
4. Derive as NULL.

Previous Degree Country (DEGCTRY)

Return: ITT

Entity: Previous Qualification

Pages Used:

Page	Page Element
Entry Profile HESA Data	DEGCTRY
HESA Data (Student Admissions > UCAS Processing > Apply Applications > Qualifications > Degree > HESA Data)	Degree Country (SAD_UC_DEGCTRY from SAD_UC_AQUAL)
External Organization Location (Campus Community > Organization > Create/Maintain Organizations > Organization Locations > Location Details > Location History)	Country

Field Derivation Rule: Derive a value if Student.DEGEST does not exist.

Derivation Steps:

1. Derive from Entry Profile HESA Data.
2. Derive from Apply Application - Qualifications. The most recent application for the most recent cycle is used. If there are multiple degree records, the record with the most recent end date is used.
3. Derive from the External Organization Location page.

Select the most recent External Education Organization record with a Degree status of complete associated with the current reporting period. Select the most recent effective dated location record, if there are multiple records.

It is possible for the Ext Org to have multiple Location records with the same effective date. In this case, select the record with the lowest Location ID to determine the country.

Use the mapping on the Nationality page to derive as the mapped HESA Nationality code. Otherwise, derive as the COUNTRY_2CHAR value if the mapping does not exist.

4. Use default.
5. If QLAIM = 020, 021, 031, or 032, derive as NULL ERROR.
6. Derive as NULL.

The normal two-character GB code is not valid for DEGCTRY. If the value 'GB' is derived, the system changes GB to the valid code XK (United Kingdom, not otherwise specified).

Previous Degree End Date (DEGENDDT)

Return: ITT

Entity: Previous Qualification

Pages Used:

Page	Page Element
Entry Profile HESA Data	DEGENDDT
HESA Data (Student Admissions > UCAS Processing > Apply Applications > Qualifications > Degree > HESA Data)	Degree End Date (SAD_UC_DEGENDDT from SAD_UC_AQUAL)
Courses and Degrees (Student Admissions > Application/ Transcript Loads > Education > Courses and Degrees)	Degree Date

Field Derivation Rule: Include for all Previous Qualification entities.

Derivation Steps:

1. Derive from EntryProfile HESA Data.
2. Derive from Apply Application - Qualifications. The most recent application for the most recent cycle is used. If there are multiple degree records, the record with the most recent end date is used.
3. Select the most recent External Education Degree record with a Degree status of complete that is associated with the current reporting period. Derive from the Courses and Degrees page for the selected record.
4. Use default.
5. If QLAIM = 020, 021, 031, or 032, derive as NULL ERROR.
6. Derive as NULL.

Previous Degree Establishment (DEGEST)

Return: ITT

Entity: Previous Qualification

Pages Used:

Page	Page Element
Entry Profile HESA Data	DEGEST

Page	Page Element
HESA Data (Student Admissions > UCAS Processing > Apply Applications > Qualifications > Degree > HESA Data)	Degree Establishment (SAD_UC_DEGEST from SAD_UC_AQUAL)
Student Admissions > Application/Transcript Loads > Education > Courses and Degrees	Ext Org ID
Region (Campus Community > Organization > Create/Maintain Organizations > Organization Table > Region)	HESA Degree Establishment

Field Derivation Rule: Include for all entities.

Derivation Steps:

1. Derive from Entry Profile HESA Data.
2. Derive from Apply Application - Qualifications. The most recent application for the most recent cycle is used. If there are multiple degree records, the record with the most recent end date is used.
3. Select the most recent External Education Organization record associated with the current reporting period. Derive from the Region page for the selected record. Convert using the two-character code (COUNTRY_2CHAR) from the Country table (PS_COUNTRY_TBL).
4. Use default.
5. Derive as NULL.

Previous Degree Length in Years (DEGLENGTH)

Return: ITT

Entity: Previous Qualification

Pages Used:

Page	Page Element
Student Admissions > Application Maintenance > Maintain Applications > Application Program Data At the bottom of the page, Transfer to Education , then click Go .	From Date Degree Date

Field Derivation Rule: Include for all Previous Qualification entities.

Derivation Steps:

1. Select the most recent External Education Degree record with a Degree status of complete that is associated with the current reporting period. Derive as Degree Date minus From Date from the selected record. The number of days is converted to years and rounded to the nearest year.
2. Use default.
3. If COMDATE is in the reporting period and and QLAIM = 020, 021, or 031, derive as NULL ERROR.
4. Derive as NULL.

Previous Degree Subject (DEGSBJ, DEGSBJ2, DEGSBJ3)

Return: ITT

Entity: Previous Qualification

Pages Used:

Page	Page Element
HESA Data (Student Admissions > UCAS Processing > Apply Applications > Qualifications > Degree > HESA Data)	Degree Subject (SAD_UC_DEGSBJ from SAD_UC_AQUAL)
Entry Profile	DEGSBJ DEGSBJ2 DEGSBJ3

Field Derivation Rule: Include for all entities.

Derivation Steps:

1. Use constant to derive a single DEGSBJ field.
2. Derive values from Entry Profile page.
3. Derive from Apply Application - Qualifications. The most recent application for the most recent cycle is used. If there are multiple degree records, the record with the most recent end date is used.
4. Use default to derive a single DEGSBJ field.
5. If QLAIM = 020, 021, 031, or 032, derive as a single DEGSBJ field as NULL ERROR.
6. Derive as NULL.

Note: The system can derive up to three values. Each of the values is included as a separate DEGSBJ field in the XML file.

Previous Degree Start Date (DEGSTDT)

Return: ITT

Entity: Previous Qualification

Pages Used:

<i>Page</i>	<i>Page Element</i>
Student Admissions > Application Maintenance > Maintain Applications > Application Program Data At the bottom of the page, Transfer to Education , then click Go .	From Date

Field Derivation Rule: Include for all Previous Qualification entities.

Derivation Steps:

1. Select the most recent External Education Degree record with a Degree status of complete that is associated with the current reporting period. Derive from the Education page for the selected record.
2. Use default.
3. If COMDATE is in the reporting period and and QLAIM = 020, 021, or 031, derive as NULL ERROR.
4. Derive as NULL.

Previous Degree Type (DEGTYPE)

Return: ITT

Entity: Previous Qualification

Pages Used:

<i>Page</i>	<i>Page Element</i>
Entry Profile HESA Data	DEGTYPE
Student Admissions > UCAS Processing > Apply Applications > Qualifications > Degree > HESA Data	Degree Type (SAD_UC_DEGTYPE from SAD_UC_AQUAL)
Student Admissions > Application/Transcript Loads > Education > Courses and Degrees	Degree
Setup SACR > Foundation Tables > Academic Structure > Degree Table	HESA Degree Type

Field Derivation Rule: Include for all entities.

Derivation Steps:

1. Derive from Entry Profile HESA Data.
2. Derive from Apply Application - Qualifications. The most recent application for the most recent cycle is used. If there are multiple degree records, the record with the most recent end date is used.
3. Derive the Previous Degree Type by mapping the most recent External Education Degree record with a Degree status of complete from the External degree region to the Degree Type value from the Degree Table.
4. Use default.
5. If QLAIM = 020, 021, 031, or 032, derive as NULL ERROR.
6. Derive as NULL.

First Degree Flag (FIRSTDEG)

Return: ITT

Entity: Previous Qualification

Pages Used: None

<i>Page</i>	<i>Page Element</i>
Entry Profile	FIRSTDEG

Field Derivation Rule: Include for all Previous Qualification entities.

Derivation Steps:

1. Derive value from the Entry Profile page.
2. If DEGTYPE is in the range 001 to 098, or is 400 or 402, derive as *01*.
3. Derive as *02*.

PGCE Class of Undergraduate Degree (PGCECLSS)

Return: ITT

Entity: Previous Qualification

Pages Used:

Page	Page Element
Entry Profile	PGCECLSS
Student Admissions > UCAS Processing > Apply Applications > Qualifications > Degree > HESA Data	Degree Class (SAD_UC_DEGCLSS from SAD_UC_AQUAL)

Note: This value is included as DEGCLSS in the XML file.

Field Derivation Rule: Include for all entities.

Derivation Steps:

1. Use constant.
2. Derive value from Entry Profile page.
3. Derive from Apply Application - Qualifications. The most recent application for the most recent cycle is used. If there are multiple degree records, the record with the most recent end date is used.
4. Use default.
5. If QLAIM = 020, 021, 031, or 032, derive as NULL ERROR.
6. Derive as null.

Data Futures Return: Course Entity

Course extract records are created if you select the **Include Course Entities** check box. If you select the **Enable Sub-Plan Reporting** check box on the HESA Returns page, the eligible academic sub-plans for the institution are selected from ACAD_SUBPLN_TBL. Eligible academic plans for the institution are selected from ACAD_PLAN_TBL.

Records are only included if the **Report to HESA** check box is selected.

Bilingual ITT Marker (BITTMC)

Return: Data Futures

Entity: Course

Pages Used:

Page	Page Element
Program HESA Data	BITTMC
Plan HESA Data	BITTMC

Page	Page Element
Sub-Plan HESA	BITTMC

Field Derivation Rule: If all the following conditions are met, a value is derived:

- Country = Scotland or Northern Ireland
- Course.TTCIDC = 01 or 02

Derivation Steps:

1. Use constant.
2. If Course entity is based on a subplan, derive from the Sub-Plan HESA page.
3. Derive from the Plan HESA Data page.
4. Derive from the Program HESA Data page.
5. Use default.
6. Derive as NULL ERROR.

Closed Course (CLSDCRSC)

Return: Data Futures

Entity: Course

Pages Used:

Page	Page Element
Program HESA Data	CLSDCRSC
Plan HESA Data	CLSDCRSC
Sub-Plan HESA	CLSDCRSC

Field Derivation Rule: Derive a if Country = England.

Derivation Steps:

1. Use constant.
2. If parent Course is based on a sub-plan, derive from the Sub-Plan HESA Data page.
3. Derive from the Plan HESA Data page.
4. Derive from the Program HESA Data page.

5. Use default.
6. Derive as NULL ERROR.

Course Title (COURSE TITLE)

Return: Data Futures

Entity: Course

Pages Used:

Page	Page Element
Plan HESA Data	Course Title
Academic Plan Table	Description
Sub-Plan HESA	Course Title
Academic Sub-Plan Table	Description

Field Derivation Rule: Include for all entities

Derivation Steps:

1. If the Course entity is based on a sub-plan, derive as either:
 - Course Title from Sub-Plan HESA (if defined).
 - Combination of Plan and Sub-Plan descriptions separated by a space.
2. Derive from the Academic Plan.
 - Course Title from Sub HESA Data(if defined).
 - Plan description

Fully Flexible Indicator (FULLYFLEX)

Return: Data Futures

Entity: Course

Pages Used:

Page	Page Element
Program HESA Data	FULLYFLEX
Plan HESA Data	FULLYFLEX
Sub-Plan HESA Data	FULLYFLEX

Field Derivation Rule: Include for all entities

Derivation Steps:

1. Use constant.
2. If parent Course is based on a sub-plan, derive from the Sub-Plan HESA Data page.
3. Derive from the Plan HESA Data page.
4. Derive from the Program HESA Data page.
5. Use default.
6. Derive as null.

Funding Level (FUNLEVEL)

Return: Data Futures

Entity: Course

Pages Used:

Page	Page Element
Program HESA Data	FUNLEVEL
Plan HESA Data	FUNLEVEL
Sub-Plan HESA Data	FUNLEVEL

Field Derivation Rule: Include for all entities

Derivation Steps:

1. Use constant.
2. If parent Course is based on a sub-plan, derive from the Sub-Plan HESA Data page.
3. Derive from the Plan HESA Data page.

4. Derive from the Program HESA Data page.
5. Use default.
6. Derive as NULL ERROR.

Pre-Requisite (PREREQUISITE)

Return: Data Futures

Entity: Course

Pages Used:

<i>Page</i>	<i>Page Element</i>
Program HESA Data	PREREQUISITE
Plan HESA Data	PREREQUISITE
Sub-Plan HESA Data	PREREQUISITE

Field Derivation Rule: Derive a value if Country = England or Northern Ireland.

Derivation Steps:

1. Use constant.
2. If parent Course is based on a sub-plan, derive from the Sub-Plan HESA Data page.
3. Derive from the Plan HESA Data page.
4. Derive from the Program HESA Data page.
5. Use default.
6. Derive as NULL ERROR.

Qualification Identifier (QUALID)

Return: Data Futures

Entity: Course

Pages Used:

<i>Page</i>	<i>Page Element</i>
Program HESA Data	Qualification ID

Page	Page Element
Plan HESA Data	Qualification ID
Sub-Plan HESA Data	Qualification ID

Field Derivation Rule: Include for all entities

Derivation Steps:

1. If parent Course is based on a sub-plan, derive from the Sub-Plan HESA Data page.
2. Derive from the Plan HESA Data page.
3. Derive from the Program HESA Data page.
4. Use default.
5. Derive as NULL ERROR.

Sandwich (SANDWICHCD)

Return: Data Futures

Entity: Course

Pages Used:

Page	Page Element
Program HESA Data	SANDWICHCD
Plan HESA Data	SANDWICHCD
Sub-Plan HESA Data	SANDWICHCD

Field Derivation Rule: Include for all entities

Derivation Steps:

1. Use constant.
2. If parent Course is based on a sub-plan, derive from the Sub-Plan HESA Data page.
3. Derive from the Plan HESA Data page.
4. Derive from the Program HESA Data page.
5. Use default.

- Derive as NULL ERROR.

Teacher Training Course (TTCIDC)

Return: Data Futures

Entity: Course

Pages Used:

<i>Page</i>	<i>Page Element</i>
Program HESA Data	TTCIDC
Plan HESA Data	TTCIDC
Sub-Plan HESA Data	TTCIDC

Field Derivation Rule: Include for all entities

Derivation Steps:

- Use constant.
- If parent Course is based on a sub-plan, derive from the Sub-Plan HESA Data page.
- Derive from the Plan HESA Data page.
- Derive from the Program HESA Data page.
- Use default.
- Derive as NULL ERROR.

Data Futures Return: Course Initiative Entity

For each Course extract record, an entity is created for each initiative defined at sub-plan, plan, or program level. In each case, the latest record where the effective date falls on or before the reporting period end date is considered. Records where Valid To is before the start of the reporting period are not considered.

Course Initiative extract records are created if you selected the **Include Course Entities** parameter check box.

For each Course entity in the extract for the return with an active status:

- If the Course.COURSEID is derived from a Sub-Plan, an entity is created for each eligible record:
 - If at least one Initiative is defined for the Sub-plan with Valid To either blank, or a date on or after the Reporting Period start date. The derivation step for INITIATIVEIDCI is set to 1.

- If at least one Initiative is defined for the parent Plan with Valid To either blank, or a date on or after the Reporting Period start date. The derivation step for INITIATIVEIDCI is set to 2.
- If the parent Plan is associated with an Academic Program (ACAD_PROG in ACAD_PLAN_TBL), and at least one Initiative is defined for the parent Program with Valid To either blank, or a date on or after the Reporting Period start date. The derivation step for INITIATIVEIDCI is set to 3.
- If the Course.COURSEID is derived from a Plan, an entity is created for each eligible record:
 - If at least one Initiative is defined for the Plan with Valid To either blank, or a date on or after the Reporting Period start date. The derivation step for INITIATIVEIDCI is set to 2.
 - If the Plan is associated with an Academic Program (ACAD_PROG in ACAD_PLAN_TBL), and at least one Initiative is defined for the parent Program with Valid To either blank, or a date on or after the Reporting Period start date. The derivation step for INITIATIVEIDCI is set to 3.
- If no eligible records are found at any level, no entities are created.

Course Initiative Identifier (COURSEINITID)

Return: Data Futures

Entity: Course Initiative

Pages Used:

Page	Page Element
Program HESA Data — Initiatives	Initiative
Plan HESA Data — Initiatives	Initiative
Sub-Plan HESA Data — Initiatives	Initiative

Field Derivation Rule: Include for all entities

Derivation Steps:

1. If parent Course is based on a sub-plan, derive from the Sub-Plan HESA Data page.
2. Derive from the Plan HESA Data page.
3. Derive from the Program HESA Data page.

Initiative Valid From Date (COURSEINITVALIDFROM)

Return: Data Futures

Entity: Course Initiative

Pages Used:

Page	Page Element
Program HESA Data — Initiatives	Valid From
Plan HESA Data — Initiatives	Valid From
Sub-Plan HESA Data — Initiatives	Valid From

Field Derivation Rule: Include for all entities

Derivation Steps:

1. If parent Course is based on a sub-plan, derive from the Sub-Plan HESA Data page converted to YYYY-MM-DD format.
2. Derive from the Plan HESA Data page converted to YYYY-MM-DD format.
3. Derive from the Program HESA Data page converted to YYYY-MM-DD format.

Initiative Valid To Date (COURSEINITVALIDTO)

Return: Data Futures

Entity: Course Initiative

Pages Used:

Page	Page Element
Program HESA Data — Initiatives	Valid To
Program HESA Data — Initiatives	Valid To
Program HESA Data — Initiatives	Valid To

Field Derivation Rule: Include for all entities

Derivation Steps:

1. If parent Course is based on a sub-plan, derive from the Sub-Plan HESA Data page converted to YYYY-MM-DD format.
2. Derive from the Plan HESA Data page converted to YYYY-MM-DD format.
3. Derive from the Program HESA Data page converted to YYYY-MM-DD format.

4. Derive as null.

Data Futures Return: Curriculum Accreditation Entity

Curriculum accreditation extract records are created if the **Include Course Entities** on the Create Extract Data page is selected. An entity is created for each Accreditation defined at sub-plan, plan, or program level where Accreditation ID is defined. For each Course entity in the extract for the return with an active status:

- If the Course.COURSEID is derived from a sub-plan, an entity is created for each eligible record when:
 - at least one eligible accreditation is defined for the sub-plan and has an accreditation ID code. The derivation step for ACCREDITATIONIDCA is set to 1.
 - at least one eligible accreditation is defined for the parent plan and has an accreditation ID code. The derivation step for ACCREDITATIONIDCA is set to 2.
 - the parent plan is associated with an academic program and at least one eligible accreditation exists for the program and has an accreditation ID. The derivation step for ACCREDITATIONIDCA is set to 3.
- If the Course.COURSEID is derived from a plan, an entity is created for each eligible record when:
 - at least one eligible accreditation is defined for the plan and has an accreditation code. The derivation step for ACCREDITATIONIDCA is set to 2.
 - the parent plan is associated with an academic program and at least one eligible accreditation for the program and has an accreditation ID. The derivation step for ACCREDITATIONIDCA is set to 3.
- If no entities have been created in the previous steps, and Country is Northern Ireland or Scotland, and Course.TTCIDC = 01 or 02, a single entity is created with ACCREDITATIONIDCA and VALIDFROM derived as NULL ERROR with derivation step 4.

Curriculum Accreditation Identifier (CURACCID)

Return: Data Futures

Entity: Curriculum Accreditation

Pages Used:

<i>Page</i>	<i>Page Element</i>
Program HESA Data — Accreditation	Accreditation ID
Plan HESA Data — Accreditation	Accreditation ID

Page	Page Element
Sub-Plan HESA Data — Accreditation	Accreditation ID

Field Derivation Rule: Include for all entities

Derivation Steps:

1. If Course entity is based on a sub-plan, derive from the Sub-Plan HESA Data.
2. Derive from Plan HESA Data.
3. Derive from Program HESA Data.
4. If Country = Northern Ireland or Scotland, and Course.TTCIDC = 01 or 02, derive as NULL ERROR.

Accreditation Valid From Date (CURACCVALIDFROM)

Return: Data Futures

Entity: Curriculum Accreditation

Pages Used:

Page	Page Element
Program HESA Data — Accreditation	Valid From
Plan HESA Data — Accreditation	Valid From
Sub-Plan HESA Data — Accreditation	Valid From

Field Derivation Rule: Include for all entities

Derivation Steps:

1. If parent Course is based on a sub-plan, derive from the Sub-Plan Offering HESA Data converted to YYYY-MM-DD format.
2. Derive from Plan HESA Data converted to YYYY-MM-DD format.
3. Derive from Program HESA Data converted to YYYY-MM-DD format.
4. If Country is Northern Ireland or Scotland and Course.TTCID = 01 or 02, derive as NULL ERROR.

Accreditation Valid To Date (CURACCVALIDTO)

Return: Data Futures

Entity: Curriculum Accreditation

Pages Used:

Page	Page Element
Program HESA Data — Accreditation	Valid To
Plan HESA Data — Accreditation	Valid To
Sub-Plan HESA Data — Accreditation	Valid To

Field Derivation Rule: Include for all entities

Derivation Steps:

1. If parent Course is based on a sub-plan, derive from the Sub-Plan Offering HESA Data converted to YYYY-MM-DD format.
2. Derive from Plan HESA Data converted to YYYY-MM-DD format.
3. Derive from Program HESA Data converted to YYYY-MM-DD format.
4. Derive as null.

Data Futures Return: Course Reference Entity

Course Reference extract records are created if you selected the **Include Course Entities** parameter check box.

Note: OWNCOURSEID is displayed in Plan HESA Data and Sub-Plan HESA Data. The other fields are displayed under KIS Course Data.

For each Academic Plan or Sub-Plan (keyed on COURSEID) in the Course Extract for the return with status of ACTIVE:

- If the Course is derived from a Sub-Plan:
 - If OWNCOURSEID is defined for the sub-plan or parent plan, a Course Identifier entity is created with COURSEREFRNCIDTYPE = 01.
 - If UCASPROGID is defined for the sub-plan or parent plan, a Course Identifier entity is created with COURSEREFRNCIDTYPE = 02.
 - If UCASCOURSEID is defined for the sub-plan or parent plan, a Course Identifier entity is created with COURSEREFRNCIDTYPE = 03.
 - If UCASCOURSEID2 is defined for the sub-plan or parent plan, a Course Identifier entity is created with COURSEREFRNCIDTYPE = 03.
 - If UCASCOURSEID3 is defined for the sub-plan or parent plan, a Course Identifier entity is created with COURSEREFRNCIDTYPE = 03.

- If none of the fields are defined for the sub-plan or plan, entities aren't created.
- If the Course is derived from a Plan:
 - If OWNCOURSEID is defined for the plan, a Course Identifier entity is created with COURSEREFRNCIDTYPE = 01.
 - If UCASPROGID is defined for the plan, a Course Identifier entity is created with COURSEREFRNCIDTYPE = 02.
 - If UCASCOURSEID is defined for the plan, a Course Identifier entity is created with COURSEREFRNCIDTYPE = 03.
 - If UCASCOURSEID2 is defined for the plan, a Course Identifier entity is created with COURSEREFRNCIDTYPE = 03.
 - If UCASCOURSEID3 is defined for the plan, a Course Identifier entity is created with COURSEREFRNCIDTYPE = 03.
 - If none of the fields are defined for the plan, entities aren't created.

Course Reference Identifier Type (COURSEREFRNCIDTYPE)

Return: Data Futures

Entity: Course Reference

Pages Used:

Page	Page Element
Plan HESA Data	OWNCOURSEID
Sub-Plan HESA Data	OWNCOURSEID
Plan HESA Data—KIS Course Data	UCASPROGID
Sub-Plan HESA Data—KIS Course Data	UCASPROGID
Plan HESA Data—KIS Course Data	UCASCOURSEID
Plan HESA Data—KIS Course Data	UCASCOURSEID2
Plan HESA Data—KIS Course Data	UCASCOURSEID3
Sub-Plan HESA Data—KIS Course Data	UCASCOURSEID

Page	Page Element
Sub-Plan HESA Data—KIS Course Data	UCASCOURSEID2
Sub-Plan HESA Data—KIS Course Data	UCASCOURSEID3

Field Derivation Rule: Include for all entities

Derivation Steps:

1. If Course entity is based on a sub-plan, derive from the Sub-Plan HESA Data page:
 - OWNCOURSEID = 01
 - UCASPROGID = 02
 - UCASCOURSEID, UCASCOURSEID2, UCASCOURSEID3 = 03
2. Derive from the Plan HESA Data page:
 - OWNCOURSEID = 01
 - UCASPROGID = 02
 - UCASCOURSEID, UCASCOURSEID2, UCASCOURSEID3 = 03

Course Reference Identifier (COURSEREFRNCID)

Return: Data Futures

Entity: Course Reference

Pages Used:

Page	Page Element
Plan HESA Data	OWNCOURSEID
Sub-Plan HESA Data	OWNCOURSEID
Plan HESA Data—KIS Course Data	UCASPROGID
Sub-Plan HESA Data—KIS Course Data	UCASPROGID
Plan HESA Data—KIS Course Data	UCASCOURSEID
Plan HESA Data—KIS Course Data	UCASCOURSEID2

<i>Page</i>	<i>Page Element</i>
Plan HESA Data—KIS Course Data	UCASCOURSEID3
Sub-Plan HESA Data—KIS Course Data	UCASCOURSEID
Sub-Plan HESA Data—KIS Course Data	UCASCOURSEID2
Sub-Plan HESA Data—KIS Course Data	UCASCOURSEID3

Field Derivation Rule: Include for all entities

Derivation Steps:

1. If Course entity is based on a sub-plan, derive Code field value from the Sub-Plan HESA Data page.
2. Derive Code field value from the Plan HESA Data page.

Data Futures Return: Course Role Entity

For each Course extract record, an entity is created for each Roles record defined at Sub-Plan, Plan, or Program level. In each case, the latest record where the effective date falls on or before the reporting period end date is considered.

Course Role extract records are created if you selected the **Include Course Entities** parameter check box.

For each Course entity in the extract for the return with an active status:

- If the Course.COURSEID is derived from a Sub-Plan, an entity is created for each eligible record:
 - If at least one Role is defined for the Sub-plan. The derivation step for each field is set to 1.
 - If at least one Role is defined for the parent Plan. The derivation step for each field is set to 2.
 - If the parent Plan is associated with an Academic Program (ACAD_PROG in ACAD_PLAN_TBL) and at least one Role is defined for the parent Program. The derivation step for each field is set to 3.
- If the Course.COURSEID is derived from a Plan, an entity is created for each eligible record:
 - If at least one Initiative is defined for the Plan with Valid To either blank or a date on or after the Reporting Period start date. The derivation step for each field is set to 2.
 - If the Plan is associated with an Academic Program (ACAD_PROG in ACAD_PLAN_TBL) and at least one Initiative is defined for the parent Program with Valid To either blank or a date on or after the Reporting Period start date. The derivation step for each field is set to 3.

If no eligible records are found at any level, a single entity is created with field values (COURSEHESAID, ROLETYPECR and CRPROPORTION) derived for any default values defined for the return with derivation step 4.

Course Role HESA Identifier (COURSEHESAID)

Return: Data Futures

Entity: Course Role

Pages Used:

Page	Page Element
Program HESA Data — Roles	Identifier
Plan HESA Data — Roles	Identifier
Plan Offering HESA Data — Roles	Identifier

Field Derivation Rule: Include for all entities

Derivation Steps:

1. If parent Course is based on a sub-plan, derive from the Sub-Plan HESA Data page.
2. Derive from the Plan HESA Data page.
3. Derive from the Program HESA Data page.
4. Use default.

Role Type (ROLETYPECR)

Return: Data Futures

Entity: Course Role

Pages Used:

Page	Page Element
Program HESA Data — Roles	Type
Plan HESA Data — Roles	Type
Sub-Plan HESA Data — Roles	Type

Field Derivation Rule: Include for all entities

Derivation Steps:

1. If parent Course is based on a sub-plan, derive from the Sub-Plan HESA Data page.
2. Derive from the Plan HESA Data page.
3. Derive from the Program HESA Data page.
4. Use default.

Course Delivery Role Proportion (CRPROPORTION)

Return: Data Futures

Entity: Course Role

Pages Used:

<i>Page</i>	<i>Page Element</i>
Program HESA Data — Roles	Percentage
Plan HESA Data — Roles	Percentage
Sub-Plan HESA Data — Roles	Percentage

Field Derivation Rule: Include for all entities

Derivation Steps:

1. If parent Course is based on a sub-plan, derive from the Sub-Plan HESA Data page.
2. Derive from the Plan HESA Data page.
3. Derive from the Program HESA Data page.
4. Use default.

Data Futures Return: Module Entity

If you select the **Include Module Entities** check box on the Create Extract Data page, the Create Extract process creates the Module entities. To create Module entities, the process uses the institution's Course Offering records that are active and have been set up as eligible for reporting to HESA. You must select the **Report to HESA** check box on the HESA Module Data page to make a course offering record eligible for HESA reporting.

The process includes dummy modules in the module entity.

Note: When you run the Create Extract process, you can choose to enter the course ID or course offering number as a run parameter for testing purposes. The Create Extract process then uses the specified course ID or course offering number to create the Module entities.

If you have selected an academic career and no course offering on the Create Extract Data page, then the process selects only those course offerings that are related to the selected career.

If you have selected the Null Errors Only check box for the Include Module Entities on the Create Extract Data page, the Create Extract process selects distinct MODID values from the existing active Module extract data, where at least one field in the Module or Module Subject extract data has a Derived Value of *NULL ERROR*. The process then selects Module entity records for these MODIDs.

If you have selected the Validation Errors Only check box for the Include Module Entities, the Create Extract process first deletes any Validation Error staging records where all of the COURSEID, MODID and EMPLID fields are blank. Then, it selects distinct MODID values from the Validation Error staging table for rows where MODID is not blank and EMPLID is blank. The process selects Module entity records for these MODIDs. Note that the File Parser process removes the leading zeroes from MODID, therefore, the comparison of MODID with Course ID and Course Offering Number includes the logic to correctly match the values. The system makes an assumption that the Course Offering Number is a single digit. Finally, the Create Extract process deletes records from the Validation Error staging table where MODID is populated and EMPLID is blank.

Credit Value of Module (CRDTPTS)

Return: Data Futures

Entity: Module

Page Used:

Page	Page Element
HESA Module Data	CRDTPTS
Catalog Data (Curriculum Management, Course Catalog, Catalog Data)	Maximum Units, Academic Progress Units, Enrollment Unit Load Calc Type

Field Derivation Rule: Include for all entities

Derivation Steps:

1. Derive from the HESA Module Data page.
2. Select the Course Catalog record for the Course ID. If the Enrollment Unit Load Calc Type value is *Academic Progress Units*, derive from the Academic Progress Units value. If the Enrollment Unit Load Calc Type value is any other value, derive from the Maximum Units value. Round off the fractional values to the nearest whole number. This step is not performed for dummy modules.
3. Use default.
4. Derive as null.

Credit Transfer Scheme (CRDTSCMM)

Return: Data Futures

Entity: Module

Page Used:

Page	Page Element
HESA Module Data	CRDTSCMM
HESA Dummy Module	CRDTSCMM

Field Derivation Rule: Include for all entities

Derivation Steps:

1. Use constant.
2. Derive from the HESA Module Data page.
3. Use default.
4. Derive as null.

Module FTE (FTE)

Return: Data Futures

Entity: Module

Page Used:

Page	Page Element
HESA Module Data	FTE
HESA Dummy Module	FTE

Field Derivation Rule: Include for all entities

Derivation Steps:

1. Use constant.
2. Derive from the HESA Module Data page.
3. Use default.

4. Derive as *NULL ERROR*.

Module Language Identifier (MODLANGID)

Return: Data Futures

Entity: Module

Page Used:

Page	Page Element
HESA Module Data	MODLANGID
HESA Dummy Module	MODLANGID

Field Derivation Rule: Include where Country = Northern Ireland or Scotland

Derivation Steps:

1. Derive from the HESA Module Data page.
2. Use default.
3. Derive as null.

Level of Credit Points (LEVLPTSM)

Return: Data Futures

Entity: Module

Page Used:

Page	Page Element
HESA Module Data	LEVLPTSM
HESA Dummy Module	LEVLPTSM

Field Derivation Rule: If Module.CRDTPTS is greater than zero, derive a value.

Derivation Steps:

1. Use constant.
2. Derive from the HESA Module Data page.
3. Use default.

4. Derive as null.

Module Identifier (MODID)

Return: Data Futures

Entity: Module

Page Used:

<i>Page</i>	<i>Page Element</i>
HESA Module Data	Course ID Course Offering Nbr

Field Derivation Rule: Include for all Module entities.

Derivation Steps:

Derive as combination of Course ID plus Course Offering Number (CRSE_ID and CRSE_OFFER_NBR column values from PS_CRSE_OFFER), or the combination of Academic Plan and Year for dummy modules. For example, if Course ID = 001248 and Offering Number = 2, then MODID = 0012482.

Data Futures Return: Module Subject Entity

If you select the **Include Module Entities** check box on the Create Extract Data page, the Create Extract process selects HECoS subjects from the most recent effective dated record that falls on or before the reporting period end date from the HESA Module or HESA Dummy Module page. If one or more subjects are found, Module Subject entities are created using the key structure of the Module Extract record, and the derivation step for each field is set to 2. If Module Subjects aren't found for the course offering, a Module Subject record is created using steps 1, 3, and 4.

Subject Identifier (MODSBJ)

Return: Data Futures

Entity: Module Subject

Page Used:

<i>Page</i>	<i>Page Element</i>
HESA Module Data (HECoS Subjects)	Subject

Field Derivation Rule: Include for all entities

Derivation Steps:

1. Use constant.
2. Derive from the HESA Module Data — HECoS Subjects page.
3. Use Default.
4. Derive as *NULL ERROR*.

Module Proportion (MODPROPORTION)

Return: Data Futures

Entity: Module Subject

Page Used:

<i>Page</i>	<i>Page Element</i>
HESA Module Data (HECoS Subjects)	Percentage

Field Derivation Rule: Include for all entities

Derivation Steps:

1. Use constant.
2. Derive from the HESA Module Data — HECoS Subjects page. If there is more than one row for the subject code, the total of all the percentage values is derived.
3. Use Default.
4. Derive as *NULL ERROR*.

Data Futures Return: Module Delivery Role Entity

For each Module entity in the extract, entities are created based on any Roles defined in HESA Module Details (for entities based on enrollment class sections) or HESA Dummy Module Details (for entities based on dummy modules).

If no Roles are defined, entities aren't created. This doesn't consider default values that are defined in HESA Returns Setup because entities are only required where another provider is involved in the Module Delivery.

Module Delivery Role HESA Identifier (MDRHESAIID)

Return: Data Futures

Entity: Module Delivery Role

Page Used:

Page	Page Element
HESA Module Details — Roles	Identifier
HESA Dummy Module Details — Roles	Identifier

Field Derivation Rule: Include for all entities

Derivation Steps:

1. If the parent Module is based on a Course Offering, derive the value from Role in HESA Module Details.
2. If the parent Module is based on a dummy module, derive the value from Role in HESA Dummy Module Details.

Module Delivery Role Proportion (MDRPROPORTION)

Return: Data Futures

Entity: Module Delivery Role

Page Used:

Page	Page Element
HESA Module Details — Roles	Percentage
HESA Dummy Module Details — Roles	Percentage

Field Derivation Rule: Include for all entities

Derivation Steps:

1. If the parent Module is based on a Course Offering, derive the value from Role in HESA Module Details.
2. If the parent Module is based on a dummy module, derive the value from Role in HESA Dummy Module Details.

Data Futures Return: Module Cost Centre Entity

For each Module entity in the extract, an entity is created for each unique cost centre value defined in HECoS Subjects in the most recent effective dated HESA Module or HESA Dummy Module record on or before the reporting period end date. If there are multiple records for the same COSTCN value, the Percentage values are totalled for COSTCNPROPORTION.

If no HECoS Subjects are defined for the Module/Dummy Module, a single entity is derived using the default value for COSTCN from HESA Returns Setup (if defined).

HESA Cost Centre (COSTCN)

Return: Data Futures

Entity: Module Cost Centre

Page Used:

Page	Page Element
HESA Module Data	HECoS Subjects — Cost Centre
HESA Dummy Module Data	HECoS Subjects — Cost Centre

Field Derivation Rule: Include for all entities

Derivation Steps:

1. Derive from HESA Module Data — HECoS Subjects.
2. Use default.

HESA Cost Centre Proportion (COSTCNPROPORTION)

Return: Data Futures

Entity: Module Cost Centre

Page Used:

Page	Page Element
HESA Module Data	HECoS Subjects — Percentage
HESA Dummy Module Data	HECoS Subjects — Percentage

Field Derivation Rule: Include for all entities

Derivation Steps:

1. Derive value from HESA Module Data — HECoS Subjects.

If there are multiple records for the same COSTCN value, the total of the Percentage values is derived. Values are rounded to the nearest integer.

2. Derive as 100 when COSTCN is derived as the default value.

Data Futures Return: Module Instance Entity

Module Instance entities are created based on enrolled or dropped Student Enrollment records for activated terms for the career where the class section dates overlap the Student Course Session or reporting period.

An additional check includes enrollments where the Grade Date is in the reporting period.

- The SCS start date is set to the derived SCSSTARTDATE if that has a date value (that is, not null or NULL ERROR). Otherwise, it's set to the reporting period start date.
- The SCS end date is set to the derived SCSENDDATE if that has a date value (that is, not null). Otherwise, it's set to the reporting period end date.

Each Module Instance is linked to a Module by MODID and has a unique identifier, MODINSTID. For each Student Course Session entity in the extract:

- For each activated term for the related Student Career, select classes from Student Enrollment (STDNT_ENRL) with:
 - One or more of the following based on Class Section dates from CLASS_TBL or from OEE dates are appropriate: Start Date in the SCS dates, or End Date in the SCS dates, or Start Date prior to the SCS start date and End Date after the SCS end date, or Grade In/Official has a value and Grade Date is in the reporting period.
 - Status (STDNT_ENRL_STATUS) = E (Enrolled), or D (Dropped) and the Drop Date is on or after the class Start Date.
 - Units Taken (UNT_TAKEN) is greater than zero or FTE is greater than zero for the associated HESA Module.
 - Grading Basis (GRADING_BASIS_ENRL) matches one of the values defined in the “Grading Basis Inclusion” region with the Extract check box selected in HESA Configuration, e.g. GRD (Graded).
 - Repeat Code (REPEAT_CODE) is blank or isn't defined in the Repeat Code Exclusion region with the Extract check box selected in HESA Configuration.
 - Enrollment Action Reason (ENRL_ACTN_RSN_LAST) is blank or isn't defined in Drop Reason Exclusion region with the Extract checkbox selected in HESA Configuration.
 - If the student has multiple careers with the same Academic Career value as the career being processed (i.e. the same career value with different career numbers) then a further filter is applied to the Class enrollments. In that case a Class is only included if the program (ACAD_PROG) of the enrollment record (in STDNT_ENRL) matches one of the programs in the Student Program records for that career/career number.
- For each record, determine the MODID and validate.

Determine MODID as concatenation of Course ID plus Course Offering Number from the related Course Offering record.

Validate the MODID exists in the Module Extract record for the return or the Module submitted data record for the institution.

If the MODID doesn't exist, the record is excluded and a message is logged.

- For each valid record, entities are created using the key structure of the parent Student Course Session extract record along with the MODINSTID (see below) and MODID.

MODINSTID is generated as the SCSESSIONID plus MODID.

- If one or more Module Instance entities have been created (i.e. some class enrollments have been included) and either the derived PREDICTEDSTULOAD or derived STULOAD in the extract for Student Course Session is greater than zero, or there is a ReferencePeriodStudentLoad entity in the extract or submitted data with a derived RPSTULOAD greater than zero.
 - The combination of the student's Plan and Year of Program (from the derived YEARPRG for the related Student Course Session) is used to form the MODID and this value is checked against the Module Extract and Module submitted data records to verify that the combination exists as a dummy module.

If the student's sub-plan is being reported the parent Plan is used to create a dummy record.

- If the MODID exists and the "Always Include" check box is selected in HESA Dummy Module Detail, a single Module Instance entity is created using MODID. Otherwise, Year of Program wasn't determined, or the MODID doesn't exist, or "Always Include" isn't selected, an entity isn't created.
- If no Module Instance entities have been created and either the derived PREDICTEDSTULOAD or derived STULOAD in the extract for Student Course Session is greater than zero, or there is a ReferencePeriodStudentLoad entity in the extract, or submitted data with a derived RPSTULOAD greater than zero:
 - The combination of the student's Plan and Year of Program is used to form the MODID and this value is checked against the Module Extract and Module submitted data records to verify that the combination exists as a dummy module. If the student's sub-plan is being reported, the parent Plan is used to create a dummy record.
 - If the MODID exists, a single Module Instance entity is created using MODID. Otherwise, Year of Program wasn't determined or the MODID doesn't exist, an entity isn't created.

Continuing Module (CONTINUING)

Return: Data Futures

Entity: Module Instance

Page Used:

<i>Page</i>	<i>Page Element</i>
Records and Enrollment > Enroll Students > Student OEE Enrollment Data	Start Date/End Date

Page	Page Element
Maintain Schedule of Classes	Start Date/End Date

Field Derivation Rule: Include for all entities

Derivation Steps:

1. Derive as null for dummy modules.
2. For OEE enrollments, if the OEE Start Date is before the SCSSTARTDATE and the OEE End Date is on or after the SCSSTARTDATE, derive as 01.
3. For standard enrollments, if the Start Date of the Class Section is before the SCSSTARTDATE and the End Date for the Class Section is on or after the SCSSTARTDATE, derive as 01.
4. Derive as null.

Inactive Module Flag (INACTIVEMOD)

Return: Data Futures

Entity: Module Instance

Pages Used:

Page	Page Element
Records and Enrollment > Enroll Students > Student OEE Enrollment Data	End Date
Maintain Schedule of Classes	End Date
Maintain Schedule of Classes > Associated Class Attributes	CAF date attribute for MODINSTENDDATE
Returns Setup > Common Attributes	Common Attributes (CLASS_ASSOC)
Records and Enrollment > Enroll Students > Enrollment	Drop Date

Field Derivation Rule: Include for all entities

Derivation Steps:

1. Derive as null for dummy modules.
2. For OEE enrollments, if the OEE End Date is before the SCSSTARTDATE, derive as 01.
3. For dropped enrollments, if the Drop Date is before the SCSSTARTDATE, derive as 01.

4. For standard enrollments, if a CAF date attribute for MODINSTENDDATE is defined for the Class Section with a date before the SCSSTARTDATE, derive as 01.
5. For standard enrollments, if a CAF date attribute for MODINSTENDDATE *isn't* defined for the Class Section, and the End Date of the Class Section is before the SCSSTARTDATE, derive as 01.
6. Derive as null.

Language Percentage (LANGPCNT)

Return: Data Futures

Entity: Module Instance

Page Used:

<i>Page</i>	<i>Page Element</i>
HESA Module Data	MODLANGID

Field Derivation Rule: Derive a value if the Module related to the Module Instance is not MODLANGID = null.

Derivation Steps: Derive as 100.

Module Instance Fee Amount (MIFEEAMOUNT)

Return: Data Futures

Entity: Module Instance

Currently, fees are reported in Student Course Session Fee Amount (SCSFEEAMOUNT) and not reported at Module Instance level, so MIFEEAMOUNT will be derived as null. The related StudentCourseSession.FEEMETHOD field will also be derived as null.

Module Identifier (MODID)

Return: Data Futures

Entity: Module Instance

Page Used: None

Field Derivation Rule: Include for all entities

Derivation Steps:

1. For class enrollments, derive the concatenation of Course ID plus Course Offering Number from the related Course Offering record.
2. For dummy modules, derive Plan code and Year of Program.

Module Instance End Date (MODINSTENDDATE)

Return: Data Futures

Entity: Module Instance

Page Used:

Page	Page Element
Maintain Schedule of Classes	End Date
Maintain Schedule of Classes > Associated Class Attributes	CAF date attribute for MODINSTENDDATE
Returns Setup > Common Attributes	Common Attributes (CLASS_ASSOC)
Records and Enrollment > Enroll Students > Enrollment	Drop Date

Field Derivation Rule: Include for all entities

Derivation Steps:

1. For dummy modules, derive a value if the SCSENDDATE is within the reporting period.
2. If INACTIVEMOD = 01, derive as SCSSTARTDATE.
3. For OEE enrollments, if the OEE End Date is within the reporting period and on or before the SCSENDDATE, derive in YYYY-MM-DD format.
4. For dropped enrollments, if the Drop Date is on or before the reporting period end date and is on or before the SCSENDDATE, derive in YYYY-MM-DD format.
5. For standard enrollments, if a CAF date attribute for MODINSTENDDATE is defined for the Class Section with a date within the reporting period and on or before the SCSENDDATE, derive in YYYY-MM-DD format.
6. For standard enrollments, if a CAF date attribute for MODINSTENDDATE is not defined for the Class Section, and the End Date for the Class Section is within the reporting period and on or before the SCSENDDATE, derive in YYYY-MM-DD format.
7. Derive a value if SCSENDDATE is in the reporting period.
8. Derive as null.

Module Instance Start Date (MODINSTSTARTDATE)

Return: Data Futures

Entity: Module Instance

Page Used:

Page	Page Element
Records and Enrollment > Enroll Students > Student OEE Enrollment Data	Start Date
Maintain Schedule of Classes	Start Date

Field Derivation Rule: Include for all entities

Derivation Steps:

1. For dummy modules, derive as the SCSSTARTDATE.
2. For OEE enrollments, the OEE Start Date is derived in YYYY-MM-DD format if the date is on or after the SCSSTARTDATE.
3. For standard enrollments, the Start Date for the Class Section is derived in YYYY-MM-DD format if the date is on or after the SCSSTARTDATE.
4. Derive as SCSSTARTDATE.

Module Outcome (MODULEOUTCOME)

Return: Data Futures

Entity: Module Instance

Page Used:

Page	Page Element
Records and Enrollment > Enroll Students > Enrollment	Grading Basis / Grade In/Official
Maintain Schedule of Classes	End Date
Maintain Schedule of Classes > Associated Class Attributes	CAF date attribute for MODINSTENDDATE
Returns Setup > Common Attributes	Common Attributes (CLASS_ASSOC)
Records and Enrollment > Enroll Students > Enrollment	Drop Date

Field Derivation Rule: Derive a value if MODINSTENDDATE is not null.

Derivation Steps:

1. For dummy modules, derive as 96 (not coded).
2. For enrollments where a Grade is recorded and is mapped to an Outcome code, derive the mapped outcome code.

To map the outcome, the Grading Scheme is determined either from the Academic Program of the student (if a Grading Scheme is defined), otherwise from the Academic Career of the student.

3. If the Enrollment Status is Dropped, derive as 03 (not completed).
4. For OEE enrollments, if the OEE End Date is after the SCSENDDATE, derive as 06.
5. For standard enrollments, if a CAF date attribute for MODINSTENDDATE is defined for the Class Section with a date after SCSENDDATE, derive as 06.
6. For standard enrollments, if a CAF date attribute for MODINSTENDDATE is not defined for the Class Section, and the End Date for the Class Section is after the SCSENDDATE, derive as 06.
7. Use default.
8. If Country = Northern Ireland or Scotland, derive as NULL ERROR.
9. Derive as null.

Module Result (MODULERESULT)

Return: Data Futures

Entity: Module Instance

Page Used:

Page	Page Element
Records and Enrollment > Enroll Students > Enrollment	Grading Basis / Grade In/Official

Field Derivation Rule: Derive a value if these conditions are met:

- Country = Northern Ireland
- ModuleInstance.MODULEOUTCOME = 01
- Either CourseInitiative.COURSEINITID = 004 *or* StudentInitiatives.STUINITID = 004

Derivation Steps:

1. For enrollments where a Grade is recorded and is mapped to a Result code, derive the mapped result code.

The grade mapping is as per MODOUTCOME but mapped to Module Result rather than Module Outcome.

2. Use default.
3. Derive as NULL ERROR.

Data Futures Return: Leaver Entity

For each Engagement entity in the extract, a single Leaver entity is created if the derived ENGENDDATE for the Instance/Student Registration falls within the reporting period.

ENGENDDATE is derived as follows:

1. Derive from HESA Instance Data.
2. If the latest row in Student Program (that has an effective date in the reporting period) has a program action/reason combination that is mapped to a Leaver Reason (RSNENGEND), and the student is a taught student, then the date is derived as the latest related StudentCourseSession.SCSENDDATE in the extract or submitted data if these conditions are true:
 - The related Qualification.QUALCAT in extract or submitted data does not start with D or L.
 - The Qualification is linked from the most recent Student Course Session of the parent Engagement entity via COURSEID (stored in Engagement extract but reported as part of Student Course Session) and QUALID.
3. If the latest row in Student Program (that has an effective date in the reporting period) has a program action/reason combination that is mapped to a Leaver Reason (RSNENGEND), the date is derived from the effective date in Student Program/Plan.
4. If a default value is defined for ENGENDDATE in returns setup.

In some cases, the end of attendance may be in a reporting period prior to the awarding of a degree. For example, if a student completes their final year in summer 2020 but has re-sits, the end of attendance date might be 30-JUN- 2020 (reflecting the end of the teaching and assessment). But the degree might not be awarded until 30-SEP-2020. In this case, the Leaver entity will be triggered when the Student Program/Plan is completed in the 01-AUG-2020 to 30-NOV-2020 reporting period, although the ENGENDDATE will fall in the previous reporting period.

The Leaver entity could be reported in an earlier reporting period if a Student Program/Plan record with mapped RSNENGEND (that is, completion of course – result unknown) was added on or before 31-JUL-2020 to indicate that the student has completed attendance but not yet been made an award. In that scenario, the Leaver entity would be reported again in the reporting period when the award was made with an updated RSNENGEND value.

Engagement End Date (ENGENDDATE)

Return: Data Futures

Entity: Leaver

Page Used:

Page	Page Element
Records and Enrollment > Career and Program Information > Student Program/Plan	Program Action/Reason
HESA Instance	ENGENDDATE

Field Derivation Rule: Include for all entities

Derivation Steps:

1. Derive from HESA Instance Data.
2. Derive the latest related StudentCourseSession.SCSENDDATE value (YYYY-MM-DD format) if all of the following is true:
 - The student is a taught student where the related Qualification.QUALCAT value in extract or submitted data doesn't start with D or L.
 - The latest row in Student Program that has an effective date in the reporting period has a program action/reason combination that is mapped to a Leaver Reason (RSNENGEND) value.
3. Derive the effective date in YYYY-MM-DD format if the latest row in Student Program that has an effective date in the reporting period has a program action/reason combination that is mapped to a Leaver Reason (RSNENGEND) value.
4. Use default.

Intended Destination (INTENDEDESTINATION)

Return: Data Futures

Entity: Leaver

Page Used:

Page	Page Element
HESA Instance	INTENDEDESTINATION

Field Derivation Rule: Derive a value if Leaver.RSNENGEND = 12.

Derivation Steps:

1. Derive from HESA Instance.
2. Use default.
3. Derive as NULL ERROR.

Reason for Engagement Ending (RSNENGEND)

Return: Data Futures

Entity: Leaver

Page Used:

Page	Page Element
Records and Enrollment > Career and Program Information > Student Program/Plan	Program Action/Reason
HESA Instance Data	RSNENGEND

Field Derivation Rule: Include for all entities

Derivation Steps:

1. Derive from HESA Instance.
2. If the latest row in Student Program that has an effective date in the reporting period has a program action/reason combination that is mapped to a Leaver Reason value, derive the mapped value.
3. Use default.
4. Derive as NULL ERROR.

Data Futures Return: Reference Period Student Load

For each Student Course Session entity in the extract, a single entity is created for each Student Course Session if Country = England or Northern Ireland.

RP Student Load (RPSTULOAD)

Return: Data Futures

Entity: Reference Period Student Load

Page Used:

Page	Page Element
HESA Instance Data - FTE	Reporting Period
HESA Instance Data - FTE	Calculated FTE
HESA Instance Data - FTE	Override FTE

Page	Page Element
HESA Instance Data - FTE	Report Zero

Field Derivation Rule: Include for all entities

Derivation Steps:

1. If there is an FTE record associated with the HESA Instance with a Reporting Period value that matches the Reporting Period of the return, and the Report Zero check box is selected, derive as zero.
2. If there is an FTE record associated with the HESA Instance with a Reporting Period value that matches the Reporting Period of the return, and the Override FTE value is greater than zero, derive the value.
3. If there is an FTE record associated with the HESA Instance with a Reporting Period value that matches the Reporting Period of the return, derive Calculate FTE.
4. Use default.
5. Derive as NULL ERROR.

Reference Period (REFPERIOD)

Return: Data Futures

Entity: Reference Period Student Load

Page Used:

Page	Page Element
HESA Returns Setup	Reporting Period

Field Derivation Rule: Include for all entities

Derivation Steps: Derive as 01.

Year (YEAR)

Return: Data Futures

Entity: Reference Period Student Load

Page Used:

Page	Page Element
HESA Returns Setup — Reporting Period	Reporting Period > Record Year

Field Derivation Rule: Include for all entities

Derivation Steps: Derive as the Record Year of the Reporting Period code for the return.

Data Futures Return: Funding and Monitoring Entity

For each Student Course Session entity in the extract, an entity is created if these conditions are met.

- The most recent Session Status entity (based on STATUSVALIDFROM date) for the current Student Course Session does not have STATUSCHANGED = 02 (dormant) and a STATUSVALIDFROM on or before the StudentCourseSession.SCSSTARTDATE.
- Leaver.ENGENDDATE is null, or is more than 14 days after Engagement.ENGSTARTDATE, or is less than 15 days after Engagement.ENGSTARTDATE and Leaver.RSNENGEND is not 03, 05, 11 or 12.

Because there is no unique identifier and there are no required fields for the entity, there may be cases where an entity is created with all the fields derived as null. Rather than include the coverage rules for each field in the entity selection, the compare processing will set the Entity Status to Unchanged if all the derived fields are null to prevent the entity from being included in the XML file or moved to the master record.

Equivalent or Lower Qualification (ELQ)

Return: Data Futures

Entity: Funding and Monitoring

Page Used:

<i>Page</i>	<i>Page Element</i>
HESA Instance	ELQ

Field Derivation Rule: Include for entities where:

- Country = England
- The related Engagement.FEEELIGE = 01 (home fees)
- The related Qualification.QUALCAT begins with E, M, H, I, J or C
- The related Engagement.INCOMINGEXCHANGE is null

Derivation Steps:

1. Use constant.
2. Derive value from HESA Instance.
3. Use default.

4. Derive as NULL ERROR.

Funding Completion (FUNDCOMPFM)

Return: Data Futures

Entity: Funding and Monitoring

Page Used:

Page	Page Element
HESA Instance	FUNDCOMPFM

Field Derivation Rule: Derive a value if all the following conditions are met:

- Country = England or Northern Ireland
- The related StudentCourseSession.SCSENDDATE is not null
- The related Engagement.INCOMINGEXCHANGE is null

Derivation Steps:

1. Use constant.
2. Derive value from HESA Instance.
3. Use default.
4. If Country = Northern Ireland, derive as NULL ERROR.
5. Derive as null.

Funding Length (FUNDLENGTH)

Return: Data Futures

Entity: Funding and Monitoring

Page Used:

Page	Page Element
Program HESA Data	FUNDLENGTH
Plan HESA Data	FUNDLENGTH
Plan Offering HESA Data	FUNDLENGTH

Page	Page Element
Plan Year HESA Data	FUNDLENGTH
Sub-Plan HESA Data	FUNDLENGTH
Sub-Plan Offering HESA Data	FUNDLENGTH
Sub-Plan Year HESA Data	FUNDLENGTH
HESA Instance	FUNDLENGTH

Field Derivation Rule: Include for entities where Country = England or Northern Ireland.

Derivation Steps:

1. Derive from HESA Instance.
2. If the course level of the Engagement is sub-plan, derive from Sub-Plan Year HESA for the combination of Academic Load and Year of Program.
3. If the course level of the Engagement is sub-plan, value from Sub-Plan Instance HESA Data.
4. Derive from Plan Year HESA for the combination of Academic Load and the Year of Program.
5. Derive from Plan Instance HESA Data.
6. Derive from Program Instance HESA Data.
7. Use default.
8. Derive as NULL ERROR.

Non-Regulated Fee Flag (NONREGFEE)

Return: Data Futures

Entity: Funding and Monitoring

Page Used:

Page	Page Element
Program HESA Data	NONREGFEE
Plan HESA Data	NONREGFEE
Sub-Plan HESA Data	NONREGFEE

<i>Page</i>	<i>Page Element</i>
HESA Instance	NONREGFEE

Field Derivation Rule: Include for all entities

Derivation Steps:

1. Use constant.
2. Derive from HESA Instance.
3. If the course level of the Engagement is sub-plan, derive from Sub-Plan Instance HESA Data.
4. Derive from Plan Instance HESA Data.
5. Derive from Program Instance HESA Data.
6. Use default.
7. Derive as null.

Data Futures Return: Session Status Entity

For each Student Course Session entity in the extract, the student's mode at the beginning of the Student Course Session is derived for STATUSCHANGEDTO using similar steps to StudentCourseSessionMode.SCSMODE, but mapping Academic Load to Session Status rather than Session Mode.

If SCSSTARTDATE of the parent Student Course Session has a value (that is, it's not NULL ERROR), a Session Status entity is created to report the status at the *beginning* of the SCS (or reporting period). In each case, STATUSVALIDTO is initially set to SCSSTARTDATE.

Note: If the student is active at the beginning of the Student Course Session and the student hasn't previously been reported as dormant, the compare processing will set the Entity Status to Unchanged and the record will not be included in the XML file. For more information, see [Understanding Compare Processing for Data Futures](#).

Subsequent Session Status entities are created where the student's status changes during the Student Course Session, which references only Student Program records. The process loops through each Student Program record where the effective date is after the SCSSTARTDATE and before the reporting period end date, starting with the earliest effective date:

- If the program action or reason is not mapped to a Session Status value in Change of Mode mapping, skip to the next effective dated record.
- If the program action or reason is mapped to a Session Status in the Change of Mode mapping, and that value is the same as the derived STATUSCHANGEDTO value of the existing Session Status entity in the extract with the latest STATUSVALIDFROM value, skip to the next effective dated record.

- If the program action or reason is mapped to a Session Status in the Change of Mode mapping, and that value is different to the derived STATUSCHANGEDTO value of the existing Session Status entity in the extract with the latest STATUSVALIDFROM value, create a new Session Status entity with STATUSCHANGEDTO set to the mapped Session Status value (derivation step 3) and STATUSVALIDFROM set to the effective date (derivation step 3). Otherwise, skip to the next effective dated record.

Status Changed To (STATUSCHANGEDTO)

Return: Data Futures

Entity: Session Status

Page Used:

Page	Page Element
HESA Instance	Instance Load
Records and Enrollment > Career and Program Information > Student Program/Plan	Program Action and Reason
Records and Enrollment > Student Term Information > Term Activate a Student > Student Session	Approved Academic Load
Records and Enrollment > Student Term Information > Term Activate a Student > Enrollment Limit	Approved Academic Load
Records and Enrollment > Career and Program Information > Student Program/Plan	Academic Load
Academic Structure > Academic Plan > HESA Offering/Year	Academic Load
Academic Structure > Academic Sub-Plan > HESA Offering/Year	Academic Load

Field Derivation Rule: Include for all entities

Derivation Steps:

1. If a continuing student is not active and has a Student Course Session entity created because they have not already been reported as interrupted or dormant/writing up, derive value as 02 (dormant).
2. If the Instance Load value from the most recent HESA Instance Data record on or before the SCSSTARTDATE is mapped to a Session Status, derive that value.
3. Select the most recent effective-dated record in the Student Program that has an Effective Date on or before the SCSSTARTDATE and a Program Action and Reason mapped to a Session Status in Change of Mode mapping. Derive the mapped HESA code.

4. If the Approved Academic Load from the most recent Student Session record by session begin date for sessions that begin on or before the SCSSTARTDATE is mapped to a Session Status in the Mode of Study mapping, derive the mapped HESA code.
5. If the Approved Academic Load from the most recent activated Student Term record by term begin date for terms that begin on or before the SCSSTARTDATE is mapped to a Session Status the Mode of Study mapping, derive the mapped HESA code.
6. If the Academic Load for the most recent effective dated record in Student Program that has an Effective Date on or before the SCSSTARTDATE is mapped to a Session Status in the Mode of Study Mapping, derive the mapped HESA code.
7. Derive as default.
8. Derive as NULL ERROR.

Status Valid From (STATUSVALIDFROM)

Return: Data Futures

Entity: Session Status

Page Used:

Page	Page Element
HESA Instance	Effective Date
Records and Enrollment > Career and Program Information > Student Program/Plan	Effective Date
Set Up SACR > Foundation Tables > Term Setup > Term/Session Table > Session Table	Begin Date
Set Up SACR > Foundation Tables > Term Setup > Term/Session Table > Term Table	Term Begin Date

Field Derivation Rule: Include for all entities

Derivation Steps:

1. If STATUSCHANGEDTO is derived as 02 (dormant) for non-returning students in Step 1, derive as the SCSSTARTDATE.

If at least one other Student Course Session entity (with a different SCSESSIONID) exists for the Engagement in submitted data, and the SCSENDDATE for the most recent earlier SCS (by SCSSTARTDATE) is not null, then STATUSVALIDTO is updated to that date plus one day.

2. Derive as SCSSTARTDATE.
3. For subsequent entities only, derive as effective date of the mapped Student Program plan record.

Data Futures Return: Study Location Entity

For each Student Course Session extract record, entities are created if any one of these conditions is true:

- If DISTANCESL is defined in HESA Instance Data, a single entity is derived with derivation step 1 with null derived for VENUEID.
- If StudentCourseSession.STUDYABROAD isn't 01 (full SCS abroad) and StudentCourseSession.PLACEMENT is null and Engagement.ENGPRINONUK is not 01:
 - If VENUEID is defined in the most recent HESA Instance record, a single entity is created with derivation Step 2. Derive STUDYPROPORTION in Step 2 if it's defined in HESA instance. Otherwise, derive STUDYPROPORTION as 100.
 - If one or more Venues are defined in the related Sub-Plan Year or Plan Year HESA Data record, an entity is created for each Venue record with derivation steps for STUDYPROPORTION and VENUEID set to 3 or 5.
 - If one or more Venues are defined in the related Sub-Plan Offering or Plan Offering HESA Data record, an entity is created for each Venue record with derivation steps for STUDYPROPORTION and VENUEID set to 4 or 6.
 - If the Campus value from the most recent Student Program record with an effective date on or before the reporting period end date is defined as the Own Venue ID for a Venue record defined in Institution HESA Data, a single entity is created with the VENUEID derived from that record and STUDYPROPORTION derived as 100 with derivation Step 7.
 - If no entities have been created in the previous steps and default values are defined for both VENUEID and STUDYPROPORTION, a single entity is created with derivation step 8 for both fields.

In each case, DISTANCESL is derived as null in step 2.

Study Abroad and Placement details are recorded in OffVenueActivity.

STUDYLOCID is derived as SCSESSIONID and a sequence number.

Distance Learning (DISTANCESL)

Return: Data Futures

Entity: Study Location

Page Used:

<i>Page</i>	<i>Page Element</i>
HESA Instance	DISTANCESL

Field Derivation Rule: Include for all entities.

Derivation Steps:

1. Derive value from HESA Instance.
2. Derive as null.

Study Proportion (STUDYPROPORTION)

Return: Data Futures

Entity: Study Location

Page Used:

Page	Page Element
HESA Instance Data	STUDYPROPORTION
Plan Offering HESA Data — Venues	Percentage
Plan Year HESA Data — Venues	Percentage
Sub-Plan Offering HESA Data – Venues	Percentage
Sub-Plan Year HESA Data – Venues	Percentage

Field Derivation Rule: Include for all entities.

Derivation Steps:

1. If DISTANCESL isn't null, derive as 100.
2. If VENUEID is derived from HESA Instance in step 2, derive as STUDYPROPORTION from HESA Instance (if it's defined). Otherwise, derive as 100.
3. If the parent Engagement entity is based on a sub-plan, derive value from Sub-Plan Year HESA Data – Venues.
4. If the parent Engagement entity is based on a sub-plan, derive value from Sub-Plan Offering HESA Data – Venues.
5. If the parent Engagement entity is based on a plan, derive value from Plan Year HESA Data — Venues.
6. If the parent Engagement entity is based on a plan, derive value from Plan Offering HESA Data — Venues.
7. If VENUEID is derived from Campus, derive as 100.
8. Use default.

Venue Identifier (VENUEID)

Return: Data Futures

Entity: Study Location

Page Used:

Page	Page Element
Plan Offering HESA Data — Venues	Venue ID
Plan Year HESA Data — Venues	Venue ID
Sub-Plan Offering HESA Data – Venues	Venue ID
Sub-Plan Year HESA Data – Venues	Venue ID
HESA Instance Data	VENUEID
Student Program	Campus
Institution HESA Data – Venues	Venue ID, Own Venue ID

Field Derivation Rule: Include for all entities.

Derivation Steps:

1. If DISTANCESL isn't null, derive as null.
2. Derive from HESA Instance Data.
3. If the parent Engagement entity is based on a sub-plan, derive value from Sub-Plan Year HESA Data – Venues.
4. If the parent Engagement entity is based on a sub-plan, derive value from Sub-Plan Offering HESA Data – Venues.
5. If the parent Engagement entity is based on a plan, derive value from Plan Year HESA Data — Venues.
6. If the parent Engagement entity is based on a plan, derive value from Plan Offering HESA Data — Venues.
7. If the Campus value is defined as the Own Venue ID value for a Venue record for the Institution in Institution HESA Data, derive the Venue ID of that record. If there are multiple Venue records with the same Own Venue ID value, derive the record with the lowest Venue ID.
8. Use default.

Data Futures Return: Supervisor Allocation Entity

For each Student Course Session entity in the extract, entities are derived if these conditions are true:

- The associated Qualification.QUALCAT = D0003, L0000 or L0001.
- Engagement.INCOMINGEXCHANGE is null
- Leaver.ENGENDDATE is null, or is more than 14 days after Engagement.ENGSTARTDATE, or is less than 15 days after Engagement.ENGSTARTDATE and Leaver.RSNENGEND is not 03, 05, 11, or 12.

SUPALLID is derived as SCSESSIONID of the parent Student Course Session and Sequence Number defaulting to 1 for the first entity and incrementing for subsequent entities.

Deriving records from Instance (step 1)

If at least one HESA Research record exists in HESA Instance Data, Records ordered by percentage descending are used to create entities using the SCSESSIONID of the parent Student Course Session along with each Units of Assessment, Collaborating Provider and Percentage value. The extract record status is set to ACTIVE. The Derivation Step for each field is set to 1.

Deriving records from Research Supervisor/Advisor HESA Data (step 2)

1. Research supervisors are selected from the most recent effective dated record (linked to the instance via the research candidate record) where the date is on or before the reporting period end date, and all the following conditions are met:
 - If the Primary Supervisor Only option is selected in HESA Returns Setup, the primary flag of the Research Supervisor record is set.
 - If the Primary Supervisor Only option is *not* selected in HESA Returns Setup, the Supervision Percentage value is greater than zero.
 - If at least one Supervisor Role is defined in HESA Returns Setup, the Supervisor Role matches one of the setup values. If no Supervisor Roles are setup for the return, all roles are considered.
 - The supervisor status matches one of the values defined in HESA Returns Setup.
 - The end date of the supervisor record is not prior to the reporting period start date.
 - The begin date of the supervisor record is not after the reporting period end date.
 - At least one Advisor HESA Data record exists for the supervisor. If no records are found a message is logged.
2. For each selected advisor, the advisor percentage is adjusted to ensure that the total percentage for all selected advisors is 100.
3. Advisor HESA Data records are selected for each supervisor to create entities:
 - For each Advisor HESA Data record, a weighted percentage is calculated based on the unit percentage and the supervisor's adjusted supervision percentage.

- If the same combination of REF Unit 2014, REF Unit 2021, and Collaborating Provider exists for more than one supervisor, the records are merged into a single entity and the weighted percentages added together.
- If the total of all the percentage values does not equal exactly 100 because of rounding during the calculation of adjusted and weighted percentages, the largest value is adjusted to ensure the total is 100.

Deriving records from Student Advisor/Advisor HESA data (step 3)

1. Student advisors are selected from the most recent effective dated record where the date is on or before the reporting period end date and all of the following conditions are met:
 - The Advisor Role defined matches one of the roles defined on the HESA Returns page.
 - The Academic Career and Academic Program match the career and program of the Instance being reported in Student Registration.
 - If the Primary Advisor Only option is selected in HESA Returns Setup, the advisor number is 1.
 - If the Primary Advisor Only option is NOT selected in HESA Returns Setup, the Percentage value is greater than zero.
 - At least one Advisor HESA Data record exists for the advisor. If no records are found a message is logged.
2. If a single eligible advisor is selected, the percentage is set to 100.
3. When there are multiple eligible advisors selected, for each advisor, the percentage is adjusted to ensure that the total for all selected advisors is 100.
4. Advisor HESA Data records are selected for each advisor to create entities:
 - For each Advisor HESA Data record, a weighted percentage is calculated based on the unit percentage and the advisor's adjusted percentage.
 - If the same combination of REF Unit 2014, REF Unit 2021, and Collaborating Provider exists for more than one advisor, the records are merged into a single entity and the weighted percentages added together.
 - If the total of all the percentage values does not equal exactly 100 because of rounding during the calculation of adjusted and weighted percentages, the largest value is adjusted to ensure the total is 100.

Supervisor Allocation HESA Identifier (SUPALLHESAIID)

Return: Data Futures

Entity: Supervisor Allocation

Page Used:

Page	Page Element
HESA Instance Data — Research Data	Collaborating Provider
Advisor HESA Data	Collaborating Provider

Field Derivation Rule: Include for all entities.

Derivation Steps:

1. If the entity is derived from HESA Instance Data – Research Data and a Collaborating Provider is defined, derive that value.
2. If the entity is derived from Research Supervisor/Advisor HESA Data and a Collaborating Provider is defined, derive that value.

If multiple Advisor HESA Data records with the same REF Unit are being merged, then derive the first Collaborating Provider (ordered by code ascending).

3. If the entity is derived from Student Advisor/Advisor HESA Data, derive as Collaborating Provider.

If multiple Advisor HESA Data records with the same REF Unit are being merged, then derive the first Collaborating Provider (ordered by code ascending).

4. Derive as null.

REF 2021 Unit of Assessment (REF2021UNIT)

Return: Data Futures

Entity: Supervisor Allocation

Page Used:

Page	Page Element
HESA Instance Data — Research Data	REF Unit 2021
Advisor HESA Data	REF Unit 2021

Field Derivation Rule: Include for all entities.

Derivation Steps:

1. If the entity is derived from HESA Instance Data – Research Data, derive as REF 2021 Unit.
2. If the entity is derived from Research Supervisor / Advisor HESA Data, derive as REF 2021 Unit.
3. If the entity is derived from Student Advisor / Advisor HESA Data, derive as REF 2021 Unit.

4. Derive as NULL ERROR.

Supervisor Allocation Proportion (SUPALLPROP)

Return: Data Futures

Entity: Supervisor Allocation

Page Used:

Page	Page Element
HESA Instance Data — Research Data	Percentage
Advisor HESA Data	Percentage

Field Derivation Rule: Include for all entities.

Derivation Steps:

1. If the entity is derived from HESA Instance Data – Research Data, derive as Percentage.
2. If the entity is derived from Research Supervisor/Advisor HESA Data, derive as Percentage weighted for multiple supervisors.
3. If the entity is derived from Student Advisor/Advisor HESA Data, derive as Percentage.

Data Futures Return: Entry Qualification Award Entity

For each Entry Profile entity in the extract, one or more entities are created when one of the following conditions is true:

Country = England:

- Qualification.QUALCAT starts with H, I, J or C, or is M0002.
- EntryProfile.HIGHESTQOE begins with P (except for P0013), or is X0000 or X0001.
- The student has an Engagement entity where HIGHESTQUALOE begins with P (except for P0013), is X0000 or X0001.
- EntryProfile.PERMADDCOUNTRY = XF, XG, XH, XI, XK, XL, GG, JE or IM.
- There is at least one Entry Qualification record with Report to HESA = Y in the HESA Instance related to the Engagement entity for the student in the extract.

Undergraduate UCAS entrants from all countries:

- Qualification.QUALCAT starts with H, I, J or C, or is M0002.
- EntryProfile.UCASSCHEMECODE is not null.

- There it at least one Entry Qualification record with Report to HESA = Y in the HESA Instance related to the Engagement entity for the student in the extract.

PGCE/PGDE students where country = Northern Ireland:

- Qualification.QUALCAT = M0016, M0018 or H0013 for the qualification associated with the parent Engagement entity.
- Engagement.INCOMINGEXCHANGE = null.
- When either one of these conditions is true:
 - The student has an External Degree record with Degree Status of Complete and a Degree Date that falls on or before the reporting period end date.
 - There is no External Degree record and at least one Entry Qualification record with Report to HESA = Y and Type = H0000, H0001, H0002, I0000, or I0001 in the HESA Instance related to the Engagement entity for the student in the extract.

If both an External Degree and Entry Qualification record are found, only the External Degree is derived.

For entities created from HESA Instance – Entry Qualification, an entity is created for each record where Report to HESA = Y and the QUALTYPEID code has been imported from HESA (based on the imported flag in SSR_HE_CODES). For the PGCE/PGDE coverage, only records with a first degree QUALTYPEID are included.

For entities created from External Degrees, a single entity is created based on the record with the latest Degree Date on or before the reporting period end date where the Degree is mapped to a QUALTYPEID in the Qualification mapping. If no records exist with a mapped QUALTYPEID, a single entity is created based on the latest Degree Date and the QUALTYPEID field will be derived as NULL ERROR.

ENTRYQUALAWARID is created based on the SID and a sequence number.

Entry Qualification Award Result (ENTRYQUALAWARDRESULT)

Return: Data Futures

Entity: Entry Qualification Award

Pages Used:

Page	Page Element
Entry Profile HESA Data – Entry Qualifications	Result (SSR_HE_QUALGRADE)
Entry Profile HESA Data	ENTRYQUALAWARDRESULT

Field Derivation Rule: Include for all entities

Derivation Steps:

1. If the entity is created from an Entry Qualification record, derive Result from Entry Profile HESA Data.
2. If the entity is created from an External Degree record, derive ENTRYQUALAWARDRESULT from Entry Profile HESA Data.
3. Derive as NULL ERROR.

Own Qualification ID (OWNQUALID)

Return: Data Futures

Entity: Entry Qualification Award

Because there's no identifier for qualifications other than the ID generated for ENTRYQUALAWARID, this field will be derived as null for all entities.

Qualification Result (QUALRESULTEQA)

Return: Data Futures

Entity: Entry Qualification Award

Page Used:

<i>Page</i>	<i>Page Element</i>
Entry Profile HESA Data – Entry Qualifications	Result
Entry Profile HESA Data	QUALRESULTEQA

Field Derivation Rule: Include for all entities.

Derivation Steps:

1. If the entity is created from an Entry Qualification record, derive Result from Entry Profile HESA Data.
2. If the entity is created from an External Degree record, derive QUALRESULTEQA from Entry Profile HESA Data.
3. Derive as NULL ERROR.

Qualification Type Identifier (QUALTYPEID)

Return: Data Futures

Entity: Entry Qualification Award

Page Used:

Page	Page Element
Entry Profile HESA Data – Entry Qualifications	Type
Entry Profile HESA Data	QUALTYPEID

Field Derivation Rule: Include for all entities.

Derivation Steps:

1. If the entity is created from an Entry Qualification record, derive Type value from Entry Profile HESA Data.
2. If the entity is created from an External Degree record, derive QUALTYPEID defined in Entry Profile.
3. If the entity is created from an External Degree record, derive Degree mapped to Type in the Qualification mapping.
4. Derive as NULL ERROR.

Qualification Year (QUALYEAR)

Return: Data Futures

Entity: Entry Qualification Award

Page Used:

Page	Page Element
Entry Profile HESA Data – Entry Qualifications	Award Date
Entry Profile HESA Data – Entry Qualifications	Year
Student Admissions > Application/Transcript Loads > Education > Courses and Degrees	Degree Date

Field Derivation Rule: Include for all entities.

Derivation Steps:

1. If the entity is created from an Entry Qualification record and Award Date has a value, derived the year element.
2. If the entity is created from an Entry Qualification record and Year has a value, derive the value.
3. If the entity is created from an External Degree record, derive the year element of Degree Date.

- 4. Derive as null.

Data Futures Return: Entry Qualification Subject Entity

For each Entry Qualification Award entity in the extract, up to five Subject entities are created based on either Entry Qualifications or External Degree records.

For records derived from Entry Qualifications, a single entity is created using the Subject value.

For records derived from External Degrees, up to five entities are created based on the HECOS1, HECOS2, HECOS3, HECOS4 and HECOS5 fields defined in Entry Profile. If no subjects are defined in Entry Profile a single entity is created with SUBJECTID derived as NULL ERROR.

Subject Identifier (SUBJECTID)

Return: Data Futures

Entity: Entry Qualification Subject

Page Used:

Page	Page Element
Entry Profile HESA Data – Entry Qualifications	Subject
Entry Profile HESA Data	HECOS1
Entry Profile HESA Data	HECOS2
Entry Profile HESA Data	HECOS3
Entry Profile HESA Data	HECOS4
Entry Profile HESA Data	HECOS5

Field Derivation Rule: Include for all entities.

Derivation Steps:

1. If the entity is created from an Entry Qualification record, derive Subject from Entry Profile HESA Data.
2. If the entity is created from an External Degree record, derive HECOS code from Entry Profile.
3. Derive as NULL ERROR.

Data Futures Return: Disability Entity

For each Student entity in the extract, entities are created using either the current value in HESA Person Data or Impairment records if these conditions are met:

- Student has an Engagement entity in the extract where INCOMINGEXCHANGE is null
- Leaver.ENGENDDATE is null, or is more than 14 days after Engagement.ENGSTARTDATE, or is less than 15 days after Engagement.ENGSTARTDATE and Leaver.RSNENGEND is not 03, 05, 11, or 12.

Only one of the following steps is used to create entities:

- If any of the disability fields (DISABILITY to DISABILITY8) are defined in the most recent effective-dated Person HESA Data where the effective date is on or before the reporting period end date, for each DISABILITY field defined an entity is created with derivation step 1.
- An entity is created for each Impairment record for the student where the code is mapped to a HESA DISABILITY code with derivation step 2.
- A single entity is created with DISABILITY derived either from the default value (if defined) with derivation step 3 or as NULL ERROR with derivation step 4. The default value can be defined as 99 (not available).

If all the Engagements for the student are subsequently flagged as dormant, delete the derived entity and associated extract fields.

Disability Type (DISABILITY)

Return: Data Futures

Entity: Disability

Page Used:

Page	Page Element
Person HESA Data	DISABILITY, DISABILITY2 to 8
Personal Information > Health Information > Impairment Regional	Type of Impairment

Field Derivation Rule: Include for all entities

Derivation Steps:

1. Derive value from Person HESA Data.
2. Derive value as the mapped DISABILITY code for the Impairment record.
3. Use default.

4. Derive as NULL ERROR.

Data Futures Return: Qualification Entity

Qualification extract records are created only if the 'Include Course entities' parameter has been selected.

Select HESA Qualification records for the Institution where the Effective Status is "Active" for the most recent row, and the effective date is on or before the reporting period end date.

- If 'Null Errors Only' is selected for Course Entities:
 - Select distinct QUALID values from the existing active Qualification extract data where at least one field in the Qualification, Qualification Subject, or Awarding Body Role has a derived value of NULL ERROR.
 - Restrict the selection based on the selected QUALIDs.
- If 'Validation Errors Only' is selected for Course Entities, all selected Qualifications are included.
- If Academic Plan or Academic Sub-Plan are selected, all selected Qualifications are included.

The QUALID is derived from the selected HESA Qualification record.

Qualification Category (QUALCAT)

Return: Data Futures

Entity: Qualification

Page Used:

<i>Page</i>	<i>Page Element</i>
HESA Qualification	Qualification Category

Field Derivation Rule: Include for all entities

Derivation Steps: Derive from the HESA Qualification page.

Qualification Title (QUALTITLE)

Return: Data Futures

Entity: Qualification

Page Used:

<i>Page</i>	<i>Page Element</i>
HESA Qualification	Qualification Title

Field Derivation Rule: Include for all entities

Derivation Steps:

1. Derive from the HESA Qualification page.
2. Derive as null.

Data Futures Return: Qualification Subject Entity

Extract records are created if the ‘Include Course entities’ parameter has been selected. For each QUALID in the Qualification Extract for the return with an active status, up to 5 entities are created. These are arranged in descending order of percentage, selected by Institution and QUALID from the most recent effective dated HESA Qualification record where the effective date is on or before the reporting period end date record.

If no HECoS Subjects are defined for the Qualification, a single entity is derived using the default value for QUALSUBJECT from HESA Returns Setup (if defined) and QUALPROPORTION = 100, or a single entity is derived with QUALSUBJECT and QUALPROPORTION is derived as NULL ERROR.

Qualification Proportion (QUALPROPORTION)

Return: Data Futures

Entity: Qualification Subject

Page Used:

<i>Page</i>	<i>Page Element</i>
HESA Qualification — HECoS Subjects	Percentage

Field Derivation Rule: Include for all entities

Derivation Step:

1. Derive value from the HESA Qualification percentage.
2. Derive as 100 when QUALSUBJECT is derived as the default value.
3. Derive as NULL ERROR.

Qualification ITT Specialism (QUALITT)

Return: Data Futures

Entity: Qualification Subject

Page Used:

<i>Page</i>	<i>Page Element</i>
HESA Qualification — HECoS Subjects	ITT Subject

Field Derivation Rule: Derive a value if one of the following conditions is met:

- Country = England and at least one associated Course.TTCIDC = 01
- Country = Scotland and at least one associated Course.TTCIDC = 01 and at least one associated Curriculum Accreditation entity exists with CURACCID = 06603 (GTCS Secondary)

Derivation Steps:

1. If ITT Subject is selected on the HESA Qualification – HECoS Subjects page, derive as 01.
2. Derive as null.

Qualification Subject (QUALSUBJECT)

Return: Data Futures

Entity: Qualification Subject

Page Used:

<i>Page</i>	<i>Page Element</i>
HESA Qualification — HECoS Subjects	Subject

Field Derivation Rule: Include for all entities

Derivation Steps:

1. Derive from the HESA Qualification page.
2. Use default.
3. Derive as NULL ERROR.

Data Futures Return: Session Year Entity

Session Year records are created if the **Include Course Entities** check box has been selected.

An entity is created for every active Session Year defined for the institution.

Session Year Identifier (SESSIONYEARID)

Return: Data Futures

Entity: Session Year

Pages Used:

<i>Page</i>	<i>Page Element</i>
Session Years	Session Year ID

Field Derivation Rule: Include for all entities

Derivation Steps: Derive value defined for Session Year.

Own Session Year Identifier (OWNSESSIONYEARID)

Return: Data Futures

Entity: Session Year

Pages Used:

<i>Page</i>	<i>Page Element</i>
Session Years	Own Identifier

Field Derivation Rule: Include for all entities

Derivation Steps:

1. Derive value defined for Session Year.
2. Use default.
3. Derive as null.

Session Year End Date (SYENDDATE)

Return: Data Futures

Entity: Session Year

Pages Used:

<i>Page</i>	<i>Page Element</i>
Session Years	End Date

Field Derivation Rule: Include for all entities

Derivation Steps: Derive value defined for Session Year converted to YYYY-MM-DD format.

Session Year Start Date (SYSTARTDATE)

Return: Data Futures

Entity: Session Year

Pages Used:

<i>Page</i>	<i>Page Element</i>
Session Years	Start Date

Field Derivation Rule: Include for all entities

Derivation Steps: Derive value defined for Session Year converted to YYYY-MM-DD format.

Data Futures Return: Engagement Entity

Engagement is the equivalent of Instance. Entities are created for all Student Program/Plan records that are active where the corresponding HESA Instance record is set to Report To HESA = Y. Records will continue to be included until the Student Program/Plan is completed. The compare logic then determines if the entity needs to be reported to HESA either because some of the data has changed (as compared to the main records), or a child entity needs to be reported.

Note: Before running the extract, the Create Student Identifier and Create Instance processes should be run to create SIDs.

Engagement extract records are created only if the **Include Student Entities** check box has been selected.

If **Student Override** is selected, the selection is restricted based on the defined EMPLID values. For each distinct Student Career:

- Select each HESA Instance record for the institution if Report To HESA = Y.
- Select the most recent relevant effective-dated Student Program record (ACAD_PROG) for the Student Career matched on Academic Institution where the combination of program action and action reason does not appear in the Award Only Mapping for the return.

Action Reason may be blank in Student Plan and Award Only Mapping. This record will be used for further selection and field derivation.

- Select the Student Plan record associated with the selected Student Program record.
- If **Enable Sub-Plan Reporting** is selected in Returns Setup, then select the Student Sub-Plan (from ACAD_SUBPLAN) associated with the Student Plan record selected.

Students starting in the reporting period are considered active if:

- They are term-activated for a term that begins within the reporting period, and have at least one enrollment related to that term.
- They have an FTE value of greater than zero for a period that overlaps the reporting period.

Continuing students are considered active if they have a Program Status defined as eligible for inclusion in Returns Setup.

An entity for the student is created if these conditions are met:

- The student is in the HIN Population. The HIN Population Year value defined in the HESA Instance record matches the Record Year of the Reporting Period associated with the return, and Report to HESA flag of the HESA Instance record is 'Y'.
- The new student is starting in the reporting period, and the HIN Population Only parameter isn't selected.
- The continuing student started before the reporting period and hasn't left or completed as of the start of the reporting period, and the HIN Population Only parameter isn't selected.
- If a sub-plan has been selected, the Sub-Plan is included in the related Course Extract or Course Master records (that is, previously reported).
- If no sub-plan has been selected, the Plan is included in the related Course Extract or Course Master records (that is, previously reported).

School Direct Employing School (EMPLOYING SCHOOL)

Return: Data Futures

Entity: Engagement

Page Used:

Page	Page Element
Program HESA Data (Program Instance HESA Data)	EMPLOYINGSCHOOL
Plan HESA Data (Plan Instance HESA Data)	EMPLOYINGSCHOOL
Sub-Plan HESA Data (Sub-plan Instance HESA Data)	EMPLOYINGSCHOOL
HESA Instance Data	EMPLOYINGSCHOOL

Field Derivation Rule: Derive a value if Engagement.ENTRYRTE = 03 or 10.

If the Engagement is subsequently flagged as dormant, the derived value is updated to null and the derivation step is set to zero.

Derivation Steps:

1. Use constant.
2. Derive value from HESA Instance Data.
3. If entity is based on a sub-plan, derive value from Sub-Plan Instance HESA Data.
4. Derive value from Plan Instance HESA Data.
5. Derive value from Program Instance HESA Data.
6. Use default.
7. Derive as NULL ERROR.

Engagement Start Date (ENGSTARTDATE)

Return: Data Futures

Entity: Engagement

Page Used:

Page	Page Element
HESA Instance Data	Start Date of Instance

Field Derivation Rule: Include for all entities

Derivation Steps:

1. Value as ‘Start Date of Instance’ in the HESA Instance record, if a value has previously been calculated or manually determined and stored
2. If there is a Research Candidate record for the instance, select the Begin Date (SSR_RS_BEGIN_DT) from the most recent active Consumption record where the effective date is on or before the reporting period end date. Derive as the Begin Date formatted to YYYY-MM-DD. Note: The Status and Consumption Indicator values are not considered.

The Research Candidate record (SSR_RS_CAND_HDR) is matched to the instance on EMPLID, Institution, Career and Career Number to find the Research Candidate Number (SSR_RS_CANDIT_NBR). If multiple records are found the record with the highest candidate number is selected.

The consumption records (SSR_RS_CONSMPTN) are associated with the Research Candidate record by EMPLID, Institution and Research Candidate Number.

The calculated value is stored in HESA Instance Data.

SSR_RS_CAND_HDR – PK is EMPLID, INSTITUTION, SSR_RS_CANDIT_NBR – potentially there could be more than one header record for an EMPLID, INSTITUTION, CAREER and CAREER NUMBER

SSR_RS_CONSMPTN – PK is EMPLID, INSTITUTION, SSR_RS_CANDIT_NBR, EFFDT, EFFSEQ

3. Calculated as the earliest Class Start Date for enrolled classes related to the Instance being reported. This selection is similar to that done for StudentOnModule except that it is not restricted to classes overlapping the reporting period and considers enrollments for linked careers:
 - Select activated Terms for the Student Career of the Instance
 - For each activated term, select classes with:
 - o Status = Enrolled
 - o Units Taken is greater than zero
 - o Grading Basis matches one of the values defined for Grading Basis Inclusion with the Extract check box selected in HESA Configuration
 - o Repeat Code is not one of the value defined for Repeat Code Exclusion with the Extract check box selected in HESA Configuration
 - If the student has multiple careers with the same Academic Career value as the career being processed (i.e. same Career but different Career Number) then a further filter is applied to the enrollments. In that case a class is only considered if the program value of the enrollment record (PS_STDNT_ENRL) is null or matches one of the program values in the Student Program records for that career/career number.
 - If the Instance has been linked to a prior Student Career using the ‘Linked Career’ and ‘Linked Career Number’ fields in the HESA Instance record, then classes for the previous career are also considered
 - The earliest Class Start Date from all the selected classes is derived The calculated value is stored in HESA Instance Data.

4. The earliest Effective Date of the HESA Instance Data records.

ITT Entry Route (ENTRYRTEE)

Return: Data Futures

Entity: Engagement

Page Used:

Page	Page Element
Program HESA Data (Program Instance HESA Data)	ENTRYRTEE
Plan HESA Data (Plan Instance HESA Data)	ENTRYRTEE
Sub-Plan HESA Data (Sub-plan Instance HESA Data)	ENTRYRTEE
HESA Instance Data	ENTRYRTEE

Field Derivation Rule: Derive a value if all these conditions are met:

- Country = England
- Related Course.TTCIDC = 01
- INCOMINGEXCHANGE is null

- Leaver.ENGENDDATE is null or is more than 14 days after Engagement.ENGSTARTDATE, or is less than 15 days after Engagement.ENGSTARTDATE and Leaver.RSNENGEND is not 03, 05, 11 or 12.

Derivation Steps:

1. Use constant.
2. Derive from HESA Instance Data.
3. If Instance.COURSEID is based on a sub-plan, derive from Sub-plan Instance HESA Data.
4. Derive from Plan Instance HESA Data.
5. Derive from Program Instance HESA Data.
6. Use default.
7. Derive as NULL ERROR.

Engagement Expected End Date (ENGEXPECTEDENDDATE)

Return: Data Futures

Entity: Engagement

Pages Used:

Page	Page Element
HESA Instance Data	ENGEXPECTEDENDDATE
Student Program	Expected Graduation Term
Term Table — Attributes (Set Up SACR > Foundation Tables > Term Setup > Term/Session Table > Term Table)	Date attribute for ENGEXPECTEDENDDATE
HESA Returns Setup — Common Attributes	Common Attributes

Field Derivation Rule: Derive a value if the following conditions are met:

- Engagement.INCOMINGEXCHANGE is null
- Course.FULLYFLEX is not 01

Derivation Steps:

1. Derive from the HESA Instance page.
2. Derived as the date attribute for the Expected Graduation Term in the most recent Student Program record converted to the YYYY-MM-DD format.

3. Derive as the Term End Date for the Expected Graduation Term in the most recent Student Program record converted to the YYYY-MM-DD format.
4. Use default.
5. Derive as NULL ERROR.

Primarily Outside the UK (ENGPRINONUK)

Return: Data Futures

Entity: Engagement

Pages Used:

Page	Page Element
Program HESA Data	ENGPRINONUK
Plan HESA Data	ENGPRINONUK
Sub-Plan HESA Data	ENGPRINONUK
HESA Instance Data	ENGPRINONUK

Field Derivation Rule: Include for all entities.

Derivation Steps:

1. Derive from HESA Instance Data.
2. If entity is based on a sub-plan, derive from Sub-Plan HESA Data.
3. Derive from Plan HESA Data.
4. Derive from Program HESA Data.
5. Derive as null.

Fee Eligibility (FEEELIGE)

Return: Data Futures

Entity: Engagement

Page Used:

Page	Page Element
Residency Official 1 (Campus Community, Personal Information (Student), Identification (Student), Residency Data, Residency Official 1)	Residency
Program HESA Data (Program Instance HESA Data)	FEEELIGE
Plan HESA Data (Plan Instance HESA Data)	FEEELIGE
Plan Offering/Year HESA	FEEELIGE
Sub-Plan HESA Data (Sub-plan Instance HESA Data)	FEEELIGE
Sub-Plan Offering/Year HESA	FEEELIGE
HESA Instance Data	FEEELIGE
Student Program	Academic Load

Field Derivation Rule: Derive a value if these conditions are met:

- Country = England or Northern Ireland
- Leaver.ENGENDDATE is null or is more than 14 days after Engagement.ENGSTARTDATE, or is less than 15 days after Engagement.ENGSTARTDATE and Leaver.RSNENGEND isn't 03, 05, 11 or 12.

If the Engagement is subsequently flagged as dormant, the derived value is updated to null and the derivation step is set to zero.

Derivation Steps:

1. Derive from HESA Instance Data.
2. If the entity is based on a sub-plan, derive from Sub-Plan Offering/Year HESA based on the Academic Load of the student instance.
3. If entity is based on a sub-plan, derive from Sub-plan Instance HESA Data.
4. Derive from Plan Offering/Year HESA based the Academic Load of the student instance.
5. Derive from Plan Instance HESA Data.
6. Derive from Program Instance HESA Data.
7. Select the student's official Residency value and map to a HESA Fee Eligibility code. Residency records are selected for the EMPLID, Institution, and Academic Career for the most recent Effective Term that starts on or before the end of the reporting period. If the mapping to a HESA code can't be done, an error message is logged.

8. Use default.
9. Derive as NULL ERROR.

Fee Status (FEESTATUS)

Return: Data Futures

Entity: Engagement

Page Used:

Page	Page Element
Residency Official 1 (Campus Community, Personal Information (Student), Identification (Student), Residency Data, Residency Official 1)	Residency
Program HESA Data (Program Instance HESA Data)	FEESTATUS
Plan HESA Data (Plan Instance HESA Data)	FEESTATUS
Plan Offering/Year HESA	FEESTATUS
Sub-Plan HESA Data (Sub-plan Instance HESA Data)	FEESTATUS
Sub-Plan Offering/Year HESA	FEESTATUS
HESA Instance Data	FEESTATUS
HESA Instance	Instance Load
Student Program	Academic Load

Field Derivation Rule: Derive a value if these conditions are met:

- Country = Scotland
- Leaver.ENGENDDATE is null or is more than 14 days after Engagement.ENGSTARTDATE, or is less than 15 days after Engagement.ENGSTARTDATE and Leaver.RSNENGEND isn't 03, 05, 11 or 12.

If the Engagement is subsequently flagged as dormant, the derived value is updated to null and the derivation step is set to zero.

Derivation Steps:

1. Derive from HESA Instance Data.

2. If the entity is based on a sub-plan, derive from Sub-Plan Offering/Year HESA based on the Academic Load of the student instance.
3. If entity is based on a sub-plan, derive from Sub-plan Instance HESA Data.
4. Derive from Plan Offering/Year HESA based on the Academic Load of the student instance.
5. Derive from Plan Instance HESA Data.
6. Derive from Program Instance HESA Data.
7. Select the student's official Residency value and map to a HESA Fee Status code. Residency records are selected for the EMPLID, Institution, and Academic Career for the most recent Effective Term that starts on or before the end of the reporting period. If the mapping to a HESA code can't be done, an error message is logged.
8. Use default.
9. Derive as NULL ERROR.

Incoming Exchange (INCOMINGEXCHANGE)

Return: Data Futures

Entity: Engagement

Page Used:

Page	Page Element
Program HESA Data (Program Instance HESA Data)	INCOMINGEXCHANGE
Plan HESA Data (Plan Instance HESA Data)	INCOMINGEXCHANGE
Plan Offering/Year HESA	INCOMINGEXCHANGE
Sub-Plan HESA Data (Sub-plan Instance HESA Data)	INCOMINGEXCHANGE
Sub-Plan Offering/Year HESA	INCOMINGEXCHANGE
HESA Instance Data	INCOMINGEXCHANGE
HESA Instance Data	Year of Program
HESA Instance Data	Instance Load
Student Program	Academic Load

Field Derivation Rule: Derive a value if these conditions are met:

- Leaver.ENGENDDATE is null or is more than 14 days after Engagement.ENGSTARTDATE, or is less than 15 days after Engagement.ENGSTARTDATE and Leaver.RSNENGEND is not 03, 05, 11 or 12.
- A related CourseInitiative.COURSEINITID is not 027.
- There are no StudentInitiative entities for the Engagement in the extract with STUINITID of 027 or 030.

Derivation Steps:

1. Derive from HESA Instance Data.
2. If the entity is based on a sub-plan, derive from Sub-Plan Offering/Year HESA for the combination of Academic Load and Year of Program of the student instance.
3. If entity is based on a sub-plan, derive from Sub-plan Instance HESA Data.
4. Derive from Plan Offering/Year HESA for the combination of Academic Load and Year of Program of the student instance.
5. Derive from Plan Instance HESA Data.
6. Derive from Program Instance HESA Data.
7. Use default.
8. Derive as null.

Lead School (LEADSCHOOL)

Return: Data Futures

Entity: Engagement

Page Used:

Page	Page Element
Program HESA Data (Program Instance HESA Data)	LEADSCHOOL
Plan HESA Data (Plan Instance HESA Data)	LEADSCHOOL
Sub-Plan HESA Data (Sub-plan Instance HESA Data)	LEADSCHOOL
HESA Instance Data	LEADSCHOOL

Field Derivation Rule: Include when these conditions are met:

- Country = England

- Engagement.ENTRYRTEE = 02, 03, or 10

If the Engagement is subsequently flagged a dormant, the derived value is updated to null and the derivation step is set to zero.

Derivation Steps:

1. Derive value from HESA Instance.
2. If Instance.COURSEID is based on a sub-plan, derive from Sub-Plan Instance HESA Data.
3. Derive from Plan Instance HESA Data.
4. Derive from Program Instance HESA Data.
5. Derive as default.
6. Derive as NULL ERROR.

NHS Employer (NHSEMP)

Return: Data Futures

Entity: Engagement

Pages Used:

<i>Page</i>	<i>Page Element</i>
Program HESA Data	NHSEMP
Plan HESA Data	NHSEMP
Sub-Plan HESA	NHSEMP
HESA Instance	NHSEMP

Field Derivation Rule: Derive a value if the following conditions are met:

- Country = England
- At least one associated CurriculumAccreditation entity associated with the Course with CURACCID = 06919, 11107, or 99902
- Leaver.ENGENDDATE is null, or is more than 14 days after Engagement.ENGSTARTDATE, or is less than 15 days after Engagement.ENGSTARTDATE and Leaver.RSNENGEND isn't 03, 05, 11 or 12.

If the Engagement is subsequently flagged as dormant, the derived value is updated to null and the derivation step is set to zero.

Derivation Steps:

1. Derive from HESA Instance Data.
2. If entity is based on a subplan, derive from the Sub-Plan Instance HESA Data.
3. Derive from the Plan HESA Data.
4. Derive from the Program HESA Data.
5. Use default.
6. Derive as *NULL ERROR*.

Own Engagement Identifier (OWNENGID)

Return: Data Futures

Entity: Engagement

Pages Used:

Page	Page Element
HESA Instance Data	Own Engagement Identifier

Field Derivation Rule: Include for all entities

Derivation Steps:

1. Derive from HESA Instance Data.
2. Use default.
3. Derive as null.

Qualified Teacher Status (QTSE)

Return: Data Futures

Entity: Engagement

Page Used:

Page	Page Element
Program HESA Data (Program Instance HESA Data)	QTSE
Plan HESA Data (Plan Instance HESA Data)	QTSE
Sub-Plan HESA Data (Sub-plan Instance HESA Data)	QTSE

Page	Page Element
HESA Instance Data	QTSE

Field Derivation Rule: Derive a value if all these conditions are met:

- Country = England, Northern Ireland
- Related Course.TTCIDC = 03
- Engagement.INCOMINGEXCHANGE is null
- Leaver.ENGENDDATE is null, or is more than 14 days after Engagement.ENGSTARTDATE, or is less than 15 days after Engagement.ENGSTARTDATE and Leaver.RSNENGEND is not 03, 05, 11 or 12.

Derivation Steps:

1. Use constant.
2. Derive from HESA Instance Data.
3. If entity is based on a sub-plan, derive from Sub-plan Instance HESA Data.
4. Derive from Plan Instance HESA Data.
5. Derive from Program Instance HESA Data.
6. Use default.
7. Derive as NULL ERROR.

Research Council Student Identifier (RCSTDID)

Return: Data Futures

Entity: Engagement

Page Used:

Page	Page Element
External System ID	External System ID
Graduate Research Management > Candidate Management > Consumption and Submission > Additional Information	Attribute (RCSTDID)
HESA Returns Setup > Returns Setup > HESA Types > Common Attributes	Attribute (RCSTDID) Record Context (SSR_RS_CONSMPTN)

Field Derivation Rule: Derive a value if the following conditions are met:

- Qualification.QUALCAT starts with D, E, L, or M (except M0002, M0016 and M0018)
- Engagement.RCSTDNTE is not 9997
- Engagement.INCOMINGEXCHANGE is null
- Leaver.ENGENDDATE is null, or is more than 14 days after Engagement.ENGSTARTDATE, or is less than 15 days after Engagement.ENGSTARTDATE and Leaver.RSNENGEND is not 03, 05, 11 or 12.

Do not derive a value and leave the field blank, if the conditions are not met.

Derivation Steps:

1. If there is a Research Candidate record for the instance, select the value of the CAF attribute defined for RCSTDID in Returns Setup from the most recent active consumption record where the effective date is on or before the reporting period end date.

The Research Candidate record (SSR_RS_CAND_HDR) is matched to the instance on EMPLID, Institution, Career and Career Number to find the Research Candidate Number (SSR_RS_CANDIT_NBR).

The consumption record (SSR_RS_CONSMPTN) is associated with the Research Candidate record by EMPLID, Institution and Research Candidate Number. The CAF record (SSR_RS_CONSP_CA) is associated with the consumption record.

2. Select External System ID records for the person with the External ID Type defined for RCSTDID in the HESA Return Setup record.

The most recent effective dated record with Effective Date on or before the reporting period end date is used.

3. Use default.
4. Derive as null.

Research Council Student (RCSTDNTE)

Return: Data Futures

Entity: Instance

Pages Used:

Page	Page Element
Program HESA Data (Program Instance HESA Data)	RCSTDNTE
Plan HESA Data (Plan Instance HESA Data)	RCSTDNTE

Page	Page Element
Sub-Plan HESA (Sub-plan Instance HESA Data)	RCSTDNTE
HESA Instance Data	RCSTDNTE
Graduate Research Management > Candidate Management > Consumption and Submission > Additional Information	Attribute (RCSTDNTE)
HESA Returns Setup > Returns Setup > HESA Types > Common Attributes	Attribute (RCSTDNTE)

Field Derivation Rule: Derive a value if the following conditions are met:

- Qualification.QUALCAT starts with D, E, L, or M (except M0002, M0016 and M0018)
- Engagement.INCOMINGEXCHANGE
- Leaver.ENGENDDATE is null, or is more than 14 days after Engagement.ENGSTARTDATE, or is less than 15 days after Engagement.ENGSTARTDATE and Leaver.RSNENGEND is not 03, 05, 11 or 12.

Derivation Steps:

1. Use constant.
2. Derive from the HESA Instance Data page.
3. If there is a Research Candidate record for the instance, select the value of the CAF attribute defined for RCSTDNTE in Returns Setup from the most recent active consumption record where the effective date is on or before the reporting period end date.

The Research Candidate record (SSR_RS_CAND_HDR) is matched to the instance on EMPLID, Institution, Career and Career Number to find the Research Candidate Number (SSR_RS_CANDIT_NBR).

The consumption record (SSR_RS_CONSMPTN) is associated with the Research Candidate record by EMPLID, Institution and Research Candidate Number. The CAF record (SSR_RS_CONSP_CA) is associated with the consumption record.

4. If Instance.COURSEID is based on a sub-plan, derive from the Sub-Plan HESA page.
5. Derive from the Plan HESA Data page.
6. Derive from the Program HESA Data page.
7. Use default.
8. Derive as *NULL ERROR*.

Study Intention (STUDYINTENTION)

Return: Data Futures

Entity: Engagement

Page Used:

Page	Page Element
Entry Profile HESA Data	STUDYINTENTION

Field Derivation Rule: Derive a value if these conditions are met:

- The related Qualification.QUALCAT is L0000.
- Leaver.ENGENDDATE is null, or is more than 14 days after Engagement.ENGSTARTDATE, or is less than 15 days after Engagement.ENGSTARTDATE and Leaver.RSNENGEND is not 03, 05, 11 or 12.

Derivation Steps:

1. Derive from the Entry Profile page where the HESA Instance with the highest Registration Number (NUMREG) matches NUMHUS and Report to HESA = Y. The most recent non-future effective dated record is used.
2. Use default.
3. Derive as null.

Teacher Reference Number (TRN)

Return: Data Futures

Entity: Engagement

Page Used:

Page	Page Element
Person Information (Student) > Identification (Student) > External System ID	External System ID

Field Derivation Rule: Derive a value if the following conditions are met:

- Country = England
- Related Course.TTCIDC = 01

Derivation Steps:

1. Select External System ID records for the person with the External System ID Type defined for TRN in the HESA Return Setup record.
2. Use default.
3. Derive as NULL ERROR.

Data Futures Return: Student Initiatives Entity

For each Engagement extract record, an entity is created if STUINITID has a value defined in the latest HESA Instance record where the effective date falls on or before the reporting period end date or at Program, Plan, Plan Offering Year, Sub-Plan, and Sub-Plan Offering Year levels.

Student Initiative (STUINITID)

Return: Data Futures

Entity: Student Initiatives

Page Used:

Page	Page Element
Program HESA Data	STUINITID
Plan HESA Data	STUINITID
Plan Offering Year HESA Data	STUINITID
Sub-Plan HESA Data	STUINITID
Sub-Plan Offering Year HESA Data	STUINITID
HESA Instance Data	STUINITID

Field Derivation Rule: Include for all entities

Derivation Steps:

1. Derive from HESA Instance Data.
2. If the entity is based on a sub-plan, derive from Sub-Plan Offering Year HESA Data for the combination of Academic Load and Year of Program of the student instance.
3. If the entity is based on a sub-plan, derive from Sub-Plan Instance HESA Data.
4. Derive from Plan Offering Year HESA Data based for the combination of Academic Load and Year of Program of the student instance.

5. Derive from Plan Instance HESA Data.
6. Derive from Program Instance HESA Data.

Data Futures Return: Entry Profile Entity

The selection is similar to the Student return.

For each Engagement entity in the extract, a single Entry Profile entity is created if either the Engagement.ENGSTARTDATE value is within the reporting period, or the Entry Profile check box in HESA Instance is selected.

Access Programme (ACCESSPRG)

Return: Data Futures

Entity: Entry Profile

Page Used:

<i>Page</i>	<i>Page Element</i>
HESA Instance Data — Entry Profile	ACCESSPRG

Field Derivation Rule: Derive a value if all conditions are met:

- Country = Scotland
- Engagement.HIGHESTQOE = X0000 or X0001
- Leaver.ENGENDDATE is null, or is more than 14 days after Engagement.ENGSTARTDATE, or is less than 15 days after Engagement.ENGSTARTDATE and Leaver.RSNENGEND is not 03, 05, 11 or 12.

Derivation Steps:

1. Derive from HESA Instance Data — Entry Profile.
2. Use default.
3. Derive as NULL ERROR.

APEL Credits (APELCRD)

Return: Data Futures

Entity: Entry Profile

Page Used:

<i>Page</i>	<i>Page Element</i>
HESA Instance Data — Entry Profile	APELCRD
Program HESA Data	APELCRD
Plan HESA Data	APELCRD

Field Derivation Rule: Derive a value if all conditions are met:

- Country = England
- EntryProfile.CRDPTSTU is not null

Derivation Steps:

1. Derive from the HESA Instance Data — Entry Profile.
2. Derive from Plan HESA Data.
3. Derive from Program HESA Data.
4. Use default.
5. Derive as null.

Care Leaver Type (CARELEAVERE)

Return: Data Futures

Entity: Entry Profile

Page Used:

<i>Page</i>	<i>Page Element</i>
HESA Instance Data — Entry Profile	CARELEAVERE

Field Derivation Rule: Derive a value if one of the following sets of conditions is met:

- Country = England
 - EntryProfile.PERMADDCOUNTRY == XF, XG, XH, XI, XK, XL, GG, JE or IM
 - Qualification.QUALCAT starts with H, I, J or C or is M0002, M0016, M0018 excluding H0009 and H0010
 - Engagement INCOMINGEXCHANGE is null

- Leaver.ENGENDDATE is null, or is more than 14 days after Engagement.ENGSTARTDATE, or is less than 15 days after Engagement.ENGSTARTDATE and Leaver.RSNENGEND is not 03, 05, 11, or 12.
- Country = Northern Ireland
 - EntryProfile. PERMADDCOUNTRY = XF, XG, XH, XI, XK, XL, GG, JE or IM
 - Qualification.QUALCAT starts with H, I, J or C or is M0002, M0016, M0018
 - Engagement ENGSTARTDATE is after 2013-07-31
- Country = Scotland
 - EntryProfile. PERMADDCOUNTRY = XF, XG, XH, XI, XK, XL, GG, JE or IM
 - Engagement INCOMINGEXCHANGE is null
 - Engagement ENGSTARTDATE is after 2013-07-31

If the Country is England and the Engagement is subsequently flagged as dormant, update derived value to null and set the derivation step to zero.

Derivation Steps:

1. Derive from HESA Instance Data — Entry Profile.
2. Use default.
3. Derive as NULL ERROR.

Credit Points Counted Towards Study (CRDPTSTU)

Return: Data Futures

Entity: Entry Profile

Page Used:

Page	Page Element
HESA Instance Data — Entry Profile	CRDPTSTU
Program HESA Data	CRDPTSTU
Plan HESA Data	CRDPTSTU

Field Derivation Rule: Derive a value if Country = England.

Derivation Steps:

1. Derive from HESA Instance Data — Entry Profile.
2. Derive from Plan HESA Data.
3. Derive from Program HESA Data.
4. Use default.
5. Derive as null.

Credit Scheme (CRDSCM)

Return: Data Futures

Entity: Entry Profile

Page Used:

<i>Page</i>	<i>Page Element</i>
HESA Instance Data — Entry Profile	CRDSCM
Program HESA Data	CRDSCM
Plan HESA Data	CRDSCM

Field Derivation Rule: Derive a value if all conditions are met:

- Country = England
- EntryProfile.CRDPTSTU is not null

Derivation Steps:

1. Derive from HESA Instance Data — Entry Profile.
2. Derive from Plan HESA Data.
3. Derive from Program HESA Data.
4. Use default.
5. Derive as NULL ERROR.

Dependant Type (DEPENDANT)

Return: Data Futures

Entity: Entry Profile

Page Used:

<i>Page</i>	<i>Page Element</i>
HESA Instance Data — Entry Profile	DEPENDANT

Field Derivation Rule: Derive a value if all conditions are met:

- Country = Northern Island
- EntryProfile.PERMADDCOUNTRY = XG
- Engagement.INCOMINGEXCHANGE is null
- Leaver.ENGENDDATE is null, or is more than 14 days after Engagement.ENGSTARTDATE

Derivation Steps:

1. Derive from HESA Instance Data — Entry Profile.
2. Use default.
3. Derive as NULL ERROR.

Entry Profile Dependant (ENTPRODEP)

Return Data Futures

Entity: Entry Profile

Page Used:

<i>Page</i>	<i>Page Element</i>
HESA Instance Data — Entry Profile	ENTPRODEP

Field Derivation Rule: Derive a value if these conditions are met:

- Country = Northern Ireland
- EntryProfile.PERMADDCOUNTRY = XG
- Engagement.INCOMINGEXCHANGE is null
- Leaver.ENGENDDATE is null, or is more than 14 days after Engagement.ENGSTARTDATE, or is less than 15 days after Engagement.ENGSTARTDATE and Leaver.RSNENGEND is not 03, 05, 11, or 12.

Derivation Steps:

1. Derive from HESA Instance Data — Entry Profile.
2. Use default.

3. Derive as NULL ERROR.

Estranged Student (ESTRANGED)

Return: Data Futures

Entity: Entry Profile

Page Used:

Page	Page Element
HESA Instance Data — Entry Profile	ESTRANGED

Field Derivation Rule: Derive a value if all conditions are met:

- Country = Scotland
- EntryProfile.PERMADDCOUNTRY = XF, XG, XH, XI, XK, XL, GG, JE or IM
- Qualification.QUALCAT with H, I, J or C or is M0002
- Engagement.ENGSTARTDATE is after 2020-07-31
- Leaver.ENGENDDATE is null, or is more than 14 days after Engagement.ENGSTARTDATE, or is less than 15 days after Engagement.ENGSTARTDATE and Leaver.RSNENGEND is not 03, 05, 11, or 12.
- A related CourseInitiative.COURSEINITID is not 027.
- There are no StudentInitiative entities for the Engagement in the extract with STUINITID of 027 or 030.

Derivation Steps:

1. Derive from HESA Instance Data — Entry Profile.
2. Use default.
3. Derive as NULL ERROR.

Highest Qualification on Entry (HIGHESTQOE)

Return: Data Futures

Entity: Entry Profile

Page Used:

Page	Page Element
HESA Instance Data — Entry Profile	HIGHESTQOE

Field Derivation Rule: Derive a value if these conditions are met:

- Engagement.INCOMINGEXCHANGE is null.
- Leaver.ENGENDDATE is null, or is more than 14 days after Engagement.ENGSTARTDATE, or is less than 15 days after Engagement.ENGSTARTDATE and Leaver.RSNENGEND is not 03, 05, 11, or 12.
- A related CourseInitiative.COURSEINITID is not 027.
- There are no StudentInitiative entities for the Engagement in the extract with STUINITID of 027 or 030.

Derivation Steps:

1. Derive from HESA Instance Data — Entry Profile.
2. Use default.
3. Derive as NULL ERROR.

Marital Status (MARSTATE)

Return: Data Futures

Entity: Entry Profile

Page Used:

Page	Page Element
Personal Information (Student) > Add/Update a Person > Biographical Information > Biographical History	Marital Status
HESA Instance Data — Entry Profile	MARSTATE

Field Derivation Rule: Derive a value if all conditions are met:

- Country = Northern Ireland
- EntryProfile.PERMADDCOUNTRY = XG (Northern Ireland)
- Engagement.INCOMINGEXCHANGE is null
- Leaver.ENGENDDATE is null, or is more than 14 days after Engagement.ENGSTARTDATE, or is less than 15 days after Engagement.ENGSTARTDATE and Leaver.RSNENGEND is not 03, 05, 11, or 12.

Derivation Steps:

1. Derive from HESA Instance Data — Entry Profile.
2. Derive the Marital Status value from the most recent effective-dated active Biographical History record that falls within the reporting period end date. This is mapped to a HESA code using the HESA Marital Status mapping for the institution.
3. Use default.
4. Derive as NULL ERROR.

Parental Education (PAREDE)

Return: Data Futures

Entity: Entry Profile

Page Used:

<i>Page</i>	<i>Page Element</i>
HESA Instance Data — Entry Profile	PAREDE

Field Derivation Rule: Derive a value if any of the following sets of conditions is met:

- Country = England
 - EntryProfile.PERMADDCOUNTRY = = XF, XG, XH, XI, XK, XL, GG, JE or IM
 - Qualification.QUALCAT starts with H, I, J or C or is M0002, M0016, M0018 excluding H0009 and H0010
 - Engagement INCOMINGEXCHANGE is null
 - The most recent Session Status entity (based on STATUSVALIDFROM date) for the current Student Course Session does not have STATUSCHANGED = 02 (dormant) and a STATUSVALIDFROM on or before the StudentCourseSession.SCSSTARTDATE
 - Leaver.ENGENDDATE is null, or is more than 14 days after Engagement.ENGSTARTDATE, or is less than 15 days after Engagement.ENGSTARTDATE and Leaver.RSNENGEND is not 03, 05, 11, or 12
- Country = Northern Ireland
 - EntryProfile.PERMADDCOUNTRY = = XF, XG, XH, XI, XK, XL, GG, JE or IM
 - Engagement ENGSTARTDATE is after 2013-07-31
 - Qualification.QUALCAT starts with H, I, J, or C, or is M0002, M0016 or M0018
- Country = Scotland

- EntryProfile.PERMADDCOUNTRY = = XF, XG, XH, XI, XK, XL, GG, JE or IM
- Qualification. QUALCAT = M0002, H0003, H0004, H0005, I0001, J0000, J0001, J0002, J0003, C0000 or C0001
- StudentCourseSession INTERCALATION is not 01
- Engagement INCOMINGEXCHANGE is null
- Engagement ENGSTARTDATE is after 2007-07-31
- Leaver.ENGENDDATE is null, or is more than 14 days after Engagement.ENGSTARTDATE, or is less than 15 days after Engagement.ENGSTARTDATE and Leaver.RSNENGEND is not 03, 05, 11, or 12
- A related CourseInitiative.COURSEINITID is not 027
- There are no StudentInitiative entities for the Engagement in the extract with STUINITID of 027 or 030

If the Country is England and the Engagement is subsequently flagged as dormant, update derived value to null and set the derivation step to zero.

Derivation Steps:

1. Derive from HESA Instance Data — Entry Profile.
2. Use default.
3. Derive as NULL ERROR.

Country of Permanent Address (PERMADDCOUNTRY)

Return: Data Futures

Entity: Entry Profile

Page Used:

Page	Page Element
Personal Information (Student) > Biographical (Student) > Addresses/Phones > Addresses	Country
Returns Setup > HESA Types	Address Types
HESA Instance Data — Entry Profile	PERMADDCOUNTRY
Residency Self-Report (Campus Community > Personal Information (Student) > Identification (Student) > Residency Data > Residency Self-Report)	Residency Self-Report—State and Country

Field Derivation Rule: Derive a value if Leaver.ENGENDDATE is null, or is more than 14 days after Engagement.ENGSTARTDATE, or is less than 15 days after Engagement.ENGSTARTDATE and Leaver.RSNENGEND is not 03, 05, 11, or 12.

Derivation Steps:

1. Derive from HESA Instance Data — Entry Profile.
2. Derive the Residency Self-Report record with the latest Date Reported prior to COMDATE. If no record is found then select the record with the earliest Date Reported date on or after ENGSTARTDATE.

If a record is found and the Country value is not GBR and is mapped to a HESA Domicile in the HESA Nationality mapping, derive that value. Otherwise, derive the two-character code (COUNTRY_2CHAR) from the Country table (COUNTRY_TBL).
3. Derive the associated HESA Code (e.g. XF, XG, XH, XI) from the UCAS APR Mapping if a Residency Self-Report record is found with Country of GBR and State is defined. If no mapping is found, derive XK.
4. Derive XK if a Residency Self-Report record is found with Country of GBR and State isn't defined.
5. Derive the Country Code from the most recent active effective-dated address record prior to ENGSTARTDATE, and has an Address Type that corresponds with those defined for PERMADDCOUNTRY in Address Types in HESA Returns Setup. If no record is found prior to ENGSTARTDATE, the record with the earliest effective date on or after ENGSTARTDATE with a defined Address Type is selected. If multiple valid addresses are found with the same effective date (for example, when multiple address types are defined), then one will be randomly picked.

The two-character Country Code is derived from the Country table with the exception of GBR where XK (United Kingdom, not otherwise specified) is derived rather than GB which is the ISO two-character code for UK, but is not included in the HESA code set.
6. Use default.
7. Derive as NULL ERROR.

Postcode of Permanent Home Address (PERMADDPOSTCODE)

Return: Data Futures

Entity: Entry Profile

Page Used:

<i>Page</i>	<i>Page Element</i>
Personal Information (Student) > Biographical (Student) > Addresses/Phones > Addresses	Postal Code
Returns Setup > HESA Types	Address Types

Page	Page Element
HESA Instance Data — Entry Profile	PERMADDPOSTCODE

Field Derivation Rule: Derive a value if these conditions are met:

- EntryProfile.PERMADDCOUNTRY = XF, XG, XH, XI, XK, XL, GG, JE or IM
- Leaver.ENGENDDATE is null, or is more than 14 days after Engagement.ENGSTARTDATE, or is less than 15 days after Engagement.ENGSTARTDATE and Leaver.RSNENGEND is not 03, 05, 11, or 12.

Derivation Steps:

1. Derive from HESA Instance Data — Entry Profile.
2. Select the postal code from the most recent effective-dated address record prior to ENGSTARTDATE that has an address type defined for PERMADDCOUNTRY in the address types in HESA Returns Setup. If no record is found prior to ENGSTARTDATE, the record with the earliest effective date on or after ENGSTARTDATE with a defined address type is selected. If multiple valid address are found with the same effective date, then one is randomly selected.

If the derived Postal Code is longer than 8 characters, the step is skipped.

3. Use default.
4. Derive as NULL ERROR.

Previous Provider (PREVIOUSPROVIDER)

Return: Data Futures

Entity: Entry Profile

Page Used:

Page	Page Element
Entry Profile	PREVIOUSPROVIDER

Field Derivation Rule: Derive a value if all conditions are met:

- EntryProfile.PERMADDCOUNTRY = XF, XG, XH, XI, XK, XL, GG, JE or IM
- StudentCourseSession INTERCALATION is not 01
- Engagement.INCOMINGEXCHANGE is null
- Qualification QUALCAT = M0002, H0003, H0004, H0005, I0001, I0007, J0000, J0001, J0002, J0003, C0000 or C0001

- Leaver.ENGENDDATE is null, or is more than 14 days after Engagement.ENGSTARTDATE, or is less than 15 days after Engagement.ENGSTARTDATE and Leaver.RSNENGEND is not 03, 05, 11, or 12.
- A related CourseInitiative.COURSEINITID is not 027.
- There are no StudentInitiative entities for the Engagement in the extract with STUINITID of 027 or 030

Derivation Steps:

1. Derive from Entry Profile page.
2. Use default.
3. Derive as NULL ERROR.

Religious Background (RELIGIOUSBGROUND)

Return: Data Futures

Entity: Entry Profile

Page Used:

<i>Page</i>	<i>Page Element</i>
Person HESA Data	RELIGIOUSBGROUND

Field Derivation Rule: Derive a value if all conditions are met:

- Country = Northern Ireland
- EntryProfile.PERMADDCOUNTRY = XG (Northern Ireland)
- Leaver.ENGENDDATE is null, or is more than 14 days after Engagement.ENGSTARTDATE, or is less than 15 days after Engagement.ENGSTARTDATE and Leaver.RSNENGEND is not 03, 05, 11, or 12.

Derivation Steps:

1. Derive from the most recent effective-dated Person HESA Data, where the effective date is on or before the reporting period end date.
2. Use default.
3. Derive as NULL ERROR.

Socio Economic Classification (SECE)

Return: Data Futures

Entity: Entry Profile

Page Used:

Page	Page Element
HESA Instance Data — Entry Profile	SECE

Field Derivation Rule: Derive a value if all conditions are met:

- EntryProfile.UCASSCHEMECODE is not null
- Qualification.QUALCAT = H, I, J or C or is M0002
- EntryProfile.PERMADDCOUNTRY = XF, XG, XH, XI, XK, XL, GG, JE or IM
- Leaver.ENGENDDATE is null, or is more than 14 days after Engagement.ENGSTARTDATE, or is less than 15 days after Engagement.ENGSTARTDATE and Leaver.RSNENGEND is not 03, 05, 11, or 12.

Derivation Steps:

1. Derive from HESA Instance Data — Entry Profile.
2. Use default.
3. Derive as NULL ERROR.

Standard Occupational Classification 2010 (SOC2010)

Return: Data Futures

Entity: Entry Profile

Page Used:

Page	Page Element
HESA Instance Data — Entry Profile	SOC2010

Field Derivation Rule: Derive a value if all conditions are met:

- Engagement..ENGSTARTDATE is before 2022-08-01
- EntryProfile.UCASSCHEMECODE is not null
- Qualification.QUALCAT = H, I, J or C or is M0002
- EntryProfile.PERMADDCOUNTRY = XF, XG, XH, XI, XK, XL, GG, JE or IM
- Leaver.ENGENDDATE is null, or is more than 14 days after Engagement.ENGSTARTDATE, or is less than 15 days after Engagement.ENGSTARTDATE and Leaver.RSNENGEND is not 03, 05, 11, or 12.

Derivation Steps:

1. Derive from HESA Instance Data — Entry Profile.
2. Use default.
3. Derive as NULL ERROR.

Standard Occupational Classification 2020 (SOC2020)

Return: Data Futures

Entity: Entry Profile

Page Used:

<i>Page</i>	<i>Page Element</i>
HESA Instance Data — Entry Profile	SOC2020

Field Derivation Rule: Derive a value if all conditions are met:

- EntryProfile.UCASSCHEMECODE is not null
- Qualification.QUALCAT = H, I, J or C or is M0002
- EntryProfile.PERMADDCOUNTRY = XF, XG, XH, XI, XK, XL, GG, JE or IM
- Leaver.ENGENDDATE is null, or is more than 14 days after Engagement.ENGSTARTDATE, or is less than 15 days after Engagement.ENGSTARTDATE and Leaver.RSNENGEND is not 03, 05, 11, or 12.

Derivation Steps:

1. Derive from HESA Instance Data — Entry Profile.
2. Use default.
3. If SOC2010 exists and has a derived value, derive as null.
4. Derive as NULL ERROR.

UCAS Scheme Code (UCASSCHEMECODE)

Return: Data Futures

Entity: Entry Profile

Page Used:

Page	Page Element
Application Data (Student Admissions > Application Maintenance > Maintain Applications > Application Data)	External Application Number
Entry Profile	UCASSCHEMECODE

Field Derivation Rule: Derive a value if any one of these conditions is met:

- Country is England or Northern Ireland
- Country = Scotland and Leaver.ENGENDDATE is null, or is more than 14 days after Engagement.ENGSTARTDATE, or is less than 15 days after Engagement.ENGSTARTDATE and Leaver.RSNENGEND is not 03, 05, 11, or 12.

Derivation Steps:

1. Derive from Entry Profile page.
2. Reference the Student Program record for the related Instance with the highest Registration Number to find the admission application number (ADM_APPL_NBR), which is used to reference the Admissions Data record (ADM_APPL_DATA) to find the External Application Number (EXT_ADM_APPL_NBR) that holds the UCAS Application Code plus Choice Number for UCAS applications. To handle change of career between the original UCAS application and the current student program, the matching doesn't consider Career and Career Number.

If the External Application Number is not null and is a UCAS number, that is, a 4-character application code that begins with 'UC' plus '-' plus a single-digit choice number (for example, UC01-1), then the UCAS value minus the '-' and choice elements is derived (for example, UC01). Only values beginning with 'UC' are derived.

3. Use default.
4. Derive as null.

Year Left Last Provider (YRLPPROV)

Return: Data Futures

Entity: Entry Profile

Page Used:

Page	Page Element
Entry Profile	YRLPPROV

Field Derivation Rule: Derive a value if all conditions are met:

- Country = Scotland

- Student Initiatives entity exists with STUINITID = 016 (Articulation)
- Leaver.ENGENDDATE is null, or is more than 14 days after Engagement.ENGSTARTDATE, or is less than 15 days after Engagement.ENGSTARTDATE and Leaver.RSNENGEND isn't 03, 05, 11, or 12.

Derivation Steps:

1. Derive from Entry Profile page.
2. Use default.
3. Derive as NULL ERROR.

Data Futures Return: Qualification Awarded Entity

For each Engagement entity in the extract, entities are created based on either Qualification Awarded records defined in HESA Instance or Student Degree records.

Entities are created if these conditions are met:

- Engagement.INCOMINGEXCHANGE is null.
- Leaver.ENGENDDATE is null, or is more than 14 days after Engagement.ENGSTARTDATE, or is less than 15 days after Engagement.ENGSTARTDATE and Leaver.RSNENGEND is not 03, 05, 11, or 12.
- Select HESA Qualification Awarded records for the HESA Instance record for the Student Registration, or
- Select Student Degree records related to either the Student Plan or the Sub-Plan being reported. If the Sub-Plan is being reported all Degree records associated with the parent Student Plan record are considered.
 - The Student Plan is determined with respect to the most recent non-future effdt record in ACAD_PLAN. Note: For Qualification Awarded the selection includes consideration of rows where the action/reason combination is defined under Award Only Mapping.
 - Degrees are considered if the Degree Status is Awarded and either one of these is true:
 - A QUALAWARDDATE attribute setup for the return is defined for the Student Degree, with a date that falls within the reporting period.
 - There is no QUALAWARDDATE attribute defined in Student Degree and the Confer Date falls within the reporting period.

Note: If the attribute is set up in the return and a value is defined for the Student Degree but the date does not fall within the reporting period, the record won't be included.

For Qualification Awarded (from HESA Instance), the QUALID is selected directly from the record.

For Student Degrees the QUALID is derived as the combination of Degree and Degree Plan record with lowest Plan Sequence. If a sub-plan is being reported (SSR_HE_LEVEL_FLAG = S), the Degree Sub-

Plan with the lowest Sub-Plan Sequence (if defined) is included after the degree plan, or if a plan is being reported (SSR_HE_LEVEL_FLAG = P), the Degree Plan record with next lowest Plan Sequence after the Primary Plan (if defined) is included after the primary degree plan.

The QUALAWARDID is derived as the same value as QUALID (unique identifier for qualification) and is also derived as NULL ERROR if the QUALID doesn't exist in the extract or MST records.

Qualification Awarded Result (QUALAWARDRESULT)

Return: Data Futures

Entity: Qualification Awarded

Pages Used:

Page	Page Element
HESA Instance Data – Qualification Awarded	Result
Records and Enrollment > Graduation > Student Degrees > Degree Honors	Honors Type/Honors Code

Field Derivation Rule: Derive a value if any one of these conditions is met:

- Country = England
- Country = Scotland or Northern Ireland, and Qualification.QUALCAT = M0002, H0003, H0004, H0005, H0009, or I0001 for the QUALID from the current Qualification extract records, or the most recent Qualification submitted data (MST) record.

Derivation Steps:

1. If the entity is derived from Instance HESA Data – Qualifications Awards, derive as the Result value.
2. If the entity is derived from Student Degrees, derive as the Degree Honors Type (DH) and Honors Code mapped to a Result using the HESA Classification mapping. If there are multiple Degree Honors records, the record with the lowest Honors Number is used.
3. Use default, e.g. 9999 Not applicable
4. Derive as NULL ERROR.

Thesis Title (THESISTITLE)

Return: Data Futures

Entity: Qualification Award

Page Used:

Page	Page Element
Graduate Research Management > Thesis Management > Thesis Submission	Thesis Title
Graduate Research Management > Candidate Management > Research Topic	Thesis Title
HESA Instance – Thesis Details	Intended Thesis Title
HESA Instance – Qualification Awarded	Thesis Title

Field Derivation Rule: If the following conditions are met a value is derived:

- Qualification.QUALCAT = D0003 for the QUALID from the current Qualification extract records, or the most recent Qualification submitted data (MST) record.
- Engagement.INCOMINGEXCHANGE does not exist.

Derivation Steps:

1. If the entity is derived from Instance HESA Data – Qualification Awarded, derive as Thesis Title from Qualification Awarded.
2. If the entity is derived from Instance HESA Data – Qualification Awarded, derive as Intended Thesis Title from Thesis Details.
3. If there is a Research Candidate record for the related Instance, derive the Thesis Title from the latest (by EFFDT and EFFSEQ) Thesis Management record.

Note: The Research Candidate record (SSR_RS_CAND_HDR) is matched to the instance on EMPLID, Institution, Career and Career Number to find the Research Candidate Number (SSR_RS_CANDIT_NBR).

The thesis records (SSR_RS_THESIS) are associated with the Research Candidate record by EMPLID, Institution and Research Candidate Number.

4. If there is a Research Candidate record for the related instance, derive the Thesis Title from the latest (by EFFDT and EFFSEQ) Research Topic record for the record with the highest sequence (SSR_RS_TOPIC_SEQ).

Note: The Research Candidate record (SSR_RS_CAND_HDR) is matched to the instance on EMPLID, Institution, Career and Career Number to find the Research Candidate Number (SSR_RS_CANDIT_NBR).

The topic records (SSR_RS_TOPIC) are associated with the Research Candidate record by EMPLID, Institution and Research Candidate Number.

5. Derive as null.

Data Futures Return: Qualification Award Accreditation Entity

For each Qualification Awarded entity in the extract, entities are created based on either the Accreditation value defined in HESA Instance - Qualification Awarded or the Award Accreditation records defined in HESA Qualification for the QualificationAwarded.QUALID.

If the Qualification Awarded entity is derived from HESA Instance – Qualifications Awarded (that is, QUALID is derived in step 1), then derive entities for Accreditation records defined for the award in HESA Instance - Qualification. But if the Qualification Awarded entity is derived from Student Degrees (that is, QUALID is derived in step 2), then derive entities for Award Accreditation records defined in HESA Qualification for the most recent effective dated record where the effective date is on or before the reporting period end date.

Qualification Awarded Accreditation Identifier (QUALAWARDACCID)

Return: Data Futures

Entity: Qualification Award Accreditation

Pages Used:

<i>Page</i>	<i>Page Element</i>
HESA Instance Details - Qualification Awarded	Accreditation ID
HESA Qualification – Award Accreditation	Accreditation ID

Field Derivation Rule: Include for all entities.

Derivation Steps:

1. Derive from HESA Instance - Qualifications Awarded.
2. Derive from HESA Qualification.

Data Futures Return: Student Course Session Entity

For each Engagement entity in the extract, a Student Course Session (SCS) is created if the student is deemed to be “active” for the reporting period.

For new students (those starting in the reporting period), Engagement entities are created only if the student is deemed to be active, that is, their term is activated with enrollment or with FTE. A Student Course Session is created for each student starting in the reporting period, that is, Engagement.ENGSTARTDATE is in the reporting period.

For continuing students (those with ENGSTARTDATE prior to the reporting period), a Student Course Session entity is created if any of the following conditions is met:

- The student has been term-activated for a term that overlaps the reporting period and has at least one enrolled class related to that term.
- For activated terms for the related Student Career, at least one class exists in Student Enrollment (STDNT_ENRL) where Grade In/Official has a value and Grade Date is in the reporting period.
- The student has an FTE value of greater than zero for the reporting period of the return, or for a reporting period that has dates that overlap the reporting period of the return.
- The student hasn't already been reported as interrupted, dormant, or writing up. This occurs if the following conditions are met:
 - There is no StudentCourseSession entity related to the Engagement in submitted data, or the most recent StudentCourseSession entity in submitted data (by latest effective date and then latest SCSSTARTDATE) has a RSNSCSEND value other than 02 (interrupted).
 - There is no SessionStatus entity related to the Engagement in submitted data, or the most recent SessionStatus entity in submitted data (based on latest effective date and then latest STATUSVALIDFROM date) has a STATUSCHANGEDTO value that isn't 02 (dormant) or 04 (writing up).

The Student Course Session ID is created based on the Engagement, Year of Program from HESA Instance, and a sequence number. The child entities that have a unique identifier (Supervisor Allocation and Module Instance) will use the SCSESSIONID plus their own sequence number.

Processing Previous Student Course Session (SCS)

Earlier Student Course Sessions may not have been reported as completed in the previous reporting period. For example, for students who enrolled from February to January, the previous SCS will overlap and finish within the current reporting period.

To create extract entities for previous Student Course Sessions, these conditions must be met:

- Engagement.ENGSTARTDATE is before the reporting period start date (that is, it's a continuing student).
- A current Student Course Session entity has been created in the extract (that is, the student is active, or needs to be reported as dormant).
- The effective date of the Instance row that's used to create the current SCS entity (stored in the Engagement extract record) is after the reporting period start date.
- The latest Instance row prior to the reporting period start date (if one exists) has a Year of Program value that's different from the value of the Instance used to create the current first SCS and an Actual Session End value within the reporting period dates.

The SCS extract record is created with Previous SCS = Y, Instance Date = effective date of the preceding Instance record

Course Identifier (COURSEID)

Return: Data Futures

Entity: Student Course Session

Pages Used:

Page	Page Element
Academic Plan	Code
Academic Sub-Plan	Code

Field Derivation Rule: Include for all entities.

Derivation Steps:

1. If Course Level for Engagement is Sub-Plan, derive Sub-Plan code.
2. Derive Plan code.

Fee Method (FEEMETHOD)

Return: Data Futures

Entity: Student Course Session

Page Used: None

Field Derivation Rule: Fees are reported in SCSFEEAMOUNT and are not reported at Module Instance level in Module Outcome, so FEEMETHOD will be derived as null. The related ModuleOutcome.MIFEEAMOUNT FEEMETHOD field will also be derived as null.

Intended Thesis Title (INTENDEDTHESISTITLE)

Return: Data Futures

Entity: Student Course Session

Page Used:

Page	Page Element
Graduate Research Management > Thesis Management > Thesis Submission	Thesis Title
Graduate Research Management > Candidate Management > Research Topic	
HESA Instance – Thesis Details	Intended Thesis Title

Field Derivation Rule: If all the following conditions are met, derive a value:

- Qualification.QUALCAT = D0003 for the QUALID associated with the Course of the SCS reported in COURSEID

- Engagement.INCOMINGEXCHANGE is null

Derivation Steps:

1. Derive from HESA Instance.
2. If there is a Research Candidate record for the related instance, derive Thesis Title from the latest Thesis Management record.
3. If there is a Research Candidate record for the related instance, derive Thesis Title from the latest Research Topic record for the record with the highest sequence (SSR_RS_TOPIC_SEQ).
4. Derive as null.

Intercalation (INTERCALATION)

Return: Data Futures

Entity: Student Course Session

Page Used:

Page	Page Element
Program HESA Data (Program Instance HESA Data)	INTERCALATION
Plan HESA Data (Plan Instance HESA Data)	INTERCALATION
Plan Offering/Year HESA	INTERCALATION
Sub-Plan HESA Data (Sub-plan Instance HESA Data)	INTERCALATION
Sub-Plan Offering/Year HESA	INTERCALATION
HESA Instance Data	INTERCALATION

Field Derivation Rule: Derive a value if these conditions are met:

- The most recent Session Status entity (based on STATUSVALIDFROM date) does not have STATUSCHANGED = 02 (dormant) and a STATUSVALIDFROM on or before the StudentCourseSession.SCSSTARTDATE
- Leaver.ENGENDDATE is null, or is more than 14 days after Engagement.ENGSTARTDATE, or is less than 15 days after Engagement.ENGSTARTDATE and Leaver.RSNENGEND is not 03, 05, 11, or 12.

Derivation Steps:

1. Derive from HESA Instance Data.

2. If the Course Session is based on a sub-plan, derive from Sub-Plan Offering/Year HESA based on the COURSESESSIONID.
3. If the Course Session is based on a sub-plan, derive from Sub-Plan Instance HESA Data.
4. Derive from Plan Offering/Year HESA based on the COURSESESSIONID.
5. Derive from Plan Instance HESA Data.
6. Derive from Program Instance HESA Data.
7. Use default.
8. Derive as null.

Invoice Fee Amount (INVOICEFEEAMOUNT)

Return: Data Futures

Entity: Student Course Session

Page Used:

Page	Page Element
HESA Instance	INVOICEFEEAMOUNT

Field Derivation Rule: Derive a value using the following sets of conditions:

- England undergraduates
 - Country = England
 - Qualification.QUALCAT starts with H, I, J or C or is M0002, M0016 or M0018
 - Engagement.FEEELIGE = 01 or 03
 - Engagement.INCOMINGEXCHANGE is null
 - The related Course.TTCIDC is not 06
 - Student.SSN is null
 - A Student Initiatives entity does not exist for the Engagement with STUINITID = 004
 - A Course Initiative entity does not exist for the related Course with COURSEINITID = 004
 - The most recent Session Status entity (based on STATUSVALIDFROM date) doesn't have STATUSCHANGED = 02 (dormant) and a STATUSVALIDFROM on or before the StudentCourseSession.SCSSTARTDATE
- England postgraduates
 - Country = England

- Qualification.QUALCAT starts with E or M excluding M0002, M0016 or M0018
 - Engagement.FEELIGE = 01 or 03
 - Engagement.INCOMINGEXCHANGE is null
 - The related Course.TTCIDC is not 06
 - A Student Initiatives entity does not exist for the Engagement with STUINITID = 004
 - A Course Initiative entity does not exist for the related Course with COURSEINITID = 004
 - The most recent Session Status entity (based on STATUSVALIDFROM date) doesn't have STATUSCHANGED = 02 (dormant) and a STATUSVALIDFROM on or before the StudentCourseSession.SCSSTARTDATE
- Country = Northern Ireland:
 - Qualification.QUALCAT starts with H, I, J or C or is M0002, M0016 or M0018 *or* the related Course.PREREQUISITE = 02 and A CurriculumAccreditation entity exists for the Course with CURACCID = 00103
 - The most recent Session Status entity (based on STATUSVALIDFROM date) doesn't have STATUSCHANGED = 02 (dormant) and a STATUSVALIDFROM on or before the StudentCourseSession.SCSSTARTDATE
 - Engagement.FEELIGE = 01 or 03
 - Engagement.INCOMINGEXCHANGE is null
 - Student.SSN is null
 - The most recent Session Status entity (based on STATUSVALIDFROM date) doesn't have STATUSCHANGED = 02 (dormant) and a STATUSVALIDFROM on or before the StudentCourseSession.SCSSTARTDATE
- Country = Scotland
 - Qualification.QUALCAT = M0002, M0016, M0018, H0003, H0004, H0005, H0009, I0001, J0002, J0003, C0000 or C0001
 - Engagement.FEESTATUS = 02
 - Engagement.INCOMINGEXCHANGE is null
 - A CollaborativeProvision entity does not exist for the Engagement with COLPROVTYPEID = 01 or 02
 - Leaver.ENGENDDATE is null, or is more than 14 days after Engagement.ENGSTARTDATE, or is less than 15 days after Engagement.ENGSTARTDATE and Leaver.RSNENGEND is not 03, 05, 11, or 12.

- The most recent Session Status entity (based on STATUSVALIDFROM date) doesn't have STATUSCHANGED = 02 (dormant) and a STATUSVALIDFROM on or before the StudentCourseSession.SCSSTARTDATE

Derivation Steps:

1. Derive from HESA Instance Data.
2. If StudentCourseSession.SCSFEEAMOUNT is not null or NULL ERROR, derive as the same value.
3. Derive as zero.

Invoice HESA Identifier (INVOICEHESAID)

Return: Data Futures

Entity: Student Course Session

Page Used:

Page	Page Element
HESA Instance	INVOICEHESAID
Program HESA Data	INVOICEHESAID
Plan HESA Data	INVOICEHESAID
Plan Offering Year HESA Data	INVOICEHESAID
Sub-Plan HESA Data	INVOICEHESAID
Sub-Plan Offering Year HESA Data	INVOICEHESAID

Field Derivation Rule: Derive a value if these conditions are met:

- Engagement.INCOMINGEXCHANGE is null.
- The most recent Session Status entity (based on STATUSVALIDFROM date) doesn't have STATUSCHANGED = 02 (dormant) and a STATUSVALIDFROM on or before the StudentCourseSession.SCSSTARTDATE.
- Leaver.ENGENDDATE is null, or is more than 14 days after Engagement.ENGSTARTDATE, or is less than 15 days after Engagement.ENGSTARTDATE and Leaver.RSNENGEND is not 03, 05, 11 or 12.

Derivation Steps:

1. Derive from HESA Instance Data.

2. If the entity is based on a sub-plan, derive from Sub-Plan Offering Year HESA Data for the combination of Academic Load and Year of Program of the instance.
3. If the entity is based on a sub-plan, derive from Sub-Plan Instance HESA Data.
4. Derive from Plan Offering Year HESA Data based on the combination of Academic Load and Year of Program of the instance.
5. Derive from Plan Instance HESA Data.
6. Derive from Program Instance HESA Data.
7. Derive as default.
8. Derive as NULL ERROR.

PGR Language Identifier (PGRLANGID)

Return: Data Futures

Entity: Student Course Session

Page Used:

Page	Page Element
HESA Instance	PGRLANGID
Plan HESA Data	PGRLANGID
Plan Offering HESA Data	PGRLANGID
Plan Year HESA Data	PGRLANGID
Sub-Plan HESA Data	PGRLANGID
Sub-Plan Offering HESA Data	PGRLANGID
Sub-Plan Year HESA Data	PGRLANGID
HESA Instance	PGRLANGID Year of Program Instance Load
Student Program	Academic Load

Field Derivation Rule: Derive a value if all conditions are met:

- Country is Northern Ireland or Scotland.
- Qualification.QUALCAT starts with D or L.
- StudentCourseSession.SCSENDDATE has a value.

Derivation Steps:

1. Derive from HESA Instance.
2. If the entity is based on a sub-plan, derive value from Sub-Plan Offering Year HESA Data for the combination of Academic Load and Year of Program of the student instance.
3. If the entity is based on a sub-plan, derive value from Sub-Plan Offering HESA Data for the Academic Load of the student instance
4. If the entity is based on a sub-plan, derive value from Sub-Plan Instance HESA Data.
5. Derive value from Plan Offering Year HESA Data for the combination of Academic Load and Year of Program of the student instance.
6. Derive value from Plan Offering HESA Data for the Academic Load of the student instance.
7. Derive value from Plan Instance HESA Data.
8. Derive value from Program Instance HESA Data.
9. Use default.
10. Derive as null.

PGR Language Percentage (PGRLANGPCT)

Return: Data Futures

Entity: Student Course Session

Page Used:

Page	Page Element
Program HESA Data	PGRLANGPCT
Plan HESA Data	PGRLANGPCT
Plan Offering HESA Data	PGRLANGPCT
Plan Year HESA Data	PGRLANGPCT
Sub-Plan HESA Data	PGRLANGPCT

Page	Page Element
Sub-Plan Offering HESA Data	PGRLANGPCT
Sub-Plan Year HESA Data	PGRLANGPCT
HESA Instance	PGRLANGPCT Year of Program Instance Load
Student Program	Academic Load

Field Derivation Rule: Derive a value if StudentCourseSession.PGRLANGID is not null.

Derivation Steps:

1. Derive from HESA Instance.
2. If the entity is based on a sub-plan, derive value from Sub-Plan Offering Year HESA Data for the combination of Academic Load and Year of Program of the student instance.
3. If the entity is based on a sub-plan, derive value from Sub-Plan Offering HESA Data for the Academic Load of the student instance
4. If the entity is based on a sub-plan, derive value from Sub-Plan Instance HESA Data.
5. Derive value from Plan Offering Year HESA Data for the combination of Academic Load and Year of Program of the student instance.
6. Derive value from Plan Offering HESA Data for the Academic Load of the student instance.
7. Derive value from Plan Instance HESA Data.
8. Derive value from Program Instance HESA Data.
9. Use default.
10. Derive as NULL ERROR.

PhD Submission Date (PHDSUB)

Return: Data Futures

Entity: Student Course Session

Page Used:

Page	Page Element
Records and Enrollment > Career and Program Information > Student Program/Plan	Program Action and Reason
Graduate Research Management > Thesis Management > Thesis Submission	Actual Submission Date
HESA Instance	PHDSUB

Field Derivation Rule: If all the following conditions are met, derive a value:

- Qualification.QUALCAT = D0003 for the QUALID associated with the Course of the SCS reported in COURSEID.
- Engagement.INCOMINGEXCHANGE is null.
- Leaver.ENGENDDATE is null, or is more than 14 days after Engagement.ENGSTARTDATE, or is less than 15 days after Engagement.ENGSTARTDATE and Leaver.RSNENGEND is not 03, 05, 11 or 12.

Derivation Steps:

1. Derive from HESA Instance.
2. If there is a Research Candidate record for the instance, select the earliest Thesis record where Actual Submission Date has a value and the effective date is on or before the reporting period end date. Derive as the Actual Submission Date formatted to YYYY-MM-DD.
3. Select the earliest effective-dated record in the Student Program/Plan stack that has a Program Action and Reason defined in HESA Return Setup – PhD Submission Action Reason Mapping and an effective date on or before the reporting period end date. Derive as the Effective Date of the record formatted to YYYY-MM-DD.
4. Derive as null.

Placement (PLACEMENT)

Return: Data Futures

Entity: Student Course Session

Page Used:

Page	Page Element
Program HESA Data	PLACEMENT
Plan HESA Data	PLACEMENT

Page	Page Element
Plan Offering HESA Data	PLACEMENT
Plan Year HESA Data	PLACEMENT
Sub-Plan HESA Data	PLACEMENT
Sub-Plan Offering HESA Data	PLACEMENT
Sub-Plan Year HESA Data	PLACEMENT
HESA Instance	PLACEMENT Year of Program Instance Load
Student Program	Academic Load

Field Derivation Rule: Include for all entities

Derivation Steps:

1. Derive from HESA Instance.
2. If the entity is based on a sub-plan, derive value from Sub-Plan Offering Year HESA Data for the combination of Academic Load and Year of Program of the student instance.
3. If the entity is based on a sub-plan, derive value from Sub-Plan Offering HESA Data for the Academic Load of the student instance
4. If the entity is based on a sub-plan, derive value from Sub-Plan Instance HESA Data.
5. Derive value from Plan Offering Year HESA Data for the combination of Academic Load and Year of Program of the student instance.
6. Derive value from Plan Offering HESA Data for the Academic Load of the student instance.
7. Derive value from Plan HESA Data.
8. Derive value from Program HESA Data.
9. Use default.
10. Derive as null.

Predicted Full-Time Equivalence (PREDICTEDSTULOAD)

Return: Data Futures

Entity: Student Course Session

Page Used:

Page	Page Element
HESA Instance	Calculated FTE Override FTE Report Zero

Field Derivation Rule: Derive a value if the following conditions are met:

- Country = Scotland
- StudentCourseSession.STULOAD is null
- Leaver.ENGENDDATE is null, or is more than 14 days after Engagement.ENGSTARTDATE, or is less than 15 days after Engagement.ENGSTARTDATE and Leaver.RSNENGEND is not 03, 05, 11 or 12.

Derivation Steps:

1. Derive as zero if the Report Zero check box is selected in the HESA Instance.
2. If the value is greater than zero, override the FTE recorded in HESA Instance Data.
3. Derive calculated FTE in HESA Instance Data.
4. Derive as zero.

Preparatory Student Course Session (PREPFLAG)

Return: Data Futures

Entity: Student Course Session

Page Used:

Page	Page Element
Program HESA Data	PREPFLAG
Plan HESA Data	PREPFLAG
Sub-Plan HESA Data	PREPFLAG
HESA Instance	PREPFLAG

Field Derivation Rule: Include for all entities

Derivation Steps:

1. Derive from HESA Instance.
2. If the entity is based on a sub-plan, derive value from Sub-Plan Instance HESA Data.
3. Derive value from Plan Instance HESA Data.
4. Derive value from Program Instance HESA Data.
5. Use default.
6. Derive as null.

Reason for Student Course Session Ending (RSNSCSEND)

Return: Data Futures

Entity: Student Course Session

Page Used:

Page	Page Element
Records and Enrollment > Career and Program Information > Student Program/Plan	Program Action/Action Reason
HESA Instance	RSNSCSEND

Field Derivation Rule: Derive a value if SCSENDDATE has a value.

Derivation Steps:

1. Derive from HESA Instance.
2. If the latest non-future row in Student Program/Plan has a program action/reason combination that is mapped to a RSNSCSEND value, derive the mapped value.
3. If the most recent SessionStatus entity in the extract or submitted data has STATUSCHANGEDTO = 02 (dormant), derive as 02 (Interrupted).
4. Derive as default.
5. Derive as NULL ERROR.

Student Course Session End Date (SCSENDDATE)

Return: Data Futures

Entity: Student Course Session

Pages Used:

Page	Page Element
Records and Enrollment > Career and Program Information > Student Program/Plan	Program Action/Action Reason
HESA Instance	Actual Session End
Session Years	End Date

Field Derivation Rule: Include for all entities

Derivation Steps:

1. For current SCS: Derive Actual Session End if it's on or before the related Session Year End Date (based on the derived SESSIONYEARID).

For previous SCS: Derive Actual Session End if it's on or before the related Session Year End Date (based on the derived SESSIONYEARID). Otherwise, derive Session Year End Date. If a SESSIONYEARID hasn't been derived, any Actual Session End date value is derived.

Dates are derived in YYYY-MM-DD format.

2. If the latest non-future row in Student Program/Plan (that is, the effective date on or before the reporting period end date) has a program action/reason combination that is mapped to a Session Reason (RSNSCSEND) value other than 02 (Interrupted), the effective date of the record is derived in YYYY-MM-DD format if the date is on or before the reporting period end date.

If there is an associated Session Year derived for SESSIONYEARID, derive the date only if it is on or before the end date of the Session Year.

3. If SESSIONYEARID has been derived, derive the end date for that Session Year if the date falls within the reporting period
4. Derive as null.

Student Course Session Expected End Date (SCSEXPECTEDENDDATE)

Return: Data Futures

Entity: Student Course Session

Page Used:

Page	Page Element
HESA Instance Details	Current Session Year
HESA Instance Details	Expected Session End

Page	Page Element
Session Years	End Date

Field Derivation Rule: Derive a value if all conditions are met:

- Country = Scotland
- StudentCourseSession.SCSENDDATE is null

Derivation Steps:

1. Expected Session End from HESA Instance is derived in YYYY-MM-DD format. If there is an associated Session Year derived for SESSIONYEARID, the date is only derived if it is on or before the end date of the Session Year
2. If SESSIONYEARID has been derived, the end date for the Session Year is derived.
3. Use default value.
4. Derive as NULL ERROR.

Student Course Session Fee Amount (SCSFEEAMOUNT)

Return: Data Futures

Entity: Student Course Session

Page Used:

Page	Page Element
HESA Instance	SCSFEEAMOUNT
Student Financials > Tuition and Fees > Review Fees After Calculation	Amount
Program HESA Data	SCSFEEAMOUNT
Plan HESA Data	SCSFEEAMOUNT
Plan Offering HESA Data	SCSFEEAMOUNT
Plan Year HESA Data	SCSFEEAMOUNT
Sub-Plan HESA Data	SCSFEEAMOUNT
Sub-Plan Offering HESA Data	SCSFEEAMOUNT

Page	Page Element
Sub-Plan Year HESA Data	SCSFEEAMOUNT

Field Derivation Rule: Derive a value if one of the following sets of conditions is met.

Set	Conditions
England Undergraduate	<ul style="list-style-type: none"> • Country = England • Qualification.QUALCAT starts with H, I, J or C, or is M0002, M0016, or M0018 • Engagement.FEELIGE = 01 or 03 • Engagement.INCOMINGEXCHANGE is null • The related Course.TTCID is not 06 • Student.SSN is null • A Student Initiatives entity does not exist for the Engagement with STUINITID = 004 • A Course Initiative entity does not exist for the related Course with COURSEINITID = 004 • The most recent Session Status entity (based on STATUSVALIDFROM date) doesn't have STATUSCHANGED = 02 (dormant) and a STATUSVALIDFROM on or before the StudentCourseSession.SCSSTARTDATE
England Postgraduate	<ul style="list-style-type: none"> • Country = England • Qualification.QUALCAT starts with E or M excluding M0002, M0016, or M0018 • Engagement.FEELIGE = 01 or 03 • Engagement.INCOMINGEXCHANGE is null • The related Course.TTCID is not 06 • A Student Initiatives entity does not exist for the Engagement with STUINITID = 004 • A Course Initiative entity does not exist for the related Course with COURSEINITID = 004 • The most recent Session Status entity (based on STATUSVALIDFROM date) doesn't have STATUSCHANGED = 02 (dormant) and a STATUSVALIDFROM on or before the StudentCourseSession.SCSSTARTDATE

Set	Conditions
Northern Ireland	<ul style="list-style-type: none"> • Country = Northern Ireland • Either Qualification.QUALCAT starts with H, I, J or C or is M0002, M0016 or M0018, <i>or</i> the related Course. PREREQUISITE = 02 and a CurriculumAccreditation entity exists for the Course with CURACCID = 00103. • Engagement.FEELIGE = 01 or 03 • Engagement.INCOMINGEXCHANGE is null • Student.SSN is null • The most recent Session Status entity (based on STATUSVALIDFROM date) doesn't have STATUSCHANGED = 02 (dormant) and a STATUSVALIDFROM on or before the StudentCourseSession.SCSSTARTDATE
Scotland	<ul style="list-style-type: none"> • Country = Scotland • Qualification.QUALCAT = M0002, M0016, M0018, H0003, H0004, H0005, H0009, I0001, J0002, J0003, C0000 or C0001 • Engagement.FEESTATUS = 02 • Engagement.INCOMINGEXCHANGE is null • A CollaborativeProvision entity does not exist for the Engagement with COLPROVTYPEID = 01 or 02 • Leaver.ENGENDDATE is null, or is more than 14 days after Engagement.ENGSTARTDATE, or is less than 15 days after Engagement.ENGSTARTDATE and Leaver.RSNENGEND is not 03, 05, 11 or 12. • The most recent Session Status entity (based on STATUSVALIDFROM date) doesn't have STATUSCHANGED = 02 (dormant) and a STATUSVALIDFROM on or before the StudentCourseSession.SCSSTARTDATE

Derivation Steps:

1. Derive from HESA Instance Data.
2. Derive the total of all the tuition fee charges for the Student Career for terms that start within the reporting period. Fee records where the Item Type Code is 'Charge' and the Account Type is one of those defined with the Tuition check box selected in HESA Returns Setup. The derived value is rounded to the nearest pound.
3. If the entity is based on a sub-plan, derive from Sub-Plan Year HESA Data for the combination of Academic Load and Year of Program of the student instance.

4. If the entity is based on a sub-plan, derive from Sub-Plan Offering HESA Data for the Academic Load of the student instance.
5. If the entity is based on a sub-plan, derive from Sub-Plan Instance HESA Data.
6. If the entity is based on a Plan, derive from Plan Year HESA Data for the combination of Academic Load and Year of Program of the student instance.
7. If the entity is based on a Plan, derive from Plan Offering HESA Data for the Academic Load of the student instance.
8. Derive from Plan Instance HESA Data.
9. Derive from Program Instance HESA Data.
10. Use default.
11. Derive as NULL ERROR.

Student Course Session Mode (SCSMODE)

Return: Data Futures

Entity: Student Course Session

Page Used:

Page	Page Element
HESA Instance	SCSMODE
HESA Instance	Instance Load
Records and Enrollment > Student Term Information > Term Activate a Student > Student Session (STDNT_SESSION)	Approved Academic Load (ACAD_APPR_LOAD)
Records and Enrollment > Student Term Information > Term Activate a Student > Enrollment Limit (STDNT_CAR_TERM)	Approved Academic Load (ACAD_APPR_LOAD)
Records and Enrollment > Career and Program Information > Student Program/Plan (ACAD_PROG)	Academic Load (ACAD_APPR_LOAD)

Field Derivation Rule: Include for all entities

Derivation Steps:

1. Derive SCSMODE values from HESA Instance.
2. If the Instance Load value from the most recent HESA Instance Data record is mapped to a Session Mode in the HESA Mode of Study mapping, derive the value.

- 3. Derive the most recent Student Program/Plan record that has an Effective Date on or before the reporting period end date, and a Program Action and Reason that's mapped to a Session Mode in the Change of Mode Mapping. Unmapped rows are not considered.
- 4. Map the Approved Academic Load from the most recent Student Session record by session begin date for sessions that overlaps the reporting period to a Session Mode using the HESA Mode of Study mapping.

A session is considered to overlap if either the begin date or end date falls within the reporting period, or the begin date is before the reporting period being date and the end date is after the reporting period end date.

- 5. Map the Approved Academic Load from the most recent activated Student Term record by term begin date for terms that overlaps the reporting period to a Session Mode using the HESA Mode of Study mapping.

For new and continuing students term activation is required for a Student Course Session to be included so this step will only be skipped if the Load value is not mapped.

- 6. Map the Academic Load for the most recent effective dated record in Student Program that has an Effective Date on or before the reporting period end date to a Session Mode using the HESA Mode of Study Mapping.
- 7. Derive as NULL ERROR.

Student Course Session Start Date (SCSSTARTDATE)

Return: Data Futures

Entity: Student Course Session

Page Used:

<i>Page</i>	<i>Page Element</i>
HESA Instance	Session Start Date
Session Years	Start Date
Session Years	End Date

Field Derivation Rule: Include for all entities

Derivation Steps:

- 1. Derive Session Start Date from HESA Instance in YYYY-MM-DD format. If there is an associated Session Year derived for SESSIONYEARID, derive the date only if it is on or after the start date of the Session Year and is on or before the end date of the Session Year.
- 2. If SESSIONYEARID has been derived, derive the start date for the Session Year.
- 3. Use default.

- Derive as NULL ERROR.

Session Year Identifier (SESSIONYEARID)

Return: Data Futures

Entity: Student Course Session

Pages Used:

Page	Page Element
HESA Instance Details	Current Session Year
HESA Instance Details	Current Term

Field Derivation Rule: Derive a value if all conditions are met:

- Course.FULLYFLEX is not 01 for the associated Course.
- Qualification.QUALCAT is not C0008, D0003, D0004, E0003, H0018, I0012, J0001, L0000, L0001, L0002, or M0022 for the QUALID associated with the Course.

Derivation Steps:

- If Current Session Year is defined in the current HESA Instance record, derive that value.
- Use the following values to determine which Session Year the student is associated with and determine the SESSIONYEARID for the related Session Year:
 - Institution: Derive value from HESA Instance.
 - Academic Career: Derive value from HESA Instance.
 - Term: If defined, derive Current Term in HESA Instance. Otherwise, derive the most recent activated term (by term begin date) from Student Career Term (STDNT_CAR_TERM) for the Institution and Career where the term begin date is on or before the reporting period end date.
 - Session: If defined for the most recent activated term from Student Career Term for the Institution and Career, derive the earliest Session Code from Student Session (STDNT_SESSION). Otherwise, derive the earliest Session Code based on SESS_BEGIN_DT from SESSION_TBL for the most recent activated term from Student Career Term for Institution and Career.

- Derive as NULL ERROR.

Study Abroad(STUDYABROAD)

Return: Data Futures

Entity: Student Course Session

Page Used:

Page	Page Element
Program HESA Data	STUDYABROAD
Plan HESA Data	STUDYABROAD
Plan Offering HESA Data	STUDYABROAD
Plan Year HESA Data	STUDYABROAD
Sub-Plan HESA Data	STUDYABROAD
Sub-Plan Offering HESA Data	STUDYABROAD
Sub-Plan Year HESA Data	STUDYABROAD
HESA Instance	STUDYABROAD Year of Program Instance Load
Student Program	Academic Load

Field Derivation Rule: Include for all entities

Derivation Steps:

1. Derive from HESA Instance.
2. If the entity is based on a sub-plan, derive from Sub-Plan Year HESA Data for the Academic Load and Year of Program of the student instance.
3. If the entity is based on a sub-plan, derive from Sub-Plan Offering HESA Data for the Academic Load of the student instance.
4. If the entity is based on a sub-plan, derive from Sub-Plan Instance HESA Data.
5. Derive from Plan Year HESA Data for the combination of Academic Load and Year of Program of the student instance.
6. Derive from Plan Offering HESA Data for the Academic Load of the student instance.
7. Derive from Plan Instance HESA Data.
8. Derive from Program Instance HESA Data.
9. Use default.
10. Derive as null.

Student Load (STULOAD)

Return: Data Futures

Entity: Student Course Session

Page Used:

Page	Page Element
HESA Instance	Calculated FTE Override FTE Report Zero

Field Derivation Rule: Derive a value if the following conditions are met:

- Country is Scotland
- SCSENDDATE has a value

Derivation Steps:

1. Derive as zero if the Report Zero check box is selected on the HESA Instance FTE record.
2. Override FTE recorded in HESA Instance if the value is greater than zero
3. Calculate FTE in HESA Instance.
4. Use default.
5. Derive as NULL ERROR.

Programme Year (YEARPRG)

Return: Data Futures

Entity: Student Course Session

Page Used:

Page	Page Element
HESA Instance	Year of Program

Field Derivation Rule: Derive a value if these conditions are met:

- Course.FULLYFLEX isn't 01
- The most recent Session Status entity (based on STATUSVALIDFROM date) does not have STATUSCHANGED = 02 (dormant) and a STATUSVALIDFROM on or before the StudentCourseSession.SCSSTARTDATE

- Leaver.ENGENDDATE is null, or is more than 14 days after Engagement.ENGSTARTDATE, or is less than 15 days after Engagement.ENGSTARTDATE and Leaver.RSNENGEND is not 03, 05, 11 or 12.

Derivation Steps: Derive from HESA Instance.

Data Futures Return: Awarding Body Role Entity

Extract records are created if the ‘Include Course entities’ parameter has been selected.

For each QUALID in the Qualification Extract for the return with an active status, if Country = England or Northern Ireland, *or* the Country = Scotland and QUALCAT isn't C0008, D0004, E0003, H0018, I0012, J0011, L0002 or M0022, entities are created based on the Awarding Body Role records defined for the HESA Qualification reported in the parent Qualification entity. If awarding bodies aren't defined in HESA Qualification and a default value is defined for AWARDINGBODYID in HESA Returns Setup - Fields, a single entity is created.

Awarding Body Identifier (AWARDINGBODYID)

Return: Data Futures

Entity: Awarding Body Role

Page Used:

Page	Page Element
HESA Qualification – Awarding Bodies	Awarding Body

Field Derivation Rule: Include for all entities

Derivation Step:

1. Derive value from HESA Qualification page.
2. Derive default.

Data Futures Return: Funding Body Entity

For each Student Course Session entity in the extract, a single entity is created if these conditions are met and a non-null FUNDINGBODY value can be derived:

- The related Engagement entity in the extract doesn't have FEELIGE = 02 (not eligible to pay home fees) or 03 (eligibility not assessed).
- The related Engagement entity in the extract doesn't have FEESTATUS = 03 (overseas fees) or 04 (eligibility not assessed).

- The related FundingAndMonitoring entity in the extract doesn't have ELQ = 01 (non-exempt ELQ) or 09 (not required).
- The most recent Session Status entity (based on STATUSVALIDFROM date) for the current Student Course Session does not have STATUSCHANGED = 02 (dormant) and a STATUSVALIDFROM on or before the StudentCourseSession.SCSSTARTDATE.
- Leaver.ENGENDDATE is null, or is more than 14 days after Engagement.ENGSTARTDATE, or is less than 15 days after Engagement.ENGSTARTDATE and Leaver.RSNENGEND is not 03, 05, 11 or 12.

Note: FEEELIGE is derived for all Engagements in England and Northern Ireland. FEESTATUS is derived for all Engagements in Scotland. ELQ is derived only for England, whether FEEELIGE = 01 and the student is not PGR or incoming exchange.

Funding Body (FUNDINGBODY)

Return: Data Futures

Entity: Funding Body

Page Used:

Page	Page Element
Program HESA Data (Program Instance HESA Data)	FUNDINGBODY
Plan HESA Data (Plan Instance HESA Data)	FUNDINGBODY
Sub-Plan HESA Data (Sub-plan Instance HESA Data)	FUNDINGBODY
HESA Instance Data	FUNDINGBODY

Field Derivation Rule: Include for all entities

Derivation Steps:

1. Use constant.
2. Derive from HESA Instance.
3. If the related Engagement entity is based on a sub-plan, derive from Sub-Plan HESA Data
4. Derive from Plan HESA Data based on the related Engagement entity.
5. Derive from Program HESA Data based on the related Engagement entity.
6. Use default.
7. Derive as null.

Data Futures Return: Student Entity

For each distinct SID in the Engagement extract records, a single Student entity is created.

Birthdate (BIRTHDTE)

Return: Data Futures

Entity: Student

Page Used:

Page	Page Element
Personal Information (Student) > Add/Update a Person > Biographical Information > Person Information	Date of Birth

Field Derivation Rule: Include for all entities

Derivation Steps:

1. Derive Date of Birth in the format YYYY-MM-DD.
2. Use default.
3. Derive as NULL ERROR.

Carer Type (CARER)

Return: Data Futures

Entity: Student

Page Used:

Page	Page Element
Person HESA Data	CARER

Field Derivation Rule: Derive a value if all conditions are met:

- Country = Scotland
- EntryProfile.PERMADDCOUNTRY = XH; if a value isn't found in the extract, the value is selected from the most recent submitted data record. If there's no value in the submitted data, a value is derived without reference to the field derivation rule.

- Leaver.ENGENDDATE is null, or is more than 14 days after Engagement.ENGSTARTDATE, or is less than 15 days after Engagement.ENGSTARTDATE and Leaver.RSNENGEND is not 03, 05, 11, or 12.

Derivation Steps:

1. Derive value from the most recent effective dated Person HESA Data where the effective date is on or before the reporting period end date.
2. Use default.
3. Derive as NULL ERROR.

Ethnicity (ETHNICS)

Return: Data Futures

Entity: Student

Page Used:

Page	Page Element
Person HESA Data	ETHNICS
Person Information > Biographical > Personal Attributes > Ethnicity	Regulatory Region, Ethnic Group

Field Derivation Rule: Derive a value if any one of these sets of conditions is met:

- First set:
 - EntryProfile.PERMADDCOUNTRY = XF, XG, XH, XI, XK, XL, GG, JE, or IM; if a value isn't found in the extract, the value is selected from the most recent submitted data record. If there's no value in the submitted data, a value is derived without reference to the field derivation rule.
 - There is an Engagement entity in the extract for the student where INCOMINGEXCHANGE is null.
 - Leaver.ENGENDDATE is null, or is more than 14 days after Engagement.ENGSTARTDATE, or is less than 15 days after Engagement.ENGSTARTDATE and Leaver.RSNENGEND is not 03, 05, 11, or 12.
- Second set:
 - Country = England
 - An Engagement entity exists for the student in the extract where the related Course.TTCIDC = 01.
 - There is an Engagement entity in the extract for the student where INCOMINGEXCHANGE is null.

- Leaver.ENGENDDATE is null, or is more than 14 days after Engagement.ENGSTARTDATE, or is less than 15 days after Engagement.ENGSTARTDATE and Leaver.RSNENGEND is not 03, 05, 11, or 12.

If all the Engagements for the student are subsequently flagged as dormant, the derived value is updated to null and the derivation step set to zero.

Derivation Steps:

1. Derive value from Person HESA Data.
2. Select Person Ethnicity records if:
 - A single record exists that record is used.
 - Multiple records exist and one if flagged as Primary that record is used.
 - Multiple records exists and none are flagged as primary, the record with the highest Percentage defined under Ethnicity Detail is used.
 - There is no way to distinguish between multiple records, the most recent record based on last updated date (LASTUPDDTTM from ETHNICITY_DTL) is used.

For the selected record, map the Ethnic Group and Regulatory Region to a HESA code using Ethnic Mapping. If no mapping exists, log an error message and skip to next step.

3. Use default.
4. Derive as NULL ERROR.

First Names (FNAMES)

Return: Data Futures

Entity: Student

Page Used:

Page	Page Element
Personal Information (Student) > Add/Update a Person > Biographical Information > Names	First Name (maximum 30 characters) Middle Name (maximum 30 characters)

Field Derivation Rule: Derive a value if there is an Engagement entity in the extract for the student where INCOMINGEXCHANGE is null.

Derivation Steps:

1. Derive the First Name and Middle Name values of the most recent effective-dated Primary name record that falls within the reporting period.

The maximum length of the derived and reported values in HESA extract data is 60 characters, so if all 30 characters have been used for both First and Middle Name, then the final character of Middle Name will be dropped to allow a space between First and Middle Name elements.

2. Use default.
3. Derive as null.

Gender Identity (GENDERID)

Return: Data Futures

Entity: Student

Page Used:

Page	Page Element
Person HESA Data	GENDERID

Field Derivation Rule: Derive a value if these conditions are met:

- Country = England or Northern Ireland
- Leaver.ENGENDDATE is null, or is more than 14 days after Engagement.ENGSTARTDATE, or is less than 15 days after Engagement.ENGSTARTDATE and Leaver.RSNENGEND is not 03, 05, 11, or 12.

Derivation Step:

1. Derive from the most recent effective-dated Person HESA Data, where the effective date is on or before the reporting period end date.
2. Use default.
3. Derive as NULL ERROR.

Nationality (NATION)

Return: Data Futures

Entity: Student

Page Used:

Page	Page Element
Person HESA Data	NATION

Page	Page Element
Campus Community > Personal Information (Student) > Identification (Student) > Citizenship > Citizenship and Passport	Country

Field Derivation Rule: Derive a value if Leaver.ENGENDDATE is null, or is more than 14 days after Engagement.ENGSTARTDATE, or is less than 15 days after Engagement.ENGSTARTDATE and Leaver.RSNENGEND is not 03, 05, 11, or 12.

If all the Engagements for the student are subsequently flagged as dormant, update the derived value to null then set the derivation step to zero.

Derivation Steps:

1. Derive from the most recent effective-dated Person HESA Data, where the effective date is on or before the reporting period end date.
2. Select Person Citizenship records and pick up the related two-character codes (COUNTRY_2CHAR) from the Country table (COUNTRY_TBL). If a mapping exists in the HESA Nationality Mapping for the CS Country, use the mapped HESA value. Otherwise, use the COUNTRY_2CHAR value.

If a single record is found, derive the CS country or HESA country value.

3. Select Person Citizenship records (as in step 2). If multiple records are found and one has a value of 'GB', derive that value.
4. Select Person Citizenship records (as in step 2). If multiple records are found, none are 'GB' but at least one is flagged as European Union country, then derive the EU country.

If there are multiple EU countries, report the one with the lowest alpha HESA code.

Note: The COUNTRY_TBL contains a flag (EU_MEMBER_STATE) to indicate if the country is a member or the EU.

5. Select Person Citizenship records (as in step 2). If multiple records are found and none are UK or EU, select the lowest alpha code.
6. Use default.
7. If the Country is England or Scotland, derive as NULL ERROR.
8. Derive as null.

Own Student Identifier (OWNSTU)

Return: Data Futures

Entity: Student

Pages Used: None

Field Derivation Rule: Include for all entities.

Derivation Step: Derive as EMPLID.

Note: Although the **OWNSTU** field is optional for HESA reporting, the system derives this field value for all students to assist with record identification.

Religion (RELIGIONS)

Return: Data Futures

Entity: Student

Page Used:

Page	Page Element
Person HESA Data	RELIGIONS
Campus Community > Personal Information > Biographical > Personal Attributes > Religious Preferences	Religious Preference

Field Derivation Rule: Derive a value if these conditions are met:

- Leaver.ENGENDDATE is null, or is more than 14 days after Engagement.ENGSTARTDATE, or is less than 15 days after Engagement.ENGSTARTDATE and Leaver.RSNENGEND is not 03, 05, 11, or 12.
- All related CourseInitiative entities for Engagement entities for the student in the extract have COURSEINITID other than 027.
- There are no StudentInitiative entities for the student in the extract with STUINITID of 027 or 030.

Derivation Steps:

1. Derive from the most recent effective-dated Person HESA Data, where the effective date is on or before the reporting period end date.
2. Derive Religious Preference for the person mapped to a HESA code using HESA Religion Mapping. If the value is not mapped, log an error then skip to the next step.
3. Use default.
4. If Country = England, derive as NULL ERROR.
5. Derive as null.

Scottish Candidate Number (SCN)

Return: Data Futures

Entity: Student

Page Used:

Page	Page Element
External System ID	External System ID

Field Derivation Rule: Derive a value if one of the following set of conditions is met:

- Country = Scotland.
- Entry Profile.PERMADDCOUNTRY = XH (Scotland); if a value isn't found in the extract, the value is selected from the most recent submitted data record. If there's no value in the submitted data, a value is derived without reference to the field derivation rule.
- There is an Engagement entity in the extract related via COURSEID to a Qualification with QUALCAT beginning with H, I, J or C
- Country = England or Northern Ireland.
- EntryProfile.PERMADDCOUNTRY = XH (Scotland) and EntryProfile.UCASSCHEMECODE isn't null; if a value isn't found in the extract, the value is selected from the most recent submitted data record. If no value is found in submitted data, a value is derived without reference to the field derivation rule.
- There's an Engagement entity in the extract related via COURSEID to a Qualification with QUALCAT beginning with H, I, J or C.

Derivation Steps:

1. Select External System ID records for the person with the External ID Type defined for SCN in the HESA Return Setup record. Value should not be 999999999.
2. Use default.
3. Derive as null.

Service Leaver Type (SERLEAVE)

Return: Data Futures

Entity: Student

Page Used:

Page	Page Element
Person HESA Data	SERLEAVE

Field Derivation Rule: Derive a value if all conditions are met:

- Country = Scotland

- Entry Profile.PERMADDCOUNTRY = XH (Scotland); if a value isn't found in the extract, the value is selected from the most recent submitted data record. If there's no value in the submitted data, a value is derived without reference to the field derivation rule.
- Leaver.ENGENDDATE is null, or is more than 14 days after Engagement.ENGSTARTDATE, or is less than 15 days after Engagement.ENGSTARTDATE and Leaver.RSNENGEND is not 03, 05, 11, or 12.
- All related CourseInitiative entities for Engagement entities for the student in the extract have COURSEINITID other than 027.
- There are no StudentInitiative entities for the student in the extract with STUINITID of 027 or 030.

Derivation Steps:

1. Derive from the most recent effective-dated Person HESA Data, where the effective date is on or before the reporting period end date.
2. Use default.
3. Derive as NULL ERROR if there is an Engagement entity in the extract related via COURSEID to a Qualification with QUALCAT beginning with H, I, J, or C, or M0002, M0016 or M0018.
4. Derive as null.

Service Student (SERSTU)

Return: Data Futures

Entity: Student

Page Used:

Page	Page Element
Person HESA Data	SERSTU

Field Derivation Rule: Derive a value if all conditions are met:

- Country = Scotland
- Entry Profile PERMADDCOUNTRY = XH (Scotland); if a value isn't found in the extract, the value is selected from the most recent submitted data record. If there's no value in the submitted data, a value is derived without reference to the field derivation rule.
- Leaver.ENGENDDATE is null, or is more than 14 days after Engagement.ENGSTARTDATE, or is less than 15 days after Engagement.ENGSTARTDATE and Leaver.RSNENGEND is not 03, 05, 11, or 12.
- All related CourseInitiative entities for Engagement entities for the student in the extract have COURSEINITID other than 027.
- There are no StudentInitiative entities for the student in the extract with STUINITID of 027 or 030.

Derivation Steps:

1. Derive from the most recent effective-dated Person HESA Data, where the effective date is on or before the reporting period end date.
2. Use default.
3. If there is an Engagement entity in the extract related via COURSEID to a Qualification with QUALCAT beginning with H, I, J, or C, or M0002, M0016, or M0018, derive as NULL ERROR.
4. Derive as null.

Sex Identifier (SEXIDS)

Return: Data Futures

Entity: Student

Page Used:

<i>Page</i>	<i>Page Element</i>
Personal Information (Student) > Add/Update a Person > Biographical Information > Biographical History	Gender
HESA Student Data/HESA Restricted Data	SEXIDS

Field Derivation Rule: Include for all entities

Derivation Steps:

1. Derive from Person HESA Data.
2. Map the Gender value from the most recent effective dated active Biographical History record that falls within the reporting period to a HESA code via the Gender mapping.
3. If a mapping doesn't exist, then the Gender value defaults as follows:
 - F (Female) to 10
 - M (Male) to 11
4. Use default.
5. Derive as NULL ERROR.

Sexual Orientation (SEXORTS)

Return: Data Futures

Entity: Student

Page Used:

Page	Page Element
Person HESA Data	SEXORTS
Personal (Campus Community, Personal Information, Add/Update a Person)	Sexual Orientation (SCC_SEXUAL_OR_T)

Field Derivation Rule: Derive a value if Leaver.ENGENDDATE is null, or is more than 14 days after Engagement.ENGSTARTDATE, or is less than 15 days after Engagement.ENGSTARTDATE and Leaver.RSNENGEND is not 03, 05, 11, or 12.

Derivation Steps:

1. Derive from the most recent effective-dated Person HESA Data, where the effective date is on or before the reporting period end date.
2. Derive the coded value from the most recent effective-dated active Person Biographic record (SCC_PERS_BIOG) that falls within the reporting period and mapped to a HESA code in the Orientation mapping.
3. Use default.
4. If Country = England or Northern Ireland, derive as NULL ERROR.
5. Derive as null.

Surname at 16 (SNAME16)

Return: Data Futures

Entity: Student

Page Used:

Page	Page Element
Personal Information (Student) > Add/Update a Person > Biographical Information > Names	Last Name (maximum 30 characters)
Personal Information (Student) > Add/Update a Person > Biographical Information > Names > Manage Long Names	Long Last Name (max 150 chars)
Returns Setup > HESA Types	Name Types

Field Derivation Rule: Derive a value if there is an Engagement entity in the extract for the student where INCOMINGEXCHANGE is null.

Derivation Steps:

1. Derive the Long Last Name of 60 characters or fewer, if it exists, of the most recent effective-dated name record that falls on or before the reporting period end date where the Name Type corresponds to a type defined for SNAME16 in Returns Setup > HESA Types.
2. Derive the Last Name of the most recent effective-dated name record that falls on or before the reporting period end date where the Name Type corresponds to a type defined for SNAME16 in Returns Setup > HESA Types.
3. Use default.
4. Derive as null.

Student Support Number (SSN)

Return: Data Futures

Entity: Student

Pages Used:

Page	Page Element
View SLC Student Data	Student Support Number
HESA Instance Data	SSN

Field Derivation Rule: Include for all entities

Derivation Steps:

1. Derive from HESA Instance Data for related Engagement entities included in the extract. If different multiple SSN values are found, select the value from the HESA Instance with the most recent Start Date.
2. Derive the SSN from the most recent Attendance Confirmation Report (ACR) record (that is, highest sequence number) for the EMPLID and institution where:
 - The Aid Year start date falls on or before the reporting period end date.
 - The Aid Year end date is not before the reporting period start date for the reporting period in which Engagement.ENGSTARTDATE falls.
 - At least one row exists for the ACR with Attendance Indicator set to any value other than *S* or *X*.
3. Derive the SSN from the most recent SSAR record (that is, highest sequence number) for the EMPLID and institution where these conditions are true:
 - The Aid Year start date falls on or before the reporting period end date.
 - The Aid Year end date is not before the reporting period start date for the reporting period in which Engagement.ENGSTARTDATE falls.

- A related first attendance confirmation record (SFA_SLC_ATD_CFR) exists.
 - If the UCAS Course Code is defined in the SSAR, then the UCAS Course Code should be linked via a UCAS Course Mapping to the same career and program as an Instance being reported for the student. If the UCAS Course code is not defined in the SSAR, or if there are no UCAS Course Mapping records for the UCAS Course Code, then the SSAR record is assumed to be relevant to the Instance.
4. Use default.
 5. Derive as null.

Student Dependant (STUDEP)

Return: Data Futures

Entity: Student

Page Used:

<i>Page</i>	<i>Page Element</i>
Person HESA Data	STUDEP

Field Derivation Rule: Derive a value if all conditions are met:

- Country = Scotland
- There is an Engagement entity in the extract for the student where INCOMINGEXCHANGE is null
- Leaver.ENGENDDATE is null, or is more than 14 days after Engagement.ENGSTARTDATE, or is less than 15 days after Engagement.ENGSTARTDATE and Leaver.RSNENGEND is not 03, 05, 11, or 12.
- All related CourseInitiative entities for Engagement entities for the student in the extract have COURSEINITID other than 027.
- There are no StudentInitiative entities for the student in the extract with STUINITID of 027 or 030.

If all the Engagements for the student are subsequently flagged as dormant, update the derived value to null then set the derivation step to zero.

Derivation Steps:

1. Derive value from the most recent effective dated Person HESA Data where the effective date is on or before the reporting period end date.
2. Use default.
3. Derive as NULL ERROR.

Surname (SURNAME)

Return: Data Futures

Entity: Student

Page Used:

Page	Page Element
Personal Information (Student) > Add/Update a Person > Biographical Information > Names	Last Name (maximum 30 characters)
Personal Information (Student) > Add/Update a Person > Biographical Information > Names > Manage Long Names	Long Last Name (max 150 chars)

Field Derivation Rule: Derive a value if there is an Engagement entity in the extract for the student where INCOMINGEXCHANGE is null

Derivation Steps:

1. Derive the Long Last Name of 60 characters or fewer, if it exists, of the most recent effective-dated Primary name record that falls on or before the reporting period end date.
2. Derive the Last Name value of the most recent effective dated Primary name record that falls on or before the reporting period end date.
3. Use default.
4. Derive as NULL ERROR.

Transgender (TRANS)

Return: Data Futures

Entity: Student

Page Used:

Page	Page Element
Person HESA Data	GENDERID

Field Derivation Rule: Derive a value if Country = Scotland.

Derivation Steps:

1. Derive from the most recent effective-dated Person HESA Data where the effective date is on or before the reporting period end date.
2. Use default.

- Derive as null.

Term-time Accommodation (TTACCOMS)

Return: Data Futures

Entity: Student

Page Used:

Page	Page Element
Person HESA Data	TTACCOMS

Field Derivation Rule: Derive a value if these conditions are met:

- There is an Engagement entity for the student in the extract where INCOMINGEXCHANGE is null.
- There is a related Student Course Session entity in the extract with SCSMODE = 01, 02, or 03.
- Leaver.ENGENDDATE is null, or is more than 14 days after Engagement.ENGSTARTDATE, or is less than 15 days after Engagement.ENGSTARTDATE and Leaver.RSNENGEND is not 03, 05, 11, or 12.
- All related CourseInitiative entities for Engagement entities for the student in the extract have COURSEINITID other than 027.
- There are no StudentInitiative entities for the student in the extract with STUINITID of 027 or 030.
- At least one Student Course Session entity exists with PLACEMENT not equal to 01 and STUDYABROAD not equal to 01.
- Either no StudyLocation entities exist or at least one StudyLocation entity exists with a null DISTANCESL.

If all the Engagements for the student are subsequently flagged as dormant, update the derived value to null then set the derivation step to zero.

Derivation Steps:

- Derive from the Person HESA Data page.
- Use default
- Derive as NULL ERROR.

Term-time Postcode (TTPCODE)

Return: Data Futures

Entity: Student

Page Used:

Page	Page Element
Person HESA Data	TTPCODE
Addresses (Campus Community, Personal Information (Student), Biographical (Student), Addresses/Phones, Addresses)	Postcode
Returns Setup > HESA Types	Address Types

Field Derivation Rule: Derive a value if these conditions are met:

- There is an Engagement entity for the student in the extract where INCOMINGEXCHANGE is null
- Leaver.ENGENDDATE is null, or is more than 14 days after Engagement.ENGSTARTDATE, or is less than 15 days after Engagement.ENGSTARTDATE and Leaver.RSNENGEND is not 03, 05, 11, or 12.
- All related CourseInitiative entities for Engagement entities for the student in the extract have COURSEINITID other than 027.
- There are no StudentInitiative entities for the student in the extract with STUINITID of 027 or 030.
- At least one Student Course Session entity exists, with PLACEMENT not equal to 01 and STUDYABROAD not equal to 01.
- Either no StudyLocation exists, or at least one StudyLocation exists with a null value for DISTANCESL.

If all the Engagements for the student are subsequently flagged as dormant, update the derived value to null then set the derivation step to zero.

Derivation Steps:

1. Derive from the Person HESA Data page.
2. Select the most recent active effective-dated address record that falls on or before the end of the reporting period, and has an Address Type that corresponds with those defined as the Address Types for TTPCODE in the HESA Returns Setup record. If multiple valid addresses are found with the same effective date, then one is randomly chosen.

Select the most recent address record (exclude records with an effective date greater than the end date of the reporting period) that has one of the UK-related country codes. The record must have an Address Type that corresponds with the Address Type set for TTPCODE in the HESA Types page.

The following country codes are considered as UK-related for the purposes of this derivation: GBR (United Kingdom), ENG (England), XF (England), NIR (Northern Ireland), XG (Northern Ireland), SCT (Scotland), XH (Scotland), WAL (Wales), XI (Wales), XK (UK not otherwise specified), XL (Channel Islands not otherwise specified), GG (Guernsey), GGY (Guernsey), JE (Jersey), JEY (Jersey), IM (Isle of Man), or IMN (Isle of Man).

3. Use default.

4. Derive as null.

UCAS Personal Identifier (UCASPERID)

Return: Data Futures

Entity: Student

Page Used:

Page	Page Element
External System ID	External System ID

Field Derivation Rule: Derive a value if any one of these conditions is met:

- Country is England or Northern Ireland.

Entry Profile UCASSCHEMECODE is not null. If a value isn't found in the extract, the value is selected from the most recent submitted data record. If a value isn't found in submitted data, a value is derived without reference to the field derivation rule.
- Country = Scotland
 - Entry Profile UCASSCHEMECODE is not null. If a value isn't found in the extract, the value is selected from the most recent submitted data record. If a value isn't found in submitted data, a value is derived without reference to the field derivation rule.
 - Leaver.ENGENDDATE is null, or is more than 14 days after Engagement.ENGSTARTDATE, or is less than 15 days after Engagement.ENGSTARTDATE and Leaver.RSNENGEND is not 03, 05, 11, or 12.

Derivation Steps:

1. Select External System ID records for the person with the External System ID Type defined for UCASPERID in the HESA Returns Setup record.

The most recent effective-dated record whose Effective Date is on or before the reporting period end date is used.

2. Use default.
3. Derive as NULL ERROR.

Unique Learner Number (ULN)

Return: Data Futures

Entity: Student

Page Used:

<i>Page</i>	<i>Page Element</i>
External System ID	External System ID

Field Derivation Rule: Include for all Student entities.

Derivation Steps:

1. Select External System ID records for the person with the External ID Type defined for ULN in the HESA Returns Setup page.

The most recent effective-dated record whose Effective Date is on or before the reporting period end date is used.

Validate the derived value using the checksum method. If the value is invalid, an error message is logged and the derivation skips to the next step. For information on the checksum method, refer to the Notes section for the ULN field available on the HESA website.

2. Derive as NULL ERROR if Country = England and either condition is true:
 - A StudentInitiatives entity in the extract for the student with STUINITID = 004
 - An Engagement entity in the extract for the student linked via COURSEID to a Course entity with a related CourseInitiative entity with COURSEINITID = 004
3. Use default.
4. Derive as null.

Data Futures Return: Venue Entity

Venue extract records are only created if the 'Include Course entities' parameter is selected.

An entity is created for each Venue ID defined in Institution HESA Data from the most recent effective-dated record, where the effective date is on or before the reporting period end date.

Own Venue Identifier (OWNVENUEID)

Return: Data Futures

Entity: Venue

Page Used:

<i>Page</i>	<i>Page Element</i>
Institution HESA Data — Venues	Own Venue ID

Field Derivation Rule: Include for all entities.

Derivation Step:

1. Derive value from Venue.
2. Derive as null.

Postcode (POSTCODE)

Return: Data Futures

Entity: Venue

Page Used:

<i>Page</i>	<i>Page Element</i>
Institution HESA Data — Venues	Postcode

Field Derivation Rule: Include for all entities.

Derivation Step: Derive value from Venue.

Venue Name (VENUENAME)

Return: Data Futures

Entity: Venue

Page Used:

<i>Page</i>	<i>Page Element</i>
Institution HESA Data — Venues	Venue Name

Field Derivation Rule: Include for all entities.

Derivation Step: Derive value from Venue.

Venue UKPRN (VENUEUKPRN)

Return: Data Futures

Entity: Venue

Page Used:

<i>Page</i>	<i>Page Element</i>
Institution HESA Data — Venues	UKPRN

Field Derivation Rule: Derive if Country = England.

Derivation Steps:

1. Derive value from Venue.
2. Derive as UKPRN for the provider institution from HESA Configuration.

Data Futures Return: Off Venue Activity Entity

For each Student Course Session in the extract, entities are created based on Off Venue Activity records defined for the most recent effective-dated HESA Instance record where the effective date falls on or before the reporting period end date. Records are not included if the Start Date is after the reporting period end date. Records without Start Dates are included.

If no entities are created from HESA Instance and a default value is defined for ACTTYPEID in returns setup, a single entity is created using default, null, or NULL ERROR values.

The OVAID unique identifier is derived as SCSESSIONID (unique identifier for parent Student Course Session) + Sequence Number, defaulting to 1 for the first entity and incremented for subsequent entities.

Activity Duration Amount (ACTDURATION)

Return: Data Futures

Entity: Off Venue Activity

Page Used:

<i>Page</i>	<i>Page Element</i>
Off Venue Activity (Records and Enrollment > Career and Program > Information > HESA Instance Details > Mobility)	Duration

Field Derivation Rule: Include for all entities.

Derivation Step:

1. Derive value from HESA Instance — Off Venue Activity.
2. Use default.
3. Derive as NULL ERROR.

Activity Duration Type (ACTDURATIONTYPE)

Return: Data Futures

Entity: Off Venue Activity

Page Used:

<i>Page</i>	<i>Page Element</i>
Off Venue Activity (Records and Enrollment > Career and Program > Information > HESA Instance Details > Mobility)	Duration Type

Field Derivation Rule: Include for all entities.

Derivation Step:

1. Derive value from HESA Instance — Off Venue Activity.
2. Use default.
3. Derive as NULL ERROR.

Activity End Date (ACTENDDATE)

Return: Data Futures

Entity: Off Venue Activity

Page Used:

<i>Page</i>	<i>Page Element</i>
Off Venue Activity (Records and Enrollment > Career and Program > Information > HESA Instance Details > Mobility)	End Date

Field Derivation Rule: Include for all entities.

Derivation Steps:

1. Derive value from HESA Instance — Off Venue Activity, converted to YYYY-MM-DD.
2. Use default.
3. Derive as null.

Activity Start Date (ACTSTARTDATE)

Return: Data Futures

Entity: Off Venue Activity

Page Used:

<i>Page</i>	<i>Page Element</i>
Off Venue Activity (Records and Enrollment > Career and Program > Information > HESA Instance Details > Mobility)	Start Date

Field Derivation Rule: Include for all entities.

Derivation Steps:

1. Derive value from HESA Instance — Off Venue Activity, converted to YYYY-MM-DD.
2. Use default.
3. Derive as null.

Activity Type Identifier (ACTTYPEID)

Return: Data Futures

Entity: Off Venue Activity

Page Used:

<i>Page</i>	<i>Page Element</i>
Off Venue Activity (Records and Enrollment > Career and Program > Information > HESA Instance Details > Mobility)	Activity Type

Field Derivation Rule: Include for all entities.

Derivation Step:

1. Derive value from HESA Instance — Off Venue Activity.
2. Use default.

Country (COUNTRY)

Return: Data Futures

Entity: Off Venue Activity

Page Used:

Page	Page Element
Campus Community > Organization > Create/Maintain Organizations > Organization Location	Country
Off Venue Activity (Records and Enrollment > Career and Program > Information > HESA Instance Details > Mobility)	External Org ID
Off Venue Activity (Records and Enrollment > Career and Program > Information > HESA Instance Details > Mobility)	Country

Field Derivation Rule: Include for all entities.

Derivation Step:

1. Derive value from HESA Instance — Off Venue Activity.
2. If an Ext Org ID is defined, derive from the Country value defined for the primary location from the most recent effective-dated Organization Table and Organization Location records. The 3-character country code is converted to the 2-character country code defined in the Country Table.
3. Use default.
4. Derive as NULL ERROR.

Host Identifier (HOSTID)

Return: Data Futures

Entity: Off Venue Activity

Page Used:

Page	Page Element
Campus Community > Organization > Create/Maintain Organizations > Organization Table	UKPRN, Unique Reference Number, Companies House Number, National Health Service ID, Host ID
Off Venue Activity (Records and Enrollment > Career and Program > Information > HESA Instance Details > Mobility)	External Org ID
Off Venue Activity (Records and Enrollment > Career and Program > Information > HESA Instance Details > Mobility)	Host ID Type

Field Derivation Rule: Derive a value if ACTTYPEID = 01 (TT placement) or 04 (studying).

Derivation Steps:

1. Derive value from HESA Instance — Off Venue Activity.
2. If an External Org ID is defined, derive UKPRN from the most recent effective dated Organization Table record.
3. If an External Org ID is defined, derive Unique Reference Number from the most recent effective dated Organization Table record.
4. If an External Org ID is defined, derive the Host ID from the most recent effective dated Organization Table record.
5. Use default.
6. Derive as NULL ERROR.

Host Identifier Type (HOSTIDTYPE)

Return: Data Futures

Entity: Off Venue Activity

Page Used:

Page	Page Element
Campus Community > Organization > Create/Maintain Organizations > Organization Table	UKPRN, Unique Reference Number, Companies House Number, National Health Service ID, Host ID
Off Venue Activity (Records and Enrollment > Career and Program > Information > HESA Instance Details > Mobility)	External Org ID
Off Venue Activity (Records and Enrollment > Career and Program > Information > HESA Instance Details > Mobility)	Host ID Type

Field Derivation Rule: Derive a value if ACTTYPEID = 01 (TT placement) or 04 (studying).

Derivation Steps:

1. Derive value from HESA Instance — Off Venue Activity.
2. If an External Org ID is defined and UKPRN is defined in the most recent effective dated Organization Table record, derive 01.
3. If an External Org ID is defined and Unique Reference Number is defined in the most recent effective dated Organization Table record, derive 02.
4. If an External Org ID is defined and Host ID is defined in the most recent effective dated Organization Table record, derive 05.

5. Use default.
6. Derive as NULL ERROR.

Mobility Scheme (MOBScheme)

Return: Data Futures

Entity: Off Venue Activity

Page Used:

Page	Page Element
Campus Community > Organization > Create/Maintain Organizations > Organization Table	Scheme

Field Derivation Rule: Include for all entities

Derivation Step:

1. Derive value from HESA Instance — Off Venue Activity.
2. Use default.
3. Derive as NULL ERROR.

Module Instance Identifier (MODINSTID)

Return: Data Futures

Entity: Off Venue Activity

Page Used:

Page	Page Element
Campus Community > Organization > Create/Maintain Organizations > Organization Table	Module Instance

Field Derivation Rule: Include for all entities

Derivation Steps:

1. Derive value from HESA Instance — Off Venue Activity.
2. Use default.
3. Derive as null.

Data Futures Return: Collaborative Provision Entity

For each Engagement entity in the extract, a single Collaborative Provision entity is created based on the defined COLPROVTYPEID if Leaver.ENGENDDATE is null, or is more than 14 days after Engagement.ENGSTARTDATE, or is less than 15 days after Engagement.ENGSTARTDATE and Leaver.RSNENGEND is not 03, 05, 11, or 12.

Entities are created using one of these steps. If an entity is created in a step, the subsequent steps are skipped.

1. An entity is created if COLPROVTYPEID is defined in the most recent HESA Instance record for the Engagement entity.
2. An entity is created if COLPROVTYPEID is defined for the most recent effective-dated Sub-Plan HESA Data record for the Engagement entity.
3. An entity is created if COLPROVTYPEID is defined for the most recent effective-dated Plan HESA Data record for the Engagement entity.
4. An entity is created if COLPROVTYPEID is defined for the most recent effective-dated Program HESA Data record of the Engagement entity.

If COLPROVTYPEID isn't defined, entities aren't created.

If the Engagement is subsequently flagged as dormant, the derived value is updated to null and the derivation step is set to zero.

Collaborative Provision Type (COLPROVTYPEID)

Return: Data Futures

Entity: Collaborative Provision

Page Used:

Page	Page Element
Program HESA Data	COLPROVTYPEID
Plan HESA Data	COLPROVTYPEID
Sub-Plan HESA Data	COLPROVTYPEID
HESA Instance Data	COLPROVTYPEID

Field Derivation Rule: Derive for all entities.

Derivation Steps:

1. Derive from HESA Instance Data.

2. Derive from Sub-Plan HESA Data.
3. Derive from Plan HESA Data.
4. Derive from Program HESA Data.

Partner NUMHUS (PARTNERNUMHUS)

Return: Data Futures

Entity: Collaborative Provision

Page Used:

<i>Page</i>	<i>Page Element</i>
HESA Instance Data	PARTNERNUMHUS

Field Derivation Rule: Include for all entities.

Derivation Steps:

1. Derive from HESA Instance Data.
2. Derive as null.

Partner SID (PARTNERSID)

Return: Data Futures

Entity: Collaborative Provision

Page Used:

<i>Page</i>	<i>Page Element</i>
HESA Instance Data	PARTNERSID

Field Derivation Rule: Include for all entities.

Derivation Steps:

1. Derive from HESA Instance Data.
2. Derive as null.

Partner UKPRN (PARTNERUKPRN)

Return: Data Futures

Entity: Collaborative Provision

Page Used:

Page	Page Element
HESA Instance Data	PARTNERUKPRN

Field Derivation Rule: Include for all entities.

Derivation Steps:

1. Derive from HESA Instance Data.
2. Derive as null.

Data Futures Return: Student Accreditation Aim Entity

For each Engagement entity in the extract, a single entity is created when any one of these conditions is true:

- Country = England *and* Course.TTCIDC = 01 or 02 for the Course entity related via COURSEID for the parent Engagement entity (stored in Engagement extract but reported as part of Student Course Session).
- The related Course for the Engagement has at least one Curriculum Accreditation entity in the extract or submitted data (CURACCID in the range 05802 to 05809, or in the range 06901 to 06920, or in the range 11101 to 11108).

Student Accreditation Aim Accreditation Identifier (STUACCID)

Return: Data Futures

Entity: Student Accreditation Aim

Page Used:

Page	Page Element
Program HESA Data	STUACCID
Plan HESA Data	STUACCID
Sub-Plan HESA Data	STUACCID
HESA Instance	STUACCID

Note: This field is included as ITTPHSC in the XML file.

Field Derivation Rule: Include for all entities

Derivation Step:

1. Derive from HESA Instance Data.
2. Derive from Sub-Plan HESA Data.
3. Derive from Plan HESA Data.
4. Derive from Program HESA Data.
5. Derive as NULL ERROR.

Data Futures Return: Student Financial Support Entity

For each Student Course Session entity in the extract, entities are derived based if these conditions are met:

- The most recent Session Status entity (based on STATUSVALIDFROM date) for the current Student Course Session of the current Engagement doesn't have STATUSCHANGED = 02 (dormant) and a STATUSVALIDFROM on or before the StudentCourseSession.SCSSTARTDATE.
- Leaver.ENGENDDATE is null, or is more than 14 days after Engagement.ENGSTARTDATE, or is less than 15 days after Engagement.ENGSTARTDATE and Leaver.RSNENGEND isn't 03, 05, 11 or 12.

Entities are derived based on these conditions:

- Financial Support records defined for the most recent non-future HESA Instance record for the Registration. Only records with Support Type populated are selected. The derivation step for the related fields is set to 1.
- Whether the student has a Support Service Request value defined in the Impairment record, and that value is mapped to a Support Type code in the Disability Allowance mapping, and FINSUPTYPE value (i.e., 100) hasn't been extracted from Financial Support. A single entity is created using the mapped FINSUPTYPE code. The derivation step for the related fields is set to 2.
- If no entities have been created from the previous steps and a default value is defined for FINSUPTYPE in the returns setup with the derivation step for FINSUPTYPE set to 3.

Financial Support Type (FINSUPTYPE)

Return: Data Futures

Entity: Student Financial Support

Page Used:

<i>Page</i>	<i>Page Element</i>
HESA Instance Data — Financial Support	Support Type
Type of Impairment	Student Support Request

Field Derivation Rule: Include for all entities

Derivation Steps:

1. Derive value from HESA Instance Data – Financial Support.
2. Derive value mapped from Type of Impairment – Student Support Request.
3. Use default.

Access and Participation Flag (APPSPEND)

Return: Data Futures

Entity: Student Financial Support

Page Used:

<i>Page</i>	<i>Page Element</i>
HESA Instance Data — Financial Support	Access Spending

Field Derivation Rule: Derive a value if these conditions are met:

- Country = England
- FINSUPTYPE = 001, 002, 003, or 004

Derivation Steps:

1. Derive from HESA Instance Data.
2. Use default.
3. Derive as null.

Financial Support Amount (FINSUPAMOUNT)

Return: Data Futures

Entity: Student Financial Support

Page Used:

<i>Page</i>	<i>Page Element</i>
HESA Instance Data — Financial Support	Amount

Field Derivation Rule: Derive a value if FINSUPTYPE = 001, 002, 003, or 004.

Derivation Steps:

1. Derive value from HESA Instance Data — Financial Support.
2. Use default.
3. Derive as NULL ERROR.

Data Futures Return: Language Proficiency Entity

For each Student entity in the extract, if all these conditions are met, a single entity is created:

- Country = Scotland
- EntryProfile.PERMADDCOUNTRY = XF, XG, XH, XI, XK, XL, GG, JE, or IM. If a value isn't found in the extract, the value is selected from the most recent submitted data record. If there's no value in the submitted data, a value is derived without reference to the field derivation rule.
- LANGPROFICIENCYID is defined in the most recent effective-dated Person HESA Data, where the effective date is on or before the reporting period end date.

Language Proficiency Identifier (LANGPROFICIENCYID)

Return: Data Futures

Entity: Language Proficiency

Page Used:

<i>Page</i>	<i>Page Element</i>
Person HESA Data	LANGPROFICIENCYID

Field Derivation Rule: Include for all entities

Derivation Step: Derive from the most recent effective-dated Person HESA Data, where the effective date is on or before the reporting period end date.

Proficiency Type (PROFICIENCYTYPE)

Return: Data Futures

Entity: Language Proficiency

Page Used:

Page	Page Element
Person HESA Data	PROFICIENCYTYPE

Field Derivation Rule: Include for all entities

Derivation Steps:

1. Derive from the most recent effective-dated Person HESA Data, where the effective date is on or before the reporting period end date.
2. Use default.
3. Derive as null.

Graduate Outcomes Return: Provider Entity

If Retain Data from Previous Run is:

- selected, initially any existing inactive extract records are deleted and any existing active records are set to inactive for all the extract records before new entities are created.
- not selected, then initially all the existing extract records for the return are deleted before new entities are created. This applies to all the extract records.

Entity selection and field derivation is as per INSTITUTION in DLHE return.

A single active Provider entity is created in the Institution Extract Data record (SSR_HE_INST_EXT) for a Graduate Outcomes return based on the HESA Returns Setup record.

The SSR_HE_INSTAPP value is saved as blank as this field is not required for GRADOUT returns.

Census (CENSUS)

Return: GRADOUT

Entity: Provider

Pages Used: None

Field Derivation Rule: Include for all entities.

Derivation Steps:

Derive as the short translate name for the selected survey parameter:

- A = Dec
- B = Mar

- C = Jun
- D = Sep

Record Type Indicator (RECID)

Return: GRADOUT

Entity: Provider

Pages Used:

Page	Page Element
Reporting Periods (Records and Enrollment, HESA Reporting, HESA Returns Setup, Reporting Periods)	Record Year
Returns (Records and Enrollment, HESA Reporting, HESA Returns Setup, Returns)	Record ID

Field Derivation Rule: Include for all Institution entities

Derivation Step: Derive as YYNNN, where YY is the final two digits of the Record Year (for example, 17 for 2017) and NNN is the three-digit Record ID for the seeded return (071 for GRADOUT).

UK Provider Reference Number (UKPRN)

Return: GRADOUT

Entity: Provider

Pages Used:

Page	Page Element
HESA Configuration	UKPRN

Field Derivation Rule: Include for all Institution entities.

Derivation Step: Derive from the HESA Configuration page.

Graduate Outcomes Return: Graduate Entity

A Graduate entity is created in the survey extract record (SSR_HE_DL_EXT) for each distinct survey record for the return that meets the following criteria:

- If at least one survey status has been defined in HESA Returns Setup (SSR_HE_DL_STAT), then a survey is only included if it has a status value that matches one of the defined statuses. If a survey status is not defined, then the survey is included irrespective of status.
- A survey is only included based on Survey (SSR_HE_APRJAN) when the corresponding Survey (that is, CENSUS) parameter (A, B, C, or D) is selected.
- If the Student Override check box is selected, survey selection is restricted based on the defined EMPLID values.
- If *Null Error Only* is selected for Student entities:
 - Select only survey records where at least one field has a derived value of NULL ERROR
 - A flag in the survey extract table (SSR_HE_DL_EXT) is set to “Y” if there is at least one field with a derived value of NULL ERROR (SSR_HE_STD_NULLERR) in either the Survey or Postal Address extract fields records

The record SSR_HE_DL_EXT and SSR_HE_DL_EX_FL are used to hold the Graduate entity values.

The derived values for APRJAN and HUSID are stored in the main table. The fields table holds the derived values for the other fields.

The Null Error flag (SSE_HE_STD_NULLERR) is set to ‘Y’ if any of the fields in any of the related entities is derived as NULL ERROR.

Country (COUNTRY)

Return: GRADOUT

Entity: Graduate

Pages Used: None

Field Derivation Rule: Include for all entities.

Derivation Steps:

1. Select the most recent active, effective-dated address record with an Address Type that corresponds to Address Types for COUNTRY in the HESA Return Setup record (or if no Address Types are defined then consider all address types) where the country code is one of the UK codes (GBR, ENG, SCT, WAL, NIR, XF, XG, XH or XI).

If multiple UK addresses are found with the same effective date, then one is randomly selected.

Derive the HESA country code as follows:

- GBR = XK
- ENG or XF = XF
- NIR or XG = XG
- SCT or XH = XH

- WAL or XI = XI
2. Select the most recent active, effective-dated address record with an Address Type that corresponds to Address Types for COUNTRY in the HESA Return Setup record (or if no Address Types are defined then consider all address types) where the country code is *not* one of the UK codes.

If multiple non-UK addresses are found with the same effective date, then one is randomly selected.

Derive the two-character country code from the Country table, for example: AUS (Australia) = AU.
 3. Use default. (for example, ZZ = not known)
 4. Derive as NULL ERROR.

Email Address (EMAIL, EMAIL2, EMAIL3)

Return: GRADOUT

Entity: Graduate

Pages Used:

Page	Page Element
Electronic Addresses (Campus Community > Personal Information (Student) > Add/Update a Person > Biographical Information)	Email Address, Type

Field Derivation Rule: Include for all entities.

Derivation Steps:

1. Select up to three email addresses where the email type matches one of the types set up in Returns Setup – HESA types for EMAIL, or no types are set up for the return for EMAIL.

If one of the selected emails has preferred = “Y,” that record is used for EMAIL and any other selected email addresses are used for EMAIL2 and EMAIL3. If more than three email addresses are selected, then the values are derived by by email type in ascending order.

2. Derive as NULL.

Forenames (FNAMES)

Return: GRADOUT

Entity: Graduate

Pages Used:

Page	Page Element
Survey Details — Supplied Fields	Forenames

Field Derivation Rule: Include for all entities.

Derivation Steps:

1. Derive from the survey record.
2. Derive as NULL.

Forename Change (FNMECHNGE)

Return: Student Record

Entity: Student

Page Used:

Page	Page Element
Names (Campus Community > Personal Information (Student) > Add/Update a Person > Biographical Details > Names)	First Name Middle Name

Field Derivation Rule: Include for all entities

Derivation Steps:

1. If First Name space Middle Name of the most recent effective-dated primary name record is different from the derived FNAMES value, derive the value.
2. Derive as null.

Status of Graduate (GRADSTATUS)

Return: GRADOUT

Entity: Graduate

Pages Used:

Page	Page Element
Survey Details — Supplied Fields	Graduate Status

Page	Page Element
Campus Community > Personal Information > Biographical > Personal Attributes > Decedent Data	Date of Death

Field Derivation Rule: Include for all entities.

Derivation Steps:

1. Derive from the survey record.
2. If Date of Death is populated, derive as 01 (deceased).
3. If null values are derived for all email and telephone fields, derive as 02 (not contactable by email or telephone).
4. Derive as NULL.

HESA Unique Graduate Identifier (HUSID)

Return: GRADOUT

Entity: Graduate

Pages Used:

Page	Page Element
Survey Details — Supplied Fields	HUSID

Field Derivation Rule: Include for all entities.

Derivation Step: Derive from the survey record.

International Telephone (INTTEL, INTTEL2, INTTEL3)

Return: GRADOUT

Entity: Graduate

Pages Used:

Page	Page Element
Campus Community > Personal Information > Addresses/Phones > Phone Numbers	Phone Number Country Code

Page	Page Element
Records and Enrollment > HESA Reporting > Survey Management > Details	Home/EU/Overseas (SSR_HE_HOMEEUOS)

Field Derivation Rule: If Home/EU/Overseas is not 3 (overseas), derive up to 3 values from non-UK phone numbers where the phone type matches one of the types set up in Returns Setup – HESA Types for INTTEL, or no types are set up for the return for that field and either one of the following:

- Country Code has a value and is *not* 000 nor 044
- Country Code is blank or 000, phone number starts with +, and Phone number does not start +44

If one of the selected records has Preferred = “Y,” that record is used for INTTEL and any other records are used for INTTEL2 and INTTEL3. If more than 3 non-UK phone numbers are selected, then fields are derived by phone type in ascending order. Phone numbers that are longer than 17 digits and not flagged as preferred are not considered.

If Home/EU/Overseas is 3, or there are no international telephone numbers, the field is null.

Derivation Step:

1. Remove special characters, spaces, and leading zeros from the phone number as well as any country code with leading zeros. Two leading zeroes are added for the UK international direct dialing code.

Derive the value if it is 17 digits or fewer.

2. For INTTEL, if the preferred phone number is derived and the derived number is longer than 17 digits, derive as NULL ERROR.

Own Graduate Identifier (OWNSTU)

Return: GRADOUT

Entity: Graduate

Pages Used:

Page	Page Element
Survey Details — Header	EMPLID

Field Derivation Rule: Include for all entities.

Derivation Step: Derive from the survey record.

Surname Change (SNAMECHNGE)

Return: Student Record

Entity: Student

Page Used:

Page	Page Element
Names (Campus Community > Personal Information (Student) > Add/Update a Person > Biographical Details > Names)	Last Name

Field Derivation Rule: Include for all entities

Derivation Steps:

1. If the Last Name of the most recent effective-dated primary name record is different from the derived SURNAME value, derive the value.
2. Derive as null.

Surname (SURNAME)

Return: GRADOUT

Entity: Graduate

Pages Used:

Page	Page Element
Survey Details — Supplied Fields	Surname

Field Derivation Rule: Include for all entities.

1. Derive from the survey record.
2. Derive as NULL ERROR.

UK Mobile (UKMOB, UKMOB2, UKMOB3)

Return: GRADOUT

Entity: Graduate

Pages Used:

Page	Page Element
Campus Community > Personal Information > Addresses/Phones > Phone Numbers	Phone Number

Field Derivation Rule: Derive up to three values from UK phone numbers where:

- Phone type matches one of the types set up in Returns Setup – HESA Types for UKMOB, or types are not set up for the return for that field
- Country code is blank, 000, or 044
- Phone number does not start with + or starts with +44
- Phone number where the special characters, spaces, leading 44, and leading zeros are removed starts in the range 71 to 79

If one of the selected records has Preferred = “Y,” that record is used for UKMOB and any other records are used for UKMOB2 and UKMOB3. If more than three UK phone numbers are selected, then fields are derived by phone type in ascending order.

Derivation Step:

1. Remove special characters, spaces, and leading 44 from the phone number. A leading zero is added if one does not exist.

Derive the value if it is 11 digits.
2. If the preferred phone number is derived and the derived number is not 11 digits, derive as NULL ERROR.

Note: This selection excludes personal numbers that begin with 070.

UK Telephone (UKTEL, UKTEL2, UKTEL3)

Return: GRADOUT

Entity: Graduate

Page Used:

Page	Page Element
Records and Enrollment > HESA Reporting > Survey Management > Details	Home/EU/Overseas (SSR_HE_HOMEEUOS)

Field Derivation Rule: If Home/EU/Overseas is not 3 (overseas), derive up to three values from UK phone numbers where:

- Phone type matches one of the types set up in Returns Setup – HESA Types for UKTEL, or types are not set up for the return for that field
- Country code is blank, 000, or 044
- Phone number does not start with + or +44
- Phone number where the special characters, spaces, leading 44, and leading zeros are removed does not start in the range 71 to 79

If one of the selected records has Preferred = “Y,” that record is used for UKTEL and any other records are used for UKTEL2 and UKTEL3. If more than three UK phone numbers are selected, then UKTEL2 and UKTEL3 are derived by phone type in ascending order.

If Home/EU/Overseas is 3, or there are no UK telephone numbers, the field is null.

Derivation Step:

1. Remove special characters, spaces, and leading 44 from the phone number. A leading zero is added if one does not exist.

Derive the value if it is 10 or 11 digits.
2. If the preferred phone number is derived and the derived number is not 10 or 11 digits, derive as NULL ERROR.

Note: This selection includes personal numbers that begin with 070.

Graduate Outcomes Return: Postal Address Entity

For each Graduate entity where the derived GRADSTATUS = 2 (cannot be contacted by email or telephone), one or two Postal Address entities are created where COUNTRY has been derived from a UK address in derivation step 1 and is one of the UK codes XF, XH, XI, XG, or XK. At least one entity is required where COUNTRY is XF, XH, XI, XG, or XK (that is, UK), and, in a similar way to the COUNTRY field, UK addresses are derived ahead of non-UK addresses.

Entities are created based on address records with an Address Type that corresponds to those defined as the Address Types for COUNTRY in the HESA Return Setup record. If Address Types are not defined, then all address types are considered. Initially, addresses with UK country codes (GBR, ENG, SCT, WAL, NIR, XF, XG, XH or XI) are selected (with the most recent ones first) to create two entities. If multiple UK addresses are found with the same effective date, then the addresses are randomly selected. Because this selection matches the first derivation step of COUNTRY, at least one Postal Address entity should always be created when COUNTRY is XF, XH, XI, XG, or XK.

Address Line 1 (ADDRESSLN1)

Return: GRADOUT

Entity: Postal Address

Pages Used:

<i>Page</i>	<i>Page Element</i>
Campus Community > Personal Information > Biographical > Addresses/Phones > Addresses	Address 1

Field Derivation Rule: Include for all entities

Derivation Steps:

1. Derive from Address 1, truncated to 50 characters.
2. Derive as NULL.

Address Line 2 (ADDRESSLN2)

Return: GRADOUT

Entity: Postal Address

Pages Used:

<i>Page</i>	<i>Page Element</i>
Campus Community > Personal Information > Biographical > Addresses/Phones > Addresses	Address 2

Field Derivation Rule: Include for all entities

Derivation Steps:

1. Derive from Address 2, truncated to 50 characters.
2. Derive as NULL.

Address Line 3 (ADDRESSLN3)

Return: GRADOUT

Entity: Postal Address

Pages Used:

<i>Page</i>	<i>Page Element</i>
Campus Community > Personal Information > Biographical > Addresses/Phones > Addresses	Address 3

Field Derivation Rule: Include for all entities

Derivation Steps:

1. Derive from Address 3, truncated to 50 characters.
2. Derive as NULL.

Address Line 4 (ADDRESSLN4)

Return: GRADOUT

Entity: Postal Address

Pages Used:

<i>Page</i>	<i>Page Element</i>
Campus Community > Personal Information > Biographical > Addresses/Phones > Addresses	Address 4

Field Derivation Rule: Include for all entities

Derivation Steps:

1. Derive from Address 4, truncated to 50 characters.
2. Derive as NULL.

Note: This is not derived for UK addresses unless the delivered UK address format is updated to add Address 4.

Address Line 5 (ADDRESSLN5)

Return: GRADOUT

Entity: Postal Address

Pages Used:

<i>Page</i>	<i>Page Element</i>
Campus Community > Personal Information > Biographical > Addresses/Phones > Addresses	City

Field Derivation Rule: Include for all entities

Derivation Steps:

1. Derive from City.
2. Derive as NULL.

Address Line 6 (ADDRESSLN6)

Return: GRADOUT

Entity: Postal Address

Pages Used:

Page	Page Element
Campus Community > Personal Information > Biographical > Addresses/Phones > Addresses	County

Field Derivation Rule: Include for all entities

Derivation Steps:

1. Derive as description for the County code.
2. Derive as NULL.

Postcode (POSTCODE)

Return: GRADOUT

Entity: Postal Address

Pages Used:

Page	Page Element
Campus Community > Personal Information > Biographical > Addresses/Phones > Addresses	Post Code

Field Derivation Rule: Include for all entities

Derivation Steps:

1. If the value is 8 characters or fewer, derive from the selected address record.
2. Derive as NULL ERROR.

DLHE Return: Institution Entity

The Create Extract Application Engine (SSR_HE_DATA) process creates a single Institution entity. The Institution entity is composed of two fields.

Record Type Indicator (RECID)

Return: DLHE

Entity: Institution

Pages Used:

Page	Page Element
Reporting Periods (Records and Enrollment, HESA Reporting, HESA Returns Setup, Reporting Periods)	Record Year
Returns (Records and Enrollment, HESA Reporting, HESA Returns Setup, Returns)	Record ID

Field Derivation Rule: Include for all Institution entities.

Derivation Steps:

1. Derive as YYNNN, where YY is the final 2-digits of the Record Year (for example, 11 for 2011) and NNN is the 3-digit Record ID for the seeded return.

UK Provider Reference Number (UKPRN)

Return: DLHE

Entity: Institution

Pages Used:

Page	Page Element
HESA Configuration	UKPRN

Field Derivation Rule: Include for all Institution entities.

Derivation Steps:

1. Derive from the HESA Configuration page.

DLHE Return: Student Entity

The Create Extract process creates a Student entity for each distinct DLHE survey record.

If at least one survey status has been defined on the HESA Returns page, then the process includes a survey only if the survey has a status value that matches one of the defined statuses. If you have not defined a survey status on the HESA Returns page, then the process includes the survey irrespective of status value. Use the Survey Management component to verify the status of a survey (Records and Enrollment, HESA Reporting, Destination of Leavers, Survey Management).

If you have selected the Null Errors Only check box for the Include Student Entities on the Create Extract Data page, the process selects distinct EMPLIDs from the existing active DLHE extract data, where at

least one field in the Student, Employment, Study, or Teaching extract data has a derived value of *NULL ERROR*. The process then selects the survey records for these EMPLIDs. If a student has more than one survey record, then the process selects all the student's surveys if any of them has any *NULL ERROR* values.

If you have selected the Student Override check box, the process considers the survey records for only the EMPLIDs you have selected.

All Activities – Q1 (ALLACT1)

Return: DLHE

Entity: Student

Page Used:

Page	Page Element
Enter DLHE Survey (Section A) self-service	Q1 – Activities check box 1

Field Derivation Rule: Include for all survey records in a DLHE return.

Derivation Steps:

1. If Student.STATUS = 07 or 08, derive as *X* (ineligible or explicit refusal).
2. If the check box is selected, derive as *I*.
3. If none of the check boxes has been selected (that is, Student.ALLACT2 to Student.ALLACT8 are all derived as *NULL*), derive as *NULL ERROR*.
4. Do not derive a value and leave the field blank.

All Activities – Q1 (ALLACT2-8)

Return: DLHE

Entity: Student

Page Used:

Page	Page Element
Enter DLHE Survey (Section A) self-service	Q1 – Activities check boxes 2 to 8

Field Derivation Rule: Student.STATUS is not 07 or 08.

Derivation Steps:

1. Derive as follows:

- ALLACT2 - Derive as 2 if the check box is selected.
- ALLACT3 - If reporting period is 2013/14 or later, derive as 9 if the check box is selected. Otherwise, derive as 3 if the check box is selected.
- ALLACT4 - Derive as 4 if the check box is selected.
- ALLACT5 - Derive as 5 if the check box is selected.
- ALLACT6 - Derive as 6 if the check box is selected.
- ALLACT7 - Derive as 7 if the check box is selected.
- ALLACT8 - Derive as 8 if the check box is selected.

2. Do not derive a value and leave the field blank.

April or January Survey (APRJAN)

Return: DLHE

Entity: Student

Page Used:

Page	Page Element
Survey Details	Survey

Field Derivation Rule: Include for all survey records in a DLHE return.

Derivation Steps:

1. Derive from the survey record, either 1 or 2.

Higher Education experience for business – Q33 (HEBUSNEXP)

Return: DLHE

Entity: Student

Page Used:

Page	Page Element
Enter DLHE Survey (Section E) self-service	Q33

Field Derivation Rule: Include for all survey records in a DLHE return.

Derivation Steps:

1. If Student.STATUS = 03, 05, 06, 07 or 08, derive as 6 (unable to code).
2. Derive from the survey record.
3. If Student.STATUS = 02, derive as 6.
4. Use default (from HESA Fields page in the HESA returns setup).
5. Derive as *NULL ERROR*.

Higher Education experience for study – Q32 (HESTUDYEXP)

Return: DLHE

Entity: Student

Page Used:

Page	Page Element
Enter DLHE Survey (Section E) self-service	Q32

Field Derivation Rule: Include for all survey records in a DLHE return.

Derivation Steps:

1. If Student.STATUS = 03, 05, 06, 07 or 08, derive as 6 (unable to code).
2. Derive from the survey record.
3. If Student.STATUS = 02, derive as 6.
4. Use default.
5. Derive as *NULL ERROR*.

Higher Education experience for work – Q31 (HEWORKEXP)

Return: DLHE

Entity: Student

Page Used:

Page	Page Element
Enter DLHE Survey (Section E) self-service	Q31

Field Derivation Rule: Include for all survey records in a DLHE return.

Derivation Steps:

1. If Student.STATUS = 03, 05, 06, 07 or 08, derive as 6 (unable to code).
2. Derive from the survey record.
3. If Student.STATUS = 02, derive as 6.
4. Use default.
5. Derive as *NULL ERROR*.

HESA unique student identifier (HUSID)

Return: DLHE

Entity: Student

Page Used:

<i>Page</i>	<i>Page Element</i>
Survey Details	HUSID

Field Derivation Rule: Include for all survey records in a DLHE return.

Derivation Steps:

1. Derive from the survey record.

Most important activity – Q1 (MIMPACT)

Return: DLHE

Entity: Student

Page Used:

<i>Page</i>	<i>Page Element</i>
Enter DLHE Survey (Section A) self-service	Q1 – Most important option

Field Derivation Rule: Include for all survey records in a DLHE return.

Derivation Steps:

1. If Student.STATUS = 07 or 08, derive as *X* (ineligibility or explicit refusal).
2. If a Most important option has been selected, derive the value from 1 to 8 (depending on which Most important option is selected).

If the reporting period is 2013/14 or later, convert 3 to 9.

- Derive as *NULL ERROR*.

Status of data collection (STATUS)

Return: DLHE

Entity: Student

Page Used:

Page	Page Element
Survey Details	Survey Method

Field Derivation Rule: Include for all survey records in a DLHE return.

Derivation Steps:

- Derive from the survey record.
- Use default value (this is derived from the HESA Fields page not from the Survey Status value on the HESA Returns page).
- Derive as *NULL ERROR*.

Opt Out from Communications (OPTOUT)

Return: DLHE

Entity: Student

Page Used:

Page	Page Element
Survey Details	Opt out check box

Field Derivation Rule: Include for all survey records in a DLHE return.

Derivation Steps:

- If check box is selected, derive as 1.
- Derive as null.

DLHE Return: Employment Entity

For each Student entity, if Student.ALLACT1 = 1 or Student.ALLACT2 = 2, then an Employment entity is included in the Student entity and the Employment entity fields are derived. Otherwise, an Employment entity is not included.

Note: Student.ALLACT is derived as *X* and Student.ALLACT2 is derived as blank if Student.STATUS is 07 (deceased) or 08 (reply explicitly refused) so in that case an Employment entity is not created.

Employment basis (EMPBASIS)

Return: DLHE

Entity: Employment

Page Used:

Page	Page Element
Enter DLHE Survey (Section B) self-service	Q5

Field Derivation Rule: Include for all survey records in a DLHE return with an Employment entity.

Derivation Steps:

1. Derive from the survey record (01 to 11).
2. If Student.STATUS = 03, 05 or 06, derive as 99 (unknown).
3. Derive as *NULL ERROR*.

Country of employment (EMPCOUNTRY)

Return: DLHE

Entity: Employment

Page Used:

Page	Page Element
Enter DLHE Survey (Section B) self-service	Q13 – Employment Country *

* Not available in student self-service. The system displays this field only when you access the self-service page by clicking the Enter Survey button on the Survey Management page.

Field Derivation Rule: Include for all survey records in a DLHE return with an Employment entity.

Derivation Steps:

1. Derive from the survey record.
2. If Employment.EMPPCODE value does not exist, derive as *NULL ERROR*.
3. Do not derive a value and leave the field blank.

Currency of Pay (EMPCURRENCY)

Return: DLHE

Entity: Employment

Page Used:

Page	Page Element
Enter DLHE Survey (Section B) self-service	Q8

Field Derivation Rule: Include for all survey records in a DLHE return with an Employment entity.

Derivation Steps:

1. If Employment.EMPPAY > 0, derive from survey record.
2. Derive as null.

Hours Worked per Week (EMPHOURS)

Return: DLHE

Entity: Employment

Page Used:

Page	Page Element
Enter DLHE Survey (Section B) self-service	Q9

Field Derivation Rule: Include for all survey records in a DLHE return with an Employment entity.

Derivation Steps:

1. If ALLACT1 = 1 or ALLACT2 = 2 and the value is greater than zero, derive from survey record.
2. Derive as null.

Importance to employer (EMPIMP)

Return: DLHE

Entity: Employment

Page Used:

Page	Page Element
Enter DLHE Survey (Section B) self-service	Q16

Field Derivation Rule: Include for all survey records in a DLHE return with an Employment entity.

Derivation Steps:

1. If Employment.QUALREQ = 11 or 12, derive from the survey record (1, 2, 4, 5 or 8).
2. Do not derive a value and leave the field blank.

Employer name (EMPNAME)

Return: DLHE

Entity: Employment

Page Used:

Page	Page Element
Enter DLHE Survey (Section B) self-service	Q11

Field Derivation Rule: Include for all survey records in a DLHE return with an Employment entity.

Derivation Steps:

1. Derive from the survey record.
2. Derive as *NULL ERROR*.

PAY (EMPPAY)

Return: DLHE

Entity: Employment

Page Used:

Page	Page Element
Enter DLHE Survey (Section B) self-service	Q6

Field Derivation Rule: Include for all survey records in a DLHE return with an Employment entity.

Derivation Steps:

1. If the value is greater than zero, derive from survey record.
2. Derive as null.

Note: The system derives the Employment.EMPPAY field prior to Employment.EMPUNPAID.

Payment Period (EMPPAYPERIOD)

Return: DLHE

Entity: Employment

Page Used:

Page	Page Element
Enter DLHE Survey (Section B) self-service	Q7

Field Derivation Rule: Include for all survey records in a DLHE return with an Employment entity.

Derivation Steps:

1. If Employment.EMPPAY value is greater than zero, derive from the survey record.
2. Derive as null.

UK Postcode for place of employment (EMPPCODE)

Return: DLHE

Entity: Employment

Page Used:

Page	Page Element
Enter DLHE Survey (Section B) self-service	Q13 – Postcode (UK only)

Field Derivation Rule: Include for all survey records in a DLHE return with an Employment entity.

Derivation Steps:

1. Derive from the survey record.
2. Do not derive a value and leave the field blank.

Note: The system derives the Employment.EMPPCODE field prior to the derivation of Employment.EMPCOUNTRY.

Place of employment (EMPPLACE)

Return: DLHE

Entity: Employment

Page Used:

Page	Page Element
Enter DLHE Survey (Section B) self-service	Q13 – Town/city/area

Field Derivation Rule: Include for all survey records in a DLHE return with an Employment entity.

Derivation Steps:

1. Derive from the survey record.
2. Do not derive a value and leave the field blank.

Unpaid work (EMPUNPAID)

Return: DLHE

Entity: Employment

Page Used:

Page	Page Element
Enter DLHE Survey (Section B) self-service	Q6 – Unpaid Work

Field Derivation Rule: Include for all survey records in a DLHE return with an Employment entity.

Derivation Steps:

1. If Employment.EMPPAY value does not exist, derive from survey record (1 if Unpaid Work check box is selected)
2. Derive as null.

Total estimated earnings for a year (ESTEARN)

Return: DLHE

Entity: Employment

Page Used:

Page	Page Element
Enter DLHE Survey (Section B) self-service	Q10

Field Derivation Rule: Include for all survey records in a DLHE return with an Employment entity.

Derivation Steps:

1. Derive from survey record if the value is greater than zero.
2. Do not derive a value and leave the field blank.

Job duties (JOBduties)

Return: DLHE

Entity: Employment

Page Used:

Page	Page Element
Enter DLHE Survey (Section B) self-service	Q4

Field Derivation Rule: Include for all survey records in a DLHE return with an Employment entity.

Derivation Steps:

1. Derive from survey record.
2. Do not derive a value and leave the field blank.

How found job (JOBFOUND)

Return: DLHE

Entity: Employment

Page Used:

Page	Page Element
Enter DLHE Survey (Section B) self-service	Q18

Field Derivation Rule: Include for all survey records in a DLHE return with an Employment entity.

Derivation Steps:

1. Derive from survey record (01 to 09).

If the reporting period is 2013/14 or later:

- 01 is converted to 10
- 06 is converted to 12

2. Do not derive a value and leave the field blank.

All reasons for taking the job (JOBRSNALL1)

Return: DLHE

Entity: Employment

Page Used:

Page	Page Element
Enter DLHE Survey (Section B) self-service	Q17 – Reasons check box 1

Field Derivation Rule: Include for all survey records in a DLHE return with an Employment entity.

Derivation Steps:

1. Derive as *01* if the check box has been selected.
2. Do not derive a value and leave the field blank.

All reasons for taking the job (JOBRSNALL2 to 9)

Return: DLHE

Entity: Employment

Page Used:

Page	Page Element
Enter DLHE Survey (Section B) self-service	Q17 – Reasons check boxes 2 to 9

Field Derivation Rule: Include for all survey records in a DLHE return with an Employment entity.

Derivation Steps:

1. Derive as follows:
 - JOBRSNALL2 - Derive as *02* if the check box is selected.
 - JOBRSNALL3 - Derive as *03* if the check box is selected.

- JOBRSNALL4 - Derive as *04* if the check box is selected.
- JOBRSNALL5 - Derive as *05* if the check box is selected.
- JOBRSNALL6 - Derive as *06* if the check box is selected.
- JOBRSNALL7 - Derive as *07* if the check box is selected.
- JOBRSNALL8 - Derive as *08* if the check box is selected.
- JOBRSNALL9 - Derive as *09* if the check box is selected.

2. Do not derive a value and leave the field blank.

Main reason for taking the job (JOBRSNMAIN)

Return: DLHE

Entity: Employment

Page Used:

<i>Page</i>	<i>Page Element</i>
Enter DLHE Survey (Section B) self-service	Q17 – Main reason

Field Derivation Rule: Include for all survey records in a DLHE return with an Employment entity.

Derivation Steps:

1. Derive from survey record (01 to 09).
2. Do not derive a value and leave the field blank.

Note: There is validation on the self-service page to ensure that the option selected for Main reason has also been selected as one of the Reasons.

Number of jobs (JOBSNO)

Return: DLHE

Entity: Employment

Page Used:

<i>Page</i>	<i>Page Element</i>
Enter DLHE Survey (Section B) self-service	Q2

Field Derivation Rule: Include for all survey records in a DLHE return with an Employment entity.

Derivation Steps:

1. Derive from survey record if greater than 1 (2 to 9).
2. Do not derive a value and leave the field blank.

Note: There is validation on the self-service page to ensure the value entered is greater than 1. In step 1, the value is checked to ensure that zero is not derived.

Job title (JOBTITLE)

Return: DLHE

Entity: Employment

Page Used:

Page	Page Element
Enter DLHE Survey (Section B) self-service	Q3

Field Derivation Rule: Include for all survey records in a DLHE return with an Employment entity.

Derivation Steps:

1. Derive from survey record.
2. If Employment.JOBDUTIES value does not exist, derive as *NULL ERROR*.
3. Do not derive a value and leave the field blank.

Nature of employer's business (MAKEDO)

Return: DLHE

Entity: Employment

Page Used:

Page	Page Element
Enter DLHE Survey (Section B) self-service	Q12

Field Derivation Rule: Include for all survey records in a DLHE return with an Employment entity.

Derivation Steps:

1. Derive from survey record.

2. Derive as *NULL ERROR*.

NHS Organisation – Q14 (NHSORG)

Return: DLHE

Entity: Employment

Page Used:

Page	Page Element
Enter DLHE Survey (Section B) self-service	Q14

Field Derivation Rule: Include for all survey records in a DLHE return with an Employment entity.

Derivation Steps:

1. Derive from survey record. (1, 2, or 8)
2. Derive as *X*.

Postdoctoral research contract – derived from Q3 and Q4 (POSTDOC)

Return: DLHE

Entity: Employment

Page Used:

Page	Page Element
Enter DLHE Survey (Section B) self-service	Postdoctoral Research Contract *

* Not available in student self-service. The system displays this field only when you access the self-service page by clicking the Enter Survey button on the Survey Management page.

Field Derivation Rule: Include for all survey records in a DLHE return with an Employment entity.

Derivation Steps:

1. Derive from survey record (1, 2 or 3).
2. Do not derive a value and leave the field blank.

Previously employed (PREVEMP)

Return: DLHE

Entity: Employment

Page Used:

Page	Page Element
Enter DLHE Survey (Section B) self-service	Q19

Field Derivation Rule: Include for all survey records in a DLHE return with an Employment entity.

Derivation Steps:

1. Derive from survey record (1, 2, 3, or 4).
2. Do not derive a value and leave the field blank.

Category of previous employment (PREVWORK1)

Return: DLHE

Entity: Employment

Page Used:

Page	Page Element
Enter DLHE Survey (Section B) self-service	Q20 – check box 1

Field Derivation Rule: Include for all survey records in a DLHE return with an Employment entity.

Derivation Steps:

1. If PREVEMP = 1, 2 or 3, then derive as *01* if the check box has been selected.
2. Do not derive a value and leave the field blank.

Category of previous employment (PREVWORK2 to 7)

Return: DLHE

Entity: Employment

Page Used:

Page	Page Element
Enter DLHE Survey (Section B) self-service	Q20 – check boxes 2 to 7

Field Derivation Rule: Include for all survey records in a DLHE return with an Employment entity.

Derivation Steps:

1. Derive as follows:
 - PREVWORK2 - Derive as *02* if the check box is selected.
 - PREVWORK3 - Derive as *03* if the check box is selected.
 - PREVWORK4 - Derive as *04* if the check box is selected.
 - PREVWORK5 - Derive as *05* if the check box is selected.
 - PREVWORK6 - Derive as *06* if the check box is selected.
 - PREVWORK7 - Derive as *07* if the check box is selected.
2. Do not derive a value and leave the field blank.

Qualification required for job (QUALREQ)

Return: DLHE

Entity: Employment

Page Used:

<i>Page</i>	<i>Page Element</i>
Enter DLHE Survey (Section B) self-service	Q15

Field Derivation Rule: Include for all survey records in a DLHE return with an Employment entity.

Derivation Steps:

1. Derive from survey record (11, 12, 13 or 14).
2. Do not derive a value and leave the field blank.

Standard Occupational Classification 2010 - derived from Q3 and Q4 (SOCDLHE2010)

Return: DLHE

Entity: Employment

Page Used:

<i>Page</i>	<i>Page Element</i>
Enter DLHE Survey (Section B) self-service	Occupational Classification *

* Not available in student self-service. The system displays this field only when you access the self-service page by clicking the Enter Survey button on the Survey Management page.

Field Derivation Rule: Include for all survey records in a DLHE return with an Employment entity.

Derivation Steps:

1. Derive from survey record.
2. Derive as *NULL ERROR*.

DLHE Return: Teaching Entity

For each Student entity, if Student.STATUS is not 07 or 08, then a Teaching entity is included in the Student entity and the Teaching entity fields are derived. Otherwise (that is, Student.STATUS is 07 or 08), a Teaching entity is not included in the Student entity.

Employed as teacher (EMPLDTEACH)

Return: DLHE

Entity: Teaching

Page Used:

Page	Page Element
Enter DLHE Survey (Section C) self-service	Q21
Enter DLHE Survey (Section C) self-service	Newly qualified teacher status – check box

Field Derivation Rule: Include for all survey records in a DLHE return with a Teaching entity.

Derivation Steps:

1. Derive from survey record (1 or 2).
2. If the check box is selected, derive as *NULL ERROR*.
3. Do not derive a value and leave the field blank.

GTC Scotland Teacher Induction scheme (GTCSTIS)

Return: DLHE

Entity: Teaching

Page Used:

Page	Page Element
HESA Returns	Country
Enter DLHE Survey (Section C) self-service	Q22
Enter DLHE Survey (Section C) self-service	Newly qualified teacher status – check box

Field Derivation Rule: Include for all survey records in a DLHE return with a Teaching entity only if Country in HESA Returns page = Scotland.

Derivation Steps:

1. Derive from survey record (1 or 2).
2. Do not derive a value and leave the field blank.

Seeking a teaching post (SEEKTEACH)

Return: DLHE

Entity: Teaching

Page Used:

Page	Page Element
Enter DLHE Survey (Section C) self-service	Q25
Enter DLHE Survey (Section C) self-service	Newly qualified teacher status – check box

Field Derivation Rule: Include for all survey records in a DLHE return with a Teaching entity.

Derivation Steps:

1. Derive from survey record (1 or 2).
2. If the check box is selected and Teaching.EMPLDTEACH = 2 and Student.STATUS is 01, 02 or 04, then derive as *NULL ERROR*.
3. Do not derive a value and leave the field blank.

Teaching funded (TEACHFUND)

Return: DLHE

Entity: Teaching

Page Used:

<i>Page</i>	<i>Page Element</i>
Enter DLHE Survey (Section C) self-service	Q23
Enter DLHE Survey (Section C) self-service	Newly qualified teacher status – check box

Field Derivation Rule: Include for all survey records in a DLHE return with a Teaching entity.

Derivation Steps:

1. If Teaching.EMPLDTEACH = 1, derive from survey record (1, 2, 3, or 4).
2. Do not derive a value and leave the field blank.

Teaching phase (TEACHPHS)

Return: DLHE

Entity: Teaching

Page Used:

<i>Page</i>	<i>Page Element</i>
Enter DLHE Survey (Section C) self-service	Q24
Enter DLHE Survey (Section C) self-service	Newly qualified teacher status – check box

Field Derivation Rule: Include for all survey records in a DLHE return with a Teaching entity.

Derivation Steps:

1. If Teaching.EMPLDTEACH = 1, derive from survey record (1, 2, 3, or 4).
2. Do not derive a value and leave the field blank.

DLHE Return: Study Entity

For each Student entity, if Student.ALLACT5 = 5 or Student.ALLACT6 = 6, then a Study entity is included in the Student entity and the Study entity fields are derived. Otherwise, a Study entity is not included in the Student entity.

Note: Student.ALLACT5 and Student.ALLACT6 are derived as blank if Student.STATUS is 07 (deceased) or 08 (reply explicitly refused) so in that case a Study entity is not created.

Course name (COURSENAME)

Return: DLHE

Entity: Study

Page Used:

Page	Page Element
Enter DLHE Survey (Section D) self-service	Q27

Field Derivation Rule: Include for all survey records in a DLHE return with a Study entity.

Derivation Steps:

1. Derive from survey record.
2. Do not derive a value and leave the field blank.

JACS 3.0 – derived from Q27 and Q28 (JACS)

Return: DLHE

Entity: Study

Page Used:

Page	Page Element
Enter DLHE Survey (Section D) self-service	JACS Subject*

*Not available in student self-service. The system displays this field only when you access the self-service page by clicking the Enter Survey button on the Survey Management page.

Field Derivation Rule: Include for all survey records in a DLHE return with a Study entity.

Derivation Steps:

1. Derive from survey record.
2. Derive as *NULL ERROR*.

JACS 3.0 – derived from Q27 and Q28 (JACS-S2, JACS-S3)

Return: DLHE

Entity: Study

Page Used:

Page	Page Element
Enter DLHE Survey (Section D) self-service	JACS Subject 2*, JACS Subject 3*

*Not available in student self-service. The system displays this field only when you access the self-service page by clicking the Enter Survey button on the Survey Management page. Also, the field is enabled only if you enter JACS Subject.

Field Derivation Rule: Include for all survey records in a DLHE return with a Study entity.

Derivation Steps:

1. Derive from survey record.
2. Do not derive a value and leave the field blank.

How funding further study (STUDYFUND)

Return: DLHE

Entity: Study

Page Used:

Page	Page Element
Enter DLHE Survey (Section D) self-service	Q30

Field Derivation Rule: Include for all survey records in a DLHE return with a Study entity.

Derivation Steps:

1. Derive from survey record (01, 02, 03, 04 or 05).
2. Do not derive a value and leave the field blank.

Subject of study, training or research (SUBJECT)

Return: DLHE

Entity: Study

Page Used:

Page	Page Element
Enter DLHE Survey (Section D) self-service	Q28

Field Derivation Rule: Include for all survey records in a DLHE return with a Study entity.

Derivation Steps:

1. Derive from survey record.
2. If Study.COURSENAME value does not exist, derive as *NULL ERROR*.
3. Do not derive a value and leave the field blank.

Type of qualification – Q26 (TYPEQUAL)

Return: DLHE

Entity: Study

Page Used:

<i>Page</i>	<i>Page Element</i>
Enter DLHE Survey (Section D) self-service	Q26

Field Derivation Rule: Include for all survey records in a DLHE return with a Study entity.

Derivation Steps:

1. Derive from survey record (01 to 07 or 98).
2. Derive as *NULL ERROR*.

Name of university or college (UCNAME)

Return: DLHE

Entity: Study

Page Used:

<i>Page</i>	<i>Page Element</i>
Enter DLHE Survey (Section D) self-service	Q29

Field Derivation Rule: Include for all survey records in a DLHE return with a Study entity.

Derivation Steps:

1. Derive from survey record.
2. Do not derive a value and leave the field blank.

Note: The system does not derive a value and leaves this field as blank if Study.UCPROV value does not exist or is derived as 6 (unknown) and the institution name is not provided for Q29.

University or college providing study – Derived from Q29 (UCPROV)

Return: DLHE

Entity: Study

Page Used:

Page	Page Element
Enter DLHE Survey (Section D) self-service	Q29*

*Not available in student self-service. The system displays this field only when you access the self-service page by clicking the Enter Survey button on the Survey Management page.

Field Derivation Rule: Include for all survey records in a DLHE return with a Study entity.

Derivation Steps:

1. Derive from survey record.
2. Do not derive a value and leave the field blank.

Note: The system derives this field prior to Study.UCNAME

Unistats/KIS Return: Institution Entity

The Create Extract process creates a single Institution entity and saves it to the Institution Extract record (SSR_HE_INST_EXT).

Where fields are derived from the Institution HESA Data record, values are selected from the most recent effective dated record where the effective date falls on or before the end of the reporting period. Values are stored in the Institution Fields Extract record (SSR_HE_INTEX_FL).

National Scholarship Programme Participation (NSP)

Return: Unistats/KIS

Entity: Institution

Page Used:

Page	Page Element
Institution HESA Data	NSP

Field Derivation Rule: If Country = England, derive a value. Otherwise, do not derive a value and leave the field blank.

Derivation Steps:

1. Derive from the Institution HESA Data page.
2. Derive as *NULL ERROR*.

Franchise UK Provider Reference Number (OTHERINST)

Return: Unistats/KIS

Entity: Institution

Page Used:

<i>Page</i>	<i>Page Element</i>
Institution HESA Data	OTHERINST

Field Derivation Rule: Include for all Institution entities.

Derivation Steps:

1. Derive from the Institution HESA Data page.
2. Do not derive a value and leave the field blank.

Note: Nine fields are provided rather than the maximum 100 available.

Franchise UK Provider Reference Number (OTHERINST2 to 9)

Return: Unistats/KIS

Entity: Institution

Page Used:

<i>Page</i>	<i>Page Element</i>
Institution HESA Data	OTHERINST2 to OTHERINST9

Field Derivation Rule: Include for all Institution entities.

Derivation Steps:

1. Derive from the Institution HESA Data page.
2. Do not derive a value and leave the field blank.

Record Type Indicator (RECID)

Return: Unistats/KIS

Entity: Institution

Pages Used:

Page	Page Element
Reporting Periods (Records and Enrollment > HESA Reporting > HESA Returns Setup > Reporting Periods)	Record Year
Returns (Records and Enrollment > HESA Reporting > HESA Returns Setup > Returns)	Record ID

Field Derivation Rule: Include for all Institution entities.

Derivation Steps:

1. Derive as YYNNN, where *YY* is the final two digits of the Record Year (for example, 09 for 2009) and *NNN* is the 3-digit Record ID for the seeded return.

The seeded record ID for the Unistats/KIS return is *061*.

Student Union URL (SUURL)

Return: Unistats/KIS

Entity: Institution

Page Used:

Page	Page Element
Institution HESA Data	Student Union URL

Field Derivation Rule: Include for all Institution entities.

Derivation Steps:

1. Derive from the Institution HESA Data page.
2. Derive as *NULL ERROR*.

UK Provider Reference Number (UKPRN)

Return: Unistats/KIS

Entity: Institution

Page Used:

Page	Page Element
HESA Configuration	UKPRN

Field Derivation Rule: Include for all Institution entities.

Derivation Steps:

1. Derive from the HESA Returns page.
2. Derive as *NULL ERROR*.

Unistats/KIS Return: Location Entity

The Create Extract process creates one or more Location entities in the Location Extract Data record (SSR_HE_LOCN_EXT) for the single Institution extract record for the Unistats/KIS return. As with the Institution entity fields, values are selected from the most recent effective dated Institution HESA Data record where the effective date is on or before the reporting period end date.

The LOCID and LOCNAME are derived as part of the initial entity selection and stored in the Location Extract Data record (SSR_HE_LOCN_EXT). The remaining fields are derived and stored in the Location Fields Extract record (SSR_HE_LOC_EXFL).

Accommodation Cost URL (ACCOMURL)

Return: Unistats/KIS

Entity: Location

Page Used:

Page	Page Element
Institution HESA Data (Locations group box)	ACCOMURL

Field Derivation Rule: Include for all Location entities.

Derivation Steps:

1. Derive from the Institution HESA Data page.
2. Derive as *NULL ERROR*.

Location Latitude (LATITUDE)

Return: Unistats/KIS

Entity: Location

Page Used:

Page	Page Element
Institution HESA Data (Locations group box)	LATITUDE

Field Derivation Rule: If Location.INSTBEDS exists, derive a value. Otherwise, do not derive a value and leave the field blank.

Derivation Steps:

1. Derive from the Institution HESA Data page.
2. Derive as *NULL ERROR*.

Location Identifier (LOCID)

Return: Unistats/KIS

Entity: Location

Page Used:

Page	Page Element
Institution HESA Data (Locations group box)	Location ID

Field Derivation Rule: Include for all Location entities.

Derivation Steps:

1. Derive from the Institution HESA Data page.

Location Identifier Name (LOCNAME)

Return: Unistats/KIS

Entity: Location

Page Used:

Page	Page Element
Institution HESA Data (Locations group box)	Location Name

Field Derivation Rule: Include for all Location entities.

Derivation Steps:

1. Derive from the Institution HESA Data page.

Location UKPRN (LOCUKPRN)

Return: Unistats/KIS

Entity: Location

Page Used:

Page	Page Element
Institution HESA Data (Locations group box)	LOCUKPRN

Field Derivation Rule: Include for all Location entities.

Derivation Steps:

1. Derive from the Institution HESA Data page.
2. Do not derive a value and leave the field blank.

Location Longitude (LONGITUDE)

Return: Unistats/KIS

Entity: Location

Page Used:

Page	Page Element
Institution HESA Data (Locations group box)	LONGITUDE

Field Derivation Rule: Include for all Location entities.

Derivation Steps:

1. Derive from the Institution HESA Data page.
2. Derive as *NULL ERROR*.

Student Union URL (SUURL)

Return: Unistats/KIS

Entity: Location

Page Used:

Page	Page Element
Institution HESA Data (Locations group box)	Student Union URL

Field Derivation Rule: Include for all Location entities.

Derivation Steps:

1. Derive from the Institution HESA Data page.
2. Do not derive a value and leave the field blank.

Note: The return uses this field when the location has a different student union. This field is also included in the Institution entity.

Unistats/KIS Return: KISCourse Entity

The Create Extract process creates records in the Course Extract Data record (SSR_HE_CRSEXT) in a similar way to the Course entity in the student return, except that academic plans and academic subplans are included based on whether *KIS Type* has been defined rather than whether *Report to HESA* has been selected. For each academic plan or subplan the effective dated record relevant to the start date of the reporting period is considered.

When selecting records, the *Null Errors Only*, *Validation Errors Only*, *Academic Plan* and *Academic Sub-Plan* parameters of the Create Extract process are considered.

The KISCOURSEID is derived as part of the initial entity selection and stored in the Course Extract Data record (in SSR_HE_COURSEID). The value is derived as the subplan or plan code. The remaining fields are derived and stored in the Course Fields Extract record (SSR_HE_CRSEX_FL).

Dependent fields are derived first including KISTYPE and UCASCOURSEID that are required for the derivation of a number of other fields.

The most recent effective dated records on or before the reporting period end date are considered for programs, plans or subplans. The exception to this is KISTYPE that is derived from the effective dated record relevant to the start of the reporting period to be consistent with the logic for including plans and subplans in the KISCourse entity.

Assessment Methods URL (ASSURL)

Return: Unistats/KIS

Entity: KISCourse

Pages Used:

Page	Page Element
Program HESA Data (KIS Course Links group box)	Assessment Methods URL
Plan HESA Data (KIS Course Links group box)	Assessment Methods URL
Sub-Plan HESA (KIS Course Links group box)	Assessment Methods URL

Field Derivation Rule: If KISCourse.KISTYPE = 1 or 3, derive a value. Otherwise, do not derive a value and leave the field blank.

Derivation Steps:

1. If KISCourse entity is based on a subplan, derive from the Sub-Plan HESA page.
2. Derive from the Plan HESA Data page.
3. Derive from the Program HESA Data page.
4. Derive as *NULL ERROR*.

Course Costs URL (CRSECSTURL)

Return: Unistats/KIS

Entity: KISCourse

Pages Used:

Page	Page Element
Program HESA Data (KIS Course Links group box)	Course Costs URL
Plan HESA Data (KIS Course Links group box)	Course Costs URL
Sub-Plan HESA (KIS Course Links group box)	Course Costs URL

Field Derivation Rule: Include for all entities

Derivation Steps:

1. If KISCourse entity is based on a sub-plan, derive from the Sub-Plan HESA page.
2. Derive from the Plan HESA Data page.
3. Derive from the Program HESA Data page.
4. Derive as *NULL ERROR*.

Course Page URL (CRSEURL)

Return: Unistats/KIS

Entity: KISCourse

Pages Used:

Page	Page Element
Program HESA Data (KIS Course Links group box)	Course Page URL
Plan HESA Data (KIS Course Links group box)	Course Page URL
Sub-Plan HESA (KIS Course Links group box)	Course Page URL

Field Derivation Rule: Include for all KISCourse entities.

Derivation Steps:

1. If KISCourse entity is based on a subplan, derive from the Sub-Plan HESA page.
2. Derive from the Plan HESA Data page.
3. Derive from the Program HESA Data page.
4. If KISTYPE = 1 or 2, derive as *NULL ERROR*.

Distance Learning Only (DISTANCE)

Return: Unistats/KIS

Entity: KISCourse

Pages Used:

Page	Page Element
Program HESA Data (KIS Course Data group box)	DISTANCE
Plan HESA Data (KIS Course Data group box)	DISTANCE
Sub-Plan HESA (KIS Course Data group box)	DISTANCE

Field Derivation Rule: If KISCourse.KISTYPE = 1 or 2, derive a value. Otherwise, do not derive a value and leave the field blank.

Derivation Steps:

1. Use constant.

2. If KISCourse entity is based on a subplan, derive from the Sub-Plan HESA page.
3. Derive from the Plan HESA Data page.
4. Derive from the Program HESA Data page.
5. Use default.
6. Derive as *NULL ERROR*.

Employment Details URL (EMPLOYURL)

Return: Unistats/KIS

Entity: KISCourse

Pages Used:

Page	Page Element
Program HESA Data (KIS Course Links group box)	Employment Details URL
Plan HESA Data (KIS Course Links group box)	Employment Details URL
Sub-Plan HESA (KIS Course Links group box)	Employment Details URL

Field Derivation Rule: If KISCourse.KISTYPE = 1 or 3, derive a value. Otherwise, do not derive a value and leave the field blank.

Derivation Steps:

1. If KISCourse entity is based on a subplan, derive from the Sub-Plan HESA page.
2. Derive from the Plan HESA Data page.
3. Derive from the Program HESA Data page.
4. Derive as *NULL ERROR*.

Foundation Year Availability (FOUNDATION)

Return: Unistats/KIS

Entity: KISCourse

Pages Used:

Page	Page Element
Program HESA Data (KIS Course Data group box)	FOUNDATION

Page	Page Element
Plan HESA Data (KIS Course Data group box)	FOUNDATION
Sub-Plan HESA (KIS Course Data group box)	FOUNDATION

Field Derivation Rule: If KISCourse.KISTYPE = 1 or 2, derive a value. Otherwise, do not derive a value and leave the field blank.

Derivation Steps:

1. Use constant.
2. If KISCourse entity is based on a subplan, derive from the Sub-Plan HESA page.
3. Derive from the Plan HESA Data page.
4. Derive from the Program HESA Data page.
5. Use default.
6. Derive as *NULL ERROR*.

Subject of Course – HECOS

For HECOS 1 to 5, records are selected from HECoS Subjects defined at Sub-Plan, Plan or Program level (maximum 5 records). Records are ordered with the highest percentage first and then used in descending order for HECOS 1 to 5. The values are selected from the most recent effective-dated records where the effective date falls on or before the reporting period end date.

Return: Unistats/KIS

Entity: KISCourse

Pages Used:

Page	Page Element
Program HESA Data (HECoS Subjects)	Subject
Plan HESA Data (HECoS Subjects)	Subject
Sub-Plan HESA (HECoS Subjects)	Subject
Plan HESA Data (ILR Aims)	ILR Year
Sub-Plan HESA (ILR Aims)	ILR Year

Page	Page Element
Plan HESA Data (HESA Course)	HESA Year
Sub-Plan HESA (HESA Course)	HESA Year

Field Derivation Rule: Derive a value if the following conditions are met:

- HESA Year is not defined for Sub-Plan or Plan (that is, HESACourse does not exist)
- ILR Year is not defined for Sub-Plan or Plan (that is, ILRAims does not exist)

Otherwise, derive as null.

Derivation Steps:

1. If KISCourse entity is based on a Sub-Plan, derive as Subject value from the Sub-Plan HESA (HECoS Subjects) page.
2. Derive as Subject value from the Plan HESA Data (HECoS Subjects) page.
3. Derive as Subject value from the Program HESA Data (HECoS Subjects) page.
4. Derive as *NULL ERROR*.

Subject of Course – HECOS (HECOS2, HECOS3, HECOS4, HECOS5)

Return: Unistats/KIS

Entity: KISCourse

Pages Used:

Page	Page Element
Program HESA Data (HECoS Subjects)	Subject
Plan HESA Data (HECoS Subjects)	Subject
Sub-Plan HESA (HECoS Subjects)	Subject

Field Derivation Rule: If KISCourse.HECOS1 is not null or NULL ERROR, derive a value.

Derivation Steps:

1. If HECOS1 is derived from a Sub-Plan (Step 1), derive as Subject value from the Sub-Plan HESA (HECoS Subjects) page.
2. If HECOS1 is derived from a Plan (Step 2), derive as Subject value from the Plan HESA Data (HECoS Subjects) page.

3. If HECOS1 is derived from a Program (Step 3), derive as Subject value from the Program HESA Data (HECoS Subjects) page.
4. Derive as null.

Because HECOS1 is the only entity required, the other fields are derived as null if HECoS Subjects are not found or only one is defined.

Honours Award Provision (HONOURS)

Return: Unistats/KIS

Entity: KISCourse

Pages Used:

Page	Page Element
Program HESA Data (KIS Course Data group box)	HONOURS
Plan HESA Data (KIS Course Data group box)	HONOURS
Sub-Plan HESA (KIS Course Data group box)	HONOURS

Field Derivation Rule: If KISCourse.KISTYPE = 1 or 2, derive a value. Otherwise, do not derive a value and leave the field blank.

Derivation Steps:

1. Use constant.
2. If KISCourse entity is based on a subplan, derive from the Sub-Plan HESA page.
3. Derive from the Plan HESA Data page.
4. Derive from the Program HESA Data page.
5. Use default.
6. Derive as *NULL ERROR*.

Subject of Course – Full JACS (JACSA)

For JACSA, JACSB and JACSC, records are selected from Course Subjects defined at Subplan, Plan or Program level (maximum 3 records) in the same way as for the CourseSubject entity in the Student return. Records are ordered with the highest percentage first and then used in order for JACSA, JACSB and then JACSC.

Return: Unistats/KIS

Entity: KISCourse

Pages Used:

Page	Page Element
Program HESA Data (Course Subjects group box)	Subject
Plan HESA Data (Course Subjects group box)	Subject
Sub-Plan HESA (Course Subjects group box)	Subject
Plan HESA Data (ILR Aims group box)	ILR Year
Sub-Plan HESA (ILR Aims group box)	ILR Year
Plan HESA Data (HESA Course group box)	HESA Year
Sub-Plan HESA (ILR Aims group box)	HESA Year

Field Derivation Rule: Derive a value if the following conditions are met:

- KISCourse.KISTYPE = 1
- HESA Year is not defined for subplan or plan (that is, HESACourse does not exist)
- ILR Year is not defined for subplan or plan (that is, ILRAims does not exist)

Do not derive a value and leave the field blank, if the conditions are not met.

Derivation Steps:

1. If KISCourse entity is based on a subplan, derive as Subject value from the Sub-Plan HESA page.
2. Derive as Subject value from the Plan HESA Data page.
3. Derive as Subject value from the Program HESA Data page.
4. Derive as *NULL ERROR*.

Subject of course – Full JACS (JACSB and JACSC)

Return: Unistats/KIS

Entity: KISCourse

Pages Used:

Page	Page Element
Program HESA Data (Course Subjects group box)	Subject

Page	Page Element
Plan HESA Data (Course Subjects group box)	Subject
Sub-Plan HESA (Course Subjects group box)	Subject

Field Derivation Rule: If KISCourse.JACSA is not blank or is *NULL ERROR*, derive a value. Otherwise, do not derive a value and leave the field blank.

Derivation Steps:

1. If JACSA is derived from a subplan (Step 1), derive as Subject value from the Sub-Plan HESA page.
2. If JACSA is derived from a plan (Step 2), derive as Subject value from the Plan HESA Data page.
3. If JACSA is derived from a program (Step 3), derive as Subject value from the Program HESA Data page.
4. Do not derive a value and leave the field blank.

KIS Course Mode (KISAIM)

Return: Unistats/KIS

Entity: KISCourse

Pages Used:

Page	Page Element
Program HESA Data (KIS Course Data group box)	KISAIM
Plan HESA Data (KIS Course Data group box)	KISAIM
Sub-Plan HESA (KIS Course Data group box)	KISAIM

Field Derivation Rule: If KISCourse.KISTYPE = 1 or 2, derive a value. Otherwise, do not derive a value and leave the field blank.

Derivation Steps:

1. Use constant.
2. If KISCourse entity is based on a subplan, derive from the Sub-Plan HESA page.
3. Derive from the Plan HESA Data page.
4. Derive from the Program HESA Data page.
5. Use default.

6. Derive as *NULL ERROR*.

KIS Course Identifier (KISCOURSEID)

Return: Unistats/KIS

Entity: KISCourse

Pages Used:

Page	Page Element
Plan HESA Data	KISCOURSEID
Sub-Plan HESA Data	KISCOURSEID
Academic Plan Table	Plan code (ACAD_PLAN)
Academic Sub-Plan Table	Sub-Plan code (ACAD_SUB_PLAN)

Field Derivation Rule: Include for all entities

Derivation Steps:

1. If KIS Course entity is based on a Sub-Plan, derive value from Sub-Plan HESA Data. Otherwise, derive value from Plan HESA Data.
2. If KIS Course entity is based on a Sub-Plan, derive value from the Sub-Plan code. Otherwise, derive the Plan code.

KIS Course Mode (KISMODE)

Return: Unistats/KIS

Entity: KISCourse

Pages Used:

Page	Page Element
Program HESA Data (KIS Course Data group box)	KISMODE
Plan HESA Data (KIS Course Data group box)	KISMODE
Sub-Plan HESA (KIS Course Data group box)	KISMODE

Field Derivation Rule: Include for all KISCourse entities.

Derivation Steps:

1. Use constant.
2. If KISCourse entity is based on a subplan, derive from the Sub-Plan HESA page.
3. Derive from the Plan HESA Data page.
4. Derive from the Program HESA Data page.
5. Use default.
6. Derive as *NULL ERROR*.

Change of Course Location (LOCCHNGE)

Return: Unistats/KIS

Entity: KISCourse

Pages Used:

Page	Page Element
Program HESA Data (KIS Course Data group box)	LOCCHNGE
Plan HESA Data (KIS Course Data group box)	LOCCHNGE
Sub-Plan HESA (KIS Course Data group box)	LOCCHNGE

Field Derivation Rule: Derive a value only if KISCourse.DISTANCE = 0 or 2.

Do not derive a value and leave the field blank, if the conditions are not met.

Derivation Steps:

1. Use constant.
2. If KISCourse entity is based on a subplan, derive from the Sub-Plan HESA page.
3. Derive from the Plan HESA Data page.
4. Derive from the Program HESA Data page.
5. Use default.
6. Derive as *NULL ERROR*.

Learning and Teaching Methods URL (LTURL)

Return: Unistats/KIS

Entity: KISCourse

Pages Used:

Page	Page Element
Program HESA Data (KIS Course Links group box)	Learning/Teaching Methods URL
Plan HESA Data (KIS Course Links group box)	Learning/Teaching Methods URL
Sub-Plan HESA (KIS Course Links group box)	Learning/Teaching Methods URL

Field Derivation Rule: If KISCourse.KISTYPE = 1 or 3, derive a value. Otherwise, do not derive a value and leave the field blank.

Derivation Steps:

1. If KISCourse entity is based on a subplan, derive from the Sub-Plan HESA page.
2. Derive from the Plan HESA Data page.
3. Derive from the Program HESA Data page.
4. Derive as *NULL ERROR*.

NHS Funded Students (NHS)

Return: Unistats/KIS

Entity: KISCourse

Pages Used:

Page	Page Element
Program HESA Data (KIS Course Data group box)	NHS
Plan HESA Data (KIS Course Data group box)	NHS
Sub-Plan HESA (KIS Course Data group box)	NHS

Field Derivation Rule: Derive a value if the following conditions are met:

- KISCourse.KISTYPE = 1 or 2
- HESACourse does not exist
- ILRAims does not exist

Do not derive a value and leave the field blank, if the conditions are not met.

Derivation Steps:

1. Use constant.
2. If KISCourse entity is based on a subplan, derive from the Sub-Plan HESA page.
3. Derive from the Plan HESA Data page.
4. Derive from the Program HESA Data page.
5. Use default.
6. Derive as *NULL ERROR*.

Length of Courses (NUMSTAGE)

Return: Unistats/KIS

Entity: KISCourse

Pages Used:

Page	Page Element
Program HESA Data (KIS Course Data group box)	NUMSTAGE
Plan HESA Data (KIS Course Data group box)	NUMSTAGE
Sub-Plan HESA (KIS Course Data group box)	NUMSTAGE

Field Derivation Rule: If KISCourse.KISMODE = 1 (full-time) or 3 (both), derive a value. Otherwise, derive as null.

Derivation Steps:

1. Use constant.
2. If KISCourse entity is based on a subplan, derive from the Sub-Plan HESA page.
3. Derive from the Plan HESA Data page.
4. Derive from the Program HESA Data page.
5. Use default.
6. Derive as *NULL ERROR*.

Related KIS 2, 3 (RELATEDKIS2, RELATEDKIS3)

Return: Unistats/KIS

Entity: KISCourse

Pages Used:

Page	Page Element
Program HESA Data (KIS Course Data group box)	RELATEDKIS2, RELATEDKIS3
Plan HESA Data (KIS Course Data group box)	RELATEDKIS2, RELATEDKIS3
Sub-Plan HESA (KIS Course Data group box)	RELATEDKIS2, RELATEDKIS3

Field Derivation Rule: If KISCourse.RELATEDKIS is not blank or is *NULL ERROR*, derive a value. Otherwise, do not derive a value and leave the field blank.

Derivation Steps:

1. If RELATEDKIS is derived from Step 2, derive from the Sub-Plan HESA page.
2. If RELATEDKIS is derived from Step 3, derive from the Plan HESA Data page.
3. If RELATEDKIS is derived from Step 4, derive from the Program HESA Data page.
4. Do not derive a value and leave the field blank.

Sandwich Year Availability (SANDWICH)

Return: Unistats/KIS

Entity: KISCourse

Pages Used:

Page	Page Element
Program HESA Data (KIS Course Data group box)	SANDWICH
Plan HESA Data (KIS Course Data group box)	SANDWICH
Sub-Plan HESA (KIS Course Data group box)	SANDWICH

Field Derivation Rule: If KISCourse.KISTYPE = 1 or 2, derive a value. Otherwise, do not derive a value and leave the field blank.

Derivation Steps:

1. Use constant.
2. If KISCourse entity is based on a subplan, derive from the Sub-Plan HESA page.
3. Derive from the Plan HESA Data page.
4. Derive from the Program HESA Data page.

5. Use default.
6. Derive as *NULL ERROR*.

Support Details URL (SUPPORTURL)

Return: Unistats/KIS

Entity: KISCourse

Pages Used:

Page	Page Element
Program HESA Data (KIS Course Links group box)	SUPPORTURL
Plan HESA Data (KIS Course Links group box)	SUPPORTURL
Sub-Plan HESA (KIS Course Links group box)	SUPPORTURL

Field Derivation Rule: If KISCourse.KISTYPE = 1 or 2, derive a value. Otherwise, do not derive a value and leave the field blank.

Derivation Steps:

1. If KISCourse entity is based on a subplan, derive from the Sub-Plan HESA page.
2. Derive from the Plan HESA Data page.
3. Derive from the Program HESA Data page.
4. Use default.
5. Derive as null.

Teaching Institution UK Provider Reference Number (TEACHUKPRN)

Return: Unistats/KIS

Entity: KISCourse

Pages Used:

Page	Page Element
Program HESA Data (KIS Course Data group box)	TEACHUKPRN
Plan HESA Data (KIS Course Data group box)	TEACHUKPRN

Page	Page Element
Sub-Plan HESA (KIS Course Data group box)	TEACHUKPRN

Field Derivation Rule: Derive a value if the following conditions are met:

- HESACourse does not exist
- ILRAims does not exist

Do not derive a value and leave the field blank, if the conditions are not met.

Derivation Steps:

1. Use constant.
2. If KISCourse entity is based on a subplan, derive from the Sub-Plan HESA page.
3. Derive from the Plan HESA Data page.
4. Derive from the Program HESA Data page.
5. Use default.
6. Do not derive a value and leave the field blank.

Note: Three fields are provided for TEACHUKPRN in Campus Solutions rather than the maximum 50 allowed by HESA.

Teaching Institution UK Provider Reference Number (TEACHUKPRN2, TEACHUKPRN3)

Return: Unistats/KIS

Entity: KISCourse

Pages Used:

Page	Page Element
Program HESA Data (KIS Course Data group box)	TEACHUKPRN2, TEACHUKPRN3
Plan HESA Data (KIS Course Data group box)	TEACHUKPRN2, TEACHUKPRN3
Sub-Plan HESA (KIS Course Data group box)	TEACHUKPRN2, TEACHUKPRN3

Field Derivation Rule: If KISCourse.TEACHUKPRN is not blank, derive a value. Otherwise, do not derive a value and leave the field blank.

Derivation Steps:

1. If KISCourse entity is based on a subplan, derive from the Sub-Plan HESA page.
2. Derive from the Plan HESA Data page.
3. Derive from the Program HESA Data page.
4. Do not derive a value and leave the field blank.

Course Title (TITLEK)

Return: Unistats/KIS

Entity: KISCourse

Pages Used:

Page	Page Element
Plan HESA Data	KIS Title Course Title
Academic Plan Table	Description (maximum 30 characters)
Sub-Plan HESA	KIS Title Course Title
Academic Sub-Plan Table	Description (maximum 30 characters)

Field Derivation Rule: If KISCourse.KISTYPE = 1 or 2, derive a value. Otherwise, do not derive a value and leave the field blank.

Derivation Steps:

1. If KISCourse entity is based on a subplan, derive as KIS Title from the Sub-Plan HESA page.
2. If KISCourse entity is based on a subplan, derive as Course Title from the Sub-Plan HESA page.
3. If KISCourse entity is based on a subplan, derive as combination of plan and subplan descriptions separated by a space.
4. Derive as KIS Title from the Plan HESA Data page.
5. Derive as Course Title from the Plan HESA Data page.
6. Derive as plan description.

Note: Because the TITLEK is derived as part of the initial creation of the KIS Course entity, the derivation steps are not captured in the Course Extract Field record and so TITLEK is not displayed on the Course Extract Data page.

Teacher Training Course (TTCIDC)

Return: Unistats/KIS

Entity: KISCourse

Pages Used:

Page	Page Element
Program HESA Data	TTCIDC
Plan HESA Data	TTCIDC
Sub-Plan HESA	TTCIDC
Plan HESA Data (ILR Aims group box)	ILR Year
Sub-Plan HESA (ILR Aims group box)	ILR Year
Plan HESA Data (HESA Course group box)	HESA Year
Sub-Plan HESA (ILR Aims group box)	HESA Year

Field Derivation Rule: Derive a value if the following conditions are met:

- HESA Year is not defined for subplan or plan (that is, HESACourse does not exist)
- ILR Year is not defined for subplan or plan (that is, ILRAims does not exist)

Do not derive a value and leave the field blank, if the conditions are not met.

Derivation Steps:

1. Use constant.
2. If KISCourse entity is based on a subplan, derive from the Sub-Plan HESA page.
3. Derive from the Plan HESA Data page.
4. Derive from the Program HESA Data page.
5. Use default.
6. Derive as *NULL ERROR*.

UCAS Programme Code for the Course (UCASPROGID)

Return: Unistats/KIS

Entity: KISCourse

Pages Used:

Page	Page Element
Plan HESA Data (KIS Course Data group box)	UCASPROGID
Sub-Plan HESA (KIS Course Data group box)	UCASPROGID

Field Derivation Rule: Derive a value if KISCourse.KISTYPE = 1 or 2. Otherwise, do not derive a value and leave the field blank.

Derivation Steps:

1. If KISCourse entity is based on a subplan, derive from the Sub-Plan HESA page.
2. Derive from the Plan HESA Data page.
3. Do not derive a value and leave the field blank.

Application UKPRN (UKPRNAPPLY)

Return: Unistats/KIS

Entity: KISCourse

Pages Used:

Page	Page Element
Program HESA Data (KIS Course Data group box)	UKPRNAPPLY
Plan HESA Data (KIS Course Data group box)	UKPRNAPPLY
Sub-Plan HESA (KIS Course Data group box)	UKPRNAPPLY

Field Derivation Rule: Include for all KISCourse entities.

Derivation Steps:

1. If KISCourse entity is based on a subplan, derive from the Sub-Plan HESA page.
2. Derive from the Plan HESA Data page.
3. Derive from the Program HESA Data page.
4. Do not derive a value and leave the field blank.

Year Abroad Availability (YEARABROAD)

Return: Unistats/KIS

Entity: KISCourse

Pages Used:

Page	Page Element
Program HESA Data (KIS Course Data group box)	YEARABROAD
Plan HESA Data (KIS Course Data group box)	YEARABROAD
Sub-Plan HESA (KIS Course Data group box)	YEARABROAD

Field Derivation Rule: If KISCourse.KISTYPE = 1 or 2, derive a value. Otherwise, do not derive a value and leave the field blank.

Derivation Steps:

1. Use constant.
2. If KISCourse entity is based on a subplan, derive from the Sub-Plan HESA page.
3. Derive from the Plan HESA Data page.
4. Derive from the Program HESA Data page.
5. Use default.
6. Derive as *NULL ERROR*.

Unistats/KIS Return: Accreditation Entity

The Create Extract process creates up to ten Accreditation entities in the Accreditation Extract Data record (SSR_HE_ACR_EXT) for each KISCourse entity where the derived KISTYPE = 1 or 2. If no Accreditation records are defined for the academic plan or subplan then no entities are created. KISTYPE defaults to 1. Only records with an Accreditation Type value are considered.

The fields are derived and stored in the Accreditation Fields Extract record (SSR_HE_ACREX_FL).

Accreditation Type (ACCTYPE)

Return: Unistats/KIS

Entity: Accreditation

Pages Used:

Page	Page Element
Program HESA Data (Accreditation group box)	Accreditation Type
Plan HESA Data (Accreditation group box)	Accreditation Type
Sub-Plan HESA (Accreditation group box)	Accreditation Type

Field Derivation Rule: Include for all Accreditation entities.

Derivation Steps:

1. If KISCOURSE entity is based on a subplan, derive from the Sub-Plan HESA page.
2. Derive from the Plan HESA Data page.
3. Derive from the Program HESA Data page.

Accreditation Dependency (ACCDEPEND)

Return: Unistats/KIS

Entity: Accreditation

Pages Used:

Page	Page Element
Program HESA Data (Accreditation group box)	Dependency (check box)
Plan HESA Data (Accreditation group box)	Dependency (check box)
Sub-Plan HESA (Accreditation group box)	Dependency (check box)

Field Derivation Rule: Include for all Accreditation entities.

Derivation Steps:

1. If ACCTYPE is derived from Step 1 (subplan), derived from the same Accreditation record. If the check box is selected, *1* is derived, otherwise *0* is derived.
2. If ACCTYPE is derived from Step 2 (plan), derived from the same Accreditation record. If the check box is selected, *1* is derived, otherwise *0* is derived.
3. If ACCTYPE is derived from Step 3 (program), derived from the same Accreditation record. If the check box is selected, *1* is derived, otherwise *0* is derived.

Accreditation Dependency URL (ACCDEPENDURL)

Return: Unistats/KIS

Entity: Accreditation

Pages Used:

Page	Page Element
Program HESA Data (Accreditation group box)	Dependency URL
Plan HESA Data (Accreditation group box)	Dependency URL
Sub-Plan HESA (Accreditation group box)	Dependency URL

Field Derivation Rule: If Accreditation.ACCDEPEND = 1, derive a value. Otherwise, do not derive a value and leave the field blank.

Derivation Steps:

1. If ACCTYPE is derived from Step 1 (subplan), derived from the same Accreditation record.
2. If ACCTYPE is derived from Step 2 (plan), derived from the same Accreditation record.
3. If ACCTYPE is derived from Step 3 (program), derived from the same Accreditation record.

Unistats/KIS Return: CourseLocation Entity

The Create Extract process creates up to three CourseLocation entities for each KISCourse record where KISCourse.KISTYPE = 1 or 2, where the Location ID fields are defined for the subplan, plan or program. If Location ID values are not defined, the process does not create the entities.

Location Identifier (LOCID)

Return: Unistats/KIS

Entity: CourseLocation

Pages Used:

Page	Page Element
Program HESA Data (KIS Course Data group box)	LOCID, LOCID2, LOCID3
Plan HESA Data (KIS Course Data group box)	LOCID, LOCID2, LOCID3

Page	Page Element
Sub-Plan HESA (KIS Course Data group box)	LOCID, LOCID2, LOCID3

Derivation Steps: Include for all CourseLocation entities.

1. If KISCourse entity is based on a subplan, derive from the Sub-Plan HESA page.
2. Derive from the Plan HESA Data page.
3. Derive from the Program HESA Data page.
4. Use default that is defined for LOCID.

UCAS Course Code for the Course (UCASCOURSEID)

Return: Unistats/KIS

Entity: CourseLocation

Pages Used:

Page	Page Element
Plan HESA Data (KIS Course Data group box)	UCASCOURSEID, UCASCOURSEID2, UCASCOURSEID3
Sub-Plan HESA (KIS Course Data group box)	UCASCOURSEID, UCASCOURSEID2, UCASCOURSEID3
UCAS Course (Set Up SACR, Product Related, Recruiting and Admissions, UCAS, Mappings, UCAS Course)	UCAS Course Code

Derivation Steps: Include for all CourseLocation entities.

Derivation Steps:

1. If LOCID is derived in Step 1 (that is, subplan) from **LOCID**, derive **UCASCOURSEID** value from the Sub-Plan HESA page.
2. If LOCID is derived in Step 1 (that is, subplan) from **LOCID**, map the combination of subplan and plan to a UCAS course code via the UCAS mappings on the UCAS Course page. Refer to the following notes on UCAS Course mappings.
3. If LOCID is derived in Step 1 (that is, subplan) from **LOCID2**, derive **UCASCOURSEID2** value from the Sub-Plan HESA page.
4. If LOCID is derived in Step 1 (that is, subplan) from **LOCID3**, derive **UCASCOURSEID3** value from the Sub-Plan HESA page.

5. If LOCID is derived in Step 1 (that is, subplan) from **LOCID**, **LOCID2** or **LOCID3**, do not derive a value and leave the field blank.
6. If LOCID is derived in Step 2 (that is, plan) from **LOCID**, derive **UCASCOURSEID** value from the Plan HESA Data page.
7. If LOCID is derived in Step 2 (that is, plan) from **LOCID**, map the plan to a UCAS course code via the UCAS mappings on the UCAS Course page. Refer to the following notes on UCAS Course mappings.
8. If LOCID is derived in Step 2 (that is, plan) from **LOCID2**, derive **UCASCOURSEID2** value from the Plan HESA Data page.
9. If LOCID is derived in Step 2 (that is, plan) from **LOCID3**, derive **UCASCOURSEID3** value from the Plan HESA Data page.
10. If LOCID is derived in Step 2 (that is, plan) from **LOCID**, **LOCID2** or **LOCID3**, do not derive a value and leave the field blank.
11. If LOCID is derived in Step 3 (that is program) or Step 4 (that is default), do not derive a value and leave the field blank.

Notes on UCAS Course mappings

The UCAS course code (SAD_UC_COURSE) is selected from the most recent record (by entry year and entry month) in SAD_UC_COURSE where the subplan (for step 2) or the plan (for step 7) is defined for the UCAS Course. The mappings are only done for entities derived from LOCID and not for entities derived for LOCID2 or LOCID3.

Step 2 - For subplans, records are selected from SAD_UC_COURSE where the academic institution matches the institution of the Unistats/KIS return, the academic subplan matches the KISCOURSEID and the active flag is 'Y'. If multiple records are found the record with the highest entry year (SAD_UC_ENTRYYEAR) is selected. If multiple records for the same Entry Year are found, the record with the highest Entry Month is selected. If multiple records for the same Entry Year and Entry Month are found (that is, more than one UCAS Course Code is found), *NULL ERROR* is derived.

Step 7 - For plans, records are selected from SAD_UC_COURSE where the academic institution matches the institution of the Unistats/KIS return, the academic plan matches the KISCOURSEID, the subplan is blank and the Active flag is 'Y'. If multiple records are found the record with the highest entry year (SAD_UC_ENTRYYEAR) is selected. If multiple records for the same Entry Year are found, the record with the highest Entry Month is selected. If multiple records for the same Entry Year and Entry Month are found (that is, more than one UCAS Course Code is found), *NULL ERROR* is derived.

Unistats/KIS Return: HESACourse Entity

The Create Extract process creates one or more HESACourse entities in the HESA Course Extract Data record (SSR_HE_HCR_EXT) for each KIS Course entity where the derived KISTYPE = 1. If no HESACourse records are defined for the academic plan or subplan then no entities are created.

The fields are derived and stored in the HESA Course Fields Extract record (SSR_HE_HCREX_FL).

HESA Course Identifier (HESACOURSEID)

Return: Unistats/KIS

Entity: HESACourse

Pages Used:

Page	Page Element
Plan HESA Data (HESA Course group box)	Course ID
Sub-Plan HESA (HESA Course group box)	Course ID

Field Derivation Rule: Include for all HESACourse entities.

Derivation Steps:

1. If KISCourse entity is based on a subplan, derive from the Sub-Plan HESA page.
2. Derive from the Plan HESA Data page.

Note: Course ID is mandatory to define a HESA Course record.

Reporting Year of HESA Course (HESAYEAR)

Return: Unistats/KIS

Entity: HESACourse

Pages Used:

Page	Page Element
Plan HESA Data (HESA Course group box)	HESA Year
Sub-Plan HESA (HESA Course group box)	HESA Year

Field Derivation Rule: Include for all HESACourse entities.

Derivation Steps:

1. If KISCourse entity is based on a subplan, derive from the Sub-Plan HESA page.
2. Derive from the Plan HESA Data page.

Registering Institution UK Provider Reference Number (REGUKPRN)

Return: Unistats/KIS

Entity: HESACourse

Pages Used:

Page	Page Element
Plan HESA Data (HESA Course group box)	Registering Institution UKPRN
Sub-Plan HESA (HESA Course group box)	Registering Institution UKPRN

Field Derivation Rule: Include for all HESACourse entities.

Derivation Steps:

1. If KISCourse entity is based on a subplan, derive from the Sub-Plan HESA page.
2. Derive from the Plan HESA Data page.
3. Do not derive a value and leave the field blank.

Note: Only non-zero values are derived.

Teaching Institution UK Provider Reference Number (TEACHUKPRN)

Return: Unistats/KIS

Entity: HESACourse

Pages Used:

Page	Page Element
Plan HESA Data (HESA Course group box)	Teaching Institution UKPRN
Sub-Plan HESA (HESA Course group box)	Teaching Institution UKPRN

Field Derivation Rule: Include for all HESACourse entities.

Derivation Steps:

1. If KISCourse entity is based on a subplan, derive from the Sub-Plan HESA page.
2. Derive from the Plan HESA Data page.
3. Do not derive a value and leave the field blank.

Note: Only non-zero values are derived.

Unistats/KIS Return: ILRAims Entity

The Create Extract process creates one or more ILRAims entities in the ILRAims Extract Data record (SSR_HE_ILR_EXT) for each KISCourse entity where the derived KISTYPE = 1. If no ILRAims records are defined for the academic plan or subplan then no entities are created.

The fields are derived and stored in the ILRAims Extract record (SSR_HE_ILREX_FL).

LAD/LARA Qualification Aim Course Code (ILRAIMID)

Return: Unistats/KIS

Entity: ILRAims

Pages Used:

Page	Page Element
Plan HESA Data (ILR Aims group box)	ILR Aim
Sub-Plan HESA (ILR Aims group box)	ILR Aim

Field Derivation Rule: Include for all ILRAims entities.

Derivation Steps:

1. If KISCourse entity is based on a subplan, derive from the Sub-Plan HESA page.
2. Derive from the Plan HESA Data page.

Year of ILR Course (ILRYEAR)

Return: Unistats/KIS

Entity: ILRAims

Pages Used:

Page	Page Element
Plan HESA Data (ILR Aims group box)	ILR Year
Sub-Plan HESA (ILR Aims group box)	ILR Year

Field Derivation Rule: Include for all ILRAims entities.

Derivation Steps:

1. If KISCourse entity is based on a subplan, derive from the Sub-Plan HESA page.
2. Derive from the Plan HESA Data page.

Registering Institution UK Provider Reference Number (REGUKPRN)

Return: Unistats/KIS

Entity: ILRAims

Pages Used:

Page	Page Element
Plan HESA Data (ILR Aims group box)	Registering Institution UKPRN
Sub-Plan HESA (ILR Aims group box)	Registering Institution UKPRN

Field Derivation Rule: Include for all ILRAims entities.

Derivation Steps:

1. If KISCourse entity is based on a subplan, derive from the Sub-Plan HESA page.
2. Derive from the Plan HESA Data page.
3. Do not derive a value and leave the field blank.

Note: Only non-zero values are derived.

Teaching Institution UK Provider Reference Number (TEACHUKPRN)

Return: Unistats/KIS

Entity: ILRAims

Pages Used:

Page	Page Element
Plan HESA Data (ILR Aims group box)	Teaching Institution UKPRN
Sub-Plan HESA (ILR Aims group box)	Teaching Institution UKPRN

Field Derivation Rule: Include for all ILRAims entities.

Derivation Steps:

1. If KISCourse entity is based on a subplan, derive from the Sub-Plan HESA page.

2. Derive from the Plan HESA Data page.
3. Do not derive a value and leave the field blank.

Note: Only non-zero values are derived.

(NZL) Generating Government Reports

Understanding New Zealand Government Reports

This section discusses:

- The SDR process.
- NZQA reports.
- The Graduation Destination Survey report.

The SDR Process

Use the Single Data Return SQR process (SRSDRNZL) to create the SDR report for the New Zealand Ministry of Education (MoE). The SDR consists of five separate data files:

- **Student File:** This file contains records for individual students who are enrolled in a course or program in the current year and have not received a complete refund of tuition fees.

All students who are enrolled in courses or programs should be reported, regardless of the level of study or the funding source. Every student in the course enrollment file should appear once in the student file.

- **Course Enrollment File:** This file contains records for each course enrollment instance.

For each individual student, a record of each separate course enrollment is required. All valid enrollments should be reported, regardless of the level of study or the funding source. Every student in the student file should appear at least once in the course enrollment file—a student who is enrolled in two or more courses will have two or more rows in the course enrollment file, but only one row in the student file.

- **Course Register file:** This file contains records for all courses in which students are enrolled in the current year.

Every unique course in the course enrollment file should appear in the course register file.

- **Qualification Completion file:** This file contains records for individual students who have passed all of the academic requirements for a recognized qualification in the previous year.

Only students who are completing a formally recognized qualification should be included in the qualification completion file.

- **Course Completion file:** This file contains course enrollment records for all individual students who were enrolled in a recognized qualification during the previous year.

The file should include all courses for which these students were actively studying in the January to December period in the previous year. Only students who are enrolled in a formally recognized

qualification should be included in the course completion file. All type D student course enrollments for the previous full year must be reported in June of the following year with the course outcome.

The MoE requires that your institution generate these SDR files on predefined dates—once a year for the Qualification Completion file, three times a year for the other three files. With the exception of the Qualification Completion file, these files provide a snapshot of student, course, and course enrollment data at a particular point in time.

The SQR process contains two sections. The first section of the process extracts the data fields that are required by the MoE and loads them into a work table for SDR. This work table is the record `SSR_SDR_EXTRACT`, and it serves as a temporary holding place for the data that you extract. The process extracts data for all four file types, but the type and number of records that are written to the work table depend on the parameters that are entered on the run control panel. The extract includes student data, enrollment data, course data, and qualification completion data from various parts of your PeopleSoft Campus Solutions system.

Because the data fields in each of the SDR files overlap, the SDR work table acts as a storage table for the extracted data of all the files. All the records are deleted from the work table prior to extraction. When the SDR process is run in final mode, the process additionally saves the Qualification Complete file and selected SDR fields in history tables.

The second section of the SQR generates the ASCII flat files using the data that is in the SDR work table. These ASCII flat files can be either the Student file, the Course Enrollment file, the Course Register file, or the Qualification Completion file.

NZQA Reports

The `NZQARPTS.sqr` report process produces three reports:

- **Hook On Request:** This report provides a listing of all students who have not previously been registered with NQF and have paid the 25.00 NZD Hook On fee.

The system selects students who do not have an NZQA ID in the system, have not previously been reported to the NQF (`SCC_PERSONL_NZL.SSR_NZQA_RPT_FLAG` is not `Y`), and who have paid the NQF Hook On fee.

When the process selects a student, the `SCC_PERSONL_NZL.SSR_NZQA_RPT_FLAG` is always set to `Y`.

The system produces the Personal Details file with one row per student and the SQR report (`NZQARPTS.lis`) listing the total number of students in the Hook On file.

- **US Results (Unit Standard Results):** This report includes unit standard results (complete or not completed) for students who have paid the per credit fees.

The system selects students who:

- Have a milestone flag (`MLSTN_ATMPT.MILESTONE_COMPLETE`) equal to `Y` or `N`.
- Have a reported flag (`SSR_MLSTATM_NZL.REPORTED_FLAG`) that is not `Y`.
- Have paid the associated fees.

The system produces the Results file with one row per student per unit standard, the Personal Details file with one row per student in the Results file, and the SQR Report (`NZQARPTS.lis`) listing a row

for each unit standard (milestone) showing the NQF code, NQF credits for that code, and total number of credits reported for all students who have been reported in that unit standard.

- NZDipBus (NZ Diploma in Business Results): This part of the process is used to report paid NZQA exam results for the NZ Diploma in Business and for Advanced Vocational Awards. Exam results are determined by the grade in STDNT_ENRL. Milestones are not used for this process. The process selects students for this report by searching for payment of a specific exam fee (identified by an item type code specified on the NZQA Run Control page).

The system produces the Personal Details file and the Results file.

The Graduation Destination Survey Report

The Graduate Destination Report contains the following information:

- The NZVCC Institution code.
- Bio/Demo data on each student, including ethnicity and residency data.
- The NZVCC Qualification.
- The NZVCC Subject.

Processing SDR Extracts

This section provides an overview of SDR processing and discusses how to:

- Process SDR extracts.
- Suppress course offerings in the Course Enrollment and Course Completion files.

Understanding SDR Processing

The enrollment reporting for the SDR is based on course enrollments. In Campus Solutions you enroll in classes, not courses. Thus, you might have multiple classes for a particular course in a given term. The SDR extract, therefore, includes enrollments only in classes that are primary components.

Data that is specific to the SDR report is entered in the different enrollment components. While the system maintains data for all class enrollment records, the SDR process extracts data for only the enrollment records of primary components.

Page Used to Process Single Data Return Extracts

<i>Page Name</i>	<i>Definition Name</i>	<i>Navigation</i>	<i>Usage</i>
SDR Extract NZL	SSR_SDR_EXTRACT	Records and Enrollment > Enrollment Reporting > SDR Reporting NZL > SDR Extract NZL > SDR Extract NZL	Process the SDR extracts for enrollment reporting to the New Zealand Ministry of Education.

Page Name	Definition Name	Navigation	Usage
SDR Course Suppression	SSR_SDR_CRSE_SUP	Records and Enrollment > Enrollment Reporting > SDR Reporting NZL > SDR Course Suppression > SDR Course Suppression	Identify the course offerings that you want to suppress in the Course Enrolment and Course Completion files.

Processing SDR Extracts

Access the SDR Extract NZL page (**Records and Enrollment > Enrollment Reporting > SDR Reporting NZL > SDR Extract NZL > SDR Extract NZL**).

This example illustrates the fields and controls on the SDR Extract NZL page. You can find definitions for the fields and controls later on this page.

SDR Extract NZL

Run Control ID: SDR [Report Manager](#) [Process Monitor](#) Run

*Academic Institution: Silver Fern University

*Extract Date:

File Mode:

Permanent Post Code:

Term Post Code:

Qualification Completion File

Pop Selection

Selection Tool:

Query Name: [Launch Query Manager](#) [Preview Selection Results](#)

*SDR Output Directory:

Field or Control	Description
Extract Date	Enter the MoE-prescribed date for running the extract.
File Mode	<p>Select a value to indicate whether the process extracts the records in <i>Review</i> mode or <i>Final</i> mode. <i>Review</i> appears by default.</p> <p>In <i>Review</i> mode, the process produces the SDR files. In <i>Final</i> mode, the process produces the SDR files and the Qualification Completion File is stored in the history table (PS_SSR_SDR_QC_HIST). Emplid, Extract Date, Permanent Post Code, Last School Attended, and Last School Year are also stored for use in subsequent SDR reporting in the PS_SSR_SDR_HISTORY table.</p>

Field or Control	Description
Permanent Post Code and Term Post Code	You must enter a value in these fields for extract of the post codes in the Student files.

Pop Selection

The Pop Selection group box becomes available when you select the **Qualification Completion File** check box. *PS Query* is the only available **Selection Tool**. The Population Selection query is mandatory if the **Qualification Completion File** check box is selected.

The extract process uses the Population Selection query to identify records for the Qualification Completion extract.

If the Qualification Completion check box is not selected, the extract process selects all students awarded a degree.

Suppressing Course Offerings in the Course Enrollment and Course Completion Files

Access the SDR Course Suppression page (**Records and Enrollment > Enrollment Reporting > SDR Reporting NZL > SDR Course Suppression > SDR Course Suppression**).

Field or Control	Description
Course Enrollment File	If you select this check box, the course offering is suppressed during the extract of the Course Enrollment File.
Course Completion File	If you select this check box, the course offering is suppressed during the extract of the Course Completion File.

Running NZQA Reports

Run the NZQARPTS SQR process to generate one of the three required NZQA reports.

This section discusses how to run the NZQA reports.

Page Used to Run the NZQA Reports

Page Name	Definition Name	Navigation	Usage
NZQA Reports	SSR_RUN_NZQA_RPTS	Records and Enrollment > Enrollment Reporting > NZQA Reports NZL > NZQA Reports	Select and run one of the NZQA reports.

Running the NZQA Reports

Access the NZQA Reports page (**Records and Enrollment > Enrollment Reporting > NZQA Reports NZL > NZQA Reports**).

<i>Field or Control</i>	<i>Description</i>
Term	If running the NZDipBus report, enter the term for which you are running the report.
NZDipBus Exam Item Type	If running the NZDipBus report, enter the item type used for the NZDipBus exam fee at your institution.
Fee Code	If running the Hook-On Request report, enter the fee code used for the Hook-On fee at your institution.
Address Usage	Select the address usage that the process should follow. The process uses this to determine which address to use for students included in the report.
Personal Details File	Enter the file path and file name that you want the system to use to save the Personal Detail file.
Results File	Enter the file path and file name that you want the system to use to save the Results file.
Credits File	Enter the file path and file name that you want the system to use to save the Credits file.

Generating the Graduation Destination Survey Data File

Use the SRUGDNZL SQR to generate the data file for the NZVCC graduation destination survey.

This section discusses how to run the NZVCC SQR.

Page Used to Generate the Graduation Destination Survey Data File

<i>Page Name</i>	<i>Definition Name</i>	<i>Navigation</i>	<i>Usage</i>
NZVCC Survey Data File	SSR_RUNCTL_UGDS_NZ	Records and Enrollment > Graduation > NZVCC Survey Data File NZL > NZVCC Survey Data File	Run the SQR to generate the NZVCC Survey Data file.

Running the NZVCC SQR

Access the NZVCC Survey Data File page (**Records and Enrollment > Graduation > NZVCC Survey Data File NZL > NZVCC Survey Data File**).

<i>Field or Control</i>	<i>Description</i>
File Name	Enter the file path and name for the system to use to save the University Graduate Destinations Survey file.

Chapter 63

Student Records Reports

Student Records Reports: A-Z

This table lists the Student Records reports, sorted by report ID.

See the product documentation for *PeopleTools: Process Scheduler*

Report ID and Report Name	Description	Navigation	Run Control Page
CCDATADC Data Dictionary	Lists all the fields in your database with their basic information, including field name, description, field type, field size and field format. Reporting Tool: SQR	Set Up SACR > Product Related > Student Records > Reports > Data Dictionary	PRCSRUNCNTL
SR201 Schedule of Classes	Lists a variety of details for each class that you schedule. Reporting Tool: SQR	Curriculum Management > Schedule of Classes > Print Class Schedule	RUNCTL_SRYSCHD
SR301 Course Catalog	Generates the Course Catalog report based on the selection criteria and report options you specify at runtime. Reporting Tool: SQR	Curriculum Management > Course Catalog > Print Course Catalog	RUNCTL_SRYCATLG
SR800CA Class Attendance	Generates the Class Attendance Report. This is a useful tool for hard-copy attendance tracking. Reporting Tool: Oracle BI Publisher	Curriculum Management > Class Attendance > Attendance Roster by Class	CLASS_ATTENDANCE
SR802 Enrollment Verification	Generates an enrollment verification report for individual students. Reporting Tool: Oracle BI Publisher	Records and Enrollment > Enrollment Verifications > Enrollment Verification	ENRL_VER_REQUEST

Report ID and Report Name	Description	Navigation	Run Control Page
SR805 Graduation Report	Lists all current degree checkout status data for all students in your selected population, including ID, career, program, plan, subplan, degree, status, expected graduation term and completion term data. (Reporting tool: Oracle BI Publisher)	Records and Enrollment > Graduation > Graduation Report	RUNCTL_GRAD_RPT
SRCLSRST Class Roster	Generates a report of students enrolled in a particular class, including name, grading basis, units taken, primary academic program, and enrollment status. If requested, this report also lists class permissions information. Reporting Tool: SQR	Curriculum Management > Class Roster > Class Roster	RUNCTL_SRCLASSRSTR
SRENRADV Enrollment Advisement	Generates an Enrollment Advisement report. Reporting Tool: SQR	Curriculum Management > Enrollment Requirements > Enrollment Advisement Report	RUNCTL_SRENRADV
SREXSCHD Exam Scheduling	Lists each course's scheduled exam time and facility. Reporting Tool: SQR	Curriculum Management > Schedule of Classes > Generate Exam Schedule	RUNCTL_SREXSCHD
SRGBEXPT Grading Basis Exception	Displays active grade basis exception mapping rules and their details. Reporting Tool: SQR	Set Up SACR > Product Related > Student Records > Reports > Grade Basis Exception	RUNCTL_SRGBEXCPT
SRGRDLPS Grade Lapse	Lists parameter information and enrollment request numbers for all lapsed grade processes. Reporting Tool: SQR	Curriculum Management > Grading > Grade Lapse	RUNCTL_SR_GRD_LPS

Report ID and Report Name	Description	Navigation	Run Control Page
SRLMSEX LMS Batch Extract	Lists high level information about a specific extract process. Detail such as setup values, run control parameters, output file formats, and total record counts referenced by a specific extract process are listed on the report. The report does NOT list the extracted data and is not to be confused with the actual extract file(s). To view the extracted data you must view the extract file itself. Reporting Tool: SQR	Curriculum Management > Learning Management Systems > LMS Batch Extract Process	RUNCTL_SRLMSEX3
SRNSLCEX NSLC Extract File Creation	Generates a report for National Student Clearinghouse (NSLC). This report lists run variables, informational messages about the process run, and NSLC report totals. Reporting Tool: SQR	Records and Enrollment > Enrollment Reporting > NSLC Report	RUNCTL_SRNSLC
SRRSTRPT Grade Roster	Generates a report of the grade roster that instructors can use to write their midterm or final grades, or administrators can use to print out hard copies of the final grades for classes. Reporting Tool: SQR	Curriculum Management > Grading > Print Grade Roster	RUNCTL_SRGRDROSTER
SRSPRMSN Class Permission	Generates a report that lists the number of class permissions assigned for each class. Reporting Tool: SQR	Records and Enrollment > Term Processing > Class Permissions > Class Permissions	RUNCTL_SRSPRMSN
SRSTDNT2 Study List	Generates an individual student's study list by academic career and term. Reporting Tool: SQR	Records and Enrollment > Enrollment Summaries > Enrollment Summary	STDNT_ENRL_INQ

Report ID and Report Name	Description	Navigation	Run Control Page
SRTCSTEV Student Transfer Evaluation	Lists an individual's transfer credit record. The report is designed in an easy-to-read format intended to be distributed to prospects, applicants, students, recruiters, or advisors. They can see what classes transferred and to which equivalent classes. They can also view their internal and external GPAs. Reporting Tool: SQR	Records and Enrollment > Transfer Credit Evaluation > Transfer Evaluation Report	RUNCTL_SR_TRCR_RPT
SRTRMDF Mid-Term Deficiency Summary	Lists students that have deficient mid term grades for the term you specify. Reporting Tool: SQR	Curriculum Management > Grading > Mid-Term Deficiency Report	RUNCTL_SRTRMDFCNY
SRTRPRNT Advisement Report or Transcript report	Generates advisement reports for a transcript request, or all transcripts for a transcript request. The transcript type you specify at runtime determines which format the system uses (advisement or transcript). The advisement report is the degree audit report that reflects a student's progress towards graduation. This report is the core function of the Academic Advisement application. The transcript report reflects a student's course work, organized chronologically or by term. This report is used primarily by the Student Records application. Reporting Tool: SQR	Records and Enrollment > Transcripts > Batch Transcripts > Transcript Print	RUNCTL_SRTRPRINT
SRWORKLD Workload Copy and Recalc	Generates a report of part time and full time instructors that are over or under the allowed workload assignment. Reporting Tool: SQR	Curriculum Management > Roll Curriculum Data Forward > Copy/Update Workload Process	RUNCTL_WORKLD

Report ID and Report Name	Description	Navigation	Run Control Page
SRWORKLD Workload Copy and Update	Lists workload data for individuals who fall into one of six reporting categories. Reporting Tool: SQR	Curriculum Management > Roll Curriculum Data Forward > Update Classes w/Ctgl Changes	RUNCTL_WORKLD

