PeopleTools 8.62: Accessibility Guide

April 2025

This software and related documentation are provided under a license agreement containing restrictions on use and disclosure and are protected by intellectual property laws. Except as expressly permitted in your license agreement or allowed by law, you may not use, copy, reproduce, translate, broadcast, modify, license, transmit, distribute, exhibit, perform, publish, or display any part, in any form, or by any means. Reverse engineering, disassembly, or decompilation of this software, unless required by law for interoperability, is prohibited.

The information contained herein is subject to change without notice and is not warranted to be error-free. If you find any errors, please report them to us in writing.

If this is software, software documentation, data (as defined in the Federal Acquisition Regulation), or related documentation that is delivered to the U.S. Government or anyone licensing it on behalf of the U.S. Government, then the following notice is applicable:

U.S. GOVERNMENT END USERS: Oracle programs (including any operating system, integrated software, any programs embedded, installed, or activated on delivered hardware, and modifications of such programs) and Oracle computer documentation or other Oracle data delivered to or accessed by U.S. Government end users are "commercial computer software," "commercial computer software documentation," or "limited rights data" pursuant to the applicable Federal Acquisition Regulation and agency-specific supplemental regulations. As such, the use, reproduction, duplication, release, display, disclosure, modification, preparation of derivative works, and/or adaptation of i) Oracle programs (including any operating system, integrated software, any programs embedded, installed, or activated on delivered hardware, and modifications of such programs), ii) Oracle computer documentation and/or iii) other Oracle data, is subject to the rights and limitations specified in the license contained in the applicable contract. The terms governing the U.S. Government's use of Oracle cloud services are defined by the applicable contract for such services. No other rights are granted to the U.S. Government.

This software or hardware is developed for general use in a variety of information management applications. It is not developed or intended for use in any inherently dangerous applications, including applications that may create a risk of personal injury. If you use this software or hardware in dangerous applications, then you shall be responsible to take all appropriate fail-safe, backup, redundancy, and other measures to ensure its safe use. Oracle Corporation and its affiliates disclaim any liability for any damages caused by use of this software or hardware in dangerous applications.

Oracle®, Java, MySQL, and NetSuite are registered trademarks of Oracle and/or its affiliates. Other names may be trademarks of their respective owners.

Intel and Intel Inside are trademarks or registered trademarks of Intel Corporation. All SPARC trademarks are used under license and are trademarks or registered trademarks of SPARC International, Inc. AMD, Epyc, and the AMD logo are trademarks or registered trademarks of Advanced Micro Devices. UNIX is a registered trademark of The Open Group.

This software or hardware and documentation may provide access to or information about content, products, and services from third parties. Oracle Corporation and its affiliates are not responsible for and expressly disclaim all warranties of any kind with respect to third-party content, products, and services unless otherwise set forth in an applicable agreement between you and Oracle. Oracle Corporation and its affiliates will not be responsible for any loss, costs, or damages incurred due to your access to or use of third-party content, products, or services, except as set forth in an applicable agreement between you and Oracle.

Documentation Accessibility

For information about Oracle's commitment to accessibility, visit the Oracle Accessibility Program website at <https://docs.oracle.com/pls/topic/lookup?ctx=acc&id=docacc>.

Access to Oracle Support

Oracle customers that have purchased support have access to electronic support through My Oracle Support. For information, visit <https://docs.oracle.com/pls/topic/lookup?ctx=acc&id=info> or visit <https://docs.oracle.com/pls/topic/lookup?ctx=acc&id=trs> if you are hearing impaired.

Contents

Preface: Preface.....	v
Understanding the PeopleSoft Online Help and PeopleBooks.....	v
Hosted PeopleSoft Online Help.....	v
Locally Installed PeopleSoft Online Help.....	v
Downloadable PeopleBook PDF Files.....	v
Common Help Documentation.....	v
Field and Control Definitions.....	vi
Typographical Conventions.....	vi
ISO Country and Currency Codes.....	vii
Region and Industry Identifiers.....	vii
Translations and Embedded Help.....	viii
Using and Managing the PeopleSoft Online Help.....	viii
PeopleTools Related Links.....	viii
Contact Us.....	viii
Follow Us.....	ix
Chapter 1: Understanding Accessibility for PeopleSoft Applications.....	11
Accessibility Standards at Oracle.....	11
Accessibility in PeopleSoft Applications.....	11
Chapter 2: Setting Up PeopleSoft Accessibility Features.....	15
Setting System Defaults for Accessibility Personalizations.....	15
Enabling Accessibility Personalizations in Permission Lists.....	16
Setting Inactivity Timeout Intervals.....	17
Chapter 3: Using PeopleSoft Accessibility Features.....	19
Personalizing Your PeopleSoft Experience to Support Assistive Technology.....	19
Enabling Screen Reader Mode.....	19
Setting Your Personalizations.....	20
Navigating with the Keyboard.....	21
Using Keyboard Shortcuts.....	21
Using the Skip to Main Content Link.....	24
Using the Keyboard with the NavBar.....	25
Navigating Fluid Pop-up Menus Using Keyboard Shortcuts.....	27
Navigating Fluid Sectional Tabs Using Keyboard Shortcuts.....	28
Navigating Calendar Controls Using Keyboard Shortcuts.....	29
Navigating Charts Using Keyboard Shortcuts.....	30
Navigating Drop-Down Menus Using Keyboard Shortcuts.....	31
Navigating in the Rich Text Editor Using Shortcuts.....	33
Setting Navigation Personalizations.....	33
Working with the Fluid User Interface.....	34
Using the Accessibility Button in Fluid.....	34
Using the Define Accessibility Help Page.....	36
Migrating Accessibility Help.....	38
Chapter 4: Using PeopleTools to Build Accessible Applications.....	39
Determining User Accessibility Layout Mode Using PeopleCode.....	39
Enabling Users to Complete Tasks Using the Keyboard.....	39
Assigning Keyboard Shortcuts.....	39
Maintaining a Logical Tab Order.....	41

Maintaining the Focus.....	43
Setting Deferred Mode at the Page Control or Grid Level.....	44
Setting Deferred Mode at the Page Level.....	44
Setting Deferred Mode at the Component Level.....	44
Customizing Processing Notification Delay Time.....	44
Understanding Processing Notifications for Assistive Technology Users.....	45
Customizing Processing Notification Delay Time.....	45
Identifying Images and User Interface Elements.....	45
Creating Meaningful Label Text.....	46
Assigning Labels to User Interface Elements.....	47
Removing Labels from Decorative Images.....	48
Providing Text Equivalents for Charts and Graphs.....	49
Assigning Labels for Grid Columns and Rows.....	49
Assigning Titles and Summaries for Grids and Scroll Areas.....	50
Hiding Labels.....	51
Using Pop-Up Message Windows for Important Information.....	51
Using Images Consistently.....	51
Enabling Users to Override Contrast and Color Selections.....	52
Providing Alternatives to Color Coding to Convey Meaning.....	53
Providing Links to Skip Repetitive Navigation.....	54
Creating HTML That Is Not Generated by PeopleTools.....	55
Testing for Accessibility.....	56
Chapter 5: PeopleTools Accessibility Improvements by Release.....	59
PeopleTools 8.50 Accessibility Improvements.....	59
PeopleTools 8.51 Accessibility Improvements.....	62
PeopleTools 8.52 Accessibility Improvements.....	63
PeopleTools 8.53 Accessibility Improvements.....	64
PeopleTools 8.54 Accessibility Improvements.....	65
PeopleTools 8.55 Accessibility Improvements.....	68
PeopleTools 8.56 Accessibility Improvements.....	69
PeopleTools 8.57 Accessibility Improvements.....	69
PeopleTools 8.58 Accessibility Improvements.....	70
PeopleTools 8.59 Accessibility Improvements.....	70
PeopleTools 8.60 Accessibility Improvements.....	71
PeopleTools 8.61 Accessibility Improvements.....	72

Preface

Understanding the PeopleSoft Online Help and PeopleBooks

The PeopleSoft Online Help is a website that enables you to view all help content for PeopleSoft applications and PeopleTools. The help provides standard navigation and full-text searching, as well as context-sensitive online help for PeopleSoft users.

Hosted PeopleSoft Online Help

You can access the hosted PeopleSoft Online Help on the [Oracle Help Center](#). The hosted PeopleSoft Online Help is updated on a regular schedule, ensuring that you have access to the most current documentation. This reduces the need to view separate documentation posts for application maintenance on My Oracle Support. The hosted PeopleSoft Online Help is available in English only.

To configure the context-sensitive help for your PeopleSoft applications to use the Oracle Help Center, see [Configuring Context-Sensitive Help Using the Hosted Online Help Website](#).

Locally Installed PeopleSoft Online Help

If you're setting up an on-premises PeopleSoft environment, and your organization has firewall restrictions that prevent you from using the hosted PeopleSoft Online Help, you can install the online help locally. Installable PeopleSoft Online Help is made available with selected PeopleSoft Update Images and with PeopleTools releases for on-premises installations, through the [Oracle Software Delivery Cloud](#).

Your installation documentation includes a chapter with instructions for how to install the online help for your business environment, and the documentation zip file may contain a README.txt file with additional installation instructions. See *PeopleSoft 9.2 Application Installation* for your database platform, "Installing PeopleSoft Online Help."

To configure the context-sensitive help for your PeopleSoft applications to use a locally installed online help website, see [Configuring Context-Sensitive Help Using a Locally Installed Online Help Website](#).

Downloadable PeopleBook PDF Files

You can access downloadable PDF versions of the help content in the traditional PeopleBook format on the [Oracle Help Center](#). The content in the PeopleBook PDFs is the same as the content in the PeopleSoft Online Help, but it has a different structure and it does not include the interactive navigation features that are available in the online help.

Common Help Documentation

Common help documentation contains information that applies to multiple applications. The two main types of common help are:

- Application Fundamentals

- Using PeopleSoft Applications

Most product families provide a set of application fundamentals help topics that discuss essential information about the setup and design of your system. This information applies to many or all applications in the PeopleSoft product family. Whether you are implementing a single application, some combination of applications within the product family, or the entire product family, you should be familiar with the contents of the appropriate application fundamentals help. They provide the starting points for fundamental implementation tasks.

In addition, the *PeopleTools: Applications User's Guide* introduces you to the various elements of the PeopleSoft Pure Internet Architecture. It also explains how to use the navigational hierarchy, components, and pages to perform basic functions as you navigate through the system. While your application or implementation may differ, the topics in this user's guide provide general information about using PeopleSoft applications.

Field and Control Definitions

PeopleSoft documentation includes definitions for most fields and controls that appear on application pages. These definitions describe how to use a field or control, where populated values come from, the effects of selecting certain values, and so on. If a field or control is not defined, then it either requires no additional explanation or is documented in a common elements section earlier in the documentation. For example, the Date field rarely requires additional explanation and may not be defined in the documentation for some pages.

Typographical Conventions

The following table describes the typographical conventions that are used in the online help.

<i>Typographical Convention</i>	<i>Description</i>
Key+Key	Indicates a key combination action. For example, a plus sign (+) between keys means that you must hold down the first key while you press the second key. For Alt+W , hold down the Alt key while you press the W key.
... (ellipses)	Indicate that the preceding item or series can be repeated any number of times in PeopleCode syntax.
{ } (curly braces)	Indicate a choice between two options in PeopleCode syntax. Options are separated by a pipe ().
[] (square brackets)	Indicate optional items in PeopleCode syntax.
& (ampersand)	When placed before a parameter in PeopleCode syntax, an ampersand indicates that the parameter is an already instantiated object. Ampersands also precede all PeopleCode variables.

Typographical Convention	Description
⇒	This continuation character has been inserted at the end of a line of code that has been wrapped at the page margin. The code should be viewed or entered as a single, continuous line of code without the continuation character.

ISO Country and Currency Codes

PeopleSoft Online Help topics use International Organization for Standardization (ISO) country and currency codes to identify country-specific information and monetary amounts.

ISO country codes may appear as country identifiers, and ISO currency codes may appear as currency identifiers in your PeopleSoft documentation. Reference to an ISO country code in your documentation does not imply that your application includes every ISO country code. The following example is a country-specific heading: "(FRA) Hiring an Employee."

The PeopleSoft Currency Code table (CURRENCY_CD_TBL) contains sample currency code data. The Currency Code table is based on ISO Standard 4217, "Codes for the representation of currencies," and also relies on ISO country codes in the Country table (COUNTRY_TBL). The navigation to the pages where you maintain currency code and country information depends on which PeopleSoft applications you are using. To access the pages for maintaining the Currency Code and Country tables, consult the online help for your applications for more information.

Region and Industry Identifiers

Information that applies only to a specific region or industry is preceded by a standard identifier in parentheses. This identifier typically appears at the beginning of a section heading, but it may also appear at the beginning of a note or other text.

Example of a region-specific heading: "(Latin America) Setting Up Depreciation"

Region Identifiers

Regions are identified by the region name. The following region identifiers may appear in the PeopleSoft Online Help:

- Asia Pacific
- Europe
- Latin America
- North America

Industry Identifiers

Industries are identified by the industry name or by an abbreviation for that industry. The following industry identifiers may appear in the PeopleSoft Online Help:

- USF (U.S. Federal)

- E&G (Education and Government)

Translations and Embedded Help

PeopleSoft 9.2 software applications include translated embedded help. With the 9.2 release, PeopleSoft aligns with the other Oracle applications by focusing our translation efforts on embedded help. We are not planning to translate our traditional online help and PeopleBooks documentation. Instead we offer very direct translated help at crucial spots within our application through our embedded help widgets. Additionally, we have a one-to-one mapping of application and help translations, meaning that the software and embedded help translation footprint is identical—something we were never able to accomplish in the past.

Using and Managing the PeopleSoft Online Help

Select About This Help in the left navigation panel on any page in the PeopleSoft Online Help to see information on the following topics:

- Using the PeopleSoft Online Help.
- Managing hosted Online Help.
- Managing locally installed PeopleSoft Online Help.

PeopleTools Related Links

[PeopleTools 8.62 Home Page](#)

[PeopleSoft Search and Insights Home Page](#)

“PeopleTools Product/Feature PeopleBook Index” (Getting Started with PeopleTools)

[PeopleSoft Online Help](#)

[PeopleSoft Information Portal](#)

[PeopleSoft Spotlight Series](#)

[PeopleSoft Training and Certification | Oracle University](#)

[My Oracle Support](#)

[Oracle Help Center](#)

Contact Us

Send your suggestions to psoft-infodev_us@oracle.com.

Please include the applications update image or PeopleTools release that you’re using.

Follow Us

<i>Icon</i>	<i>Link</i>
	<u>Watch PeopleSoft on YouTube</u>
	<u>Follow @PeopleSoft_Info on X.</u>
	<u>Read PeopleSoft Blogs</u>
	<u>Connect with PeopleSoft on LinkedIn</u>

Understanding Accessibility for PeopleSoft Applications

Accessibility Standards at Oracle

For information about Oracle's commitment to accessibility, visit the Oracle Accessibility Program website at <http://www.oracle.com/us/corporate/accessibility/index.html>.

Accessibility in PeopleSoft Applications

PeopleTools provides the underlying technology for PeopleSoft applications. All PeopleSoft applications, such as Human Capital Management and Customer Relationship Management, are built, deployed, and maintained using PeopleTools. PeopleTools is designed to generate HTML content that is coded to standards to work with assistive technology. This HTML content includes several features to help people who use assistive technology, such as screen readers. PeopleSoft accessibility layout features include:

- Alternate text for images, buttons, collapsible section icons, and hide and expand grid tabs.
- Table summaries and row and column headings for tables.
- The ability to add links and anchors that enable keyboard-only users to bypass repeated navigation content, such as page tabs.
- A feature that presents the elements on the body of a page in a linear format (recommended for people who are blind or visually impaired who use assistive technology, such as screen readers).
- Landmarks that identify page sections.

These landmarks provide a method to programmatically identify web page sections in a consistent way, which enables assistive technologies to provide users with features they can use to identify and navigate to sections of page content.

To ensure that these accessibility layout features are available:

- If developers customize applications, they must build them according to the accessibility design standards.

Starting with PeopleTools 8.50 and PeopleSoft 9.1, delivered pages have been audited to ensure that they include accessibility layout features, such as page control labels and grid summaries. However, if developers change or add pages, they must ensure that their changes are coded to standards to work with assistive technology. PeopleTools provides many accessibility layout features, but they are not all automatic. For example, PeopleTools provides the ability to add page control labels, but it does not automatically create the labels. Developers must manually add labels and set other accessibility layout features so that they are available to users who enable the accessibility layout.

Note: It's important to incorporate accessibility from the beginning, when you are designing your customizations. This documentation provides details that are specific to PeopleTools and PeopleSoft applications, but you should also consult the numerous accessibility resources that are available outside of Oracle to create a complete accessibility plan. In addition, it's important to involve users with various disabilities throughout your process, beginning in the design phase.

- System administrators must grant access to the Accessibility Layout option in PeopleTools.

Accessibility layout features are not enabled by default. System administrators must, at a minimum, enable the accessibility layout features for each permission list.

- Users who use assistive technology should enable the Screen Reader mode from the Accessibility Layout drop-down list on the My Personalizations - General Settings page.

For more information, see [Personalizing Your PeopleSoft Experience to Support Assistive Technology](#).

Note: Keyboard-only navigation features are available to all users and do not require users to enable accessibility layout features.

This accessibility guide provides details about how to develop, set up, and use the accessibility layout features in PeopleSoft applications.

Examples

The following example shows a typical transaction page that contains fields, buttons, scroll areas, and a grid:

Example of a typical transaction page.

Biographical Details
Contact Information
Regional

Susan Jones
Person ID 0002

Name
Q | < > 1 of 1 | View All

Effective Date 01/01/2000

Format Type English

Formal Name Susan Jones

Display Name Susan Jones

+ -
View Name

Biographic Information

Date of Birth 📅

Date of Death 📅

Birth Country 🔍 United States

Birth State 🔍

Birth Location Waive Data Protection

Years 60 Months 4

Biographical History
Q | < > 1 of 1 | View All

*Effective Date 📅

*Gender ▼

*Highest Education Level ▼

*Marital Status ▼

Language Code ▼

Alternate ID

Full-Time Student

As of 📅

+ -

National ID

📄 Q
< > 1-1 of 1 | View All

*Country	*National ID Type	National ID	Primary ID	
<input type="text" value="USA"/> 🔍	<input type="text" value="Social Security Number"/> ▼	<input type="text" value="██████████"/>	<input checked="" type="checkbox"/>	+ -

The following example shows how the same page appears when users have set the Accessibility Layout option to Screen Reader On:

Example of a page with Screen Reader On enabled.

Biographical Details
Contact Information
Regional

Susan Jones Person ID 0002

Name

View All

Effective Date 01/01/2000

Format Type English

Formal Name Susan Jones View Name Display Name Susan Jones

Biographic Information

Date of Birth 04/06/1964 Years 60 Months 4

Date of Death Birth Country USA United States

Birth State

Birth Location Waive Data Protection

Biographical History

View All

Effective Date 01/01/2000 *Gender Female

*Highest Education Level A-Not Indicated

*Marital Status Married As of 01/01/2000

Language Code

Alternate ID Full-Time Student

National ID

View All

*Country	*National ID Type	National ID	Primary ID	Add row	Delete row
USA <input type="text"/>	Social Security Number <input type="text"/>	<input type="text"/>	<input checked="" type="checkbox"/>	+	-

Notice that in the preceding example the controls in the scroll areas have been moved to appear inline with the other fields, and the Add row and Delete row columns in the grid have column headings (unlike the example of the standard page, which does not include headings for those columns). Because the purpose of this mode is to facilitate the use of assistive technologies, such as screen readers, the page layout may be quite different from how pages appear when the **Accessibility Layout** option is set to *Screen Reader Off*.

Pagelet Behavior in Screen Reader On Mode

When you interact with a portal pagelet when the **Accessibility Layout** option is set to *Screen Reader On*, the pagelet expands to a full-sized page. Use the Home link to return to the homepage.

Chapter 2

Setting Up PeopleSoft Accessibility Features

Setting System Defaults for Accessibility Personalizations

When you install PeopleTools, accessibility features to support assistive technology are available to all users, but they are turned off by default. Users who want to use these features must enable them, individually, in My Preferences. You can change the system default value for each of the accessibility personalizations to suit your user community. For example, if the majority of your users use assistive technology, you might make these features available to everyone by default so that individual users do not have to enable them.

Note: Keyboard-only navigation features are available to all users and do not require users to enable accessibility layout features.

To change the default value of accessibility personalizations:

1. Select **PeopleTools > Personalization > Define System Personalizations** to access the Define Personalizations page.
2. Search and select *PPTL* to open the PeopleTools personalization options.

Two accessibility personalizations appear near the top of the list:

- ACCESSMENU – Screen Reader in Actions Menu (Enable Screen Reader Mode link).
- ACCESS – Accessibility Layout (screen reader mode).

3. Select the **Format** tab.

The current default values appear in the Option Default Value column.

4. To change a default value, click the **Set Option Default Value** link for a personalization option.
5. For the ACCESSMENU – Screen Reader in Actions Menu option, select one of the following values:

<i>Field or Control</i>	<i>Description</i>
<i>No</i>	Select this value to hide the Enable Screen Reader Mode link in the Actions menu for all users. Users who want to see this link can enable it in My Personalizations.

Field or Control	Description
<i>Yes</i>	Select this value to display the Enable Screen Reader Mode link in the Actions menu for all users. Users who do not want to see this link can disable it in My Personalizations.

- For the ACCESS – Accessibility Layout option, do not change the default value for the screen reader mode unless all of your user community requires it.
- Click **OK** to apply the change and return to the Define Personalizations page.
- Click **Save**.

Related Links

“Defining System Personalization Options” (Security Administration)

Enabling Accessibility Personalizations in Permission Lists

In order for users to see and modify a personalization option in My Preferences, you must explicitly grant users permission to each option, including accessibility personalization options, on the Personalizations page of a permission list.

To enable accessibility personalizations on a permission list:

- Select **PeopleTools > Security > Permissions and Roles > Permission Lists**.
- Add or select a permission list.
- Select the **Personalizations** page to access the personalization permissions.
- Enter the following information:

Field or Control	Description
Option Category Level	Select <i>Tools</i> .
Option Category Group	Select <i>PS Internet Architecture</i> .

- Click the **Edit Options** link to open the Personalization Permissions page.
- Select the **Allow User Option** check box next to each accessibility personalization that you want to enable for users with this permission list:
 - ACCESS – Accessibility Layout (screen reader mode).
 - ACCESSMENU – Screen Reader in Actions Menu (Enable Screen Reader Mode link).

Note: If a user has been assigned the DisableScreenReaderInActions role, then this link is never displayed. For those users, hide this personalization since it will have no effect.

7. Click OK to apply the change and return to the Personalizations page.
8. Click Save.

Related Links

“Setting Personalization Permissions” (Security Administration)

Setting Inactivity Timeout Intervals

This section explains how to set up PeopleTools security to help satisfy the following WCAG 2.0 standard:

WCAG 2.0 2.2.1 - Timing Adjustable: For each time limit that is set by the content,⇒
at least one of the following is true: Turn off, Adjust, Extend, Real-time Excepti⇒
on, Essential Exception, or 20 Hour Exception.

PeopleTools security enables you to specify the timeout intervals for users who are signed in to the PeopleSoft system. A timeout interval specifies how long the user’s machine can remain idle—no keystrokes, no SQL—before the PeopleSoft system automatically signs the user out of the application. You assign the timeout intervals to permission lists using PeopleTools Security. The default value is to never time out.

If you do set a timeout interval, users who approach the timeout interval receive a message that enables them to extend the timeout interval or allow the timeout to occur.

To change the timeout interval:

1. Select **PeopleTools > Security > Permissions and Roles > Permission Lists**.
Select the **General** page.
2. Select one of the following timeout options:

<i>Field or Control</i>	<i>Description</i>
Never Time-out	Select this option to eliminate a timeout interval. This value is the default.

Field or Control	Description
Specific Time-out (minutes)	<p>Select this option to assign a timeout interval and enter the appropriate value in minutes. The value:</p> <ul style="list-style-type: none"> • Must be a positive integer. • Cannot contain edit characters, such as commas or a \$. • Must be a SMALLINT in the valid range allowed for this field (0–32767). <p>Entering a value of zero is equivalent to selecting Never Time-Out.</p> <hr/> <p>Note: If you generally provide users with shorter timeout intervals, such as 20 minutes, you might want to create a special accessibility permission list with a longer timeout interval, such as 60 minutes.</p> <hr/> <p>Note: Because timeout intervals are also controlled at the web server level, you need to change the web server timeout values.</p> <hr/>

Important! Other timeout intervals that are unrelated to security are controlled by your web server and by PeopleSoft Pure Internet Architecture components.

Related Links

“Setting General Permissions” (Security Administration)

“Web Server Timeouts” (System and Server Administration)

Chapter 3

Using PeopleSoft Accessibility Features

Personalizing Your PeopleSoft Experience to Support Assistive Technology

Enabling Screen Reader Mode

When you use a PeopleSoft system, you can enable screen reader mode so that PeopleSoft pages are rendered in a manner that supports assistive technologies such as screen readers. You can enable screen reader mode:

- Temporarily for the current session only.

Note: When screen reader mode is enabled temporarily, it can be disabled only by signing out and signing back in.

To enable screen reader mode for the current session only:

- Select the Enable Screen Reader Mode check box on the PeopleSoft signon page.
- Select the Enable Screen Reader Mode link in the Actions menu. If you are prompted to retain this setting for subsequent sessions, click No.
- Select the Enable Screen Reader mode menu item from the Accessibility button. The Accessibility button is available in the quick access bar on the fluid banner. If you are prompted to retain this setting for subsequent sessions, click No.

Note: On small form factor devices, the Accessibility button is available only on the homepage in the quick access bar.

See [Using the Accessibility Button in Fluid](#).

- For the current session and any subsequent sessions. (If you do not have permission to update personalizations, then you also do not have the ability to turn screen reader mode on for subsequent sessions.)

Note: When screen reader mode is enabled for the current session and subsequent sessions, it can be disabled only by changing by the accessibility layout option in My Preferences.

To enable screen reader mode for the current session and subsequent sessions:

- Select Screen reader mode on as the accessibility layout option in My Preferences.
- Select the Enable Screen Reader Mode link in the Actions menu. When prompted, click Yes to turn on screen reader mode for subsequent sessions.

- Select the Enable Screen Reader mode menu item from the Accessibility button. The Accessibility button is available in the quick access bar on the fluid banner. If you are prompted to retain this setting for subsequent sessions, click Yes.

Note: On small form factor devices, the Accessibility button is available only on the homepage in the quick access bar.

See [Using the Accessibility Button in Fluid](#).

After you change the setting for screen reader mode (either enabling it or disabling it), a confirmation page is displayed where the new setting is in effect. Click the Back button to return to the previous context retaining the new screen reader setting.

Note that when the Enable Screen Reader Mode link has been enabled by the system administrator using the personalization infrastructure, it is available under My Preferences on fluid homepages and fluid pages only. While this link is available in most fluid applications, it is not displayed:

- When screen reader mode is already in effect.
- In fluid activity guides, fluid navigation collections, and in My Preferences.
- When you have been assigned the DisableScreenReaderInActions role.
- On classic pages and homepages.

Note: The Enable Screen Reader Mode link under the Accessibility button ignores this setting and is always available.

Note: Keyboard-only navigation features are available to all users and do not require users to enable accessibility features.

Related Links

[Navigating with the Keyboard](#)

Setting Your Personalizations

Use My Preferences to set personalizations to support your use of assistive technologies.

1. Select **My Preferences** from the Actions menu.
2. On the General Settings page, in the **General Options** section.
3. Select one of the following options for **Accessibility Layout**:

<i>Field or Control</i>	<i>Description</i>
<i>Screen reader mode off</i>	Select this option to disable screen reader mode for the current session and subsequent sessions.

Field or Control	Description
<i>Screen reader mode on</i>	Select this option to enable screen reader mode for the current session and subsequent sessions.

Note: After you select to persist screen reader mode or to disable the persistence of screen reader mode, a confirmation page is displayed that then transfers you back to the current context so that your changes are now in effect.

4. Select one of the options for **Screen Reader in Actions Menu**:

Field or Control	Description
<i>Yes</i>	<p>Display the Enable Screen Reader Mode link in the Actions menu.</p> <hr/> <p>Note: This link is available on fluid homepages and fluid pages only. However, while this link is available in fluid applications, it is not displayed in fluid activity guides, fluid navigation collections, and in My Preferences.</p> <hr/>
<i>No</i>	Do not display the Enable Screen Reader Mode link in the Actions menu.

5. Save your changes.

Note: If you changed the screen reader mode, a confirmation page is displayed.

Related Links

“Specifying General Settings in My Preferences” (Applications User’s Guide)

Navigating with the Keyboard

This section provides an overview of keyboard shortcuts and describes how to navigate using the keyboard.

Using Keyboard Shortcuts

Working in a browser-based environment can often be mouse intensive. However, PeopleSoft applications offer keyboard navigation alternatives to using a mouse. To view a printable list of all keyboard shortcuts while using a PeopleSoft application, press **Alt + K (Ctrl + K on a Mac)**. The key sequences displayed are appropriate for the browser that you are currently signed on with. If you sign on with a different browser (for example, Safari instead of Firefox), then different key sequences may apply.

Note: Certain PeopleSoft hot keys do not work as expected on alternate, non-U.S. keyboard layouts. For example, **Alt + ' , Alt + \ , and Alt + /** do not produce the expected results on the AZERTY keyboard. This occurs because some keys on non-U.S. keyboards produce different key codes than the same key on a U.S. keyboard (also known as a QWERTY keyboard).

See “PeopleSoft Hot Keys Do Not Function As Expected on a non-U.S. Keyboard” (Global Technology) for a solution to this problem.

The following table lists the keyboard shortcuts available in a PeopleSoft system. The key sequences can differ depending on the desktop operating system and sometimes the browser. Some shortcuts are designated as valid in a classic context only while others are designated as valid in a fluid context only. In addition, when a second or third shortcut is listed, it is alternative to the primary shortcut, which may not work in all circumstances.

Shortcut (Windows)	Shortcut (macOS)	Result	Classic	Fluid
<ul style="list-style-type: none"> • Alt + 1 • Alt + Shift + 1 (fluid, Firefox only) 	<ul style="list-style-type: none"> • Ctrl + Shift + 1 (classic) • Ctrl + Alt + 1 (fluid) 	<p>For classic components, executes a specific button depending on the page type:</p> <ul style="list-style-type: none"> • When the toolbar is present at the bottom of a standard page, invokes the Save button. • On a secondary page, invokes the OK button. • On a component search page, invokes the Search or Add button. • On a prompt page, invokes the Search (or Lookup) button. <p>For fluid components, executes a specific button depending on the page type:</p> <ul style="list-style-type: none"> • On a standard page, invokes the Save button if the button was generated by PeopleTools. • In a modal window, invokes the Done button in the header of the modal window. • On a component search page, invokes the Search button. • On a prompt page, invokes the Search button. 	Y	Y
Alt + 2	Ctrl + Shift + 2	Returns to the search page from a transaction page.	Y	N
Alt + 3	Ctrl + Shift + 3	Views the next row in the list when the Next in List button is active.	Y	N
Alt + 4	Ctrl + Shift + 4	Views the previous row in the list when the Previous in List button is active.	Y	N

Shortcut (Windows)	Shortcut (macOS)	Result	Classic	Fluid
Alt + 5	Ctrl + Shift + 5	Executes an action depending on the context: <ul style="list-style-type: none"> • Opens the lookup page from a prompt field. • Opens the calendar prompt from a date field. 	Y	Y
Alt + 6	Ctrl + Shift + 6	Opens a pop-up window to show other links or activates the link when there is only one link.	Y	N
Alt + 7	Ctrl + Shift + 7	Inserts a row in a grid or scroll area.	Y	Y
Alt + 8	Ctrl + Shift + 8	Deletes the current row in a grid or scroll area.	Y	Y
Alt + 9	Ctrl + Shift + 9	Takes you to the first link in the pagebar at the top of the page	Y	N
Alt + 0	Ctrl + Shift + 0	Refreshes the page by invoking the Refresh button on the toolbar.	Y	N
Alt + .	Ctrl + Shift + 0	Displays the next set of rows in a grid or scroll area.	Y	N
Alt + ,	Ctrl + Shift + ,	Displays the previous set of rows in a grid or scroll area.	Y	N
Alt + /	Ctrl + Shift + /	Finds data in a grid or scroll area when the cursor is within the grid or scroll area page control.	Y	Y
Alt + ‘	Ctrl + Shift + ‘	Views all rows of data in a grid, scroll area, or search page results list.	Y	N
Alt + \	Ctrl + Shift + \	Depending on the context, performs a different action: <ul style="list-style-type: none"> • On a standard page, takes you to the first button in the toolbar at the bottom of the page. • On a component search page, toggles between the Find an Existing Value and the Add a New Value tabs. 	Y	N
Alt + ;	Ctrl + Shift + ;	Displays the related action's page field context menu.	Y	Y
<ul style="list-style-type: none"> • Alt + J • Ctrl + J • Ctrl + Shift + J 	<ul style="list-style-type: none"> • Ctrl + Shift+ J • Ctrl + J 	Displays the system information page if it is configured by an administrator to be displayed. See “Using the System Information Page” (Applications User’s Guide).	Y	Y

Shortcut (Windows)	Shortcut (macOS)	Result	Classic	Fluid
<ul style="list-style-type: none"> • Alt + K • Ctrl + Alt + K 	Ctrl + K	Displays the keyboard shortcuts information page.	Y	Y
Ctrl + M	Ctrl + M	Activates drag mode for the selected object.	N	Y
Ctrl + Alt + M	Ctrl + Alt + M	Places (drops) an object that was moved in drag mode.	N	Y
Ctrl + Alt + P	Ctrl + Alt + P	<ul style="list-style-type: none"> • When screen reader mode is not enabled, opens a mouse over pop-up page for a field (if configured for that field). Hit the Esc key to close this page. • When screen reader mode is enabled, you can continue to use the information (i) icon to open the pop-up page. 	Y	N
Ctrl + Alt + S	Ctrl + Alt + S	<p>Displays the Skip to Main Content link and sets focus on the link.</p> <p>See Using the Skip to Main Content Link for more information.</p>	Y	Y
Enter	Enter	<p>In certain circumstances, the Enter key has been given these additional behaviors:</p> <ul style="list-style-type: none"> • When a modal window is displayed, invokes the OK (or Done) button. • When a component search page is displayed, invokes the Search or Add button. • When a prompt page is displayed, invokes the Lookup (or Search) button. 	Y	Y
Esc	Esc	Activates the Cancel button if it is displayed.	Y	Y

Using the Skip to Main Content Link

The Skip to Main Content link allows keyboard-only users to bypass all the header links and get to the main content on the page.

When you tab from the browser header area into a PeopleSoft page (non-modal pages only), the Skip to Main Content link is displayed automatically. Also, when you are on any control within any PeopleSoft page, you can use **Ctrl + Alt + S** to display the Skip to Main Content link. Then, press Enter to dismiss the link and place focus on the first actionable field within the main content of the PeopleSoft page.

Note: For fluid pages, focus is first placed on the main fluid page container, which is itself not actionable. Then, press Tab once to place focus on the first actionable field within the main content of the page. Pressing tab on the skip to main content link, closes the pop-up menu and places you on the first button on the banner.

Using the Keyboard with the NavBar

The NavBar (navigation bar) is a control that provides quick access to tiles, folders, and pages in your PeopleSoft system. The NavBar contains tiles on the left that, when clicked, display a list of associated items on the right. The list items can be folders, links, or other objects. Users can use the list of items to access a page.

This example illustrates the appearance of the three sections of the NavBar: the NavBar header, the tile list on the left, and the content area on the right.

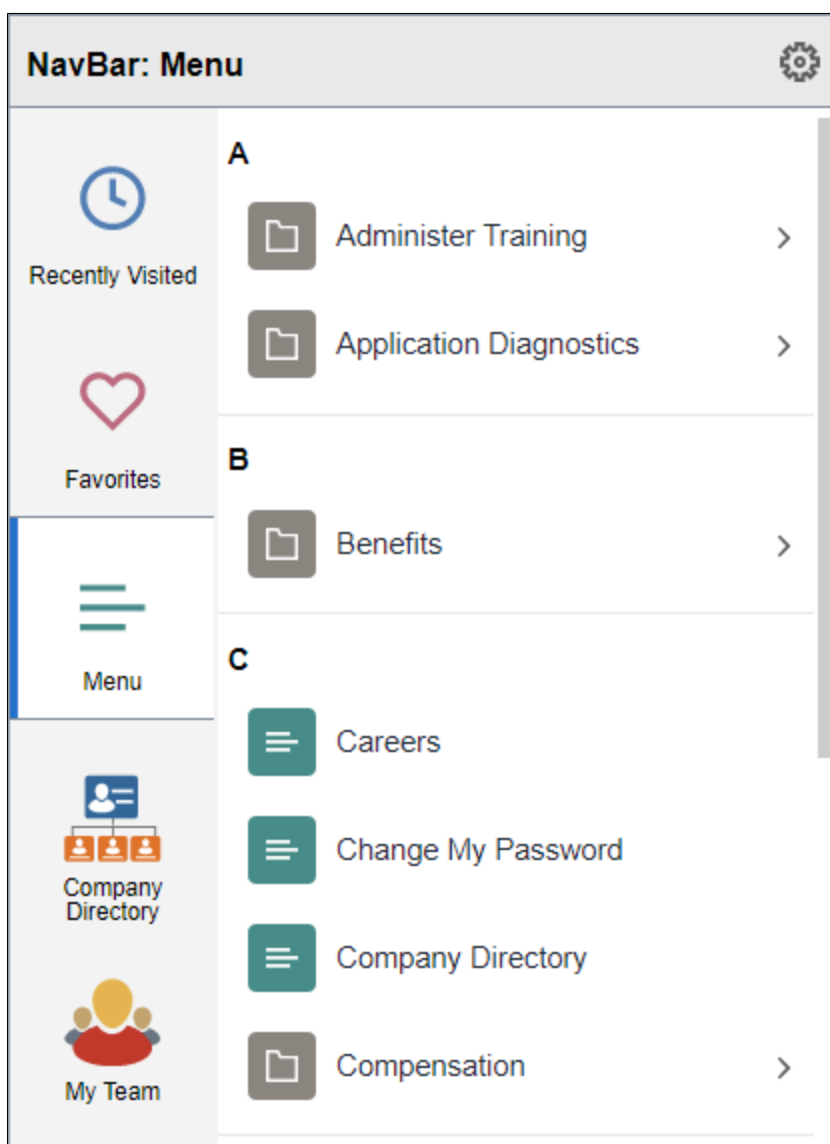

You can use the following keyboard shortcuts within the NavBar:

Key or Key Combination	Result
Tab	<p>Moves focus forward through the three sections of the NavBar: the NavBar header, the tile list on the left, and the content area on the right.</p> <hr/> <p>Note: When the NavBar is first opened, the content area on the right is not displayed.</p> <hr/>
Shift + Tab	<p>Moves focus backward through the three sections of the NavBar: the NavBar header, the tile list on the left, and the content area on the right.</p> <hr/> <p>Note: When the NavBar is first opened, the content area on the right is not displayed.</p> <hr/>
Down Arrow	<p>When focus is on either the tile list or the content area, moves focus to the next item.</p>
Up Arrow	<p>When focus is on either the tile list or the content area, moves focus to the previous item.</p>
Enter	<ul style="list-style-type: none"> • When focus is on a tile, toggles the content area open or closed. <p>When the content area is opened to display new content, focus is moved to the first item in the list.</p> <ul style="list-style-type: none"> • When focus is on an item in the content area, opens the content associated with that item—for example, a menu folder or a menu item. • When the menu is displayed in alphabetical order and when focus is on an alphabetical section divider such as the letter B, selects the alphabetical section divider. <hr/> <p>Note: When an alphabetical section divider is selected in this manner, it remains selected throughout the time the menu remains open in the content area of the NavBar. Then, when you tab out and tab back into the content area again, this section divider is selected rather than the first one in the list. If you close the menu or select a different NavBar tile, this selection is discarded.</p> <hr/>
Right Arrow	<ul style="list-style-type: none"> • When focus is on a menu folder, opens the menu folder. • Only when the menu is displayed in alphabetical order and focus is on an alphabetical section divider, moves focus to the first item in that section.

Key or Key Combination	Result
Left Arrow	<ul style="list-style-type: none"> When focus is on a menu item or menu folder, moves focus backward to the parent menu folder. Only when the menu is displayed in alphabetical order and focus is on an item beneath an alphabetical section divider, moves focus back to the alphabetical section divider.

Navigating Fluid Pop-up Menus Using Keyboard Shortcuts

You can use keyboard shortcuts to navigate items of a fluid pop-up menu.

The Actions menu is an example of a fluid pop-up menu:

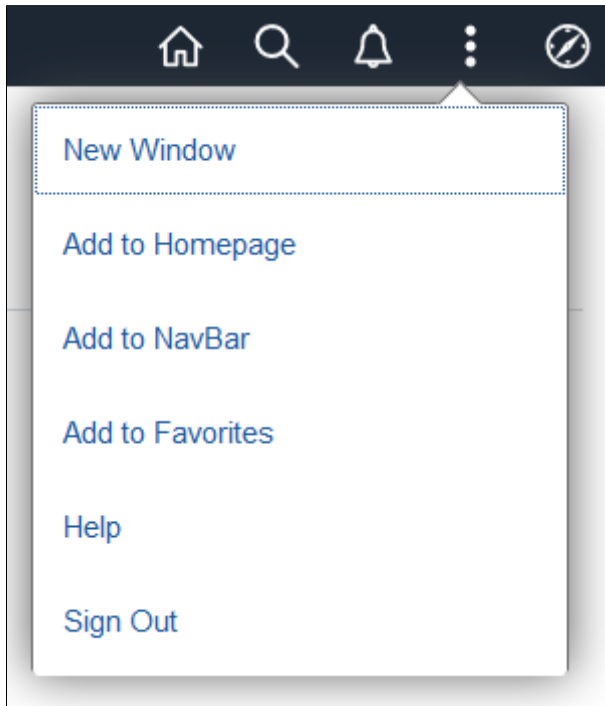

This table lists the key or key combinations that you use to navigate fluid pop-up menus:

Key or Key Combination	Result
Enter	<ul style="list-style-type: none"> When focus is on the menu button, opens the menu and moves focus to the first menu item in the list. When focus is on a menu item, performs the action of that item (for example, accessing a new component) and closes the menu.
Down Arrow	When focus is on a menu item, moves focus to the next item, optionally wrapping from the last to the first.

Key or Key Combination	Result
Up Arrow	When focus is on a menu item, moves focus to the previous item, optionally wrapping from the first to the last.
Esc	Closes the pop-up menu and returns focus to the item or context from which the menu was opened—for example, the menu button or parent menu item.
Tab	Closes the pop-up menu and moves focus to the next item in the tab sequence.
Shift + Tab	Closes the pop-up menu and moves focus to the previous item in the tab sequence.

Related Links

“Creating Fluid Pop-up Menus” (Fluid User Interface Developer’s Guide)

Navigating Fluid Sectional Tabs Using Keyboard Shortcuts

You can use keyboard shortcuts to navigate items within a collection of fluid sectional tabs.

The following example illustrates fluid sectional tabs in a horizontal layout:



This table lists the key or key combinations that you use to navigate fluid sectional tabs and the results of using those keys:

Key or Key Combination	Result
Tab	<ul style="list-style-type: none"> • When focus moves to the tab set, places focus on the first tab. • When focus is on the tab set, moves focus out of the tab set and onto the next focusable item on the page.
Shift + Tab	<ul style="list-style-type: none"> • When focus moves to the tab set, places focus on the first tab. • When focus is on the tab set, moves focus out of the tab set and onto the previous focusable item on the page.

Key or Key Combination	Result
<ul style="list-style-type: none"> • Right Arrow • Down Arrow 	Moves focus to the next tab. If focus is on the last tab, moves focus to the first tab.
<ul style="list-style-type: none"> • Left Arrow • Up Arrow 	Moves focus to the previous tab. If focus is on the first tab, moves focus to the last tab.
<ul style="list-style-type: none"> • Enter • Space 	Activates the tab.

Related Links

“Creating Sectional Tabs on a Page” (Fluid User Interface Developer’s Guide)

Navigating Calendar Controls Using Keyboard Shortcuts

This table lists the key or key combinations that you use to navigate through calendar controls and the results of using those keys:

Note: Screen reader users, use the table command to change the date.

Key or Key Combination	Result
Tab	Moves focus to the next object within the calendar control. When you initially open a calendar control, the focus is on the current date link.
Enter	Selects the current item. In the Date table, pressing Enter on a date selects that date and closes the calendar control. On the Current Date link, pressing Enter selects the current date and closes the calendar control.
Esc	Closes the calendar without any action.
Down Arrow	Moves to the same day of the week in the next week.
Up Arrow	Moves to the same day of the week in the previous week.
Right Arrow	Moves to the next day.

Key or Key Combination	Result
Left Arrow	Moves to the previous day.

Navigating Charts Using Keyboard Shortcuts

This table lists the key or key combinations that you use to navigate through charts and the results of using those keys:

Note: These keyboard shortcuts apply to charts beginning with PeopleTools release 8.55. Charts from previous releases, and some specific charts do not support these keyboard shortcuts.

Key or Key Combination	Result
Tab	Moves focus to next component.
Shift + Tab	Moves focus to the previous component.
Up Arrow	Moves focus and selection to previous data item.
Down Arrow	Moves focus and selection to next data item.
Left Arrow	Moves focus and selection to previous data item (on left).
Right Arrow	Moves focus and selection to next data item (on right).
Shift + Up Arrow	Moves focus and multi-selects previous data item.
Shift + Down Arrow	Moves focus and multi-selects next data item.
Shift + Left Arrow	Moves focus and multi-selects previous data item (on left).
Shift + Right Arrow	Moves focus and multi-selects next data item (on right).
Ctrl + Up Arrow	Moves focus to previous data item, without changing the current selection.
Ctrl + Down Arrow	Moves focus to next data item, without changing the current selection.
Ctrl + Left Arrow	Moves focus to previous data item (on left), without changing the current selection.

Key or Key Combination	Result
Ctrl + Right Arrow	Moves focus to next data item (on right), without changing the current selection.
Ctrl + Spacebar	Multi-selects data item with focus.
= or +	Zooms in one level if zooming is enabled.
- or _	Zooms out one level if zooming is enabled.
Page Up	Pans up if scrolling is enabled.
Page Down	Pans down if scrolling is enabled.
Shift + Page Up	Pans left in left-to-right locales. Pans right in right-to-left locales.
Shift + Page Down	Pans right in left-to-right locales. Pans left in right-to-left locales.

Navigating Drop-Down Menus Using Keyboard Shortcuts

Important! Drop-down menus and other forms of classic navigation are no longer supported. The information in this topic pertains to a prior version of PeopleSoft classic applications only. The default navigational interface for PeopleSoft applications in the current release is based on the fluid banner, which can be used for both classic and fluid applications. For information on using the keyboard to navigate within the fluid user interface, see [Using the Keyboard with the NavBar](#).

This table lists the key or key combinations that you use to navigate the drop-down menu structure and the results of using those keys:

Key or Key Combination	Result
Ctrl + Y	Expands the Main Menu.
Alt + Z	If the search field is configured to appear in the Main Menu, expands the Main Menu and moves the cursor to a search field.
Tab	If the search field is configured to appear in the Main Menu, press Tab to move past the search field and sort icons to access the menu items.

Key or Key Combination	Result
Up Arrow	Varies based on context: <ul style="list-style-type: none"> • In an expanded menu, moves one item upward through a list of folders and content references. • When moving through the navigation path, collapses a drop-down menu item.
Down Arrow	Varies based on context: <ul style="list-style-type: none"> • In an expanded menu, moves one item downward through a list of folders and content references. • When moving through the navigation path, expands a drop-down menu item.
Right Arrow <hr/> Note: This functionality applies only to languages read from left to right.	Varies based on context: <ul style="list-style-type: none"> • In an expanded menu, opens a folder to the right so that subfolders or content references appear. • When moving through the navigation path, accesses the next menu item to the right.
Right Arrow <hr/> Note: This functionality applies only to languages read from right to left.	Varies based on context: <ul style="list-style-type: none"> • In an expanded menu, closes the current folder and sets the focus on its parent folder. • When moving through the navigation path, accesses the next menu item to the right.
Left Arrow <hr/> Note: This functionality applies only to languages read from left to right.	Varies based on context: <ul style="list-style-type: none"> • In an expanded menu, closes the current folder and sets the focus on its parent folder. • When moving through the navigation path, accesses the next menu item to the left.
Left Arrow <hr/> Note: This functionality applies only to languages read from right to left.	Varies based on context: <ul style="list-style-type: none"> • In an expanded menu, opens a folder to the right so that subfolders or content references appear. • When moving through the navigation path, accesses the next menu item to the left.
Esc	Closes all open menu items. Collapses all expanded menus.

Navigating in the Rich Text Editor Using Shortcuts

This table lists the key or key combinations that you use to navigate to and from the rich text editor toolbar and the results of using those keys:

Keyboard Shortcuts in Rich Text Editor v5

<i>Key or Key Combination</i>	<i>Result</i>
Alt + F10 On a Mac, you may require the Fn key.	Moves the focus to the toolbar.
<ul style="list-style-type: none"> • Enter • Space 	Selects a toolbar option when the focus is on the toolbar.
Esc	Closes contextual balloons and UI components, for example, drop-down list box.
Arrow keys	Moves through toolbar items and options.

Setting Navigation Personalizations

If you frequently use the tab key to navigate, you can opt to skip page elements that you know you will not need to access. For example, you can set your navigation personalizations to always tab over the calendar prompt if you always type the date into a date field and then press **Tab** to move quickly to the next field rather than opening the calendar prompt, selecting the date, and then closing the prompt. To do this:

1. Select **My Preferences** from Actions.

The My Preferences page appears.

2. The appearance of this page may differ depending on the application that you are using. If multiple preference categories appear in the left panel, select General Settings.
3. Expand the **Navigation Personalizations** section.
4. Configure the navigation options—specifically, tab navigation options—as you prefer.
5. Save your changes; your selections will be active the next time you log on to the system.

Related Links

“Defining User Preferences” (Applications User’s Guide)

Working with the Fluid User Interface

When you work with PeopleSoft Fluid User Interface, the controls differ from PeopleSoft Classic. Instead of drop-down menu navigation, you interact with tiles, lists, and other objects. The following table describes how assistive devices identify these controls.

<i>Fluid Object</i>	<i>Recognition by Assistive Devices</i>
Homepage Tiles	Tiles on Fluid homepages are recognized as links by assistive devices. Use these links to navigate to transaction pages.
NavBar	The Navigation List objects are recognized by assistive devices as buttons and, when activated, display a list of associated items on the Content Area.

You can use the personalization options on the Personalize Homepage page to reorder tiles or grouplets on a homepage or dashboard.

Using the Accessibility Button in Fluid

The Accessibility button is available in the quick access bar on the fluid banner. Using the Accessibility button, you can enable screen reader mode, view keyboard shortcuts, and access additional Accessibility Help information configured within the application.

The Accessibility button is only available when the quick access bar is displayed on fluid pages and the component buffer is available. This feature is not available on activity guide-based components.

Note: On small form factor devices, the Accessibility button is available only on the homepage in the quick access bar.

This example illustrates the Accessibility button in the fluid banner, and the menu items available under the Accessibility Button.

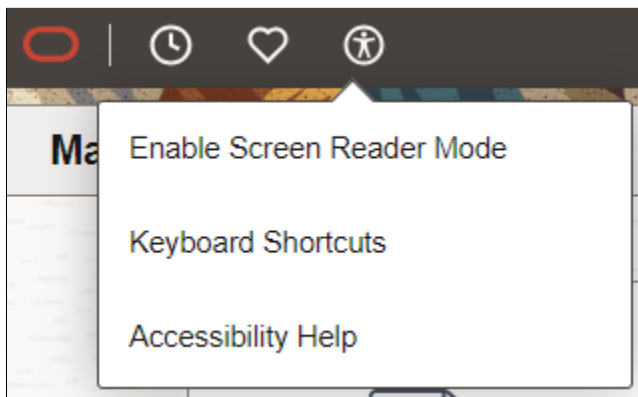

Enabling Screen Reader Mode

A screen reader is an assistive technology that renders text and image content as speech. A screen reader reads the content on the screen and is primarily used by people with vision impairments and learning disabilities. Examples of screen readers include JAWS, NVDA, VoiceOver, and ChromeVox.

If you already have a screen reader software installed on your device, select the Accessibility button and then select the **Enable Screen Reader Mode** menu item to enable screen reader mode.

If you are prompted to retain this setting for subsequent sessions, select:

- **Yes** if you want to enable screen reader mode for the current session and any subsequent sessions.
- **No** if you want to enable screen reader mode temporarily for the current session only.

See [Enabling Screen Reader Mode](#).

Note: The **Enable Screen Reader Mode** menu item does not appear in the Accessibility button drop-down menu when screen reader mode is already enabled.

Viewing Keyboard Shortcuts

You can use keyboard shortcuts and keyboard navigation alternatives instead of using a mouse so you can work more efficiently. These keyboard shortcuts help you navigate the page or perform certain actions on the page using only the keyboard. Keyboard-only navigation features are available to all users and do not require users to enable screen reader mode.

Select the Accessibility button and then select the **Keyboard Shortcuts** menu item to view a list of keyboard shortcuts.

See [Navigating with the Keyboard](#).

Viewing Additional Accessibility Help information

Select the Accessibility button and then select the **Accessibility Help** menu item to view the Accessibility Help Viewer page which displays additional Accessibility Help information configured within the application. The content under the Accessibility Help Viewer page is configured by an administrator using the Define Accessibility Help page. See [Using the Define Accessibility Help Page](#).

In the Accessibility Help Viewer page, the available topics are displayed in the Topic Selection Panel on the left side of the page. When you select the topic label, the content in the topic is displayed on the right side of the page.

This example illustrates the Accessibility Help Viewer page.

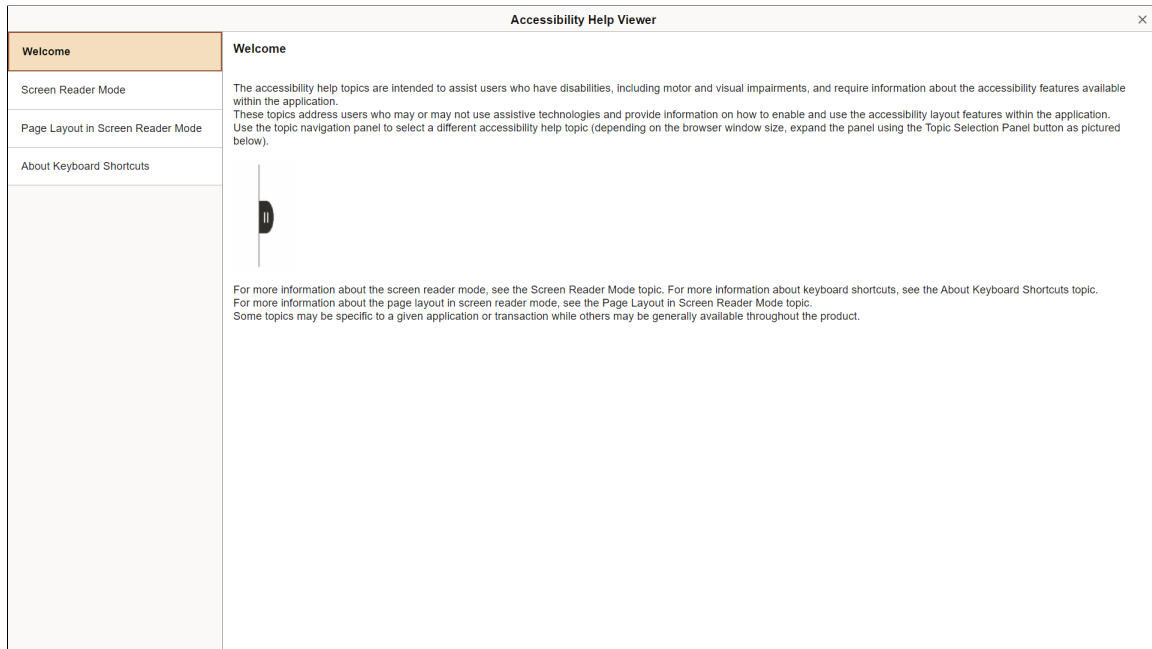

Using the Define Accessibility Help Page

The Define Accessibility Help page allows administrators to view and configure the information displayed on the Accessibility Help Viewer page using a rich text editor.

To access the Define Accessibility Help page, select **PeopleTools > Utilities > Administration > Define Accessibility Help**.

Use this page to view or edit existing topics or add new topics in the Accessibility Help Viewer page.

This example illustrates the Define Accessibility Help page. You can find definitions for the fields and controls later on this page.

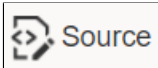
Field or Control	Description
Help Code	Set the internal identifier for the Accessibility topic. The Help Code must be unique.
Sequence Number	Enter a sequence number to determine the sequence in which the topic will be displayed in the Accessibility Help Viewer page.
Active Flag	Select to display the topic in the Accessibility Help Viewer page. When disabled, the topic is hidden and does not appear in the Accessibility Help Viewer page. This option is enabled by default.
Label	Enter a label for the topic. The label appears on the Topic Selection Panel on the Accessibility Help Viewer page.
Content	Use this section to edit the existing content or enter new content for the Accessibility Help Viewer page.
	Select the Source button within the rich text editor to directly access the HTML source for the topic to add HTML, CSS, and Aria attributes not provided natively by the editor.

Migrating Accessibility Help

PeopleSoft provides the ability to migrate data for Accessibility Help using PeopleSoft Data Mover.

You can export Accessibility Help data from a development environment (source) and import the data into a testing or production environment (target). The following data types can be migrated:

- Rich Text Editor data.
- Images.

Example: Exporting Data for Accessibility Help

This is an example of a Data Mover Script export statement to export Accessibility Help content:

```
EXPORT PS_PT_ACCHELP;
```

This is an example of a Data Mover Script export statement to export Accessibility Help images:

```
EXPORT PS_PTRTDB;
```

This is an example of a Data Mover Script export statement to export specific Rich Text Editor images:

```
EXPORT PS_PTRTDB where attachsysfilename IN ( 'image#1_name' , 'image#2_name',... 'image#n_name' ) ;
```

The image name is appended with the timestamp, making it unique.

Example: Importing Data for Accessibility Help

This is an example of a Data Mover Script import statement to import Accessibility Help content:

```
IMPORT PS_PT_ACCHELP;
```

This is an example of a Data Mover Script import statement to import Accessibility Help images:

```
IMPORT PS_PTRTDB;
```

This is an example of a Data Mover Script import statement to import specific Rich Text Editor images:

```
IMPORT PS_PTRTDB where attachsysfilename IN ( 'image#1_name' , 'image#2_name',... 'image#n_name' ) ;
```

The image name is appended with the timestamp, making it unique.

Note: If the target environment already has existing data, use the WHERE clause to import the Accessibility Help data to avoid overwriting the existing data. For more information, see “Using PeopleSoft Data Mover Command Modifiers” (Lifecycle Management Guide).

Chapter 4

Using PeopleTools to Build Accessible Applications

Determining User Accessibility Layout Mode Using PeopleCode

Users activate accessibility layout features by setting the **Accessibility Layout** option to *Screen Reader On* in their personalizations. PeopleTools provides a PeopleCode function to determine a user's layout mode personalization setting. For example:

```
&access = GetUserOption("PPTL","ACCESS");
If &access = "A" then
/* Logic for accessible layout/screen reader on mode user */
Else
/* Logic for non-accessible layout/screen reader off mode user */
End-if
```

Enabling Users to Complete Tasks Using the Keyboard

This section explains how to design applications according to the following WCAG 2.0 standards:

- 2.1.1 - Keyboard: All functionality of the content is operable through a keyboard interface without requiring specific timings for individual keystrokes, except where the underlying function requires input that depends on the path of the user's movement and not just the endpoints.
- 2.4.3 - Focus Order: If a Web page can be navigated sequentially and the navigation sequences affect meaning or operation, focusable components receive focus in an order that preserves meaning and operability.

Assigning Keyboard Shortcuts

Use keyboard shortcuts to improve usability for users who use a keyboard rather than a mouse. PeopleSoft applications use two kinds of keyboard shortcuts: hot keys and access keys.

See [Using Keyboard Shortcuts](#).

This section discusses how to:

- Assign access keys to page tabs.
- Assign access keys to grid tabs.

Assigning Access Keys to Page Tabs

To assign access keys to page tabs:

1. Open the component definition in PeopleSoft Application Designer.
2. Enter an ampersand (&) in the text of the item label for the page preceding the letter that you want to assign as the access key.

The access key letter is underlined on the page tab at runtime. For example:

This example illustrates using ampersands to assign access keys.

Definition		Structure		
	Page Name	Item Name	Hidden	Item Label
1	JOB_DATA1	JOB_DATA1	<input type="checkbox"/>	Work Location
2	JOB_DATA_JO...	JOB_DATA_JOBCO...	<input type="checkbox"/>	&Job Information
3	JOB_LABOR	JOB_LABOR	<input type="checkbox"/>	Job &Labor
4	JOB_DATA2	JOB_DATA2	<input type="checkbox"/>	&Payroll
5	JOB_DATA_SA...		<input type="checkbox"/>	&Salary Plan
6	JOB_DATA3	JOB_DATA_3	<input type="checkbox"/>	&Compensation

Note: Make sure that the access key that you assign does not conflict with any other access keys that are assigned in the component.

At runtime, a user can navigate between pages by pressing the **Alt** key plus the letter that is underlined, followed by the **Enter** key.

This example shows underlined access keys that the user sees at runtime.

<u>W</u> ork Location	Job Information	Job <u>L</u> abor	<u>P</u> ayroll	<u>S</u> alary Plan	<u>C</u> ompensation
-----------------------	-----------------	-------------------	-----------------	---------------------	----------------------

Assigning Access Keys to Grid Tabs

To assign access keys to grid tabs:

1. Open the grid tab separator properties in PeopleSoft Application Designer.
2. On the Label tab, enter an ampersand (&) in the label text preceding the letter that you want to assign as the access key.

The access key letter is underlined on the grid tab at runtime.

Note: Make sure that the access key that you assign does not conflict with any other access keys that are assigned on the page.

At runtime, a user can navigate between grid tabs by pressing the **Alt** key plus the letter that is underlined, followed by the **Enter** key.

Related Links

“Defining Components” (Application Designer Developer’s Guide)

“Using Grids” (Application Designer Developer’s Guide)

“Creating HTML Definitions” (Application Designer Developer’s Guide)

Maintaining a Logical Tab Order

Maintaining a logical tab order on your page is critical, because people who are blind or visually impaired cannot see the groupings or field proximity. When the **Accessibility Layout** option is set to *Screen Reader On*, PeopleTools automatically linearizes pages based on the tab order, so the tab order must be set up correctly in each page definition in PeopleSoft Application Designer.

Tab order is also important for sighted users who use the keyboard to navigate because it can be confusing if the cursor moves to fields in an order that is different from how they appear on the screen.

This section discusses how to:

- Order controls logically
- Test the tab order
- Change the tab order

Ordering Controls Logically

Tab ordering through a page at runtime is strictly defined by page field ordering. When you add a control to a page, PeopleSoft Application Designer automatically inserts it in the order list based on where you position it on the page. You can manipulate the ordering of fields on your page by moving them up or down on the Order tab in the page definition. In doing so, you also change the tab order that users follow as they move through fields on the page.

In general, field tab order should flow from top left to bottom right on a page. The flow should reflect the way that the eye naturally scans information. On a page with multiple scroll levels, the tab order should follow the scroll level order, from Level 0 to Level 1, and so on. In a noncolumnar page, the tab order should go from left to right on each line from top to bottom. For example:

This example illustrates correct field tab order flow on a noncolumnar page.

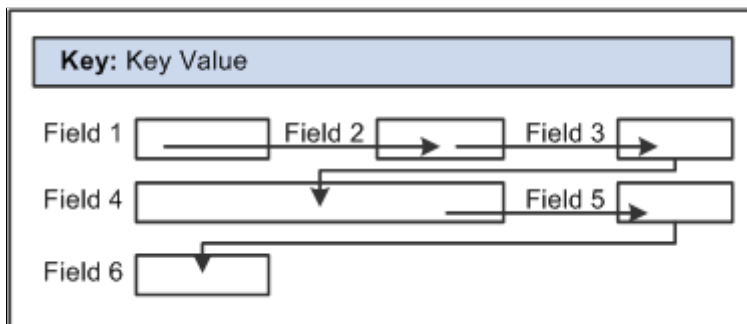

In a columnar page, the tab order should go from the top to the bottom of the first column, and then from the top to the bottom of the second column, and so on. For example:

This example illustrates correct field tab order flow on a page with two columns.

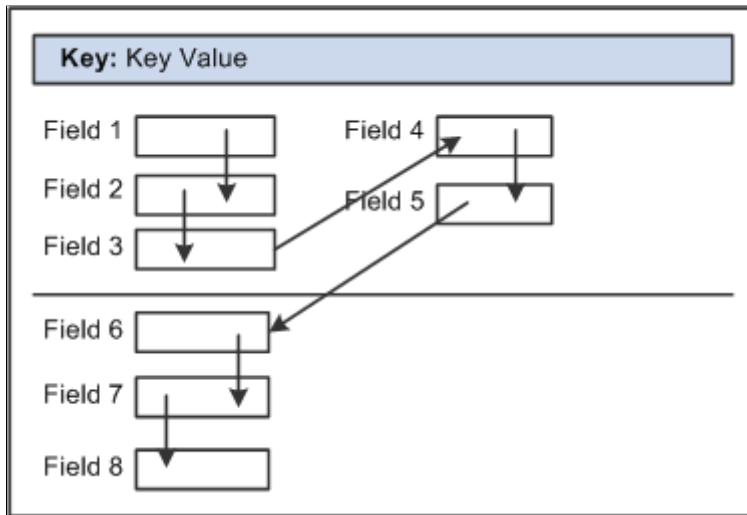

Fields that share the same label should follow consecutively in the tab order from left to right.

Testing the Tab Order

After you have placed all of the controls on your page, you should test the tab order. You can do this by viewing the page in the browser and tabbing through the page controls.

Note: The tab order that you establish at design-time may not apply for all browsers. For more information, see the *PeopleTools Browser Compatibility Guide* on My Oracle Support.

Changing the Tab Order

The Order tab of the page definition displays attributes about each of the page fields and their field order. The ID column represents the order in which the field was added to the page. If you modify the order of page fields on the page, note that the numbers assigned to each field remain constant. Thus the IDs may not always appear in sequential order. The field ID appears in the Compare report when a database compare is performed to assist you in identifying specific page fields.

Reorder page fields on the Order tab by dragging them in the same view. Changing the order list does not change the physical location of controls on the page. It changes only the logical order or tab order in which controls are processed. When you have added and arranged all of your controls, you may want to print your page definition to see how you might need to reorder your controls.

The Order tab also governs processing rules for scrolls and record or field relationships. Consider which controls are associated with which scroll area or scroll bar and which secondary relationships are important to page processing.

To change the order list:

1. Open the page definition in PeopleSoft Application Designer.
2. Select the **Order** tab.
3. To move a control to another position in the control order list, select the control that you want to move.

Press the **Shift** key to select multiple controls.

4. Drag the selected control to the new position on the **Order** tab.

The system moves the control to the new location in the list. The ID value remains static. The visual display of the page still looks the same—changing the order list does not move the control on the page, only the logical processing order of the control.

Important! When viewing your page in Test Mode, page fields cannot be accessed, moved, or modified from the Order tab if the page definition contains a sub page. Exit Test Mode to rearrange page fields in the order list.

Related Links

“Ordering and Spacing Page Controls” (Application Designer Developer’s Guide)

Maintaining the Focus

This section explains how to design applications according to the following WCAG 2.0 standards:

- 2.4.7 - Focus Visible: Any keyboard operable user interface has a mode of operation where the keyboard focus indicator is visible.
- 3.2.1 - On Focus: When any component receives focus, it does not initiate a change of context.

PeopleSoft applications are designed to provide clear feedback on the position of the cursor on-screen and to enable assistive technology to track the cursor focus. When accessibility layout features are on, the on-screen focus is indicated by a thick dark outline around the field that is in focus.

By default, the PeopleSoft application places initial focus to the first interactive PeopleSoft element within the main content area of a page when opened. This initial focus behavior allows the user to immediately begin interacting with the transactional fields for data entry.

Note: Initial focus is not set on mobile devices on fluid pages in certain circumstances. On a mobile device, whenever a fluid page is displayed or redisplayed due to user action, the PeopleSoft application does not automatically set focus to any field that would activate the device’s keyboard (for example, input fields, calendar fields, and so on) or that would activate selectors (for example, drop-down list boxes, date/time fields, and so on).

To help assistive technology maintain the focus, set up applications to use the Deferred processing mode, which batches field-level events and processes them the next time the user triggers a server trip. Interactive mode processes field level events as they occur, giving users immediate feedback. However, each server trip refreshes the page. This refresh may cause some screen readers to lose focus of the field that the user was on, resulting in the screen readers going back to the top of the page and reading the page from the beginning. Some screen reader users may waste time finding their place again after a screen refresh. Interactive mode might still be appropriate in some situations, such as when one field on a page is dependent on another, but use it judiciously and test it with screen readers.

You can select Deferred mode at the page control, grid, page (include subpage and secondary page), and component levels. For a page control in the component to run in Deferred mode, you must select Deferred mode at each of those levels. Deferred mode is the default processing mode at all levels.

Related Links

“Improving Online Performance” (Application Designer Developer’s Guide)

Setting Deferred Mode at the Page Control or Grid Level

To set Deferred mode at the page control or grid level:

1. Open the properties for the control or grid in PeopleSoft Application Designer.
2. On the Use tab, select the **Allow Deferred Processing** check box.

Related Links

“Understanding Page Controls” (Application Designer Developer’s Guide)

“Using Grids” (Application Designer Developer’s Guide)

Setting Deferred Mode at the Page Level

To set Deferred mode at the page level:

1. Open the page properties in PeopleSoft Application Designer.
2. On the Use tab, select **Allow Deferred Processing**.

Related Links

“Producing Pages” (Application Designer Developer’s Guide)

Setting Deferred Mode at the Component Level

To set Deferred mode at the component level:

1. Open the component definition in PeopleSoft Application Designer.
2. Select the **Allow Deferred Processing** check box for every page in the component.
3. Open the component properties.
4. On the Internet tab, select Deferred for the processing mode.

Related Links

“Setting Component Properties” (Application Designer Developer’s Guide)

Customizing Processing Notification Delay Time

This topic discusses system processing notifications for assistive technology users.

Understanding Processing Notifications for Assistive Technology Users

PeopleTools and PeopleSoft applications usually indicate system processing by displaying a Loading icon on the screen.

Assistive technology users need a way to identify that this type of background processing is occurring.

If a Loading icon displays on the screen for more than two seconds, screen readers read "Processing. Please Wait." Once the load is complete, screen readers read "Loading Complete." That is, there is a delay time of two seconds between the start of system processing and when the "Processing. Please Wait." notification is available to the screen reader.

Customizing Processing Notification Delay Time

The default delay time between the start of system processing and the processing notification is two (2) seconds.

To customize the processing notification delay time:

1. Login to Application Designer.
2. Open the HTML file *PT_PAGESCRIPT*.
3. Navigate to the function `window.showhide` and change the second argument value of the function call `setTimeout(callbackOnDelay_%Formname, 2000)` accordingly.

This parameter is in milliseconds. If the preferred delay time is five (5) seconds, then the second value (replacing 2000) is *5000*. If it is 2.5 seconds, it should be *2500* milliseconds.

4. Open the HTML file *PT_PROCESSING*.
5. Navigate to `ptLoadingStatus_empty(display)` method and change the second argument value of the function call `setTimeout(callbackOnDelay_empty, 2000)` accordingly.
6. Save all changes.
7. Clear browser cache before login

Identifying Images and User Interface Elements

This section explains how to design applications according to the following WCAG 2.0 standards:

- 1.1.1 - Non-text Content: All non-text content that is presented to the user has a text alternative that serves the equivalent purpose, except for the situations listed below: Controls, Input; Time-Based Media; Test; Sensory; CAPTCHA; and Decoration, Formatting, Invisible.
- 1.3.1 - Info and Relationships: Information, structure, and relationships conveyed through presentation can be programmatically determined or are available in text.
- 2.4.6 - Headings and Labels: Headings and labels describe topic or purpose.
- 3.3.2 - Labels or Instructions: Labels or instructions are provided when content requires user input.

Ensure that all user interface elements have descriptive labels. PeopleTools provides the ability to add labels to user interface elements, but it does not automatically insert labels. You must add them manually.

User interface elements include functional images, page controls (such as push buttons and edit boxes), grids, group boxes, and scroll areas. Functional images include image buttons and links and images that convey meaningful information, such as status. Meaningful labels are vital for people who are blind or visually impaired so that they can understand the meaning of an image through screen readers. Image labels also clarify the meaning of images for sighted users, because the labels appear as mouse-over text in some browsers. Decorative images, such as invisible spacer files or images that do not serve a functional purpose other than to provide visual interest, should have blank (empty) labels.

Note: When you assign labels to images in PeopleSoft Application Designer, PeopleTools generates alternate text (<ALT> HTML tags) based on the labels at runtime. These labels are visible to all users as mouse-over text in some browsers, regardless of whether the system administrator makes the accessibility layout features available to users in PeopleTools Security.

Oracle recommends that you use the browser zoom utility, as opposed to the text zoom, to avoid distortion on the page. If the text zoom is used, the text becomes larger, but the corresponding buttons, grids, and so on, do not change, so the page becomes distorted.

Creating Meaningful Label Text

This section provides general guidelines for creating label text, but this information is not meant to be a complete discussion about text. You should consult other resources, as well.

Follow these general guidelines when you create label text to assign to user interface elements:

- Use descriptive text that explains the specific function or purpose of the user interface element.

For example, do not create a link labeled “Click here.” Use a descriptive label, such as “Return to Previous Page.”

- Use unique labels for all images and controls on a page.

Many screen readers generate lists of the various controls (such as buttons and links) on a page to make it easier for users to navigate without having to tab through the entire page. If two buttons on a page have the same name, users may not be able to determine which one they need from the list that is generated by the screen reader.

For example, if you create a page to send an email, do not include a “Find” link for the **To** field and another “Find” link for the **CC** field. In a screen reader, the list of links displays two “Find” links but no additional information to differentiate between them.

Note: Within grids, the same fields, buttons, and links appear in every row. However, these are not considered duplicates because screen readers typically read the row number with each label (for example, “row 1 Details link,” “row 2 Details link,” and so on).

- Avoid using abbreviations in labels.

Screen readers read abbreviations differently. For example, some read *Nbr* as a word and others read it as individual letters, either of which could confuse users.

- Avoid using punctuation and symbols in labels.

Screen readers interpret symbols differently. For example, some read # as *number* and some read it as *pound*.

- Do not modify formatting styles to add color, bold, or italicized text to labels because screen readers do not recognize formatting changes.
- Do not use device-dependent language such as “Click” in link text.

Not all users use a mouse, so the word *click* can be misleading.

Assigning Labels to User Interface Elements

To assign labels to user interface elements:

1. Open the properties for the image or page control in PeopleSoft Application Designer.
2. On the Label tab, select the type of label, and enter or select the label text.

Label types include a message from the Message Catalog, custom label text, or the RFT long or RFT short label if the image or control is associated with a record field. (Not all label types are available for all types of controls.) The Message Catalog is the preferred source of label text because it can be translated. The Message Catalog contains labels for the following types of page elements: folder tabs, scroll left and right buttons, hide and show grid tabs, prompt buttons, expand and collapse grid buttons, group boxes, and scroll areas.

Follow these principles when choosing the type of label:

- For buttons and links that perform a function, choose a label that describes the function (for example, Search or Save).
- For data entry fields, choose a label that describes what to enter in the field.
- If an image displays text, choose a label that is exactly the same as the text in the image.
- If an image is not active but conveys information, choose a label that conveys the same information (for example, a description of the status).
- If an image is redundant or conveys no information, leave the label blank.

Guidelines for Data Entry Field Labels

To ensure that screen readers read data entry field labels properly, use the following general guidelines when creating field labels:

- Avoid repeating group box labels in the field labels within the group box.

When you include fields within a group box, screen readers read the group box label before each field label within the group box.

- Avoid adding additional text after the field that explains information about what the user should enter.

Screen readers do not typically read this type of text with the field labels. Instead, a user must specifically command the screen reader to read the entire page or a particular area of the page. As an alternative to including additional text after the field, make the field label more descriptive.

- Do not use static text or a second independent field as the label for a data entry field.

Doing so may cause confusion for people who are blind or visually impaired, because not all screen readers interpret these situations correctly. Always assign the label to the field in the properties for that field.

- Do not insert a text field above a column of entry fields to simulate a table and column heading.

Instead, assign a unique label to each field or use a grid, if appropriate.

- Size edit boxes, long edit boxes, and drop-down list boxes so that the full contents are visible without horizontal scrolling.
- Place labels close to the corresponding fields.

For edited boxes, long edited boxes, and drop-down list boxes, place labels to the left (or above) the field. For check boxes and radio buttons, place labels to the right.

Note: Do not place entry fields between radio buttons. This placement may interfere with how screen readers read the radio buttons.

Guidelines for Group Boxes

If group boxes are used only for *visual layout* purposes, select the **Suppress Accessible Label** check box in Application Designer on the Group Box Properties – Label tab. This prevents screen readers from reading the label when the **Accessibility Layout** option is set to *Screen Reader On*.

Avoid nesting group-boxes unnecessarily as this can lead to confusion for screen reader users. It is recommended to use only one level deep for group boxes. For additional levels, use a header.

Related Links

“Understanding Page Controls” (Application Designer Developer’s Guide)

“Setting Page Field Properties for Controls” (Application Designer Developer’s Guide)

“Using Multiple Labels” (Application Designer Developer’s Guide)

“Using Group Boxes” (Application Designer Developer’s Guide)

Removing Labels from Decorative Images

If images have no information to convey to users and do not serve as navigation, they should not have labels. Images used as spacers, such as invisible GIFs, also should not have labels.

To remove labels from images:

1. Open the properties for the image in PeopleSoft Application Designer.
2. On the Label tab, set the **Label Text Type** field to *Static Text*.
3. Delete any characters from the **Text** field if it is present.

You do not need to enter a space. Leave the **Text** field blank.

Providing Text Equivalents for Charts and Graphs

Charts and graphs present data as images or client-side image maps with links to navigate to details about the data. Because charts and graphs typically display significant amounts of data, providing alternate text labels for the chart or graph images is usually not enough to make the data accessible to people using screen readers. To make charts and graphs more accessible:

- Do not use ASCII images to display charts and graphics; use the objects that are provided in PeopleTools.
- Do not use color alone to convey information in charts and graphs.

See [Providing Alternatives to Color Coding to Convey Meaning](#).

- Provide textual information to describe the content of charts and graphs.

You can insert a static text field to describe the charts and graphs, but also consider displaying the underlying table information of the chart or graph in a grid format when the **Accessibility Layout** option is set to *Screen Reader On*. This method ensures that users in Screen Reader On mode get the same information that the chart or graphic image conveys.

Note: The label that you specify on the Label tab of the Chart Properties dialog box is for information-only and does not appear at runtime. This label appears on the control order list on the Order tab of the page definition and any page definition report that you print.

Related Links

“Using Charts” (Application Designer Developer’s Guide)

“Using Static Text” (Application Designer Developer’s Guide)

“Charting Classes Reference” (PeopleCode API Reference)

Assigning Labels for Grid Columns and Rows

When you create grids, make sure that you include column headings for all visible columns, including columns that contain images and links. In addition, avoid adding grid controls (such as scroll actions). Grid controls that you add are not included automatically within the page area that is skipped by the PeopleTools-generated page anchor.

Column headings and their alignment are derived from the label text that you select on the Label tab in the properties for the page control or page field that you assign to the column. Therefore, you must make sure that the associated page controls or data entry fields have appropriate labels, according to the guidelines in the preceding sections. Also make sure that you select the Show Column Headings (runtime) check box on the Label tab in the Grid Properties dialog box.

If adding column headings will interfere with usability for sighted users, you can hide the grid column titles so that they appear only when the **Accessibility Layout** option is set to *Screen Reader On* by adding PeopleCode that renames the column headings at runtime.

Row headings can be assigned in Application Designer, by providing a value for the **Row Header** option. If **Row Header** is not specified, then the row header generated by default is the first display-only edit field.

Related Links

[Hiding Labels](#)

[Providing Links to Skip Repetitive Navigation](#)

“Using Grids” (Application Designer Developer’s Guide)

PeopleCode Developer’s Guide

PeopleCode Language Reference

Assigning Titles and Summaries for Grids and Scroll Areas

Include titles and descriptive summaries for all grids and scroll areas. To do this:

1. Open the properties for the grid or scroll area in PeopleSoft Application Designer.
2. On the Label tab, select the **Display Title** check box.
3. Click the **Properties** button for the display title to open the Title Properties dialog box.
4. Enter the Label text that you want to appear in the title:

Field or Control	Description
Type	Select the type of label text to appear in the navigation bar. <i>Message Catalog</i> : Select this option to use a message in the Message Catalog as the title. <i>Static</i> : Select this option to manually enter text as the title.
Text	Enter the text to appear as the title of the scroll area. This field is enabled when you select <i>Static</i> as the Label Text type.
Message Set/Number	Enter the message set number and message number of the message in the Message Catalog to appear as the title of the scroll area. This field is enabled when you select <i>Message Catalog</i> as the Label Text type.

5. Click OK to return to the Label tab in the properties.
6. Click the **Properties** button in the **Summary** group box to open the Summary Properties dialog box.

Note: The default value of the summary matches the title. However, you should add a more detailed description of the contents of the grid or scroll area to make the summary more useful in Screen Reader On mode.

7. Clear the **Default to Title** check box to activate the other Summary options.

8. Enter static text or enter a message set and number to use text from the Message Catalog.
9. Click OK twice.

Related Links

“Understanding Scroll Areas, Scroll Bars, and Grids” (Application Designer Developer’s Guide)

Hiding Labels

In some cases you might want to hide labels so that they do not appear on screen but are still read by screen readers when **Accessibility Layout** option is set to *Screen Reader On* mode. For example, a currency field that appears to the right of an amount field may not require a visible label for sighted users. However, people who are blind or visually impaired often navigate to fields from a list of fields that the screen reader generates, so each field requires a label.

To hide labels while still enabling screen readers to access them:

1. Open the properties for the page control or page field in PeopleSoft Application Designer.
2. On the Label tab, make sure that a label is selected and change the style to *PTTRANSPARENT*.

This style is set up to be invisible except for users in Screen Reader On mode.

Note: If you use *PTTRANSPARENT* for a check box label, make sure that no fields are close to the check box label, even though it is transparent, because it might overlap the field.

Using Pop-Up Message Windows for Important Information

If you use a field or an HTML area to display text that contains important information, such as error messages, use PeopleCode to display the message in a pop-up window when **Accessibility Layout** option is set to *Screen Reader On* mode. Screen readers do not typically read display-only field values unless a user specifically commands the screen reader to read the entire page or a particular area of the page.

The following example shows how to create this type of PeopleCode:

```
If All(&CAL_FINAL_TS) Then
  If GetUserOption("PPTL", "ACCESS") = "A" Then
    MessageBox(%MsgStyle_OK, "", 17000, 407, "");
  End-If;
  &rs0(1).DERIVED_GP.TEXT254.Value = MsgGetText(17000, 407, "");
  &rs0(1).DERIVED_GP.TEXT254.Visible = True;
Else
```

Related Links

PeopleCode Developer’s Guide

PeopleCode Language Reference

Using Images Consistently

This section explains how to design applications according to the following WCAG 2.0 standard:

3.2.3 - Consistent Navigation: Navigational mechanisms that are repeated on multiple Web pages within a set of Web pages occur in the same relative order each time they are repeated, unless a change is initiated by the user.

Before creating your own images, check the Image Catalog in PeopleSoft Application Designer to see if an existing image is already available. The images are categorized by function and listed alphabetically by image name. Always use images only for the purpose that is specified in the Image Catalog. If you create new images, use them consistently. For example, you should always use the following image for the **Search** button:

This example shows the Search button.

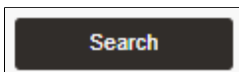

To see a complete list of available images and their purposes, access the Image Catalog by selecting File, Open, Image in PeopleSoft Application Designer.

In addition, if you use images to convey status, make sure that you are using the status indicator images correctly.

See [Providing Alternatives to Color Coding to Convey Meaning](#).

Related Links

“Creating Image Definitions” (Application Designer Developer’s Guide)

Enabling Users to Override Contrast and Color Selections

This section explains how to design applications according to the following WCAG 2.0 standard:

1.4.3 - Contrast (Minimum): The visual presentation of text and images of text has a contrast ratio of at least 4.5:1, except for the following: Large Text, Incidental, and Logotypes.

PeopleTools uses style sheets to apply text and background colors in the applications. System administrators can change colors and contrast settings for all users by modifying the delivered style sheets or by creating multiple style sheets.

In PeopleTools, style sheets are definitions, like record or page definitions, that you create and maintain in PeopleSoft Application Designer. To modify colors in style sheets:

1. Open the style sheet definition in PeopleSoft Application Designer.
2. Access the Classes dialog box.
3. Change font colors on the Font tab and change background colors on the Background tab.

Note: Do not use color to convey meaning. For more information, see [Providing Alternatives to Color Coding to Convey Meaning](#).

Related Links

“Understanding Style Sheets and Style Classes” (Application Designer Developer’s Guide)

Providing Alternatives to Color Coding to Convey Meaning

This section explains how to design applications according to the following WCAG 2.0 standard:

1.4.1 - Use of Color: Color is not used as the only visual means of conveying information, indicating an action, prompting a response, or distinguishing a visual element.

Do not use color as your only way to convey information. Include a redundant clue so that people who are color-blind or visually impaired are aware that a field or process is special or different. For example, do not change the background or text color to red to indicate an error. Another common mistake is to use an icon that changes color based on status but is otherwise the same. Color-blind users cannot distinguish between certain colors, nor can screen readers. In addition, if a user prints a page on a black and white printer, color-dependent items on the page become indistinguishable.

When showing status, you have two options:

- Use a display-only text field with the label **Status** to indicate status.

For example:

This example shows a display-only status text field.

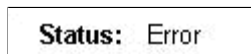

- Use icons that have different colors and different shapes to represent the different status values.

The following incorrect example shows status icons that are differentiated only by color:

This example illustrates status icons that use only color to convey meaning; this should be avoided.

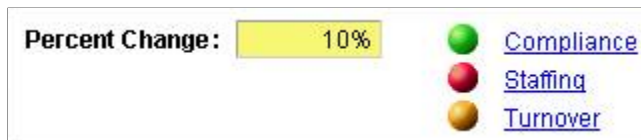

The following correct example shows status icons that have both different colors and different shapes:









This example illustrates status icons that use both color and shape to convey meaning. This is desired.



Note: When using icons, be sure to assign alternative text labels to the icons.

See [Identifying Images and User Interface Elements](#).

For consistency, use the following icons to indicate status:

<i>Field or Control</i>	<i>Description</i>
	PS_STATUS_OK_ICN: OK, normal, good
	PS_STATUS_CAUTION_ICN: Warning, caution, at risk
	PS_STATUS_ERROR_ICN: Error, critical
	PS_STATUS_CLOSED_ICN: Completed
	PS_STATUS_CANCELLED_ICN: Cancelled
	PS_STATUS_UNCHANGED_ICN: No status, status unchanged
	PS_STATUS_TREND_UP_ICN: Trend up
	PS_STATUS_TREND_STABLE_ICN: Trend unchanged

Note: In addition, do not use flickering, moving, blinking, scrolling, or auto-updating objects to indicate status.

Providing Links to Skip Repetitive Navigation

This section explains how to design applications according to the following WCAG 2.0 standard:

2.4.1 - Bypass Blocks: A mechanism is available to bypass blocks of content that are repeated on multiple Web pages.

Use page anchors to enable users to jump to other areas of a page. For example, if a page contains a group of navigation links or a series of four or more text buttons in a row, users who navigate using the keyboard might not want to tab through those links or buttons every time they visit the page. You can enable them to skip repetitive page controls by adding a page anchor labeled “Skip Toolbar and Navigation Links” before the repetitive controls. You might also want to provide a way for users to return to the repetitive controls, if they need them, by including another page anchor labeled “Return to Toolbar and Navigation Links” to take them back.

To add these page anchors:

1. Insert a push button/hyperlink object on the page using PeopleSoft Application Designer.

Locate the new object immediately before the controls to be skipped.

2. Open the properties for the new object.
3. On the Type tab, change the type to **Hyperlink**, add a record and field name, and change the destination to *Page Anchor*.
Leave the related control blank. You add this information after you create the return object.
4. On the Label tab, enter a label using the Message Catalog.
5. On the General tab, enter a page field name and select the **Enable as Page Anchor** check box.
The page field name is used as a reference later in the PeopleCode.
6. Add another push button/hyperlink object to the page after the repetitive controls that you want to skip.
7. Open the properties for the new object.
8. On the Type tab, change the type to *Hyperlink*, add a record and field name, change the destination to *Page Anchor*; and enter the page field name for the first object (the name that you entered on the General tab of the properties for that object) in the **Related Control** field.
9. On the Label tab, enter a label using the Message Catalog.
10. On the General tab, enter a page field name and select the **Enable as Page Anchor** check box.
11. Open the properties for the first object again and enter the page field name of the second object in the **Related Control** field on the Type tab.
12. Click OK, and then save the page.
13. Add PeopleCode to hide the page anchors when the Accessibility Layout option is set to Screen Reader Off for users. For example:

```
/* Check if screen reader mode is on. If on then show anchors else hide the anchors */
chorst */
&access = GetUserOption("PPTL", "ACCESS");
If &access = "A" Then
    GetField(HRS_J03_NAV_WRK.HRS_J0360_SKIP).Visible = True;
    GetField(HRS_J03_NAV_WRK.HRS_J0360_RET).Visible = True;
Else
    GetField(HRS_J03_NAV_WRK.HRS_J0360_SKIP).Visible = False;
    GetField(HRS_J03_NAV_WRK.HRS_J0360_RET).Visible = False;
```

Creating HTML That Is Not Generated by PeopleTools

If a page contains HTML that is not generated by PeopleTools (such as code in HTML areas) or an applet, you must code to the WCAG 2.0 AA accessibility standards. The applicable WCAG 2.0 standards are all Level A and AA standards.

See www.w3.org/TR/WCAG20.

Related Links

“Creating HTML Definitions” (Application Designer Developer’s Guide)

Testing for Accessibility

When testing for accessibility, it's important to include a wide variety of users with various disabilities, test various assistive technologies, and include a combination of manual testing (for example, with the keyboard) and automated testing using scripts or browser add-ons to verify the HTML code. Various web resources and books are available outside of Oracle to help you develop your testing plan.

In addition, the HTML code that is generated for users who enable accessibility layout features is different from the HTML code that is generated for users who do not enable the features. Therefore, you must test for accessibility in all of the available accessibility modes:

- Test when the **Accessibility Layout** option is set to *Screen Reader On* with various assistive technology, such as screen readers.

If possible, test with users who are familiar with how the assistive technology works.

- Test keyboard navigation with accessibility layout features turned off.

Many accessibility users do not have vision problems, but they still use the keyboard instead of a mouse due to physical discomfort or disabilities.

Note: Testing for accessibility when the **Accessibility Layout** option is set to *Screen Reader Off* does not work for screen readers because most accessibility layout features are available only in *Screen Reader On* mode. Although when the **Accessibility Layout** option is set to *Screen Reader On* may be more difficult to navigate for sighted users, you must use it to test with screen readers.

To determine the full list of features that you need to test, review the [WCAG 2.0 Level A and AA standards](#).

The following list provides a high-level overview of the accessibility layout features that you should test after customizing applications in PeopleSoft Application Designer:

- Can users complete tasks using only the keyboard?
 - Is the tab order correct?
 - Are keyboard shortcuts assigned to page tabs and grid tabs?
- Do screen readers track the on-screen focus?
 - Do pages use the Deferred processing mode?
 - If pages do not use Deferred processing, is field processing minimized?
- Do all functional images and user interface elements have meaningful, unique labels?
 - Do functional images (static, dynamic, and button) have labels?

- Do data entry fields have labels?
 - Do push buttons and hyperlinks have labels?
 - Do grid columns have labels?
 - Do grids and scroll areas have titles?
 - Do grids have summaries?
 - Are labels deactivated for decorative images?
-
- Are images used consistently?
 - Do foreground and background colors provide sufficient contrast?
 - Do pages provide alternatives to color coding to convey meaning?
 - Do pages contain links to skip repetitive navigation?
 - Is HTML that is not generated by PeopleTools (such as code in an HTML area) or an applet coded to the WCAG 2.0 AA accessibility standards?

Chapter 5

PeopleTools Accessibility Improvements by Release

PeopleTools 8.50 Accessibility Improvements

This table describes accessibility improvements for release 8.50 by product area:

<i>Product Area</i>	<i>Improvements</i>	<i>PeopleBook Cross-References for More Information</i>
Portal	<ul style="list-style-type: none">• Redesigned the portal header to use list items for all links.• Rewrote the portal menu to use list items, which work better with screen readers than the older nested tables. List items make it easier for users to navigate the system.• Modified pagelet icons for minimize, maximize, help, and refresh functions to be usable through the keyboard. Previous releases required the use of a mouse.	<ul style="list-style-type: none">• <i>PeopleTools: Portal Technology</i>, “Modifying the Portal Interface”.• <i>PeopleTools: Portal Technology</i>, “Administering Portals”.• <i>PeopleTools: Portal Technology</i>, “Using Pagelet Wizard to Create and Manage Pagelets”.

Product Area	Improvements	PeopleBook Cross-References for More Information
<p>PeopleSoft Internet Architecture (PIA)</p>	<ul style="list-style-type: none"> • Added page headers to all PIA pages, as follows: <ul style="list-style-type: none"> • <H1> tag for the page title. • <H2> tag for group boxes, grids, and scroll areas at level 0, using their titles. • <H3> tag for group boxes, grids, and scroll areas at level 1, using their titles. • <H4> tag for group boxes, grids, and scroll areas at level 2, using their titles. • <H5> tag for group boxes, grids, and scroll areas at level 3, using their titles. <hr/> <p>Note: All scroll areas and grids must have titles in order for some page headers to be generated.</p> <hr/> <p>See Assigning Titles and Summaries for Grids and Scroll Areas.</p> <ul style="list-style-type: none"> • Removed fieldset-legend tags from grid and scroll areas and replaced them with headers. • Improved grid areas by providing row and column header tags for every cell in a grid. These tags make it easier for users to navigate grids in edit mode. • Provided a title for the Expand/Collapse icon. • Provided better and more usable error reporting on the PIA pages and the sign-on page. • Added the ISO Language attribute to all pages (added the %LanguageISO Meta-HTML variable). • Provided a better indicator on the current focus control. This indicator helps visually impaired users see where the cursor is focused on the screen. • Made required fields readable by screen readers. Screen readers now 	<ul style="list-style-type: none"> • <i>PeopleTools: Application Designer Developer's Guide</i>, "Creating Page Definitions". • <i>PeopleTools: Application Designer Developer's Guide</i>, "Creating Record Definitions". • <i>PeopleTools: Application Designer Developer's Guide</i>, "Using Scroll Areas, Scroll Bars, and Grids".

Product Area	Improvements	PeopleBook Cross-References for More Information
	<p>read “*(Star) required field” before required fields.</p> <ul style="list-style-type: none"> Updated the search results table so that screen readers read it correctly, and added a row counter to the summary table. 	
PeopleSoft Application Designer	<p>Provided the ability to populate summary text for grids so that users can provide descriptive information about grids.</p> <p>See Assigning Titles and Summaries for Grids and Scroll Areas.</p>	<p><i>PeopleTools: Application Designer Developer's Guide</i>, “Using Scroll Areas, Scroll Bars, and Grids”.</p>

Product Area	Improvements	PeopleBook Cross-References for More Information
PeopleTools pages	<p>Improved the HTML of delivered PeopleTools pages, including PeopleSoft Tree Manager, Query, Process Scheduler, Integration Broker, Security, Portal, and navigation pages.</p> <p>Improvements include:</p> <ul style="list-style-type: none"> • Removed unnecessary grid navigation headers (Skip and Jump). • Simplified portal headers and added header tags. • Removed unneeded anchor tags on pages. • Replaced tags with style classes. • Replaced <U> tags with style classes. • Simplified navigation pages. • Reorganized some pages so that they are easier to use in Accessibility mode. • Labeled input fields. • Added column headings for grids. • Reviewed and clarified alternate text for images and buttons. • Added grid summaries to grids. • Reviewed and updated the tab order. • Noted all grid and scroll area sort indicators to help users identify which columns they can sort. 	<ul style="list-style-type: none"> • <i>PeopleTools: Tree Manager</i> • <i>PeopleTools: Query</i> • <i>PeopleTools: Process Scheduler</i> • <i>PeopleTools: Integration Broker</i> • <i>PeopleTools: Security Administration</i> • <i>PeopleTools: Portal Technology</i>

PeopleTools 8.51 Accessibility Improvements

This table describes accessibility improvements for release 8.51 by product area:

Product Area	Improvement	PeopleBook Cross-References for More Information
PIA	Created a new grid customization page for Accessibility mode. This page makes it easier for users to customize grids.	<i>PeopleTools: Application Designer Developer's Guide</i> , "Using Scroll Areas, Scroll Bars, and Grids".
PeopleTools pages	Added or clarified labels on pages, including duplicate references. In some situations, duplicate references to the same text were removed so as not to confuse users.	<i>PeopleTools: Application Designer Developer's Guide</i> , "Using Page Controls".
Portal	Made the drop-down menu available in Accessible Layout mode. The drop-down menu is usable through the keyboard and uses ARIA tags to improve integration with screen readers. This functionality enables users to identify a specific record as a favorite.	<i>PeopleTools: Portal Technology</i> , "Understanding Portal Technology".
Navigation or Functional Area Navigation (FAN) pages	Simplified the navigation or FAN pages to use list tags instead of HTML tables. This functionality makes these pages easier for screen readers to process.	<i>PeopleTools: Portal Technology</i> , "Working with Navigation Pages and Navigation Collections".
PeopleSoft Integration Broker and other specific product pages	Improved the HTML in Accessible Layout mode, including: <ul style="list-style-type: none"> • Simplified and added links on Integration Broker pages. • Simplified the portal header and reduced the number of bullets that users can encounter. • Simplified the Add to Favorites page in Accessible Layout mode to improve usability. 	<i>PeopleTools: Integration Broker</i>

PeopleTools 8.52 Accessibility Improvements

This table describes accessibility improvements for release 8.52 by product area:

Product Area	Improvement	PeopleBook Cross-References for More Information
PIA Core Technology	In Accessible Layout mode, append 'Required' to the label of the field so screen reader reads it properly.	<ul style="list-style-type: none"> • <i>PeopleTools: Application Designer Developer's Guide</i>, "Creating Page Definitions". • <i>PeopleTools: Application Designer Developer's Guide</i>, "Creating Record Definitions".
Rich Text Editor	Added additional language tags for Rich Text Editor.	<ul style="list-style-type: none"> • <i>PeopleTools: Application Designer Developer's Guide</i>, "Creating Page Definitions". • <i>PeopleTools: Application User's Guide</i>, "Using PeopleSoft Application Pages".
Portal	Removed duplicate text on link if the alternate text is the same. Icons or buttons require the alternate text.	<i>PeopleTools: Application Designer Developer's Guide</i> , "Using Page Controls".
Portal or PIA Search Functionality	Added or clarified alternate text on icons and buttons. In some situations, duplicate references to the same text were removed so as not to confuse users.	<i>PeopleTools: Application Designer Developer's Guide</i> , "Using Page Controls".
PIA Core Technology	Removed extra label tags from non-form fields.	<i>PeopleTools: Application Designer Developer's Guide</i> , "Creating Page Definitions".
Portal	In accessibility mode, the keyboard-only navigation is not available for the Related Content or Related Actions context menu. Alternatively, you can use the standard menu navigation.	<i>PeopleTools: Application Designer Developer's Guide</i> , "Using Page Controls".

PeopleTools 8.53 Accessibility Improvements

This table describes accessibility improvements for release 8.53 by product area:

Product Area	Improvement	PeopleBook Cross-References for More Information
PIA Core Technology	Page design: added the ability to include the controls in an HTML area within the page tabbing order.	"Using HTML Areas" (Application Designer Developer's Guide)

Product Area	Improvement	PeopleBook Cross-References for More Information
PIA Core Technology	Page design: provided a new set level option for a horizontal rule, which enables you to specify a scroll level organization that differs from the tab order of page fields. Use this feature to manipulate the occurs level of your controls on the page while still preserving the physical tab order at runtime.	“Using Horizontal Rules” (Application Designer Developer’s Guide)
PIA Core Technology	Provided keyboard support for calendar controls.	Navigating with the Keyboard
Related Content Framework	Provided keyboard support for related content and related actions in accessibility mode.	“Understanding the PeopleSoft Related Content Framework” (Portal Technology)
Pivot Grids	Provided support for pivot grids in accessibility mode. An option is provided to view chart data as a grid. Users can navigate and perform actions on the pivot grid using the keyboard.	“Pivot Grid” (Getting Started with PeopleTools)
PeopleSoft Online Help	<p>The PeopleSoft Online Help was redesigned and coded to standards to work with assistive technology. The accessibility improvements include:</p> <ul style="list-style-type: none"> • Added alt attributes for all images. • Added summary attributes for all tables. • Enhanced text descriptions of images. • Improved navigation options and functionality for keyboard users. • Improved the underlying HTML code to work better with assistive technology, such as screen readers. 	<i>About This Help</i> , Navigating the PeopleSoft Online Help

PeopleTools 8.54 Accessibility Improvements

This table describes accessibility improvements for release 8.54 by product area:

Product Area	Improvement	PeopleBook Cross-References for More Information
PIA Core Technology	Page elements coded to standards for WCAG 2.0.	“Understanding Page Controls” (Application Designer Developer’s Guide)
PeopleSoft Application Designer	Group boxes - For group boxes that are used only for visual layout purposes, a new option is available in Application Designer in the Group Box Properties – Label tab, to suppress the group box label in accessibility mode.	“Using Group Boxes” (Application Designer Developer’s Guide)
PeopleSoft Application Designer	<p>Grids – In Application Designer in the Grid Properties – Use tab, the following new grid layout types are available:</p> <ul style="list-style-type: none"> • Original List Grid (Unordered) Identifies the grid as an unordered list containing rows of list items in accessibility mode. • Original List Grid (Ordered) Identifies the grid as an ordered list containing rows of list items in accessibility mode. • Original Presentation Grid Layout Identifies the grid as a layout table in accessibility mode. 	“Using Grids” (Application Designer Developer’s Guide)
PeopleSoft Application Designer	<p>Grids – In Application Designer, a new Row Header option enables you to select a grid column to use as the row header in accessibility mode.</p> <p>The dialog box for setting the Row Header option differs depending on the grid type:</p> <ul style="list-style-type: none"> • Grids with no tabs: available on the Grid Properties - General tab. • Tabbed Grids: available on the Tab Separator Properties - General tab. <p>If a row header is not specified, then the row header generated is the row number plus the first display-only edit field.</p>	“Using Grids” (Application Designer Developer’s Guide)

Product Area	Improvement	PeopleBook Cross-References for More Information
PIA Core Technology	Added landmarks to identify page sections per WAI-ARIA specifications. These landmarks provide a method to programmatically identify commonly found sections of web page content in a consistent way, which enables assistive technologies to provide users with features they can use to identify and navigate to sections of page content.	“Understanding Page Controls” (Application Designer Developer’s Guide)
Global Search	Provided enhanced keyboard support and added landmarks to list selections for accessibility mode.	“Working with Global Search” (Search Technology)
Charting	Provided the Chart Options page to specify system-wide accessibility settings by chart type.	“Special Considerations for Charts” (PeopleCode API Reference)
Portal	Provided enhanced keyboard support for page tabs, search page tabs, and grids tabs, per WAI-ARIA specifications.	“Understanding Grids and Scroll Areas” (Applications User’s Guide)
MultiChannel Framework	Enhanced HTML elements that are hidden or uncovered visually, to behave similarly in accessibility mode.	“PeopleSoft MultiChannel Framework” (MultiChannel Framework)
PIA Trees	Provided keyboard support for trees. Added landmarks, properties, and states for accessibility mode.	“Working With Trees” (Applications User’s Guide)
Activity Guides	Provided support for action item status changes and dependent link information pop-ups in accessibility mode.	“Understanding Activity Guides” (Portal Technology)
Portal Technology: WorkCenters	Provided enhanced keyboard support. Added landmarks, properties, and states for accessibility mode.	“Managing WorkCenter Pages” (Portal Technology)
Portal Technology: Related Content Framework	Provided enhanced keyboard support. Added landmarks, properties, and states for accessibility mode. Added header markup for pagelet labels.	“Understanding the PeopleSoft Related Content Framework” (Portal Technology)

Product Area	Improvement	PeopleBook Cross-References for More Information
Portal Technology: Pagelet Wizard	<p>Added landmarks to layout table nodes in default Navigation Collection-based pagelet XSLs</p> <p>Changed the step icon hover text on the Pagelet Wizard component to "step n - xxxx" format.</p>	"Understanding Pagelet Wizard" (Portal Technology)

PeopleTools 8.55 Accessibility Improvements

This table describes accessibility improvements for release 8.55 by product area:

Product Area	Improvement	PeopleBook Cross-References for More Information
PIA Core Technology	New personalization option for pagelet transfer warning in accessibility mode.	"Defining User Preferences" (Applications User's Guide)
PIA Core Technology	Enhanced keyboard commands for charts.	Navigating with the Keyboard
PIA Core Technology	New My Preferences page that contains various personalizations for customizing the user experience.	"Defining User Preferences" (Applications User's Guide)
PIA Core Technology: Fluid user interface	<p>Ability to set the Aria attributes on page controls using the following PeopleCode commands:</p> <ul style="list-style-type: none"> Field Class.AriaWrapperAttributes = Ajax wrapper (outer container of fields) Field Class.AriaAttributes = Actual Control (html tags of SELECT, INPUT, TEXTAREA, and A) <p>For example, Field Class.AriaAttributes = "aria-label='Employee Photo'";</p>	"Field Class Properties" (PeopleCode API Reference)
PIA Core Technology: Fluid User Interface	New keyboard commands for drag and drop.	Using Keyboard Shortcuts

PeopleTools 8.56 Accessibility Improvements

This table describes accessibility improvements for release 8.56 by product area:

<i>Product Area</i>	<i>Improvement</i>	<i>PeopleBook Cross-References for More Information</i>
PIA Core Technology	On the PIA sign-in page, the name of the option to enable accessibility features has changed from Enable Accessibility Mode to Enable Screen Reader Mode.	Personalizing Your PeopleSoft Experience to Support Assistive Technology
PIA Core Technology	The term “accessibility layout” has replaced the term “accessibility features”.	Throughout the PeopleTools 8.56 PeopleBooks documentation set.
PIA Core Technology	Accessibility Layout mode names have changed to: <ul style="list-style-type: none"> • Screen reader on • Screen reader off 	<ul style="list-style-type: none"> • Personalizing Your PeopleSoft Experience to Support Assistive Technology • Setting System Defaults for Accessibility Personalizations • “Understanding General Options” (Security Administration)
PIA Core Technology	The hot keys CTRL + ALT + P open mouse over pop-up pages.	Using Keyboard Shortcuts
PIA Core Technology	A “Processing. Please Wait.” notification is read on screen readers when the Loading icon appears on screen due to system processing for more than two seconds. Administrators can customize the delay time to suit customer preferences.	Customizing Processing Notification Delay Time
PIA Core Technology	The ENHANCEDCURS personalization enables the enhanced focus indicator formerly provided by the Standard Layout mode.	“Understanding General Options” (Security Administration)

PeopleTools 8.57 Accessibility Improvements

This table describes accessibility improvements for release 8.57 by product area:

Product Area	Improvement	PeopleBook Cross-References for More Information
PIA Core Technology	Ability to create pop-up menus with keyboard navigation per WCAG 2.0 standard.	<ul style="list-style-type: none"> • “Creating Fluid Pop-up Menus” (Fluid User Interface Developer’s Guide) • Navigating Fluid Pop-up Menus Using Keyboard Shortcuts
PIA Core Technology	Ability to create sectional tabs with keyboard navigation per WCAG 2.0 standard.	<ul style="list-style-type: none"> • “Creating Sectional Tabs on a Page” (Fluid User Interface Developer’s Guide) • Navigating Fluid Sectional Tabs Using Keyboard Shortcuts
PIA Core Technology	In the navigation bar (NavBar), pressing the Tab key moves the focus through the three sections of the NavBar - the Header, the Navigation List, and the Content Area.	Using the Keyboard with the NavBar

PeopleTools 8.58 Accessibility Improvements

This table describes accessibility improvements for release 8.58 by product area:

Product Area	Improvement	PeopleBook Cross-References for More Information
PIA Core Technology	The ErrorDisplay property of the Field class allows an application developer to highlight one or more fields that are, according to the business rules of the application, in error so that the error condition is rendered, styled, and tagged to standards that work with assistive technology. PeopleTools already automatically performs this rendering, styling, and tagging of FieldEdit errors. Therefore, the ErrorDisplay property can be useful in other scenarios, such as SaveEdit, when one or more fields needs to be marked as in error.	“ErrorDisplay” (PeopleCode API Reference)

PeopleTools 8.59 Accessibility Improvements

This table describes accessibility improvements for release 8.59 by product area:

Product Area	Improvement	PeopleBook Cross-References for More Information
Portal Technology	Ability to set the screen reader mode dynamically.	<ul style="list-style-type: none"> • Enabling Screen Reader Mode • “SuppressCommonActionItem” (PeopleCode API Reference)
Portal Technology	Enhancements to keyboard shortcuts in fluid and classic applications: <ul style="list-style-type: none"> • Implemented Alt + 1, Alt + 5, Alt + 7, Alt + 8, Alt + /, and Alt + ; for fluid applications. • Implemented keyboard shortcuts support for macOS. • Changed the keyboard shortcut for the Keyboard Information page to Alt + K to eliminate conflicts with JAWS and certain browsers. 	Using Keyboard Shortcuts
Fluid Homepage and NavBar	Menu folders and menu items in the Menu are displayed in alphabetical order by default for most supported languages. Keyboard navigation includes the ability to focus on and navigate between alphabetical section dividers at the root of the menu structure.	<ul style="list-style-type: none"> • “Working with the NavBar” (Applications User’s Guide) • Using the Keyboard with the NavBar
Fluid Core	Adjustments to support WCAG 2.1: 1.4.11 – Non Text Contrast.	None
Fluid Core	Adjustments to support WCAG 2.1: 1.3.5 – Identify Input Purpose.	The “HtmlAttributes” (PeopleCode API Reference) property is now supported on classic pages.

PeopleTools 8.60 Accessibility Improvements

This table describes accessibility improvements for PeopleTools 8.60 by product area:

Product Area	Improvement	PeopleBook Cross-References for More Information
Portal Technology	The Skip to Main Content link is now available on fluid pages and classic pages without requiring any configuration or a special key sequence. When you tab from the last browser control into any PeopleSoft page, the Skip to Main Content link is displayed automatically. As was the case previously, when you are on any control within any PeopleSoft page, you can still use Ctrl + Alt + S to display the Skip to Main Content link.	Using the Skip to Main Content Link
Application Designer	Application developers can use the Read only control for screen reader page field property to mark fields as read only in screen reader mode, which enables screen readers to set focus into the fields but does not allow the user to modify the value.	“Setting Use Properties” (Application Designer Developer’s Guide)

PeopleTools 8.61 Accessibility Improvements

This table describes accessibility improvements for PeopleTools 8.61 by product area:

Product Area	Improvement	PeopleBook Cross-References for More Information
PIA Core Technology: Fluid User Interface	<p>Added the new Accessibility button feature in Fluid pages which includes:</p> <ul style="list-style-type: none"> The Accessibility button on the quick access bar which allows users to enable screen reader mode and to view keyboard shortcuts and additional Accessibility Help information configured by administrators. The Define Accessibility Help page which enables administrators to view and configure the Accessibility Help information. 	Using the Accessibility Button in Fluid