

---

# PeopleTools 8.62: Lifecycle Management Guide

---

**April 2025**

This software and related documentation are provided under a license agreement containing restrictions on use and disclosure and are protected by intellectual property laws. Except as expressly permitted in your license agreement or allowed by law, you may not use, copy, reproduce, translate, broadcast, modify, license, transmit, distribute, exhibit, perform, publish, or display any part, in any form, or by any means. Reverse engineering, disassembly, or decompilation of this software, unless required by law for interoperability, is prohibited.

The information contained herein is subject to change without notice and is not warranted to be error-free. If you find any errors, please report them to us in writing.

If this is software, software documentation, data (as defined in the Federal Acquisition Regulation), or related documentation that is delivered to the U.S. Government or anyone licensing it on behalf of the U.S. Government, then the following notice is applicable:

U.S. GOVERNMENT END USERS: Oracle programs (including any operating system, integrated software, any programs embedded, installed, or activated on delivered hardware, and modifications of such programs) and Oracle computer documentation or other Oracle data delivered to or accessed by U.S. Government end users are "commercial computer software," "commercial computer software documentation," or "limited rights data" pursuant to the applicable Federal Acquisition Regulation and agency-specific supplemental regulations. As such, the use, reproduction, duplication, release, display, disclosure, modification, preparation of derivative works, and/or adaptation of i) Oracle programs (including any operating system, integrated software, any programs embedded, installed, or activated on delivered hardware, and modifications of such programs), ii) Oracle computer documentation and/or iii) other Oracle data, is subject to the rights and limitations specified in the license contained in the applicable contract. The terms governing the U.S. Government's use of Oracle cloud services are defined by the applicable contract for such services. No other rights are granted to the U.S. Government.

This software or hardware is developed for general use in a variety of information management applications. It is not developed or intended for use in any inherently dangerous applications, including applications that may create a risk of personal injury. If you use this software or hardware in dangerous applications, then you shall be responsible to take all appropriate fail-safe, backup, redundancy, and other measures to ensure its safe use. Oracle Corporation and its affiliates disclaim any liability for any damages caused by use of this software or hardware in dangerous applications.

Oracle®, Java, MySQL, and NetSuite are registered trademarks of Oracle and/or its affiliates. Other names may be trademarks of their respective owners.

Intel and Intel Inside are trademarks or registered trademarks of Intel Corporation. All SPARC trademarks are used under license and are trademarks or registered trademarks of SPARC International, Inc. AMD, Epyc, and the AMD logo are trademarks or registered trademarks of Advanced Micro Devices. UNIX is a registered trademark of The Open Group.

This software or hardware and documentation may provide access to or information about content, products, and services from third parties. Oracle Corporation and its affiliates are not responsible for and expressly disclaim all warranties of any kind with respect to third-party content, products, and services unless otherwise set forth in an applicable agreement between you and Oracle. Oracle Corporation and its affiliates will not be responsible for any loss, costs, or damages incurred due to your access to or use of third-party content, products, or services, except as set forth in an applicable agreement between you and Oracle.

## **Documentation Accessibility**

For information about Oracle's commitment to accessibility, visit the Oracle Accessibility Program website at <https://docs.oracle.com/pls/topic/lookup?ctx=acc&id=docacc>.

## **Access to Oracle Support**

Oracle customers that have purchased support have access to electronic support through My Oracle Support. For information, visit <https://docs.oracle.com/pls/topic/lookup?ctx=acc&id=info> or visit <https://docs.oracle.com/pls/topic/lookup?ctx=acc&id=trs> if you are hearing impaired.

# Contents

- Preface: Preface.....xi**
- Understanding the PeopleSoft Online Help and PeopleBooks..... xi
- Hosted PeopleSoft Online Help..... xi
- Locally Installed PeopleSoft Online Help..... xi
- Downloadable PeopleBook PDF Files.....xi
- Common Help Documentation.....xi
- Field and Control Definitions..... xii
- Typographical Conventions..... xii
- ISO Country and Currency Codes..... xiii
- Region and Industry Identifiers..... xiii
- Translations and Embedded Help..... xiv
- Using and Managing the PeopleSoft Online Help..... xiv
- PeopleTools Related Links..... xiv
- Contact Us..... xiv
- Follow Us..... xv
- Chapter 1: Getting Started with Application Designer's Lifecycle Management Features.....17**
- PeopleSoft Application Designer Implementation..... 17
- Other Sources of Information..... 17
- Chapter 2: Upgrading with PeopleSoft Application Designer..... 19**
- Understanding a PeopleSoft Upgrade.....19
- PeopleSoft Application Designer Upgrade Features..... 19
- Definition Types That You Can Upgrade..... 20
- Using the Upgrade Workspace..... 20
- Switching to the Upgrade View..... 20
- Viewing Upgrade Attributes by Definition Type..... 21
- Working with Upgrade Definition Columns..... 22
- Using Upgrade Menu Actions..... 22
- Setting Upgrade Options..... 24
- Preparing Projects for an Upgrade..... 37
- Understanding Upgrade Projects..... 37
- Populating Projects..... 37
- Searching for Definitions..... 38
- Printing All Definitions in a Project..... 38
- Obtaining Access for Upgrading..... 38
- Viewing Upgrade Messages..... 38
- Understanding Upgrade Messages..... 38
- Determining Whether Errors Were Encountered..... 38
- Viewing Messages..... 39
- Printing Upgrade Messages..... 39
- Clearing Messages..... 39
- Chapter 3: Comparing Source and Target Definitions.....41**
- Understanding the Compare Process..... 41
- Comparing All Definitions by Type..... 42
- Comparing Definitions by Project..... 42
- Synchronizing Databases When Comparing Record Definitions..... 42
- Working With Compare Reports..... 44

|   |           |
|---|-----------|
| Running a Compare Report.....   | 44        |
| Working with the Compare and Report Dialog Box.....                                 | 46        |
| Working With Workspace Reports.....   | 48        |
| Accessing Reports.....  | 48        |
| Searching for Definitions in Reports.....   | 48        |
| Navigating the Differences in a Compare Report.....                                 | 49        |
| Printing the Report.....  | 50        |
| Saving Reports as Text Files.....   | 51        |
| Working with Browser Reports.....   | 51        |
| Understanding Browser Reports.....  | 51        |
| Accessing and Sharing Browser Reports.....  | 52        |
| Selecting a Project.....  | 53        |
| Searching for Definitions.....  | 53        |
| Viewing Report Details.....   | 54        |
| Viewing Status Summary.....   | 54        |
| Viewing Compare Results by Definition Type.....                                     | 55        |
| Working With PrintProject Reports.....  | 56        |
| Accessing the PrintProject Report.....  | 58        |
| Working with Composite Reports.....   | 58        |
| Understanding Composite Reports.....  | 58        |
| Generating Composite Reports.....   | 59        |
| Working With Composite Report Output.....   | 60        |
| Example: Creating a Composite Report.....   | 61        |
| Working with Definition Status.....   | 63        |
| Determining Definition Status.....  | 63        |
| Comparing Source Status to Target Status.....                                       | 64        |
| Comparing and Merging Page Definitions.....   | 66        |
| Comparing and Merging Page Definitions.....   | 67        |
| Working with the Page Compare Results.....  | 67        |
| <b>Chapter 4: Working with Text Definitions and Text Files During Upgrades.....</b> | <b>73</b> |
| Understanding Comparing Text Definitions and Text Files.....                        | 73        |
| Comparing and Merging Text Definitions and Files.....                               | 73        |
| Running the Merge Process for Text Definitions.....                                 | 74        |
| Running the Merge Process for External Text Files.....                              | 74        |
| Using the Merge Interface.....  | 75        |
| Working with Merge Properties.....  | 78        |
| Accessing the Merge Properties Dialog Box.....                                      | 78        |
| Viewing and Setting Merge Properties.....   | 78        |
| Running a Project PeopleCode Diff/Merge.....  | 81        |
| Understanding the Project PeopleCode Diff/Merge.....                                | 81        |
| Running a Project PeopleCode Diff/Merge.....  | 81        |
| Using the Project PeopleCode Diff/Merge.....  | 81        |
| Filtering the Project PeopleCode Diff List.....                                     | 82        |
| <b>Chapter 5: Copying Projects and Definitions.....</b>                             | <b>83</b> |
| Reviewing Upgrade Settings.....   | 83        |
| Selecting View Options.....   | 83        |
| Selecting Custom View Settings.....   | 83        |
| Overriding Upgrade Defaults.....  | 84        |
| Recording Upgrade Settings.....   | 86        |
| Copying Projects.....   | 86        |
| Understanding Project Copy Options.....   | 87        |

|  |            |
|--|------------|
| Copying Projects to a Target Database.....                                 | 87         |
| Copying a Project to Multiple Databases.....                               | 88         |
| Copying a Project to a File.....   | 88         |
| Copying a Project From a File.....   | 89         |
| Stamping the Target Database.....  | 93         |
| Reusing Projects.....  | 93         |
| <b>Chapter 6: Working With Alter Analyzer.....</b>                         | <b>97</b>  |
| Understanding the Alter Analyzer.....                                      | 97         |
| Loading Metadata.....  | 98         |
| Running the Alter Analyzer.....  | 99         |
| Working with the Alter Repository.....                                     | 99         |
| Understanding the Alter Repository.....                                    | 99         |
| PS_PTUALTRECADATA Table.....   | 99         |
| PS_PTUALTRECFLDDAT Table.....  | 100        |
| PS_PTUALTRECFLDDEF Table.....  | 103        |
| Querying The Alter Repository.....   | 104        |
| <b>Chapter 7: Using Command Line Parameters.....</b>                       | <b>107</b> |
| Understanding PeopleSoft Application Designer Command Line Parameters..... | 107        |
| Command Line Option Sequence.....  | 107        |
| Command Line Parameters.....   | 108        |
| Required and Optional Parameters Matrix.....                               | 108        |
| Available Parameters for the Various Functions.....                        | 112        |
| Starting the PeopleSoft Application Designer Command Line Interface.....   | 125        |
| Building Projects Using the Command Line.....                              | 126        |
| Creating Projects Using the Command Line.....                              | 127        |
| Creating Customization Project Using the Command Line.....                 | 128        |
| Copying Definitions Using the Command Line.....                            | 130        |
| Merging Projects Using the Command Line.....                               | 132        |
| Comparing Definitions for Upgrade Using the Command Line.....              | 132        |
| Compiling and Saving Directive PeopleCode.....                             | 134        |
| <b>Chapter 8: Getting Started with Application Data Sets.....</b>          | <b>135</b> |
| Application Data Set Overview.....   | 135        |
| Application Data Sets (ADS).....   | 135        |
| Data Migration Workbench.....  | 137        |
| Main Components.....   | 137        |
| Application Data Set Integration with PeopleSoft Update Manager.....       | 138        |
| Deployment of Application Data Using Application Data Sets.....            | 138        |
| Application Data Set Implementation.....                                   | 140        |
| Application Data Set Limitations and Recommendations.....                  | 141        |
| <b>Chapter 9: Using Application Data Set Designer.....</b>                 | <b>143</b> |
| Creating and Editing Data Set Definition.....                              | 143        |
| Searching For and Creating Data Sets.....                                  | 143        |
| Defining the Data Set.....   | 144        |
| Cloning a Data Set Definition.....   | 150        |
| Defining Relations.....  | 150        |
| Defining Groups.....   | 155        |
| Defining Data Set Properties.....  | 156        |
| Defining Extension.....  | 158        |
| CustomValidate.....  | 160        |
| DoTransform.....   | 160        |
| CustomTransform.....   | 161        |

|  |            |
|--|------------|
| CustomMerge.....   | 162        |
| Flow for the To File Process.....                              | 162        |
| Flow for the From File Processes.....                          | 162        |
| <b>Chapter 10: Understanding ADS Projects.....</b>             | <b>165</b> |
| Understanding ADS Projects.....                                | 165        |
| Searching for, Adding and Deleting Projects.....               | 165        |
| Defining ADS Project.....                                      | 167        |
| Defining Data Set Content.....                                 | 170        |
| Inserting Data Content.....                                    | 171        |
| Using Operators to Build the WHERE Clause.....                 | 174        |
| Adding Data Set Instances from Object Designer Pages.....      | 177        |
| <b>Chapter 11: Copying and Comparing ADS Projects.....</b>     | <b>179</b> |
| Copy Compare Overview.....                                     | 179        |
| Copy to File.....  | 179        |
| Compare.....   | 179        |
| Using Compare Viewer.....                                      | 181        |
| Copy from File.....  | 181        |
| Managing ADS Project File Locations.....                       | 181        |
| Copying Project to File.....                                   | 182        |
| Loading Project from File.....                                 | 184        |
| Defining the Data Set Definition on the Target Database.....   | 184        |
| Loading Project on Target Database.....                        | 184        |
| Comparing ADS Projects.....                                    | 185        |
| Tracked ADS Definitions.....                                   | 185        |
| Comparing From File.....                                       | 185        |
| Compare Options.....   | 187        |
| Removing Project Compare Sessions.....                         | 190        |
| Viewing Compare Reports.....                                   | 191        |
| Viewing Data Set Content.....                                  | 194        |
| Understanding Status.....                                      | 196        |
| Understanding Copy Actions.....                                | 196        |
| Understanding Upgrade Action.....                              | 197        |
| Compare Report Details.....                                    | 198        |
| Using ADS-MO Unified Compare Review.....                       | 202        |
| Viewing ADS-MO Unified Compare Review.....                     | 203        |
| Viewing the Managed Objects Content.....                       | 204        |
| Viewing Data Set Content.....                                  | 207        |
| Viewing Validation Reports.....                                | 208        |
| Submitting for Copy.....                                       | 210        |
| <b>Chapter 12: Validating Data Sets.....</b>                   | <b>213</b> |
| Understanding Data Set Validation.....                         | 213        |
| Checking Integrity.....  | 215        |
| Validating From File.....                                      | 216        |
| <b>Chapter 13: Running ADS Summary Report.....</b>             | <b>219</b> |
| Running ADS Summary Report.....                                | 219        |
| Data Set Summary Report Page.....                              | 219        |
| <b>Chapter 14: Working With ADS Administrator Reports.....</b> | <b>225</b> |
| Understanding ADS Administrator Reports.....                   | 225        |
| Security Reports.....  | 225        |
| Metadata Reports.....  | 226        |
| Running ADS Administrator Reports.....                         | 226        |

|  |            |
|--|------------|
| Administrator Reports Search Page.....                                   | 227        |
| Report Definition Page.....  | 228        |
| <b>Chapter 15: Implementing Data Set Security.....</b>                   | <b>229</b> |
| Understanding Data Set Security.....                                     | 229        |
| Assigning Data Set Permissions to Users.....                             | 230        |
| Setting ADS Project File Permissions for UNIX Users.....                 | 231        |
| Setting Data Migration Permissions.....                                  | 232        |
| Defining Access Group Permissions.....                                   | 232        |
| Defining Copy Compare Report Permission.....                             | 234        |
| Setting Upgrade Permissions.....   | 236        |
| Setting PeopleTools Data Access.....                                     | 237        |
| Encrypting Data Set Project Files.....                                   | 239        |
| Setting Up Approval Framework for Data Migration.....                    | 240        |
| Assigning Data Migration Roles.....                                      | 240        |
| Defining Workflow for User Profile.....                                  | 240        |
| Creating and Maintaining User List Definition.....                       | 241        |
| Setting up the Approval Process for Data Migration.....                  | 241        |
| Scheduling and Approving Copy from File.....                             | 244        |
| Submitting for Copy using Approval Framework.....                        | 244        |
| Approving a Copy Request.....  | 245        |
| <b>Chapter 16: Running PeopleTools Configuration Reports.....</b>        | <b>249</b> |
| Understanding PeopleTools Configuration Reports.....                     | 249        |
| Generating SQR Reports.....  | 250        |
| Generating SQR Reports from Process Scheduler.....                       | 250        |
| Generating SQR Reports from the Isolated Customization Reports Page..... | 252        |
| <b>Chapter 17: Using PeopleSoft Data Mover.....</b>                      | <b>255</b> |
| Understanding PeopleSoft Data Mover.....                                 | 255        |
| PeopleSoft Data Mover Overview.....                                      | 255        |
| PeopleSoft Data Mover Environment.....                                   | 255        |
| PeopleSoft Data Mover Operating Modes.....                               | 256        |
| Understanding Data Mover Scripts.....                                    | 256        |
| Data Mover Script Commands.....  | 256        |
| Supported SQL Commands.....  | 258        |
| Data Mover Commands Compared to SQL Commands.....                        | 260        |
| PeopleSoft Data Mover COMMIT Statements.....                             | 261        |
| Using the Development Environment.....                                   | 262        |
| Signing In to the Development Environment.....                           | 262        |
| Navigating the Data Mover Window.....                                    | 262        |
| Creating and Running PeopleSoft Data Mover Scripts.....                  | 263        |
| Understanding Command Types.....   | 263        |
| Understanding Syntax Rules.....  | 263        |
| Creating and Editing Scripts.....  | 265        |
| Preparing to Run Export Scripts.....                                     | 266        |
| Running Scripts.....   | 267        |
| Using the Database Setup Utility.....                                    | 268        |
| Accessing the Database Setup Utility.....                                | 268        |
| Working with the Database Setup Utility.....                             | 268        |
| Checking the Generated Script.....                                       | 271        |
| Using the PeopleSoft Data Mover Command-Line Interface.....              | 271        |
| Understanding the PeopleSoft Data Mover Command-Line Interface.....      | 271        |
| Setting Up UNIX to Run PeopleSoft Data Mover.....                        | 272        |

|   |     |
|---|-----|
| Setting Up Tracing.....                               | 273 |
| Running Data Mover Scripts from the Command Line..... | 274 |
| Using PeopleSoft Data Mover Commands.....             | 277 |
| CHANGE_ACCESS_PASSWORD.....                           | 278 |
| CREATE_SEQUENCE.....                                  | 278 |
| CREATE_TEMP_TABLE.....                                | 279 |
| CREATE_TRIGGER.....                                   | 279 |
| ENCRYPT_PASSWORD.....                                 | 279 |
| EXPORT.....   | 280 |
| IMPORT.....   | 281 |
| REM, REMARK, and --.....                              | 283 |
| RENAME.....   | 283 |
| REPLACE_ALL.....                                      | 285 |
| REPLACE_DATA.....                                     | 286 |
| REPLACE_VIEW.....                                     | 286 |
| RUN.....  | 287 |
| SET.....  | 287 |
| SET BASE_LANGUAGE.....                                | 288 |
| SET IGNORE_IMPORT_ERRORS.....                         | 288 |
| SET IGNORE_SPLCHARS.....                              | 289 |
| SET COMMIT.....                                       | 289 |
| SWAP_BASE_LANGUAGE.....                               | 290 |
| Using PeopleSoft Data Mover Command Modifiers.....    | 291 |
| AS.....   | 291 |
| IGNORE_DUPS.....                                      | 292 |
| UPDATE_DUPS.....                                      | 293 |
| WHERE.....  | 293 |
| Using SET Parameters.....                             | 294 |
| COMMIT.....   | 294 |
| CREATE_INDEX_BEFORE_DATA.....                         | 294 |
| DBSPACE.....  | 295 |
| ENABLE_DB2UTS.....                                    | 296 |
| DDL.....  | 296 |
| EXECUTE_SQL.....                                      | 297 |
| EXTRACT.....  | 297 |
| IGNORE_DUPS.....                                      | 298 |
| INPUT.....  | 298 |
| INSERT_DATA_ONCE.....                                 | 299 |
| LOG.....  | 299 |
| NO DATA.....  | 300 |
| NO INDEX.....   | 300 |
| NO RECORD.....  | 300 |
| NO SPACE.....   | 301 |
| NO TRACE.....   | 301 |
| NO VIEW.....  | 302 |
| OUTPUT.....   | 302 |
| OUTPUTDb2DBDDL.....                                   | 302 |
| OUTPUTDb2UTSDDL.....                                  | 303 |
| SET Db2DBDDL.....                                     | 303 |
| SET Db2UTSDDL.....                                    | 304 |
| SIZING SET.....                                       | 304 |

SPACE..... 305

START..... 305

STATISTICS..... 306

UNICODE..... 306

VERSION..... 307

Using Script Examples..... 307

    Exporting Databases..... 307

    Building Databases..... 307

    Recreating All Views..... 308

    Importing with REPLACE\_ALL with a Commit Level..... 308

    Combining SQL Commands and IMPORT..... 308



# Preface

---

## Understanding the PeopleSoft Online Help and PeopleBooks

The PeopleSoft Online Help is a website that enables you to view all help content for PeopleSoft applications and PeopleTools. The help provides standard navigation and full-text searching, as well as context-sensitive online help for PeopleSoft users.

### Hosted PeopleSoft Online Help

You can access the hosted PeopleSoft Online Help on the [Oracle Help Center](#). The hosted PeopleSoft Online Help is updated on a regular schedule, ensuring that you have access to the most current documentation. This reduces the need to view separate documentation posts for application maintenance on My Oracle Support. The hosted PeopleSoft Online Help is available in English only.

To configure the context-sensitive help for your PeopleSoft applications to use the Oracle Help Center, see [Configuring Context-Sensitive Help Using the Hosted Online Help Website](#).

### Locally Installed PeopleSoft Online Help

If you're setting up an on-premises PeopleSoft environment, and your organization has firewall restrictions that prevent you from using the hosted PeopleSoft Online Help, you can install the online help locally. Installable PeopleSoft Online Help is made available with selected PeopleSoft Update Images and with PeopleTools releases for on-premises installations, through the [Oracle Software Delivery Cloud](#).

Your installation documentation includes a chapter with instructions for how to install the online help for your business environment, and the documentation zip file may contain a README.txt file with additional installation instructions. See *PeopleSoft 9.2 Application Installation* for your database platform, "Installing PeopleSoft Online Help."

To configure the context-sensitive help for your PeopleSoft applications to use a locally installed online help website, see [Configuring Context-Sensitive Help Using a Locally Installed Online Help Website](#).

### Downloadable PeopleBook PDF Files

You can access downloadable PDF versions of the help content in the traditional PeopleBook format on the [Oracle Help Center](#). The content in the PeopleBook PDFs is the same as the content in the PeopleSoft Online Help, but it has a different structure and it does not include the interactive navigation features that are available in the online help.

### Common Help Documentation

Common help documentation contains information that applies to multiple applications. The two main types of common help are:

- Application Fundamentals

- Using PeopleSoft Applications

Most product families provide a set of application fundamentals help topics that discuss essential information about the setup and design of your system. This information applies to many or all applications in the PeopleSoft product family. Whether you are implementing a single application, some combination of applications within the product family, or the entire product family, you should be familiar with the contents of the appropriate application fundamentals help. They provide the starting points for fundamental implementation tasks.

In addition, the *PeopleTools: Applications User's Guide* introduces you to the various elements of the PeopleSoft Pure Internet Architecture. It also explains how to use the navigational hierarchy, components, and pages to perform basic functions as you navigate through the system. While your application or implementation may differ, the topics in this user's guide provide general information about using PeopleSoft applications.

## Field and Control Definitions

PeopleSoft documentation includes definitions for most fields and controls that appear on application pages. These definitions describe how to use a field or control, where populated values come from, the effects of selecting certain values, and so on. If a field or control is not defined, then it either requires no additional explanation or is documented in a common elements section earlier in the documentation. For example, the Date field rarely requires additional explanation and may not be defined in the documentation for some pages.

## Typographical Conventions

The following table describes the typographical conventions that are used in the online help.

| <b><i>Typographical Convention</i></b> | <b><i>Description</i></b>   |
|--|---|
| <b>Key+Key</b>                         | Indicates a key combination action. For example, a plus sign (+) between keys means that you must hold down the first key while you press the second key. For <b>Alt+W</b> , hold down the <b>Alt</b> key while you press the <b>W</b> key. |
| ... (ellipses)                         | Indicate that the preceding item or series can be repeated any number of times in PeopleCode syntax.  |
| { } (curly braces)                     | Indicate a choice between two options in PeopleCode syntax. Options are separated by a pipe ( ).  |
| [ ] (square brackets)                  | Indicate optional items in PeopleCode syntax.   |
| & (ampersand)                          | When placed before a parameter in PeopleCode syntax, an ampersand indicates that the parameter is an already instantiated object.<br><br>Ampersands also precede all PeopleCode variables.  |

| <b>Typographical Convention</b> | <b>Description</b>   |
|---------------------------------|--|
| ⇒                               | This continuation character has been inserted at the end of a line of code that has been wrapped at the page margin. The code should be viewed or entered as a single, continuous line of code without the continuation character. |

## ISO Country and Currency Codes

PeopleSoft Online Help topics use International Organization for Standardization (ISO) country and currency codes to identify country-specific information and monetary amounts.

ISO country codes may appear as country identifiers, and ISO currency codes may appear as currency identifiers in your PeopleSoft documentation. Reference to an ISO country code in your documentation does not imply that your application includes every ISO country code. The following example is a country-specific heading: "(FRA) Hiring an Employee."

The PeopleSoft Currency Code table (CURRENCY\_CD\_TBL) contains sample currency code data. The Currency Code table is based on ISO Standard 4217, "Codes for the representation of currencies," and also relies on ISO country codes in the Country table (COUNTRY\_TBL). The navigation to the pages where you maintain currency code and country information depends on which PeopleSoft applications you are using. To access the pages for maintaining the Currency Code and Country tables, consult the online help for your applications for more information.

## Region and Industry Identifiers

Information that applies only to a specific region or industry is preceded by a standard identifier in parentheses. This identifier typically appears at the beginning of a section heading, but it may also appear at the beginning of a note or other text.

Example of a region-specific heading: "(Latin America) Setting Up Depreciation"

### Region Identifiers

Regions are identified by the region name. The following region identifiers may appear in the PeopleSoft Online Help:

- Asia Pacific
- Europe
- Latin America
- North America

### Industry Identifiers

Industries are identified by the industry name or by an abbreviation for that industry. The following industry identifiers may appear in the PeopleSoft Online Help:

- USF (U.S. Federal)

- E&G (Education and Government)

## Translations and Embedded Help

PeopleSoft 9.2 software applications include translated embedded help. With the 9.2 release, PeopleSoft aligns with the other Oracle applications by focusing our translation efforts on embedded help. We are not planning to translate our traditional online help and PeopleBooks documentation. Instead we offer very direct translated help at crucial spots within our application through our embedded help widgets. Additionally, we have a one-to-one mapping of application and help translations, meaning that the software and embedded help translation footprint is identical—something we were never able to accomplish in the past.

---

## Using and Managing the PeopleSoft Online Help

Select About This Help in the left navigation panel on any page in the PeopleSoft Online Help to see information on the following topics:

- Using the PeopleSoft Online Help.
- Managing hosted Online Help.
- Managing locally installed PeopleSoft Online Help.

---

## PeopleTools Related Links

[PeopleTools 8.62 Home Page](#)

[PeopleSoft Search and Insights Home Page](#)

“PeopleTools Product/Feature PeopleBook Index” (Getting Started with PeopleTools)

[PeopleSoft Online Help](#)

[PeopleSoft Information Portal](#)

[PeopleSoft Spotlight Series](#)

[PeopleSoft Training and Certification | Oracle University](#)

[My Oracle Support](#)

[Oracle Help Center](#)

---

## Contact Us

Send your suggestions to [pssoft-infodev\\_us@oracle.com](mailto:pssoft-infodev_us@oracle.com).

Please include the applications update image or PeopleTools release that you’re using.

---

## Follow Us

| <i>Icon</i>   | <i>Link</i>  |
|---|--|
|  | <a href="#"><u>Watch PeopleSoft on YouTube</u></a>         |
|  | <a href="#"><u>Follow @PeopleSoft_Info on X.</u></a>       |
|  | <a href="#"><u>Read PeopleSoft Blogs</u></a>               |
|  | <a href="#"><u>Connect with PeopleSoft on LinkedIn</u></a> |



## Chapter 1

# Getting Started with Application Designer's Lifecycle Management Features

---

## PeopleSoft Application Designer Implementation

Before you can begin using PeopleSoft Application Designer, the following items must be in place.

| <i>Activity</i>      | <i>Description</i>  |
|----------------------|---|
| Set up security.     | <p>For developing and customizing PeopleSoft applications you will need access to the definitions involved, such as fields, records, pages, and so on. Your administrator can provide access by adjusting your definition security settings. There are also general PeopleTools permissions for maintaining and upgrading data that your administrator may need to provide access to as well. These include Build and Data Administration, Change Control, and Upgrade.</p> <p>See “Setting PeopleTools Permissions” (Security Administration)</p> <p>See “Understanding Definition Security” (Security Administration)</p> |
| Set up workstations. | <p>PeopleSoft Application Designer is a windows-based program. To run PeopleSoft Application Designer, you need to have a supported version of Windows with ample CPU and memory resources, and you need to have the workstation configured using PeopleSoft Configuration Manager so that there is connectivity to the appropriate database and all required environment variables are set.</p> <p>See “Setting Up the PeopleTools Development Environment” (System and Server Administration)</p>   |

---

## Other Sources of Information

This section provides information to consider before you begin to use PeopleSoft Application Designer. In addition to implementation considerations presented in this section, take advantage of all PeopleSoft sources of information, including the installation guides, release notes, PeopleBooks, and training courses.

### Related Links

Getting Started with PeopleTools

Change Assistant and Update Manager  
Change Impact Analyzer

## Chapter 2

# Upgrading with PeopleSoft Application Designer

---

## Understanding a PeopleSoft Upgrade

This section provides an overview of PeopleSoft upgrade.

## PeopleSoft Application Designer Upgrade Features

PeopleSoft Application Designer streamlines the migration of database definitions—such as records, pages, projects, and PeopleCode—from one PeopleSoft database to another. You can perform a complete database upgrade or you can upgrade only the definitions included in a particular project. This topic focuses mainly on project upgrades, and the PeopleSoft upgrade documentation focuses on complete database upgrades, which are typically performed when upgrading from one version of a PeopleSoft application to another.

While this topic does not discuss the specific procedures for an enterprise-wide upgrade for a specific platform, there are basic steps to perform in PeopleSoft Application Designer regardless of the type of upgrade, which include:

- Updating your PeopleSoft software.
- Identifying the source and target database. The source can be a file, a project, or an entire database.
- Comparing the source and target database to determine changed definitions.
- Copy any new or changed definitions into your database and adjust all your system components—such as application data, SQL tables, indexes, views, and so on—accordingly.

Updating the PeopleSoft software is covered in the installation documentation for PeopleTools and PeopleSoft applications. This topic mainly focuses on comparing your source with your target and copying the definitions from the source to the target.

When comparing your source and target you can view results in the upgrade workspace, in reports, in your browser, and side-by-side (for pages and text definitions, such as PeopleCode). When copying definitions into the target database you can use the PeopleSoft Application Designer interface or a command line interface. For text definitions you can use the merge feature.

---

**Note:** The complexity of these tasks performed depends on the type of upgrade you are performing. For example, if you are copying brand new definitions from a small project into a source database this is a relatively uncomplicated task, as comparisons are not required and you can immediately begin a copy. However, if you are upgrading an entire database or a large project containing numerous changed definitions it is likely that the compare, merge, or copy process will require more analysis.

---

---

**Note:** To use the PeopleSoft Application Designer upgrade features, you must have full access to projects and upgrade access in the target database. To run a compare you only need read-only upgrade access.

---

### Related Links

“Setting PeopleTools Permissions” (Security Administration)  
Security Administration

## Definition Types That You Can Upgrade

PeopleTools managed objects can be compared and can be copied to a file or to database, with the exception of those in the following list.

These definitions can be copied to database, but cannot be compared and cannot be copied to file:

- Dimensions
- Cube definitions
- Cube instance definitions

---

**Note:** Certain definition types that are specified as compare and copy or copy only (for example, Cube Dimensions) do not appear on the Development tab because you cannot edit them in PeopleSoft Application Designer.

---

---

**Note:** PeopleSoft delivered definition types (such as pages, Application Engine programs, iScript PeopleCode, and so on) cannot be copied across product lines. For example, you cannot copy a definition from PeopleSoft Human Capital Management to PeopleSoft Customer Relationship Management. License codes for these definitions are specific to the product line in which the definition is delivered. If a PeopleSoft delivered definition is copied to a different product line, it may be inaccessible on the target database.

---

---

## Using the Upgrade Workspace

This section provides an overview of using the upgrade workspace.

### Switching to the Upgrade View

When you perform an upgrade with PeopleSoft Application Designer, select the Upgrade tab at the bottom of the project workspace to switch to the upgrade view.

The upgrade view of the project workspace shows all of the definition types in the project that are available for upgrade—not only those that PeopleSoft Application Designer can modify, as in the development view. The upgrade definition window displays the definitions in the project and their upgrade settings. One definition type appears at a time.

Displayed here are the upgrade attributes for all record definitions in the selected project.

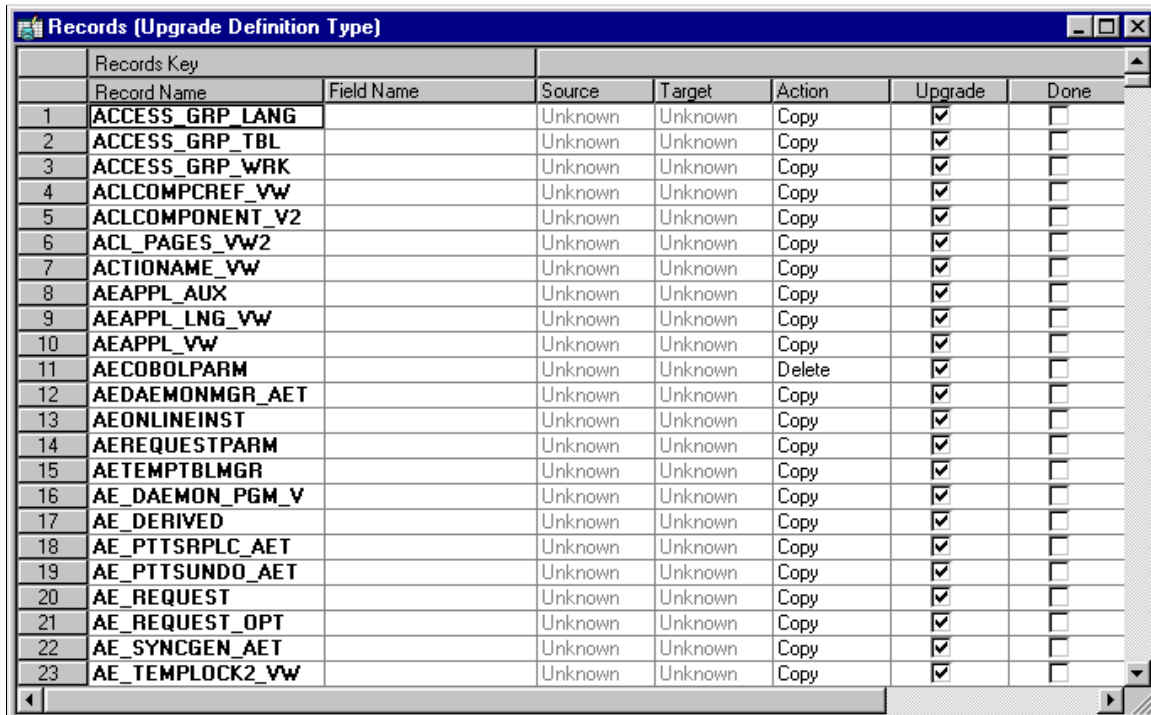

| Records (Upgrade Definition Type) |                 |            |         |         |        |                                     |                          |
|-----------------------------------|-----------------|------------|---------|---------|--------|-------------------------------------|--------------------------|
| Records Key                       |                 |            |         |         |        |                                     |                          |
|                                   | Record Name     | Field Name | Source  | Target  | Action | Upgrade                             | Done                     |
| 1                                 | ACCESS_GRP_LANG |            | Unknown | Unknown | Copy   | <input checked="" type="checkbox"/> | <input type="checkbox"/> |
| 2                                 | ACCESS_GRP_TBL  |            | Unknown | Unknown | Copy   | <input checked="" type="checkbox"/> | <input type="checkbox"/> |
| 3                                 | ACCESS_GRP_WRK  |            | Unknown | Unknown | Copy   | <input checked="" type="checkbox"/> | <input type="checkbox"/> |
| 4                                 | ACLCOMPREF_VW   |            | Unknown | Unknown | Copy   | <input checked="" type="checkbox"/> | <input type="checkbox"/> |
| 5                                 | ACLCOMPONENT_V2 |            | Unknown | Unknown | Copy   | <input checked="" type="checkbox"/> | <input type="checkbox"/> |
| 6                                 | ACL_PAGES_VW2   |            | Unknown | Unknown | Copy   | <input checked="" type="checkbox"/> | <input type="checkbox"/> |
| 7                                 | ACTIONAME_VW    |            | Unknown | Unknown | Copy   | <input checked="" type="checkbox"/> | <input type="checkbox"/> |
| 8                                 | AEAPPL_AUX      |            | Unknown | Unknown | Copy   | <input checked="" type="checkbox"/> | <input type="checkbox"/> |
| 9                                 | AEAPPL_LNG_VW   |            | Unknown | Unknown | Copy   | <input checked="" type="checkbox"/> | <input type="checkbox"/> |
| 10                                | AEAPPL_VW       |            | Unknown | Unknown | Copy   | <input checked="" type="checkbox"/> | <input type="checkbox"/> |
| 11                                | AECOBOLPARM     |            | Unknown | Unknown | Delete | <input checked="" type="checkbox"/> | <input type="checkbox"/> |
| 12                                | AEDAEMONMGR_AET |            | Unknown | Unknown | Copy   | <input checked="" type="checkbox"/> | <input type="checkbox"/> |
| 13                                | AEONLINEINST    |            | Unknown | Unknown | Copy   | <input checked="" type="checkbox"/> | <input type="checkbox"/> |
| 14                                | AEREQUESTPARM   |            | Unknown | Unknown | Copy   | <input checked="" type="checkbox"/> | <input type="checkbox"/> |
| 15                                | AETEMPTBLMGR    |            | Unknown | Unknown | Copy   | <input checked="" type="checkbox"/> | <input type="checkbox"/> |
| 16                                | AE_DAEMON_PGM_V |            | Unknown | Unknown | Copy   | <input checked="" type="checkbox"/> | <input type="checkbox"/> |
| 17                                | AE_DERIVED      |            | Unknown | Unknown | Copy   | <input checked="" type="checkbox"/> | <input type="checkbox"/> |
| 18                                | AE_PTTSRPLC_AET |            | Unknown | Unknown | Copy   | <input checked="" type="checkbox"/> | <input type="checkbox"/> |
| 19                                | AE_PTTSUNDO_AET |            | Unknown | Unknown | Copy   | <input checked="" type="checkbox"/> | <input type="checkbox"/> |
| 20                                | AE_REQUEST      |            | Unknown | Unknown | Copy   | <input checked="" type="checkbox"/> | <input type="checkbox"/> |
| 21                                | AE_REQUEST_OPT  |            | Unknown | Unknown | Copy   | <input checked="" type="checkbox"/> | <input type="checkbox"/> |
| 22                                | AE_SYNCGEN_AET  |            | Unknown | Unknown | Copy   | <input checked="" type="checkbox"/> | <input type="checkbox"/> |
| 23                                | AE_TEMPLOCK2_VW |            | Unknown | Unknown | Copy   | <input checked="" type="checkbox"/> | <input type="checkbox"/> |

## Viewing Upgrade Attributes by Definition Type

To view the upgrade attributes by definition type in a project:

1. Open a project.
2. Select the Upgrade tab at the bottom of the project workspace.
3. Double-click a folder to open the upgrade definition window.

With the exception of PeopleCode, the folders in the upgrade view are not expandable. The upgrade definition window contains a grid with definitions in the project that are of the selected type. For example, if you double-click the Records folder in the upgrade view, the upgrade definition window displays the records in the project.

You can view only one upgrade definition window—and one definition type—at a time. When you double-click another definition type in the upgrade view, the upgrade definition window is refreshed with the new definitions of that type.

---

**Note:** You can filter which definitions are displayed in this window. By default, no filtering is applied.

---

## Working with Upgrade Definition Columns

The columns in the upgrade definition window display various information about each definition.

| <b>Field or Control</b> | <b>Description</b>  |
|-------------------------|---|
| <b>Key</b>              | Displays the name of the definition, plus any other key values. The number and titles of the key columns vary, depending on the definition type.  |
| <b>Source</b>           | Displays the definition status in the source (current) database.  |
| <b>Target</b>           | Displays the definition target database status.   |
| <b>Action</b>           | Displays the action that is performed if the definition is copied into the target database.   |
| <b>Upgrade</b>          | Select to upgrade the definition during a copy.   |
| <b>Done</b>             | Is selected when the definition has been copied. You can't select <b>Done</b> check boxes yourself—PeopleSoft Application Designer does this after a copy—but you can <i>clear</i> them. Only definitions that have <b>Upgrade</b> selected and <b>Done</b> cleared are copied during an upgrade. |
| Execute                 | Only applies to file references and Application Engine definitions. Allows file references and Application Engine definitions to be executed when applying a change package.  |

To enlarge the window enough so that you can scroll through the upgrade columns:

- Maximize the upgrade definition window.
- Maximize PeopleSoft Application Designer.
- Hide the project workspace.

To display *all* of the grid columns at one time when the preceding options don't enable you to see every column, use the zooming commands in the View menu. With each Zoom Out command, the grid size is reduced. To restore the normal view, select 100%.

You can also resize individual columns by dragging the column border to the appropriate size.

## Using Upgrade Menu Actions

To access the pop-up upgrade menu, right-click anywhere in the grid in the upgrade definition window.

This table describes the upgrade menu actions and the actions they perform:

| <b>Menu Item</b>                | <b>Action</b>   |
|---------------------------------|---|
| View Definition                 | Opens the definition. This is enabled for definitions created in Application Designer.  |
| View PeopleCode                 | Opens the PeopleCode Editor. This is enabled for PeopleCode definition types.   |
| Find Definition References      | Finds all references to the selected definition.  |
| Merge Definition                | Enables you to compare and merge text definitions between two sources, either a file or another database. Text definitions are PeopleCode, SQL, XSLT, and HTML. |
| Diff / Merge Page               | Enables you to compare (side-by-side) page definitions between two sources, either a file or another database, and merge the definitions.                       |
| Filtering                       | Opens a cascading menu with filtering options that you can apply to the upgrade grid. These same options are also in the View menu.                             |
| Refresh View                    | Updates the information in the upgrade definition window.   |
| Set Action                      | Enables you to select and tag definitions for copying and deleting.   |
| Set Action for Project          | Enables you to select and tag all definitions in a project for copy or delete.  |
| Tag for Upgrade                 | Enables you to tag a group of definitions for upgrade.  |
| Untag for Upgrade               | Enables you to remove the tag on a group of definitions for upgrade.  |
| Reset Done Flag                 | Enables you to reset <b>Done</b> check boxes for a group of definitions.  |
| Reset Project Done Flags        | Enables you to reset all <b>Done</b> check boxes.   |
| Insert Definitions into Project | Opens the Insert Definitions into Project dialog box.   |
| Remove from Project             | Removes the selected definitions from the current project. You can also use the <b>Delete</b> key.  |
| Project Properties              | Opens the Project Properties dialog box, in which you define properties for the project, like description.  |

## Setting Upgrade Options

This section discusses how to:

- Access the upgrade options.
- Set general options.
- Set compare options.
- Set report options.
- Set report filter options.
- Set copy options.

### Accessing the Upgrade Options

To access the upgrade options:

1. Select **Tools > Compare and Report**.
2. Select *To Database*.
3. Sign in to an upgrade target database.

This example illustrates the fields and controls on the Compare and Report page.

The screenshot shows the 'Compare and Report' dialog box. It is titled 'Compare and Report' and has a close button (X) in the top right corner. The dialog is divided into several sections:

- PeopleTools Release:** 8.58.00
- Source:**
  - Database Name: T58CD999
  - Application Release: PeopleTools 8.57.000
  - Service Pack: 0
- Target:**
  - Database Name: T58CDDMO
  - Application Release: PeopleTools 8.58.001
  - Service Pack: 0
- Project Item Status / Child Definitions:**
  - Update Project Item Status and Child Definitions
- Definition:** A list box containing 'Records', 'Components', 'Pages', and 'Record PeopleCode'. 'Records' is currently selected and highlighted in blue.
- Buttons:** 'Compare', 'Cancel', 'Options...' (highlighted with a blue border), 'Select All', and 'Deselect All'.

By default the Update Project Item Status and Child Definitions is selected.

4. On the Compare and Report dialog box, click **Options**, and select the appropriate upgrade option tab.

## Setting General Options

This example illustrates the fields and controls on the Upgrade Options dialog box: General Options tab. You can find definitions for the fields and controls later on this page.

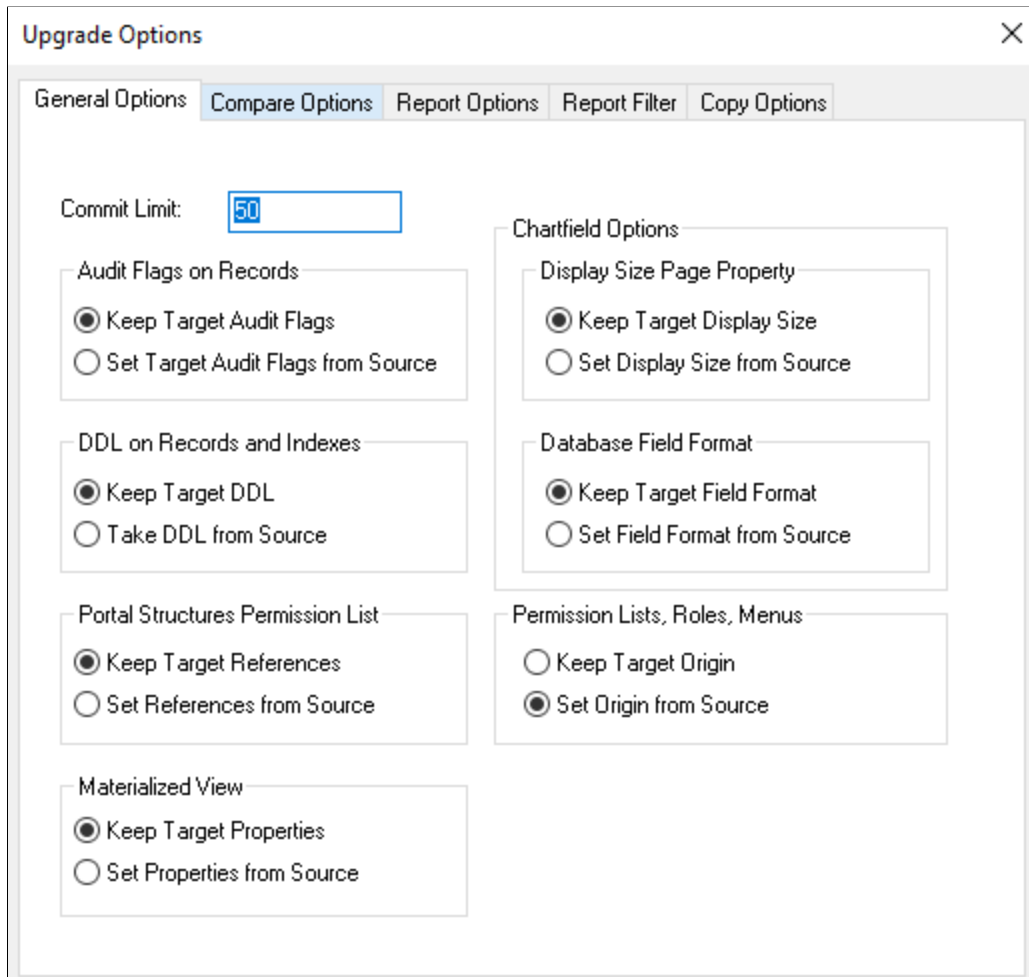

Use the Upgrade Options dialog box to set general options for the Compare or Copy process.

| <b>Field or Control</b> | <b>Description</b>   |
|-------------------------|--|
| <b>Commit Limit</b>     | <p>Set the commit limit.</p> <p>Start with the default of 50. If the Copy process seems slow and there is sufficient log file space, try increasing the commit limit. You can modify the initial project default commit limit on the PeopleTools Options page.</p> <p>Very large commit limits, however, can cause more work if something goes wrong during the copy. For example, if the commit limit is set to 1,000 and the Copy process stalls on the 999th definition, none of the previous definitions are copied. The Copy process must be performed again.</p> |

| <b>Field or Control</b>                  | <b>Description</b>  |
|--|---|
| <b>Audit Flags on Records</b>            | <p>Select one:</p> <ul style="list-style-type: none"> <li>• <b>Keep Target Audit Flags:</b> Select to preserve all of the enabled target flags. This is the default. Audit flags that are enabled in the source are also retained. Differences between the source and target audit flags are not shown on the compare report.</li> <li>• <b>Set Target Audit Flags from Source:</b> Select to copy audit flag settings from the source to the target database.</li> </ul>   |
| DDL on Records and Indexes               | <p>Select one:</p> <ul style="list-style-type: none"> <li>• <b>Keep Target DDL:</b> Select to preserve the target DDLs. This is the default. Differences between the source and target DDL are not shown on the compare report.</li> <li>• <b>Take DDL from Source:</b> Select to copy the DDL from the source to the target database.</li> </ul> <hr/> <p><b>Note:</b> For Oracle customers using partitioning on records and indexes, the partitioning is not migrated with the record or index. To migrate the partitioning use Data Migration Workbench and create a project containing the data set definition PTBLIDXPART. See “Maintaining Partition Definitions” (Data Management) and <u>Defining ADS Project</u>.</p> <hr/> |
| <b>Materialized View</b>                 | <p>Select one:</p> <ul style="list-style-type: none"> <li>• <b>Keep Target Properties:</b> Select to retain the target properties of materialized view. This is the default.</li> <li>• <b>Set Properties from Source:</b> Select to copy the materialized view properties like REFRESH_MODE, REFRESH_METHOD and BUILD_MODE from the source to the target database.</li> </ul>  |
| <b>Portal Structures Permission List</b> | <p>Select one:</p> <ul style="list-style-type: none"> <li>• <b>Keep Target References:</b> Select to preserve the target portal structures permission list references. This is the default.</li> <li>• <b>Set References from Source:</b> Select to copy the portal structures permission list references from the source to the target database.</li> </ul>  |

| <b>Field or Control</b>   | <b>Description</b>  |
|---------------------------|---|
| <b>Chartfield Options</b> | <p><b>Set the Display Size Page Property:</b></p> <ul style="list-style-type: none"> <li>• <b>Keep Target Display Size:</b> Does not copy any display changes to a ChartField on the source database (the target values are saved). If this is set for a Compare process, no differences between the source and target in the named fields are displayed. If the only differences on the page are the ChartField display properties, then the page compares as the same for both.</li> <li>• <b>Set Display Size from Source:</b> Copies the position, as well as the size and type attributes, from the source to the target database.</li> </ul> <p><b>Set the Database Field Format:</b></p> <ul style="list-style-type: none"> <li>• <b>Keep Target Field Format:</b> Does not copy any changes to the field format values for a database field that is a ChartField on the source database, and preserves the target field format values. If this is set for a Compare process, any changes to the ChartField field format attributes are not displayed. If these attributes are the only changes for a field, then the definition compares as the same for both.</li> <li>• <b>Set Field Format from Source:</b> Copies the ChartField field format attributes from the source to the target database.</li> </ul> |

| <b>Field or Control</b>              | <b>Description</b>   |
|--------------------------------------|--|
| <b>Permission List, Roles, Menus</b> | <p>If Roles, Menus or Permission Lists are renamed or cloned, this information is tracked in tables that store the original name. This information is used by PUM Security Automation when change packages are created to apply updates.</p> <p>Select one:</p> <ul style="list-style-type: none"> <li>• <b>Keep Target Origin</b><br/>           Select to preserve the tracking tables for these definitions.<br/> <hr/> <b>Note:</b> This option is primarily used for PUM updates.         </li> <li>• <b>Set Origin from Source</b><br/>           Select to overwrite the tracking tables for these definitions on the target. This is the default.<br/> <hr/> <b>Note:</b> This option is primarily used for project copies executed in Application Designer, such as development to test.         </li> </ul> <hr/> <b>Note:</b> This option applies to Upgrade Copy operation and is ignored for Upgrade Compare operation. |

## Setting Compare Options

Access the Upgrade Options dialog box and select the Compare Options tab to complete setting compare options. You can find definitions for the fields and controls later on this page.

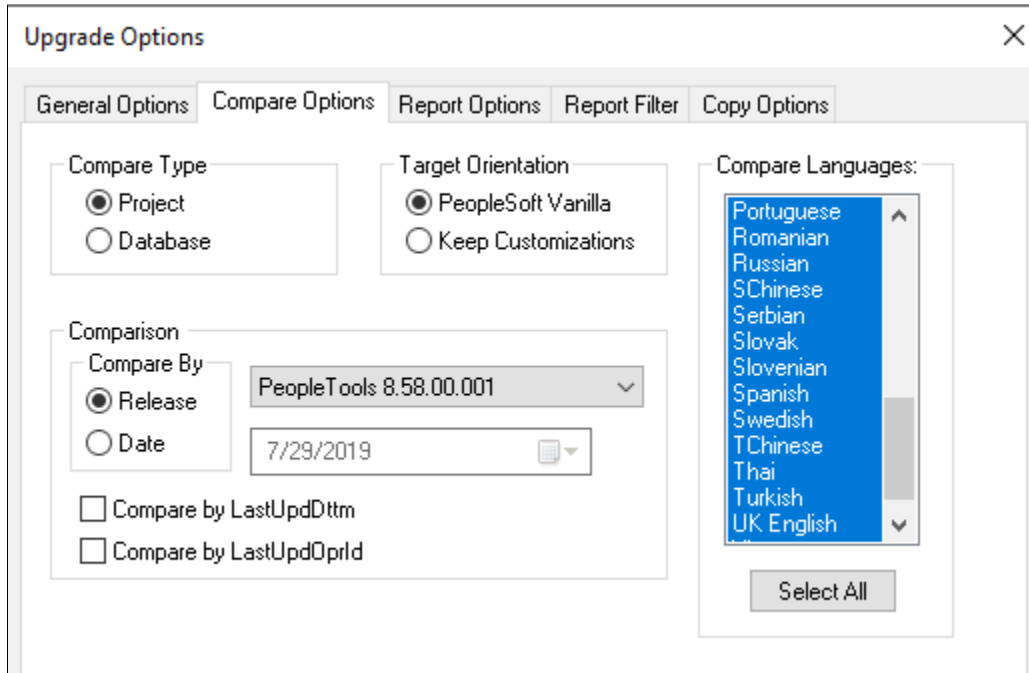

| <b>Field or Control</b>          | <b>Description</b>   |
|----------------------------------|--|
| <p><b>Compare Type</b></p>       | <p>Select <b>Project</b> to compare only the definitions of the specified definition type in the current project. The contents of the project do not change.</p> <p>Select <b>Database</b> to compare all definitions of the specified definition type. If you select <b>Database</b>, the contents of the current project are deleted and replaced with definitions that are found during the comparison.</p> |
| <p><b>Target Orientation</b></p> | <p>Determines how the <b>Upgrade</b> check boxes in the upgrade definition window are set for definitions that were last modified by the customer in one database and last modified by PeopleSoft in the other database.</p>   |

| <b>Field or Control</b>         | <b>Description</b>  |
|---------------------------------|---|
| <p><b>Comparison</b></p>        | <p>Select <b>Release</b> to compare databases by the highest release that the two databases have in common. Use the drop-down list box to select from lower common releases. The Compare process labels definitions as Changed or Custom/Changed if they have been changed since the date and time stamp for that release level. This is the default.</p> <p>Select <b>Date</b> to have the Compare process label definitions as Changed or Custom/Changed if they have been modified since the date that you specify.</p> <p>Use LastUpdDttm (last update date and time) and LastUpdOprid (last user to update definition) to improve the performance of the compare process for larger compare projects. If these options are selected, Application Designer uses only these values to assess differences between PeopleCode definitions. If it is determined that the LastUpdDttm and/or LastUpdOprid are the same, Application Designer assumes that the rest of the attributes are the same and moves on to the next definition in the project. If it is determined that the PeopleCode definitions are different, Application Designer proceeds to compare all attributes of the definition as normal.</p> <hr/> <p><b>Note:</b> LastUpdDttm and LastUpdOprid apply only to PeopleCode definitions.</p> <hr/> |
| <p><b>Compare Languages</b></p> | <p>Select the languages of definitions that you want to compare, and select <i>COMMON</i>, which specifies basic definition characteristics and parameters in the architecture that are not language-sensitive. Language options specify label-oriented characteristics of a definition, such as page names, labels, and messages. If you do not select <i>COMMON</i>, basic definition characteristics are omitted.</p> <p>If you need specific languages and basic definition characteristics, also select <i>COMMON</i>. However, to compare only language attributes of a definition, you do not need <i>COMMON</i>.</p> <p>Clicking <b>Select All</b> is the recommended default.</p> <p>Press the <b>Ctrl</b> key and your mouse to clear unwanted languages.</p>   |

| <b>Field or Control</b>  | <b>Description</b>  |
|--|---|
| <b>Checkboxes for Compare by LastUpdDttm and Compare by LastUpdOprid</b> | Since Compare by LastUpdDttm and Compare by LastUpdOprid are a customization bypass, the process will skip the comparison if LastUpdOprid = PPLSOFT or if the LastUpdDttm has the same value on both the source and target databases. |

### Setting Report Options

The following screenshot is an example showing how to set values in report options. Access the Upgrade Options dialog box and select the Report Options tab. You can find definitions for the fields and controls later on this page.

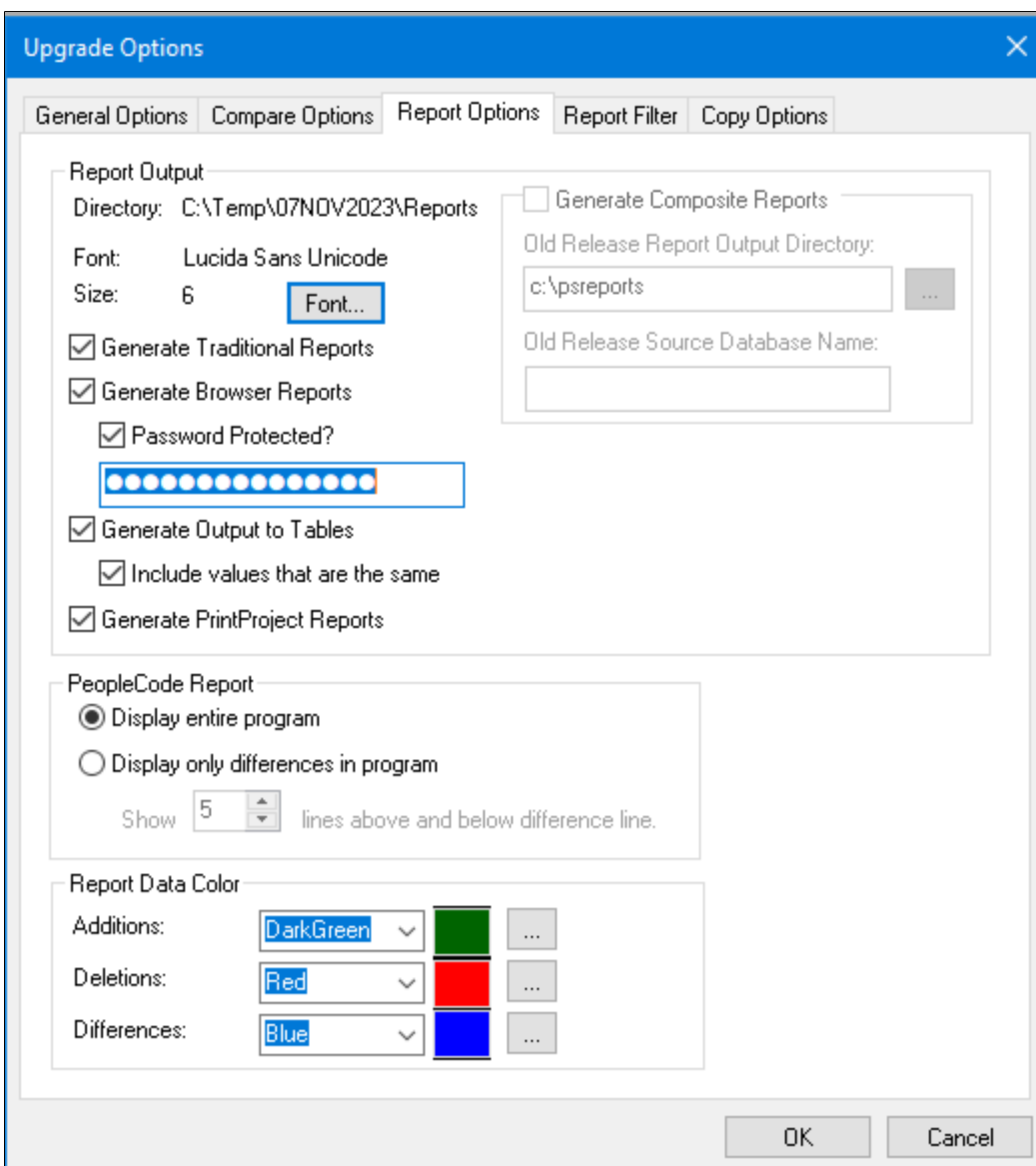

| <b>Field or Control</b>     | <b>Description</b>  |
|-----------------------------|---|
| <p><b>Report Output</b></p> | <ul style="list-style-type: none"> <li>• <b>Directory:</b> Displays the compare report output directory. To change the output directory path, select <b>Tools</b> &gt; <b>Options</b> from the PeopleSoft Application Designer toolbar, and select the General tab.</li> <li>• <b>Font and Size:</b> Displays the font type and size that will appear in the compare report output. Click <b>Font</b> to select a different font or to change the font size.</li> <li>• <b>Generate Traditional Reports:</b> Select this option to create traditional workspace (PRN) reports that are displayed in Application Designer.<br/><br/>See <a href="#">Working With Workspace Reports</a></li> <li>• <b>Generate Browser Reports:</b> Select to generate HTML reports that you can view in a browser in addition to the reports that appear in the Application Designer workspace.<br/><br/>See <a href="#">Working with Browser Reports</a>.</li> <li>• <b>Password Protected ?:</b> Select this option to set password while generating browser compare report. This ensures that only valid users access the report.</li> <li>• <b>Generate Output to Tables:</b> Select this option to write the compare output to database tables. This enables you to keep a historical record of your compares in your database, and it also provides you the flexibility of being able to design custom queries for analyzing specific definitions, attributes, and so on. The following PeopleTools tables store compare data: <ul style="list-style-type: none"> <li>• <b>PSCOMPSESSION:</b> Contains high-level information related to the compare, such as project name, target database name, source database name, session type, and so on.</li> <li>• <b>PSCOMPOBJDIFF:</b> Contains data related to the individual definitions that are being compared, including definition type, definition name, source status, target status, and so on, as well as specific data for the individual attributes compared.</li> </ul> </li> <li>• <b>Include values that are same:</b> This checkbox only applies to the compare results that are written to tables (generate output to tables option).</li> </ul> |

| <b>Field or Control</b>  | <b>Description</b>  |
|--------------------------|---|
|                          | <p>If selected that definitions with same-name will be written to the tables. Any values that are same-name for the source and target are not displayed on compare reports.</p> <ul style="list-style-type: none"> <li>• <b>Generate PrintProject Reports:</b> Select this option to create PrintProject style compare report definition.<br/><br/>See <a href="#">Working With PrintProject Reports</a></li> <li>• <b>Generate Composite Reports:</b> Select to generate a composite report, which is a subset of information showing only the definitions customized at your site that were also modified in the most recent PeopleSoft release. <ul style="list-style-type: none"> <li>• <b>Old Release Report Output Directory:</b> Enter the directory containing the compare reports run on the database for your previous PeopleSoft installation: the database from which you are upgrading.</li> <li>• <b>Old Release Source Database Name:</b> Enter the source database name you specified when running the compare reports on your previous PeopleSoft installation. This enables the system to identify the appropriate database definitions listed within the compare reports.<br/><br/>See <a href="#">Working with Composite Reports</a>.</li> </ul> </li> </ul> <hr/> <p><b>Note:</b> If no output options are selected, traditional reports will be produced. You can select multiple output options.</p> <hr/> |
| <b>PeopleCode Report</b> | <p>Specify the PeopleCode report options.</p> <p>For PeopleCode compare reports, specify whether to show the entire program on the report (the default setting) or only the code differences between the source and target. If you select the latter, you can specify the number of code lines to show above and below the difference for context. The values for the number of lines to show are 0 to 99. A value of 0 shows only the difference line. A value greater than 0 shows that many lines above and below the difference line.</p> <hr/> <p><b>Note:</b> The PeopleCode report options are global across all projects. Changing settings for one project changes all subsequent PeopleCode compares, regardless of project.</p> <hr/>  |

| <b>Field or Control</b>  | <b>Description</b>  |
|--------------------------|---|
| <b>Report Data Color</b> | <p>Select the report data color.</p> <p>Use the <b>Browse</b> button to display the standard color dialog box. Choose a color that is not included in the drop-down list box or create a custom color.</p> <p>The custom color value appears as hex color code, for example, #820041.</p> <ul style="list-style-type: none"> <li>• <b>Additions:</b> Select a color for additional data values on the source database. These are also source-only values. The default value is dark green.</li> <li>• <b>Deletions:</b> Select a color for data values that are deleted from the source database. These are target-only values. The default value is red.</li> <li>• <b>Differences:</b> Select a color for changed values, which are both source and target values. The default value is blue.</li> </ul> <p>The color selection is not applicable for Browser compare report.</p> <p>The color selection can be set through command line parameters such as -ADDCLR, -DELCLR, and, -DIFCLR. For details, refer <a href="#">Command Line Parameters</a>.</p> |

## Setting Report Filter Options

The following screenshot shows how to set up report filter options. Access the Upgrade Options dialog box and select the Report Filter tab.

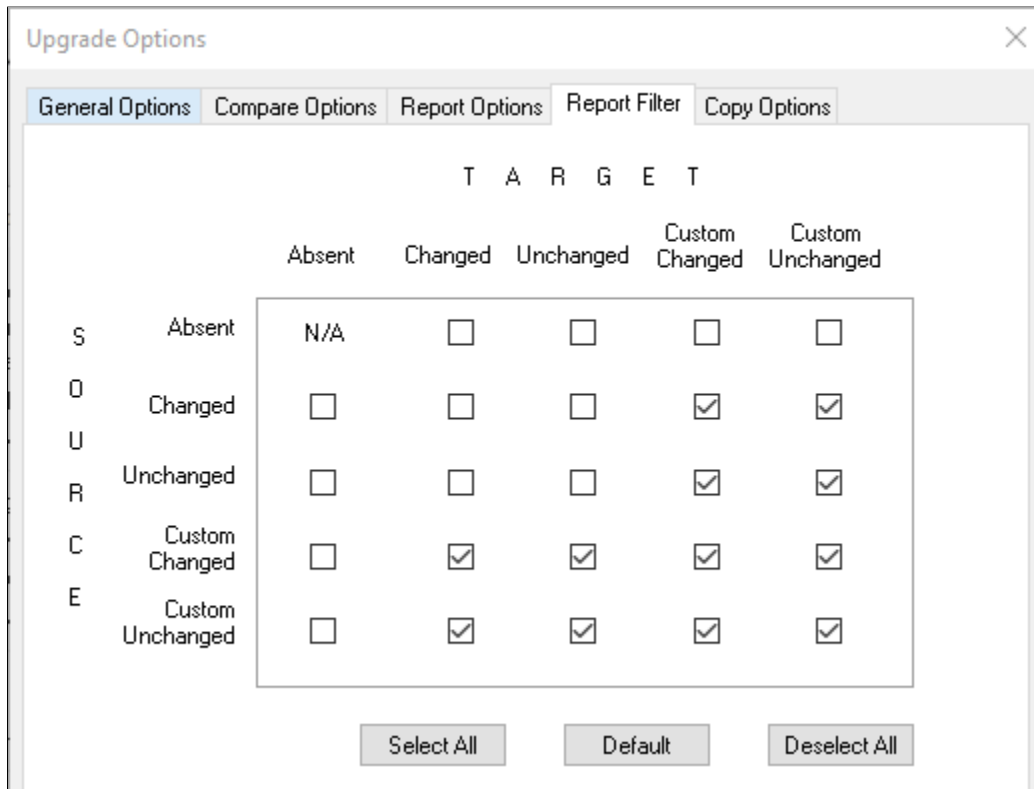

When you perform a comparison, the system generates a report for each definition type compared. These reports provide detailed information about how each definition in the source differs from its counterpart in the target.

Before performing a comparison, you can select the definition status combinations with which you generate reports by using report filter options. For example, during an upgrade to a new PeopleSoft release, you might decide that if a definition that was last changed in the target by PeopleSoft is found in the source and it hasn't changed since the last upgrade, you don't need to see information about the definition differences (because you intend to accept the new PeopleSoft version). In this case, you want to filter the compare reports so that a report is not generated if:

- The source is any status.
- The target is unchanged.

---

**Note:** Filtering comparison reports does not affect which definitions are added to a project during a database comparison, only which definitions are reported. Definitions that are defined differently in the two databases are always added to the project.

---

Select the check boxes corresponding to the definition status combinations that you want to report.

Each row in the matrix corresponds to the definition status in the source database. Each column corresponds to the definition status in the target.

The default settings for report filtering show conflicting configured definitions only.

- To reset your selections to the default setting, click the **Default** button.
- To select all definition status combinations, click the **Select All** button.
- If you don't want to generate any reports, click the **Deselect All** button to clear all of the check boxes.

### Setting Copy Options

This example illustrates the fields and controls on the Upgrade Options dialog box: Copy Options tab. You can find definitions for the fields and controls later on this page.

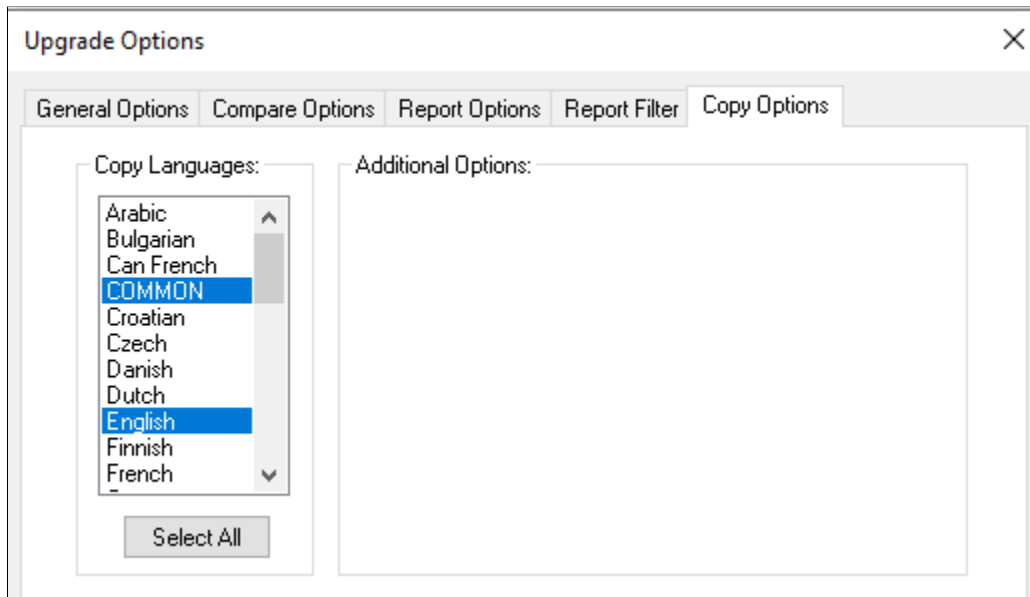

| <b>Field or Control</b> | <b>Description</b>   |
|-------------------------|--|
| Copy Languages          | <p>Select a specific language for label-oriented characteristics of a definition, such as page names, labels, and messages.</p> <p><i>COMMON</i>, specifies basic definition characteristics and parameters in the architecture that are not language-sensitive. Select <i>COMMON</i> when you select English. Do not select <i>COMMON</i> when you select a language other than English.</p> <p>If you do not select <i>COMMON</i>, basic definition characteristics are omitted.</p> <p>Make sure that the enabled languages in the source and target databases match. Otherwise, you might overwrite translations in the target. Use the <b>Ctrl</b> key and your mouse to clear unwanted languages.</p> <p>When you save the project, the copy settings that you made are saved and remain set unless you change them again.</p> |

This table lists translation scenario examples:

| <b>Selection</b>                 | <b>Reason</b>  |
|----------------------------------|--|
| <i>COMMON</i> and <i>English</i> | The source database does not include translations, but the target database has translations that you do not want to overwrite.                 |
| Languages (omit <i>COMMON</i> )  | You sent the database out for translations and want to avoid copying inadvertent changes that were made by the translators to the definitions. |
| <i>COMMON</i> (omit languages)   | You want to copy the source without translations to the target.  |

## Preparing Projects for an Upgrade

This section provides an overview of preparing project for an upgrade.

### Understanding Upgrade Projects

Before you can copy definitions from one database to another, you must insert them into a PeopleSoft Application Designer project. If you have a custom application, identify which definitions must be copied from the source into the target database. When you know which definitions you want to upgrade, specify and insert the definitions into the project.

However, when you are unfamiliar with one of the databases, you might want to populate a project by comparison—for example, when you upgrade to a new PeopleSoft application release. When you populate a project by comparison, the system compares the source and target databases and automatically populates the project with definitions that are defined differently in the two databases.

### Populating Projects

To populate projects:

1. Select **Insert** > **Definitions** into Project from the PeopleSoft Application Designer menu.

PeopleSoft Application Designer designates certain definition types as related to a parent or controlling definition type. For example, a record's related definitions can include fields, indexes, and subrecords. When you insert definitions into a project for upgrading, it can be important for these related definitions to be included.

2. Select the definitions and click **Insert**.
3. Select **Tools** > **Options**.
4. On the Project tab, review the settings in **Related Definitions Options** and reset.

## Searching for Definitions

To find a definition in the project select **Edit > Find** from the menu. This opens the Find dialog box where you can perform a search for a text string in an upgrade definition window.

## Printing All Definitions in a Project

You can print a project definition for all of the definition types in the current project. This differs from the Print menu item, which prints only the currently selected definition type that is open in the upgrade grid. The data, however, is the same.

To print a project definition for all definitions in current project, select **File > Print Project** from the PeopleSoft Application Designer toolbar.

## Obtaining Access for Upgrading

To use the PeopleSoft Application Designer upgrade features, you must have full access to projects and upgrade access in the target database.

Also, lock all PeopleSoft Application Designer definitions in the source and target databases before comparing and copying projects. To do this, you need supervisor-level access to Change Control (in the Tools menu). If your Change Control administrator performs this action for you, the administrator's user ID is the only one that is allowed to perform the copy while the target definitions are locked.

---

## Viewing Upgrade Messages

This section provides an overview of viewing upgrade messages.

### Understanding Upgrade Messages

During the compare and copy processes discussed in this section, if the system encounters any errors you will be notified through system messages. These messages alert you to various areas that may need to be corrected for a successful upgrade compare and copy.

### Determining Whether Errors Were Encountered

Select the Upgrade tab in the output window to determine whether any errors were encountered during the Compare or Copy process.

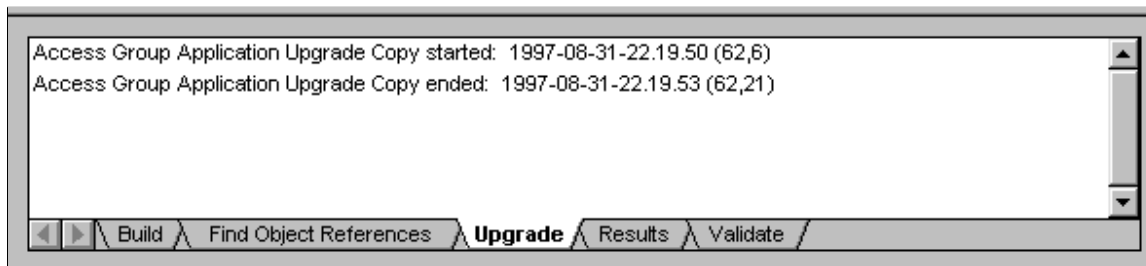

This view displays upgrade messages pertaining to the definition type that was most recently displayed in the upgrade definition window. In the preceding example, Access Groups was the last definition type that was viewed in the window.

## Viewing Messages

To view messages:

1. Open the project.
2. Select the Upgrade tab in the project workspace.
3. Double-click the folder of the definition type for which you want to view messages, or click the project icon to view all messages.

Any upgrade messages for that definition type appear in the output window.

## Printing Upgrade Messages

To print upgrade messages:

1. View the messages that you want to print.
2. Right-click the output window and select Print.

## Clearing Messages

To clear messages:

1. View the messages that you want to clear.
2. Right-click the output window and select Clear.



## Chapter 3

# Comparing Source and Target Definitions

---

## Understanding the Compare Process

PeopleSoft Application Designer enables you to compare the contents of the database to which you are signed on (or project within) with the target database or an exported project file. It enables you to view the status of each definition in each location so you can then decide which definitions to keep.

There are two ways to compare definitions:

- Compare all database definitions of a certain type, such as record definitions. After doing so, you populate the upgrade project with only the definitions that are defined differently in the source than in the target.
- Compare only the definitions in the current upgrade project to the equivalent definitions in the target database or file.

When performing comparisons between source and target definitions, PeopleSoft Application Designer enables you to:

- Generate workspace reports.

These reports appear in the PeopleSoft Application Designer workspace immediately after the compare process completes.

- Generate browser reports.

These reports are written to HTML and XML files enabling you to open the report in a browser, share the report with coworkers easily, and store report data in an industry-standard format.

- Generate Output to Tables.

Writes the compare reports to output tables.

- Generate PrintProject compare report

This report is written to the report directory in HTML using RTF format.

- Visually compare page definitions.

This feature enables you to view the source and target page definitions side-by-side with differences clearly marked.

- Visually compare and merge text definitions.

This feature enables you to view the source and target PeopleCode, HTML, SQL, XSLT definitions side-by-side with differences clearly marked. It also enables you to merge source PeopleCode with target PeopleCode.

## Comparing All Definitions by Type

PeopleSoft Application Designer performs comparisons on one definition type at a time. For each definition type that you select, the system removes any existing definitions of that type from the current project and repopulates the project based on the comparison results. For this reason, be careful when performing a database comparison on a predefined project.

For example, suppose that your project includes several record, page, and menu definitions and you perform a database comparison on pages only. All of the page definitions that were originally in the project are removed and replaced by any page definitions that were found in the Compare process. However, the record and menu definitions in the project are not affected.

Performing a database comparison overwrites custom upgrade settings with the defaults for the specified target orientation.

## Comparing Definitions by Project

If you manually inserted definitions into the project and you want to see how those definitions differ from the same definitions in another database, perform a project comparison. This method compares only the definitions in the project and does not repopulate the project—except in record and field comparisons. Upgrade settings are never modified when you perform a project comparison.

When records are compared—during a database *or* project comparison—differences that are found in record fields are written into the project. For example, suppose that Record A in the source database contains record fields 1, 2, 3, 4, and 5, and Record A in the target database contains fields 2, 4, 6, and 7. Before the comparison, the project contains only Record A. After the comparison, the project contains Record A and record fields 1, 3, 5, 6, and 7.

Similarly, when field definitions are compared, differences that are found in the field labels are inserted into the project as new field definitions. For example, suppose that you are comparing the source with the target, and both databases have the same field definitions. However, the field label for one of those field definitions is different. The source field definition is labeled **Employee ID**, but in the target, it is labeled **Staff ID**. The Compare process creates a new field definition that is labeled **Staff ID**. After the comparison, the project contains both an **Employee ID** field and a **Staff ID** field.

---

**Note:** These are the only situations where a project comparison repopulates a project.

---

## Synchronizing Databases When Comparing Record Definitions

The Upgrade Copy process synchronizes databases when performing an upgrade compare and copy for record definitions. During the upgrade copy (CopyProp only) of a table, subrecord, or temporary table, the system reorders the indexes (0 through 9) to follow the source index order. The target order matches the source order after the copy.

For example, suppose that the source record, Z, is a table with fields B, A, C, G, H and the target record, Z, is a table with fields A, B, F, G, C, H where all of these conditions are true:

- F is a customization and a **Key** field.
- A and B are exactly the same except for field order, and both are keys.

- C, G, H are exactly the same except for field order, and they are nonkey fields.

In this example, the upgrade compare produces project items for this record:

| <b>Record Name</b> | <b>Field Name</b>   | <b>Source</b> | <b>Target</b> | <b>Action</b> | <b>Upgrade</b> |
|--------------------|---------------------|---------------|---------------|---------------|----------------|
| Z                  | Not applicable (NA) | Changed       | UnChanged     | CopyProp      | Y              |
| Z                  | F                   | Absent        | *Changed      | Delete        | N              |

\* Unless the F record field is deleted, an upgrade copy and compare always shows this project item.

The result of an upgrade copy on this record changes record fields A, B, F, G, C, and H in the target database to B, F, A, G, C, and H, without moving the nonkey fields. Another upgrade compare would produce the same project items.

Likewise, during an upgrade copy of a view or dynamic view, the target order is reordered to match the source when a record field project item is copied and the source order does not match the target order.

For example, suppose that the source record, Z, is a view with fields B, A, C, and the target record, Z, is a view with fields A, B, F, C where all of these conditions are true:

- F is a customization.
- A and B are exactly the same except for field order.

In this example, the upgrade compare produces project items for these record fields:

| <b>Record Name</b> | <b>Field Name</b> | <b>Source</b> | <b>Target</b> | <b>Action</b> | <b>Upgrade</b> |
|--------------------|-------------------|---------------|---------------|---------------|----------------|
| Z                  | A                 | Changed       | UnChanged     | Copy          | Y              |
| Z                  | B                 | Changed       | UnChanged     | Copy          | Y              |
| Z                  | C                 | --            | --            | Copy          | Y              |
| Z                  | F                 | Absent        | *Changed      | Delete        | N              |

\* Unless record field F is deleted, an upgrade copy and compare always shows this project item.

The result of an upgrade copy changes A, B, F, C in the target database to B, F, A, C.

Another project compare would produce these project items:

| <b>Record Name</b> | <b>Field Name</b> | <b>Source</b> | <b>Target</b> | <b>Action</b> | <b>Upgrade</b> |
|--------------------|-------------------|---------------|---------------|---------------|----------------|
| Z                  | A                 | Changed       | UnChanged     | Copy          | Y              |

| <i>Record Name</i> | <i>Field Name</i> | <i>Source</i> | <i>Target</i> | <i>Action</i> | <i>Upgrade</i> |
|--------------------|-------------------|---------------|---------------|---------------|----------------|
| Z                  | C                 | --            | --            | Copy          | Y              |
| Z                  | F                 | Absent        | *Changed      | Delete        | N              |

\* Unless F is deleted, an upgrade copy and compare always shows this project item.

---

## Working With Compare Reports

This section discusses how to work with compare reports.

### Running a Compare Report

To perform a comparison:

1. Save any changes to objects and close all windows before starting the Compare process.

This ensures that all generated reports are saved during the Compare process. Once the process is complete, you can open the reports from a file and view them online.

2. Lock all of the PeopleSoft Application Designer definitions in the target database.

If you perform a full comparison, it might take several days for you to review all of the comparison reports and set the upgrade settings accordingly. Locking the PeopleSoft Application Designer definitions in the target database ensures that those definitions cannot be changed between the comparison and the time that you perform the copy.

3. Turn off all tracing.
4. Select **Tools > Compare and Report**, and select one of these options:
  - From Database: The PeopleSoft Signon dialog box appears, prompting you to sign in to an upgrade target database.
  - To File: The Compare and Report From File : Select Project dialog appears for you to select the project to compare.
5. On the Compare and Report dialog box, select the types of definitions to compare from the Definition list.
6. Click **Options** to access the Upgrade Options dialog box.

Set all upgrade options including comparison report filters.
7. Select the appropriate Project Item Status / Insert Child Definitions option (if enabled it allows you to preserve the original project).
8. Click **Compare** to perform the comparison.

The system creates online reports for the definitions that you are comparing. Upgrade Compare reports are saved to the location you specify in the **Report Output Directory** field in **Tools > Options** on the General tab.

When the compare process completes, the PRT reports (if selected) are opened in Application Designer. Links to reports are displayed in the Output window, as well as compare messages.

This example illustrates the fields and controls in Application Designer when the compare process completes.

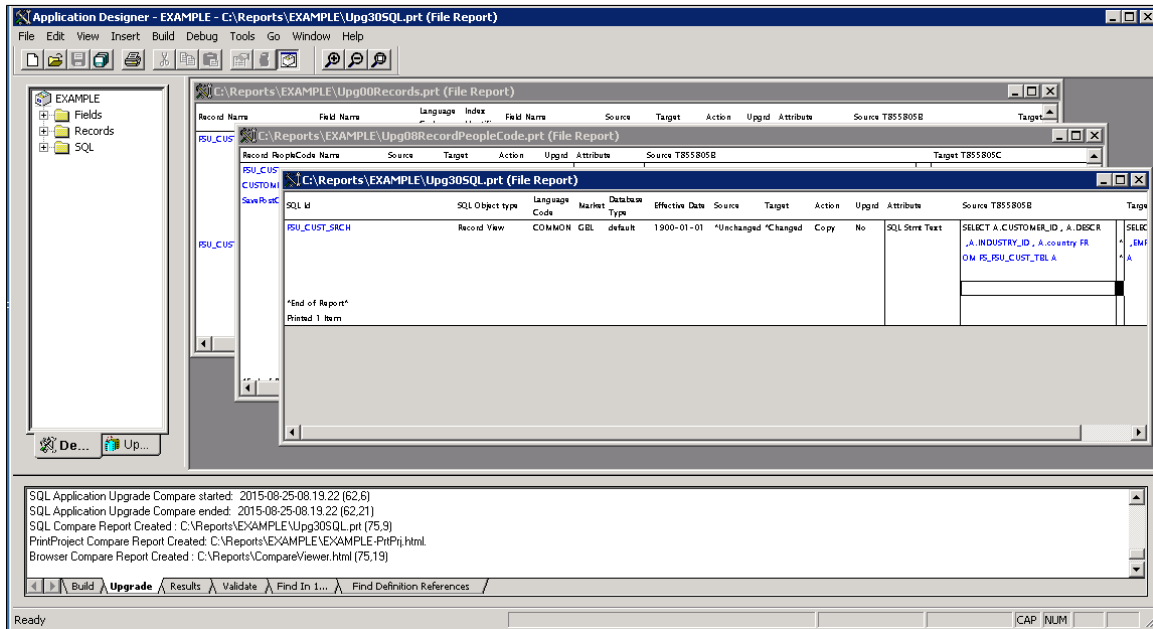

**Note:** You can also compare definitions using command line syntax.

See [Comparing Definitions for Upgrade Using the Command Line](#).

## Working with the Compare and Report Dialog Box

This example illustrates the fields and controls on the Compare and Report From File dialog box. You can find definitions for the fields and controls later on this page.

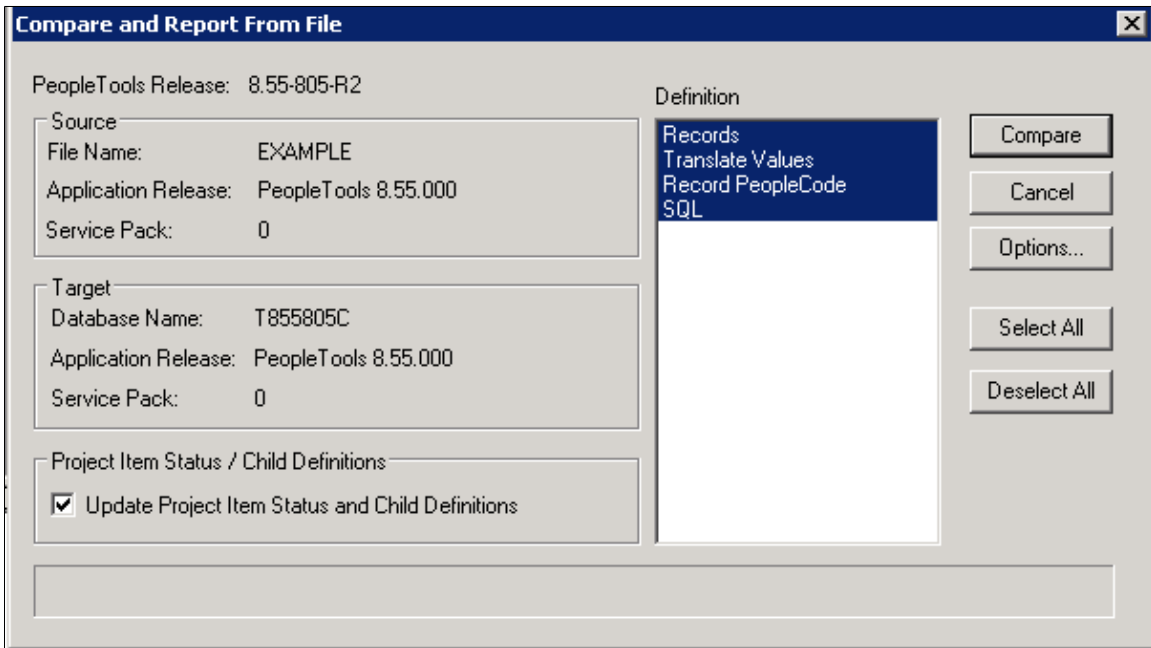

**Note:** Depending on whether you are comparing to a database or from a file, the dialog box name changes accordingly.

| <b>Field or Control</b> | <b>Description</b>  |
|-------------------------|---|
| <b>Source</b>           | Identifies the file or database name, the application release, and the service pack level of the source file or database. |
| <b>Target</b>           | Identifies the database name, the application release, and the service pack level of the target database.                 |

| <b>Field or Control</b>                            | <b>Description</b>  |
|--|---|
| <p><b>Update Item Status/Child Definitions</b></p> | <p>Deselect the <b>Update Project Item and Child Definitions</b> option to preserve the status of the items in your upgrade project and the child definitions when running a compare. Child definitions apply only to records and fields in which fields are the child definitions of the record, and field labels are the child definitions of record fields.</p> <p>When running a compare report, the system compares the definitions in an another database or file to the database to which you are currently signed on. Based on the compare results, the system updates the status of the project items in your upgrade project in the definition window. For example, after running the compare, the system inserts the status of the Source and Target (Absent, Changed, Unchanged, and so on), the Action to take (None, Copy, CopyProp, and so on).</p> <p>Regarding child definitions with the case of records, if a record is the same version in both places, the system removes the fields. With the case of fields, if a field is the same version in both places the system removes the field labels from the upgrade project definition.</p> <p>When a child item is found to be different between the two places, then that item is inserted into the project so the child item can then be copied as a unique item. When this option is deselected, no child items are deleted nor inserted into the project.</p> <p>In some cases, as in when you want to compare the same upgrade project to multiple sources, for example a demo database, a production database, and a project file, you may decide to deselect this option so that the source upgrade project remains unchanged. When deselected, the project item status and child definitions information only appears in the generated compare report, not online in the PeopleSoft Application Designer project definition.</p> <hr/> <p><b>Note:</b> By default, this setting is selected, which should accommodate most situations.</p> <hr/> <p><b>Note:</b> This option applies only when performing project compares, and is not applicable when performing a full database compare (Compare Type is set to Database on the Compare Options tab in the Upgrade Options dialog box). A full database compare should start with an empty upgrade project and insert the different items into the upgrade project.</p> <hr/> <p><b>Note:</b> When performing a compare from file, if the option is turned off, the resulting project definition after the compare will have the same status settings and project items as in the file project definition. The compare reports will still reflect the status settings and differences in any child items. When the option is left on, the compare will change the project definition based on the compare results, changing the status settings, and inserting or deleting child items as needed.</p> |

| <b>Field or Control</b>        | <b>Description</b>   |
|--------------------------------|--|
| <b>Definition</b>              | Displays the current set of definitions being compared. The system only compares the definitions in the list that are highlighted. |
| <b>Compare</b>                 | Executes the compare process.  |
| <b>Cancel</b>                  | Cancels the compare process.   |
| <b>Options</b>                 | Opens the Upgrade Options dialog box.<br><br>See <a href="#">Setting Upgrade Options</a> .   |
| <b>Select All/Deselect All</b> | Selects all the definitions in the <b>Definition</b> list, or deselects all.   |

---

## Working With Workspace Reports

PeopleSoft provides online comparison reports in PeopleSoft Application Designer. These reports appear in the project workspace area after you run a compare report.

### Accessing Reports

To access reports:

1. Select **Tools** > **Compare and Report** from the PeopleSoft Application Designer toolbar.
2. Select one of these options:
  - From Database
  - To File
3. Sign in to the target database.

The system automatically displays a comparison report for each definition that you selected to be copied. If the current definition type has a PeopleSoft Application Designer based editor, you can double-click the definition name in the report to open it. If the comparison report is large, you can search for specific definition names.

### Searching for Definitions in Reports

For long compare reports, it is useful to perform a search to locate specific items. The Find in Report feature searches by column. To search for an object in a comparison report highlight or place your cursor in the column that you want to search and select **Edit** > **Find in Report**.





# Navigating the Differences in a Compare Report

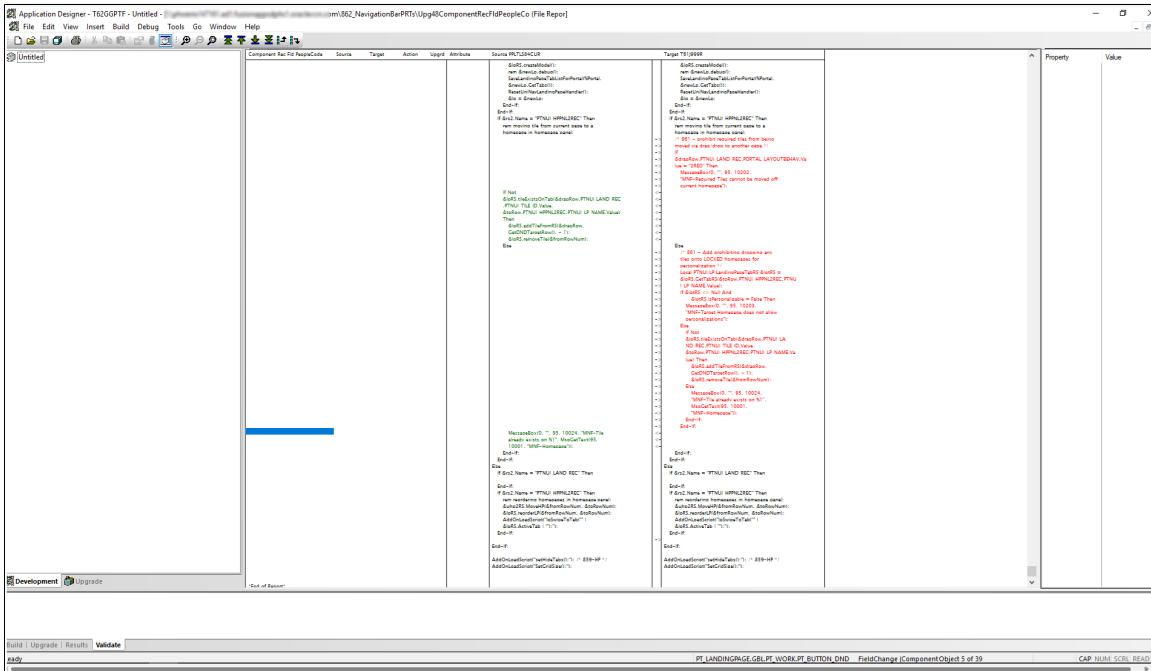

Use the different options to navigate through the differences and objects in a compare report. Especially in a larger compare report, finding the differences becomes easier with these options.

To open an existing compare report, select File> Report from File> View Report.

This example illustrates the fields and controls in Application Designer 's toolbar that is used to navigate through the compare report.



| Field or Control  | Description   |
|---|---|
|  | Displays the very first difference in the compare report.<br><br>Keyboard shortcut is Alt + Home.   |
|  | Displays the previous difference in the compare report.<br><br>Keyboard shortcut is Alt + Up Arrow. |
|  | Displays the next difference in the compare report.<br><br>Keyboard shortcut is Alt + Down Arrow.   |
|  | Displays the last difference in the compare report.<br><br>Keyboard shortcut is Alt + End.          |

| <b>Field or Control</b>   | <b>Description</b>   |
|---|--|
|  | <p>Navigates to the previous object.</p> <p>On the status bar, the details of the object is displayed.</p> <p>Also, the count of current focused object and count of total number of objects are displayed. For example, object 5 of 39.</p> <p>Keyboard shortcut is Shift + Up.</p> |
|  | <p>Navigates to the next object.</p> <p>On the status bar the details of the object is displayed.</p> <p>Also, the count of current focused object and count of total number of objects are displayed. For example, object 6 of 39.</p> <p>Keyboard shortcut is Shift + Down.</p>    |

All the options listed above can be accessed through the View menu also.

Initially when the compare report is opened, the View First Difference, View Next Difference, and View Last Difference options are enabled if any differences are present in the report.

If there are no differences in the report, none of the options will be enabled.

Based on the option you have selected, some of the options get disabled or enabled. For example, when you are viewing the very first difference, the options View First Difference and View Previous Difference get disabled.

## Printing the Report

### Printing the Comparison Report

This example illustrates the fields and controls on the Print preview comparison report.

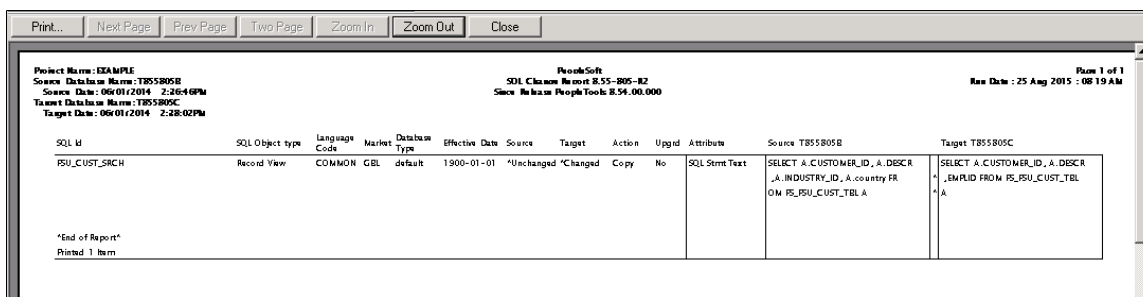

To print the comparison report select **File > Print**. The standard Print dialog box appears, enabling you to select the printer, number of copies, and so on.

### Printing a Comparison Report From a File

To print a comparison report from a file:

1. To print a saved comparison report, select **File > Report from File**.
2. Select **Print Preview**, **Print**, or **View Report**.

These options require that you specify the report name and its location in a standard Open dialog box. **View Report** displays the specified report in the project workspace.

## Moving Print Files

You might want to move the comparison report files to another directory or send them as email attachments. Each comparison report file is saved as two files with the following format:

- Upg<number>DefinitionType.prt
- Upg<number>DefinitionType.idx

Both files (filename.prt and filename.idx) are required to view or print the report.

## Saving Reports as Text Files

While the report is open in the workspace, you can save the workspace report as a text file. This enables you to import the report results into applications of your choice, such as Microsoft Excel.

To save the workspace report as a text file:

1. Select File, Save Report As.
2. On the Save Report As dialog box insert a file name into the **File Name** edit box, and select a file type from the **Save as type** drop-down list.

You can select *Tab Delimited (.txt)* or *Comma Delimited (.csv)*.

3. Click **Save**.

---

## Working with Browser Reports

This section provides an overview of working with browser reports.

### Understanding Browser Reports

Browser reports enable you to view compare results using your browser.

You use the Compare Report Viewer to view and navigate within the results. The Compare Report Viewer is a client-based HTML program through which you view the compare results, which are stored in XML. Having the compare results in HTML and XML enables you to:

- Share compare results online with colleagues that do not have PeopleTools installed.
- Display results in custom formats using the data stored in the generated XML files.

By setting the Generate Browser Reports option, when you run the Compare and Report process, the system generates browser reports in addition to the workspace reports that automatically appear in the PeopleSoft Application Designer workspace.

## Accessing and Sharing Browser Reports

This section discusses how to:

- Access browser reports.
- Share browser reports.

### Accessing Browser Reports

To access a browser report, double-click on the line in the output window containing "Browser Compare Report Created."

Enter password, if prompted. You can set password for browser compare reports in Report Options tab on the Upgrade Options dialog box.

The following is a screen image of Accessing Browser Reports in PeopleSoft Compare Report Viewer.

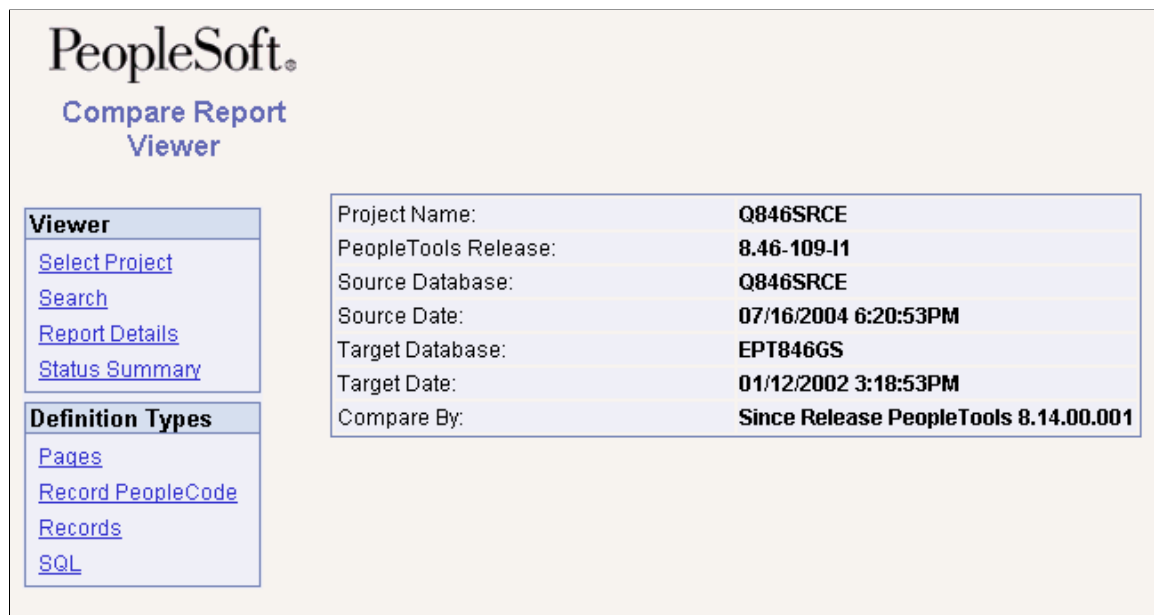

The Viewer menu contains menu options related to navigating within the report. The Definition Types menu enables you to drill down into the compare data for each definition type compared. The Definition Types menu only contains the definitions compared.

Note that the PeopleSoft Compare Report Viewer (pscmpviewer.exe) is placed in the same folder location where browser compare reports are saved.

The compare reports are saved to the location you specify in the Report Output Directory field in Tools > Options on the General tab.

## Sharing Browser Reports

PeopleSoft Application Designer writes the browser reports to a subdirectory named after the project name within the Report Output Directory specified on the General tab on the Options dialog. For example, if the Report Output Directory is c:\psreports and the project name is "PROJECT," then the browser reports exist in c:\psreports\PROJECT. To view the compare results, double-click CompareViewer.html and then select the desired project name.

For each type of definition you compare, there is a subdirectory containing XML files storing the compare data for that definition type. For example, if you compared pages, the XML file containing compare data for the page compare exists in c:\psreports\PROJECT\Pages. These files can be used as source data for custom displays of the compare data. The PeopleSoft Compare Report Viewer uses these XML files along with various HTML and XSL files to present your compare data.

To share the browser reports, PeopleSoft recommends:

- Copying the entire high-level report output directory (containing all subdirectories, HTML, and XSL files) and copying it to a shared network drive.
- Compressing the entire directory and sending or posting individual copies as needed.

## Selecting a Project

If you've run multiple compare reports on the same workstation, the PeopleSoft Compare Report Viewer enables you to switch between them easily.

To select a project:

1. Click Select Project.
2. Select the appropriate project in the Project Name list.

## Searching for Definitions

You can search for specific definitions within the compare data.

To search for definitions:

1. Select Search.
2. From the **Definition Type** list, specify the appropriate definition type, such as *Records*.
3. In the **Search Text** edit box, enter the name or part the name of the definition you want to view.

---

**Note:** You must enter at least three characters.

---

**Note:** The search returns the parent and child definitions. For example, if you enter 'RecordA' that contains FieldB and FieldC, the search returns RecordA, RecordA.FieldB, and RecordA.FieldC. Also, the search returns all definitions beginning with the search string entered.

---

4. Click Search.

## Viewing Report Details

Click Report Details to view information related to the databases and/or files compared.

| <b>Field or Control</b>            | <b>Description</b>  |
|------------------------------------|---|
| <b>Project Name</b>                | The name of the project in the primary database.  |
| <b>PeopleTools Release</b>         | The PeopleTools release number on which the primary database runs.  |
| <b>Source Database/Source File</b> | The name of the primary database or file depending on which compare option you selected.  |
| <b>Source Date</b>                 | The date the primary database was last updated.   |
| <b>Target Database</b>             | The name of the secondary database.   |
| <b>Target Date</b>                 | The date the secondary database was last updated.   |
| <b>Compare By</b>                  | Displays the Comparison options selected on the Compare Options dialog box either the release or date.<br><br>See <a href="#">Setting Upgrade Options</a> . |

## Viewing Status Summary

To view the status summary, click Status Summary.

The status summary is a high-level view of the compare results showing the definitions compared and the occurrence of differences. The summary table indicates whether the difference occurred because of additions, modifications, or deletions that were the result of activity at your site, or whether the difference occurred as a result of an addition or modification made by PeopleSoft. This summary can be useful for managers and executives who are scoping and budgeting for an upgrade.

Each of the columns in the status summary indicate the number of items found to differ by definition type. The columns represent the "Source" and "Target" status values set during the compare process. You can click on any of the cell values to view the items filtered for each particular status result. You can also click the value in the Definition Type column to view further status information.

The following table shows how each column in the status summary table equates to the status in the source and target locations.

| <b>Field or Control</b> | <b>Description</b>                                   |
|-------------------------|--|
| <b>Customer Added</b>   | Source: Absent<br><br>Target: *Changed or *Unchanged |

| <b>Field or Control</b>    | <b>Description</b>   |
|----------------------------|--|
| <b>Customer Modified</b>   | Source: Changed or Unchanged<br>Target: *Changed or *Unchanged |
| <b>Customer Deleted</b>    | Source: Absent<br>Target: Changed or Unchanged                 |
| <b>PeopleSoft Added</b>    | Source: Any<br>Target: Absent                                  |
| <b>PeopleSoft Modified</b> | Source: Changed or Unchanged<br>Target: Changed or Unchanged   |

**Note:** If you have generated composite reports, two tabs appear for the status summary: Compare Report and Composite Report.

**Note:** The compare report values reflect the assumption that the source is the delivered PeopleSoft demonstration database and the target is a customer's production copy of a database.

## Related Links

[Working with Definition Status](#)

## Viewing Compare Results by Definition Type

The Definition Types menu displays a menu item for each type of definition you compared. Click the link for a particular definition type to view the comparison results for each definition of that type.

Each definition compared appears in a grid containing identification information relevant to that definition type as well as the status of the definition in each location, the action, and the upgrade flag. The identification columns are links enabling you to drill down into the compare results of that definition so you can compare source and target values.

| <b>Field or Control</b> | <b>Description</b>  |
|-------------------------|---|
| Expand All              | Expands all definitions in the grid to reveal all associated attributes and child definitions.                          |
| Collapse All            | Collapses the expanded grid so that only the list of definitions appear.  |
| Show All Attributes     | Click to show all attributes within a definition in Expand All mode after hiding an attribute or hiding all attributes. |

| <b>Field or Control</b>     | <b>Description</b>   |
|-----------------------------|--|
| Hide this/all Attribute     | Hides the values of a specific attribute, or hides all attributes of a specific type.                        |
| Next, Previous, First, Last | Enables you to navigate between pages in a report containing multiple pages.                                 |
| Items Per Page              | Shows the number of items appearing on a single, current page, and the total number of items in the project. |

---

**Note:** If you have generated a composite report, two tabs appear: Compare Report and Composite Report.

---

See [Working with Definition Status](#).

---

## Working With PrintProject Reports

PrintProject produces an HTML report in RTF (rich text) format. The report is written directly to the report directory. The report will be named <PROJECT\_NAME>-PrtPrj.html for example if the project name is EXAMPLE, the report name is EXAMPLE-PrtPrj.html. In Application Designer there will be a link to the report in the output window.

This example illustrates the fields and controls on the PrintProject report. You can find definitions for the fields and controls later on this page.

The screenshot shows a web browser window with the address bar displaying 'C:\EXAMPLES\EXAMPLE-Prj.html'. The main content area is titled 'Project: EXAMPLE' and contains the following sections:

- Database Information:**
  - Database: *T855805B* ~~T855805C~~
  - Description: *Example project*
  - Comments: *Example to use in online help*
- Record PeopleCode:**
  - PSU\_CUST\_TBL.CUSTOMER\_ID.SavePostChange*
  - PSU\_CUST\_TBL.CUST\_BUTTON.FieldChange*
  - PSU\_CUST\_TBL.REPORT.FieldChange*
- Records:**
  - PSU\_CUST\_SRCH*
  - PSU\_CUST\_SRCH.COUNTRY*
  - PSU\_CUST\_SRCH.CUSTOMER\_ID
  - PSU\_CUST\_SRCH.DESCR
  - ~~PSU\_CUST\_SRCH.EMPLID~~
  - PSU\_CUST\_SRCH.INDUSTRY\_ID*
  - PSU\_CUST\_TBL*
  - PSU\_CUST\_TBL.CONTRACT\_DT
  - PSU\_CUST\_TBL.CUSTOMER\_ID*
  - PSU\_CUST\_TBL.CUSTOMER\_TYPE
  - PSU\_CUST\_TBL.CUST\_BUTTON*
  - PSU\_CUST\_TBL.DESCR*
  - PSU\_CUST\_TBL.DESCRLONG
  - PSU\_CUST\_TBL.DESCRSHORT
  - PSU\_CUST\_TBL.EMPLID
  - PSU\_CUST\_TBL.INDUSTRY\_ID*
  - PSU\_CUST\_TBL.PHONE
  - PSU\_CUST\_TBL.PSU\_ADDRESS\_SBR
  - PSU\_CUST\_TBL.REPORT*
  - PSU\_CUST\_TBL.TRAINING\_UNITS
  - PSU\_CUST\_TBL.TRANSFER\_PB
- SQL:**
  - PSU\_CUST\_SRCH.Record View*
- Record PeopleCode Detail:**

Record PeopleCode: PSU\_CUST\_TBL.CUSTOMER\_ID.SavePostChange

| Key   | IpProgCode   |
|---|--|
| <i>PSU_CUST_TBL.CUSTOMER_ID.SavePostChange.....</i> | <i>/* Publish PeopleCode for PSU_CUST_TBL */</i>     |
|   | Local Message aMSG;                                  |
|   | If %UserId = "PRINT" Then                            |
|   | <del>aMSG = CreateMessage(Operation.CUSTOMER);</del> |
|   | aMSG = CreateMessage(Operation.CUST_ADD);            |
|   | If aMSG.IsActive Then                                |
|   | aMSG.CopyRowsetDelta(GetRowset());                   |

The first section of the report contains some general information including the project name, project description, and comments.

The second section of the report contains an index of all the objects included in the project. The objects in this section that appear in red with a strikethrough are objects marked for deletion.

A details section is displayed for each object type in the projects, this section displays added, deleted or changed code and/or attributes.

## Accessing the PrintProject Report

You can access the PrintProject report by either:

- In Application Designer when the compare is run double-click on the line in the output window containing "PrintProject Compare Report Created."
- Navigate to the report directory, select the Project folder and select <PROJECT\_NAME>-PrtPrj.html.

---

## Working with Composite Reports

This section provides an overview of working with composite reports.

### Understanding Composite Reports

When performing a PeopleSoft application upgrade, part of the process involves identifying the customizations made on your previous database and ensuring that all customizations are reflected in the upgraded database. During the development of a new PeopleSoft application release, many changes are made to the underlying metadata of the PeopleSoft application. If your application database is highly customized, it's likely that you've customized at least some of the definitions that PeopleSoft has modified in the new release. You identify your customizations and PeopleSoft modifications by running compare reports.

For example, suppose you are performing an upgrade from PeopleSoft 8.1x applications to PeopleSoft 8.4x applications. To identify your customizations, you run compare reports between your current 8.1x production database and the delivered 8.1x DEMO database. Then, to view your customizations and the PeopleSoft modifications after your 8.1x database has been upgraded to the 8.4x version, you run compare reports between your upgraded database and the delivered DEMO version of the 8.4x database.

Generating composite reports during this process greatly enhances your ability to identify the definitions that both you have customized and that PeopleSoft has modified. Composite reports compare your previous compare reports to the target database. The information in the previous compare reports is considered a subset of the composite reports. That is, all data appearing in the previous compare reports also appears on the composite reports, and those attributes that were updated by your organization and PeopleSoft will be highlighted.

The report output displays the changed attributes of the definitions so that you can determine the level and granularity of your customizations and how much effort will be involved in reapplying your customizations during the upgrade. This information can assist the decision making process when assessing the upgrade project scope.

---

**Note:** Composite reports are not a comprehensive record of *all* changes in the system. They only reflect definitions that have been changed by PeopleSoft *and* by a customer implementation.

---

**Note:** Composite reports do not replace compare reports. Rather, a composite report provides an alternate display of the information in compare reports, showing information appearing in both old release and new release compare reports.

---

---

**Note:** Composite reports are generated only for definitions that exist within both databases. For example, Analytic Model definitions used for the PeopleSoft Analytic Calculation Engine do not exist in a PeopleTools 8.1x application database. If comparing between a PeopleTools 8.1x application database and a PeopleTools 8.47 application database, a composite report for Analytic Model definitions will not be generated, as those definitions do not exist within a PeopleTools 8.1x database.

---

## Generating Composite Reports

Before generating composite reports, consider the following:

- Compare report output (.PRT files and .IDX files) generated from the previous version must exist in an accessible directory. All reports must exist in the same directory, and the report file names must not have changed since they were originally generated.
- The previous compare reports must have been generated on applications running on at least PeopleTools 8.1x. Compare reports generated by PeopleTools versions prior to 8.1x, such as PeopleTools 7.x or 7.5x are not supported.
- Composite reports should only be generated when necessary, as in during the Enterprise upgrade process. Generating composite reports can be time consuming and can cause performance degradation.
- If you have selected Generate Browser Reports on the Report Options tab in the Upgrade Options dialog box, the system also generates browser reports for the composite reports. To view the composite reports in the browser, click the Composite Report tab in the Report Viewer.
- Any filtering options you've set on the Report Filter tab in the Upgrade Options dialog box also apply to the composite reports.

To generate a composite report:

1. Make sure that the compare reports generated from your previous release exist and reside in an accessible directory.
2. Launch Application Designer and sign on to the delivered PeopleSoft demonstration database.
3. Select **Tools > Compare and Report > To Database**.
4. On the Compare and Report dialog box, select **Options**.
5. On the Upgrade Options dialog box, select the Report Options tab.
6. Select the **Generate Composite Reports** check box, which activates the **Old Release Report Output Directory** and **Old Release Source Database Name** edit boxes.
7. In the **Old Release Report Output Directory** edit box, enter the directory where the compare reports generated from your previous database reside.
8. In the **Old Release Source Database Name** edit box, enter the name of your original, source database (which is typically the PeopleSoft demonstration database from the previous release), and click **OK**.

At this point, the process is identical to running a typical compare report. When the report completes, Application Designer displays both reports: the regular compare report and the composite report for each type of definition compared.

**Note:** The naming convention for composite reports is similar to compare reports, only the prefix for composite report file names is "Cmp". For example, the naming convention for composite reports is Cmp<number><definition>, as in Cmp05Pages.prt and Cmp05Pages.idx.

## Working With Composite Report Output

Generate a composite report.

The following is a screenshot of Working with Composite Report sample output. You can find definitions for the fields and controls later on this page.

| Page Name          | Language Code | Field Type | Record (Table) Name | Field Name | Attribute    | Old Release | New Release | Customization  |
|--------------------|---------------|------------|---------------------|------------|--------------|-------------|-------------|----------------|
| ACCESS_GROUP_TABLE | ENG           |            |                     |            | Upgrd Status | Unchanged   | *Changed    | *Changed       |
|                    |               |            |                     |            | Descr        |             |             | tgt long descr |
|                    |               |            |                     |            | Descr        |             | src descr   | tgt descr      |
|                    |               | Frame      |                     |            | Descr        |             |             |                |
|                    |               |            |                     |            | Field Left   | 8           | <same>      | 16             |
|                    |               |            |                     |            | Field Top    | 8           | <same>      | 4              |
|                    |               |            |                     |            | Fld. Right   | 624         | <same>      | 632            |
|                    |               |            |                     |            | Fld Bottom   | 44          | <same>      | 40             |
|                    |               | Edit Box   | ACCESS_GRP_TBL      | DESCR      | Field Left   | 128         | 120         | 136            |
|                    |               |            |                     |            | Field Top    | 60          | 64          | 56             |
|                    |               |            |                     |            | EdLbl Left   | 20          | 12          | 28             |
|                    |               |            |                     |            | EdLbl Top    | 60          | 64          | 56             |
|                    |               |            |                     |            | EdLbl Right  | 89          | 81          | 97             |
|                    |               |            |                     |            | EdLbl Bot.   | 73          | 77          | 69             |

| Field or Control | Description   |
|------------------|---|
| Old Release      | Previous release source data value. In a PeopleSoft upgrade, this is the source value from the DEMO database in the previous release.   |
| New Release      | New release source data value. In a PeopleSoft upgrade, this is the source value from the DEMO database in the new release, which reflects the modification performed by PeopleSoft development teams. If no modification has been made by PeopleSoft for a particular attribute, the value "<same>" appears in the New Release column. |
|                  | <b>Note:</b> Changes represented here are not necessarily performed by PeopleSoft. If the compare reports were ran against your development environment, the modification was made in-house, not by PeopleSoft.   |

| <i>Field or Control</i> | <i>Description</i>   |
|-------------------------|--|
| Customization           | New release's copy of the production target value. In a PeopleSoft upgrade, this is the target value from the copy of the production database against which all upgrade scripts have been run. |

## Example: Creating a Composite Report

To illustrate how the system compiles and displays composite report information, this section provides a simple example. Keep in mind that this example only displays information for one definition. A typical composite report can contain information pertaining to hundreds of definitions. This example shows:

- Compare report results between a PeopleSoft 8.1 demonstration database and PeopleSoft 8.1 production copy.
- Compare report results between a PeopleSoft 8.4 demonstration database and PeopleSoft 8.4 production copy.
- Composite report result based on the previous compare report results.

### Compare Report Results Between a PeopleSoft 8.1 Demonstration Database and PeopleSoft 8.1 Customer Production Database

This compare report shows customizations. For the field, FLD1, the following customizations were made:

- Field Length: 10 to 12
- Description: ABC to XYZ
- Owner ID: PPT to CUST

With these customizations, the compare report results would appear as follows:

| <i>Definition Name</i> | <i>Source Status</i> | <i>Target Status</i> | <i>Attribute</i> | <i>Source Value</i> | <i>Target Value</i> |
|------------------------|----------------------|----------------------|------------------|---------------------|---------------------|
| FLD1                   | Unchanged            | *Changed             | Field Length     | 10                  | 12                  |
|                        |                      |                      | Description      | ABC                 | XYZ                 |
|                        |                      |                      | Owner ID         | PPT                 | CUST                |

### Compare Report Results Between a PeopleSoft 8.4 Demonstration Database and PeopleSoft 8.4 Customer Production Database

This report shows customizations and PeopleSoft modifications.

For the field, FLD1, the following customizations were made:

- Field Length: 10 to 12
- Description: ABC to XYZ
- Owner ID: PPT to CUST

For the field, FLD1, PeopleSoft made the following modifications:

- Field Length: 10 to 14
- Format: Upper to Mixed
- Field Type: Char to Long Char

With these customizations, the compare report results would appear as follows:

| <b>Definition Name</b> | <b>Source Status</b> | <b>Target Status</b> | <b>Attribute</b> | <b>Source Value</b> | <b>Target Value</b> | <b>Note</b>                             |
|------------------------|----------------------|----------------------|------------------|---------------------|---------------------|---|
| FLD1                   | Unchanged            | *Changed             | Field Length     | 14                  | 12                  | PeopleSoft modification + Customization |
|                        |                      |                      | Description      | ABC                 | XYZ                 | Customization Only                      |
|                        |                      |                      | Owner ID         | PPT                 | CUST                | Customization Only                      |
|                        |                      |                      | Format           | Mixed               | Upper               | PeopleSoft modification only            |
|                        |                      |                      | Field Type       | Long Char           | Char                | PeopleSoft modification only            |

### Composite Report Result Based on the Previous Compare Report Results

The following table is a sample composite report only showing the attributes from the previous compare reports that were changed by both PeopleSoft and a customer.

| <b>Definition Name</b> | <b>Attribute</b> | <b>Old Release</b> | <b>New Release</b> | <b>Customization</b> |
|------------------------|------------------|--------------------|--------------------|----------------------|
| FLD1                   | Field Length     | 10                 | 14                 | 12                   |
|                        | Descr            | ABC                | (same)             | XYZ                  |

| <b>Definition Name</b> | <b>Attribute</b> | <b>Old Release</b> | <b>New Release</b> | <b>Customization</b> |
|------------------------|------------------|--------------------|--------------------|----------------------|
|                        | OwnerID          | PPT                | (same)             | <i>CUST</i>          |

## Working with Definition Status

This section discusses how to work with definition status.

### Determining Definition Status

PeopleSoft Application Designer defines the status of a definition in the source and the target database.

| <b>Field or Control</b> | <b>Description</b>   |
|-------------------------|--|
| Unknown                 | Definition has not been compared. This is the default status for all definitions inserted manually into a project and the permanent status of all non-comparison definitions.  |
| Absent                  | The definition was found in the other database, but not in this one. When upgrading to a new PeopleSoft release, all new PeopleSoft definitions should have Absent status in the target database and all of your custom definitions should have Absent in the source database.     |
| Changed                 | The definition has been compared, the LASTUPDOPRID value is PPLSOFT, and the LASTUPDDTTM value is greater than the date/time stamp of the comparison release database. This indicates that PeopleSoft modified the definition since the comparison release.                        |
| Unchanged               | The definition has been compared, the LASTUPDOPRID value is PPLSOFT, and the LASTUPDDTTM value is less than or equal to the date/time stamp of the comparison release database. This indicates that PeopleSoft modified the definition prior to the comparison release.            |
| *Changed                | The definition has been compared, the LASTUPDOPRID value is <i>not</i> PPLSOFT, and the LASTUPDDTTM value is greater than the date/time stamp of the comparison release database. This indicates that a customer modified the definition since the comparison release.             |
| *Unchanged              | The definition has been compared, the LASTUPDOPRID value is <i>not</i> PPLSOFT, and the LASTUPDDTTM value is less than or equal to the date/time stamp of the comparison release database. This indicates that a customer modified the definition prior to the comparison release. |

| <b>Field or Control</b> | <b>Description</b>  |
|-------------------------|---|
| Same                    | The definition has been compared and is defined the same in both databases. When a definition in one database has this status its counterpart in the other database will have the equivalent status. This status can be seen when performing a project comparison because with a project comparison the definitions are static; the project is not repopulated based on the comparison results. This status is not seen in a database comparison, because when doing so the project is populated only with definitions defined differently. |

**Note:** Compare by release date is determined by finding the highest release label in common between the source and target databases. PSRELEASE.RELEASELABEL column is searched on both source and target to find the latest common value between the two. Then PSRELEASE.PSRELEASEDTM for that label is used for compare by release date for the source and target, respectively. You can override this value to set a different release label, or specific compare by date, on the Upgrade Options interface. Only common release labels (found on both source and target PSRELEASE table) can be used.

## Comparing Source Status to Target Status

The following table summarizes the possible status, action, and upgrade values that could be applied to a single definition during the comparison process.

| <b>Source Status</b> | <b>Target Status</b>   | <b>Action</b> | <b>Other Action</b> | <b>PeopleSoft Vanilla</b> | <b>Keep Customizations</b> |
|----------------------|------------------------|---------------|---------------------|---------------------------|----------------------------|
| Absent               | Changed or Unchanged   | DELETE        | None                | True                      | True                       |
| Absent               | *Changed or *Unchanged | DELETE        | None                | False                     | False                      |
| Changed              | Absent                 | COPY          | None                | True                      | True                       |
| Changed              | Changed or Unchanged   | COPY          | COPYPROP            | True                      | True                       |
| Changed              | *Changed or *Unchanged | COPY          | COPYPROP            | True                      | False                      |
| Unchanged            | Absent                 | COPY          | None                | True                      | True                       |
| Unchanged            | Changed                | COPY          | COPYPROP            | False                     | False                      |
| Unchanged            | Unchanged              | COPY          | COPYPROP            | True                      | True                       |

| <b>Source Status</b> | <b>Target Status</b>   | <b>Action</b> | <b>Other Action</b> | <b>PeopleSoft Vanilla</b> | <b>Keep Customizations</b> |
|----------------------|------------------------|---------------|---------------------|---------------------------|----------------------------|
| Unchanged            | *Changed or *Unchanged | COPY          | COPYPROP            | True                      | False                      |
| *Changed             | Absent                 | COPY          | None                | True                      | True                       |
| *Changed             | Changed or Unchanged   | COPY          | COPYPROP            | False                     | True                       |
| *Changed             | *Changed or *Unchanged | COPY          | COPYPROP            | True                      | True                       |
| *Unchanged           | Absent                 | COPY          | None                | True                      | True                       |
| *Unchanged           | Changed or Unchanged   | COPY          | COPYPROP            | False                     | True                       |
| *Unchanged           | *Changed               | COPY          | COPYPROP            | False                     | False                      |
| *Unchanged           | *Unchanged             | COPY          | COPYPROP            | True                      | True                       |
| Absent               | Absent                 | None          | None                | False                     | False                      |
| Same                 | Same                   | None          | None                | False                     | False                      |
| Unknown              | Unknown                | None          | None                | False                     | False                      |

The Action, Other Action, PeopleSoft Vanilla, and Keep Customizations are described in the following sections.

## Action

Describes the upgrade action set for an item.

| <b>Field or Control</b> | <b>Description</b>   |
|-------------------------|--|
| DELETE                  | (DEL) The item will be deleted from the target database during the copy. |
| COPY                    | The item will be copied to the target database during the copy.          |

### Other Action

Describes the action when the system finds differences in record or field definitions.

---

**Note:** Used for record and field definitions only.

---

| <i>Field or Control</i> | <i>Description</i>  |
|-------------------------|---|
| COPYPROP                | Copy properties of the item only. That is, for records, only copy the record definition, and not record fields. For fields, copy field definition only, and not the field labels. |
| NONE                    | Use the default action instead (DELETE or COPY).  |

### PeopleSoft Vanilla

Describes the setting of the Upgrade flag for the project item when performing the Vanilla Compare type (set on Upgrade Options).

| <i>Field or Control</i> | <i>Description</i>   |
|-------------------------|--|
| True                    | Upgrade flag is ON.  |
| False                   | Upgrade flag is OFF. You must override this value in order to have Copy perform the action set in the Action column. |

### Keep Customization

Describes the setting of the Upgrade flag for the project item when performing the Keep Customizations Compare type (set on Upgrade Options).

| <i>Field or Control</i> | <i>Description</i>   |
|-------------------------|--|
| True                    | Upgrade flag is ON.  |
| False                   | Upgrade flag is OFF. You must override this value in order to have Copy perform the action set in the Action column. |

---

## Comparing and Merging Page Definitions

This section discusses how to compare and merge page definitions.

## Comparing and Merging Page Definitions

To compare and merge page definitions in the Upgrade view:

1. Open the upgrade project, and make sure that you are in the Upgrade view.
2. Open the Pages window within the upgrade project.
3. Select the page(s) that you want to compare.
4. Right-click on the Pages window to display the context menu.
5. Select Diff / Merge Page, and then select one of these options:
  - From Database: select if you are comparing the current definitions with definitions in another database. After doing so, sign on to the appropriate database using the PeopleSoft Signon window.
  - From File: select if you are comparing the current definitions with definitions in a project file. After doing so, navigate to the appropriate file using the Merge from File: Select Project dialog box.

To compare and merge page definitions from the Development view:

1. Open the page definition that you want to compare.
2. Select Diff / Merge Page, and then select one of these options:
  - From Database: select if you are comparing the current definitions with definitions in another database. After doing so, sign on to the appropriate database using the PeopleSoft Signon window.
  - From File: select if you are comparing the current definitions with definitions in a project file. After doing so, navigate to the appropriate file using the Merge from File: Select Project dialog box.

---

**Note:** For the compare to work, the name of the page in the external database or project file must have the same name (the same key value) as the page in the current database.

---

## Working with the Page Compare Results

This section discusses how to:

- Use the Diff / Merge for Page interface.
- Determine differences between page definitions.
- Use the Properties panel.
- Merge attributes and properties from source to target.

### Using the Diff / Merge for Pages Interface

After successfully connecting to the database or file, the interface appears similar to the following example.

The following is a screenshot of Page definition Diff / Merge interface.

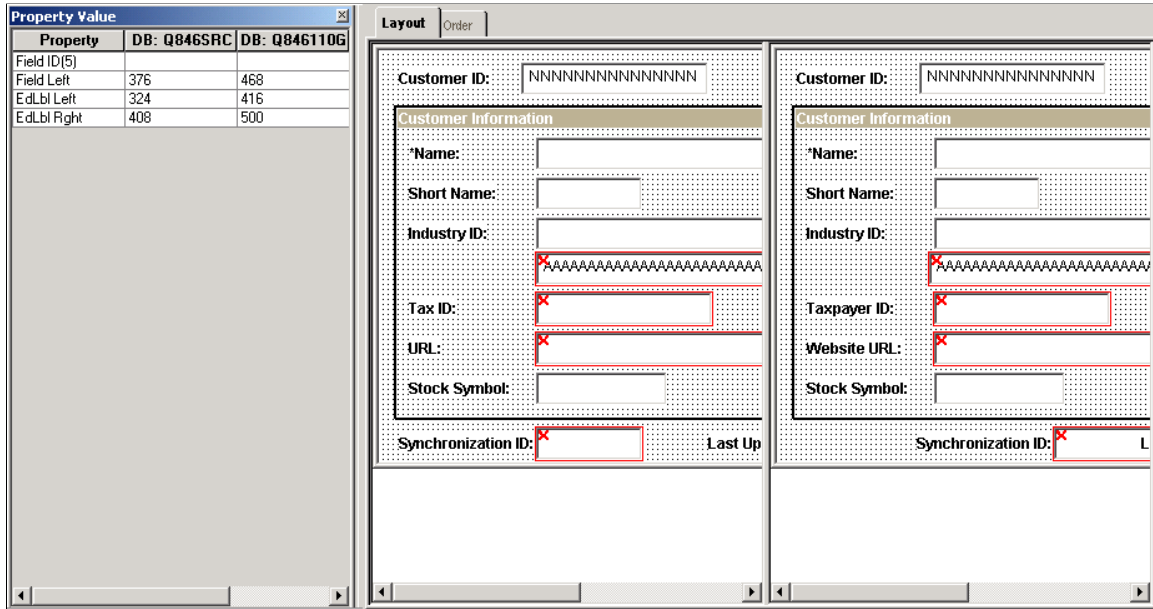

The PeopleSoft Application Designer displays a Property Value panel to show details about every difference or each changed page control. To the right, each page is displayed side-by-side enabling the visual comparison.

---

**Note:** The pages appear in a read-only state. You cannot make any changes to either page definition from the Visual Compare interface.

---

### Determining Differences between Page Definitions

When there are differences between source and target page definitions, the system illustrates this in the Layout tab by surrounding the page field with a red box with a red 'X' at the top, left-hand corner. The field in which you have placed your cursor has a dotted line surrounding it.

The following is a screenshot of determining differences between Page definition Visual Compare as mentioned in the Order tab.

Page controls that have differences are highlighted in red. If you select a page control, you can see easily if its order is different as the highlighted areas do not match.

| Layout |    | Order |                    |               |    |    |    |                    |               |
|--------|----|-------|--------------------|---------------|----|----|----|--------------------|---------------|
|        | ID | Lv    | Label              | Type          |    | ID | Lv | Label              | Type          |
| 1      | 1  | 0     | Customer ID        | Edit Box      | 1  | 1  | 0  | Customer ID        | Edit Box      |
| 2      | 5  | 0     | Status             | Drop Down Lst | 2  | 5  | 0  | Status             | Drop Down Lst |
| 3      | 37 | 0     | Customer Informati | Group Box     | 3  | 37 | 0  | Customer Informati | Group Box     |
| 4      | 3  | 0     | *Name              | Edit Box      | 4  | 3  | 0  | *Name              | Edit Box      |
| 5      | 4  | 0     | Short Name         | Edit Box      | 5  | 4  | 0  | Short Name         | Edit Box      |
| 6      | 9  | 0     | Industry ID        | Edit Box      | 6  | 9  | 0  | Industry ID        | Edit Box      |
| 7      | 39 | 0     | Description        | Edit Box      | 7  | 39 | 0  | Description        | Edit Box      |
| 8      | 7  | 0     | URL                | Edit Box      | 8  | 6  | 0  | Taxpayer ID        | Edit Box      |
| 9      | 6  | 0     | Tax ID             | Edit Box      | 9  | 7  | 0  | Website URL        | Edit Box      |
| 10     | 8  | 0     | Stock Symbol       | Edit Box      | 10 | 8  | 0  | Stock Symbol       | Edit Box      |
| 11     | 28 | 0     | Synchronization I  | Edit Box      | 11 | 28 | 0  | Synchronization I  | Edit Box      |
| 12     | 30 | 0     | Last Update Date   | Edit Box      | 12 | 30 | 0  | Last Update Date   | Edit Box      |

| Field or Control  | Description   |
|---|---|
|  | Use the Previous Difference and Next Difference toolbar buttons to navigate quickly between the differences flagged within the active window. |

### Using the Properties Panel

The Properties panel enables you to view the details regarding the differences between the source and target page controls. You can move the panel and dock it to the desired locations.

By placing your cursor into each page control surrounded by a red box, the differences in properties between the source and target definition for that particular page control appear on the Properties panel. You can also use the TAB key to move from field to field. For page controls that are identical between the source and target, nothing appears in the Properties panel.

The following is a screenshot of Property Value Panel:

Page fields are identified in the Property Value panel by the field ID value displayed on the Order tab. You can find definitions for the fields later on this page.

| Property        | [A] ID848UPG | [B] ID848GES |
|-----------------|--------------|--------------|
| Field ID(5)     |              |              |
| UseDefaultLabel | 0            | 1            |
| Label ID        | AUTHOR       | USERID       |
| Label Text      | Author       | User ID      |

| <b>Field or Control</b>                            | <b>Description</b>   |
|--|--|
| <b>Property</b>                                    | <p>Displays the list of properties associated with a particular page field or control.</p> <hr/> <p><b>Note:</b> The properties appearing for different page fields and controls may differ. Many of the properties are only used internally by PeopleTools for page display and position.</p> |
| <b>[A] &lt;Signed on Database Name&gt;</b>         | <p>Displays the property values for a page field or control residing in the database to which you are currently signed on. In the context of merging pages, this is the "target" definition.</p>   |
| <b>[B] &lt;Database Name/Project File Name&gt;</b> | <p>Displays the property values for a page field or control residing in an external database or project file. In the context of merging pages, this is the "source" definition.</p>  |

**Note:** If needed you can access the page definition properties by selecting File, Object Properties or clicking **ALT + ENTER**.

### Merging Attributes and Properties from Source to Target

When merging attributes of a page definition it is important to keep in mind where the two definitions you are merging reside. The database to which you are signed on is A:, or the "target," and the database or project file from which you are merging page properties is B:, or the "source."

Use the A and B buttons to control the merging of page definitions between the target and source.

| <b>Field or Control</b>   | <b>Description</b>   |
|---|--|
|  | <p>Click <b>B</b> to merge a page field, a control, or the properties of a field, to your target database (A:).</p> <p>Click <b>A</b> to undo any previously merged items from the B page definition. The A button is active only after you have previously merged items from the B page definition.</p> <hr/> <p><b>Note:</b> Before using the <b>A</b> or <b>B</b> buttons, you need to place the cursor on the page field or page control that you intend to merge from one definition to the other.</p> <hr/> <p><b>Note:</b> The only way to manipulate the page definitions during the diff / merge operation is by using the <b>A</b> and <b>B</b> buttons.</p> |

## Using the Merge Output Window

After running a diff / merge for pages operation, the Merge tab appears in the output window of the Application Designer work space. The Merge tab enables you to view the status of your merge operation as it records each event, such as:

- the initiation of the merge.
- the name of the page being compared.
- the number of differences identified between the two definitions.
- the operations that have occurred (merge Add, undo merge, and so on).
- the name of the saved, merged page definition.

For example:

Opening Visual Merge: MYPAGE(Page)

Comparing [A(ENG,DUT)], [B(ENG,DUT)]

2 difference(s)

(5) Merge: [B](ID:5)→[A](ID:5)

(4) Merge, Add: [B](ID:13)→[A](ID:0)

Save [A]:MYPAGE\_NEW(Page)

## Saving Merged Definitions

After you have determined that all of the appropriate page fields and page controls have been merged into your target definition, save your changes. By doing so, the system renames the target definition according to the following naming convention:

<previous\_page\_name>\_NEW



# Working with Text Definitions and Text Files During Upgrades

---

## Understanding Comparing Text Definitions and Text Files

PeopleSoft Application Designer enables you to compare the same text definition shared between two databases (or one database and a file) as well as the same text file used by different PeopleSoft releases. Similar to the Visual Compare interface for pages, you can view the text definitions or files side-by-side while the system detects each difference and clearly indicates the differences using visual queues. During this comparison, you choose which lines from each file or definition to carry forward into the merged version.

---

**Note:** The merge process and interface is identical for all text definitions and text files.

---

Text definitions are Application Designer definitions that are comprised of text, or code. They are:

- PeopleCode
- SQL
- HTML
- XSLT

Text files refer to text files used to store program logic or configuration settings within the PeopleSoft system. They are:

- COBOL files (.CBL).
- Configuration files (.CFG).
- Data Mover script files (.DMS).
- Initialization files (.INI).
- SQR source files (.SQC).
- SQL files (.SQL).
- SQR report files (.SQR).

---

## Comparing and Merging Text Definitions and Files

This section discusses how to compare and merge text definitions and files.

## Running the Merge Process for Text Definitions

To run the merge process for text definitions:

1. Launch the Upgrade Definition Type window for a text definition.
2. Select the definition you want to compare and merge.
3. Right-click, and select Merge Definition.
4. Select one of the following:
  - Database. Select this option if the definition to which you are comparing exists in another database. The system prompts you to sign on to the other database.
  - File. Select this option if the definition to which you are comparing exists in a project file. The system prompts you to navigate to the project file.
5. After selecting what you want to be the result of the final merge, click Save.

## Running the Merge Process for External Text Files

To run the merge process for a single pair of external text files:

1. Select **Tools > Diff / Merge External Text > Files**.
2. In the **To Merge File 'A':** dialog box, navigate to, and select the file you want to merge, and click **Open**.

Typically, the 'A' file is the file that is either older or contains less lines to merge into the most current file.

3. In the **To Merge File 'B':** dialog box, navigate to, and select the file you want to merge, and click **Open**.

Typically, the 'B' file is the file that is most recent and contains more of the lines you want to remain in the resulting merged file.

To run the merge process for multiple pairs of external files:

1. Select **Tools > Diff / Merge External Text > Folders**.
2. In the Merge Folder dialog box navigate to and select the appropriate directory for Folder A: and Folder B:.

How you have the options set on the Merge Properties dialog box, determines to which directory the system saves the merged results.

3. Select **Include sub-folders** if you intend to compare multiple sub-folders within one directory, otherwise, the system only compares and merges files in the immediate directory specified.
4. Click **OK**.

## Using the Merge Interface

The following is a screenshot of Merge interface for a text definition.

The merge interface displays three windows: the A: window, the B: window, and the Output window.

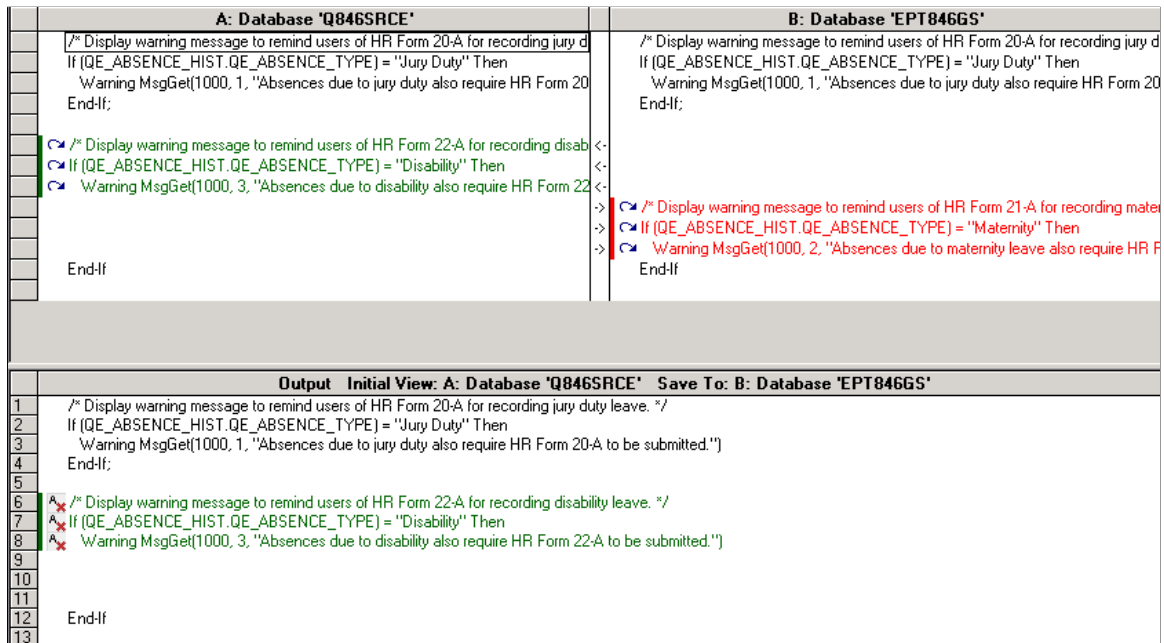

The following is a screenshot of Merge interface for an external text file.

The merge interface displays three windows for an external text file: the A: window, the B: window, and the Output window.

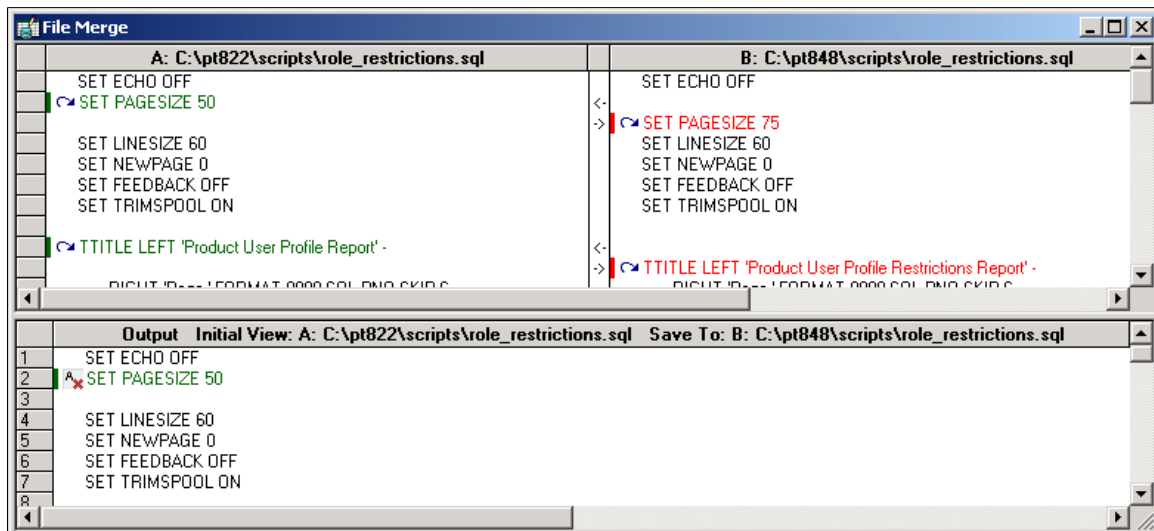

## Working with the A: and B: Windows

| <b>Text Type</b>   | <b>Description</b>   |
|--------------------|--|
| Text definition    | <p>The A: window displays the definition existing in the database to which you are currently signed on. Code that appears only in this definition appear in the color specified in the Merge Properties for A:.</p> <p>The label of the A: window adheres to the following syntax:</p> <p>A: Database '&lt;Database Name&gt;'</p> <p>The B: window displays the definition existing in the database or file to which you are comparing the definition existing in database A:.. Code that appears only in this definition appear in the color specified in the Merge Properties for B:.</p> <p>The label of the B: window adheres to the following syntax:</p> <p>B: &lt;Database/File&gt; '&lt;Database/File Name&gt;'</p>  |
| External text file | <p>The A: window displays the text file specified in the <b>To Merge File 'A'</b> dialog. Code that appears only in this file appears in the color specified in the Merge Properties for A:.</p> <p>The label of the A: window adheres to the following syntax:</p> <p>A: &lt;file path&gt;</p> <p>The B: window displays the text file specified in the <b>To Merge File 'A'</b> dialog. Code that appears only in this text file appears in the color specified in the Merge Properties for B:.</p> <p>The label of the B: window adheres to the following syntax:</p> <p>B: &lt;file path&gt;</p> <hr/> <p><b>Note:</b> If you are comparing and merging multiple files in a directory structure (using the Folders option), you view individual pairs of files by selecting them in the Folder Merge Diff List window.</p> <hr/> |

**Note:** In the context of the merge feature, there is not necessarily a concept of "source" and "target." Assigning an "A" and "B" value is used only to distinguish the different locations of definitions and external text files.

## Working with the Output Window

The output window displays what will be the finished result of the merge after clicking Save.

Initially either the A: or B: definition view will appear, depending on what you selected as the Initial Output View in the Merge Properties dialog. The **Initial View** window label displays the value you selected.

The output window label also displays the **Save To** value, which represents the location in which the merged results will be saved.

You can perform simple editing of a line in a text definition appearing in the output window, but you cannot add new lines.

---

**Note:** The Merge tab of the PeopleSoft Application Designer output window, displays any PeopleCode compile syntax errors. The merged result cannot be saved if there are syntax errors.

---





**Note:** While there is an output window for the merge feature, the output window for the PeopleSoft Application Designer is also visible.

---

**Note:** PeopleSoft Application Designer does not provide a method for you to track the change history of a text definition or external file. Developers must keep track of the changes made during the merge process.

---

## Moving Lines of Code into the Output Window

| <i>Field or Control</i>   | <i>Description</i>  |
|---|---|
|   | Click the arrow button to insert lines of code from window A: or B: into the output window. This button only appears next to lines of code in the A: and B: windows that are unique to that definition or file. |
|  | Click this button to remove from the output window lines of code that exist only in the A: definition or file.  |
| <i>Field or Control</i>   | <i>Description</i>  |
|  | Click this button to remove from the output window lines of code that exist only in the B: definition or file.  |
|  | Use the Previous Difference and Next Difference buttons to navigate quickly between the differences flagged within the active window.   |

## Saving Merged PeopleCode

After you are satisfied with PeopleCode in the output window that you have merged, click Save to save the changes to the database specified as the Save Output Destination.

After you have successfully saved the merged PeopleCode, to view the merged PeopleCode as it appears in the Saved Output Destination, click the line in the output window indicating that the PeopleCode was successfully saved.

### **Saving Merged External Files**

After you are satisfied with the content of the output window, click Save to save the changes to the file specified as the Save Output Destination in the Merge Properties. To view the results, navigate to the directory containing the file and open it using the appropriate program.

---

## **Working with Merge Properties**

This section discusses how to work with merge properties.

### **Accessing the Merge Properties Dialog Box**

You access the Merge Properties dialog box after first running the merge process. Then you select File, Definition Properties.

If you change any properties, and click OK, PeopleSoft Application Designer applies those to the current merge results. Your merge property changes are applied to all future merge results.

### **Viewing and Setting Merge Properties**

This section discusses how to:

- Set Merge properties.
- View "A" and "B" properties.

#### **Setting Merge Properties**

Access the Merge Properties dialog box and select the Merge tab.

The following is a screenshot of Setting Merge Properties dialog box showing merge tab. You can find definitions for the fields and controls later on this page.

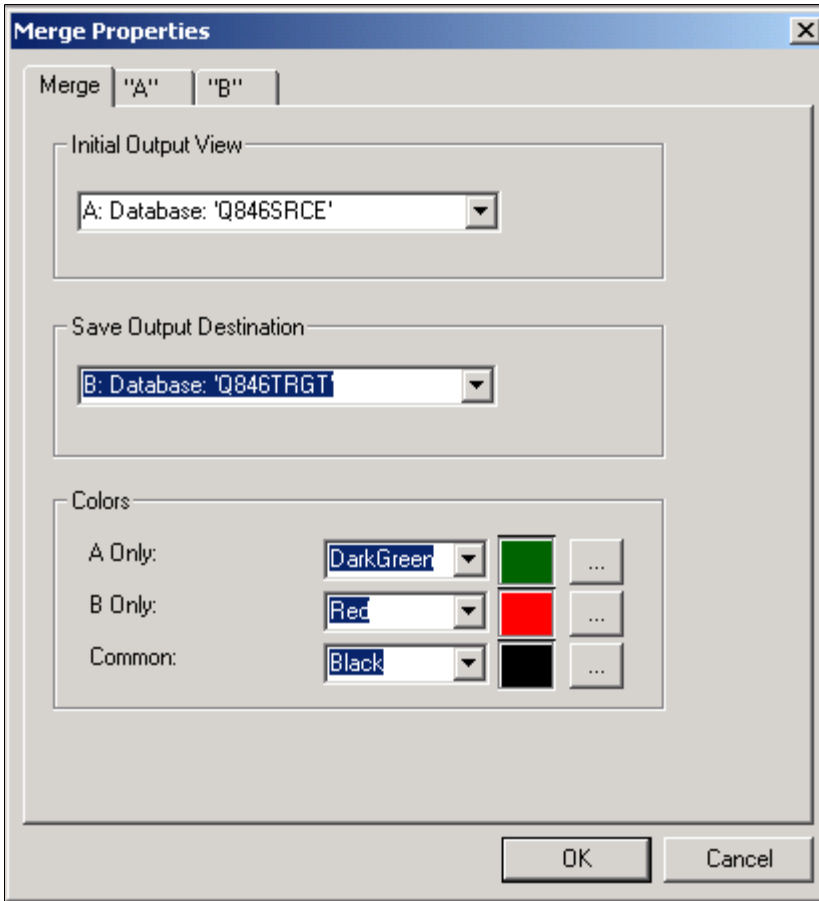

| <b>Field or Control</b>        | <b>Description</b>   |
|--------------------------------|--|
| <b>Initial Output View</b>     | Select the definition you want to appear in the output window of the compare interface. Typically, you set the <b>Initial Output View</b> to contain the definition that would have the most modifications to accept. Either "A" or "B" can be selected. |
| <b>Save Output Destination</b> | Select the location where the system saves the contents of the merged output window. The location you select appears on the title bar of the output window.<br><br><b>Note:</b> You cannot save the output to a file.                                    |

| <i>Field or Control</i> | <i>Description</i>   |
|-------------------------|--|
| <b>Colors</b>           | <p>Specify the colors that the system should associate with each definition to enhance readability.</p> <ul style="list-style-type: none"> <li>• <b>A Only:</b> Select the color to attribute to text that appears only in definition A.</li> <li>• <b>B Only:</b> Select the color to attribute to text that appears only in definition B.</li> <li>• <b>Common:</b> Select the color to attribute to text that appears in definition A and B.</li> </ul> |

## View "A" and "B" Properties

Access the Merge Properties dialog box and select either the "A" or "B" tab.

The following is a screenshot of Merge properties dialog box showing "A" tab.

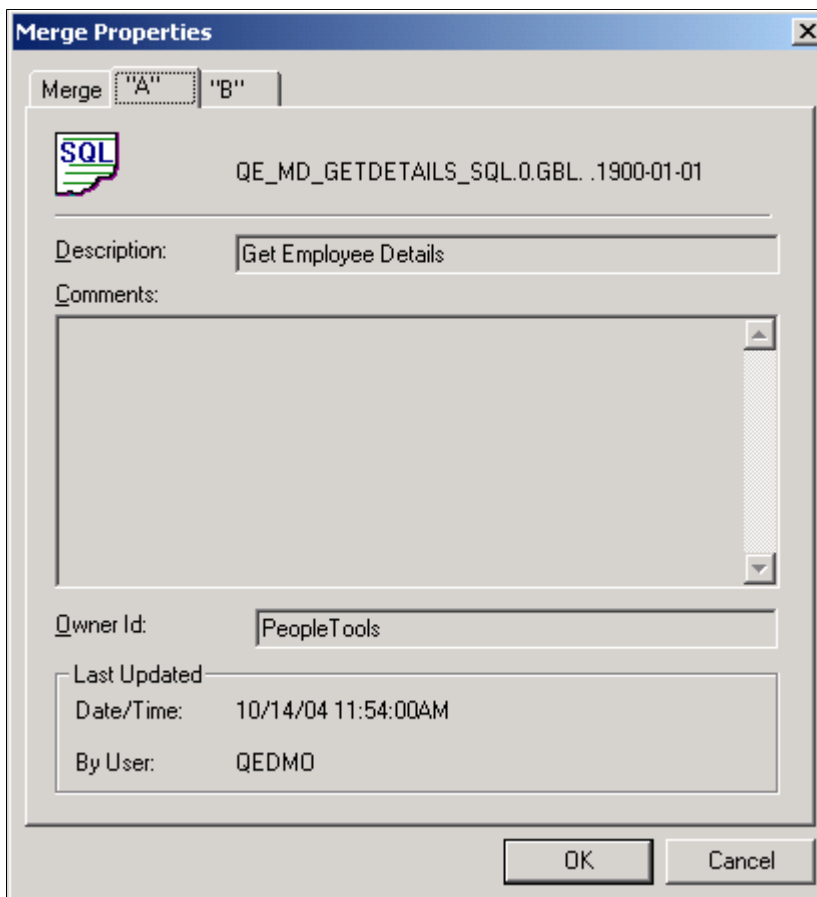

The "A" and "B" tabs display the properties for the current A and B definitions, respectively. These settings are read-only.

---

**Note:** PeopleCode definitions do not possess description or Owner ID properties, so these properties appear blank for PeopleCode definitions.

---

## Running a Project PeopleCode Diff/Merge

This section discusses how to run a Project PeopleCode Diff/Merge.

### Understanding the Project PeopleCode Diff/Merge

Running a Project PeopleCode Diff/Merge enables you to compare all the PeopleCode definitions in your upgrade project with another database or file simultaneously. If you have numerous PeopleCode definitions to compare and merge, this feature can save you time.

---

**Note:** The Project PeopleCode Diff/Merge feature is only available for PeopleCode definitions. For SQL, HTML, and XSLT definitions, you need to merge each definition separately.

---

### Running a Project PeopleCode Diff/Merge

To run a Project PeopleCode Diff/Merge:

1. Select Tools, Diff/Merge Project PeopleCode.
2. Select either:
  - Database: select this option if you are comparing definitions with another database. The system will prompt you to sign on to the appropriate database.
  - File: select this option if you are comparing definitions existing in a file. The system will prompt you to navigate to the appropriate file.

### Using the Project PeopleCode Diff/Merge

After running the Project PeopleCode Diff/Merge process a blank merge interface appears and the PeopleCode Diff List window appears at the bottom of the Application Designer workspace.

The following is a screenshot of using the PeopleCode Diff List window.

| Project Q846SRCE PeopleCode Diff List |  |   |
|---------------------------------------|--|---|
|                                       | Item   | Diff  |
| 1                                     | ACCESSLOGQRYWRK.URL_1.RowInit (Record PeopleCode)            | different (A: Database 'Q846SRCE' is more recent) |
| 2                                     | AEREQUESTPARM.AE_BIND_VAR.FieldChange (Record PeopleCode)    | different (A: Database 'Q846SRCE' is more recent) |
| 3                                     | QE_ABSENCE_HIST.QE_ABSENCE_TYPE.SaveEdit (Record PeopleCode) | identical   |

The Item column contains the reference to every PeopleCode definition in the project.

The Diff column indicates whether the comparison between the two definitions uncovered any differences. If there is no difference between the two definitions, the word “identical” appears in the Diff column. If there are differences between the two definitions, the word “different” appears in the Diff column, and indicates which definition is more recent. If the definition appears in only one location, the

Diff column text will read "A only" or "B only." If the definition is not present in either location the Diff column text will read "Absent in both."

When differences are found, the system highlights the row in red also. A and B only lines appear in blue.

Double-click a row in the PeopleCode Diff List to populate the merge interface above and view the differences between the two definitions.

## Related Links

[Using the Merge Interface](#)

## Filtering the Project PeopleCode Diff List

When working with numerous PeopleCode definitions, for ease of use you may need to reduce the number of rows appearing in the diff list. To filter what appears in the diff list, select or deselect these items from the View menu.

| <b><i>Field or Control</i></b> | <b><i>Description</i></b>  |
|--------------------------------|--|
| Show Identical Items           | Show items that are identical in both data sources.                  |
| Show A-Only Items              | Show items that exist only in the A: data source.                    |
| Show B-Only Items              | Show items that exist only in B: data source.                        |
| Show Different Items           | Show items where a difference is found between the two data sources. |
| Show Absent Items              | Show items where a definition is absent in either data source.       |

## Chapter 5

# Copying Projects and Definitions

---

## Reviewing Upgrade Settings

After your project is populated with definitions and has been compared (if applicable), review it and check the upgrade settings before copying it. To reduce the number of definitions through which you must search, filter out the information that you don't need to see by setting your view options. Afterwards, you can adjust the default upgrade settings.

## Selecting View Options

Filter your view of the upgrade definition window by selecting one of the options in the View, Filtering menu. These same options are available in the upgrade pop-up menu in the Filtering menu. The options are:

| <i>Field or Control</i>       | <i>Description</i>  |
|-------------------------------|---|
| <b>No Filtering</b>           | Select to display all definitions.  |
| <b>Tagged for Upgrade</b>     | Select to display only definitions with the <b>Upgrade</b> check box selected.                        |
| <b>Not Tagged for Upgrade</b> | Select to display only definitions with the <b>Upgrade</b> check box cleared.                         |
| <b>Done</b>                   | Select to display only definitions with the <b>Done</b> check box selected.                           |
| <b>Not Done</b>               | Select to display only definitions with the <b>Done</b> check box cleared.                            |
| <b>Custom Filtering</b>       | Select to open a dialog box in which you can specify which definition status combinations to display. |

When you apply a filter, the filter type appears in the bar above the upgrade columns.

## Selecting Custom View Settings

Select **View > Filtering > Custom Filtering** to access the Custom Filtering dialog box, which includes a matrix that is similar to that found on the Report Filters tab in the Project Properties dialog box.

## Custom Filtering

Select the definition status combinations to display in the upgrade definition window.

The following is a screenshot of selecting Custom view settings in the Custom Filtering dialog box. You can find definitions for the fields and controls later on this page.

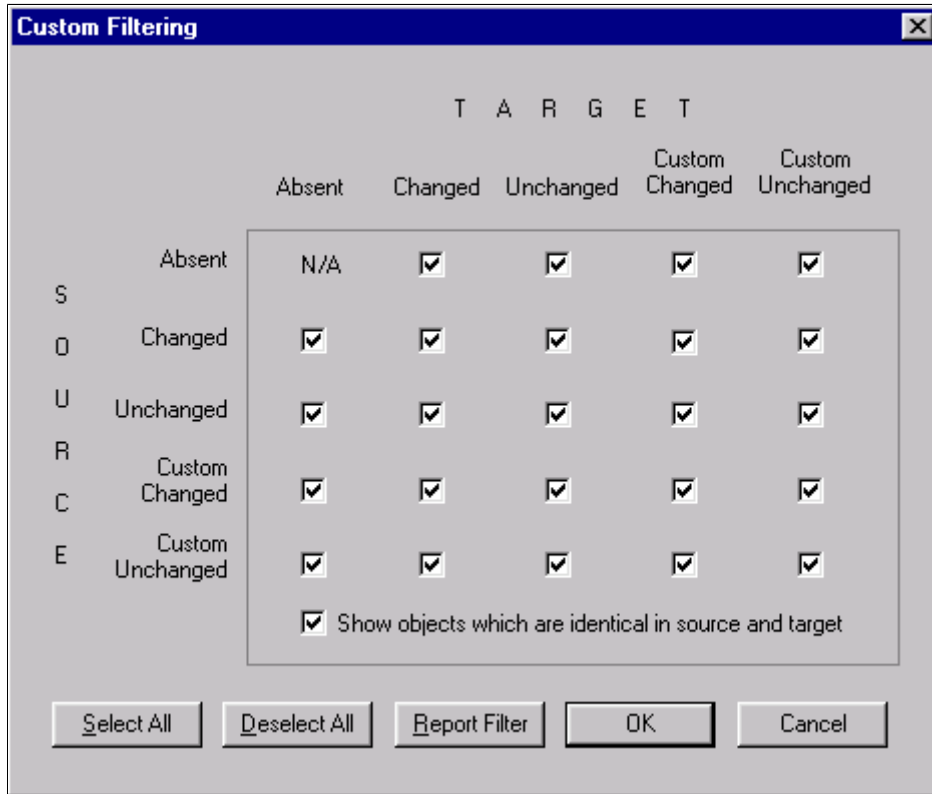

| <i>Field or Control</i>                                      | <i>Description</i>  |
|--|---|
| <b>Report Filter</b>   | Click to set these options to be the same as your settings on the Report Filter tab in the Project Properties dialog box.   |
| <b>Show objects which are identical in source and target</b> | Select to display definitions with a status combination of Same and Same. This status combination is possible only if you performed a project comparison and if definitions in the project were defined the same way in the source and target. You can never have a Same and Same status combination for definition types on which you performed a database comparison. |

## Overriding Upgrade Defaults

After reviewing your project and its compare reports, you can override the default upgrade column values for any definitions by changing the **Upgrade** and **Action** values.

For example, to preserve a definition that PeopleSoft Application Designer plans to delete from the target (**Action** is *Delete* and the **Upgrade** check box is selected) change the **Upgrade** value. You can also remove a definition from the project. This does not delete the definition from the database.

Overriding defaults helps if you want to propagate deletions from one database to another.

### Specifying Whether Action is Taken on a Single Definition

To specify whether action is taken on a single definition, select or clear the definition's **Upgrade** check box.

When the **Upgrade** check box is selected, the displayed action is performed when you copy the project. If the check box is cleared, no action is taken.

### Specifying Whether Action is Taken on a Group of Definitions

To specify whether an action is taken on a group of definitions:

1. Select a group of definitions.

Use the **Ctrl** and **Shift** keys, or select all definitions in the upgrade definition window by clicking the top, left-hand cell of the grid.

2. Right-click one of the definitions and select one of these options:

- Tag for Upgrade

Select to select the **Upgrade** check boxes for all of the selected definitions.

- Untag for Upgrade

Select to clear the **Upgrade** check boxes for all of the selected definitions.

### Specifying Which Action is Performed on a Definition During a Copy

To specify which action is performed on a definition during a copy:

1. Click the **Action** cell of the definition.

This activates a drop-down list box in the cell.

2. Select *Copy* or *Delete* from the drop-down list box.

### Remove a Definition From a Project

To remove a definition from a project, select the definition and press **Del**.

### Selecting and Tagging Definitions for Copying or Deleting

To select and tag definitions for copying or deleting:

1. Select the definition rows.
2. Right-click one of the definitions and select Set Action.

3. Select *Copy* or *Delete*.

Your selected definition reflects this change in the **Action** column. When you upgrade the project, it is copied or deleted from the target database.

You can also select *Set Action for Project* to tag all of the definitions in a project for a selected action.

## Recording Upgrade Settings

After you change the default upgrade settings, save the project. You might also want to print a hard-copy record of the project in its current state. You can rerun the Compare process (as a project compare) to regenerate new upgrade reports, or you can print the contents of the upgrade definition window to save a high-level view of the project.

### Regenerating Upgrade Reports

To regenerate upgrade reports:

1. Set up the reporting filter.
2. Perform a project comparison.

A project comparison compares only the definitions in the project, not the action and upgrade settings. Your project contents are not altered unless record fields have changed in the target database, in which case the corresponding changes are made in the project.

This comparison generates new upgrade reports that reflect the configured action and upgrade settings.

### Printing the Contents of the Upgrade Definition Window

To print the contents of the upgrade definition window:

1. Open the upgrade definition with the appropriate definition type displayed.  
To do this, select the appropriate folder in the upgrade view.
2. Select **File > Print**.

The print job is automatically in landscape format.

---

## Copying Projects

This section provides an overview of project copy options.

---

**Note:** When upgrading from one database to another some migrated images may not display in a browser. To remedy this situation manually clear the cache files in your browser after the project is copied. For more information about clearing the browser cache, refer to the documentation for your internet browser version.

The Copy Project from File and Copy to Project to File menu items are available only to users who have upgrade security or read-only access to the database. If these menu items are not available to you, contact your system administrator to update your security profile.

---

## Understanding Project Copy Options

There are two ways to copy projects to another database:

- Copying a source project directly to a target database to which you are connected.
- Copying a source project to a file and then copying the file to a target database.

This feature provides more flexibility in moving PeopleTools definitions and projects across databases. To move definitions to another database, you copy definitions to a target directory and files instead of another database. The directory and files can be local or reside on a file server. These files then become the source when copying a project from a file. Note, however, that not all definition types that are supported by the Copy to Database process are supported by the Copy to/from File processes. Those that are not supported must be migrated using Copy to Database.

See [Definition Types That You Can Upgrade](#).

## Copying Projects to a Target Database

To copy a project:

1. (Optional) Lock target database definitions.

Before PeopleSoft Application Designer replaces or deletes a definition in the target database, it checks to determine whether the definition has a change control lock applied. If so, PeopleSoft Application Designer takes action on that definition if it has been locked by the same user ID that is performing the copy. Consequently, the speed of a copy might be slow because every definition to be deleted or replaced in the target must be checked.

You can avoid the performance degradation by locking all of the database definitions in the target database by using the Change Control Administrator dialog box. This sets a flag telling PeopleSoft Application Designer not to check the lock status of every definition. When all target definitions are locked, the copy is faster.

2. Deactivate all system tracing.
3. Select **Tools > Copy Project > To Database** from the PeopleSoft Application Designer toolbar.

The Target Signon dialog box appears, prompting you to sign in to a target database.

4. Sign in to the target database as you do with any PeopleSoft database.

The Copy dialog box appears.

5. In the Copy dialog box, specify the types of definitions to copy and start the Copy process.
6. (Optional) Select the **Reset Done Flags** check box.

Any definition with a selected **Done** check box is not copied. The first time that you copy a project, all **Done** check boxes are cleared. When you're repeating a copy due to problems found the first time, however, you might want to clear the **Done** check boxes of definitions that were copied incorrectly. Clear all project **Done** check boxes from the Copy dialog box by selecting **Reset Done Flags**. This option is selected by default.

7. (Optional) Select the **Copy Project Definition** check box.

If you select this check box, the project definition is copied to the target database.

8. Select the definition types to copy.

Only the definition types that exist in the project are displayed in the **Object Type(s)** list. To select all types, click **Select All**. You can also copy one definition type at a time (repeat this procedure each time).

---

**Note:** If you copy definition types individually, copy them in the order in which they're presented in the dialog box. For instance, start with records, then indexes, and so on.

---

9. Click **Copy**.

As the Copy process runs, a progress indicator appears on the status bar of the dialog box, displaying the definition type, the total number of definitions to copy, and the number copied so far.

10. After the copy completes, check for messages.

If you find any problems, correct them and repeat the copy.

11. Stamp the database.

To track the history of the configuration upgrades, PeopleSoft recommends that you stamp the target database after each copy.

## Copying a Project to Multiple Databases

When copying a project to multiple databases, or multiple PeopleSoft systems, use one of the techniques described in this section to ensure that version numbers remain in the correct sequence.

- Sign off and re-sign onto Application Designer between each project copy to a new environment. This ensures the target environment version is being incremented for each copy. If you do not sign off and re-sign onto the system, the version from the previous target environment will be incremented in the next target environment, which may result in a version discrepancy.
- Use Change Assistant.  
See "Understanding Change Packages" (Change Assistant and Update Manager).
- Create a batch file with multiple PSIDE command lines: one for each system.

See [Copying Definitions Using the Command Line](#).

## Copying a Project to a File

To copy a project to a file:

1. Open the project that you want to copy.
2. Select **Tools > Copy Project > To File**.

The Copy File dialog box appears.

3. Select the objects that you want to copy, and enter the output directory.

#### 4. Click **Copy**.

If the file already exists, a confirmation dialog box appears asking if you want to overwrite the existing project. Select **Yes** to continue and overwrite project or **No** to cancel the Copy process.

The Progress dialog box shows the progress of the Copy process as it copies each definition in the project to the specified directory. If you click the **Cancel** button, the system cancels the Copy process. Any files that were created by the Copy process are removed from the specified directory. To continue copying a project, restart the Copy process if it was canceled.

When the Copy process completes successfully, a directory with the same name as the current project is created under the specified export directory. This directory contains the PeopleTools definitions and project definition in XML file format.

---

**Note:** Index key fields are not copied to the project file in certain cases when the session language set in Configuration Manager *does not* match the base language for your installation. For best results, set your session language to match the base language before performing a project copy to file.

---

## Copying a Project From a File

The Copy Project From File command in the Tools menu imports PeopleTools definitions and the project definition from a file that was previously copied by using the Copy To File feature.

### Tracking Fixed Incidents

When PeopleSoft delivers a software update, it is in the form of a change project file. This project file usually includes enhancements or updates that fix incidents. You can view incident IDs and their dependencies before you copy the file to the target database.

To view incident IDs that were included in the project file:

1. Open the maintenance project that you are planning to copy to the database.
2. Click the **Project Properties** button.
3. Select the Update IDs tab.

This tab contains a list of update IDs that were fixed and applied to the software.

4. Select the Pre-Requisites tab.

This tab contains a list of update IDs that are dependent on other fixes that are being applied. These are validated against the target database when you copy the project. If a fix in the Pre-Requisites list has not been applied, a message appears, indicating that the target database is missing a dependency. The only way to have the system allow you to copy projects that have dependencies that are not applied is to select the **Override Pre-Requisites** check box.

---

**Note:** We can track applied update ID fixes only through the Copy Project From File command in the Tools menu. Therefore, every update ID fix that PeopleSoft delivers is in a change project that must be copied to your database.

---

See “Creating a Change Project” (Change Assistant and Update Manager)

## Copying From a File a Project That Does Not Exist in the Database

To copy a project from a file:

1. Select **Tools > Copy Project > From File**.

The Copy From File: Select Project dialog box appears.

2. Browse to locate the project file or select the file from the **Projects** list.

---

**Note:** You can use the Open button to open folders while browsing. It does not open the project file and begin the copy process.

---

You can copy only one project from a file at a time.

3. Select the project from the projects list by clicking **Select** or double clicking the project name.

The Copy From File dialog box appears.

4. Select whether to use the project definition from the file or the database, and click **OK**.

5. Select the definition types to copy.

The **Definition Type(s)** list shows the definition types that have been exported and are available to be copied into the database.

6. Select the **Override Pre-Requisites** check box if required.

You can select the Override Pre-Requisites check box if you want the system not to check for project prerequisites and apply the project regardless of prerequisites that have not been applied.

7. Select the **Compile PeopleCode after Import** check box.

You can select the Compile PeopleCode after Import check box to compile all the PeopleCode programs in the Project.

8. Click to Options button.
9. Select the Copy Options tab.

This example illustrates the fields and controls on the Copy Options tab. You can find definitions for the fields and controls later on this page.

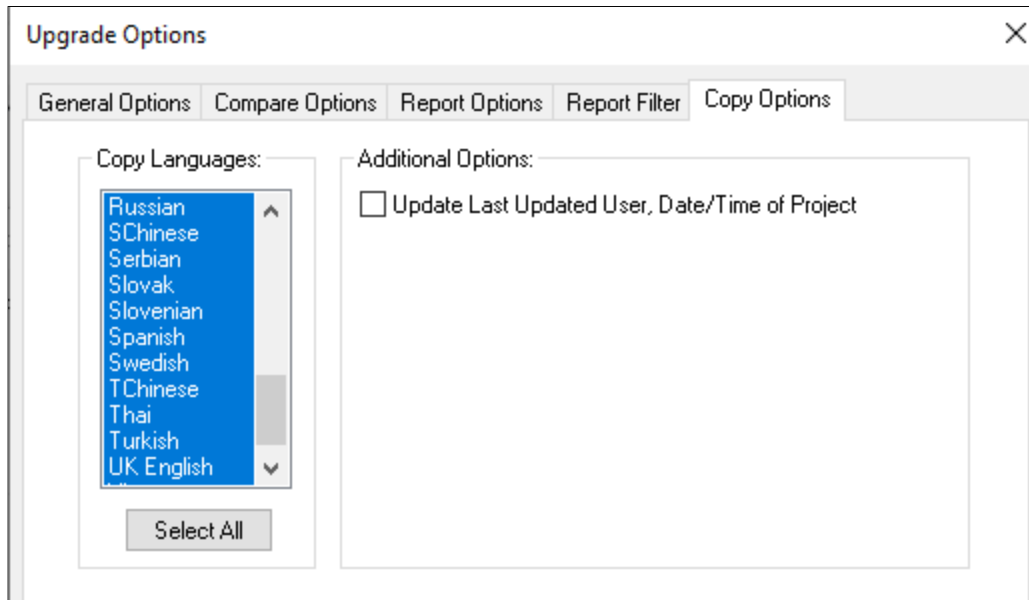

| <b>Field or Control</b>                        | <b>Description</b>   |
|--|--|
| Copy Languages                                 | Select the languages to copy.  |
| Update Last Updated User, Date/Time of Project | By default when you copy a project from file, the last update date for the project is shown as time when the file was created. Select this option to set the LASTUPDOPRID to current signed on userid and LASTUPDDTTM to current date. |

#### 10. Click **Copy**.

There are two phases to the Import process: content on the XML file is written to the system cache directory (as specified in the PeopleSoft Configuration Manager) under a stage directory for the current database. Then the cache is copied to the database. When the import is complete, the cache files are deleted.

The Progress dialog box shows the progress of the Copy process as it copies each definition from the export directory into the attached database. When the Copy from File process successfully completes, the system creates a new project definition from the PeopleTools definitions in the current database.

If you click the **Cancel** button before copying the project, the project becomes invalid and the system deletes the project reference from the database.

---

**Note:** When copying application packages and Portal Registry Structures, the Progress dialog box may display unexpected counting behavior, making it appear that definitions are being processed more than once. This behavior is expected.

---

## Copying From a File a Project That Does Exist in the Database

The process for copying a project from a file when a project of the same name exists in the database is slightly different. After selecting Tools, Copy Project, From File and a project of the same name already exists in the database to which you are currently signed on, the following dialog box appears.

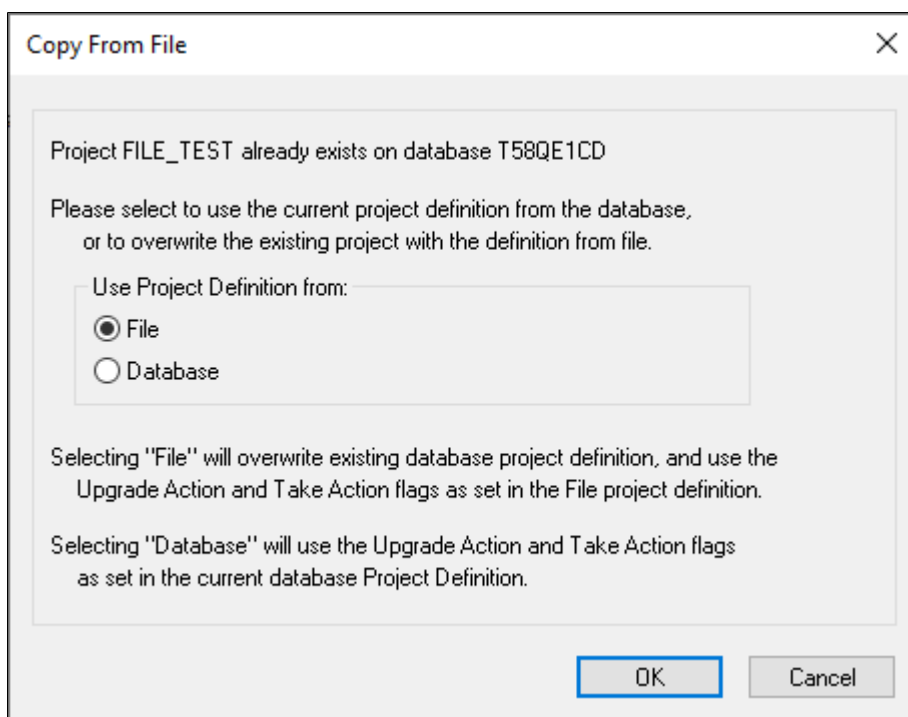

This prompt enables you to specify which project definition to use, the one stored in the database to which you are signed on or the one stored in the file from which you intend to copy. Keep in mind that the project definition is the metadata of the project and determines which definitions (pages, fields, records, and so on) are members of the project.

| <b>Field or Control</b> | <b>Description</b>   |
|-------------------------|--|
| <b>File</b>             | <p>Select this option if you intend to copy the project stored in the file regardless of any Upgrade Action or Take Action settings in the database.</p> <hr/> <p><b>Note:</b> By selecting this option, you overwrite the project definition of the same name that previously existed in the database.</p> <hr/> <p><b>Important!</b> After selecting File and clicking OK, the second Copy From File dialog box appears where you can view source and target information, select Definition Types, select copy options, and so on. If you select Cancel from this dialog box, the project file does not get copied into the database, however, the existing project definition <i>will be deleted from the database.</i></p> |

| <i>Field or Control</i> | <i>Description</i>  |
|-------------------------|---|
| <b>Database</b>         | Select this option if you intend to maintain control of the upgrade project definition stored in the database and manually override any Upgrade Action or Take Action settings. |

## Stamping the Target Database

After successfully copying a project into the target database, "stamp" it to reflect the fact that it has changed from its previous customer release level. This helps to identify modifications that you make after this version of the database.

To stamp the target database:

1. Select **Tools > Upgrade > Stamp Database**.

Use this dialog box to specify and stamp the database with a new customer release level.

2. Enter the new customer release value.

The new customer release value must be greater than or equal to the previous value.

---

**Note:** Once you are on application release 9.2, the PeopleSoft Release and Service Pack will not change.

---

3. Click **Stamp**.

### Related Links

“Change Control Stamping” (Application Designer Developer’s Guide)

## Reusing Projects

PeopleSoft Application Designer enables you to reuse projects. To reuse a project, clear the **Done** check boxes for the definitions to be recopied. You might also want to validate the project integrity and delete

invalid definitions. However, this is not necessary. During a copy, invalid definitions are reported and ignored.

## Validating Project Integrity

To validate project integrity:

1. Select **Tools > Options**.
2. Select the Validate tab.

Use this tab to specify what kind of checks you want to perform during a project validation. This procedure discusses only project integrity validation.

3. Select the **Validate project integrity** check box.
4. Click **OK**.
5. Select **Tools > Validate**.

A message appears, asking whether you want to delete and report invalid definitions or just to report them.

---

**Note:** An invalid definition is any definition in the project with an Add or Replace action that does not exist in the database. PeopleSoft Application Designer does not act on definitions with a Delete action, because it assumes that you want to retain such definitions in the project—regardless of whether they still exist in the database—for the purpose of deleting the same definition in a target database.

---

## Resetting All Done Check Boxes

To reset all **Done** check boxes, right-click in the upgrade definition window and select **Reset Done Flag**. To reset them for the entire project, select the **Reset Project Done Flags** option. You can also select **Edit > Upgrade > Reset Project Done Flags** from the main menu. All **Done** check boxes for all definitions in the project are cleared.

## Resetting Done Check Boxes for a Group of Definitions

To reset **Done** check boxes for a group of definitions:

1. Select a group of definitions.  
Use the **Ctrl** and **Shift** keys, or select all definitions in the upgrade definition window by clicking the top, left-hand cell of the grid.
2. Right-click one of the definitions and select Reset Done Flag.

You can also select **Edit > Upgrade > Reset Done Flag** from the main menu. This clears all **Done** check boxes for the selected definitions.

## Resetting the Done Check Box for a Single Definition

To reset the **Done** check box for a single definition, clear the **Done** check box for the definition.

---

**Note:** You can only manually *clear* **Done** check boxes. You cannot activate these check boxes yourself; they are automatically selected after a successful copy.

---



# Working With Alter Analyzer

---

## Understanding the Alter Analyzer

In addition to PeopleSoft Application Designer compare features, you can also use the Alter Analyzer to compare the PeopleSoft record source and target metadata, gaining insight into an Alter operation. The Alter Analyzer does not compare all application metadata, just selected attributes, highly relevant to the application DDL.

In most cases, the Alter Analyzer will be used during PeopleSoft application upgrades, and specific instructions for setting this up appear in your PeopleSoft upgrade instructions and Change Assistant templates. The Alter Analyzer applies, for the most part, to the traditional PeopleSoft upgrade process referred to as "upgrade in place." The main focus of the Alter Analyzer is to enable you to determine the DDL implications of applying a change to the metadata. The change can be a new release (upgrade), but could also be a patch, a bundle, a maintenance pack, and so on.

The Alter Analyzer consists of two Application Engine programs that:

1. Load selected record metadata values from the database into a set of staging tables to create a 'base line' of your metadata, capturing a snapshot of the metadata at that time.
2. Compare the equivalent metadata attributes between the baseline and the target record metadata.
3. Record metadata differences between baseline and target record metadata in the alter repository for ongoing analysis.

A typical scenario when using the Alter Analyzer would be:

1. Run the metadata loading program to establish a baseline of the metadata.
2. Apply the metadata change(s).
3. Run the metadata analyzer program, and review the alter repository information.

Benefits of the Alter Analyzer include:

- Insight into the alter process, which enables the upgrade process to become more fine-tuned. Designers of the PeopleSoft application upgrade process can use the Alter Analyzer (internally) to rearrange the alter process, making it more modular and flexible, which passes on improved performance to customers upgrading applications.
- A record of all metadata changes can be stored in the alter repository, which you can refer to, query, run reports against as needed, both during and after an upgrade.
- Improved visibility of important record metadata changes, especially if there is a large volume of record and record field definitions to be compared. With the alter repository, you can quickly access the most relevant changes related to DDL.

---

**Note:** While the upgrade process can involve various releases of PeopleTools, the Alter Analyzer is designed for and tested only on PeopleTools 8.50 and later versions.

---

## Related Links

Lifecycle Management Guide

“Running Application Engine Programs” (Application Engine)

---

## Loading Metadata

In order to compare the source and target metadata, the selected record metadata attributes need to be extracted from the metadata tables. This creates a baseline of your metadata, against which you can compare changes. You load the metadata required for Alter Analyzer by running the PTALTDATLOAD Application Engine program. PTALTDATLOAD, runs against a subset of PeopleTools metadata tables, storing metadata related to record definitions into the metadata load PeopleTools tables.

Keep in mind that this process is designed for the "alter in place" upgrade process, where the source and target exist within the same physical database. PTALTDATLOAD runs against the current metadata tables, extracts the important record metadata attributes, and creates your metadata baseline. Then future alter processes can be compared against this baseline.

| <i>Metadata Load Table</i> | <i>Description</i>                                |
|----------------------------|---|
| PS_PTRECDEFN               | Stores selected values from source PSRECDEFN.     |
| PS_PTRECFLDDB              | Stores selected values from source PSRECFLDDB.    |
| PS_PTDBFIELD               | Stores selected values from source PSDBFIELD.     |
| PS_PTOBJCHNG               | Stores selected values from source PSOBJCHNG.     |
| PS_PTOPTIONS               | Stores selected values from source PTSOPTIONS.    |
| PS_PTAEAPLTMPTBL           | Stores selected values from source PSAEAPLTMPTBL. |
| PS_PTAEAPPLDEFN            | Stores selected values from source PSAEAPPLDEFN.  |
| PS_PTINDEXDEFN             | Stores selected values from source PSINDEXDEFN.   |
| PS_PTKEYDEFN               | Stores selected values from source PSKEYDEFN.     |

---

**Note:** The metadata load tables exist in PeopleTools 8.50 and later version of PeopleTools.

---

## Running the Alter Analyzer

After loading the metadata and creating a baseline, you would then begin applying metadata change(s). When doing so, you can periodically run the PTALTANLYZR Application Engine program, which compares metadata changes to the stored metadata (the baseline) and inserts differences into the alter repository.

## Working with the Alter Repository

This section discusses how to work with the alter repository.

### Understanding the Alter Repository

The alter repository consists of a set of tables designed to store the results of the PTANALYZER program run, as well as some static information to be used for reference. Once the PTANALYZER program runs, the alter repository will contain information for each definition where metadata attributes differ between the source and target databases. Use a SQL editor or reporting application to query the repository and extract the information you require. This will require a working knowledge of the Alter Repository table structure.

The alter repository consists of these tables:

- PS\_PTUALTRECADATA
- PS\_PTUALTRECFLDDAT
- PS\_PTUALTRECFLDDEF

The structure of the tables is described in the following sections.

### PS\_PTUALTRECADATA Table

The following table describes the fields in the PS\_PTUALTRECADATA table.

| <b>Column Name</b> | <b>Description</b>    |
|--------------------|-----------------------|
| PTUPG_SRECNAME     | Source Record Name.   |
| PTUPG_TRECNAME     | Target Record Name.   |
| PTUPG_STABNAME     | Source Table Name.    |
| PTUPG_TTABNAME     | Target Table Name.    |
| PTUPG_SRECTYPE     | Source Record's Type. |

| <b>Column Name</b> | <b>Description</b>  |
|--------------------|---|
| PTUPG_TRECTYPE     | Target Record's Type.   |
| PTUPG_STMPTBLINST  | Temp Table Instances count for Source temp table. (Applies only to temporary tables). Default value is 0.   |
| PTUPG_TTMPTBLINST  | Temp Table Instances count for Target temp table. (Applies only to temporary tables'). Default value is 0.  |
| PTUPG_ALTACTION    | <p>Indicates the Alter action:</p> <p>A: Add Record (New)</p> <p>D: Delete Record</p> <p>RR: Rename Record</p> <p>CR: Record Added.</p> <p>DR: Record Deleted</p> <p>RR: Record Renamed</p> <p>AR: Alter Record with Field changes, Index changes, and Trigger changes.</p> <p>NA: Not applicable, Record with only Trigger, Index, or both changes.</p> <p>TC: Record type changed between source and target. Source table is a non-table (SQL View, Dynamic View, Derived/Work table, and so on) and in the Target the table is an actual SQL table (SQL Table, Temporary Table).</p> <p>TD: Record type changed between source and target.</p> |
| PTUPG_IDXONLY      | <p>Indicates whether changes are only to indexes.</p> <p>0: Default</p> <p>1: Only Index Changes</p>  |
| PTUPG_TRGONLY      | <p>Indicates whether changes are only to triggers.</p> <p>0: Default</p> <p>1: Only Trigger Changes</p>   |

## PS\_PTUALTRECFLDDAT Table

The following tables describes the fields in the PS\_PTUALTRECFLDDAT table.

| <b>Column</b>     | <b>Description</b>  |
|-------------------|---|
| PTUPG_SRECNAME    | Source Record Name.   |
| PTUPG_SRECTYPE    | Source Record Type.   |
| PTUPG_SFLDNAME    | Source Record.Field Name.   |
| PTUPG_SFLDTYPE    | Source Record.Field Name and Type. (Platform independent-PeopleTools field type).                                       |
| PTUPG_SFLDLEN     | Source Record.Field Name, Type, and .Length.  |
| PTUPG_SFLDDECPOS  | Source Record.Field Name, Type, and Decimal Position.   |
| PTUPG_SFLDNOTNULL | Source Record.Field Name, and Null ability.<br>0: Null<br>1: Not Null   |
| PTUPG_SFLDDEFREC  | Default Record Name.  |
| PTUPG_SFLDDEFFLD  | Constant (or) Default Record Name. Field Name.  |
| PTUPG_SENCRYPT    | (Applies only to Oracle databases using TDE.) Source Record.<br>Field, Encryption.<br>0: No Encryption<br>1: Encryption |
| PTUPG_TRECNAME    | Target Record Name.   |
| PTUPG_TRECTYPE    | Target Record, Record Type.   |
| PTUPG_TFLDNAME    | Target Record.Field Name  |
| PTUPG_TFLDTYPE    | Target Record.Field Name, and Type. (Platform independent-PeopleTools field type)                                       |
| PTUPG_TFLDLEN     | Target Record.Field Name, Type, and Length.   |
| PTUPG_TFLDDECPOS  | Source Record.Field Name, Type, and Decimal Position.   |

| <b>Column</b>     | <b>Description</b>   |
|-------------------|--|
| PTUPG_TFLDNOTNULL | Target Record.Field Name, and Null ability.<br><br>0: Null<br>1: Not Null  |
| PTUPG_TFLDDEFREC  | Default Record Name.   |
| PTUPG_TFLDDEFFLD  | Constant (or) Default Record Name. Field Name.   |
| PTUPG_TENCRYPT    | (Applies to Oracle databases using TDE.) Target Record Field .Encryption.<br><br>0: No Encryption<br>1: Encryption                               |
| PTUPG_ALTACT_A    | Indicates whether the field is newly added or not.<br><br>0: Not an Added Field<br>1: Added Field (New)  |
| PTUPG_ALTACT_D    | Indicates whether the field is deleted or not.<br><br>0: Not a Deleted Field<br>1: Deleted Field   |
| PTUPG_ALTACT_CT   | Indicates whether the field type has changed.<br><br>0: No Change in Field Type<br>1: Change in Field Type                                       |
| PTUPG_ALTACT_CL   | Indicates whether the field length has changed.<br><br>0: No Change in Field Length<br>1: Change in Field Length                                 |
| PTUPG_ALTACT_CD   | Indicates whether the field decimal position has changed.<br><br>0: No Change in Field Decimal Position.<br>1: Change in Field Decimal Position. |

| <b>Column</b>    | <b>Description</b>   |
|------------------|--|
| PTUPG_ALTACT_CN  | Indicates whether the field null ability has changed (Null/Not Null).<br><br>0: No Change in Null ability<br>1: Change in Null ability                 |
| PTUPG_ALTACT_CDR | Indicates whether the default record name has changed.<br><br>0: No Change in Default Record Name<br>1: Change in Default Record Name                  |
| PTUPG_ALTACT_CDF | Indicates whether the default field name has changed.<br><br>0: No Change in Default Field Name<br>1: Change in Default Field Name                     |
| PTUPG_ALTACT_CEN | (Applies only to Oracle databases using TDE.) Indicates a change in the field encryption.<br><br>0: No Change in Encryption<br>1: Change in Encryption |
| PTUPG_ALTACT_FR  | Indicates whether a field has been renamed.<br><br>0: No Field Rename<br>1: Field Renamed  |

## PS\_PTUALTRECFLDDEF Table

This table is provided for reference purposes only. It displays the PeopleSoft field types and their default values per database platform. It is a static table, not used or updated by Alter Analyzer.

| <b>Column Name</b> | <b>Description</b>                                |
|--------------------|---|
| PTUPG_FIELDTYPE    | PeopleSoft field type.                            |
| PTUPG_FLDTYPE_NAME | PeopleSoft field type name.                       |
| PTUPG_PLTFRM_ORA   | Default value for Oracle databases.               |
| PTUPG_PLTFRM_MSS   | Default value for Microsoft SQL Server databases. |

| <b>Column Name</b> | <b>Description</b>                       |
|--------------------|--|
| PTUPG_PLTFRM_DB2   | Default value for Db2 for z/OSdatabases. |

## Querying The Alter Repository

This section provides these examples to illustrate the type of information you can gather from the contents of the alter repository.

- Example: Fields Altered For Target Records
- Example: Source Records Deleted From Target
- Example: Source Records Renamed In Target

### Example: Fields Altered For Target Records

This sample query illustrates how to determine which fields on a particular target record will be altered why.

```
SELECT
  PTUPG_TRECNAME,
  PTUPG_TFLDNAME,
  PTUPG_ALTACT_A,
  PTUPG_ALTACT_D,
  PTUPG_ALTACT_CT,
  PTUPG_ALTACT_CL,
  PTUPG_ALTACT_CD,
  PTUPG_ALTACT_CN,
  PTUPG_ALTACT_CDR,
  PTUPG_ALTACT_CDF,
  PTUPG_ALTACT_CEN,
  PTUPG_ALTACT_FR
FROM PS_PTUALTRECFLDDAT
WHERE PTUPG_TRECNAME LIKE 'JOB_CD_TBL'
```

### Example: Source Records Deleted From Target

This sample query illustrates how to determine which records in the source database will be deleted from the target.

```
SELECT
  PTUPG_SRECNAME,
  PTUPG_STABNAME
FROM PS_PTUALTRECDDATA
WHERE PTUPG_ALTACTION = 'DR'
```

### Example: Source Records Renamed In Target

This sample query illustrates how to determine which records in the source database are being renamed in the target.

```
select
  PTUPG_SRECNAME,
  PTUPG_STABNAME,
  PTUPG_TRECNAME,
  PTUPG_TTABNAME
FROM PS_PTUALTRECDDATA
```

```
WHERE PTUPG_ALTACTION = 'RR'
```



## Chapter 7

# Using Command Line Parameters

---

## Understanding PeopleSoft Application Designer Command Line Parameters

PeopleSoft Application Designer offers a variety of command line parameters that you can use to control the database to which it connects. By using these parameters, you can automatically navigate to the part of the system that you need.

Use the values from the following tables to specify certain parameters.

See [Command Line Parameters](#).

### Syntax

The following command line syntax applies to all actions identified in this topic:

```
PSIDE [-parameter value [-parameter value . . .]]
```

You can include as many or as few parameters as you need.

Each parameter starts with a hyphen (-) or a forward slash (/). The value for each parameter follows the hyphen or slash, separated by zero or more spaces. In general, the value does not need to have quotation marks around it, even if it has internal spaces: the system treats all text following the parameter as part of the value, up to the next parameter or the end of the command line.

---

**Note:** You must enclose a value in quotation marks only when it includes a hyphen or forward slash, or to include leading or trailing spaces. If the value itself includes a quotation mark character, precede the double quote with a backslash (\).

---

### Related Links

[Using the PeopleSoft Data Mover Command-Line Interface](#)

## Command Line Option Sequence

Only one command should be included in a single command line. If multiple commands are included in the command line, the only command that will execute is the command that is last in the order of precedence.

The following sequence is used for commands:

1. COPYDB - Copy Database
2. COPYTOFILE - Copy To File
3. COPYFROMFILE - Copy From File

4. COMPAREDB- Compare Database
5. COMPAREFROMFILE - Compare From File
6. BUILDPRJ - Build Project
7. CONVERTPCODE - Convert PeopleCode
8. CONVERTFIELDNAMES - Convert FieldNames
9. CONVERTSEVENWORKFLOW - Convert Workflow
10. CREATEPRJ - Create Project
11. MERGEPRJ - Merge Project
12. BULKEXPORT - Bulk Export
13. SHADOWEXPORT - Shadow Export
14. VALIDATEPROJ - Validate Project Integrity
15. CMPALLPC - Compile All PeopleCode in the Database
16. CMPPRJPC - Compile all PeopleCode in the project
17. CMPDIRPC - Compile Directive PeopleCode in the Database
18. CMPPRJDIRPC - Compile Directive PeopleCode in a project

For example, if the command line included `PSIDE.exe . . . . -CMPDIRPC -CMPPRJDIRPC -VALIDATEPROJ....`, `CMPPRJDIRPC` would process, as it comes last in the sequence order.

---

## Command Line Parameters

This section provides a matrix of required and optional parameters specific for a function and description of the various parameters.

### Required and Optional Parameters Matrix

The following table shows a matrix of required and optional parameters for Copy and Compare functions.

Terms used in the table:

- R — Indicates required parameters for that function.
- O — Indicates optional parameters for that function.

---

**Note:** Empty cells in the table indicate parameters that are not applicable to that function.

---

| <b>Function</b>   | <b>Parameter</b> | <b>Copy</b>      |                |                             | <b>Compare</b>   |                             |
|-------------------|------------------|------------------|----------------|-----------------------------|------------------|-----------------------------|
|                   |                  | <i>From File</i> | <i>To File</i> | <i>Database to Database</i> | <i>From File</i> | <i>Database to Database</i> |
| <i>Project</i>    | -PJFF            | R                |                |                             |                  |                             |
|                   | -PJTF            |                  | R              |                             |                  |                             |
|                   | -PJC             |                  |                | R                           |                  |                             |
|                   | -PJFC            |                  |                |                             | R                |                             |
|                   | -PJM             |                  |                |                             |                  | R                           |
| <i>Connect DB</i> | -CT              | R                | R              | R                           | R                | R                           |
|                   | -CS              | R                | R              | R                           | R                | R                           |
|                   | -CD              | R                | R              | R                           | R                | R                           |
|                   | -CO              | R                | R              | R                           | R                | R                           |
|                   | -CP              | R                | R              | R                           | R                | R                           |
|                   | -CI              | O                | O              | O                           | O                | O                           |
|                   | -CW              | O                | O              | O                           | O                | O                           |
| <i>Target DB</i>  | -TS              |                  |                | R                           |                  | R                           |
|                   | -TD              |                  |                | R                           |                  | R                           |
|                   | -TO              |                  |                | R                           |                  | R                           |
|                   | -TP              |                  |                | R                           |                  | R                           |
|                   | -TI              |                  |                | O                           |                  | O                           |
|                   | -TW              |                  |                | O                           |                  | O                           |
| <i>Log File</i>   | -LF              | O                | O              | O                           | O                | O                           |

| <b>Function</b>          | <b>Parameter</b> | <b>Copy</b> |   |   | <b>Compare</b> |   |
|--------------------------|------------------|-------------|---|---|----------------|---|
| <i>Copy</i>              | -FP              | R           | R |   | R              |   |
|                          | -OVD             | O           | O | O |                |   |
|                          | -EXP             |             |   | O |                |   |
|                          | -RST             | O           | O | O |                |   |
|                          | -OVW             | O           | O |   |                |   |
| <i>Object</i>            | -OBJ             | O           | O | O | O              | O |
| <i>Copy/<br/>Compare</i> | -CL              | O           | O | O | O              | O |
|                          | -AF              | O           | O | O | O              | O |
|                          | -PPL             | O           | O | O | O              | O |
|                          | -DDL             | O           | O | O | O              | O |
|                          | -CFD             | O           | O | O | O              | O |
|                          | -CFF             | O           | O | O | O              | O |
|                          | -LNG             | O           | O | O | O              | O |
| <i>Compare</i>           | -FLTR            |             |   |   | O              | O |
|                          | -CMT             |             |   |   | O              | O |
|                          | -TGT             |             |   |   | O              | O |
|                          | -CBY             |             |   |   | O              | O |
|                          | -ROD             |             |   |   | O              | O |
|                          | -CMTABLE         |             |   |   | O              | O |
|                          | -CMXML           |             |   |   | O              | O |

| <b>Function</b> | <b>Parameter</b> | <b>Copy</b> |   |   | <b>Compare</b> |   |
|-----------------|------------------|-------------|---|---|----------------|---|
|                 | -CMR             |             |   |   |                | O |
|                 | -CROD            |             |   |   |                | O |
|                 | -CRDB            |             |   |   |                | O |
|                 | -NOTKACT         |             |   |   |                | O |
|                 | -CUSTPRJ         |             |   |   |                | O |
| <i>No GUI</i>   | -HIDE            | R           | R | R | R              | R |
|                 | -QUIET           | O           | O | O | O              | O |
|                 | -SS              | O           | O | O | O              | O |
|                 | -SN              | O           | O | O | O              | O |

The following table shows a matrix of required and optional parameters for the Merge, Build, Create, and Start functions.

Terms used in the table:

- R — Indicates required parameters for that function.
- O — Indicates optional parameters for that function.

---

**Note:** Empty cells in the table indicate parameters that are not applicable to that function.

---

| <b>Function</b> | <b>Parameter</b> | <b>Merge</b>               | <b>Build</b>   | <b>Create</b>  | <b>Start</b>              |
|-----------------|------------------|----------------------------|----------------|----------------|---------------------------|
|                 |                  | <i>Project Definitions</i> | <i>Project</i> | <i>Project</i> | <i>Start App Designer</i> |
| <i>Merge</i>    | -PIMG            | R                          |                |                |                           |
| <i>Build</i>    | -PJB             |                            | R              |                |                           |
|                 | -CFG             |                            | R              |                |                           |
| <i>Create</i>   | -PJR             |                            |                | R              |                           |
|                 | -PJRCUST         |                            |                | R              |                           |

| <b>Function</b>   | <b>Parameter</b> | <b>Merge</b> | <b>Build</b> | <b>Create</b> | <b>Start</b> |
|-------------------|------------------|--------------|--------------|---------------|--------------|
| <i>Connect DB</i> | -CT              | R            | R            | R             | R            |
|                   | -CS              | R            | R            | R             | R            |
|                   | -CD              | R            | R            | R             | R            |
|                   | -CO              | R            | R            | R             | R            |
|                   | -CP              | R            | R            | R             | R            |
|                   | -CI              | O            | O            | O             | O            |
|                   | -CW              | O            | O            | O             | O            |
|                   | -LF              | O            | O            | O             | O            |
|                   | -OBJ             |              |              | O             |              |
| <i>No GUI</i>     | -HIDE            | R            | R            | R             | O            |
|                   | -QUIET           | O            | O            | O             | O            |
|                   | -SS              | O            | O            | O             | O            |
|                   | -SN              | O            | O            | O             | O            |

## Available Parameters for the Various Functions

Available parameters for functions

| <b>Parameter</b> | <b>Description</b>  | <b>Error Handling</b>       |
|------------------|---|-----------------------------|
| -AF              | Audit flags on records (0 or 1).<br><br>Enter 1 to keep the target audit flags as is. Enter 0 to take them from the source database. Example: -AF 0 | Optional. The default is 1. |

| <b>Parameter</b> | <b>Description</b>   | <b>Error Handling</b>   |
|------------------|--|---|
| -ADDCLR          | <p>Select a color for changed values, which are both source and target values. Select a color for additional data values on the source database. These are also source-only values.</p> <p>Used while generating Traditional compare reports and PrintProject compare reports. However, this parameter is not applicable while generating Browser compare reports.</p> <p>Example: -CMTRAD 1 -ROD c:\temp\CompareReports -SHPRG 0 -SHLNS 2 -ADDCLR "#86FC83"</p> <hr/> <p><b>Note:</b> If you want to use the customized color defined in the Report Data Color (Upgrade Option&gt; Report Option), then pass the hex color code value (example: #86FC83.)</p> | Optional. The default color is dark green.  |
| -CBY             | <p>Comparison By:</p> <p>To compare by release, enter REL, followed by the release number. To compare by date, enter DAT, followed by a date in the following format: YYYY-MM-DD-HH.MM.SS.sss. Release numbers are included in the Available Release Numbers list. Example: 2002-02-01-12.00.00.000</p>  | Optional. The default is REL.   |
| -CD              | <p>Database name.</p> <p>Enter the name of the database to which you are connecting, as you would enter it into the PeopleSoft Signon dialog box.</p>  | Required. If you omit this parameter, the process stops and error messages are written to the log file. |

| <b>Parameter</b> | <b>Description</b>   | <b>Error Handling</b>   |
|------------------|--|---|
| -CFD             | <p>Keep Target ChartField PageField Display Size.</p> <p>(Number 1 or 0). This parameter indicates whether or not the target ChartField page field display size attributes are to be kept, or whether they should be set from the source. See Upgrade options for more information.</p> <p>Enter 1 to keep the target ChartField page field display size attributes.</p> <p>Enter 0 to set these attributes from the source values.</p> <p>Example, -CFD 0</p> | Optional. Default is 1  |
| -CFF             | <p>Keep Target ChartField Field Format.</p> <p>(Number 1 or 0) This parameter indicates whether or not the target ChartField field format attributes are to be kept, or whether they should be set from the source. See Upgrade options for more information.</p> <p>Enter 1 to keep the target ChartField field format attributes.</p> <p>Enter 0 to set these attributes from the source values.</p> <p>Example, -CFF 0</p>                                  | Optional. Default is 1  |
| -CI              | <p>Connect ID</p> <p>Enter the ID that is used to connect to the database server.</p>  | <p>Optional.</p> <p>If the connect ID is not specified, the value from the registry (psfg) is used.</p>   |
| -CL              | <p>Commit limit.</p> <p>Enter the Commit limit (a number greater than 0) for the number of objects to be copied or compared before a commit is issued. Example: -CL 150</p>  | Optional. The default is 50 if the user does not set this parameter.  |
| -CMPDIRPC        | <p>Compile and save all the directive PeopleCode.</p> <p>Supply the -CMPDIRPC parameter in the command line and there is no need to pass any additional value. This will compile and save all the directive people.</p>  | <p>Required. This is the parameter to compile and save the all directive PeopleCode programs in the database.</p> <p>If you do not supply this parameter then directive PeopleCode programs in the database will not be compiled and saved.</p> |

| <b>Parameter</b> | <b>Description</b>   | <b>Error Handling</b>   |
|------------------|--|---|
| -CMPPRJDIRPC     | Compile and Save the PeopleCode for the project specified.<br><br>Enter the project name. Example: -CMPPRJDIRPC PROJECT1.  | Required. This is the parameter to compile and save the directive PeopleCode programs in a project. If you do not supply this parameter then the directive PeopleCode programs in the project will not be compiled and saved. |
| -CMPRTPRJ        | Enable generation of PrintProject report during compare.<br><br>Enter 1 to enable this option, and enter 0 to disable this option.   | Optional. The default value is 0.<br><br>This is equivalent to setting the Generate PrintProject Reports options on the Report Options tab on the Upgrade Options dialog box.   |
| -CMR [0   1]     | Use 0 to disable, 1 to enable, the generation of the Composite Compare Reports. Parameter is only valid when used in conjunction with the -PJM option. Ignored otherwise.  | Optional. If not used, then composite report disabled. Must also use -CROD and -CRDB options when using -CMR.<br><hr/> <b>Note:</b> Not supported for Compare from file. <hr/>  |
| -CMT             | Compare type: project (1) or database (0). Example: -CMT 0   | Optional. The default is 1.<br><hr/> <b>Note:</b> Value will always be 1 for Compare from file. <hr/>   |
| - CMTRAD         | Enable generation of traditional compare reports during compare.<br><br>Enter 1 to enable this option, and enter 0 to disable this option.   | Optional. The default value is 1.<br><br>This is equivalent to setting the Generate Traditional Reports options on the Report Options tab on the Upgrade Options dialog box.  |
| -CMTABLE [0 1]   | Select this option to write the compare output to database tables. This enables you to keep a historical record of your compares in your database, and it also provides you the flexibility of being able to design custom queries for analyzing specific definitions, attributes, and so on. Enter 1 to enable this option, and enter 0 to disable this option.<br><br><u>See Using the Upgrade Workspace</u> | Optional. The default is 1.   |

| <b>Parameter</b> | <b>Description</b>   | <b>Error Handling</b>  |
|------------------|--|--|
| -CMXML           | <p>Generate browser reports (0 or 1).</p> <p>This command enables you to enable the option of generating browser reports written to your report output directory. This is equivalent to setting the Generate Browser Reports options on the Report Options tab on the Upgrade Options dialog box.</p> <p>Enter 1 to enable this option, and enter 0 to disable this option.</p> <p>Example: -CMXML 1</p> <p>See <a href="#">Working with Browser Reports</a></p> | Optional. The default is 0.  |
| -CMPXMLPASS      | <p>Browser compare report password.</p> <p>This option enables you to secure the browser compare report by setting a password while generating the report. This is equivalent to setting the Password Protected option on the Report Options tab on the Upgrade Options dialog box.</p> <p>Example: -CMPXMLPASS 12345678</p> <p>See <a href="#">Working with Browser Reports</a></p>   | Optional   |
| -CO              | <p>User ID.</p> <p>Enter the PeopleSoft user ID that is needed to sign in to the connect database.</p>   | Required. If you omit this parameter, the last database type is taken from the registry. If it fails, the process stops and error messages are written to the log file.  |
| -CP              | <p>User password.</p> <p>Enter the password for the specified user ID for the connect database.</p> <hr/> <p><b>Note:</b> The password can be entered either as encrypted or clear text.</p> <hr/>   | Required. If you omit this parameter, the PeopleSoft Signon dialog box appears and prompts the user for the password. If the password fails, the process stops and error messages are written to the log file if the log file name parameter is specified. |

| <b>Parameter</b>       | <b>Description</b>  | <b>Error Handling</b>   |
|------------------------|---|---|
| -CRDB [database name]  | Pass the value of the Old Release Source Database name when generating Composite Reports. This value must match the Source Database name value from the Old Release Report for each definition type. This is to ensure the original old release report is valid and contains the expected data. If the old release report source database name for the current definition type does not match the passed value, then an error message is generated to the log file, but process continues for other definition types. | Optional.<br><hr/> <b>Note:</b> Not supported for Compare from file. <hr/>  |
| -CROD [directory path] | Set path for the Old Release Compare reports when generating Composite Reports (-CMR 1). Only valid when used in conjunction with the -PJM and -CMR 1 options, ignored otherwise.   | If not set when generating composite reports (-CMR 1) then its an error condition, and processing should stop, and an error generated to the log file. Directory path can be a local directory, a mapped network directory, or a UNC path specification.<br><hr/> <b>Note:</b> Not supported for Compare from file. <hr/> |
| -CS                    | Server name.<br><br>Enter the name of the database server for the database to which you are connecting.   | Required for some database types. If you omit this parameter, the process stops and error messages are written to the log file.   |
| -CT                    | Database type.<br><br>Enter the type of the database to which you are connecting (ORACLE, DB2, and so on).  | Required. If you omit this parameter, the last database type is taken from the registry. If it fails, the process stops and error messages are written to the log file.   |
| -CW                    | Connect ID password.<br><br>Enter the password for the specified connect ID.  | Optional.<br><br>If the connect ID password is not specified, the value from the registry (psfg) is used.   |

| <b>Parameter</b> | <b>Description</b>  | <b>Error Handling</b>              |
|------------------|---|------------------------------------|
| -DELCLR          | <p>Select a color for data values that are deleted from the source database. These are target-only values.</p> <p>Used while generating Traditional compare reports and PrintProject compare reports. However, this parameter is not applicable while generating Browser compare reports.</p> <p>Example: -CMTRAD 1 -ROD c:\temp\CompareReports -SHPRG 0 -SHLNS 2 -DELCLR "#820041"</p> <hr/> <p><b>Note:</b> If you want to use the customized color defined in the Report Data Color (Upgrade Option&gt; Report Option), then pass the hex color code value (example: #820041.)</p> <hr/> | Optional The default value is red. |
| -DDL             | <p>Data definition language (DDL) on records and indexes (0 or 1).</p> <p>Enter 1 to keep the target database DDL flags as is. Enter 0 to take them from the source database. Example: -DDL 0</p>   | Optional. The default is 1.        |
| -DIFCLR          | <p>Select a color for changed values, which are both source and target values.</p> <p>Used while generating Traditional compare reports and PrintProject compare reports. However, this parameter is not applicable while generating Browser compare reports.</p> <p>Example: -CMTRAD 1 -ROD c:\temp\CompareReports -SHPRG 0 -SHLNS 2 -DIFCLR "Blue"</p> <hr/> <p><b>Note:</b> If you want to use the customized color defined in the Report Data Color (Upgrade Option&gt; Report Option), then pass the hex color code value (example: #820041.)</p> <hr/>                                | Optional. Default is Blue.         |

| <b>Parameter</b> | <b>Description</b>  | <b>Error Handling</b>  |
|------------------|---|--|
| -EXOBJ           | <p>Exclude object from copy.</p> <p>Object types to exclude from copy:<br/>List the object types as numbers with commas as delimiters. For example, if you choose to exclude file references and file type codes for copying, use the appropriate numbers for file references and file type codes from the Definition Type Selection table (PTOBJECTTYPES). For file references, the number is 68, and for the file type codes, the number is 69. Example: -EXOBJ 68,69</p>   | Optional.  |
| -EXP             | <p>Export project definition (0 or 1).</p> <p>Enter 1 to export the project definition to the target database when using the Database Copy process. Not applicable for Copy Project to File process.</p>  | Optional. The default is 1. Any project with the same name is overwritten with the new project definition.   |
| -FLTR            | <p>Report filter.</p> <p>The command line report filter options are equivalent to those displayed on the Report Filter tab on the Upgrade Options dialog box.</p> <p>The syntax is:</p> <pre data-bbox="662 1182 992 1230">-FLTR XXXXX XXXXX XXXXX       XXXXX XXXXX</pre> <p>Where each <i>X</i> corresponds to a specific check box on the Report Filter tab, and each set of <i>X</i>'s corresponds to a row in the matrix on the Report Filter tab, moving left-to-right, top-to-bottom, beginning with the top, left-hand corner (Source, Absent/Target, Absent).</p> <p>The value of <i>X</i> can be either a <i>0</i> (not selected) or <i>1</i> (selected).</p> <p>For example:</p> <pre data-bbox="662 1623 992 1671">-FLTR 00000 00011 00011       01111 01111</pre> <p>Using this example, and comparing this to the GUI on the Report Filter tab, none of the check boxes would be selected in the first row, only the check boxes in the Custom Changed and Custom Unchanged columns would be selected, and so on.</p> | Optional. If report filter options are not submitted on the command line, the system uses the current settings on the Report Filter tab on the Upgrade Options dialog box. |

| <b>Parameter</b> | <b>Description</b>   | <b>Error Handling</b>  |
|------------------|--|--|
| -FP              | Project file path.<br>Enter the project file path.   | Required for a Copy To File or Copy From File process (but not for a Database Copy process). For the Copy From File process, the directory must exist. For the Copy To File process, any project with the same name is overwritten unless you use the -OVW parameter. A directory specification is created if it does not exist. Do not include the name of the project in the file path. Use -PJTF or -PJFF to specify the project name.<br><br>Required for Compare from file. |
| -HIDE            | Use to hide the PeopleSoft Application Designer interface. Always use this parameter when performing a command line Copy process.  | Required for all project command line processes.   |
| -KMVP            | Enter 1 to retain the target properties of materialized view.<br><br>Enter 0 to set the properties from the source. You can copy the materialized view properties like REFRESH_MODE, REFRESH_METHOD and BUILD_MODE from the source to the target database.<br><br>Example: -KMVP 1 | Optional. Default value is 1.  |
| -LF              | Log file name.<br><br>Enter the name of the file in which error messages are logged.   | Optional. If you omit this parameter, a file is created with the specified path and name, and all of the processing and error messages are written to that file.   |

| <b>Parameter</b> | <b>Description</b>  | <b>Error Handling</b>   |
|------------------|---|---|
| -LNG             | <p>List the language codes with commas as delimiters or enter ALL to select all available languages. For new languages that are not listed in the Language Selection table, use the xlat short name from the LANGUAGE_CD field in the translate table. For example, if you choose English and Spanish for copying or comparing, enter the appropriate codes for English and Spanish from the Language Selection table. For English, the code is ENG, and for Spanish, the code is ESP. Example: -LNG ENG,ESP</p> <p>See “Language Selections” (Application Designer Developer’s Guide).</p> | <p>Optional. If you omit this parameter, then the languages that are already set in the project are used as the default. The COMMON language code refers to nonlanguage attributes that are not translated. Translated attributes can be copied or compared separately from nontranslated attributes. If you do not specify the COMMON code when using -LNG, you copy or compare only the translated language attributes.</p> <p>Changing languages on the command line changes the values that are stored with the project definition. Subsequent Copy and Compare processes on the modified project use the new values unless they are explicitly changed again in the upgrade options.</p> |
| -OBJ             | <p>Object types to copy: List the object types as numbers with commas as delimiters. For example, if you choose records and indexes alone for copying, use the appropriate numbers for records and indexes from the Definition Type Selection table. For records, the number is 0, and for the indexes, the number is 1. Example: -OBJ 0,1</p> <p>Definition type to compare: List the definition types to compare as numbers with commas as delimiters, or enter All. Example: -OBJ 0,1</p>  | <p>Optional. If you omit this parameter, then all of the objects or definitions are copied or compared by default.</p> <p>For a project comparison, this refers to all definitions in the project. For a database comparison, this includes all definitions in the database.</p>  |
| -OVD             | <p>Override dependencies (0 or 1).</p> <p>Enter 1 to override the checks for unapplied dependency incidents and to perform the copy even if dependency incidents for the project have not been applied to the source database.</p>  | <p>Optional. The default is 0. When you enter the default and if the project’s dependency incidents have not been applied to the source database, an error message is written to the log file listing which incidents need to be applied. The copy process also stops. When you enter 1, a warning message is written to the log for unapplied incidents and processing continues.</p>  |
| -OVW             | <p>Overwrite existing project (0 or 1). Enter 1 to overwrite any existing projects with the same name in the specified path during the Copy Project To File process, or in the database in the Copy Project From File process. Enter 0 to not overwrite existing projects. This parameter applies to the Copy Project To and From File processes only.</p>  | <p>Optional. The default is 1.</p>  |

| <b>Parameter</b> | <b>Description</b>   | <b>Error Handling</b>  |
|------------------|--|--|
| -PJB             | Project name.<br><br>Enter the name of the project to be built. This project should be available in the database before starting the command line project build.   | Required. This is the main parameter and is used internally to decide whether the user can build a project. If you omit this parameter and if you supply all of the source database login parameters, the program only starts the application.   |
| -CFG             | RDM build setting configuration file.  | Required. This parameter is used with -PJB to set the build settings.<br><br>Sample file is available at <PS_HOME>\setup\ptbld.cfg.  |
| -PJC             | Source project name.<br><br>Enter the name of the project that is to be copied from the source database to the target database. This project should be available in the source database before starting the command line Upgrade Copy process to target database.          | Required for a Database Copy process. This is the main parameter that is used internally by the executable file to identify an Upgrade Copy process. If you omit this parameter and if you supply all of the source database login parameters, the executable file starts the application. |
| -PJFF            | Copy Project From File project name.<br><br>Enter the name of the project to be copied from the file into the source database.   | Required for a Copy From File process. Do not include the file path to the project with this parameter. Use -FP to specify the file path.  |
| -PJFC            | Compare from file.<br><br>Enter the project name for the file.   | Required for Compare from file.  |
| -PJM             | Source project name.<br><br>Enter the name of the project that is to be compared from the source database to the target database. This project should be available in the source database before starting the command line Upgrade Compare process to the target database. | Required. This is the main parameter that is used internally by the executable file to identify an upgrade compare. If you do not supply this parameter and if you supply all of the source database login parameters, this executable file starts the application.                        |
| -PJTF            | Copy Project To File project name.<br><br>Enter the name of the project to be copied from the source database to the file.   | Required for a Copy To File process. Do not include the file path to the project with this parameter. Use -FP to specify the file path.  |
| -PJV             | Validate Project   | Required for Validate Project.   |

| <b>Parameter</b> | <b>Description</b>  | <b>Error Handling</b>   |
|------------------|---|---|
| -PLRM            | <p>Permission List, Role, Menu (0 OR 1).</p> <p>Enter 1 to keep the target database tracking data for permissions lists, roles and menus. Enter 0 to take the tracking data from the source database.</p> <p>Example: -PLRM 0</p> <hr/> <p><b>Note:</b> This option applies to Upgrade Copy operation and is ignored for Upgrade Compare operation.</p> | Optional. The default is 0.   |
| -PPL             | <p>Portal registry structures permission list references.</p> <p>Enter 1 to keep the target portal registry permission list references as is. Enter 0 to take them from the source database.</p>  | Optional. The default is 1.   |
| -QUIET           | <p>Use to run in quiet mode so that no message boxes appear. The system writes messages to the log file or trace file, depending on whether you also use the -LF parameter. Quiet mode is recommended for use with processes that require no human interaction.</p>   |   |
| -ROD             | <p>Report Output Directory.</p> <p>Enter the report output directory location. Example-ROD c:\temp\upgreports</p>   | Optional. If you do not supply this parameter, the system uses the <b>Report Output Directory</b> value from the <b>Tools &gt; Options</b> General tab. |
| -RST             | <p>Reset done flags (0 or 1).</p> <p>Enter 1 to reset the done flags before initiating the Copy process. Enter 0 to not reset them. Example: -RST 0</p>   | Optional. The default is 1.   |
| -SHLNS           | <p>Displays the number of lines above and below the difference line in PeopleCode Report Options.</p> <p>Used while generating Traditional Compare Reports and Browser Compare reports. However, this parameter is not applicable while generating PrintProject compare reports. Example: -CMTRAD 1 -ROD c:\temp\CompareReports -SHPRG 0 -SHLNS 2</p>   | <p>Optional. Default is 0.</p> <p>This parameter works only if -SHPRG value is 0.</p>   |

| <b>Parameter</b> | <b>Description</b>  | <b>Error Handling</b>   |
|------------------|---|---|
| -SHPRG           | <p>Based on the value selected, displays the entire program or displays the differences in program.</p> <p>Used while generating Traditional Compare Reports and Browser Compare reports. However, However, this parameter is not applicable while generating PrintProject compare reports.<br/>Example: -CMTRAD 1 -ROD c:\temp\CompareReports -SHPRG 1</p> | Optional. Default is 1 and it displays the entire program.  |
| -SN              | Use to suppress the sound that plays when you sign in to the PeopleSoft system. Any other value causes the sound to play.   | Optional  |
| -SS              | Use to suppress the display of the PeopleSoft splash screen. Any other value causes the splash screen to appear.  | Optional  |
| -TD              | <p>Target database name.</p> <p>Enter the name of the target database to which you are connecting as you would enter it into the PeopleSoft Signon dialog box.</p>  | <p>Required for Compare (Database to Database).</p> <p>Required for a database Copy process (but not used for a Copy To File or Copy From File process).</p> <p>If you omit this parameter, the process stops and error messages are written to the log file if the log file name parameter is specified.</p> |
| -TGT             | Target Orientation: PeopleSoft vanilla (0) or keep personalization (1).   | Optional. The default is 0.   |
| -TI              | <p>Target connect ID.</p> <p>Enter the ID that is used to connect to the target database server. If the connect ID for the target database is the same as the connect ID for the connect database, this parameter is not necessary.</p>   | <p>Optional. If no value is specified, CA determines the value in this order:</p> <ol style="list-style-type: none"> <li>1. Uses the -CI value (Connect ID.)</li> <li>2. Reads the value from the registry. This value is populated by pscfg.</li> </ol>  |

| <b>Parameter</b> | <b>Description</b>  | <b>Error Handling</b>  |
|------------------|---|--|
| -TO              | <p>Target user ID.</p> <p>Enter the PeopleSoft user ID to use to sign in to the target database.</p>  | <p>Required for Compare (Database to Database).</p> <p>Required for a Database Copy process (but not used for a Copy To File or Copy From File process).</p> <p>If you omit this parameter, the process stops and error messages are written to the log file if the log file name parameter is specified.</p>                      |
| -TP              | <p>Target user password.</p> <p>Enter the password for the specified user ID for the target database.</p> <hr/> <p><b>Note:</b> The password can be entered either as encrypted or clear text.</p> <hr/>                  | <p>Required for Compare (Database to Database).</p> <p>Required for a Database Copy process (but not used for a Copy To File or Copy From File process).</p> <p>If you omit this parameter, the process stops and error messages are written to the log file if the log file name parameter is specified.</p>                      |
| -TS              | <p>Target server name.</p> <p>Enter the name of the target database server for the database to which you are connecting.</p>  | <p>Required for Compare (Database to Database).</p> <p>Required for some database types and for a Database Copy process (but not used for a Copy To File or Copy From File process). If you omit this parameter, the process stops and error messages are written to the log file if the log file name parameter is specified.</p> |
| -TW              | <p>Target connect ID password.</p> <p>Enter the connect ID password for the target database. If the connect ID password for the target database is the same as the connect database, this parameter is not necessary.</p> | <p>Optional. If no value is specified, CA determines the value in this order:</p> <ol style="list-style-type: none"> <li>1. Uses the -CW value (Connect ID.)</li> <li>2. Reads the value from the registry. This value is populated by pscfg.</li> </ol>   |

---

## Starting the PeopleSoft Application Designer Command Line Interface

Use the command line syntax and available parameters to start PeopleSoft Application Designer.

### Command Line Syntax

Use the command line syntax described previously to start PeopleSoft Application Designer.

See [Understanding PeopleSoft Application Designer Command Line Parameters](#).

### Example

For this example, assume that the:

- Database type is Oracle.
- Server name is SEPNTDB05.
- Database name is EP7TST.
- User ID is PTDMO.
- Password is encrypted.

This command line statement starts PeopleSoft Application Designer and signs in to the DEP7TST database:

```
PSIDE -CT ORACLE -CS SEPNTDB05 -CD EP7TST -CO PTDMO -CP ***Encrypted Password***
```

See [Command Line Parameters](#).

---

## Building Projects Using the Command Line

Use the same command line syntax as identified previously to build a project.

See [Understanding PeopleSoft Application Designer Command Line Parameters](#).

Use the command line statement for the project build to:

- Connect the project to the source database.
- Use the build settings from the Windows registry to generate the SQL script for the create or alter processes.

Before running the build command line, verify that:

- The project's system components are created and loaded.
- The build options are set in the Windows registry.

### Example

For this example, assume that the:

- Project name is PROJECT1.
- Database type is Oracle.
- Database name is T1B85401.
- User ID is PTDMO.
- Password is encrypted.

- Path name of the log file is c:\temp\psbuild.log in the Windows registry.

For this example, you would enter the following at the command line:

```
pside.exe -CT ORACLE -CS -CD T1B85401 -CO PTDMO -CP ***Encrypted password*** -CI people -
CW password -PJB PROJECT1 -LF C:\temp\out\BuildCreateTest.log -HIDE -QUIET -SS -SN
```

See [Command Line Parameters](#).

## Creating Projects Using the Command Line

Use the same command line syntax as identified previously to build a project.

See [Understanding PeopleSoft Application Designer Command Line Parameters](#).

Use the command line statement for the project create to:

- Connect the project to the source database.
- Indicate the object types to include in the project.

---

**Note:** Projects created using -PJR are limited to object types and will include all instances of the object type specified. You can include multiple object types separated by comma. To create a project that includes all object types use ALL.

---

### Example

For this example, assume that the:

- Project name is CREATETEST.
- Database type is Oracle.
- Database name is T1B85401.
- User ID is PTTRN.
- The object types are 79,80,81,82.
- If there is an existing project with the same name it will be overwritten.
- Path name of the log file is c:\temp\out\CreateTest.log.

For this example, you would enter the following at the command line:

```
pside.exe -CT ORACLE -CS -CD T1B85401 -CO PTTRN -CP password -CI people -CW password -PJR
CREATETEST -OBJ 79,80,81,82 -OVW 1 -LF c:\temp\out\CreateTest.log -HIDE -QUIET -SS NO -SN
NO
```

This is an example of the log file created for this command line.

This example illustrates the fields and controls on the Example of log for creating a project.

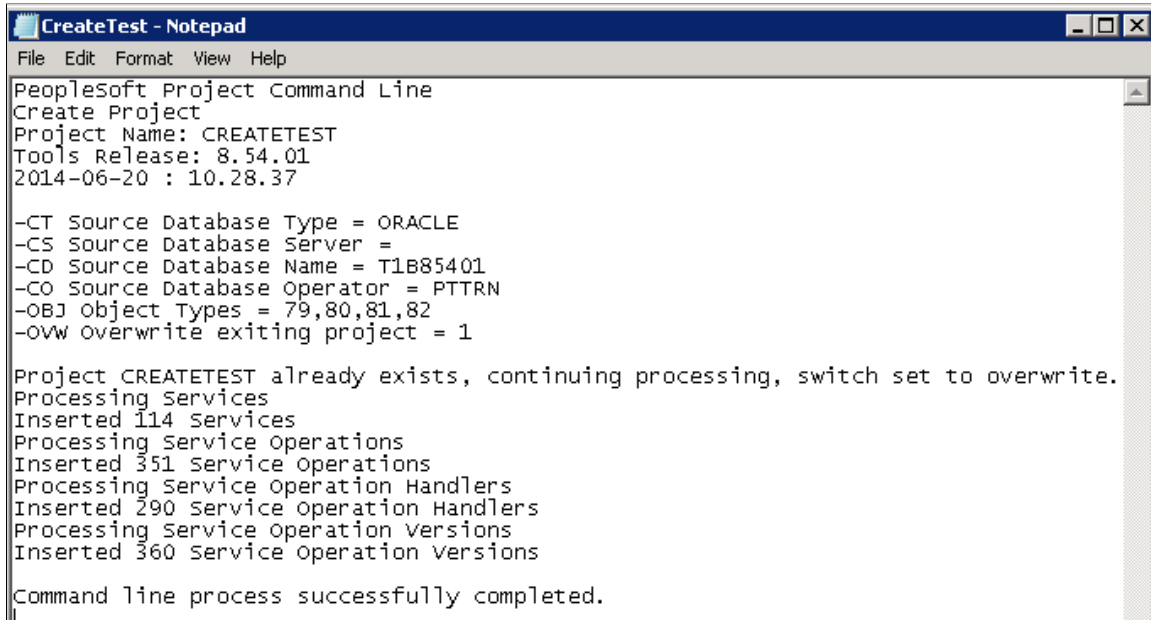

```

CreateTest - Notepad
File Edit Format View Help
PeopleSoft Project Command Line
Create Project
Project Name: CREATETEST
Tools Release: 8.54.01
2014-06-20 : 10.28.37

-CT Source Database Type = ORACLE
-CS Source Database Server =
-CD Source Database Name = T1B85401
-CO Source Database Operator = PTTRN
-OBJ object Types = 79,80,81,82
-OVW overwrite exiting project = 1

Project CREATETEST already exists, continuing processing, switch set to overwrite.
Processing Services
Inserted 114 Services
Processing Service Operations
Inserted 351 Service Operations
Processing Service Operation Handlers
Inserted 290 Service Operation Handlers
Processing Service Operation Versions
Inserted 360 Service Operation Versions

Command line process successfully completed.

```

---

## Creating Customization Project Using the Command Line

Customization projects are used to identify any customizations made to managed objects. This feature is only available using the command line or as a step in Change Assistant. This feature will go through the specified objects in a database and check the user ID:

- If the user ID is not specified in the command line, PSIDE will compare the object user id with 'PPLSOFT' and insert the object into the customization project if the user ID is not 'PPLSOFT'.
- If user ID is specified in the command line, PSIDE will compare the object user ID with the user IDs specified in the command line and insert the object into the project if the user ID is one of the user IDs specified in the command line.

---

**Important!** This feature compares the user ID of the managed object, it does not compare LASTUPDDTTM and detail the property of the managed object.

---

Use the same command line syntax as identified previously to create a customization project.

See [Understanding PeopleSoft Application Designer Command Line Parameters](#).

Use the command line statement for the create customization project to:

- Connect the project to the source database.
- Indicate the user IDs.

---

**Note:** To enter multiple user ID, separate the user IDs with commas.

---

- Indicate the object types to include in the project.

---

**Note:** Projects created using -PJRCUST are limited to object types and will include all instances of the object type specified. You can include multiple object types separated by comma. To create a project that includes all object types use ALL.

---

## Example

For this example, assume that the:

- Project name is PROJECT1.
- Database type is Oracle.
- Database name is T855805B.
- User IDs for the LASTOPRID are PTTRN and PTINT.
- User ID to signon is PTTRN.
- The object types are 0,2 (record and field).
- If there is an existing project with the same name it will be overwritten.
- Path name of the log file is C:\temp\createcust.log .

For this example, you would enter the following at the command line:

```
pside.exe -PJRCUST PROJECT1 -OBJ 0,2 -LASTOPRID PTTRN,PTINT -CT ORACLE -CS -CD
T855805B -CO PTTRN -CP password -CI people -CW password -LF C:\temp\createcust.log -HIDE -
QUIET -SS -SN
```

This is an example of the log file created for this command line.

This is an example of the log file for creating a customization project.

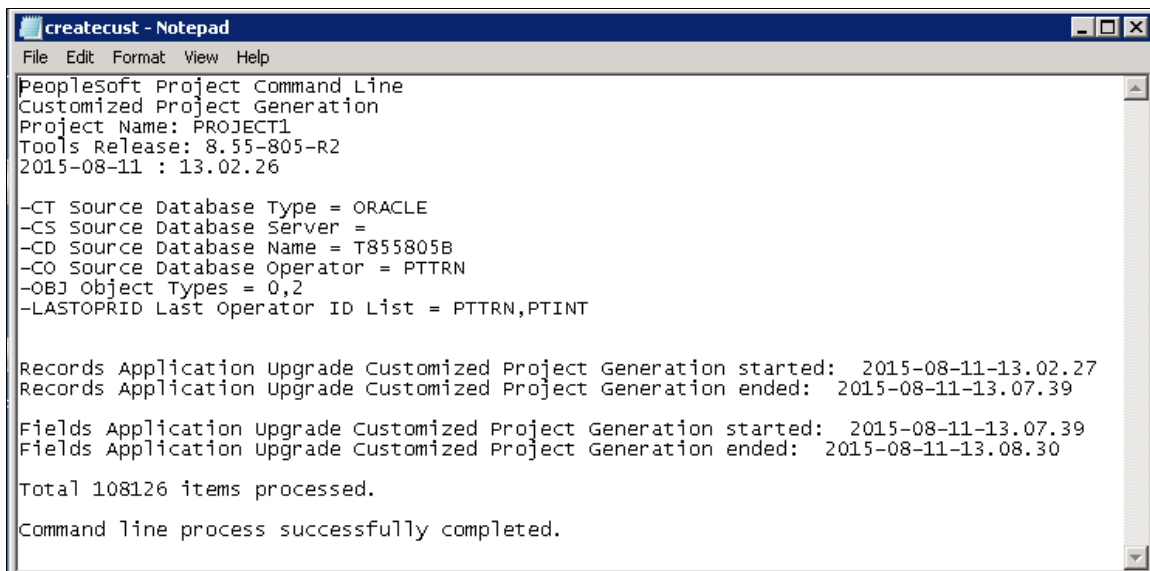

```
createcust - Notepad
File Edit Format View Help
PeopleSoft Project Command Line
Customized Project Generation
Project Name: PROJECT1
Tools Release: 8.55-805-R2
2015-08-11 : 13.02.26

-CT Source Database Type = ORACLE
-CS Source Database Server =
-CD Source Database Name = T855805B
-CO Source Database Operator = PTTRN
-OBJ Object Types = 0,2
-LASTOPRID Last Operator ID List = PTTRN,PTINT

Records Application Upgrade Customized Project Generation started: 2015-08-11-13.02.27
Records Application Upgrade Customized Project Generation ended: 2015-08-11-13.07.39

Fields Application Upgrade Customized Project Generation started: 2015-08-11-13.07.39
Fields Application Upgrade Customized Project Generation ended: 2015-08-11-13.08.30

Total 108126 items processed.
Command line process successfully completed.
```

## Copying Definitions Using the Command Line

Use the same command line syntax as identified previously to copy definitions.

See [Understanding PeopleSoft Application Designer Command Line Parameters](#).

Use the command line statement for Upgrade Copy processes to:

- Connect to the source database.
- Connect to the target database.
- Copy the project and its objects from the source database to the target database.

If the same project already exists in the target database, you can set the option to overwrite the older project with the new project.

- Identify the definition type to copy. By default all definition types in the project are copied unless you set the `-OBJ` parameter to include only specific definition types or you use the `-EXOBJ` parameter to specify specific definition types to exclude.

This table lists how these parameters work together in the command line.

| <b><i>-OBJ</i></b> | <b><i>-EXOBJ</i></b> | <b><i>Object List</i></b>   | <b><i>Example</i></b>   |
|--------------------|----------------------|---|---|
| No                 | No                   | All Objects   | Command line does not have either of these parameters<br><br>Object list contains all definition types.     |
| Yes                | No                   | All objects listed in <code>-OBJ</code> parameter                     | <code>-OBJ 1,2,3</code><br><br>Object list contains definition types 1, 2, and 3.                           |
| No                 | Yes                  | All objects except objects listed in <code>-EXOBJ</code> parameter    | <code>-EXOBJ 1,2,3</code><br><br>Object list contains all definition types except types 1, 2, and 3.        |
| Yes                | Yes                  | Objects of <code>-OBJ</code> excluding objects of <code>-EXOBJ</code> | <code>-OBJ 0,1,2,3,4,5 -EXOBJ 3,4,5,6,7</code><br><br>Object list will contains definition types 0,1 and 2. |

### Example: Database Copy Process

These are some command line statements for the Database Copy process:

- Copy the project PPLTOOLS from the source Oracle database, PTDMO, to the target database, PTTST.

- Log process and error messages to `c:\temp\copy.log`.
- Set the commit limit to 150.  
Copy the audit flags and record and index DDLs from the source database.
- Copy only records, indexes, pages, queries, and process definitions from the project.
- Do not reset the done flags before initiating the Copy process.
- Copy only English and Spanish translations.
- Keep the target origin for permission list, roles and menus.

This is a command line statement that performs the preceding list of tasks.

```
PSIDE.EXE -HIDE -PJC PPLTOOLS -CT ORACLE -CD PTDMO -CO PTDMO -CP password -TD
PTTST -TO PTDMO -TP password -QUIET -LF C:\TEMP\COPY.LOG -CL 150 -AF 0 -DDL 0 -OBJ
0,1,5,10,20 -RST 0 -LNG ENG, ESP -PLRM 1
```

See [Command Line Parameters](#).

### Example: Copy To File Process

These are some command line statements for the Copy to File process:

- Copy the PPLTOOLS project from the Oracle database, PTDMO, by using the PTDMO user ID, to the local directory `c:\temp\export`.  
A directory named PPLTOOLS is created in `c:\temp\export`.
- Log progress and error messages to `c:\temp\copy.log`.

This is a command line statement that performs the preceding list of tasks.

```
PSIDE.EXE -HIDE -PJTF PPLTOOLS -FP c:\temp\export -CT ORACLE -CD PTDMO -CO PTDMO -
CP password -QUIET -LF c:\temp\copy.log
```

See [Command Line Parameters](#).

### Example: Copy From File Process

These are some command line statements for the Copy From File process.

- Copy the PPLTOOLS project to the DB2 UDB for Linux, Unix, and Windows database, PTDMO, by using the user ID PTDMO, from the local directory `c:\temp\export`.  
A directory named PPLTOOLS must exist under `c:\temp\export`.
- Log progress and error messages to `c:\temp\copy.log`.

This is a command line statement that performs the preceding list of tasks.

```
PSIDE.EXE -HIDE -PJFF PPLTOOLS -FP c:\temp\export -CT DB2UNIX -CD PTDMO -CO PTDMO -
CP password -QUIET LF c:\temp\copy.log
```

See [Command Line Parameters](#).

---

## Merging Projects Using the Command Line

Use the same command line syntax as identified previously to build a project.

See [Understanding PeopleSoft Application Designer Command Line Parameters](#).

Use the command line statement for the merge projects to:

- Connect the database.
  - Merge 2 projects in that database.
- Projects are merged into the first project listed.

### Example

For this example, assume that the:

- Projects to merge are: PROJECT1 and PROJECT2  
Projects will be merged into PROJECT1.
- Database type is Oracle.
- Database name is T1C85401.
- User ID is PTTRN.
- Password is *password*.
- Path name of the log file is C:\temp\Output\mergetest.log in the Windows registry.

For this example, you would enter the following at the command line:

```
pside.exe -CT ORACLE -CS -CD T1C85401 -CO PTTRN -CP password -CI people -CW password -PJMGM PROJECT1,PROJECT2 -LF C:\temp\Output\mergetest.log -HIDE -QUIET -SS NO -SN NO
```

See [Command Line Parameters](#).

---

## Comparing Definitions for Upgrade Using the Command Line

Use the same command line syntax as identified previously to compare definitions.

See [Understanding PeopleSoft Application Designer Command Line Parameters](#).

Use the command line statement for an Upgrade Compare process to:

- Connect to the source database.
- Connect to the target database.
- Perform a project or database compare (based on parameters).

- Create compare reports in the specified output directory.

### Example: Comparing to Database

Use this example as a guide for running an Upgrade Compare process:

- Run a database Compare process against the source Microsoft SQL Server database, FSDMO, and the target database, PTTST.
- Source database uses connect ID and password as defined in pscfg.
- Log process and error messages to c:\temp\compare.log.
- Set the commit limit to 150.
- Show the audit flag and DDL differences between databases.
- Compare records, indexes, pages, queries, and process definitions.
- Compare only English and Spanish translations.
- Set the database compare type.
- Set the target orientation to keep the customizations.
- Compare by release 8.52.00.000.
- Generate compare reports to the c:\temp\upgreports directory.
- Set target database server connect id to people.
- Set target database server connect password to 123456.

```
PSIDE.EXE -HIDE -CT MICROSOFT -CD FSDMO -CO PTDMO -CP password -PJM PPLTOOLS -
TD PTTST -TO PTDMO -TP password -QUIET -LF C:\TEMP\COMPARE.LOG -CL 150 -AF 0 -DDL
0 -OBJ 0,1,5,10,20 -LNG ENG, ESP -CMT 0 -TGT 1 -CBY REL Core 8.52.00.000 -ROD C:\TEMP
\UPGREPORTS -TI people -TW 123456
```

See [Command Line Parameters](#).

### Example: Comparing from File

Use this example as a guide for running an Upgrade Compare From File process:

- Run a Compare From File process on the T855805B database (target) against the file C:\PROJECTS\CUSTPRJ (source).
- Project name is CUSTPRJ.
- Log process and error messages to C:\TEMP\COMPARE.log.
- Set the commit limit to 100.
- Compare all definitions.
- Compare all languages.

- Set the database compare type.
- Set the report filter.
- Set the target orientation to PeopleSoft Vanilla.
- Compare by release PeopleTools 8.54.00.000.
- Generate PrintProject report.
- Generate compare reports to the D:\Reports directory.

```
PSIDE.EXE -CT ORACLE -CS -CD T855805B -CO PTTRN -CP password -PJFC CUSTPRJ -FP C:\PROJECTS\ -LF C:\TEMP\COMPARE.log -CL 100 -AF 1 -OBJ All -LNG All -PPL 1 -CFD 1 -CFF 1 -FLTR 00000 00011 00011 01111 01111 -TGT 0 -CBY REL PeopleTools 8.54.00.000 -CMPRTPRJ 1 -ROD C:\Reports\ -HIDE -QUIET
```

See [Command Line Parameters](#).

## Compiling and Saving Directive PeopleCode

Directive PeopleCode is identified using the PTOOLSREL column on the PSPCMPROG table. As a part of the PeopleTools Only upgrade, it may be necessary to compile the directive PeopleCode. The parameter -CMPDIRPC is used to compile directive PeopleCode.

### Example: Compiling and Saving Directive PeopleCode

For this example, assume that the:

- Database type is Oracle.
- Database server name is SERVER1.
- Database name is QEDMO854.
- Database user ID is QEDMO.
- PeopleSoft splash screen is suppressed.
- Run in QUIET mode.
- PeopleSoft Application Designer interface is hidden.
- Compile and Save Directive PeopleCode
- Path name of the log file is c:\temp\test2.log in the Windows registry

```
pside.exe -CT ORACLE -CS SERVER1 -CD QEDMO854 -CO QEDMO -CP password -SS NO -QUIET -HIDE -CMPDIRPC -LF c:\temp\test2.log
```

See [Understanding PeopleSoft Application Designer Command Line Parameters](#) for details on the parameters.

# Getting Started with Application Data Sets

---

## Application Data Set Overview

Application Data Sets referred to as ADS is the name given to a collection of technology used to migrate application/configuration data between PeopleSoft environments. Application Data Sets is used as part of the Selective Adoption maintenance process and can also be used between two different PeopleSoft applications that have similar data structures.

The three main parts of ADS are:

1. Application Data Set Definitions

Application Data Set definitions define classes of Application Data Sets. Application Data Set definitions are created and maintained in the Data Set Designer. Data sets is the technology used to relate data into logical objects to help simplify and improve the process of understanding and migrating changes to the data.

2. ADS projects

ADS projects convey the data described by Application Data Set definitions.

3. Data Migration Workbench

Data Migration Workbench or DMW provides the interactive user interface to run ADS operations such as compare and copy, review the compare reports, override merge or copy actions, provide approvals when necessary, as well as create new ADS projects.

## Application Data Sets (ADS)

Application Data Sets (ADS) provide the underlying transport technology to move, compare, validate, and merge configuration data. Configuration data includes:

- setup data
- application data
- tools configuration
- managed objects

Application Data Sets are designed to manage the complexity of migrating configuration data across multiple PeopleSoft systems. It is very common to have four or more databases in a PeopleSoft environment, including one or more for development, another for quality assurance, as well as the primary production system. PeopleTools migrates managed objects between environments in PeopleSoft projects that are extracted from one database and imported into another, which works well for PeopleTools metadata however it does not handle application configuration data.

ADS provides the ability for any authorized developer to easily define application data sets, create and modify projects and to compare and copy the objects in the projects similar to the way managed objects have been copied and compared for many years.

#### Application Data Sets:

- Enable developers to use PeopleSoft Pure Internet Architecture (PIA) to create data set definitions as a hierarchy of records with some collective properties. A data set definition defines the *shape* of data set instances. It consists of the following elements:
  - A root record. The primary keys of the root record are then keys of the data set instance
  - An optional hierarchy of related child records, where each child record includes the keys of its parent record.
  - An optional set of properties.
  - An optional set of relationships to other data sets, and their properties.
  - An optional set of attribute groups and their properties.
  - An optional application class having PeopleCode that transform and/or validates the data set instances at copy, compare and validate time.

Data set definitions are like record definitions: record definitions define a group of fields that constitute a record; data set definitions define a group of records that constitute a data set. Both record definitions and data set definitions are metadata that define the *shape* of data.

- Data sets support relations and groups. Relations make it possible to associate two or more data sets based on keys, criteria and properties. Data Sets that include relationships with the family property make it possible to merge the attributes when the data set is copied to the target database. Groups can be used to define records and fields that can be safely merged or that should be hidden from compare.
- Enable developers or administrators using PIA to insert data set instances (data content) into projects to represent a unit of work as an ADS project. ADS projects are like managed object projects: a collection of data set instances having various data set definitions.
- Enable developers or administrators using PIA or Change Assistant to copy, compare, validate, and merge data sets that get included in an ADS project.
- Enable PIA-based copy and compare to use powerful servers rather than the Windows workstations required for PeopleSoft Integrated Development Environment (PSIDE)-based copy and compare.
- Integrate with the Enterprise Components Approval Framework to provide administrative control of the project copy from file process.
- In some cases, provide enhanced security to assure that the data set definitions are suitable for copying data, that the user has access to the PIA data set pages, and that user has the right to copy and compare the data.
- Provide an alternative to Data Mover that offers greater visibility and control for managed changes of a customer's environment.

- Allow pre-defined target configuration fields values to be preserved within each instance. The object owner defines what fields can be preserved using groups. The customer can review and choose to override default behavior with interactive PIA-based compare.

## Data Migration Workbench

Data Migration Workbench is the interactive user interface used to:

- Define ADS project content.
- Launch copy, compare and validation operations for projects.
- View compare and validation results, and modify the copy options of data sets that will be copied.

Data Migration Workbench shows the current status of a project and prevents inconsistent actions. Once you have defined the ADS project, you can copy the data to a file that can later be compared or copied from file on another PeopleSoft database.

The Data Migration Workbench uses a Project Repository as a place in the file system where project files can be copied to and from. The Project Repository is defined in the data base as a repository name, an associated file path, and one or more *areas* (sub folders) that can contain project files. The purpose of Project Repository is to avoid manually copying project files from one system to another by promoting common definition of shared file locations and providing better security for administrative control of the places that project files can be copied to.

## Main Components

This diagram illustrates the main components for Application Data Sets: Data Set Definition and Data Migration Workbench

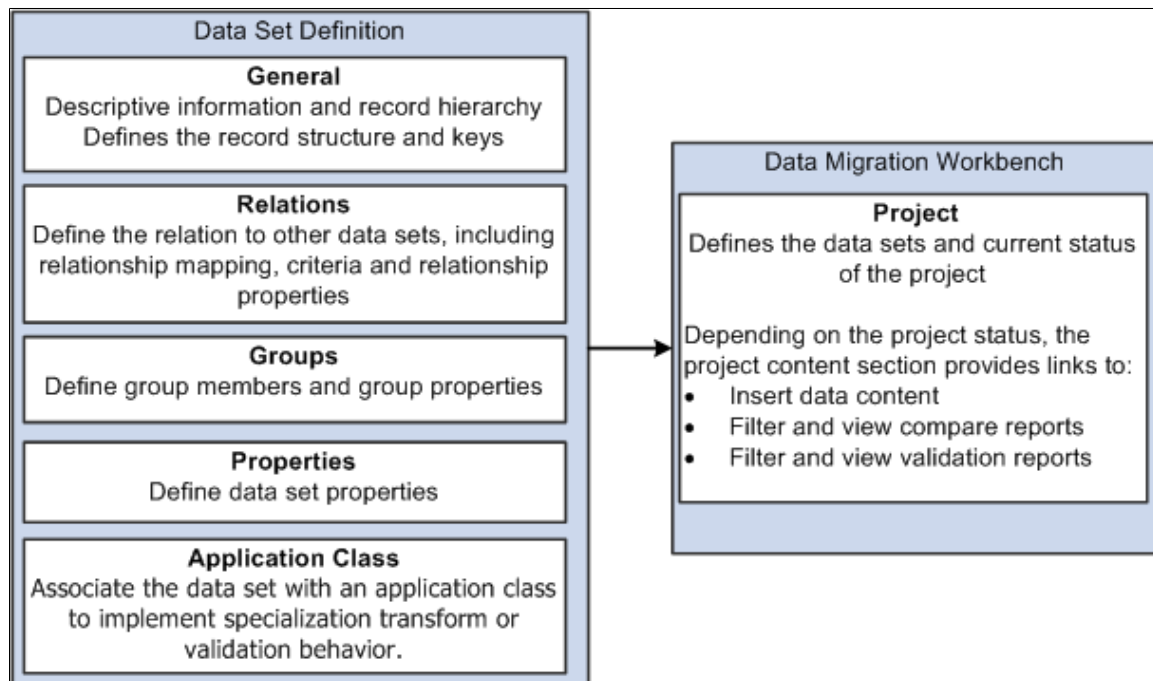

## Application Data Set Integration with PeopleSoft Update Manager

PeopleSoft Update Manager (PUM) is used by PeopleSoft to deliver maintenance to customers. PUM uses ADS projects to migrate both PeopleTools-owned objects like Pivot Grids and Activity Guides, and application-owned objects like Global Payroll. The principle change in 8.54 integration with PUM was to create a composite project of customer-selected units of work containing ADS projects and their dependents for ADS in a manner similar to what has been done for IDE objects in 8.53. Thus when a customer selects units of work to apply in PUM, and the dependency calculation adds dependent units of work, a single composite ADS project is generated. This simplifies downstream processing.

---

## Deployment of Application Data Using Application Data Sets

In previous releases, Data Mover scripts were the only option available to load application data. There was no way to compare the data that is copied by Data Mover. Application Data Sets provide the ability to compare and copy the content data.

---

**Note:** Data Mover scripts are still being used to load application data, however ADS provides another alternative for migrating data.

---

This diagram shows the overall flow for creating and copying ADS projects.

This diagram shows the flow for creating and copying data sets. On the source database, you create a data set definition in PIA just once. The data set definition is a traditional managed object, so it can be copied and compared using the IDE (Integrated Development Environment). You can then include data defined by the data set definition into data migration projects. Each project can contain data from multiple data set definitions. Once the ADS project contains data content it can be copied to a file. The file will be located in one of the Project Repositories defined for your environment. Before you can copy the ADS project to a PeopleSoft target database, the data set definition must exist on the target database. To copy the data set definition, you will need to create an IDE project in Application Designer that contains the data set definition. You can then copy the IDE project to a file and copy it from the file to the target database. On the target database, you will load the data migration project from the Project File repository location, this step copies the project definition from the file to the target, but none of the project content is copied. You can then compare the project and update the copy options, or, if approvals are not enabled on the target or the approval rules do not require a compare, you may copy the project without doing a compare. When you are ready to copy the project, you will submit for copy. If approvals are enabled on the target

database, it will enter the approval process; otherwise the copy will be initiated. If the approval process is enabled, then only approved projects are scheduled for copy, if the project is rejected there is no copy.

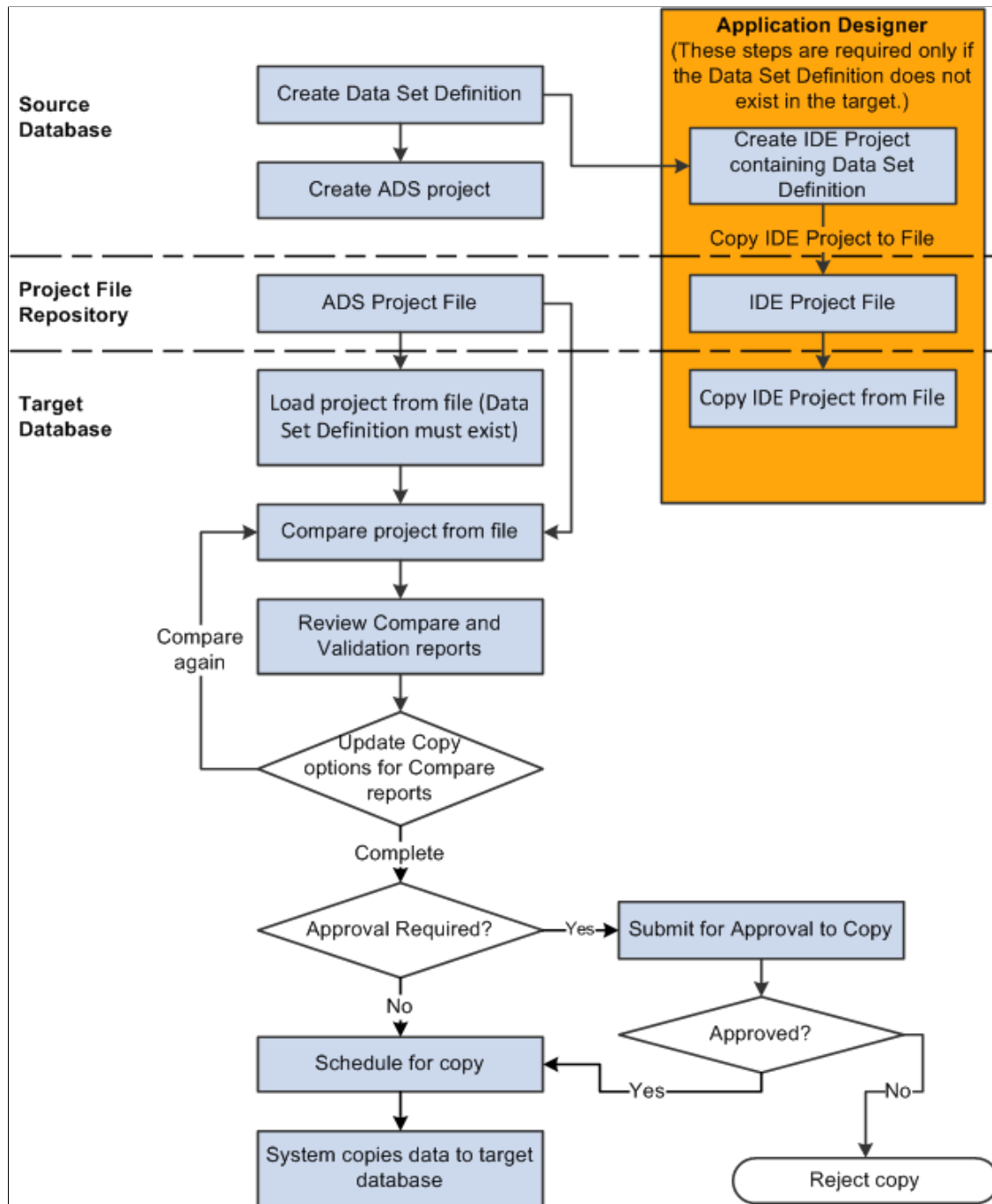

## Application Data Set Implementation

This section discusses the steps used to implement and migrate data using data sets:

| <b>Steps</b>                                   | <b>Reference</b>   |
|--|--|
| 1. Create Data Set Definition.                 | See <a href="#">Creating and Editing Data Set Definition</a> . |
| 2. Create or select then populate ADS Project. | See <a href="#">Defining ADS Project</a> .                     |
| 3. Copy to file.                               | See <a href="#">Copying Project to File</a>                    |
| 4. Compare ADS Project from file.              | See <a href="#">Comparing ADS Projects</a> .                   |
| 5. Review compare and validation reports.      | See <a href="#">Viewing Compare Reports</a> .                  |
| 6. Copy ADS Project from file.                 | See <a href="#">Submitting for Copy</a> .                      |

---

## Application Data Set Limitations and Recommendations

This section lists some limitations and recommendations for Application Data Sets.

### Limitations

Keep in mind the following limitations for Application Data Sets:

- The Application Server and Process Scheduler used must both be able to access the project files using the same path. This will require that both are running on Operating Systems that use compatible file access conventions. For example, Microsoft Windows and UNIX-derived operating systems do not have compatible native file access conventions.
- Although data set security has been improved in PeopleTools 8.54, and is more secure than some other migration technologies, data migration via ADS is intended to be used for data that does not contain sensitive data.
- The data set definition must exist on the target database before you load a data set project to the target database.
- The *shape* of a data set is defined by the records and fields included in the data set. The allowed shape changes include adding records or fields to a data set definition. Allowed shape changes do not require PeopleCode.

Additional shape changes, such as supplying data values for a newly added field or moving data from one record to another may require a custom transform program. The application classes associated with data sets can support various data transformations expressed using the rowset PeopleCode API. In 8.53 transforms are possible at copy from file time, and in 8.54 and beyond transforms can be implemented at both copy to and from file times.

- Data set records must be physical records that have at least one primary key. All child records must include the primary keys of the parent record, but may also have additional primary keys.

## Recommendations

The following practices are strongly recommended:

- ADS projects are meant for relatively small data sets of relatively static data.

---

**Note:** ADS projects are not recommended for large data sets.

---

- Do not change the source ADS Project file after the compare has been performed. If the source data file is changed, any compares must be re-run.

---

**Note:** The decision of which objects to copy is based on the compare report, which is stored in the database. If the ADS project is changed after the compare, you may not get the desired results. Changing the target database may be necessary to fix validation errors, but caution is required to avoid changes to the target database that might create validation errors during copy that were not seen in compare.

---

- Setting up the Project Repositories and areas is a one time activity. The directories should first be created by a system administrator with read/write access permissions for the users who will start the application and process schedule servers.

## Chapter 9

# Using Application Data Set Designer

## Creating and Editing Data Set Definition

This section describes how to create and edit data set definitions.

### Searching For and Creating Data Sets

Use the Data Set Designer search page to search for, add, or delete a data set.

Navigation:

**PeopleTools > Lifecycle Tools > Migrate Data > Application Data Set Designer**

This example illustrates the fields and controls on the Data Set Search page. You can find definitions for the fields and controls later on this page.

The screenshot shows the 'Data Set Search' interface. At the top, there are two tabs: 'Find an Existing Value' (active) and 'Add a New Value'. Below the tabs, the title 'Data Set Search' is displayed, followed by the instruction: 'Enter any information you have and click Search. Leave fields blank for a list of all values.' Underneath, there is a section titled 'Search Criteria' with a dropdown arrow. The 'Search By' field is set to '\*Search By' and has a dropdown menu open showing 'Data Set Name', 'Description', and 'Owner Id'. To the right of the dropdown is the text 'begins with' followed by an empty text input field and a blue 'Add a New Value' button. A blue 'Search' button is located below the dropdown menu.

The Data Set Search page has two tabs: Find an Existing Value, and Add a New Value.

### Search

Search is the default action for Data Set Designer. Users can search for existing data sets and open an existing data set for modification. Users can also delete one or more data sets from the search result set.

You can search for an existing data set using:

- Data Set Name
- Description
- Owner ID

Basic and advanced search is provided so users can search based on one or multiple search keys. The search result produces a grid. Users can select one or multiple data sets in the grid to delete. Users can open the data set for modification using the link for the data set name.

This example illustrates the fields and controls on the Data Set Designer Search page.

Find an Existing Value
Add a New Value

### Data Set Search

Enter any information you have and click Search. Leave fields blank for a list of all values.

---

**Search Criteria**

\*Search By Data Set Name begins with ACT Add a New Value

Search
Advanced Search

---

**Search Results**

1-3 of 3

|                          | Data Set Definition Name | Description              | Object Owner ID |
|--------------------------|--------------------------|--------------------------|-----------------|
| <input type="checkbox"/> | ACTIVITY_GUIDE_DATATYPE  | Activity Guide data type | PeopleTools     |
| <input type="checkbox"/> | ACTIVITY_GUIDE_ITEM      | Activity Guide Item      | PeopleTools     |
| <input type="checkbox"/> | ACTIVITY_GUIDE_LIST      | Activity Guide List      | PeopleTools     |

Select All
Deselect All
Delete Selected Rows

## Create New Data Set

Select the Add a New Value tab or link to create a new data set.

Enter a Data Set Name and a description for the new data set. Data Set Name and Description are mandatory fields. When you click the Add button, the identity page is displayed.

See [Defining the Data Set](#).

## Defining the Data Set

Use the General page to identify the top-level properties of the data set.

Navigation:

**PeopleTools > Lifecycle Tools > Migrate Data > Application Data Set Designer**

This example illustrates the fields and controls on the Data Set Designer – General page. You can find definitions for the fields and controls later on this page.

General
Relations
Groups
Properties
Extension

### Data Set Designer

**Data Set Name** ACTIVITY\_GUIDE\_ITEM Add a New Value

**\*Description** Activity Guide Item

**Long Description**

**Owner ID** PeopleTools ▼

**Is Copyable**

**Derivation Type**

Loaded from Component
 Manually Entered

Define the record hierarchy for the data set definition.  
The keys of the data set definition can be selected from the keys of the root record. Add Record to Root

**Data Set Description**

| Record Name   |
|---|
| <div style="display: flex; align-items: center;"> <div style="margin-right: 5px;"> <span style="font-size: 10px;">☐</span> <span style="font-size: 10px;">→</span> </div> <span>PTAI_ITEM</span> <div style="margin-left: 5px; font-size: 10px;"> <span>⚙️</span> <span>+</span> <span>📄</span> </div> </div> |
| <div style="display: flex; align-items: center;"> <div style="margin-right: 5px;"> <span style="font-size: 10px;"> </span> <span style="font-size: 10px;">→</span> </div> <span>PTAI_HIER</span> </div>   |
| <div style="display: flex; align-items: center;"> <div style="margin-right: 5px;"> <span style="font-size: 10px;"> </span> <span style="font-size: 10px;">→</span> </div> <span>PTAI_ATTACH</span> </div>   |
| <div style="display: flex; align-items: center;"> <div style="margin-right: 5px;"> <span style="font-size: 10px;"> </span> <span style="font-size: 10px;">→</span> </div> <span>PTAI_ITEM_CNTXT</span> </div>   |
| <div style="display: flex; align-items: center;"> <div style="margin-right: 5px;"> <span style="font-size: 10px;"> </span> <span style="font-size: 10px;">→</span> </div> <span>PTAI_ITEM_LNG</span> </div>   |
| <div style="display: flex; align-items: center;"> <div style="margin-right: 5px;"> <span style="font-size: 10px;"> </span> <span style="font-size: 10px;">→</span> </div> <span>PTAI_ITM_ASGNTO</span> </div>   |
| <div style="display: flex; align-items: center;"> <div style="margin-right: 5px;"> <span style="font-size: 10px;">☐</span> <span style="font-size: 10px;">→</span> </div> <span>PTAI_OVRPGT_BTN</span> </div>   |
| <div style="display: flex; align-items: center;"> <div style="margin-right: 5px;"> <span style="font-size: 10px;"> </span> <span style="font-size: 10px;">→</span> </div> <span>PTAI_OVRPGTBLG</span> </div>  |

View Summary Report
Save As...

Return to Search

| <b>Field or Control</b> | <b>Description</b>  |
|-------------------------|---|
| Data Set Name           | Uniquely identifies the data set definition. Each data set definition describes a distinct shape, and there can be many instances of that type. |
| Description             | A description of the data set definition.   |
| Long Description        | A long description providing additional information such as guidance, limitations or cautions regarding this data set.                          |

| <b>Field or Control</b> | <b>Description</b>   |
|-------------------------|--|
| Owner ID                | Identifies the product that will own the data set definition and content.  |
| Is Copyable             | Selecting this check box indicates that the data included in the data set definition is suitable for copy from one database to another. Data is suitable for copy only if doing so will produce a valid object on the target and not corrupt any other data on the target. This field is only editable if <i>Allow setting Copy Compare attributes on ADS definitions</i> is selected for the users Data Migration security profile.<br><br>See <a href="#">Setting Data Migration Permissions</a> . |
| Derivation Type         | This indicates if the data set definition was created manually or generated from a component.<br><br><b>Note:</b> In PeopleTools 8.54, the generate option is no longer available.   |
| Add Record to Root      | Select the parent record, which will become the root record and is placed in the Record Hierarchy section.   |
| View Summary Report     | Select this link to view the summary report for the data set.<br><br>See <a href="#">Running ADS Summary Report</a>  |
| Save As                 | Select this link to clone an existing data set definition. You will be prompted to enter a new data set definition name.<br><br>See <a href="#">Cloning a Data Set Definition</a>  |

## Record Hierarchy

This section shows the record hierarchy for the data set.

There is at least one row for every record in the data set definition. Related language tables are automatically added by the system.



---

**Note:** A related language record can be added as a child record to its base record.

---

The following icons are used in the record hierarchy:

| <b>Icon</b>   | <b>Description</b>   |
|---|--|
|  | This icon will appear before each record in the hierarchy that is included in a merge group. |

| <b>Icon</b>   | <b>Description</b>   |
|---|--|
|  | Click this icon to add a child record to the hierarchy.  |
|  | Click this icon to view the record details.  |
|  | Click this icon to delete a record in the hierarchy.<br><hr/> <b>Note:</b> The root record can not be deleted once the data set definition is saved. <hr/> |

Use the Insert Record icon to build the record hierarchy and add additional child records.

This example illustrates the fields and controls on the Icon to insert child record. You can find definitions for the fields and controls later on this page.

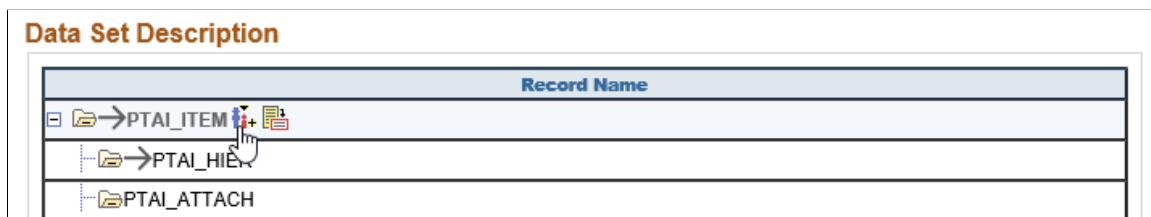

When you select the Insert Record icon, a child record insertion dialog will open with child record lookup. A child record is a record having the same keys as parent record. The child record may also contain additional keys. The lookup list will be restricted to records that include all keys (and possibly additional keys) of the corresponding parent record that have not already been selected for the current parent record name.

In record hierarchy, the related language record plays a significant role. When a record added to a data set definition (either as root record or as a child record) has a related language record, it is implicitly included in the data set as a child record.

**Note:** If you use the delete icon to delete a related language record, a warning message is displayed "Do you want to delete a Related Language Record? (257,755) Deleting Related Language Record separately would cause inconsistency between multiple languages". If the user clicks *Yes* the warning is ignored and the related language record is deleted. If the user clicks *No* the related language record remains in the data set.

You can also use the Details icon to view the keys and labels for a record.

This example illustrates the fields and controls on the Record Details page. You can find definitions for the fields and controls later on this page.

**Record Details**

Data Set Name ACTIVITY\_GUIDE\_ITEM  
 Record Name PTAL\_ITEM  
 Record Description Action Items

Override Record Report Label

**Record Fields**

1-73 of 73

| Primary Key                         | Field Name     | Field Long Name   | Override Report Label ID | Report Label      | Content Type         | Mergeable                           |
|-------------------------------------|----------------|-------------------|--------------------------|-------------------|----------------------|-------------------------------------|
| <input checked="" type="checkbox"/> | PTAL_ITEM_ID   | Item ID           | <input type="text"/>     | Item ID           |                      | <input type="checkbox"/>            |
| <input type="checkbox"/>            | PTAL_LIST_ID   | Activity Guide ID | <input type="text"/>     | Activity Guide ID |                      | <input type="checkbox"/>            |
| <input type="checkbox"/>            | PTAL_LABEL     | Title             | <input type="text"/>     | Title             |                      | <input checked="" type="checkbox"/> |
| <input type="checkbox"/>            | PTAL_DESCRLONG | Description       | <input type="text"/>     | Description       | <input type="text"/> | <input checked="" type="checkbox"/> |
| <input type="checkbox"/>            | PTAL_PRIORITY  | Priority          | <input type="text"/>     | Priority          |                      | <input checked="" type="checkbox"/> |
| <input type="checkbox"/>            | PTAL_STATUS    | Status            | <input type="text"/>     | Status            |                      | <input checked="" type="checkbox"/> |
| <input type="checkbox"/>            | PTAL_DUE_DATE  | Due Date          | <input type="text"/>     | Due Date          |                      | <input checked="" type="checkbox"/> |
| <input type="checkbox"/>            | PTAL_ASSIGN_DT | Assigned Date     | <input type="text"/>     | Assigned Date     |                      | <input type="checkbox"/>            |

| <b>Field or Control</b>      | <b>Description</b>   |
|------------------------------|--|
| Override Record Report Label | The field and record labels are shown in compare reports. The object owner can override the default record label by entering a record report label here.     |
| Override Report Label ID     | The field and record labels are shown in compare reports. The object owner can select a different field label to use in the Override Report Label ID column. |
| Content Type                 | For long character fields, you can indicate if the field should be rendered in html or text on the compare report.   |
| Mergeable                    | If the field is in at least one merge group, the check box will be selected.<br><br>For more information on merge groups see <a href="#">Defining Groups</a> |

**Note:** A large record hierarchy level in a Data Set may cause performance issues, therefore if the record hierarchy level is more than 4, a warning is displayed when saving the data set definition.

This example illustrates the warning message when the level of record hierarchy exceeds 4.

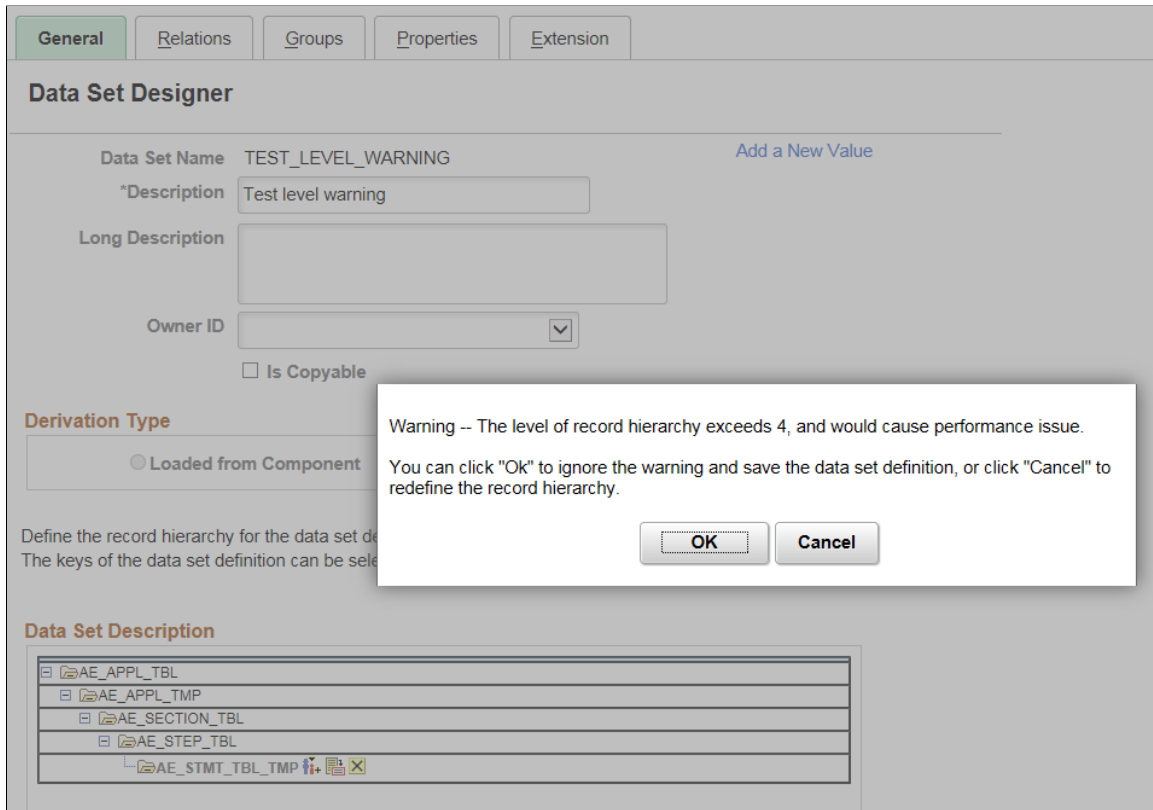

## Record Restrictions

The records in data set definitions have the following restrictions:

- Application Data Set definitions can only contain records that are physical tables.
- Data Set Designer allows a record to appear only once in the record hierarchy.
- All records in a data set must have unique keys as defined in the key view of the record in Application Designer.
- The keys of the parent record must also be keys of the child record, though a child record may have some keys that are not in the parent record.
- The root record cannot be deleted from the data set hierarchy once the data set has been saved.

When creating a new data set definition, you will have the ability to delete the root record before saving the definition.

This example illustrates the delete icon available on the root record.

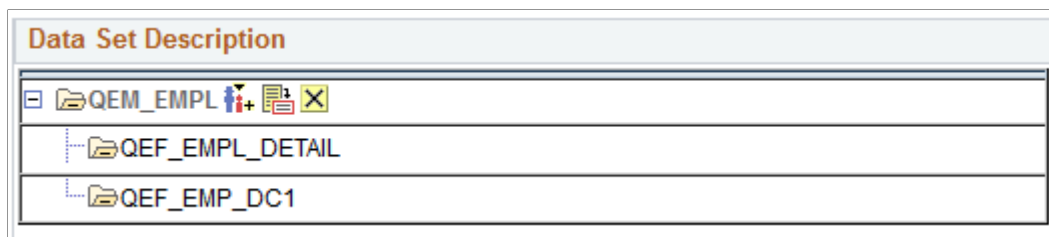

When you delete the root record, all child records are also deleted. If the root record is deleted, you can not save the data set definition.

## Cloning a Data Set Definition

Save As is used to clone an existing data set definition. To clone a definition:

1. Select PeopleTools, Lifecycle Tools, Migrate Data, Application Data Set Designer.
2. Select the data set definition you want to clone.
3. Click Save As.
4. On the Save Data Set As page, enter a name and description for the new data set, then click OK.

The system will verify that the new data set name does not already exist. If it does, you will be prompted to enter another name.

In the resulting cloned data set definition:

- All of the original data set definition's properties except for extension property will be displayed.
- The relation name is changed automatically to the new data set name.
- The Owner ID is NULL by default.

---

## Defining Relations

Use the Relations page to define the relationship of this data set to other data sets.

Navigation:

**From the General page > Relations tab.**

This example illustrates the fields and controls on the Data Set Designer – Relations page. You can find definitions for the fields and controls later on this page.

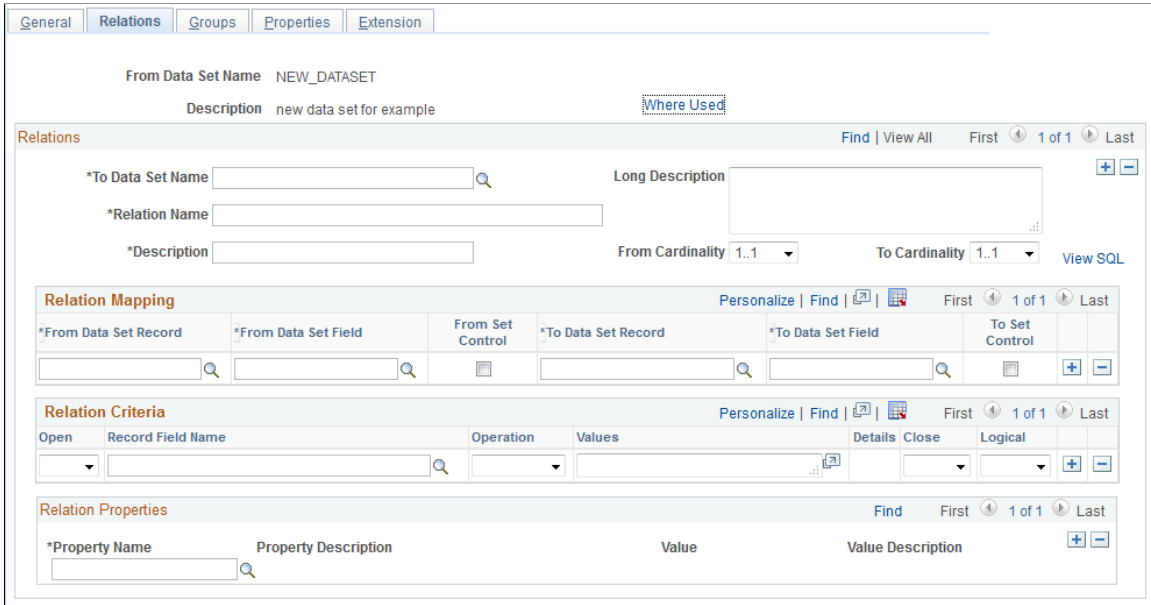

Relations

| <b>Field or Control</b> | <b>Description</b>   |
|-------------------------|--|
| To Data Set             | Enter the name of the data set to include in the relationship.   |
| Relation Name           | Enter a name for the relation.   |
| Description             | Enter a description for the relation.  |
| Long Description        | Enter a long description for the relation.   |
| From Cardinality        | Enter the cardinality for the referencing data set.<br><br>The values of cardinality are as follows: <ul style="list-style-type: none"> <li>• 0..1<br/>0 or 1 (optional)</li> <li>• 1<br/>exactly 1</li> <li>• 0..*<br/>0 or more</li> <li>• 1..*<br/>1 or more</li> </ul> |

| <b>Field or Control</b> | <b>Description</b>   |
|-------------------------|--|
| To Cardinality          | <p>Enter the cardinality for the referenced data set.</p> <p>The values of cardinality are as follows:</p> <ul style="list-style-type: none"> <li>• 0..1<br/>0 or 1 (optional)</li> <li>• 1<br/>exactly 1</li> <li>• 0..*<br/>0 or more</li> <li>• 1..*<br/>1 or more</li> </ul> |

## Relation Mapping

The relation mapping section is used to define a set of foreign key fields in a referencing data set to key fields in a referenced data set. Enter one row for each key that needs to be mapped.

Both the From (referencing) and the To (referenced) keys can be in either the parent record or child record of the data set definition.

| <b>Field or Control</b> | <b>Description</b>   |
|-------------------------|--|
| From Data Set Record    | Enter the name of the record in the current data set that will be used to map to a record on the To Data Set.            |
| From Data Set Field     | Enter the name of the field in the current data set that will be used to map to a record on the To Data Set.             |
| From Set Control        | Select this check box if the data set uses set control processing and the set control value is on the From record/field. |
| To Data Set Record      | Enter the name of the record in the to data set that will be used to map to a record on the From Data Set.               |
| To Data Set Field       | Enter the name of the field in the to data set that will be used to map to a field on the From Data Set.                 |
| To Set Control          | Select this check box if the data set uses set control processing and the set control value is on the To record/field.   |

## Relation Criteria

The Relation Criteria section is used to specify conditions imposed on the relation mapping between records within the data set definitions. Both the To and From records can be either the root or child record. This criteria modifies whether or not the relationship applies. The criteria applies to all uses of the relationship.

The value is a WHERE clause-like expression containing only table names, record names, SQL operators, and literals. There may be verbs introduced to avoid entering anything other than table name, record name, SQL operator, and literals.

Use this section to build the WHERE clause.

| <b>Field or Control</b> | <b>Description</b>   |
|-------------------------|--|
| Open                    | If you are entering multiple criteria, select the appropriate open parentheses necessary to group the criteria.              |
| Record Field Name       | Enter the record field name. Use the prompt button to see all the record fields available on both the From and To data sets. |
| Operation               | Select the operator. All standard SQL operators are available from the drop down list.                                       |
| Values                  | Enter the value or values for your expression.   |
| Details Lookup Icon     | Use the lookup icon to select values for the record field name selected.   |
| Close                   | If you are entering multiple criteria, select the appropriate close parentheses necessary to group the criteria.             |
| Logical                 | When you specify two or more selection criteria, You need to indicate the logical operator – AND or OR.                      |

## Relation Properties

There is an underlying set of relationship APIs used by all the behavioral APIs to get related objects. In cases where some but not all of the related objects are desired, relation properties are used as filters. Relationship properties are name, value pairs that are associated with a relationship.

This diagram illustrates a relationship named X.Y between two instance having data set definitions named X and Y, respectively. Each instance has one key, whose values are A and B, respectively. The relationship metadata is part of data set definition X.

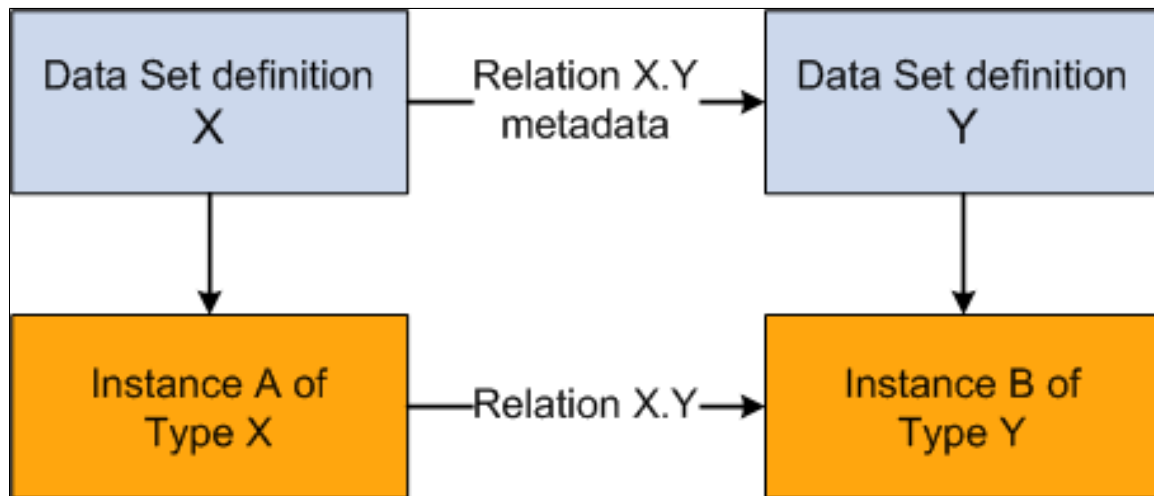

PeopleSoft delivers the following relationship properties:

- Family

The *Family* property is used when there is custom PeopleCode to synchronize merging of two or more instances in parallel. This can occur when the mergeable attributes in one instance affect values in another instance. For example, families are used for Pivot Grids, Activity Guides, and Related Content instances.

- Insert Inverse Relation and Insert into Project

Use these properties to designate if and how related objects should be inserted into a project.

The *Insert Inverse Relation* applies to the backward reference: whether to insert instances referenced by an instance that is being inserted. For the relation X.Y illustrated in the *Definition and Instance Relationship* diagram above, the *Insert Inverse Relation* property applies to determine whether A should be inserted when B is being inserted.

The *Insert into Project* applies to the forward reference: whether to insert instances referenced by an instance that is being inserted. For the relation X.Y illustrated in the *Definition and Instance Relationship* diagram above, the *Insert into Project* property applies to determine whether B should be inserted when A is being inserted.

There are 2 value options:

- *PROMPT*, the user will be prompted whether or not to insert the object type.
  - *FORCE*, the related objects will be inserted even if not selected by the user if the other partner in the relationship is selected.
- Insert Recursion Limit

The *Insert Recursion Limit* property is used to define how many levels of relations beyond the nearest neighbor should be inserted into the project. If not specified, the default is that the insertion applies only to nearest neighbor.

- Validate Integrity

The *Validate Integrity* property is used to verify all required *To Data Set* instances exist for all *From Data Set* instances in the project. Set the severity level for missing references.

- Validate Inverse Relation

The *Validate Inverse Relation* property is used to verify all required *From Data Set* instances exist for all *To Data Set* instances in the project. Set the severity level for missing references.

## Defining Groups

Groups are used to define sets of records and/or fields for which some common processing is required. The processing is controlled by the properties associated with the groups.

Use the Groups page to define the records and fields to be included in the group, as well as assigning the group properties.

This example illustrates the fields and controls on the Data Set Designer – Groups page. You can find definitions for the fields and controls later on this page.

| <b>Field or Control</b> | <b>Description</b>        |
|-------------------------|---------------------------|
| Group Code              | Enter a group code.       |
| Group Name              | Enter a group name.       |
| Description             | Enter a group description |

### Group Members

Use this section to add records and fields to the group. The record must exist in the data set and the field must exist on the selected record.

Fields are optional. If no field is chosen, the entire record is within the group. Omitting record and field would be equivalent to an object property.

If the user deletes a record from the data set definition via the tree on the General tab, the corresponding group members will be deleted. If a field is deleted on a record the file is removed from the group. If the data set definition is deleted, group rows will be deleted as well. If the records or fields are renamed or deleted, the group members will be renamed or deleted.

---

**Note:** If no field is specified for the record then for the purpose of data integrity, all its child records will also be added to the group automatically when saving group definition.

---

## Group Properties

Group properties apply to the members of the group.

The following group properties are available:

| <b>Group</b>         | <b>Description</b>  |
|----------------------|---|
| Merge Configurations | <p>The MERGE property is used during copy to preserve any configuration changes made on the target data set instance if the fields changed are part of this data set group.</p> <p>Merge group allows the object owner to declare that the attributes within the group are relations and can be changed independently of other attributes.</p> <hr/> <p><b>Note:</b> If no field is chosen for a record in the group members, then the entire record will be merged. This means the entire row change and any child rows for the record in target will be preserved by default. All its child records will also be added to the group automatically when saving the group definition.</p> <hr/> |
| Hide Differences     | <p>The Hide group allows the object owner to identify records and fields that are less important and any differences in these fields can be hidden on the compare report to simplify the review process.</p>  |

A group with or without properties can be used in compare visualization for filtering purposes. For example, it might be useful to create a group of all translatable text attributes, or all position attributes on a page.

---

## Defining Data Set Properties

Use the Properties page to assign properties to the data set.

Navigation:

## From the General page > Properties tab.

This example illustrates the fields and controls on the Data Set Designer – Properties page. You can find definitions for the fields and controls later on this page.



The following properties are available on this page:

- **HTML Style Sheet**  
Style sheet to use when rendering HTML in the compare visualization.
- **Instance Search View**  
Name of a view to use when searching for data set instances in the DMW. The search keys specified on the view will display by default. All keys of the root record must be keys in the specified view.
- **Last Updated Timestamp Field**  
Used together with LASTUPDOPRID to determine the default merge action on compare/copy.
- **Last Updated User ID Field**  
Used together with LASTUPDDTTM to determine the default merge action on compare/copy.
- **Managed Object Delete Table**  
Enter the name of the delete table for the managed object. This information is used to delete cache when an object is deleted or renamed. Objects that do not have a C++ manager should omit this property.
- **Managed Object Name**  
Designate the data set as a managed object. If the object has a C++ manager, the property value is the C++ acronym for that object, such as RDM. Objects that do not have a C++ manager should leave this blank.
- **Managed Object Version**  
Specify the OBJECTTYPENAME of a row in PSVERSION and PSLOCK for the managed object. This information is used to synchronize cache when the object is updated. Objects that do not have a C++ manager should omit this property.

## Defining Extension

Use the Extension page to define the extension application class that will be used by the object owner to provide custom PeopleCode validate, transforms, and merge data set instances.

Navigation:

**From the General page > Extension tab.**

This example illustrates the fields and controls on the Data Set Designer – Extension page. You can find definitions for the fields and controls later on this page.

The screenshot shows the 'Extension' tab of the Data Set Designer. At the top, there are five tabs: 'General', 'Relations', 'Groups', 'Properties', and 'Extension'. Below the tabs, the 'Data Set Name' is 'NEW\_DATASET'. The main section is titled 'Extension App Class' and contains three input fields with search icons:

- Package Name
- App Package Path
- Application Class ID

The applicant class the user specifies on this page will extend the PTADSDEFN:AdsValidationBase application class that is part of the data set framework. Specific methods of the AdsValidationBase application class or its extension class are invoked at a particular time during processing.

There are four areas of functionality controlled by in the AdsValidationBase application class that are designed to be implemented by object owners:

- DB Integrity Checks
- To File Custom Transforms
- From File Custom Transforms
- From File Custom Merging

### Application Class Extension

Developers can extend the PTADSDEFN:AdsValidationBase base class to define specific validation logic. AdsValidationBase provides an empty implementation of the methods of the Application Class that a data set definition may be associated with. To provide validation or transformation logic in PeopleCode, a developer will override the appropriate base class methods and provide additional methods and properties as necessary.

Validation is implemented in the CustomValidate method. See [CustomValidate](#).

---

**Important!** Unless mentioned in this document as being designed for extension other methods in the `AdsValidationBase` base class are used internally so changing or overriding them will modify basic behavior.

---

## DB Integrity Checks

The Database Integrity Check should be run on the target database after the copy from file to ensure database integrity.

DB Integrity Checks use the `DoADSValidations` method provided in the `AdsValidationBase` base class. This method will validate for static prompts, translates, Y/N values, and required fields. If a validation error is detected, information about the error is written to a target database table and `DoADSValidations` returns false to the C++ layer. Thus even if no application class has been associated with the ADS definition, this method will perform the default validations.

## To File Custom Transforms

To File Custom Transforms are used by the owners of a few objects to implement custom transform instances from a newer PeopleTools release to an older release, such as from 8.54 to 8.53. This transform is applied at copy to file time and on the newer release. The ADS and record definitions of both the newer and older release must be present.

The transform is implemented in the `DoTransform` method. See [DoTransform](#).

## From File Custom Transforms

From File Custom Transforms might be used by the owners of a few objects in a few circumstances such as:

1. To implement custom transform instances from a older PeopleTools release to an newer release, such as from 8.53 to 8.54.
2. To provide value transforms when data in the object needs to be adjusted in some way.
3. To perform custom merging outside of merge groups.

This transform is applied prior to compare, validate or copy from file time on the newer release. The ADS and record definitions of both the newer and older release must be present.

The transform is implemented in the `CustomTransform` method. See [CustomTransform](#)

## From File Custom Merging

This is for adjusting the automated merging performed when merge groups are present. Attribute values that are in a merge group are, by default, merged to the source from the target. However, there may be additional adjustments that need to be made to the object to assure the object has consistent data. In some cases other objects in the same FAMILY may also be adjusted at this time.

The transform is implemented in the `CustomMerge` method. See [CustomMerge](#)

## CustomValidate

### Syntax

```
CustomValidate (&ADSRowset, &ADSName, &CompareType)
```

### Description

Implemented by object owners to provide custom validation logic.

### Parameters

| <i>Parameter</i>        | <i>Description</i>   |
|-------------------------|--|
| <i>&amp;ADSRowset</i>   | Specifies the current in-memory data set instance as a rowset object.  |
| <i>&amp;ADSName</i>     | Specifies the ADS name as a string.  |
| <i>&amp;CompareType</i> | <p>Specifies the compare type as integer:</p> <ul style="list-style-type: none"> <li>• 4 indicates premerge validation</li> <li>• 1 indicates post merge validation</li> <li>• 6 indicates Check DB Integrity</li> </ul> <p>The premerge validation is performed only if there are merge groups in the data set.</p> |

### Returns

Integer.

## DoTransform

### Syntax

```
DoTransform (&AdsNameArray)
```

### Description

Implemented by object owners to provide custom copy to file transform, often to an older PeopleTools release.

## Parameters

| <b>Parameter</b>         | <b>Description</b>   |
|--------------------------|--|
| <i>&amp;ADSNameArray</i> | <p>AdsNameArray is an array of ADSM:AdsNameRowset.</p> <p>An ADSM:AdsNameRowset is a (data set name, data set rowset) pair. When the function is called, this array will contain a single ADS instance in the form of the newer release. On return this array will contain 0 or more rowsets in the form of the target release. There can be more than one output rowset if the data set in one release was represented as several data sets in another release. There would be no rowsets in the array on return if the data set definition did not exist in the older release.</p> <p>The target release is passed as a property named TargetRelease to the AdsValidationBase constructor – this can be used to determine what transform to apply.</p> |

## Returns

Integer.

## CustomTransform

### Syntax

**CustomTransform** (&ADSRowset, &ADSName)

### Description

Implemented by object owners to provide custom transform logic at compare, validate or copy from file time.

### Parameters

| <b>Parameter</b>      | <b>Description</b>   |
|-----------------------|--|
| <i>&amp;ADSRowset</i> | Specifies the current in-memory data set instance as a rowset. |
| <i>&amp;ADSName</i>   | Specifies the ADS name as a string.                            |

### Returns

Integer.

## CustomMerge

### Syntax

`CustomMerge (&ADSRowset, &ADSName, &CompareType)`

### Description

This method is implemented by object owners to provide custom merge logic. If merge groups are present in the data set, then prior to compare, validate and copy each instance in the source project file is copied to memory, and the corresponding target is also copied into memory. The merge groups attributes from the in-memory source rowset are copied into the in-memory target rowset. The resulting rowset is then passed to CustomMerge to allow programmatic adjustments.

### Parameters

| <i>Parameter</i>        | <i>Description</i>   |
|-------------------------|--|
| <i>&amp;ADSRowset</i>   | Specifies the current in-memory data set instance as a rowset object.  |
| <i>&amp;ADSName</i>     | Specifies the ADS name as a string.  |
| <i>&amp;CompareType</i> | <p>Specifies the compare type as integer:</p> <ul style="list-style-type: none"> <li>• 4 indicates premerge</li> </ul> <p>The premerge call is called after the default merge has been performed but before compare is run and before the user modifies merge options.</p> <ul style="list-style-type: none"> <li>• 1 indicates post merge</li> </ul> <p>The post merge validation is executed after a user has changed the merge options and prior to copy.</p> |

## Flow for the To File Process

The only To File process is Copy to File.

During copy to file the framework iterates over instances in the project, and for each instance calls the OnCopyToFile base class method. In turn, OnCopyToFile calls DoTransform. The base class DoTransform makes no changes, but if the derived class implements this method then the source object may change when copied to the project XML file.

## Flow for the From File Processes

The From File processes are Compare from File, Validate from File, Copy from File.

During From File processing the framework iterates over instances in the project, and for each instance calls the OnPreCopyCompare then OnPreUpdate base class methods. OnPreCopyCompare is implemented in the base class to make the roughly following preliminary calls:

1. CustomTransform: any special *from file* transforms.
2. Validate: standard validations of original source if DB Integrity or Validate is selected.
3. CustomValidate: any special validations.
4. Merge: perform default merge of merge groups. This includes a compare of original source object.
5. CustomMerge: any special adjustments to merge.
6. Compare: compare merged rowset if compare was requested and merging was performed.
7. Validate and CustomValidate: validate merged rowset if validate was requested and merging was performed.
8. Copy: if copy was requested. If compare was run, then the user's compare selections will be honored.



# Understanding ADS Projects

## Understanding ADS Projects

Once you have created a data set definition, you can create an ADS project to encapsulate instances of the data defined by the data set definition allowing the instances to be compared and copied. In the main Data Migration Workbench page, you first select data set definitions to include in the project, then select the instances of that data to insert into the project. What ultimately gets inserted into the database is a set of data set instances each identified by a unique set of root-level keys. The data contents are filtered based on the keys in the data set.

You can define multiple projects with different criteria for the same data set.

This example illustrates that the content data is defined in an ADS project.

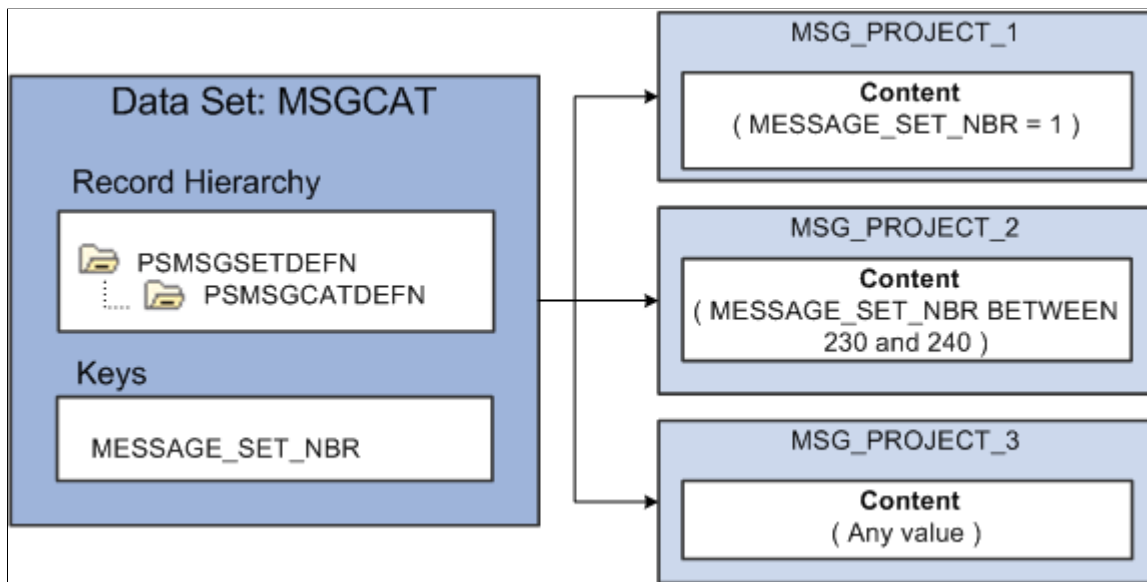

Once data set content has been inserted into a project and security criteria fulfilled on source, the project can be copied to a file. Once the data set project has been copied to a file, it can be loaded into a target database and compared from file on the target database.

**Note:** The target database must contain the Data Set definition that is included in the ADS project file, however the corresponding ADS structure or the record structure may be different than on the source database, which may require a shape transform.

## Searching for, Adding and Deleting Projects

Use the Project Search page to search for or create new ADS projects.

**Note:** You can add data set instances directly to a new or an existing ADS project from the object designer pages (PIA) by using the Add to Project button rather than navigating to Data Migration Work Bench page.  
 See [Adding Data Set Instances from Object Designer Pages](#).

Navigation:

**PeopleTools > Lifecycle Tools > Migrate Data > Data Migration Workbench**

This example illustrates the fields and controls on the Project Search page. You can find definitions for the fields and controls later on this page.

**Project Search**

Enter any information you have and click Search. Leave fields blank for a list of all values.

---

**Search Criteria**

Project Name  [Add a New Value](#)

Description  [Load Project From File](#)

---

**Search Results**

1-5 of 5

|                          | Project Name             | Project Description | Project State                 |
|--------------------------|--------------------------|---------------------|-------------------------------|
| <input type="checkbox"/> | <a href="#">EXAMPLE</a>  | Sample ADS project  | Integrity checked with errors |
| <input type="checkbox"/> | <a href="#">EXAMPLE1</a> | Pivot grid example  | Created                       |
| <input type="checkbox"/> | <a href="#">EXAMPLE2</a> | PG EXAMPLE 2        | Copy to file succeeded        |

When you click the Search button on the Project Search page, a grid displaying projects matching the criteria is displayed.

Click the Project Name link to open the ADS project for modification.

**Deleting Projects**

To delete projects:

1. Select PeopleTools, Lifecycle Tools, Migrate Data, Data Migration Workbench.
2. Click Search.
3. Select the projects to delete.
4. Click the Delete Selected Rows link.

**Adding Projects**

To add a project:

1. Select PeopleTools, Lifecycle Tools, Migrate Data, Data Migration Workbench.

2. Click the Add a New Value link.
3. Enter a Project Name and Description.
4. Click Add.

### Loading Project from File

To load a project from file:

1. Select PeopleTools, Lifecycle Tools, Migrate Data, Data Migration Workbench.
2. Click the Load Project from File link.
3. Select the file location and area.
4. Click Add.

---

**Note:** All data set definitions must exist on the target database before you can load the project. Load project from file only loads the project definition and data set bindings, no data content is copied.

---

---

## Defining ADS Project

To define a new project:

1. The initial state is New Project. Add a description and comments.
2. Select a data set.
3. When you tab off the data set name, the Insert Data Set Content page is displayed for that data set.
4. Select the data set content.

See [Inserting Data Content](#)

5. Save the project. The new status is Created.
6. Additional data sets can be added to the project.

Use the Project Definition page to define the ADS project.

Navigation:

**PeopleTools > Lifecycle Tools > Migrate Data > Data Migration Workbench**

This example illustrates the fields and controls on the Project Definition page. You can find definitions for the fields and controls later on this page.

### Data Migration Workbench

---

Project Name EXAMPLE

\*Description

Comments

Project State Created

Progress

**Project Content**

1-3 of 3 | View All

| Data Set Name              | Description              |   |   |
|----------------------------|--------------------------|---|---|
| PIVOTGRID_DEFINITION       | Pivot Grid Definition    | + | - |
| RCF_SERVICES               | RC Services              | + | - |
| RCF_SERVICE_CONFIGURATIONS | RC Service Configuration | + | - |

| <b>Field or Control</b> | <b>Description</b>   |
|-------------------------|--|
| Description             | Enter a description for the project. The description should include information about the project. |
| Comments                | Optionally you can add comments to the project.  |

| <b>Field or Control</b> | <b>Description</b>   |
|-------------------------|--|
| Project State           | <p>Display only field that shows the current state of the project. You can use the Refresh button to obtain the most recent state.</p> <p>Progress state on the source will show:</p> <ul style="list-style-type: none"> <li>• New project</li> <li>• Created</li> <li>• Scheduled for copy to file</li> <li>• Copying to file</li> <li>• Copy to file succeeded</li> </ul> <p>Progress state on the target will show:</p> <ul style="list-style-type: none"> <li>• Loaded from file</li> <li>• Scheduled for file compare</li> <li>• Comparing from file</li> <li>• Copying from file</li> <li>• Compare from file succeeded</li> <li>• Scheduled for copy from file</li> <li>• Copy from file succeeded</li> </ul> <p>Validation errors, if any, are also shown.</p> |
| Progress                | Display only field that shows the progress of the project copy or compare.   |
| Data Set Name           | Select one or more existing data sets from the lookup. Look up will show all the existing data sets that have <i>Is Copyable</i> selected in the data set definition.  |
| Content Description     | This is description associated with the data set content.  |
| Add a new row (+)       | Click to add another data set to the project.  |
| Delete a row (-)        | Click to delete a data set from the project.   |

**Note:** ADS projects are not shown in Application Designer project search and cannot be opened in Application Designer.

## Defining Data Set Content

When the data set name is selected on the Project Definition page, the Insert Data Content page will open when you tab off the data set name field. See [Inserting Data Content](#).

Use the Data Set Content page to review the data content for the project and add additional content.

Navigation:

To add additional data set instances or modify the data set instances in an existing data set, click on the Data Set Name on the Project Definition page.

This example illustrates the fields and controls on the Data Set Content page. You can find definitions for the fields and controls later on this page.

The screenshot shows the 'Data Set Content' page for a project named 'EXAMPLE'. The 'Data Set Name' is 'PIVOTGRID\_DEFINITION'. The page includes an 'Insert Content' button, a 'Filters' section, and a table of pivot grid definitions. Below the table are buttons for 'Select All', 'Deselect All', 'Delete', 'Save', 'Return', and 'Update Data Set Action...'.

| Select                   | Pivot Grid Name       | Pivot Grid Title     | Action |
|--------------------------|-----------------------|----------------------|--------|
| <input type="checkbox"/> | QE COPY CUST BOOK PG  | QE COPY CUST BOOK PG | Copy   |
| <input type="checkbox"/> | QE COPY SUPPLY PROD C | Supply Production    | Copy   |
| <input type="checkbox"/> | DEMO_CHART            | Example Pivot Grid   | Copy   |

Use the Insert Content button to define the data content for the project.

See [Inserting Data Content](#)

After data has been inserted into the project, you can select which rows of data you want to process.

| <b>Field or Control</b> | <b>Description</b>   |
|-------------------------|--|
| Select                  | Use this check box to select the rows for one of the actions available.        |
| Action                  | By default, the action type is Copy. You can change the action type to Delete. |
| Select All              | Use the Select All button to select all rows.                                  |

| <b>Field or Control</b> | <b>Description</b>                                |
|-------------------------|---|
| Deselect All            | Use the Deselect All button to deselect all rows. |
| Delete                  | Use to delete select rows.                        |
| Update Data Set Action  | Use to change the action for selected rows.       |

## Inserting Data Content

To insert content into the project:

1. Click the link for the data set on the project definition page.
2. Click the Insert Data button.
3. By default the Basic search criteria is displayed.

**Note:** When you enter a Data Set Name on the Project Definition page, the Insert Data Content page will open when you tab off the Data Set Name field.

Use the Insert Data Content page to insert data content into the ADS project.

Navigation:

**Click the Insert Content button on the Data Set Content page.**

This example illustrates the fields and controls on the Insert Data Content page. You can find definitions for the fields and controls later on this page.

The screenshot displays the 'Insert Data Set Content' interface. At the top, it states: 'This page allows users to identify and insert instances of data into the project. Users can limit the scope of the result set by entering and refining search criteria.' Below this, the 'Project Name' is 'EXAMPLE' and the 'Data Set Name' is 'PIVOTGRID\_DEFINITION'. The search criteria is set to 'Pivot Grid Name Begins with QE\_COPY'. There are checkboxes for 'Case Sensitive' and an 'Advanced Search' link. A 'Search' button is present. The search results table shows the following data:

| Select                              | Pivot Grid Name                | Pivot Grid Title               |
|-------------------------------------|--------------------------------|--------------------------------|
| <input checked="" type="checkbox"/> | QE_COPY_CUST_BOOK_PG           | QE_COPY_CUST_BOOK_PG           |
| <input type="checkbox"/>            | QE_COPY_PROD_SUPPLY_G          | QE_COPY_PROD_SUPPLY_G          |
| <input type="checkbox"/>            | QE_COPY_PROD_SUPPLY_GC         | QE_COPY_PROD_SUPPLY_GC         |
| <input checked="" type="checkbox"/> | QE_COPY_SUPPLY_PROD_C          | Supply Production              |
| <input type="checkbox"/>            | QE_COPY_PG_CHARTONLY_OPTION    | Product Chart                  |
| <input type="checkbox"/>            | QE_COPY_PG_GRIDANDCHART_OPTION | QE_COPY_PG_GRIDANDCHART_OPTI_T |
| <input type="checkbox"/>            | QE_COPY_PG_GRIDONLY_OPTION     | QE_COPY_PG_GRIDONLY_OPTION_T   |
| <input type="checkbox"/>            | QE_COPY_PG_MULTI_FILTERS_C     | QE_COPY_PG_MULTI_FILTERS_C_T   |

At the bottom of the search results, there are buttons: 'Select All', 'Deselect All', 'Insert Content', 'Insert and Return', and 'Cancel'. On the right side, there is a section for 'Insert Related Data Sets' with a table:

| Select                              | Data Set Name              | Description              | Open |
|-------------------------------------|----------------------------|--------------------------|------|
| <input checked="" type="checkbox"/> | RCF_SERVICES               | RC Services              |      |
| <input checked="" type="checkbox"/> | PIVOTGRID_DEFINITION       | Pivot Grid Definition    |      |
| <input checked="" type="checkbox"/> | RCF_SERVICE_CONFIGURATIONS | RC Service Configuration |      |

Below the related data sets table, there are links: 'Select All Data Sets' and 'Deselect All Data Sets'.

| <b>Field or Control</b>  | <b>Description</b>  |
|--------------------------|---|
| Search Criteria          | By default the Basic Search Criteria is displayed. Click the Advanced Search link to access.  |
| Key Field                | In the Basic Search only the key fields are displayed.  |
| Operation                | The operations for basic search are based on the search criteria for the data set definition.   |
| Values                   | Enter the value for the SQL.  |
| Search button            | Click the Search button to display the rows meeting the filter criteria and display them on the Search Results grid.  |
| Search Results Grid      | Use the Search Results grid to select the rows of data to include in the data set content.  |
| Select All               | Use the Select All button to select all rows.   |
| Deselect All             | Use the Deselect All button to deselect all rows.   |
| InsertContent            | Click the Insert Content button to insert the selected rows into the data set content and remain on the page.   |
| Insert and Return        | Click the Insert and Return button to insert the selected rows into the data set content and return to the Data Set Content page.   |
| Insert Related Data Sets | <p>If the data set selected contains relationships to other data sets, the Insert Related Data Sets grid is displayed. Depending on how the related data sets were defined, they will either always be included, or the user will be able to select which related data sets to include in the project.</p> <p>See <a href="#">Defining Relations</a>.</p> |

This example illustrates the fields and controls on the Advanced Search Criteria example. You can find definitions for the fields and controls later on this page.

**▼ Search Criteria**

Pivot Grid Name

Pivot Grid Title

Case Sensitive    [Basic Search](#)   

**Search Results**

| 1-1 of 1                 |                 |                    |
|--------------------------|-----------------|--------------------|
| Select                   | Pivot Grid Name | Pivot Grid Title   |
| <input type="checkbox"/> | DEMO_CHART      | Example Pivot Grid |

| <b>Field or Control</b> | <b>Description</b>  |
|-------------------------|---|
| Field Name              | <p>There are two types of fields in the grid.</p> <ul style="list-style-type: none"> <li>• <b>Read-only:</b> These are the key fields of the record selected while defining the data set definition. These fields can not be removed.</li> </ul> <p>See <a href="#">Creating and Editing Data Set Definition</a>.</p> <ul style="list-style-type: none"> <li>• <b>Non Key:</b> You can add any other non key fields from the root record of the data set definition. This addition is not in the data set definition, it is specific to this data set content in this specific ADS project .</li> </ul> |

| <b>Field or Control</b> | <b>Description</b>  |
|-------------------------|---|
| Operation               | <p>Select the operation to use for this field. Valid operations are:</p> <ul style="list-style-type: none"> <li>• != (not equal)</li> <li>• &lt; (less than)</li> <li>• &lt;= (less than or equal)</li> <li>• = (equal)</li> <li>• &gt; (greater than)</li> <li>• &gt;= (greater than or equal)</li> <li>• All</li> <li>• Between</li> <li>• In</li> <li>• Is NULL</li> <li>• Is Not NULL</li> <li>• Like (Value contains specified text)</li> <li>• Not Between</li> <li>• Not In</li> <li>• Not Like</li> </ul> |
| Values                  | <p>Enter the value for the SQL.</p> <p>For every operation other than <i>All</i> you need to supply one or more values in this text box. Based on the operator and value, the system will build the actual WHERE clause for the filter condition on the root record of the data set definition.</p> <p>See <a href="#">Using Operators to Build the WHERE Clause</a>.</p>   |

## Using Operators to Build the WHERE Clause

This section provides examples for building WHERE Clauses.

### Numeric Operators

For any of the numeric operators, select the operator and provide a value.

This example illustrates using the equal operation.

Project Name SAMPLES  
Data Set Name MSG\_CAT\_SET\_DEFN Message Catalog Set

▼ Search Criteria

Message Set Number =

Case Sensitive [Advanced Search](#)

**Search Results**

1-1 of 1

| Select                   | Message Set Number | Description          |
|--------------------------|--------------------|----------------------|
| <input type="checkbox"/> | 257                | Application Data Set |

## Between

The Between operator expects an *AND* keyword in the values field.

This example illustrates using the Between operation

Project Name SAMPLES  
Data Set Name MSG\_CAT\_SET\_DEFN Message Catalog Set

▼ Search Criteria

Message Set Number

Case Sensitive [Basic Search](#)

**Search Results**

1-4 of 4

| Select                   | Message Set Number | Description          |
|--------------------------|--------------------|----------------------|
| <input type="checkbox"/> | 257                | Application Data Set |
| <input type="checkbox"/> | 258                | Test Manager         |
| <input type="checkbox"/> | 259                | Reserved             |
| <input type="checkbox"/> | 260                | Test Case Manager    |

## In

In interprets the , (comma) as the separator for the literals.

This example illustrates using the In criteria.

Project Name SAMPLES  
 Data Set Name MSG\_CAT\_SET\_DEFN Message Catalog Set

▼ Search Criteria

Message Set Number In 257,260,262 +

Case Sensitive Basic Search Search

**Search Results**

1-3 of 3

| Select                   | Message Set Number | Description                  |
|--------------------------|--------------------|------------------------------|
| <input type="checkbox"/> | 257                | Application Data Set         |
| <input type="checkbox"/> | 260                | Test Case Manager            |
| <input type="checkbox"/> | 262                | PeopleTools Search Framework |

### Like

Like will implicitly add % (percent sign) with the string.

This example illustrates using the Like operation.

Project Name SAMPLES  
 Data Set Name MSG\_CAT\_SET\_DEFN Message Catalog Set

▼ Search Criteria

Message Set Number All +

Description Like Integration + -

Case Sensitive Basic Search Search

**Search Results**

1-15 of 15

| Select                   | Message Set Number | Description                    |
|--------------------------|--------------------|--------------------------------|
| <input type="checkbox"/> | 129                | Merchant Integration Component |
| <input type="checkbox"/> | 155                | Integration Server             |
| <input type="checkbox"/> | 158                | Integration Broker             |
| <input type="checkbox"/> | 229                | Dashboard Integration Framewrk |
| <input type="checkbox"/> | 273                | Integration Group Manager      |

## Adding Data Set Instances from Object Designer Pages

Use the Add to Project button on the object designer pages (PIA) to add data set instances directly to an existing or a new ADS project rather than navigating to Data Migration Work Bench page.

This example illustrates the fields and controls on the Project Search page.

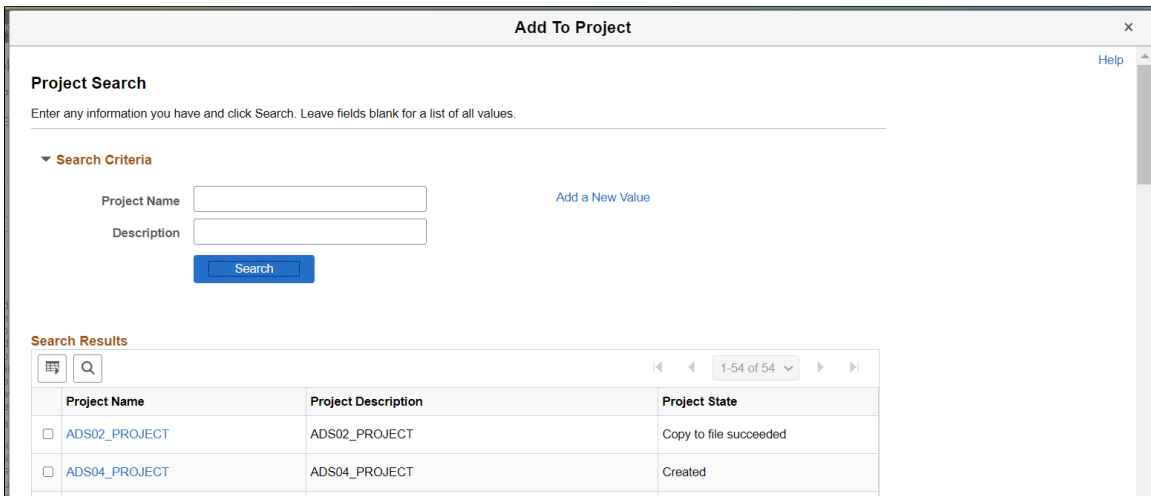

Click the Add to Project button to open the Project Search page.

Click the Add a New Value link to add the data set instance to a new project or click the Search button to open a list of matching projects to add the data set instance.

The following example illustrates insertion of data set instances and related data sets.

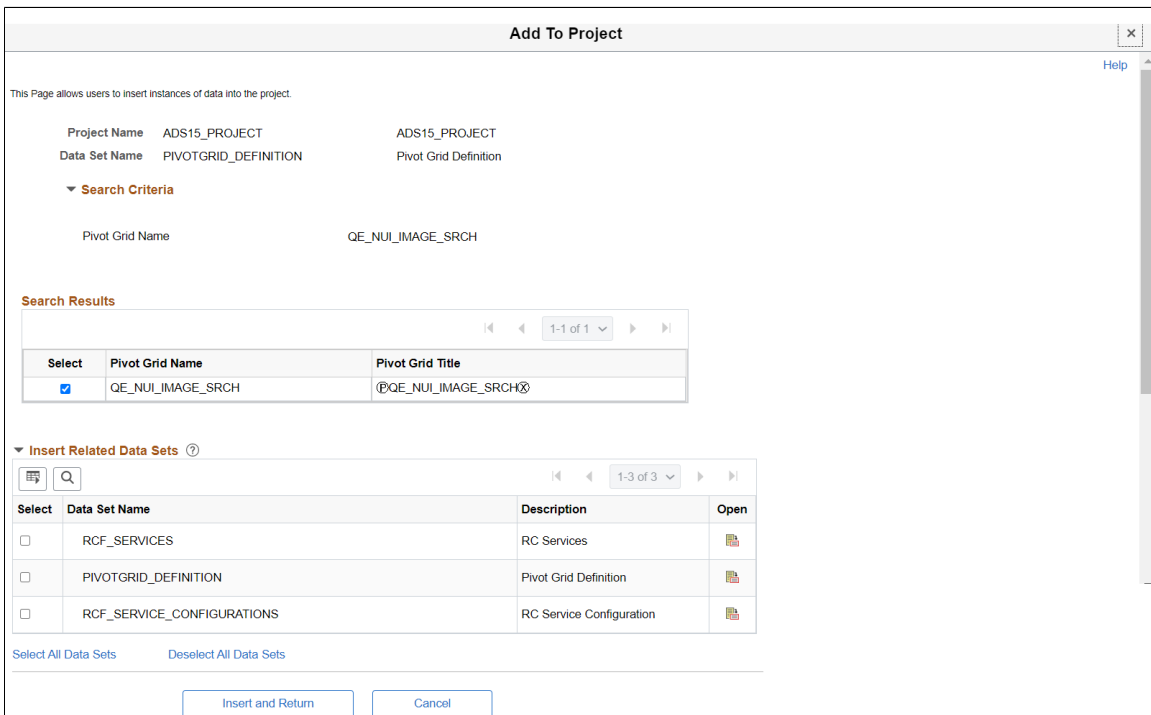

You have the option to add all related instances into the project.

When you click the Insert and Return button to add the selected data set instance, a message appears to confirm the addition of data instance into the project.

---

**Note:** After adding data set instances from Fluid pages, such as, Event Mapping page, the Add to Project window does not close automatically. Click the Close button to close the window.

---

Similar to Data Migration Work Bench page, you can filter data instances based on multiple search criteria.

While adding data instances from Fluid pages, such as OpenSearch Dashboards or Event Mapping, utilize the multiple search criteria to overcome the URL length limit of 2000 characters.

### **Related Links**

[Searching for, Adding and Deleting Projects](#)

## Chapter 11

# Copying and Comparing ADS Projects

---

## Copy Compare Overview

The Data Migration Workbench is used to copy and compare projects.

The ability to compare or copy a project is determined by the data set definition parameter *Is Copyable*. The user initiating the copy or compare must also have permission to the data contained in the ADS Project.

Data Migration Workbench provides the ability to:

- Copy an ADS project to a file.
- Compare an ADS project from file.
- Copy an ADS project from file.

### Related Links

[Setting Data Migration Permissions](#)

## Copy to File

Once the ADS project is defined it can be copied to file. The system will prompt you to select the file location from the available file locations defined on the Manage File Locations page. When the copy to file has succeeded, the Project State will be updated to *Copy to file succeeded*.

## Compare

Before you can do a compare, all data set definitions referenced in the project file must also exist in the target database. There may be cases where the a data set definition is different in the source and target. *Shape* refers to the metadata describing the data set instances in the ADS project, including the data set definition itself, the record definitions that are part of the data set definition, and the fields that are part of the records that are part of the data set definitions.

Any time there is a shape difference between the source and target data set definition, an implicit data transform is performed to align the source shape with the target shape. There are 2 categories of shape changes:

- Regular shape change

This type of shape change is supported by the Data Migration Framework and no custom transform PeopleCode is necessary. Examples of a regular shape change are:

- Add or remove a record that is included in a data set definition.

- Add or remove a non-key field from a record that is included in a data set definition.
- Irregular shape change  
This type of shape change requires custom transform PeopleCode.
  - Change the key structure of a record.
  - Change the meaning of a field value.
  - Change the field size.
  - Add a new data set definition or removing an existing data set definition.
  - Provide default values on target that do not exist in the source.
  - Change a field type or format.
  - Rename a record, field or data set definition.
  - Move data from one record to another.
  - Refactor by splitting an object into 2 or more objects.
  - Refactor by combining 2 or more objects into a single object.
  - Change in data migration pathway such as an object formerly migrated using IDE project or Data Mover is migrated using Data Migration Framework.

Compare looks for the following types of differences:

- Row Difference – Based on the record keys compares if the row exists in both the source and target databases. All differences will be captured and shown as Absent on the database where the key is not present.
- Field Difference – The value of a field differs between source and target.

For PeopleTools owned ADS definitions (managed objects), the compare will examine the LASTUPDDTTM and LASTUPDOPRID fields to detect whether the object has been changed by the customer. This is the same logic used in an IDE project compare. See [Tracked ADS Definitions](#).

## Comparing From File

When you select to compare, the system performs the following:

1. An application engine program is executed that copies each data set instance in the ADS Project from XML to memory as a PeopleSoft rowset (not to the database) and the corresponding object is copied from SQL to memory as a different PeopleSoft rowset.
2. The two in-memory rowsets are then compared record-by-record, row-by-row, and field-by-field.

In this case the file is the source and the local node is the target.

3. Any differences found in compare are stored in a table on the target database.

---

**Note:** It is stored in the same table used for managed object compare.

---

4. The differences found can be seen by running the compare viewer, which reads the compare output table.

## Using Compare Viewer

Once the compare is completed, you can use the viewer to view differences and determine which data set instances you want to include in the copy.

## Copy from File

Once you have reviewed the compare reports on the target database and selected which data set instances in the project should be copied, you can submit the ADS project for copy. If approval workflow has been configured for the Data Migration Workbench, you will receive a message that the project has entered the approval workflow. If approvals are not required for the project or when all approvals have been obtained, the copy will be scheduled to run through the Process Scheduler.

---

**Note:** If there is a shape change in Application owned datasets between the source and target environments the copy, compare, and validate process will fail.

To correct the shape changes, review and use the logs <filename.stdout> available at Process Monitor > Details > View Log/Trace

---



---

## Managing ADS Project File Locations

The project file locations are managed by a system administrator in the Project Repository to restrict the places where ADS project files can be placed. Before you can copy a ADS project to a file, you must set up the Project Repository to use. Typically, this task will be performed by a system administrator.

There are two parts to the Project Repository setup process:

1. Creating the file system folders for a specified path and the *areas* under that path. These folders should be manually created by a system administrator with appropriate access permissions for those users who will be starting the application and process scheduler servers or running Change Assistant. The system administrator should manually create both the *path* folders and the *area* folders.

---

**Note:** On non-Windows operating systems, folder names are case sensitive. At run-time *area* names are upper cased, so the names of *area* folders should also be upper cased.

---

2. Registering the path to each directory containing area folders in the database as locations for holding project files. These registered locations and the area folders within them are the Project Repository.

Use the Manage File Locations page to register paths to valid Project Repository locations.

Navigation:

**PeopleTools > Lifecycle Tools > Migrate Data > ADS Project File Locations**

This example illustrates the fields and controls on the Manage File Locations page. You can find definitions for the fields and controls later on this page.

### Manage File Locations

\*Location Name  Delete

Description

\*Path

| Area      |
|-----------|
| Area Name |
| AREA1     |
| AREA2     |

| <i>Field or Control</i> | <i>Description</i>  |
|-------------------------|---|
| Location Name           | Assign a name for your file location.   |
| Description             | Optionally add a description for the file location.   |
| Path                    | <p>The specified path must be accessible from both the application server and the process scheduler server. Absolute network paths are less prone to issues in this respect as all servers are not likely to be running on the same machine, thus may not have access to a local or relative path.</p> <p>If the application server is on Windows and the process scheduler server is on non-Windows or conversely, your system administrator will need to provide special setup to share files across machine boundaries.</p> <hr/> <p><b>Note:</b> On Windows, you must use a UNC naming convention, such as \\&lt;servername&gt;\&lt;sharename&gt;. On UNIX based platforms, you must use absolute path, such as /&lt;rootdir&gt;/&lt;subdir&gt;/.../&lt;subdir&gt;.</p> |
| Area                    | The area grid is populated with the sub directories in the path.  |

## Copying Project to File

To copy an ADS project to a file:

1. Select **PeopleTools > Lifecycle Tools > Migrate Data > Data Migration Workbench**
2. Open the project you want to copy to file.
3. Select the **Copy to File** button.

---

**Note:** If you selected to encrypt the project (see [Encrypting Data Set Project Files](#)) a message will be displayed.

---

This is an example of the encryption message

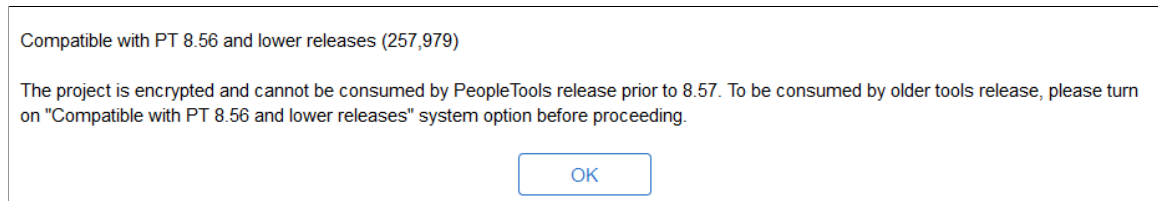

4. Select the file location and area to copy the file.
5. By default all data sets in the project are selected.
6. Click the Run button.

---

**Note:** If the file already exists, you will be prompted whether or not to replace it.

---

7. On the Process Scheduler Request page, click OK.

The copy will run in the Process Scheduler.

8. Click OK to return to the Project Definition page.

The Project State is displayed. Use the Refresh button to check the progress of the copy.

This example illustrates the fields and controls on the Copy To File page.

**Copy To File**

Run Control ID: EXAMPLE      [Report List](#)      [Process Monitor](#)      [Run](#)

**Project Information**

Project Name: EXAMPLE      Sample ADS project

Location Name: LINUX\_MOUNT      🔍

Area Name: ADS\_Projects ▼

**Data Sets**

🗨️      << < 1-3 of 3 > >> | [View All](#)

| Select                              | Data Set Name              | Description              |
|-------------------------------------|----------------------------|--------------------------|
| <input checked="" type="checkbox"/> | PIVOTGRID_DEFINITION       | Pivot Grid Definition    |
| <input checked="" type="checkbox"/> | RCF_SERVICES               | RC Services              |
| <input checked="" type="checkbox"/> | RCF_SERVICE_CONFIGURATIONS | RC Service Configuration |

---

**Note:** If dataset instances are missing from source database, copying to file will continue for the rest of the ADS objects and a warning message will be issued for the missing objects. To view the message, open the message log in the Process Monitor page.

---

---

## Loading Project from File

In order to load a project from file on the target system the data set definition must exist on the target database.

When you load a ADS project to the target database, it does not load the data content from the ADS project. Load from file causes the source project definition to be copied from the file to the target database. It does not copy the data set instances.

## Defining the Data Set Definition on the Target Database

Before the project can be loaded, copied or compared from file, the data set definitions (including records and fields) must exist on the target database. Depending on the releases and patch level of your environment, the data set definitions may have different shapes than on the source database.

See [Comparing From File](#)

If you have created your own custom data set definition and it does not exist on the target, you can copy the data set definition using an IDE project.

To migrate the data set definition and related objects using IDE project:

1. On the source database, create a new IDE project in Application Designer. **File > New > Project.**
2. Insert the data set definitions into the IDE project. **Insert > Definitions into Project > select Definition Type: Data set Definitions > select the specific data set definitions to include > click Insert.**

Insert all the records definitions that are in the data set definition and all the database field definitions that are in the record definitions.

3. Save the IDE project.
4. Copy the IDE project to a file. **Tools > Copy Project > To File > enter the export directory > click Copy.**
5. On the target database, open Application Designer and compare the IDE project from the file. **Tools > Compare and Report > From File.**

It is advisable to run a compare to check whether copying the record and field definitions are the same on the source and target.

6. On the target database, open Application Designer and copy the IDE project from the file. **Tools > Copy > From File.**

---

**Note:** You also have the option of using Copy to Database, if your environment is set up where both the source and target databases are available. If any records were changed or added in the IDE project, it will be necessary to table create or alter to assure that the records exist on the target.

---

## Loading Project on Target Database

To load the data ADS project on the target database:

1. On the target database, select **PeopleTools > Lifecycle Tools > Migrate Data > Data Migration Workbench > Load Project From File**.

This example illustrates the fields and controls on the Load Project From File.

**Load Project From File**

\*Location Name  x Q

\*Area  C

**Select a Project**

Q 1-12 of 116 | View 100

|                       | Project Name | Last Update Date/Time | File Size | Project State               |
|-----------------------|--------------|-----------------------|-----------|-----------------------------|
| <input type="radio"/> | EXAMPLE      | 09/04/19 1:11:00PM    | 627,719   |                             |
| <input type="radio"/> | DEMO1        | 09/04/19 7:27:00AM    | 361,987   | Compare from file succeeded |

2. Select the File Location and Area. A list of projects in that location will be displayed.  
See [Managing ADS Project File Locations](#)
3. Select the ADS project to load.
4. Optionally, if you want to run the load from file process asynchronously in Application Engine through Process Scheduler, select Asynchronous check box.
5. Click Load.

If the data set definition used in the ADS project does not exist on the target database, you will receive an error message and the project will not load.

---

## Comparing ADS Projects

Data Migration Workbench enables you to compare the data in the ADS project file (source) with the data in the target database (signed on database).

The compare is always executed from the target database. First you must load the ADS project file and then execute the compare.

See [Loading Project on Target Database](#)

## Tracked ADS Definitions

Starting in PeopleTools 8.57, any changes to data sets in the PSADSTRACKITEM table are tracked. When you run the compare, the compare results for tracked ADS definitions will produce results similar to the compare results in Application Designer.

---

**Note:** Tracked ADS definitions are defined in the table PSADSTRACKITEM.

---

## Comparing From File

To compare an ADS project:

1. On the target database, select **PeopleTools** > **Lifecycle Tools** > **Migrate Data** > **Data Migration Workbench**.
2. Load the ADS project.
3. Click the Compare button.
4. Select the data sets to compare.
5. Optionally, set the compare options.

See [Compare Options](#)

6. Click the Run button.
7. Set your Process Scheduler options and click OK.  
The process will be scheduled to run in the Process Scheduler.
8. Click OK again to return to the Project Definition page.
9. Click the Refresh icon on the Project Definition page to see the new status for the project.

Use the Compare button on the Project Definition page to compare a project from a file.

This example illustrates the fields and controls on the Compare From File page. You can find definitions for the fields and controls later on this page.

Perform ADS operation

---

**Compare From File**

Run Control ID: EXAMPLE2      Report List      Process Monitor      Run      Options

---

**Project Information**

|               |             |                    |
|---------------|-------------|--------------------|
| Project Name  | EXAMPLE2    | Sample ADS project |
| Location Name | ADSPROJECTS |                    |
| Area Name     | Team        |                    |

---

**Data Sets**

☰
1-3 of 3
View All

| Select                              | Data Set Name              | Description              |
|-------------------------------------|----------------------------|--------------------------|
| <input checked="" type="checkbox"/> | PIVOTGRID_DEFINITION       | Pivot Grid Definition    |
| <input checked="" type="checkbox"/> | RCF_SERVICES               | RC Services              |
| <input checked="" type="checkbox"/> | RCF_SERVICE_CONFIGURATIONS | RC Service Configuration |

[Select All Data Sets](#)      [Deselect All Data Sets](#)

| <b>Field or Control</b> | <b>Description</b>   |
|-------------------------|--|
| Data Sets               | By default all data sets in the project are selected. Use the links to select or deselect all data sets. Select each data set you want to compare. |

## Compare Complete

When the compare is complete, the project status is updated and the compare report summary statistics are displayed.

This example illustrates the fields and controls on the Compare Report Summary. You can find definitions for the fields and controls later on this page.

**Data Migration Workbench**

---

Project Name: EXAMPLE

\*Description:

Comments:

Project State: Compare from file succeeded

Progress:

► **Filters** ?

**Project Content**

☰
Q

1-3 of 3
▼
View All

| Data Set Name              | Description              | Add | Delete | Change | Same | Messages |
|----------------------------|--------------------------|-----|--------|--------|------|----------|
| PIVOTGRID_DEFINITION       | Pivot Grid Definition    | 1   | 0      | 2      | 1    | 2        |
| RCF_SERVICES               | RC Services              | 1   | 0      | 0      | 0    | 0        |
| RCF_SERVICE_CONFIGURATIONS | RC Service Configuration | 0   | 0      | 5      | 0    | 0        |

To view the compare reports see [Viewing Compare Reports](#).

## Compare Options

When you select the Options button, three tabs are displayed — Languages, Compare Options and Report Filter. These options are similar to the compare options available in Application Designer for Managed Objects.

This example illustrates the fields and controls on the Languages page. You can find definitions for the fields and controls later on this page.

### Perform ADS operation

Languages
Compare Options
Report Filter

**Include Language-Neutral Data**

#### Languages

☰
◀ ◀
1-8 of 34
▼
▶ ▶
[View All](#)

| Select                              | Language        |
|-------------------------------------|-----------------|
| <input type="checkbox"/>            | Arabic          |
| <input type="checkbox"/>            | Canadian French |
| <input type="checkbox"/>            | Czech           |
| <input type="checkbox"/>            | Danish          |
| <input type="checkbox"/>            | Dutch           |
| <input checked="" type="checkbox"/> | English         |
| <input type="checkbox"/>            | Spanish         |
| <input type="checkbox"/>            | Finnish         |

[Select All Languages](#)
[Deselect All Languages](#)

| <b>Field or Control</b>       | <b>Description</b>  |
|-------------------------------|---|
| Include Language-Neutral Data | By default this check box is selected.<br><br>Language neutral data is data that is not translated. In an IDE project copy this is referred to as COMMON. |
| Languages                     | By default all installed languages are selected. Use the links to select or deselect all languages. Select each language you want to compare.             |

**Note:** This page applies to all data sets.

This example illustrates the fields and controls on the Compare Options page. You can find definitions for the fields and controls later on this page.

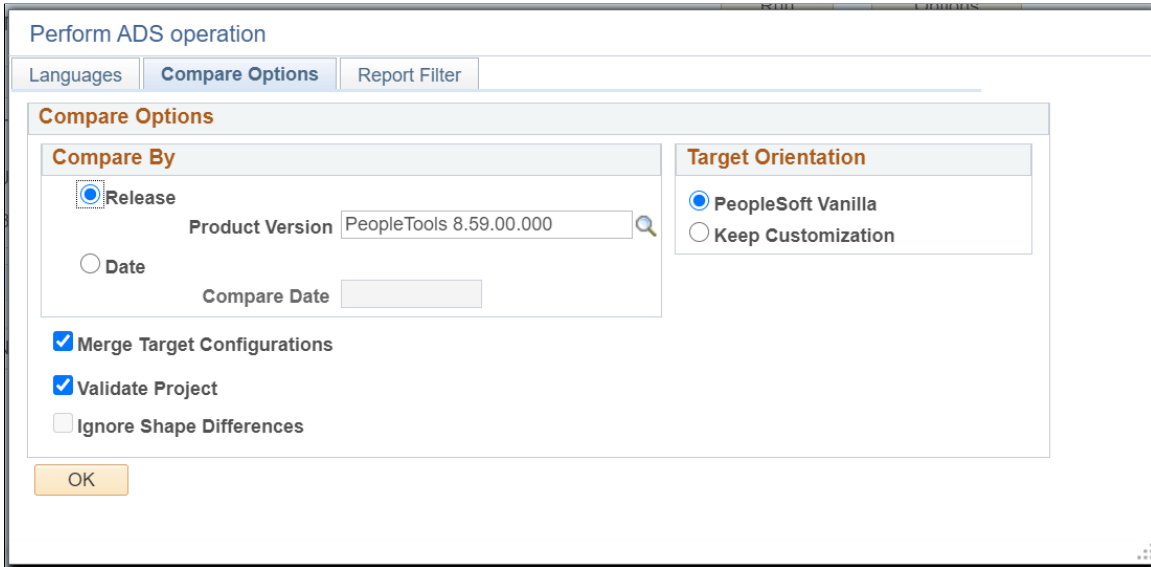

**Note:** The compare options *Compare By* and *Target Orientation* only apply to Tracked Data Sets .See [Tracked ADS Definitions](#).

| <b>Field or Control</b>     | <b>Description</b>   |
|-----------------------------|--|
| Compare By                  | <p>Select <i>Release</i> to compare by the highest release in the target. Use the search icon to select other releases in the target. The Compare process labels definitions as Changed, *Changed (custom changed), or %Changed if they have been changed since the date and time stamp for that release level. This is the default.</p> <p>Select <i>Date</i> to have the Compare process label definitions as Changed, *Changed or %Changed if they have been changed since the date that you specify.</p> <p>See <a href="#">Understanding Status</a></p> |
| Target Orientation          | <p>Determines how the Upgrade check boxes are set for comparing objects based on the user that last modified the object. To understand the impact of the target orientation, refer to <a href="#">Understanding Upgrade Action</a>.</p>  |
| Merge Target Configurations | <p>If the data set includes mergeable group, this check box is selected by default.</p> <p>If the data set does not contain mergeable groups, this box is not selected and a message is displayed that the project does not contain any mergeable data sets.</p>   |

| <b>Field or Control</b>  | <b>Description</b>  |
|--------------------------|---|
| Validate Project         | Select this check box if you want to validate the project when it is compared.<br><br>By default the check box is selected.<br><br>See <a href="#">Validating From File</a>   |
| Ignore Shape Differences | This functionality is now disabled. If there is a shape change in Application owned datasets between source and target environments, then the copy, compare, and validate processes fail.<br><br>To correct the shape changes, review and use the logs <filename.stdout> available at <b>Process Monitor</b> > <b>Details</b> > <b>View Log/Trace</b> . |

**Note:** The compare options Compare By and Target Orientation only apply to Tracked Data Sets .See [Tracked ADS Definitions](#). For all other data sets, the page is display only.

This example illustrates the fields and controls on the Report Filter page. You can find definitions for the fields and controls later on this page.

| Perform ADS operation             |                      |                             |                                     |                                     |                                     |                                     |
|-----------------------------------|----------------------|-----------------------------|-------------------------------------|-------------------------------------|-------------------------------------|-------------------------------------|
| Languages                         |                      | Compare Options             |                                     | Report Filter                       |                                     |                                     |
| <b>Report Filter</b>              |                      |                             |                                     |                                     |                                     |                                     |
|                                   |                      | Target Absent               | Target Changed                      | Target Unchanged                    | Target Custom Changed               | Tgt Custom Unchanged                |
| 1                                 | Source Absent        | <input type="checkbox"/>    | <input type="checkbox"/>            | <input type="checkbox"/>            | <input type="checkbox"/>            | <input type="checkbox"/>            |
| 2                                 | Source Changed       | <input type="checkbox"/>    | <input type="checkbox"/>            | <input type="checkbox"/>            | <input checked="" type="checkbox"/> | <input checked="" type="checkbox"/> |
| 3                                 | Source Unchanged     | <input type="checkbox"/>    | <input type="checkbox"/>            | <input type="checkbox"/>            | <input checked="" type="checkbox"/> | <input checked="" type="checkbox"/> |
| 4                                 | Src Custom Changed   | <input type="checkbox"/>    | <input checked="" type="checkbox"/> | <input checked="" type="checkbox"/> | <input checked="" type="checkbox"/> | <input checked="" type="checkbox"/> |
| 5                                 | Src Custom Unchanged | <input type="checkbox"/>    | <input checked="" type="checkbox"/> | <input checked="" type="checkbox"/> | <input checked="" type="checkbox"/> | <input checked="" type="checkbox"/> |
| <a href="#">Select All Status</a> |                      | <a href="#">Set Default</a> |                                     | <a href="#">Deselect All Status</a> |                                     |                                     |

Before performing a comparison, you can select the definition status combinations with which you generate reports by using report filter options.

The default settings for report filtering show conflicting configured definitions only.

- To reset your selections to the default setting, click the Default button.
- To select all definition status combinations, click the Select All button.
- If you don't want to generate any reports, click the Deselect All button to clear all of the check boxes

## Removing Project Compare Sessions

The ADS or MO project compare session details are stored in PSCOMPSESSION table.

Use the Project Session Administration page to search for a project and remove all or any selected compare session.

Navigation:

**PeopleTools > Lifecycle Tools > Manage ADS-MO Project Sessions**

This example illustrates the fields and controls on the Project Session Administration page.

The screenshot shows the 'Project Session Administration' page for project 'ALLOBJT128591PTM'. The project description is 'SP Data Migration Project' and it is checked as a 'Data Migration Project'. Below this is a 'Session' table with three rows. The first row, dated 01/13/2021 at 1:17:11AM, has a checked checkbox in the 'Delete' column. The other two rows have unchecked checkboxes. A 'Delete Selected' button is located at the bottom right of the table.

| Run Date/Time         | Delete                              |
|-----------------------|-------------------------------------|
| 01/13/2021 1:17:11AM  | <input checked="" type="checkbox"/> |
| 01/13/2021 12:36:36AM | <input type="checkbox"/>            |
| 01/12/2021 10:04:10PM | <input type="checkbox"/>            |

**Note:** Once the compare session is deleted, the related comparison details stored in the PSCOMPOBJDIFF table also gets deleted.

## Viewing Compare Reports

After the compare process has completed, a compare summary is displayed on the Project Definition page.

Navigation:

**PeopleTools > Lifecycle Tools > Migrate Data > Data Migration Workbench**

This example illustrates the fields and controls on the Project Summary page showing compare results. You can find definitions for the fields and controls later on this page.

**Data Migration Workbench**

---

Project Name: EXAMPLE  
 \*Description:  [Copy To File](#)  
 Comments:  [Validate](#)  
 Project State: Compare from file succeeded [Compare](#)  
 Progress:  [Submit for Copy](#)  
[Check Integrity](#)

► **Filters** ⓘ

**Project Content**

☰  1-3 of 3 | View All

| Data Set Name                              | Description              | Add               | Delete            | Change            | Same              | Messages          |
|--|--------------------------|-------------------|-------------------|-------------------|-------------------|-------------------|
| <a href="#">PIVOTGRID_DEFINITION</a>       | Pivot Grid Definition    | <a href="#">1</a> | <a href="#">0</a> | <a href="#">2</a> | <a href="#">1</a> | <a href="#">2</a> |
| <a href="#">RCF_SERVICES</a>               | RC Services              | <a href="#">1</a> | <a href="#">0</a> | <a href="#">0</a> | <a href="#">0</a> | <a href="#">0</a> |
| <a href="#">RCF_SERVICE_CONFIGURATIONS</a> | RC Service Configuration | <a href="#">0</a> | <a href="#">0</a> | <a href="#">5</a> | <a href="#">0</a> | <a href="#">0</a> |

[Save](#) [Save As...](#) [Update Project Action...](#) [Return to Search](#) [Add a New Value](#) [Process Monitor](#)

### Project Content Grid

On the target database, the Project Content grid displays all data set definitions currently in the project, but prevents changes to the project. Statistics are displayed for each data set definition in the project indicating the count of data set instances based on type. Reviewers can use the filters to further assist in determining where the changes or issues are located.

By clicking one of the hyperlinks displayed in the grid, you can drill in to view the data instances in the project for each data set. When compare or validation counts are displayed, they indicate a count of data set instances, not the number of fields compared or validated within each instance.

For large projects, use the Zoom Project Content and Search icons to find a specific data set.

Clicking on a compare or validation count will set the filter criteria on the content page appropriate to the selected count. Clicking on the data set name hyperlink will show the content page unfiltered.

| <b>Field or Control</b> | <b>Description</b>   |
|-------------------------|--|
| Data Set Name           | Each instance of the data set names is displayed as a hyperlink. When you click the hyperlink, the compare report for that data set instance is displayed. |
| Add                     | The count for additions is displayed as a hyperlink.<br><br>Add indicates the root record in the data set instance is new and the action is copy.          |

| <b>Field or Control</b> | <b>Description</b>  |
|-------------------------|---|
| Delete                  | The count for deletions is displayed as a hyperlink.<br><br>Delete indicates that all records in the data set instance are to be deleted and the copy action is delete.   |
| Change                  | The count for changes is displayed as a hyperlink.<br><br>Change indicates that either the root record has changes, or another record in the data set instance is changed, added or deleted, and the copy action is copy.   |
| Same                    | The count for same is displayed as a hyperlink.<br><br>Same indicates that the data set instance is the same on both the source and target after customizations from the target are applied. If there are customizations that differ from the source value, the action is set to None and can be viewed in the details for the data set instance. If there are no customizations to be merged, same indicates the source and target have the same values. |
| Messages                | The count for messages is displayed as a hyperlink. Only Warning and Error messages are displayed.  |

## Filters

Expand and use the filters section to limit the result set shown in the Data Set Content grid. The filter will also alter the statistics shown for each data set object in the project. All criteria specified are cumulative.

This example illustrates the fields and controls on the Filters section. You can find definitions for the fields and controls later on this page.

Filters ?

Results will be displayed where the selected filter criteria are true

**Message Type**

- Error
- Warning
- None

\*Action

\*Upgrade

\*Done

Apply

| <b>Field or Control</b> | <b>Description</b>  |
|-------------------------|---|
| Message Type            | Select which message types to display. If there are any errors or warnings the Message column will indicate the total number of messages. |
| Type                    | Select the results types to display.  |
| Action                  | Select which copy actions to display. Any will display the count for all copy actions.  |
| Upgrade                 | Upgrade status is Yes or No. Any will display the count for all statuses.   |
| Done                    | Done status is Yes or No. Any will display the count for all done statuses.   |

## Viewing Data Set Content

Use the Data Set content page to review and update the copy action for each instance of a data set.

This example illustrates the fields and controls on the Compare Report page. You can find definitions for the fields and controls later on this page.

Project Name EXAMPLE Sample ADS project State Compare from file succeeded

Data Set Name PIVOTGRID\_DEFINITION Pivot Grid Definition

---

▶ Filters ?

**PIVOTGRID\_DEFINITION**

1-4 of 4

| Pivot Grid Name          | Pivot Grid Title             | Source  | Target     | Action | Upgrade                             | Done                     | Details | Messages |
|--------------------------|------------------------------|---------|------------|--------|-------------------------------------|--------------------------|---------|----------|
| QE COPY CUST BOOK PG     | Example for Compare          | Changed | *Unchanged | Merge  | <input checked="" type="checkbox"/> | <input type="checkbox"/> |         |          |
| QE COPY SUPPLY PROD C    | QE COPY SUPPLY PROD C        | Changed | %Changed   | Merge  | <input checked="" type="checkbox"/> | <input type="checkbox"/> |         |          |
| DEMO_CHART               | Example Pivot Grid           | Changed | Absent     | Copy   | <input checked="" type="checkbox"/> | <input type="checkbox"/> |         |          |
| QE_IN_SD_SOLDTO_BOOKINGS | Customer Bookings Pivot Grid | Same    | Same       | None   | <input type="checkbox"/>            | <input type="checkbox"/> |         |          |

### Filters

The same filters available on the Project Definition page are available for the data set instances. Use the filters to limit the data set content display. All criteria specified are cumulative.

### Data Set Content

The data set content section provides the copy action and whether or not the copy has been done at the data set instance level.

| <b>Field or Control</b> | <b>Description</b>   |
|-------------------------|--|
| Source                  | <p>The source is the file that was loaded from <i>Load Project from File</i>.</p> <p>The source status is determined based on whether or not the data set is tracked, as well as the last user and date/time stamp. See <a href="#">Understanding Status</a></p> |
| Target                  | <p>Target is the database you are currently logged onto.</p> <p>The target status is determined based on whether or not the data set is tracked, as well as the last user and date/time stamp. See <a href="#">Understanding Status</a></p>                      |
| Action                  | <p>Indicates the copy action for the data set instance, the copy action will be:</p> <ul style="list-style-type: none"> <li>• Merge</li> <li>• Copy</li> </ul> <p>See <a href="#">Understanding Copy Actions</a></p>   |
| Upgrade                 | <p>Indicates whether or not to perform the selected action.</p> <p>For Tracked Data Sets, whether or not the upgrade check box is selected, depends on the orientation selected.</p> <p>See <a href="#">Understanding Upgrade Action</a></p>                     |
| Done                    | <p>When the Copy from File has completed, the Done check box will be checked.</p>  |
| Details                 | <p>Use the Details icon to view the details for the data set instance.</p> <hr/> <p><b>Note:</b> The details icon is displayed if there are differences based on the report filter selected when the Compare was run.</p> <hr/>                                  |
| Messages                | <p>Click the message icon to view any messages for the data set instance.</p> <hr/> <p><b>Note:</b> Only errors and warning are displayed.</p> <hr/>   |

## Understanding Status

This table lists the possible statuses for the source and target.

| <b>Status</b> | <b>Description</b>  |
|---------------|---|
| Same          | The ADS instance is the same in both databases. When an instance in one database has this status, its counterpart in the other database will have the equivalent status.  |
| Changed       | The ADS instance's LASTUPDOPRID value is PPLSOFT and the LASTUPDDTTM value is greater than the date/time stamp of the comparison release database. This indicates that PeopleSoft modified the instance since the comparison release.   |
| Unchanged     | The ADS instance's LASTUPDOPRID value is PPLSOFT and the LASTUPDDTTM value is less than or equal to the date/time stamp of the comparison release database. This indicates that PeopleSoft modified the instance prior to the comparison release.   |
| *Changed      | The ADS instance's LASTUPDOPRID value is not PPLSOFT and the LASTUPDDTTM value is greater than the date/time stamp of the comparison release database. This indicates that a customer modified the instance since the comparison release.   |
| *Unchanged    | The ADS instance's LASTUPDOPRID value is not PPLSOFT and the LASTUPDDTTM value is less than or equal to the date/time stamp of the comparison release database. This indicates that a customer modified the instance prior to the comparison release.   |
| Absent        | The ADS instance is found in the other database, but not in this one. When upgrading to a new PeopleSoft release, all new PeopleSoft instances should have Absent status in the target database and all of your custom instances should have Absent in the source database.   |
| %Changed      | <p>The ADS instance does not contain any tracking data. All untracked ADS definitions will have the status %Changed.</p> <p>This status will also appear for tracked ADS definitions when the source project is in an older release that does not contain any tracking data.</p> <p>See <a href="#">Tracked ADS Definitions</a></p> |

## Understanding Copy Actions

The copy actions available will depend on the data set instance.

## Merge

The merge action is only available when the data set contains one or more mergeable groups. Merge applies to the data set instance and will copy the data based on the individual group instance selections made in the detail compare report.

The default action for a merge group depends on the LASTUPDOPRID. If the LASTUPDOPRID on the target database is not PPLSOFT, the action is set to None. If the LASTUPDOPRID is PPLSOFT the action is set to Copy.

## Copy

The copy action is used to copy the data from the source database to the target database.

## Understanding Upgrade Action

Whether or not the Upgrade check box is selected, depends on the source and target status, action and orientation selected for the comparison. The orientation only applies to tracked data sets. The status of *%Changed* indicates no tracking data is available or the definition is in an older release that does not contain any tracking data.

| <b>Source Status</b> | <b>Target Status</b>   | <b>Action</b> | <b>PeopleSoft Vanilla</b> | <b>Keep Customizations</b> |
|----------------------|------------------------|---------------|---------------------------|----------------------------|
| Absent               | Changed or Unchanged   | DELETE        | True                      | True                       |
| Absent               | *Changed or *Unchanged | DELETE        | False                     | False                      |
| Changed              | Absent                 | COPY          | True                      | True                       |
| Changed              | Changed or Unchanged   | COPY          | True                      | True                       |
| Changed              | *Changed or *Unchanged | COPY          | True                      | False                      |
| Unchanged            | Absent                 | COPY          | True                      | True                       |
| Unchanged            | Changed                | COPY          | False                     | False                      |
| Unchanged            | Unchanged              | COPY          | True                      | True                       |
| Unchanged            | *Changed or *Unchanged | COPY          | True                      | False                      |
| *Changed             | Absent                 | COPY          | True                      | True                       |

| <b>Source Status</b>                                | <b>Target Status</b>                                | <b>Action</b> | <b>PeopleSoft Vanilla</b> | <b>Keep Customizations</b> |
|---|---|---------------|---------------------------|----------------------------|
| *Changed  | Changed or Unchanged                                | COPY          | False                     | True                       |
| *Changed  | *Changed or *Unchanged                              | COPY          | True                      | True                       |
| *Unchanged  | Absent  | COPY          | True                      | True                       |
| *Unchanged  | Changed or Unchanged                                | COPY          | False                     | True                       |
| *Unchanged  | *Changed  | COPY          | False                     | False                      |
| *Unchanged  | *Unchanged  | COPY          | True                      | True                       |
| %Changed  | %Changed  | COPY          | True                      | True                       |
| %Changed  | *Changed, *Unchanged, Changed, Unchanged, or Absent | COPY          | True                      | True                       |
| *Changed, *Unchanged, Changed, Unchanged, or Absent | %Changed  | COPY          | True                      | True                       |
| Absent  | %Changed  | Delete        | True                      | True                       |

## Compare Report Details

Use the CompareReports page to review the changes and update or change the Upgrade action. Click the Details icon for the data set instance.

This example illustrates the fields and controls on the Compare Report Details page. You can find definitions for the fields and controls later on this page.

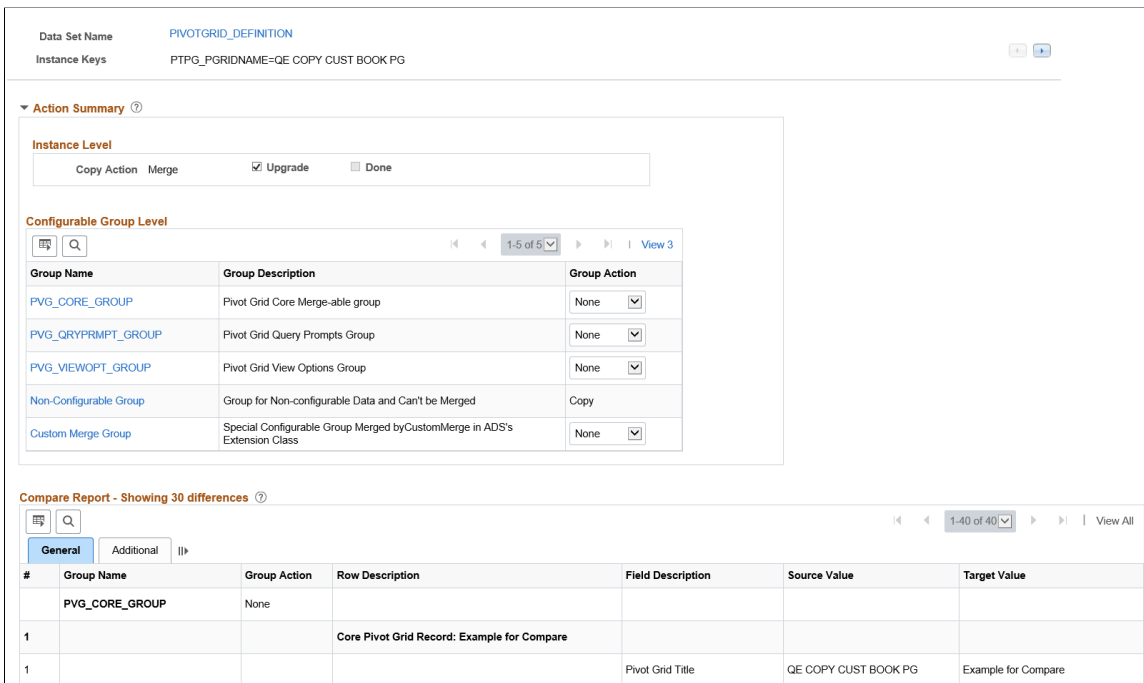

## Action Summary

Action Summary displays Instance Level and Configurable Group Level.

- Instance Level — The current data set instance is displayed with the copy action and copy status. The copy action is display only and derived from the Group Actions selected in the Configurable Group Level. You can select whether or not to perform the upgrade.
- Configurable Group Level
  - Group action in a specific configurable group can be *None* or *Copy*.
  - Group action for “Non-Configurable Group” is *Copy* and can not be changed.
  - If group actions for all configurable groups are changed to *Copy*, the instance level action status will be *Copy*.
  - “Custom Merge Group” is a special configurable group that uses CustomMerge in the ADS’s extension class. The action change for “Custom Merge Group” will impact the instance level action. Once the group action is changed from *None* to *Copy*, the instance level action will be *Copy*. All other configurable groups will also be set to *Copy*.

## Compare Report Grid

The compare report details for the data instance are displayed in the Compare Report grid. Click the Group Name in the Action Summary, Configurable Group Level to display the details for the group.

| <b>Field or Control</b> | <b>Description</b>   |
|-------------------------|--|
| #                       | The number for the record. Each field on the record will be assigned the number of the record with a decimal value for the field.  |
| Group Name              | Description of the record.   |
| Group Action            | <p>Group action will be:</p> <ul style="list-style-type: none"> <li>• None - the target data is retained.</li> <li>• Copy - Copy the data from source to target.</li> </ul> <hr/> <p><b>Note:</b> The group action can be changed in the Configurable Group Level.</p> <hr/> |
| Row Description         | Description of the row.  |
| Field Description       | Description of the field.  |
| Source Value            | Displays the value on the source. This is the value in the project file that was loaded for this data set instance.  |
| Current Target Value    | Displays the current value in the target database.   |

## Compare Report Addition page

This example illustrates the fields and controls on the Compare Report Addition page. You can find definitions for the fields and controls later on this page.

Compare Report - Showing 30 differences ?

General **Additional** ||>

| Record Name | Field Name      | Key Labels                       | Key Values                     |
|-------------|-----------------|----------------------------------|--------------------------------|
| PSPGCORE    |                 |                                  |                                |
| PSPGCORE    |                 | Pivot Grid Name                  | QE COPY CUST BOOK PG           |
| PSPGCORE    | PTPG_PGRIDTITLE | Pivot Grid Name                  | QE COPY CUST BOOK PG           |
| PSPGCORE    | DESCRLONG       | Pivot Grid Name                  | QE COPY CUST BOOK PG           |
| PSPGCORE    | LASTUPDDTTM     | Pivot Grid Name                  | QE COPY CUST BOOK PG           |
| PSPGCORE    | LASTUPDOPRID    | Pivot Grid Name                  | QE COPY CUST BOOK PG           |
| PSPGCORE    |                 |                                  |                                |
| PSPGCORE    |                 | Pivot Grid Name                  | QE COPY CUST BOOK PG           |
| PSPGCORE    | OBJECTOWNERID   | Pivot Grid Name                  | QE COPY CUST BOOK PG           |
| PSPGMODEL   |                 |                                  |                                |
| PSPGMODEL   |                 | Pivot Grid Name / Unique Heading | QE COPY CUST BOOK PG / A.NAME1 |

| <b>Field or Control</b> | <b>Description</b>        |
|-------------------------|---------------------------|
| Record Name             | Displays the record name. |
| Field Name              | Displays the field name.  |
| Key Labels              | Displays the key names.   |
| Key Value               | Displays the key value.   |

## Compare Report for Data Sets without Groups

If the data set does not contain groups, the Configurable Group level will only contain the Non-Configurable Group.

This example illustrates the fields and controls on the Compare Report details for data set without groups.

Data Set Name: PT\_SEC\_ROLECLASS  
 Instance Keys: ROLENAME=Training, CLASSID=PTPT1000

**Action Summary**

Instance Level: Copy Action Copy  Upgrade  Done

Configurable Group Level

| Group Name             | Group Description                                   | Group Action |
|------------------------|---|--------------|
| Non-Configurable Group | Group for Non-configurable Data and Can't be Merged | Copy         |

Compare Report - Showing 2 differences

| # | Group Name             | Group Action | Row Description                  | Field Description | Source Value | Target Value |
|---|------------------------|--------------|----------------------------------|-------------------|--------------|--------------|
| 1 | Non-Configurable Group | Copy         | Role Classes: Training, PTPT1000 |                   |              |              |
| 1 |                        |              |                                  | Role Name         | Training     |              |
| 1 |                        |              |                                  | Permission List   | PTPT1000     |              |

All descriptions

## Using ADS-MO Unified Compare Review

ADS-MO Unified Compare Review is used with PeopleSoft Update Manager (PUM). When an update change package contains both Managed Objects (MO) and Data Set projects (ADS), Change Assistant will create a unified compare report that contains both MO and ADS project compare results.

**Note:** The ADS-MO Unified Compare Review is only available if the target database is on PeopleTools 8.57 and above

This diagram describes the PUM process for creating the online ADS-MO Unified Compare Review report, which unifies the MO and ADS projects.

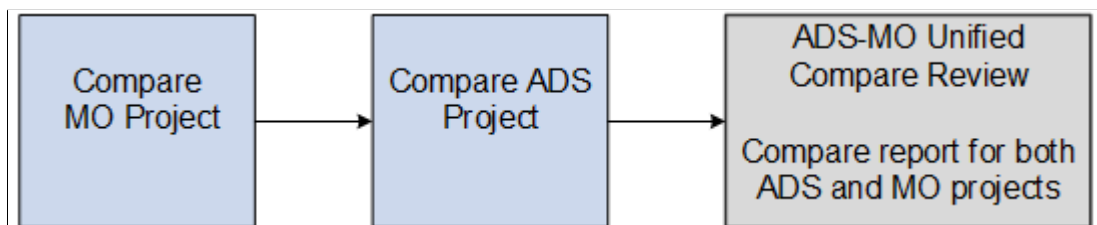

The change package will contain a step for *Defining the Managed Object Compare Review*, this step combines the compare results from *Running CP Compare Reports* and *Compare ADS MO Project From File* into a single compare review. There is a manual step *Reviewing CP Compare Reports*. To review the compare report, sign on to the browser for the target database and select PeopleTools, Lifecycle Tools, Migrate Data, ADS-MO Unified Compare Review.

## Viewing ADS-MO Unified Compare Review

On the target database, the ADS-MO Unified Compare Review grid displays all the object types in the project. Statistics are displayed for each object type in the unified project indicating the count based on object type:

- Non-comparable objects, such as Access Groups, Trees, Cube Definitions and so forth will display a summary count for Add, Delete, Change, Same and Messages as 0 since no compare report exists for these objects.
- Managed Objects, such as Activities, Records, Fields, Components and so forth will display the count for Add, Delete, Change and Same. No messages are displayed for Managed Objects.
- Data Set Definitions, such as PIVOTGRID\_DEFINITION, ACTIVITY\_GUIDE\_ITEM, RCF\_SERVICES, and so forth will display the count for Add, Delete, Change, Same and Messages.

By clicking on one of the hyperlinks displayed in the grid, you can drill in to view the object instances in the project for each object type.

Navigation:

### PeopleTools > Lifecycle Tools > Migrate Data > ADS-MO Unified Compare Review

The review name is the same as the name of the change package by default. User does have the option of providing a different report name by changing the options in step *Defining the Managed Object Compare Review* before running that step in the template.

This example illustrates the fields and controls on the Compare Review Workbench page. You can find definitions for the fields and controls later on this page.

| Compare Review Workbench                      |                               |                                    |        |        |      |                        |
|---|-------------------------------|------------------------------------|--------|--------|------|------------------------|
| Review Name COMPARE_REVIEW_TEST               |                               | Description Unified Compare Review |        |        |      |                        |
| Review Content ?                              |                               |                                    |        |        |      |                        |
|   |                               |                                    |        |        |      | 1-12 of 118   View 100 |
| Object Type                                   | Description                   | Add                                | Delete | Change | Same | Messages               |
| <a href="#">ACCESS_GROUPS</a>                 | Access Groups                 | 0                                  | 0      | 0      | 0    | 0                      |
| <a href="#">ACTIVITIES</a>                    | Activities                    | 0                                  | 0      | 1      | 0    | 0                      |
| <a href="#">ANALYTIC_MODELS</a>               | Analytic Models               | 0                                  | 0      | 1      | 0    | 0                      |
| <a href="#">ANALYTIC_TYPES</a>                | Analytic Types                | 0                                  | 0      | 0      | 0    | 0                      |
| <a href="#">APPLICATION_ENGINE_PEOPLECODE</a> | Application Engine PeopleCode | 0                                  | 1      | 1      | 0    | 0                      |

| Field or Control | Description   |
|------------------|---|
| Object Type      | Each object type is displayed as a hyperlink. When you click the hyperlink, the compare report for that object type is displayed. |
| Description      | Object description (read only)  |

| <b>Field or Control</b> | <b>Description</b>   |
|-------------------------|--|
| Add                     | <p>The count for additions is displayed as a hyperlink.</p> <p>For Managed Objects and Data Sets, <i>Add</i> indicates the objects are new and the action is copy.</p>   |
| Delete                  | <p>The count for deletions is displayed as a hyperlink.</p> <p>For Managed Objects and Data Sets, <i>Delete</i> indicates the objects are to be deleted and the copy action is delete.</p>   |
| Change                  | <p>The count for changes is displayed as a hyperlink.</p> <p>For Managed Objects and Data Sets, <i>Change</i> indicates the object contains changes and the copy action is copy.</p>   |
| Same                    | <p>The count for same is displayed as a hyperlink.</p> <ul style="list-style-type: none"> <li>• For Managed Objects, <i>Same</i> indicates the object is the same on both the source and target.</li> <li>• For Data Sets, <i>Same</i> indicates that the data set instance is the same on both the source and target after data from the merge group is merged. If there are differences in the merge group, the action is set to Keep and can be viewed in the details for the data set instance.</li> </ul> |
| Messages                | <p>Messages are produced for ADS validations. For Data Set definitions, the count for messages is displayed as a hyperlink.</p> <p>Since no validation is performed on Managed Objects, the count will always be 0 (zero) for Managed Objects.</p>   |

## Viewing the Managed Objects Content

To view the Managed Object Content, click the link for the Managed Object on the Compare Review Workbench page.

This example illustrates the fields and controls on the Example Content page for Components. You can find definitions for the fields and controls later on this page.

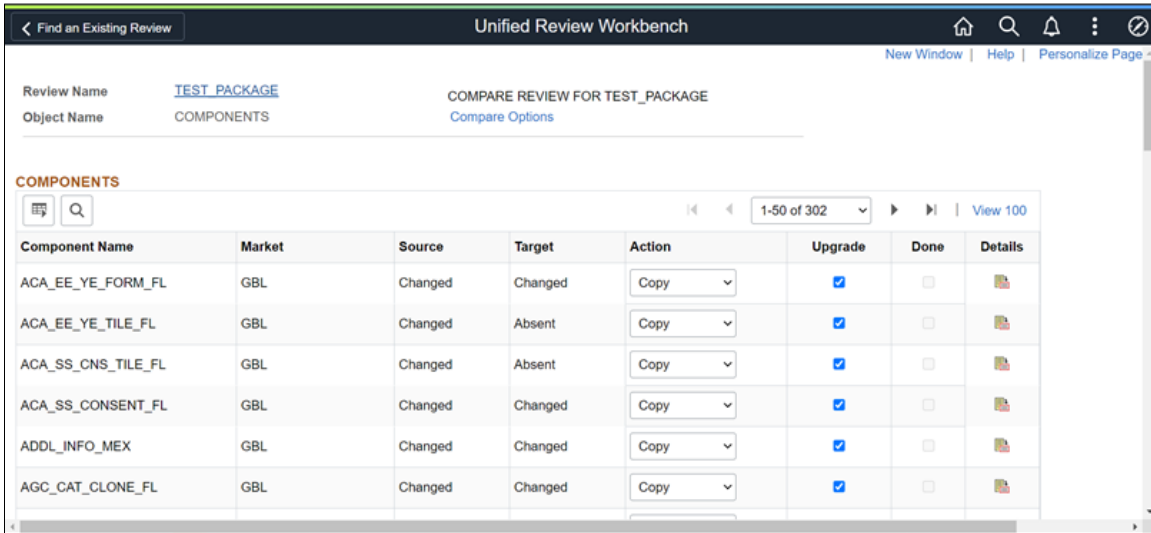

The grid is similar to the upgrade view in Application Designer. You can change the Action and Upgrade columns for each row. Use the Details link to display the details.

Click Compare Options link to view the compare options.

This example illustrates the fields and controls on the Example of Compare Options for Managed Objects.

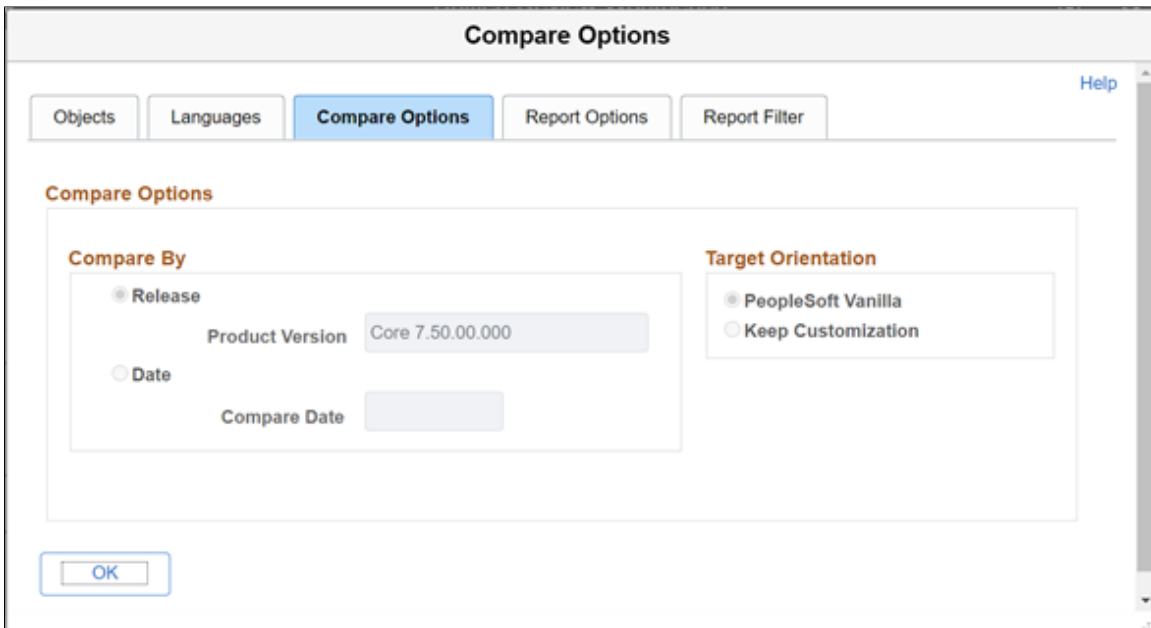

For more information on Managed Object compare reports, see [Working with Definition Status](#)

### Example Component Compare Report Details

This is an example of the details in a component compare report.

This example illustrates the fields and controls on an example Unified Compare Report. This is similar to the report in Application Designer.

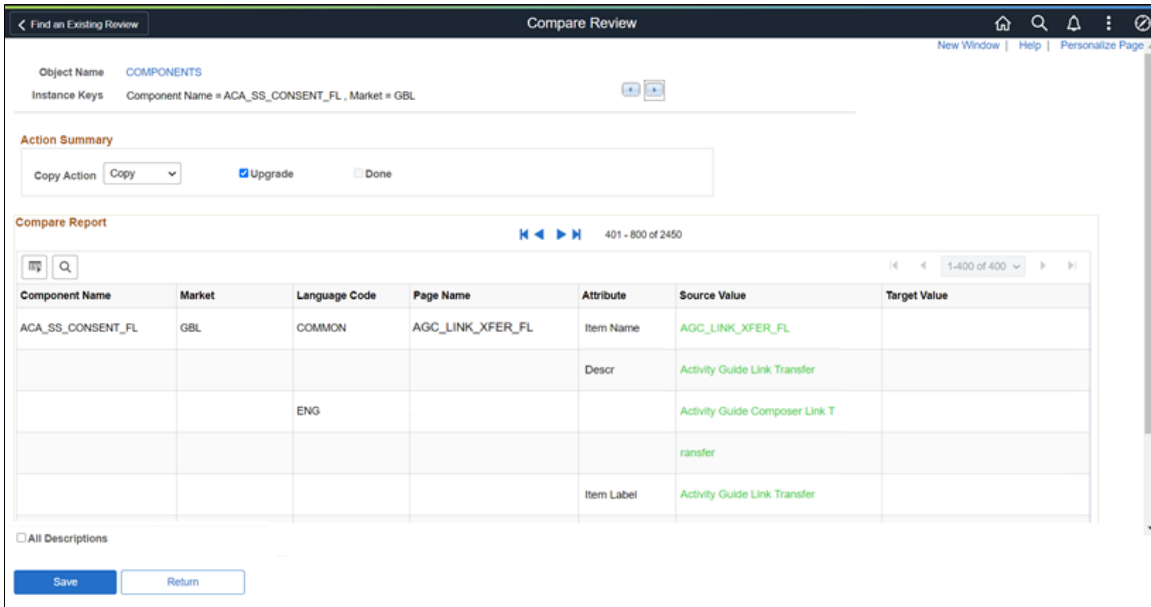

Use the First, Next, Previous and Last buttons on the page to navigate between pages in the compare report containing multiple pages.

Clear the All Descriptions check box to hide all duplicate column values. If you select the All Descriptions check box, values of all the columns are shown even if the values are same for all the rows.

### PeopleCode Object Compare Report

When you select to view the details for PeopleCode, the unified report provides additional buttons at the top of the page to assist in viewing the PeopleCode differences.

This example illustrates the fields and controls on the Unified PeopleCode Report. In this example First Difference was selected and the first difference is highlighted.

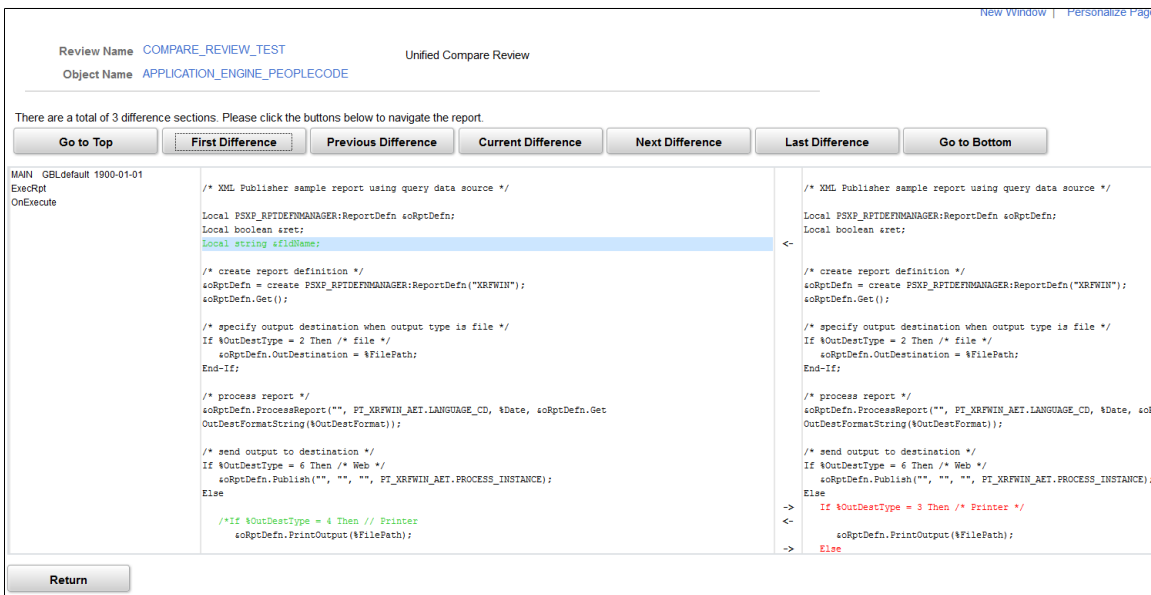

Click the buttons at the top of the page to navigate to the differences in the PeopleCode.

## Viewing Data Set Content

To view the Data Set Content, click the link for the Data Set on the Compare Review Workbench page.

This example illustrates the fields and controls on the Example Content page for PivotGrid Definition Data Set.

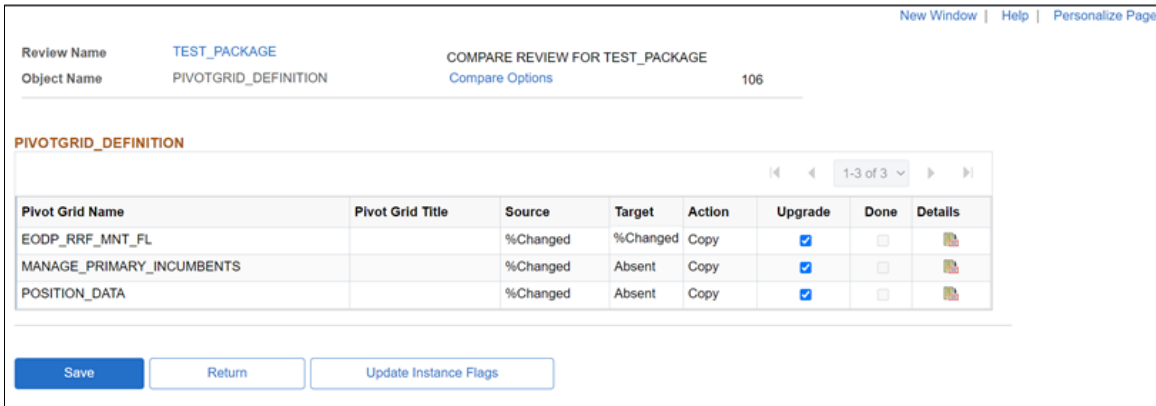

Similar to viewing the compare report in Data Migration Workbench, you can change the action and upgrade columns after reviewing the details.

Click Compare Options link to view the compare options.

This example illustrates the fields and controls on the Compare Options for ADS data set objects.

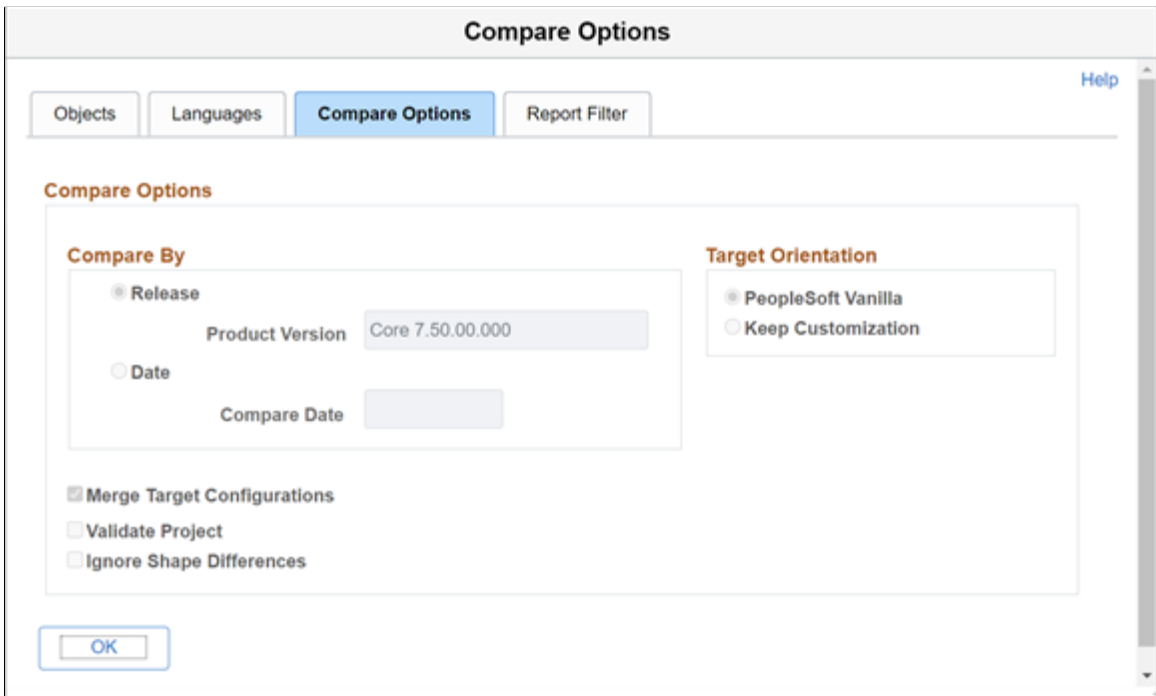

## Viewing Validation Reports

Validation is initiated by one of the following processes:

- Check Integrity

On the source database, click Check Integrity on Project Definition page.

See [Checking Integrity](#)

- Validate From File

On the target database, click Validate on Project Definition page.

See [Validating From File](#)

- Copy From file

On the target database, click Copy From File on Project Definition page and select the Validate Project check box.

When the validation process is complete, the Project Definition page is updated to indicated the message count. Depending on which process was run, you may see additional columns in the data content grid.

This example illustrates a project that contains validation errors.

**Data Migration Workbench**

---

Project Name: EXAMPLE

\*Description:

Comments:

Project State: Validation errors on validate ↻

Progress:

[Copy To File](#)

[Validate](#)

[Compare](#)

[Submit for Copy](#)

[Check Integrity](#)

**Filters** ?

**Project Content**

☰ 🔍
1-3 of 3 | View All

| Data Set Name                              | Description              | Messages |
|--|--------------------------|----------|
| <a href="#">PIVOTGRID_DEFINITION</a>       | Pivot Grid Definition    | 3        |
| <a href="#">RCF_SERVICES</a>               | RC Services              | 0        |
| <a href="#">RCF_SERVICE_CONFIGURATIONS</a> | RC Service Configuration | 0        |

| <b>Term</b> | <b>Definition</b>   |
|-------------|---|
| Filters     | Use the filters section to limit which validation message to display the count for. |

| <b>Term</b> | <b>Definition</b>  |
|-------------|--|
| Message     | Click the hyperlink for the message count to display the messages. |

Click the hyperlink in the Messages to view the data content.

This example illustrates the fields and controls on the Data content page for validation.

Project Name EXAMPLE      Sample ADS project      State Validation errors on validate

Data Set Name PIVOTGRID\_DEFINITION      Pivot Grid Definition

---

▶ **Filters** ?

**PIVOTGRID\_DEFINITION**

1-2 of 2

| Pivot Grid Name          | Pivot Grid Title             | Action | Upgrade                             | Done                     | Messages |
|--------------------------|------------------------------|--------|-------------------------------------|--------------------------|----------|
| QE COPY SUPPLY PROD C    | QE COPY SUPPLY PROD C        | Copy   | <input checked="" type="checkbox"/> | <input type="checkbox"/> |          |
| QE_IN_SD_SOLDTO_BOOKINGS | Customer Bookings Pivot Grid | Copy   | <input checked="" type="checkbox"/> | <input type="checkbox"/> |          |

The data set instances that contain errors or warnings are displayed.

| <b>Term</b> | <b>Definition</b> |
|-------------|-------------------|
|             | Warning message   |
|             | Error message     |

Click on the message icon to view the message details on the Validation Report page.

This example illustrates the fields and controls on the Validation Report page.

Project Name: EXAMPLE      Sample ADS project      State: Validation errors on validate  
 Data Set Name: PIVOTGRID\_DEFINITION      Pivot Grid Definition

Pivot Grid Title: Customer Bookings Pivot Grid  
 Instance Keys: PTPG\_PGRIDNAME=QE\_IN\_SD\_SOLDTO\_BOOKINGS  
 Datetime Validated: 11/21/2019 8:54:26.541007AM

**Project Navigator**

Comparing FILE (Source) to T58CDDMO (Target)

- ALL RECORDS - Display all records
- PSPGCORE - Core Pivot Grid Record

**Filter By**

\*Record Name: <All>  
 \*Message Severity: <All>      Apply

**Validation Report**

| Record Name | Validation Type      | Message Severity | Message Text   | Explanation  |
|-------------|----------------------|------------------|--|--|
| 1 PSPGCORE  | Translate Value Edit | Warning          | While performing a translate table validation, the provided value does not seem to be available in the translate values defined for this field. Please address this issue and perform the validations again. | VALUE: DIN specified for the FIELD: OBJECTOWNERID on the RECORD: PSPGCORE is not found in the Translate Table  |
| 2 PSPGCORE  | Custom Validation    | Error            | Field defined in the Pivot Grid not found in the Query definition. (268,809)   | Invalid Query Field Line specified in the source for the Pivot Grid QE_IN_SD_SOLDTO_BOOKINGS. All the Pivot Grid Fields need to match the Query Fields for the Pivot Grid to render. This error should be corrected before a Copy is performed on the project. |

You can also use the Filter By section to display the report based on filters for record name, message severity or any combination of those filters. Select the Show Results Without Merge check box to view the messages if merge were disabled. This option can help the reviewer to decide whether to keep configurations or copy from source.

The report has 5 columns:

| <i>Term</i>      | <i>Definition</i>                    |
|------------------|--------------------------------------|
| Record Name      | The name of the record.              |
| Validation Type  | The type of validation error.        |
| Message Severity | Indicates the severity of the error. |
| Message Text     | The message text.                    |
| Explanation      | An explanation of the message.       |

## Submitting for Copy

To copy the project from file:

1. Select **Select PeopleTools > Lifecycle Tools > Migrate Data > Data Migration Workbench.**

2. Select the *Submit for Copy* button.
3. Select the languages to copy.
4. Select the data sets to copy.
5. Select which options to run.
6. Click the Run button.
7. Click OK.

If Approval Framework has been configured, the request will enter the approval workflow, otherwise the process is scheduled in the Process Scheduler.

This example illustrates the fields and controls on the Copy From File page. You can find definitions for the fields and controls later on this page.

### Copy From File

Run Control ID EXAMPLE1
Report List
Process Monitor

Run
Options

**Project Information**

|               |              |                    |
|---------------|--------------|--------------------|
| Project Name  | EXAMPLE1     | Pivot grid example |
| Location Name | LINUX_MOUNT  |                    |
| Area Name     | ADS_Projects |                    |

**Data Sets**

☰
1-1 of 1
View All

| Select                              | Data Set Name        | Description           |
|-------------------------------------|----------------------|-----------------------|
| <input checked="" type="checkbox"/> | PIVOTGRID_DEFINITION | Pivot Grid Definition |

Select the Options button to set the copy languages and copy options.

This example illustrates the fields and controls on the Copy Options page. You can find definitions for the fields and controls later on this page.

## Perform ADS operation

Languages

Copy Options

**Copy Options**

Merge Target Configurations

Validate Project

Check Integrity After Copy

| <b>Field or Control</b>     | <b>Description</b>  |
|-----------------------------|---|
| Merge Target Configurations | Select this checkbox to indicate that the process should observe all merge actions as defined in the project. If the checkbox is de-selected, no data set instances will be merged. |
| Validate Project            | Select this checkbox to validate the project when it is copied.   |
| Check Integrity After Copy  | Select this checkbox to run an integrity check after the copy completes.  |

Refer to [Scheduling and Approving Copy from File](#) for approving the request.

# Validating Data Sets

---

## Understanding Data Set Validation

The purpose of Data Set validation (Validate/Check Integrity) is to check data validity based on rules defined on record fields (metadata), for example, whether a field value can be empty. Data can be validated from either the project file (Validate) or database (Check Integrity). The validation rules are always stored as metadata in database.

- Validation  
Data will be validated come from project file.
- Check Integrity  
Data will be validated come from database.

There are two types of validation:

- Basic Validation  
Provides the default validations.
- Custom Validation  
Extension application class (defined in the Data Set Definition) that extends the base validation class to define specific validation logic.  
See [Defining Extension](#)

### Basic Validation

Basic validation is used to check that the data set instances in a project are correct against their metadata in the database. This table lists the validations performed:

| <b>Validation Operation</b> | <b>Description</b>  |
|-----------------------------|---|
| Translate                   | For record fields defined as edit type <i>Translate Table Edit</i> , check if field value is in the translate table.      |
| Yes/No                      | For record fields defined as edit type <i>Yes/No Table Edit</i> , check if all yes/no fields contain yes or no data only. |
| Required                    | For record fields defined as <i>Required</i> , check if all Required fields contain data.                                 |

| <b>Validation Operation</b> | <b>Description</b>  |
|-----------------------------|---|
| Prompt                      | For record fields defined as edit type <i>Prompt Table Edit</i> , check if the field value is contained in the prompt table.                    |
| Reference                   | For references defined in <i>Relations</i> in the Data Set Designer, check if the references for data set instances in the project are correct. |

## When and Where to Run Validation

Validation and Check Integrity can be run in various stages in the data migration process. When they are run will determine the validation that takes place.

- Check Integrity

| <b>Stage</b>                  | <b>Database</b> | <b>UI Control</b>  | <b>Description</b>        |
|-------------------------------|-----------------|--|---------------------------|
| Before Copy to File           | Source          | Check Integrity button   | Performs all basic edits. |
| Before Compare/Copy From File | Target          | Check Integrity button   | Performs all basic edits. |
| Copy From File                | Target          | Check Integrity After Copy checkbox on the Copy From File page | Performs all basic edits. |
| After Copy From File          | Target          | Check Integrity button   | Performs all basic edits. |

- Validate

| <b>Stage</b>                  | <b>Database</b> | <b>UI Control</b>                                   | <b>Description</b>  |
|-------------------------------|-----------------|---|---|
| Before Compare/Copy From File | Target          | Validate button                                     | Performs translate, Yes/No, and Required edits, does not include prompt and reference edit. |
| Compare From File             | Target          | Validate Project checkbox on Compare From File page | Performs translate, Yes/No, and Required edits, does not include prompt and reference edit. |

| <b>Stage</b>   | <b>Database</b> | <b>UI Control</b>                                | <b>Description</b>  |
|----------------|-----------------|--|---|
| Copy From File | Target          | Validate Project checkbox on Copy From File page | Performs translate, Yes/No, and Required edits, does not include prompt and reference edit. |

---

## Checking Integrity

To run the integrity check on your project in the source database:

1. Select **PeopleTools > Lifecycle Tools > Migrate Data > Data Migration Workbench**.
2. Open the project.

The project status must be Created or Check integrity succeeded.

3. Click Check Integrity.
4. Select the data sets to check and click Run.
5. On the Process Scheduler Request page click OK.
6. Click OK to return to the Project Definition page.
7. Use the Refresh button to check the progress of the copy.
8. When the check integrity report succeeds, the message count for each data set is displayed in the project content grid.
9. To view only errors and warnings, use the Message Type filter.

This example illustrates the fields and controls on the Check Database Integrity results. The 2 in the message column indicates that integrity errors exist..

**Data Migration Workbench**

---

Project Name EXAMPLE

\*Description  Copy To File

Comments

Project State Integrity checked with errors Validate

Progress  Compare

Submit for Copy

Check Integrity

► Filters ?

**Project Content**

1-3 of 3 | View All

| Data Set Name                              | Description              | Messages |   |   |
|--|--------------------------|----------|---|---|
| <a href="#">PIVOTGRID_DEFINITION</a>       | Pivot Grid Definition    | 2        | + | - |
| <a href="#">RCF_SERVICES</a>               | RC Services              | 0        | + | - |
| <a href="#">RCF_SERVICE_CONFIGURATIONS</a> | RC Service Configuration | 0        | + | - |

For information on viewing the validation reports see [Viewing Validation Reports](#).

## Validating From File

To run the validate from file.

1. On the Target database, select **PeopleTools** > **Lifecycle Tools** > **Migrate Data** > **Data Migration Workbench**.
2. Select the project.
3. Click the Validate button.
4. Select the data sets to validate.
5. Click the Options button to select or deselect to Merge Target Configurations.

---

**Note:** The Ignore Shape Differences functionality is disabled. If there is a shape change in Application owned datasets between source and target environments, then the copy, compare, and validate processes fail.

To correct the shape changes, review and use the logs <filename.stdout> available at Process Monitor > Details > View Log/Trace.

---

6. Click the Run button.
7. On the Process Scheduler Request page, click OK.

8. Click OK to return to the Project Summary page.
9. The Project State is displayed. Use the Refresh button to check the progress of the copy.

This example illustrates the fields and controls on the Validate From File page.

**Validate From File**

Run Control ID: EXAMPLE      Report List      Process Monitor           

**Project Information**

|               |              |                    |
|---------------|--------------|--------------------|
| Project Name  | EXAMPLE      | Sample ADS project |
| Location Name | LINUX_MOUNT  |                    |
| Area Name     | ADS_Projects |                    |

**Data Sets**

| Select                              | Data Set Name              | Description              |
|-------------------------------------|----------------------------|--------------------------|
| <input checked="" type="checkbox"/> | PIVOTGRID_DEFINITION       | Pivot Grid Definition    |
| <input checked="" type="checkbox"/> | RCF_SERVICES               | RC Services              |
| <input checked="" type="checkbox"/> | RCF_SERVICE_CONFIGURATIONS | RC Service Configuration |

## Validate from File Results

When the Validate From File process completes, the project content grid is updated with the message count for each data set.

For information on viewing the validation reports see [Viewing Validation Reports](#).



# Running ADS Summary Report

---

## Running ADS Summary Report

The Data Set Summary report enables you to produce a report to view all of the information contained in the data set definition pages including general, relationships, groups, and properties. Optionally, you can also include overlapping data sets, referenced data sets, and referencing on the report. The report can also be produced in PDF format.

## Data Set Summary Report Page

Use the Data Set Summary Report page to run a report that provides a summary of the data set.

Navigation:

**PeopleTools > Lifecycle Tools > Migrate Data > ADS Summary Report**

The Data Set Summary Report can also be accessed directly from the Data Set Designer by clicking the View Summary Report link on the General page.

This example illustrates the fields and controls on the Data Set Summary Report page. You can find definitions for the fields and controls later on this page.

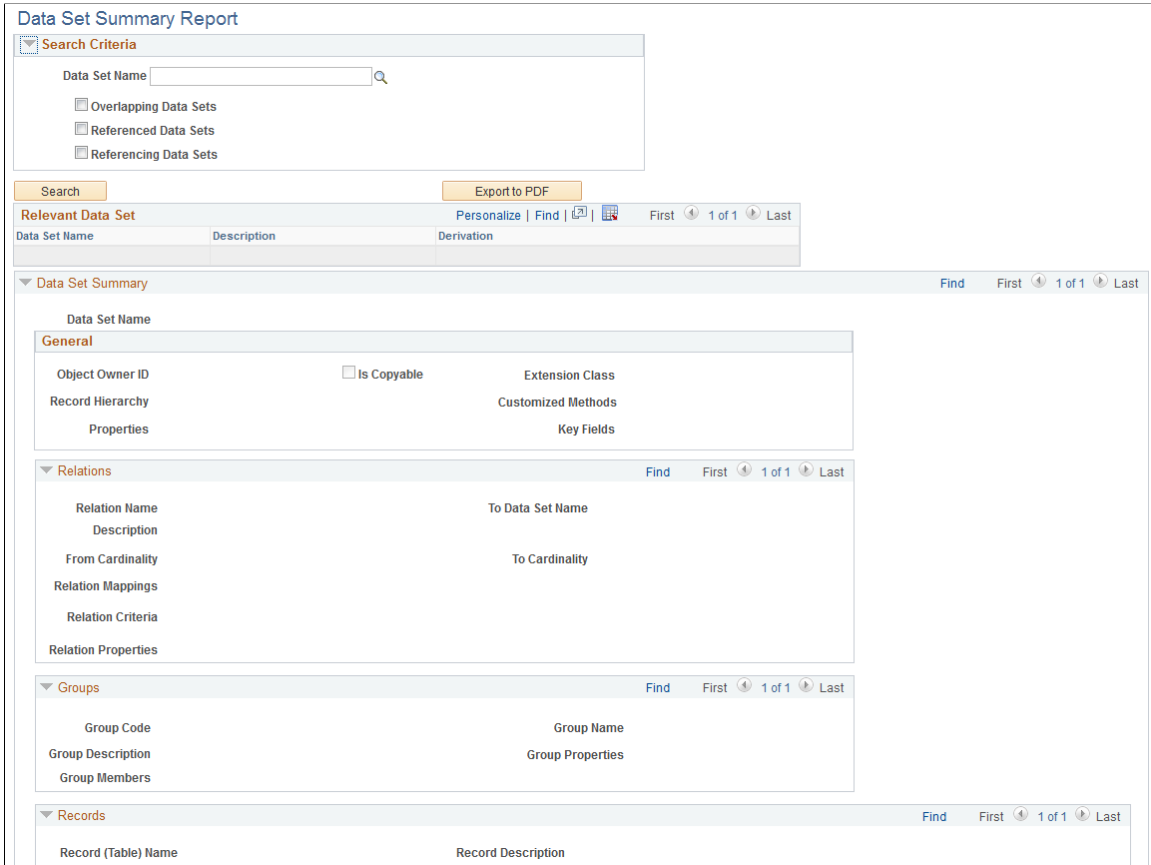

## Search Criteria

Use the Search Criteria section to select the data set or sets for the report. Click Search after entering the search criteria and the report will be displayed.

| <b>Field or Control</b>      | <b>Description</b>   |
|------------------------------|--|
| <b>Data Set Name</b>         | Select or enter the data set name.   |
| <b>Overlapping Data Sets</b> | Select to include all data sets that contain a record included in the record hierarchy of the selected data set. |
| <b>Referenced Data Sets</b>  | Select to include data sets that are defined in the relation to the selected data set.                           |
| <b>Referencing Data Sets</b> | Select to include data sets where the selected data set is defined in the relation.                              |
| <b>Export to PDF</b>         | Select this button to export the report to a PDF file.   |

## Relevant Data Set

This section will list the data sets returned from the search with the description and deviation.

This example illustrates the selecting the data set RCF\_SERVICES to include overlapping, referenced and referencing data sets.

### Data Set Summary Report

**Search Criteria**

Data Set Name

Overlapping Data Sets

Referenced Data Sets

Referencing Data Sets

| Relevant Data Set          |                              |   | Personalize   Find  |
|----------------------------|------------------------------|---|---------------------|
| Data Set Name              | Description                  | Derivation  |                     |
| RCF_SERVICES               | RC Services                  |   | First 1-8 of 8 Last |
| PIVOTGRID_DEFINITION       | Pivot Grid Definition        | Referencing   |                     |
| RCF_SERVICE_DEFINITIONS    | Related Content Service defn | Referenced  |                     |
| RCF_MENU_FOLDERS           | RC Menu Folders              | Overlapping(PSPTCSMNUFLDRLG, PSPTCS_MNUFLDRS)               |                     |
| RCF_MENU_LAYOUTS           | RC Menu Layouts              | Overlapping(PSPTCS_MENU_TBL)                                |                     |
| RCF_MENU_LINKS             | RC Menu Links                | Overlapping(PSPTCS_MNULINKS)                                |                     |
| RCF_SERVICE_CONFIGURATIONS | RC Service Configuration     | Overlapping(PSPTCSSRVCONF, PSPTCSSRVCONFLG, PSPTCS_MAPFLDS) |                     |
| RCF_SERVICE_CREFS          | RC CREF Configuration        | Overlapping(PSPTCS_SRVCFG)                                  |                     |

| <b>Field or Control</b> | <b>Description</b>  |
|-------------------------|---|
| <b>Data Set Name</b>    | Data set name.  |
| <b>Description</b>      | Data set description.   |
| <b>Deviation</b>        | <p>There are 3 values:</p> <ul style="list-style-type: none"> <li>• <i>Overlapping</i> <p>The record hierarchy of this data set has some overlapping with the one of data set selected in search criteria, only the first overlapping record is displayed in parenthesis.</p> </li> <li>• <i>Referenced</i> <p>This data set was the referenced data set of selected/input data set in search criteria</p> </li> <li>• <i>Referencing</i> <p>This data set was the referencing data set of selected/input data set in search criteria</p> </li> </ul> |

## Data Set Summary

The Data Set Summary section has 4 groups: General, Relations, Groups, and Records.

This example illustrates the fields and controls on the Data Set Summary section. You can find definitions for the fields and controls later on this page.

The screenshot displays the 'Data Set Summary' window for the 'ACTIVITY\_GUIDE\_LIST' data set. It is divided into three main sections: General, Relations, and Groups.

**General Section:** Shows the Data Set Name as 'ACTIVITY\_GUIDE\_LIST'. The Object Owner ID is 'PeopleTools' and it is marked as 'Is Copyable'. The Extension Class is 'PTAI\_ADSPKG:ItemValidationBase'. The Record Hierarchy includes '-PTAI\_LIST', 'PTAI\_CONTEXT', 'PTAI\_LIST\_LNG', 'PTAI\_LIST\_PRIV', '-PTAI\_PGLT\_BTN', 'PTAI\_PGLTBTNLANG', '-PTAI\_QUES\_LIST', and 'PTAI\_QUES\_LNG'. Customized Methods are 'CustomMerge', 'DoRowsetValidations', and 'DoTransform'. The Key Fields are 'PTAI\_LIST\_ID'.

**Relations Section:** Contains two relation entries. The first is 'ACTIVITY\_GUIDE\_LIST.ACTIVITY\_GUIDE\_DATATYPE' with a description 'Activity Guide data type', 'From Cardinality' of '1..1', and 'To Cardinality' of '1..1'. Its relation mappings are 'PTAI\_LIST.PTAI\_GPDS\_ID : PTAI\_GP\_DSTYPE.PTAI\_GPDS\_ID' and its property is 'Insert Into Project : Optional Insert'. The second is 'ACTIVITY\_GUIDE\_LIST.ACTIVITY\_GUIDE\_ITEM' with a description 'Activity Guide's Action Items', 'From Cardinality' and 'To Cardinality' both blank, and relation mappings 'PTAI\_LIST.PTAI\_LIST\_ID : PTAI\_ITEM.PTAI\_LIST\_ID'. Its property is 'Insert Into Project : Insert By Default'.

**Groups Section:** Shows a group with 'Group Code' 'PTAI\_CONTEXT\_GROUP' and 'Group Name' 'PTAI\_CONTEXT\_GROUP'. The 'Group Description' is 'PTAI\_CONTEXT group fields' and 'Group Properties' are 'Merge Configurations'. The 'Group Members' are 'PTAI\_CONTEXT.PTAI\_IMAGE\_TYPE' and 'PTAI\_CONTEXT.PTAI\_IMG\_CLASSID'.

- **General**

This section shows:

- Data Set Name
- Owner ID
- Is Copyable
- Record Hierarchy: The '-' character in front of the record name means that this record has child record(s).

- **Object Properties:** Each property displays in one line with the format of `PropertyName : PropertyValue`.
- **Extension class Name:** Full path of the application class, including the package name.
- **Customized Methods:** Displays which methods are overwritten(implemented) by the object owner. Methods include: `CustomMerge`, `CustomValidat`, `DoRowsetValidations`, `DoTransform`, `CustomTransform`, `OnPreUpdate`, or `OnPostCopy`.

- **Relations**

This section shows:

- **Relation Name**
- **To Data Set Name**
- **From Cardinality**
- **To Cardinality**
- **Relation Mapping:** Each mapping is displayed in one line with the format of `recordName.fieldName : recordName.fieldName` (the first part is from *From Data Set*, while the second part is from *To Data Set*).
- **Relation Criteria**
- **Relation Properties:** Each property is displayed in one line with the format of `PropertyName : PropertyValue`.

- **Groups**

This sections shows:

- **Group Code**
- **Group Name**
- **Group Members:** Each record field occupies one line with the format of `recordName.fieldName`. If no field name was specified, we the `recordName` is displayed.
- **Group Properties:** Each property is displayed in one line with the format of `PropertyName : PropertyValue`

- **Records**

Expand this section to view the records in the data set.

## **Related Links**

[Creating and Editing Data Set Definition](#)



# Working With ADS Administrator Reports

---

## Understanding ADS Administrator Reports

Many of the delivered ADS definitions are complex and may include relations, properties, groups, and app class extension to do custom validate, merge, and/or other transforms.. The delivered Administrator reports consist of metadata reports and security reports.

Administrative reports provide information on data sets and are grouped by category. This table lists the delivered categories:

| <i>Report Category</i> | <i>Description</i>  |
|------------------------|---|
| Properties             | Reports about data set level properties.  |
| Security               | Reports about data set level security, and privileged users, and so forth.  |
| Relations              | Reports about data set relations and relation properties.   |
| Extended               | Reports about data sets containing customized code or reports about data sets containing extended code, such as merge, validation or transform. |
| Groups                 | Reports about groups, such as mergeable groups, and so forth.   |
| Language               | Reports about language records in data sets.  |

## Security Reports

Access groups are used to determine which records the user has access to in Data Migration Workbench. For delivered data set definitions, it is necessary to add the access groups to the Data Migration page of the appropriate permission list. The ACCESS\_GRP\_RECORDS report shows the access groups associated with each data set.

Copy and Compare access rights determine the access permission for copying and comparing ADS projects.

Privileged users are users that have full access to upgrade, which allows the user to copy any record without checking the specific authorization for that record.

This table lists the delivered security reports:

| <b>Report</b>      | <b>Description</b>  |
|--------------------|---|
| ACCESS_GRP_RECORDS | Access groups for each data set.  |
| PERM_CC_ACCESS     | Copy/compare access rights defined by permission lists for each data set. |
| PRIVILEGED_USERS   | Privileged users who can bypass data set records security check.          |
| DEFN_CC_ACCESS     | Copy/compare access rights for each data set.                             |

## Metadata Reports

This table lists the delivered metadata reports by category.

| <b>Report Name</b>     | <b>Category</b> | <b>Description</b>                                    |
|------------------------|-----------------|---|
| CUST_MERGE             | Extended        | Data sets containing custom merge code                |
| CUST_VALIDATION        | Extended        | Data sets containing custom validation code           |
| SHAPE_TRANSFORM_OUTPUT | Extended        | Data sets containing custom CopyToFile transform code |
| MERGEABLE_FIELDS       | Groups          | Data sets and their mergeable records                 |
| MO_DATA_SETS           | Properties      | Data sets that are managed objects                    |
| DAT_SET_RELATIONS      | Relations       | Data sets and their related data sets                 |
| DATA_SET_RLR           | Languages       | Records with related language records in data sets    |

---

## Running ADS Administrator Reports

To run ADS Administrator Reports:

1. Select PeopleTools, Lifecycle Tools, Migrate Data, ADS Administrator Reports.
2. On the Administrator Report page click Search.

- Click the Run icon for the report you want to run.

---

**Note:** In order to run Administrator Reports, the user must have been granted the *Read Only Access* for *Copy Compare Report* permission. See [Defining Copy Compare Report Permission](#)

---

## Administrator Reports Search Page

Use the Administrator Reports Search page to search for existing administrator reports.

Navigation:

**PeopleTools > Lifecycle Tools > Migrate Data > ADS Administrator Reports**

This example illustrates the fields and controls on the Administrator Reports Search page. You can find definitions for the fields and controls later on this page.

### Administrator Reports Search

Enter any information you have and click Search. Leave fields blank for a list of all values.

---

**Search Criteria**

Report Name

Category

| Search Results <span style="float: right;">Find   <input type="text"/> First 1-11 of 11 Last</span> |     |            |  |
|---|-----|------------|--|
| Report Name   | Run | Category   | Description  |
| <input type="checkbox"/> <a href="#">ACCESS_GRP_RECORDS</a>   |     | Security   | Accessible data set records by access group setting in permission lists  |
| <input type="checkbox"/> <a href="#">CUST_MERGE</a>   |     | Extended   | Data sets containing customized merge code                               |
| <input type="checkbox"/> <a href="#">CUST_VALIDATION</a>  |     | Extended   | Data sets containing customized validation code                          |
| <input type="checkbox"/> <a href="#">DATA_SET_RELATIONS</a>   |     | Relations  | Data sets and their related data sets                                    |
| <input type="checkbox"/> <a href="#">DATA_SET_RLR</a>   |     | Languages  | Records with related language records in data sets                       |
| <input type="checkbox"/> <a href="#">DEFN_CC_ACCESS</a>   |     | Security   | Copy/compare access rights for each data set                             |
| <input type="checkbox"/> <a href="#">MERGEABLE_FIELDS</a>   |     | Groups     | Data sets and their mergeable records                                    |
| <input type="checkbox"/> <a href="#">MO_DATA_SETS</a>   |     | Properties | Data sets that are managed objects                                       |
| <input type="checkbox"/> <a href="#">PERM_CC_ACCESS</a>   |     | Security   | Copy/compare access rights defined by permission lists for each data set |
| <input type="checkbox"/> <a href="#">PRIVILEGED_USERS</a>   |     | Security   | Privileged users who can bypass data set records security check          |
| <input type="checkbox"/> <a href="#">SHAPE_TRANSFORM_OUTPUT</a>                                     |     | Extended   | Data sets containing customized CopyToFile transform code                |

Click the Run icon for the report you would like to run, or click the report name link to open the report definition page.

This example illustrates the fields and controls on the Example of Access Group report.

**Report Results**

**Report Name** ACCESS\_GRP\_RECORDS

**Description** Accessible data set records by access group setting in permission lists

**Report Results** First 1-50 of 133 Last

| Data Set Name           | Record Name    | Permission List | Query Access Tree | Access Group    | Access Code |
|-------------------------|----------------|-----------------|-------------------|-----------------|-------------|
| ACSGRPS                 | ACCESS_GRP_TBL | INFODEV         | QUERY_TREE_PT     | PT_ACCESS_GROUP | RW          |
| ACTIVITY_GUIDE_ITEM     | PTAI_ATTACH    | INFODEV         | QUERY_TREE_PT     | PT_ACCESS_GROUP | RW          |
| ACTIVITY_GUIDE_ITEM     | PTAI_HIER      | INFODEV         | QUERY_TREE_PT     | PT_ACCESS_GROUP | RW          |
| ACTIVITY_GUIDE_ITEM     | PTAI_ITEM      | INFODEV         | QUERY_TREE_PT     | PT_ACCESS_GROUP | RW          |
| ACTIVITY_GUIDE_LIST     | PTAI_CONTEXT   | INFODEV         | QUERY_TREE_PT     | PT_ACCESS_GROUP | RW          |
| ACTIVITY_GUIDE_LIST     | PTAI_LIST      | INFODEV         | QUERY_TREE_PT     | PT_ACCESS_GROUP | RW          |
| ACTIVITY_GUIDE_LIST     | PTAI_LIST_PRIV | INFODEV         | QUERY_TREE_PT     | PT_ACCESS_GROUP | RW          |
| ACTIVITY_GUIDE_LIST     | PTAI_PGLT_BTN  | INFODEV         | QUERY_TREE_PT     | PT_ACCESS_GROUP | RW          |
| CONTENT_REPOSITORY_DEFN | PSCONTDEFN     | INFODEV         | QUERY_TREE_PT     | PT_ACCESS_GROUP | RW          |
| IWC_MSG_EVENTS          | PSMSGEVENTS    | INFODEV         | QUERY_TREE_PT     | PT_ACCESS_GROUP | RW          |
| IWC_PORTAL_OBJ          | PSIWCEVENTS    | INFODEV         | QUERY_TREE_PT     | PT_ACCESS_GROUP | RW          |

## Report Definition Page

Use the Report Definition page to run an administrative report.

Navigation:

From the Administrator Reports Search page, click the report name link in the search results grid.

This example illustrates the fields and controls on the Report Definition page.

**Report Definition (VIEW ONLY)**

**Report Name** ACCESS\_GRP\_RECORDS

**Query Name** PSPTADSRTQAG\_VW

**Category** Security

**Description** Accessible data set records by access group setting in permission lists

[Return to Search](#)

Click Run to run the report.

# Implementing Data Set Security

---

## Understanding Data Set Security

The Application Data Set (ADS) framework allows users to:

1. Define the shape of business objects as data set definitions.
2. Define the contents of a data migration project.
3. Copy or compare the data migration projects to and from files.

Data sets may contain sensitive data, therefore it is critical to define security for data set functions and services. Security for data sets includes security to:

- Create data sets and ADS projects.
- Copy ADS projects to file.
- Compare ADS projects from file.
- View compare reports.
- Copy ADS projects from file.
- Encrypt data set project files.
- Modify PeopleTools owned data sets.

---

**Important!** PeopleTools owned data set are delivered as read-only and should not be modified. Any modifications necessary will be delivered in an update available from PUM.

---

This table provides a summary of the security used with ADS.

| <b>Access To</b>  | <b>Set In</b>  | <b>Details</b>  |
|---|--|---|
| ADS pages   | User profile<br><br>See <a href="#">Assigning Data Set Permissions to Users</a>  | ADS Designer role   |
| Access Group permission to the access groups that contain the records in the data sets. | Permission List - Data Migration page - Access Group Permission link.<br><br>See <a href="#">Defining Access Group Permissions</a> | The access groups are used to determine which records the user has access to in Data Migration Workbench. |

| <b>Access To</b>                | <b>Set In</b>  | <b>Details</b>   |
|---------------------------------|--|--|
| Copy Compare Report permissions | Permission List - Data Migration page - Copy Compare Report link.<br><br>See <a href="#">Defining Copy Compare Report Permission</a> | Grant access to copy and compare data migration projects.<br><br>Grant access to edit and run reports on data sets.                                    |
| Upgrade                         | Permission List - PeopleTools page - Application Designer link<br><br>See <a href="#">Setting Upgrade Permissions</a>                | Grant Full Access to Upgrade.<br><br>Full access to upgrade allows the user to copy any record without checking the specific authority to that record. |
| PeopleTools Data Access         | Permission List - PeopleTools page<br><br>See <a href="#">Setting PeopleTools Data Access</a>  | Select PeopleTools Data Access to grant access to modify PeopleTools owned data sets.  |
| File Repository                 | System Administrator creates a directory.<br><br>See <a href="#">Managing ADS Project File Locations</a>                             | The project repository location must be accessible in order to load, copy and compare data migration projects.   |

## Assigning Data Set Permissions to Users

PeopleSoft delivers the role *ADS Designer* that grants access to the ADS components. Assign this role to any user that needs access to create and use data sets.

The permission list PTPT3500 provides access to the Migrate Data pages. This permission list is included in the role ADS Designer.

| <b>Component Reference</b> | <b>Page</b>   |
|----------------------------|---|
| Data Set Designer          | PTADSDEFNSEARCH<br>PTADSDEFNSEARCH_AD<br>PTADSDEFNSEARCH_GC |
| Data Migration Workbench   | PTADSDMWSEARCH<br>PTADSDMWPRJDEFN<br>PTADSDMWCONTENT        |
| Copy Project to file       | RUN_PTADSAEPRCS   |
| Compare Project            | RUN_PTADSAEPRCS   |

| <b>Component Reference</b> | <b>Page</b>                        |
|----------------------------|------------------------------------|
| Manage File Locations      | PTPRJREPOSDEFN                     |
| Administrator Reports      | PTADSADMINRPTSrch<br>PTADSADMINRPT |
| Data Set Summary Report    | PTADSSUMRPT                        |

## Setting ADS Project File Permissions for UNIX Users

PeopleSoft provides an option to choose whether to grant read and write permissions to ADS project files to other UNIX users.

Select the **Set project files permissions to allow access to all users (UNIX)** option on the ADS Options page (PeopleTools, Lifecycle Tools, Migrate Data, ADS Options).

This example illustrates the ADS Options page with Set project file permission for UNIX users selected.

**ADS Options**

▼ **Project File Options**

Encrypt Data Set Project Files
 

- Compatible with PT 8.56 and lower releases
- Set project files permissions to allow access to all users (UNIX)

Save

Notify

By default this option is deselected.

When this option is deselected, data set project files created while Copy to File operation will have default permissions. This provides read and write permissions only to Owner and Group users, such as PeopleSoft administrators.

Select this option to provide read and write permission to data set project files for other UNIX users. The other UNIX users can be users in the development environment who do not have administrative privileges.

When you enable access to other UNIX users, it allows inter-application access between development and production environments where there are different users belonging to different groups.

---

**Note:** This feature is applicable only for UNIX systems. There is no change in permissions for data set project files on non-UNIX system.

---

## Setting Data Migration Permissions

Use the Data Migration permissions page to set the security for migrating data and running administrative reports.

Navigation:

1. **PeopleTools> Security> Permissions and Roles> Permission Lists.**
2. **Select the permission list to update.**
3. Select the Data Migration tab.

This example illustrates the fields and controls on the Data Migration Permissions page. You can find definitions for the fields and controls later on this page.

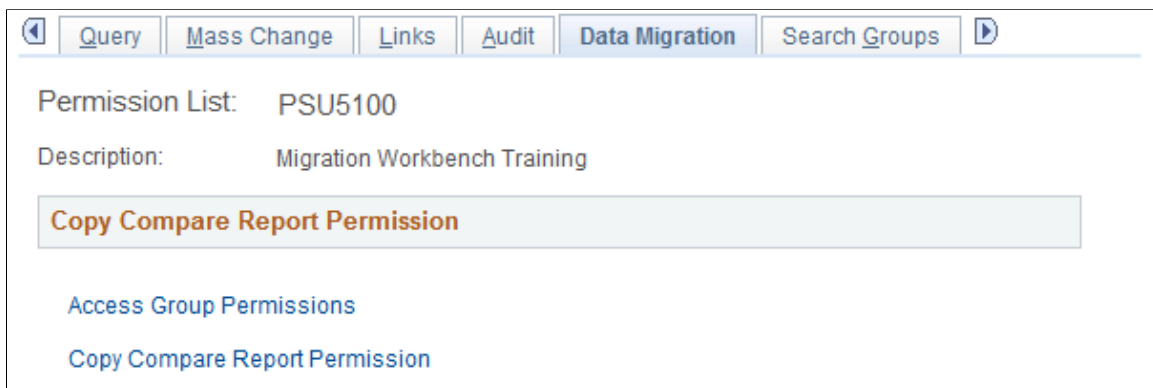

The Data Migration page has links to the Access Group Permissions page, where you can define the records to which the user can have access in the Data Migration Workbench, and the Copy Compare Report Permission page, where you can define the copy and compare operations that the user can perform, as well as permission to run administrative reports.

## Defining Access Group Permissions

Use the Permission List Access Groups page (SCRTY\_ADS\_ACC\_GRP) to define the query tree and access groups, as well as the read and write privileges.

---

**Note:** If the permission list grants full access to Upgrade, it is not necessary to include all of the access groups for a Copy from File. The access group security is always used when creating a data migration project.

---

Navigation:

**Click the Access Group Permission link on the Data Migration page.**

This example illustrates the fields and controls on the Permission List Access Groups Page. You can find definitions for the fields and controls later on this page.

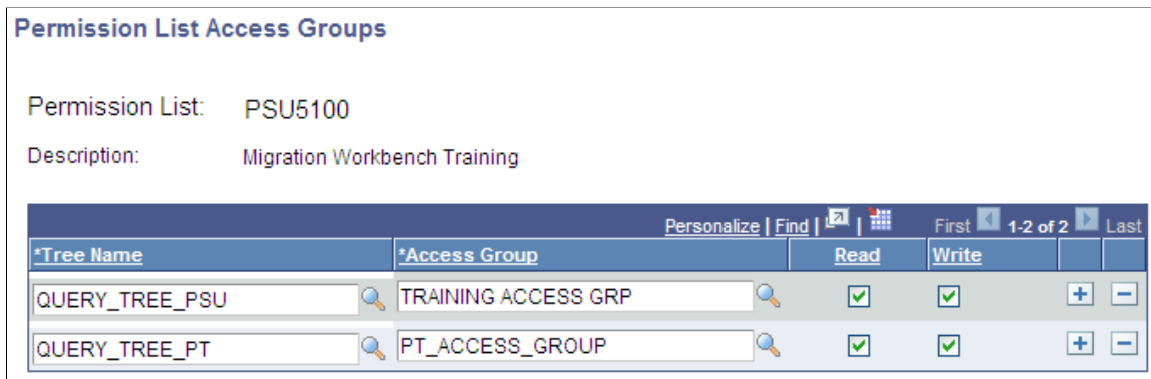

Access groups are nodes in a query tree, which you build with Query Access Manager. After you build a query tree, you give users access to one or more of its access groups. Then, they can generate queries on any tables in the access groups accessible to them.

ADS uses the query trees defined in Query Access Manager (PeopleTools, Security, Query Access Manager).

Users who have access to Data Set Designer can create data set definitions for any records in the database, however in order to copy or compare the data set, the user must have permission to an access group that contains the records to be copied or compared.

To add an access group to a permission list:

1. Open the permission list and select the **Data Migration tab > Access Group Permissions**.
2. Select a tree name.
3. Select the highest access group that the user can access.

The system displays access groups in the selected query tree only.

The access group that you select should be the highest-level tree group to which this permission list needs access.

4. Select the Read check box to grant the user access to the compare reports for this access group.

---

**Note:** Read access is enough for Copy to file and Compare operations.

---

5. Select the Write check box to grant the user access copy data for this access group from a file.

---

**Note:** Write access is required for Copy from file.

---

6. Save your changes.

## Read Write Privileges

| <b>Operation</b>  | <b>Permission Required</b> |
|-------------------|----------------------------|
| Copy to file      | Read                       |
| Copy from file    | Write                      |
| Compare from file | Read                       |

## Defining Copy Compare Report Permission

Use the Copy Compare Report Permission page (SCRTY\_ADS\_PROFILES) to define the access permission for copying and comparing ADS projects.

Navigation:

**Click the Copy Compare Report Permission link on the Data Migration page.**

This example illustrates the fields and controls on the Copy Compare Report Permission page. You can find definitions for the fields and controls later on this page.

**Copy Compare Report Permission**

---

Permission List PSU5100  
 Description Migration Workbench Training

**Copy Compare Permissions**

Assign access permissions for copying and comparing data set content

Full Access ▼

Allow setting Copy Compare attributes on data set definitions

**Report Permission**

Assign access permissions for editing and running reports on data sets

Read Only ▼

## Copy Compare Permissions

Use this section to specify the copy and compare options available.

| <b>Field or Control</b>                                       | <b>Description</b>   |
|---|--|
| Access  | <p>Select the appropriate access level. Options are:</p> <ul style="list-style-type: none"> <li>• Full Access: Enables user to copy and compare the data set.</li> <li>• No Access: User can not copy or compare the data set.</li> <li>• Read-Only: User can compare the data set.</li> </ul>   |
| Allow setting Copy Compare attributes on data set definitions | <p>The user can set the copy and compare options on the data set definition.</p> <p>This privilege should only be given to architects with a thorough knowledge of the data set definition and its associated data content who would certify data set definitions to be copyable and comparable. A flawed data set definition could corrupt a data base. A partial list of considerations for the architect includes the following items to assess:</p> <ul style="list-style-type: none"> <li>• The validation rules expressed in the application class must be accurate and complete.</li> <li>• Records in the data set should represent a tightly coupled set of data.</li> <li>• Copying the data set must preserve dependency relationships.</li> <li>• No orphan rows should be created in copy or delete.</li> <li>• Consideration should be made of validation dependencies: if a dependent object is being copied from the source, it must be copied before the objects that depends on it.</li> </ul> |

| <b>Copy Compare Access</b> | <b>Copy to File</b> | <b>Copy from File</b> | <b>Compare from File</b> |
|----------------------------|---------------------|-----------------------|--------------------------|
| No Access                  | No                  | No                    | No                       |
| Read-Only Access           | Yes                 | No                    | Yes                      |
| Full Access                | Yes                 | Yes                   | Yes                      |

### Report Permission

Use this section to specify permission to run administrative reports.

See [Running ADS Administrator Reports](#)

| <b><i>Field or Control</i></b> | <b><i>Description</i></b>  |
|--------------------------------|--|
| Access                         | <p>Select the appropriate access level. Options are:</p> <ul style="list-style-type: none"> <li>• No Access: User can not view or run administrative reports.</li> <li>• Read-Only: Enables users to run and view administrative reports.</li> </ul> |

## Setting Upgrade Permissions

In order to copy from file, the user must have all of the appropriate permissions to the records in the file. To simplify this process, you can create a permission list that includes Full Access to Upgrade.

Full access to upgrade allows the user to copy any record without checking the specific authority to that record. Once you create a permission list with this access and assign it to a role, you should limit the number of users who are granted the role.

To assign Full Access to Upgrade:

1. Select **PeopleTools > Security > Permissions and Roles > Permission Lists**.
2. Select the PeopleTools tab.
3. Select the Application Designer check box.
4. Select the Tools Permission link.
5. Select Full Access for Upgrade.
6. Click OK and the save the page.

This example illustrates the fields and controls on the Tools Permission page.

**Tools Permission**

Permission List: UPGRADE

Description: Upgrade

1-9 of 9

◀ ▶

| Tool                        | Access Code                        |
|-----------------------------|------------------------------------|
| Change Control              | Supervisor ac <input type="text"/> |
| Build / Data Admin.         | Full data adm <input type="text"/> |
| Language Translations       | Full access <input type="text"/>   |
| Merge                       | Full access <input type="text"/>   |
| Peoplecode Debugger         | Full access <input type="text"/>   |
| PeopleCode Work-In-Progress | Full access <input type="text"/>   |
| SQL Editor                  | Full access <input type="text"/>   |
| Upgrade                     | Full access <input type="text"/>   |
| Visual Merge Page           | Full access <input type="text"/>   |

Full Access (All)

Read Only (All)

No Access (All)

**Related Links**

“Defining Permissions” (Security Administration)

**Setting PeopleTools Data Access**

In order to modify a PeopleTools owned data set definition, the developer must have:

- Full access to copy and compare for data migration.  
See [Defining Copy Compare Report Permission](#)
- Permission list access to the tools tables.  
See [Defining Access Group Permissions](#)
- PeopleTools Data Set access

To set PeopleTools Data Set access:

1. Select **PeopleTools > Security > Permissions and Roles > Permission Lists**.
2. Select the PeopleTools tab.
3. Select the PeopleTools Data Set Access check box.
4. Save the page.

This example illustrates the fields and controls on the Permission List – Tools page.

General
Pages
PeopleTools
Process
Sign-on Times
>

**Permission List**    UPGRADE

**Description**    Upgrade

**PeopleTools Permissions**

- Application Designer Access**
- Data Mover Access**
- Definition Security Access**
- Query Access**
- Performance Monitor PPMI Access**
- PeopleTools Data Set Access**

**Realtime Event Notification**

[Realtime Event Notification Permissions](#)

**Data Archival**

**Generate SQL**  
 **Run SQL**

**Edit SQL**  
 **Purge Audit**

## Encrypting Data Set Project Files

Data set project files are stored in project file repositories and should be encrypted for added security. By default, the option to encrypt data set project files is selected.

Prior to PeopleTools 8.57 ADS used 3DES encryption/decryption algorithm for ADS projects. PeopleTools 8.57 uses a new encryption algorithm provided by PeopleTools. ADS projects can be used across PeopleTools releases, therefore it may be necessary to use the older encryption method for compatibility.

**Note:** ADS projects delivered through PUM are PeopleSoft delivered projects which are public and therefore not encrypted. Encryption only applies to user created ADS projects.

To handle ADS project encryption, access the ADS Options page (PeopleTools, Lifecycle Tools, Migrate Data, ADS Options).

This example illustrates the ADS Options page with Encrypt Data Set Project Files selected.

The screenshot shows the 'ADS Options' page. Under the 'Project File Options' section, there are three checkboxes:
 

- Encrypt Data Set Project Files
- Compatible with PT 8.56 and lower releases
- Set project files permissions to allow access to all users (UNIX)

 At the bottom of the form, there are two buttons: 'Save' and 'Notify'.

**Important!** If you are migrating a data set project from PeopleTools 8.54 to PeopleTools 8.53 the encryption must be turned off.

| <b>Field or Control</b>                    | <b>Description</b>   |
|--|--|
| Encrypt Data Set Project Files             | Select this checkbox to encrypt ADS projects using PeopleTools 8.57 encryption algorithm.  |
| Compatible with PT 8.56 and lower releases | Select this checkbox if you will be creating ADS projects that will span PeopleTools releases. If selected the 3DES algorithm is used for encryption/decryption. |

**Note:** At copy to file time, if the encryption flag is enabled but *Compatible with PT 8.56 and lower releases* flag is disabled, a message is displayed to warn the user that the generated ADS project cannot be consumed by tools release prior to 8.57.

---

## Setting Up Approval Framework for Data Migration

Approval Framework is included in PeopleSoft applications as part of Enterprise Components. A set of approvals is included for ADS projects. If activated and configured, this approval process is triggered when the user clicks the Submit for Copy button.

The ProcessID *MigrateData* contains all of the information necessary to route approvals to the appropriate approvers and take the necessary action when a transaction is approved, denied, or pushed back.

To configure and activate the Approval Framework process for MigrateData:

1. Assign the appropriate role in the user profile for the approvers.
2. Define workflow for user profile.
3. Create and maintain user list definition.
4. Set up the Approval Process for Data Migration.

### Assigning Data Migration Roles

Two roles are delivered for Data Migration approvals:

- EOMW\_REVIEWER
- EOMW\_APPROVER

You can use these roles or create new roles as needed for your approvers.

To assign data migration roles to a user profile:

1. Select **PeopleTools > Security > User Profiles > User Profiles > Roles**.
2. Insert the role or roles.
3. Save the page.

### Related Links

“Defining Role Options” (Security Administration)

### Defining Workflow for User Profile

In order to receive approval notifications, the user must have the worklist option selected in the user profile.

To set up a workflow user:

1. Select **PeopleTools > Security > User Profiles > User Profiles**
2. Select the user profile, or create a new one.
3. Access the Workflow page.

4. Select the Worklist check box.

## Related Links

“Specifying Workflow Settings” (Security Administration)

## Creating and Maintaining User List Definition

A *user list* is a collection of users (PeopleSoft User IDs) expressed as the result of a SQL statement, PeopleSoft role, or PeopleSoft Application Class. User lists are used to represent the business process of your approval hierarchy on a transaction-by-transaction basis. PeopleSoft delivers pre-defined user lists. If none of the delivered user lists apply to your organization's hierarchy, then you can define your own using the User List Setup component (Enterprise Components, Approvals, Approvals, User List Setup).

There are two delivered User Lists for Data Migration, however you can use any of the user lists that apply for your applications.

| <b>User List</b>     | <b>Description</b>   |
|----------------------|--|
| MigrateData_Reviewer | Based on the role EOMW_REVIEWER. The transaction will be routed to any user that has the role EOMW_REVIEWER defined in the user profile. |
| MigrateData_Approver | Based on the role EOMW_APPROVER. The transaction will be routed to any user that has the role EOMW_APPROVER defined in the user profile. |

For more information on setting up user lists see *Approval Framework*, Defining Notification Templates and Users for Approval Framework.

## Setting up the Approval Process for Data Migration

To set up approval process definitions, use the Setup Process Definitions component.

Business analysts use this component to define an approval process definition. The process is made up of stages and their paths and steps. The approval steps that you place on the approval path represent the approval levels that are required for a transaction.

| <b>Approval Flow</b> | <b>Description</b>   |
|----------------------|--|
| Stage                | A stage is one part of an approval process that can contain multiple paths. The system executes stages in sequence where one must complete the stage before the next one begins. A stage can be at the header or line level. For Data Migration only the header level is used. |
| Path                 | A path contains a sequence of steps. Within a stage, paths execute in parallel. Path entry criteria determines whether or not a path executes for a given transaction.   |

| <b>Approval Flow</b> | <b>Description</b>   |
|----------------------|--|
| Step                 | A step represents one or more approvers or reviewers. Steps within a path execute in sequence. Separate criteria for each step determines whether or not that step executes. Each step can also have a set of reviewers. |

Typical approval processes for Data Migration might include:

- Supervisor or Manager to review data that will be copied to the database.
- Manager to approve the data migration before it is copied to the database.
- Two different approvers for each step, where both approvers at a step must approve the request for it to advance to the next step.

### Example Approval Process Definition

This section provides an example of how to set up an approval process definition for a transaction that is specific to `MigrateData`.

To set up the approval process definition:

1. Select **Enterprise Components > Approvals > Approvals > Setup Process Definitions**.
2. Select ProcessID *MigrateData*.

This example illustrates the fields and controls on the Set Up Process Definition page. You can find definitions for the fields and controls later on this page.

**Setup Process Definitions**

Clone Approval Process | Approval Process Viewer | Preview Approval Process

Process ID MigrateData  
 Definition ID Default  
 Effective Date 01/01/1900  
 Description

**Definition Options**

Definition Criteria | Alert Criteria | Definition Notifications | Timeout Options

\*Admin Role SYSTEM ADMINISTRATOR  Default Process Definition  
 \*Error Action Route to next step on error  User Auto Approval  
 \*Status Active  Route to Requester  
 Priority 1  Include Requester

**Stages**

| *Stage Number | Description         | Level  |
|---------------|---------------------|--------|
| 10            | Supervisor Approval | Header |

**Paths**

| Description | *Source |
|-------------|---------|
| Supervisor  | Dynamic |

**Steps**

| Description           | Approver User List   | Details | Criteria |
|-----------------------|----------------------|---------|----------|
| 1 Supervisor Approval | Supervisor by UserID |         |          |

In the Definition Options section, the process definition needs to be set to Active.

In this example the approval process contains two stages – Supervisor and Copy Scheduler. Each stage has one path and one step. The first stage requires supervisor approval before the ADS project can be routed to the Copy Scheduler. When the copy scheduler approves the request (final approval), the ADS project will be scheduled for copy in the Process Scheduler.

You can define multiple stages, paths, and steps for an approval process definition. For example, perhaps you require administrator approval for the copy request. In this case, you would create an additional path within the existing stage that contains one step requiring administrator approval.

The Approval Framework processes multiple stages and steps sequentially. The engine cannot advance to the next step until you complete the preceding step in the given path. Likewise, the engine cannot advance to the next stage until you complete all paths within a given stage. For paths, however, you can define them as static (processed sequential) or dynamic (processed in parallel).

## Criteria

By default, the criteria will be Always True, which means if the process definition for MigrateData is active, Approval Framework will always be invoked.

You can add logic that the Approval Framework evaluates at runtime for a Boolean result. You can define criteria at the definition, path, or step level. To set up criteria, click the Definition Criteria link at the top

of the Setup Process Definitions page for the definition, for path and step criteria, click the associated criteria icon for that path or step.

This example illustrates the fields and controls on the Criteria Definition page.

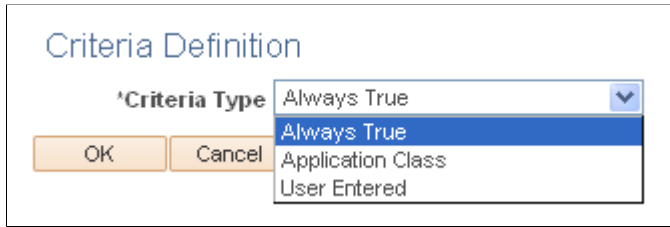

Refer to the *Approval Framework PeopleBook*, Setting Up Approval Framework Process Definitions, Defining Criteria for Approval Framework Processes for details on how to define the criteria.

## Scheduling and Approving Copy from File

This section discusses how to schedule and approve copy from file.

### Submitting for Copy using Approval Framework

When the MigrateData approval process is active, all approvals must be completed before the Copy from file will be scheduled in the Process Scheduler.

To request the copy from file:

1. In the Process Definition component (PeopleTools, Lifecycle Tools, Migrate Data, Data Migration Workbench) select the Submit for Copy button.
2. Select the languages to copy.
3. Click Run.

You will receive a message that the project has been submitted for approval and the status will be updated to Evaluating Approval.

4. Click OK to return to the Project Definition page.
5. To view the approvals required, click the Work Approvals link.

This example illustrates the fields and controls on the ADS Approval View. You can find definitions for the fields and controls later on this page.

The screenshot shows the ADS Approval View interface. At the top, there is a dropdown menu labeled "ADS Approval View". Below it, the "Supervisor Approval" section is displayed. It features a dropdown menu with the text "PROJECTNAME=MSG\_257,:Pending". Underneath, the "Supervisor" section shows a "Pending" status with a clock icon and the text "Director 2" and "Supervisor by UserId". Below this, the "Copy Scheduler" section is shown. It has a dropdown menu with the text "PROJECTNAME=MSG\_257,:Awaiting Further Approvals". Underneath, the "Copy Scheduler" section shows a "Not Routed" status with a folder icon and the text "Multiple Approvers" and "Migrate Data Scheduler".

This example shows the two paths. First the Supervisor must approve the project and then the copy scheduler. Note in this example that for Copy Scheduler there are multiple approvers. If you want to see who the approvers are, click on Multiple Approvers for a list of possible approvers. Only one approval is needed, so once one of the copy scheduler approvers approves the copy, the transaction will be deleted from the other copy scheduler approvers worklist.

## Approving a Copy Request

The approval request is added to the approvers worklist. To approve a request:

1. Sign on as the approver.
2. Select Worklist from the menu bar or select Worklist, My Worklist - Summary View.
3. In the Link column, click the link.
4. The Data Migration Approval page is displayed.

This example illustrates the fields and controls on the Data Migration Approval page. You can find definitions for the fields and controls later on this page.

The screenshot shows the Data Migration Approval page. At the top, there is a title "Data Migration Approval". Below it, the "Project Name" is "DEM02" and "demo2". There is a link "View Compare Report". The "Project State" is "Evaluating Approval". The "Schedule Date/Time" field has a calendar icon and a "BT" button. The "Time" field has a clock icon. There is a checkbox labeled "Schedule Immediately" which is checked. Below these fields is a large text area for "Approval Comment". At the bottom, there are five buttons: "Approve", "Deny", "Pushback", "Request Information", and "Save Comment". At the very bottom, there is a dropdown menu labeled "ADS Approval View".

| <b>Field or Control</b> | <b>Description</b>  |
|-------------------------|---|
| Approve                 | Click to approve the transaction.   |
| Deny                    | Enter a comment in the Approval Comment edit box and click to deny the transaction.   |
| Pushback                | <p>Click to push back the transaction.</p> <p>Pushback is an optional feature that can be implemented in the Approval Monitor. If implemented, push back takes a currently pending step out of pending status and requeues the previous step to its approvers. The meaning of push back is that the approver is questioning the prior step's approval and is requesting clarification. Push back is only possible within a path, therefore, the first step of a path cannot push back.</p>  |
| Request Information     | Click this button to request additional information from the originator. The approval will be placed on hold.   |
| Save Comment            | <p>Enter a comment in the Approval Comment edit box and select Save Comment.</p> <p>Requesters can add comments to transactions, and approvers can associate their comments with the approval process rather than the request transaction directly. The Approval Framework Monitor provides a mechanism for associating comments with a particular approval process instance, which is tied to a particular application transaction. Approvers can view comments added by another approver, but they cannot change previous comments.</p> |

Expand the ADS Approval View to view the current progress of the request.

This example illustrates the fields and controls on the ADS Approval View.

The screenshot displays the 'ADS Approval View' interface. It is divided into two main sections: 'Supervisor Approval' and 'Copy Scheduler'. Each section shows a project name, its status, and a list of approvers with their roles and timestamps. A 'Comment History' section is also visible at the bottom of each approval card.

**ADS Approval View**

### Supervisor Approval

PROJECTNAME=DEM02.:Approved [View/Hide Comments](#)

Supervisor

| Approved |                      |
|----------|----------------------|
| ✓        | Director 2           |
|          | Supervisor by UserId |
|          | 10/02/12 - 11:42 AM  |

▶ **Comment History**

### Copy Scheduler

PROJECTNAME=DEM02.:Pending [View/Hide Comments](#)

Copy Scheduler

| Pending |                        |
|---------|------------------------|
| 🕒       | Multiple Approvers     |
|         | Migrate Data Scheduler |

▶ **Comment History**



# Running PeopleTools Configuration Reports

---

## Understanding PeopleTools Configuration Reports

Drop zones, event mapping, Application Engine plug-ins, and configurable search allow users to configure the delivered pages, components, Application Engine programs, and search pages without customizing those.

For example, you can use drop zone to add fields to the delivered pages, use event mapping to add PeopleCode program to the delivered components, and so on.

You can generate SQR reports to capture details on configurations done using drop zones, event mapping, Application Engine plug-ins, and configurable search. You can refer to the configuration details during lifecycle management.

This table describes the SQR programs run in Process Scheduler to generate the SQR reports:

| <b>SQR Program</b> | <b>Description</b>  |
|--------------------|---|
| XRFPGDZ            | Lists all pages and their related drop zone subpages.   |
| XRFAEPL            | Lists all delivered Application Engine programs, which have been configured with Application Engine plug-in program that contains the new SQL or PeopleCode action, which will be used to configure the delivered Application Engine program and various other values such as, section, step, action, and mode. |
| XRFEVPC            | Lists all components, pages, records and fields that are mapped to application package PeopleCode program and event type.   |
| XRFCSCR            | Lists all configurable search customizations such as components, search records, and search definitions.  |

The SQR reports can be produced in CSV, HP, HTM, LP, PDF, PS, or SPF formats.

### Related Links

“Understanding Cross-Reference Reports” (Application Designer Developer’s Guide)

## Generating SQR Reports

This section discusses how to generate SQR reports on configurations done using drop zones, event mapping, Application Engine plug-ins, and configurable search.

You can generate the reports from Process Scheduler or Isolated Customization Reports page.

### Generating SQR Reports from Process Scheduler

This section discusses how to generate SQR reports on configurations done using drop zones, event mapping, Application Engine plug-ins, and configurable search using Process Scheduler.

To generate a report:

1. Select PeopleTools, Process Scheduler, Schedule Process Request.
2. The Sample Processes page appears,
3. Click Add a new Value and enter a run control ID.
4. On the Schedule Process Request page, click Run.

The Process Scheduler Request page appears.

This example illustrates the fields and controls on the Process Scheduler Request page.

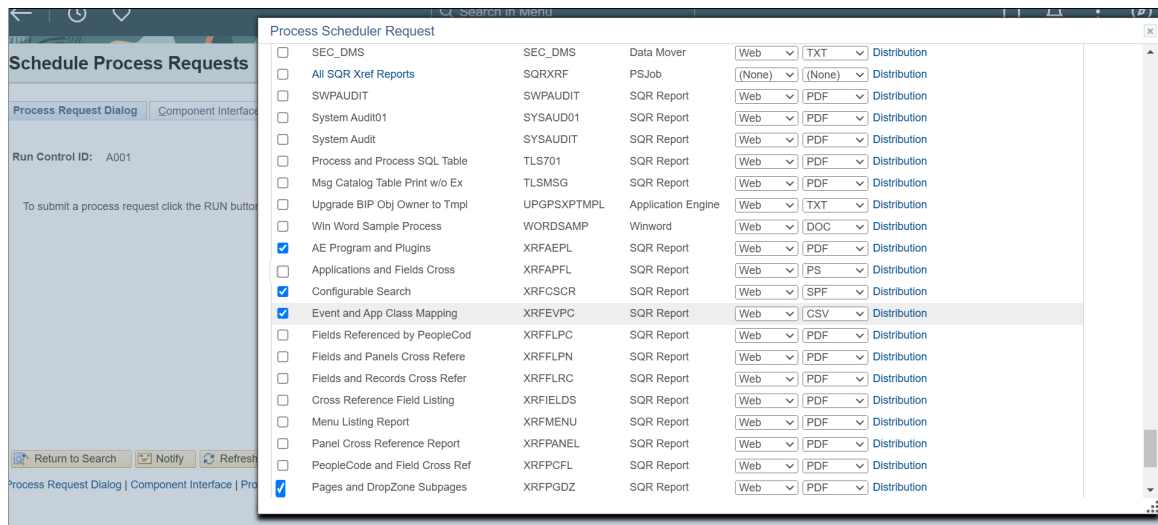

5. Select the process — XREFPGDZ, XRFAEPL, XRFCSCR, or XRFVPC depending on which report you want to generate.
6. Click OK to generate a report. By default, a consolidated report is generated that contains both the PeopleSoft and non-PeopleSoft delivered configurations.

This is an example of a Drop Zone SQR report in PDF format.

| PeopleSoft                                     |                      |        |       |                    |                    | Page No. 1          |
|--|----------------------|--------|-------|--------------------|--------------------|---------------------|
| CROSS REFERENCE -- PAGES AND DROPZONE SUBPAGES |                      |        |       |                    |                    | Run Date 11/05/2024 |
|  |                      |        |       |                    |                    | Run Time 03:20:35   |
| Report ID:                                     | XRFPGDZ              |        |       |                    |                    |                     |
| Project Name:                                  | 1111                 |        |       |                    |                    |                     |
| Report Type:                                   | FULL                 |        |       |                    |                    |                     |
| Output Type:                                   | BOTH                 |        |       |                    |                    |                     |
| Component                                      | Portal Object        | Market | Type  | Page               | DropZone SubPage   |                     |
| QEQUICKCONTACTS                                | QEQUICKCONTACTS_GBL  | GBL    | Fluid | QEQUICKCONTSP1_SEC | QE_RCF_PAY_SUB     |                     |
|  |                      |        |       | QE_DZ_QK_CONTACTS  | QE_RCF_PAY_INFO    |                     |
|  |                      |        |       |                    | QE_SUOW_L1_SRV_SBP |                     |
| QEQUICKCONTACTS2                               | QEQUICKCONTACTS2_GBL | GBL    | Fluid | QEQUICKCONTACTS2   | QEQCX_ATHEEND      |                     |
|  |                      |        |       |                    | QEQCX_INSTRUCT_SBP |                     |
|  |                      |        |       |                    | QEQCX_SBP          |                     |
|  |                      |        |       | QEQUICKCONTSP1_SEC | QE_BOOKINFO_SBP    |                     |
|  |                      |        |       | QEQUICKCONT_SEC    | QEQCX_ATHEEND      |                     |

Note that an SQR report gets generated even if there is no data. The empty report will contain the header information and columns. The data section will display the 'No References Found' message.

Instead of a consolidated report, you can customize to generate a PeopleSoft-only or non-PeopleSoft delivered configurations.

To customize a report:

1. Select PeopleTools, Process Scheduler, Process Scheduler Processes.
2. On the Override Options tab, you can modify parameters to generate filtered reports.

This example illustrates the fields and controls on the Override Options page.

### Process Scheduler Processes

Process Definition
Process Definition Options
Override Options
>

Process Type **SQR Report**

Name **XRFCSCR**

**Override Options**

\*Parameter List:  ▾

\*Command Line:  ▾

\*Working Directory:  ▾

**Parameters**

By default, the override options are set to *1111*, *FULL*, and *BOTH*, which generates a *full database* report.

To generate a report on a specific project, replace *1111* with the name of the project to be analyzed.

For a report on non-PeopleSoft delivered configurations, replace *FULL* with *FILTER*.

*BOTH* generates the SQR report in your chosen format, and saves the Managed Object list to the PS\_PTADSUMMOL table and ADS instances list to the PS\_PTADSUMAOL table.

Replace *BOTH* with *OUTDB* to add managed Object list and ADS instances list to PS\_PTADSUMMOL table and PS\_PTADSUMAOL table respectively. No SQR report will be generated.

Replace *BOTH* with *OUTFILE* to generate only the SQR report, which gets saved in a chosen format such as, PDF or Web.

## Generating SQR Reports from the Isolated Customization Reports Page

Use this page to generate SQR reports to capture details on configurations done using drop zones, event mapping, Application Engine plug-ins, and configurable search.

Navigate to PeopleTools, Lifecycle Tools, Isolated Customization Reports.

This example illustrates the fields and controls on the Isolated Customization Reports page.

You can find definitions for the fields and controls later on this page.

**Isolated Customization Reports**
Report Manager Process Monitor Run

Run Control ID NEW

**Options**

Report Category Database ▾

Report Type Full ▾

Output to Table ☑

**Reports For**

Application Engine Plugins ☑

Configurable Search ☐

Drop Zone ☑

Event Mapping ☑

**View Reports**

Status Success

[Reports](#) [Process Details](#)

| <b>Field or Control</b> | <b>Description</b>   |
|-------------------------|--|
| Report Category         | Select database or project.<br><br>Project name field to select a project is enabled when you choose the project category. |
| Report Type             | The options are Filter or Full.<br><br>Full- Generates a full database report.<br><br>Filter- Generates a filtered report. |

| <b>Field or Control</b> | <b>Description</b>   |
|-------------------------|--|
| Output to Table         | Select this option to add Managed Object list and ADS instances list to the PS_PTADSUMMOL table and PS_PTADSUMAOL table respectively.  |
| Reports For             | Select the options to generate reports on Drop Zones, Event Mapping, Application Engine Plug-ins, and configurable search.   |
| View Reports            | <p>After running the SQR program with the PTISOCUSTRPT Application Engine program, you can view the status.</p> <p>If it is success, you can see a Reports link to view the report in PDF or other supported formats.</p> <p>Click the Process Details link to view the details. If the program fails, click on the Process Instance link for further troubleshooting.</p> |

After selecting the required options, click Run. The Process Scheduler Request page opens where you run the PTISOCUSTRPT Application Engine program.

This example illustrates the fields and controls on the Process Scheduler Request page.

Cancel
**Process Scheduler Request**
OK

User ID PS

Run Control ID NEW1

---

Server Name

Run Date

Recurrence

Run Time

[Reset to Current Date/Time](#)

Time Zone

**Process List**

| Select                              | Description                    | Process Name | Process Type       | *Type                            | *Format                          | Distribution                 |
|-------------------------------------|--------------------------------|--------------|--------------------|----------------------------------|----------------------------------|------------------------------|
| <input checked="" type="checkbox"/> | Isolated Customization reports | PTISOCUSTRPT | Application Engine | <input type="text" value="Web"/> | <input type="text" value="PDF"/> | <a href="#">Distribution</a> |

When PTISOCUSTRPT runs, the selected SQR programs gets scheduled on the Process Scheduler.

The report can be generated only in HTM or PDF format.

Note that only data pertaining to the latest run is maintained. When an SQR program is run, the previous data gets overwritten.

Same SQR report generated by multiple users is maintained in the Managed Object list table PS\_PTADSUMMOL and ADS instances list table PS\_PTADSUMAOL, along with the user ID, to avoid conflicts.

For example, configurable search report generated by two users QEDMO and VP1 will be maintained in the database table. When VP1 generates the configurable search report again, then the previous data gets overwritten. However, the configurable search report generated by QEDMO remains.

### **Related Links**

“Configuring Drop Zones” (Application Designer Developer’s Guide)

“Configuring Application Engine Action Plug-ins” (Application Engine)

“Mapping Application Class PeopleCode to Component Events ” (Portal Technology)

“Working with Configurable Search” (Search Technology)

## Chapter 17

# Using PeopleSoft Data Mover

---

## Understanding PeopleSoft Data Mover

This section provides an overview of PeopleSoft Data Mover.

---

**Note:** PeopleSoft supports a number of versions of UNIX and Linux in addition to Microsoft Windows. Throughout this documentation, we make reference to operating system configuration requirements. Where necessary, the documentation refers to specific operating systems by name. However, for simplicity the word UNIX refers to all UNIX-like operating systems, including Linux.

---

## PeopleSoft Data Mover Overview

PeopleSoft Data Mover enables you to:

- Transfer application data between PeopleSoft databases.
- Move PeopleSoft databases across operating systems and database platforms.
- Run Structured Query Language (SQL) statements against any PeopleSoft database, regardless of the underlying operating system or database platform.
- Control database security and access.
- Create, edit, and run scripts.

These scripts may include any combination of SQL commands and PeopleSoft Data Mover commands for exporting and importing data.

---

**Note:** Data in PeopleSoft databases generally can't be transferred directly between major releases using PeopleSoft Data Mover. For example, you can't import data from a PeopleTools 7.x database into a PeopleTools 8.x database.

---

## PeopleSoft Data Mover Environment

There are two ways to run PeopleSoft Data Mover:

- Using the Data Mover development environment.

This is a graphical user interface (GUI), which runs only in Microsoft Windows. Use the Data Mover shortcut in the PeopleSoft program group. Select Start, Programs, *your\_PSFT\_program\_group*, Data Mover.

- Using the Data Mover command-line interface.

The command-line interface is intended mainly for UNIX servers. You run PeopleSoft Data Mover from a console in Microsoft Windows and from a telnet session in UNIX.

---

**Note:** PeopleSoft Data Mover runs in two-tier mode only. You must sign in to the database directly, not through an application server.

---

You set Data Mover environment variables in PeopleSoft Configuration Manager on Windows and in the `psconfig.sh` for UNIX.

## Related Links

[Setting Up UNIX to Run PeopleSoft Data Mover](#)

## PeopleSoft Data Mover Operating Modes

Operating modes determine how you are connected to the database. PeopleSoft Data Mover operating modes are:

- Regular mode.

Most of the time, you use regular mode. To sign in to regular mode, enter your PeopleSoft user ID and password during sign-in. In regular mode, all commands are valid.

- Bootstrap mode.

In bootstrap mode, you use a database access ID and password when signing in. Typically, you use bootstrap mode for database loading, because no PeopleSoft security tables are established yet. You also use bootstrap mode for running some security commands, such as `ENCRYPT_PASSWORD`.

---

**Note:** In bootstrap mode, the following script commands are not valid: `EXPORT` and `RENAME`.

---

---

## Understanding Data Mover Scripts

This section discusses the commands and statements used in Data Mover Scripts.

## Data Mover Script Commands

This section discusses the valid PeopleSoft Data Mover commands that you can include in PeopleSoft Data Mover scripts.

PeopleSoft Data Mover commands are platform-independent and are unique to PeopleSoft Data Mover. You can use PeopleSoft Data Mover commands for importing, exporting, and other tasks, such as controlling the run environment, renaming fields and records, administering database security, and denoting comments.

The following table describes the PeopleSoft Data Mover commands and the ways that you can indicate comments:

| <b>Command</b>      | <b>Description</b>   |
|---------------------|--|
| ENCRYPT_PASSWORD    | Encrypt one or all user passwords (operator and access) defined in PSOPRDEFN for users.  |
| EXPORT              | Select record information and data from records and store the result set in a file. You can use the generated export file as input for migrating to another platform. This file is portable between ASCII and EBCDIC character sets, and also supports double-byte characters.   |
| IMPORT              | Insert data into tables using the information in an export file. If a tablespace or table does not exist, this command creates tablespace, table, and indexes for the record, using the information in the export file, and inserts the data.  |
| REM, REMARK, and -- | Indicate comment statements.   |
| RENAME              | Rename a PeopleSoft record, a field in one record, or a field in all records.  |
| REPLACE_ALL         | This is a variation of the IMPORT command. If a table already exists, use this command to drop the table and its indexes from the database. It then does the following: <ol style="list-style-type: none"> <li>1. creates the table.</li> <li>2. creates any triggers.</li> <li>3. inserts the data.</li> <li>4. creates indexes.</li> </ol> |
| REPLACE_DATA        | This is a variation of the IMPORT command. Delete data in existing tables and insert the corresponding data from the export file.  |
| REPLACE_VIEW        | Recreate specified views found in the database.  |
| RUN                 | Run a specified .DMS file from within a PeopleSoft Data Mover script. The file cannot contain nested RUN commands.   |
| SET                 | When a command is followed by valid SET parameters, it forms a statement that establishes the conditions under which PeopleSoft Data Mover runs the PeopleSoft Data Mover and SQL commands that follow.  |

| <b>Command</b>           | <b>Description</b>   |
|--------------------------|--|
| SET_IGNORE_IMPORT_ERRORS | (Optional) If this command is set, then all errors produced by IMPORT, REPLACE_DATA, and REPLACE_ALL will be ignored and processing will continue until the end of the data file or last import command.<br><br>Any failed records will be shown in the Data Mover log if it is run from the Data Mover GUI or the import output if it is run from the command line. |
| SET IGNORE_ERRORS        | (Optional) If this command is set, then all errors produced by the SWAP_BASE_LANGUAGE command are ignored. Otherwise, the system stops on errors.  |
| SET IGNORE_SPLCHARS      | (Optional), If this command is set with option ON, then special character, such as colon would not be used as bind variable.<br><br>The carriage returns and spaces in a SQL string are not skipped and gets inserted into the database as it is written in the DMS script.<br><br>Default value is OFF.   |
| SET BASE_LANGUAGE        | Swap individual language tables. You should swap individual tables only when there is an error with any of the tables after the SWAP_BASE_LANGUAGE command.  |
| SWAP_BASE_LANGUAGE       | Swap all the language tables from PSRECDEFN.   |

## Related Links

[Using PeopleSoft Data Mover Commands](#)

[Using PeopleSoft Data Mover Command Modifiers](#)

[Using SET Parameters](#)

## Supported SQL Commands

With PeopleSoft Data Mover, you can use supported SQL commands in scripts on any supported database platform. Except as noted in the following discussion regarding standard SQL commands, you can use all of the supported SQL commands with the following Data Mover SET statements:

- SET LOG
- SET NO COMMIT
- SET NO TRACE

## Standard SQL Commands with DMS Scripts

PeopleSoft Data Mover supports the following standard SQL commands:

- ALTER
- COMMIT
- CREATE
- DELETE
- DROP

---

**Note:** With DROP commands, any drop errors are ignored. The script continues, but the errors are reported in the log.

---

DB2 UTS customers can use the DROP table command.

- GRANT
- INSERT

---

**Important!** INSERT cannot be used with SET NO COMMIT or SET NO TRACE.

---

- ROLLBACK
- UPDATE
- TRUNCATE

---

**Warning!** PeopleSoft Data Mover does not support SELECT statements, because they require a SQL FETCH function.

---

## Standard SQL Commands with SQL Files

PeopleSoft Data Mover supports all SQL commands and other database-specific function calls that are supported by the database engine.

---

**Note:** PeopleSoft Data Mover runs only files with the extension *.SQL*.

---

## Nonstandard SQL Commands

With PeopleSoft Data Mover, you can also use the following nonstandard SQL commands created by PeopleSoft: STORE and ERASE. Use the commands to change COBOL SQL statements in PS\_SQLSTMT\_TBL.

The STORE command first deletes the existing stored statement from PS\_SQLSTMT\_TBL, and then inserts the new statement using the following syntax:

```
STORE progname_type_stmtname
```

For example:

```
STORE PTPEMAIN_S_MSGSEQ
SELECT MAX (MESSAGE_SEQ), PROCESS_INSTANCE
FROM PS MESSAGE_LOG
WHERE PROCESS_INSTANCE = :1
GROUP BY PROCESS_INSTANCE
;
```

The ERASE command deletes one or all stored statements from PS\_SQLSTMT\_TBL. When deleting a single statement, you use the *progrname\_type\_stmntname* format as shown for STORE. For example:

```
ERASE PTPMAIN_S_MSGSEQ;
```

When deleting all SQL statements for a particular program, you include only the program name in the command line format. For example:

```
ERASE PTPMAIN;
```

## Expressing Dates and Time in SQL Used in Data Mover

When you need to express dates and time in Data Mover SQL statements, use PeopleSoft meta-SQL date and time constructs, such as %CURRENTDATEOUT, %CURRENTTIMEOUT, %CURRENTDATETIMEOUT, %DATEIN, %TIMEIN, and so on.

See “Understanding Meta-SQL” (PeopleCode Language Reference).

## Truncating Tables

Occasionally, it is necessary to delete all the rows in a table from Data Mover. Data Mover supports the use of the TRUNCATE command. When used, Data Mover resolves the command to the current database syntax using PeopleTools meta-SQL constructs.

For best performance, using the TRUNCATE command is recommended, rather than performing a mass DELETE operation, which can encounter performance issues where large tables and triggers are involved.

See “%TruncateTable” (PeopleCode Language Reference).

## Data Mover Commands Compared to SQL Commands

The following table shows the relationship between SQL and PeopleSoft Data Mover commands. *DDL* refers to data definition commands, which define the structure of a database. *DML* refers to data manipulation commands which define the contents of a database.

| <i>Function</i>                          | <i>Command Type</i> | <i>Supported SQL Commands</i> | <i>Data Mover Commands</i> |
|--|---------------------|-------------------------------|----------------------------|
| Create tables, tablespaces, and indexes. | DDL                 | CREATE                        | IMPORT<br>REPLACE_ALL      |
| Create views.                            | DDL                 | CREATE                        | REPLACE_VIEW               |
| Drop tables.                             | DDL                 | DROP                          | REPLACE_ALL                |
| Modify tables.                           | DDL                 | ALTER                         | None                       |
| Modify PeopleSoft records.               | DDL                 | None                          | RENAME                     |

| <b>Function</b>  | <b>Command Type</b> | <b>Supported SQL Commands</b> | <b>Data Mover Commands</b>                  |
|--|---------------------|-------------------------------|---|
| Delete <i>all</i> rows.                                    | DDL                 | TRUNCATE                      | None  |
| Insert rows.   | DML                 | INSERT<br>STORE               | IMPORT<br>REPLACE_ALL<br>REPLACE_DATA       |
| Delete rows.   | DML                 | DELETE<br>ERASE               | REPLACE_DATA                                |
| Update rows.   | DML                 | UPDATE                        | None  |
| Encrypt rows.  | DML                 | None                          | ENCRYPT_PASSWORD                            |
| Select rows.   | Query               | None                          | EXPORT                                      |
| Save or don't save changes.                                | Transaction         | COMMIT<br>ROLLBACK            | SET (when used with<br>COMMIT or NO COMMIT) |
| Control or run other<br>PeopleSoft Data Mover<br>commands. | Environment         | None                          | SET<br>RUN                                  |
| Denote an explanatory<br>statement.                        | Comment             | None                          | REM<br>REMARK<br>--                         |

## PeopleSoft Data Mover COMMIT Statements

PeopleSoft Data Mover issues COMMIT statements after most successful SQL commands, except for EXPORT and IMPORT. For EXPORT and IMPORT, PeopleSoft Data Mover issues a COMMIT after each record. With IMPORT, a SET COMMIT *n* command performs a COMMIT after the system inserts every *n* rows.

If you are executing native SQL in PeopleSoft Data Mover, and no COMMIT statements exist in the SQL script, PeopleSoft Data Mover issues a COMMIT after each successful SQL statement. For example, if you run a PeopleSoft Data Mover script that contains three update commands, and the third command fails, the first and second update commands are committed, but the third command is not.

---

## Using the Development Environment

This section discusses how to use the development environment.

### Signing In to the Development Environment

To start PeopleSoft Data Mover in the Windows development environment:

1. Select Start, Programs, PeopleSoft Group, Data Mover.

If you don't have a PeopleSoft Data Mover shortcut, you can add one to the desktop. The executable to launch is: `PS_HOME\bin\client\winx86\psdmt.exe`

2. Sign in using the appropriate ID and password.

In regular mode, use a user ID and password. In bootstrap mode, use a system access ID and access password, such as SYSADM.

### Navigating the Data Mover Window

The PeopleSoft Data Mover interface consists of two horizontal panes: an input pane and an output pane. The input pane is on top.

The status bar at the bottom of the window provides the following information:

- Database name (for example, QEDMO, PTS920HR, and so on).
- Database type (for example, Oracle, DB2, and so on).
- Operating mode (regular or bootstrap).
- Trace status (on or off).

The input pane displays the script that you open. In this pane, you view and edit PeopleSoft Data Mover scripts.

The output window displays the results after running a script. If you encounter any errors, the output window shows where the script failed. In a multi database environment, always check the information at the top of the output to ensure that you run the script against the appropriate database. Specifically, verify the information on the Database line.

---

**Note:** By default, the results in the output window are saved to the file DATAMOVE.LOG, which is written to the default log directory as specified in PeopleSoft Configuration Manager (on the Edit Profile, Common tab). You can specify a different file name.

---

The status of the SQL Trace utility appears on the right-hand end of the status bar. Use PeopleSoft Data Mover with tracing turned off. There are several ways to disable the SQL Trace utility (for the Microsoft Windows environment) before starting PeopleSoft Data Mover. You can use:

- PeopleSoft Configuration Manager.
- PeopleTools options.

- A Data Mover command (NO TRACE).

The operating mode on the status bar indicates either regular mode or bootstrap mode. If you connect to the database in regular mode, the operating mode status is blank. The operating mode is bootstrap if you sign in using the access ID and password.

---

**Note:** Verify the mode that you are using. Most commands require regular mode to run successfully.

---

### Related Links

[Using SET Parameters](#)

[NO TRACE](#)

[PeopleSoft Data Mover Operating Modes](#)

---

## Creating and Running PeopleSoft Data Mover Scripts

This section provides overviews of command types and syntax rules in PeopleSoft data mover scripts.

### Understanding Command Types

A PeopleSoft Data Mover script can contain two types of commands:

- Data Mover commands.

Use these commands to export and import database information and to otherwise modify the database. PeopleSoft Data Mover commands also control script execution, call other PeopleSoft Data Mover files, and indicate comments.

- SQL commands.

You can use both standard and nonstandard SQL commands that modify the database.

### Understanding Syntax Rules

To create or edit PeopleSoft Data Mover scripts, follow these syntax rules to ensure that the commands run successfully.

#### Delimiters

With the exception of double-hyphen (--) comment statements, every command statement must be followed by a delimiter.

Valid delimiters are:

- Semicolon (;)

A semicolon can appear on the same line as the command itself, or by itself on the line immediately following a command statement. For example, the following two examples of the semicolon delimiter are valid:

```
SET OUTPUT c:\temp\abc.dat;
```

```
SET LOG c:\temp\new.log
;
```

- Forward slash (/)

This delimiter can be used only on a line by itself, in column 1, on a line immediately following a command statement. For example:

```
IMPORT *
/
```

## Multiline Statements

With the exception of double-hyphen (--) comment statements, statements can span multiple lines. For example:

```
EXPORT absence_hist
WHERE absenCe_type = 'A';
```

## Multiline Comments

A double-hyphen (--) comment statement does not require a delimiter termination. However, each statement can't span more than one line. Be sure to add a space after the double hyphen before you start the comment. For example:

Correct:

```
-- This script imports the information stored in
-- the ABC.DAT file.
```

Incorrect:

```
--This script imports the information stored in
the ABC.DAT file.
```

## White Space

Command statements can contain any amount of white space between items.

## Case Sensitivity

Statement text is not case-sensitive. For example,

```
IMPORT *
```

is equivalent to

```
import *
```

## String Constants

String constants are case-sensitive and must be surrounded by single quotation marks. For example, 'ABC' is treated differently than 'Abc' or 'abc'.

## Record Names and Table Names

In PeopleSoft Data Mover, when a record name needs to be specified as one of the elements in the command statement syntax, as in an `IMPORT` statement, you can specify either the record name or the corresponding table name. For example, the following `IMPORT` statements are equivalent:

Correct:

```
IMPORT job;
```

Correct:

```
IMPORT ps_job;
```

However, when a table name is required for one of the elements in the command statement syntax, you must use the table name, not the record name. For example:

Correct:

```
IMPORT job AS ps_process;
```

Incorrect:

```
IMPORT job AS process;
```

## Creating and Editing Scripts

When you use PeopleSoft Data Mover to manipulate the information in a database, you can either write a new script or open and edit an existing script that is similar to the one that you want to create.

The default file extension for scripts is *.DMS*, which stands for *Data Mover script*.

### Creating a New Script

To create a new script:

1. Select File, New.

When you first launch PeopleSoft Data Mover, a new file appears automatically. .

2. Enter the script text (that is, the code) in the input pane, which appears on top.

Using proper Data Mover syntax, enter the command statements that you want the script to run.

3. Save the script.

Select File, Save. In the Save As dialog box, select the **Save as Unicode** check box (if appropriate) and click **Save**.

### Editing an Existing Script

To edit an existing PeopleSoft Data Mover script:

1. Select File, Open.
2. Select the file and click **OK**.

By default, you view only .DMS files. You can select *All Files* from the **Files of type** drop-down list box to view all file types. After you open a script, it appears in the PeopleSoft Data Mover input pane.

3. Modify the script.

If the file that you opened is not a .DMS file, verify that it conforms to the required syntax rules and that it doesn't contain unsupported SQL commands.

4. Save the script with a new name.

Select File, Save As.

In the Save As dialog box, enter a file name, select the **Save as Unicode** check box (if appropriate) and click **Save**.

If the script is edited in Unicode format, then the default save is Unicode. However, if the file is opened in ASCII format, then the default is ASCII.

### Related Links

[Understanding Data Mover Scripts](#)

[Understanding Syntax Rules](#)

## Preparing to Run Export Scripts

Before running a PeopleSoft Data Mover export script, you must first prepare the database.

To prepare for an export:

1. Load DDL model information by running all DDL\*.DMS files through PeopleSoft Data Mover.
2. To change the DDL model information, use the DDL Model Defaults utility in PeopleTools Utilities.
3. Run DDDAUDIT.SQR and fix any errors that it finds.
4. Run SYSAUDIT.SQR and SYAUD01.SQR and fix any errors.
5. Use the SQL Alter function in Application Designer to alter all tables.

Either let the files alter in place or run the script that it generates to alter any tables that it marks as out of synchronization.

6. Use the SQL Create function in Application Designer to create all records, using the *If table exists ... Never recreate* option.

### Related Links

[System and Server Administration](#)

[“Understanding Data Integrity Tools” \(Data Management\)](#)

[Application Designer Developer's Guide](#)

## Running Scripts

Through PeopleSoft Data Mover, you can run DDL, DML, and SQL scripts created with the following tools:

- PeopleSoft Data Mover (DMS scripts).
- Build SQL functionality in Application Designer (SQL scripts).
- Platform-specific SQL utilities (SQL scripts).

---

**Note:** You can also schedule PeopleSoft Data Mover scripts using PeopleSoft Process Scheduler. This can be useful in scheduling audit routines or extracting data from the PeopleSoft database. Additionally, logs and data files generated by PeopleSoft Data Mover can be posted to the report repository in PeopleSoft Process Scheduler so that they can be viewed either through Process Monitor or Report Manager.

---

**Note:** DMS scripts which contain characters outside of the US ASCII range should be saved in UTF-8 encoding.

---

When running scripts through PeopleSoft Data Mover, keep the following items in mind:

- Turn off the SQL Trace utility to run PeopleSoft Data Mover scripts.

If SQL Trace is enabled, disable it on the Trace tab in PeopleSoft Configuration Manager before you run the script. You can also enter the SET NO TRACE statement within scripts. This disables SQL Trace for the DMS script even if it is enabled in PeopleSoft Configuration Manager.

- Records defined using the PeopleSoft Data Mover EXPORT and IMPORT commands can have a maximum of 500 columns, and they can have multiple long columns within the limitations for long columns set by the database platform.

Check with the database vendor for restrictions on the number of long columns allowed for the platform.

- On DB2 UDB platforms, locks can occur on system catalogs.

Do not run unattended PeopleSoft Data Mover sessions. Close the session as soon as all scripts terminate.

- To run a SQL script, you must open it by selecting File, Open so that the SQL runs properly.

Do not copy and paste SQL from another source into PeopleSoft Data Mover.

---

**Note:** If you plan to import or export files greater than 2 gigabytes (GB) on UNIX, you must enable large file support at the operating system level.

---

To run a script:

1. Select File, Open.
2. Select one of the following types of script to run.
  - PeopleSoft Data Mover files (.DMS).

These are the files created using PeopleSoft Data Mover.

- Query files (.SQL).

These are the files created using the Build SQL functionality in Application Designer or using a query tool specific to a relational database management system (RDBMS), such as PL/SQL on Oracle.

- All files.

Select to view all available files in a directory. Only .DMS and .SQL files are valid file types for PeopleSoft Data Mover.

---

**Note:** SELECT commands are not supported. When performing upgrades, use the SQL utility for the platforms to run .SQL scripts, not PeopleSoft Data Mover.

---

3. Select File, Run.

You can monitor the script's progress in the output pane, which reveals any error messages and displays the message *Script Completed* when processing has ended.

---

## Using the Database Setup Utility

This section discusses how to use the database setup utility.

Typically, you use the Database Setup utility during PeopleSoft installations and upgrades, not on a daily basis. You use this utility to create PeopleSoft Data Mover import scripts that load data into a PeopleSoft database.

---

**Note:** If you are performing an installation, use the documentation included in your PeopleSoft installation guide, which provide specific details regarding your applications, languages, and RDBMS. This section provides a general overview and is not specific to the installation procedure.

---

## Accessing the Database Setup Utility

To access the Database Setup utility:

1. Sign in to PeopleSoft Data Mover in bootstrap mode.

Use the access ID and password rather than your PeopleSoft user ID and password.

2. Select File, Database Setup.

---

**Note:** If you sign in to PeopleSoft Data Mover using regular mode, not bootstrap mode, the Database Setup menu item is not available.

---

## Working with the Database Setup Utility

This section discusses the dialog boxes that make up the utility.

## Database Setup

| <i>Field or Control</i>       | <i>Description</i>  |
|-------------------------------|---|
| <b>Select Target Database</b> | Select the RDBMS against which to run the database setup script. For instance, if the database that you are creating will run on an Oracle server, select <i>Oracle</i> . |
| <b>Database Type</b>          | PeopleSoft supports non-Unicode (ANSI) and Unicode database types. Select the appropriate type for the system. For some RDBMS types, Unicode is not available.            |
| <b>Select Character Set</b>   | Select a character set. Your choices vary depending on the database type that you selected.   |

## Select PeopleSoft Application

| <i>Field or Control</i>             | <i>Description</i>  |
|-------------------------------------|---|
| <b>PeopleSoft Application</b>       | Only the applications that you have licensed appear. Select the applications for which you want to create PeopleSoft Data Mover scripts. To add applications selectively, use the <b>Add</b> button. To add all applications available, use the <b>Add All</b> button.  |
| <b>Data Mover Scripts to Create</b> | Use the <b>Remove</b> button to remove a single application, or use the <b>Remove All</b> button to clear the list box.   |
| <b>Database Type</b>                | Specify what the result of running the script should be. There are two database codes: <i>PT</i> for PeopleTools and <i>EP</i> for PeopleSoft applications. Options are: <ul style="list-style-type: none"> <li>• <i>Demo</i>: Select to create a demonstration database.</li> <li>• <i>System</i>: Select to create a system database.</li> <li>• <i>Add New Language</i>: Select to add support of new languages to an existing database.</li> <li>• <i>Add New Product</i>: Select to add a new PeopleSoft product to the current system. With this option selected, only non-PT database codes appear.</li> </ul> |

## Database Parameters

| <b>Field or Control</b>          | <b>Description</b>   |
|----------------------------------|--|
| <b>Database Name</b>             | Enter the name of the database against which to run the script. The database name that appears is the database to which you are currently signed on. If the script that you are creating will be run against another database, specify the appropriate name here. If you generate a script for a database other than the current database, the system uses a default database using the following convention: <i>XXDMO</i> for demonstration databases and <i>XXSYS</i> for system databases. The <i>XX</i> represents the product code, such as HR. |
| <b>Symbolic ID</b>               | Enter the ID used as the key to retrieve the access ID and access password. For initial installation, set it equal to the database name.   |
| <b>Access ID</b>                 | This ID is the RDBMS ID with which PeopleSoft applications are ultimately connected to the database once the PeopleSoft system validates the user or connect ID. It typically has all the RDBMS privileges necessary to access and manipulate data for an entire PeopleSoft application.   |
| <b>Access Password</b>           | Enter the password associated with the access ID.  |
| <b>Connect ID</b>                | This ID is used for the initial connection to the database. Any two-tier connection requires a connect ID. A connect ID is a valid user ID, that when used during logon, takes the place of PeopleSoft user IDs for the sign-in process.   |
| <b>Table Owner</b>               | (DB2 UDB for z/OS) This field populates the CREATOR field in the system catalog table SYSIBM.SYSTABLES. You determine the name of the table owner ID during the initial installation.  |
| <b>Index Storage Group</b>       | (DB2 UDB for z/OS) Enter the storage group where the index spaces are created.   |
| <b>Table Space Storage Group</b> | (DB2 UDB for z/OS) Enter the storage group for tablespaces. This value must be the same as that used in the XXDDL.SQL script when you create tablespaces during the installation.  |

## Checking the Generated Script

After running the Database Setup utility, check the output directory for the generated script. Some commands are added that call other scripts and perform various functions. These commands are added to reduce the number of scripts and commands that you must run manually. For example, note that the following commands appear at the end of the script:

- REPLACE\_VIEW

This command creates views for the new database.

- CREATE\_TEMP\_TABLE

This command creates any necessary temporary table images. The number of temporary tables is determined by the value for the **Temp Table Instances** setting in PeopleTools options (Utilities, Administration, PeopleTools Options) plus the number of PeopleSoft Application Engine temporary tables.

- SWAP\_BASE\_LANGUAGE

If you selected a base language other than English, this command modifies the system to recognize that language as the base language. The default PeopleTools language is English if the PSSTATUS table is not available.

- RUN

This command runs the CURRXXX.DMS script to load the system with the appropriate currency information, and it runs MSGTLXXX.DMS to load the system with the appropriate PeopleTools messages (error and informational messages). The XXX represents the language code, such as FRA for French. The system runs these scripts only if you have selected a base language other than English.

---

**Note:** After each DDL create table, import data, and DDL create indexes command, PeopleSoft Data Mover issues an UPDATE STATISTICS command (except on z/OS), which improves the performance of subsequent commands, such as the REPLACE\_VIEW command.

---

### Related Links

[CREATE\\_TEMP\\_TABLE](#)

[SWAP\\_BASE\\_LANGUAGE](#)

---

## Using the PeopleSoft Data Mover Command-Line Interface

This section provides an overview of using the PeopleSoft Data Mover command-line interface.

### Understanding the PeopleSoft Data Mover Command-Line Interface

The PeopleSoft Data Mover command-line interface enables you to run PeopleSoft Data Mover scripts from the command line in UNIX and Microsoft Windows environments. The command-line interface is designed only for running scripts, not creating and editing scripts. In Microsoft Windows, you create and edit scripts using the PeopleSoft Data Mover development environment. In UNIX, you can use any supported text editor.

When using the command-line interface, the results of the script run appear in the command-line window, much like the contents of the output pane in the PeopleSoft Data Mover GUI. The system also writes this information to the log file.

The PeopleSoft Data Mover command line supports the environment variable `$PS_HOME` on UNIX and `%PS_HOME%` on Windows.

---

**Note:** Although the command-line interface also runs on Windows machines, this documentation primarily discusses UNIX.

---

---

**Important!** The PeopleSoft Data Mover command line on UNIX is intended to increase performance with large database loads during installation. Use the PeopleSoft Data Mover Windows interface for other types of scripts.

---

## Setting Up UNIX to Run PeopleSoft Data Mover

Before running the PeopleSoft Data Mover command-line interface on UNIX, verify that Tuxedo is installed. Tuxedo is required for PeopleSoft Data Mover to run on UNIX.

Next, configure the `psconfig.sh` shell script to set the UNIX and PeopleTools environment variables properly for Data Mover, then run the script. You must run it from the `PS_HOME` directory.

---

**Note:** The UNIX environment requires certain platform-specific environment variables. These variables are set automatically, but you can reconfigure the `psconfig.sh` script file to change their values.

---

### UNIX Environment Variables

Data Mover environment variables for UNIX are stored in the `psconfig.sh` script. When you run `psconfig.sh`, several environment variables are automatically set to default values that reflect a standard PeopleSoft Data Mover install.

To modify them, you must edit `psconfig.sh` or manually change the environment.

| <b>Statement</b>  | <b>Description</b>  |
|---|---|
| <code>\$DM_HOME=\$HOME/PS_DM</code>                       | Data Mover output, log file and trace file path. This environment setting needs to point to a writable location in case of a secure, read-only PS_HOME environment.<br><br>The default setting is <code>\$HOME/PS_DM</code> |
| <code>PS_DM_DATA_IN=\$PS_HOME/data</code>                 | Specifies the directory where PeopleSoft Data Mover searches for input data (.DAT) files. The default setting is <code>\$PS_HOME/data</code> .  |
| <code>PS_DM_DATA_OUT=\$DM_HOME/data</code>                | Specifies the directory where PeopleSoft Data Mover writes the output data (.DAT) files. The default setting is <code>\$DM_HOME/data</code> .   |
| <code>PS_DM_SCRIPT=script_path;export PS_DM_SCRIPT</code> | <code>PS_DM_SCRIPT</code> specifies the location of the PeopleSoft Data Mover script files. The default setting is <code>\$PS_HOME/scripts</code> .   |
| <code>PS_DM_LOG=log_path;export PS_DM_LOG</code>          | <code>PS_DM_LOG</code> specifies the location of PeopleSoft Data Mover log files. The default is <code>\$DM_HOME/log</code> , as in as in <code>\$HOME/PS_DM/log</code> .   |

---

**Note:** `$DM_HOME/log` is an environment variable for UNIX specifying a location to which Data Mover has write access in the case of a read-only PS\_HOME configuration.

---



---

**Note:** If you want to perform tracing under UNIX, you must set additional environment variables.

---



---

**Note:** If you have installed your PeopleSoft application outside of PS\_HOME, make sure to consider the PS\_APP\_HOME location.

---

See [Setting Up Tracing](#).

## Setting Up Tracing

To enable tracing for PeopleSoft Data Mover, you must set the `PS_SERVER_CFG` environment variable to point to the Data Mover configuration file, which contains parameters for tracing and character set:

- In Windows, you can set `PS_SERVER_CFG` in the System control panel, or issue the following command in a batch file or at a command prompt:

```
set PS_SERVER_CFG=%PS_HOME%\setup\psdmtx.cfg
```

- In UNIX, edit `psconfig.sh` to include the following statement:

```
PS_SERVER_CFG=$PS_HOME/setup/psdmtx.cfg;export PS_SERVER_CFG
```

To configure tracing for PeopleSoft Data Mover, you must edit the `psdmtx.cfg` file to specify the appropriate tracing behavior. Use the *TraceSql* bitfield parameter to set the level of the SQL trace by adding together the numeric values that represent each degree of tracing required. The values are defined as follows:

| <b>Bit Value</b> | <b>Type of Tracing</b>  |
|------------------|---|
| 1                | SQL statements.   |
| 2                | SQL statement variables.  |
| 4                | SQL connect, disconnect, commit and rollback.                             |
| 8                | Row Fetch (indicates that it occurred, not data).                         |
| 16               | All other API calls except <code>ssb</code> .                             |
| 32               | Set Select Buffers (identifies the attributes of columns to be selected). |
| 64               | Database API specific calls.  |
| 128              | COBOL statement timings.  |
| 4096             | Manager information.  |
| 8192             | Mapcore information.  |

After running PeopleSoft Data Mover, look for the generated trace log file in `PS_CFG_HOME\log\APPSRV.LOG`.

For UNIX, the `TraceFile` environment variable enables you to configure the trace file path and name. The system only uses the `TraceFile` value when `TraceSql` is set to a value greater than 0. The default value of `TraceFile` is `DM_HOME/datamover.trc`. For example,

```
TraceFile=%DM_HOME%/datamover.trc
```

## Running Data Mover Scripts from the Command Line

The PeopleSoft Data Mover command line program is located as follows:

- Microsoft Windows: `PS_HOME\bin\client\winx86`
- UNIX: `PS_HOME/bin`

At a command prompt, change to the program directory and issue the **psdmtx** command with the appropriate parameters.

## Standard Command Line Syntax

Use the following standard syntax to run most Data Mover scripts:

```
psdmtx -CT dbtype -CD database_name  
-CO user_ID -CP user_password[-CI connect_ID -CW connect_password]  
[-I process_instance] -FP dms_filepath
```

The value of each parameter follows the parameter name, separated by zero or more spaces. It doesn't need to have quotation marks around it, even if it has internal spaces — the system treats all text following the parameter name as part of the value, up to the next parameter or the end of the command line.

---

**Note:** You must enclose a value in quotation marks only when it includes a hyphen or forward slash, or to include leading or trailing spaces. If the value itself includes a quotation mark character, precede the double quote with a backslash (\).

---

To display a listing of all the command-line parameters and their arguments at the command prompt, enter:

```
psdmtx /help
```

## Standard Command Line Parameters

The following table lists the standard command-line parameters and arguments for running the **psdmtx** command:

| <b>Parameter</b> | <b>Argument</b>  | <b>Example</b>      |
|------------------|--|---------------------|
| -CT              | Specify the database type. Valid values are DB2, DB2ODBC, MICROSOFT, and ORACLE.<br><br><b>Note:</b> Notice the spelling of MICROSOFT. DB2ODBC is the database type for DB2 z/OS.      | -CT ORACLE          |
| -CS              | Specify the server name  | -CS SERVER          |
| -CD              | Specify the name of the database to connect to, as you would when signing in to PeopleSoft.  | -CD HR857DMO        |
| -CO              | Specify the PeopleSoft user ID you're using to sign in.  | -CO JPHAM2          |
| -CP              | Specify the user password for the PeopleSoft user ID you specified.  | -CP <i>password</i> |
| -CI              | (Optional) Specify the connect ID used to connect to the database server.<br><br><b>Note:</b> This parameter is required only if you're running PeopleSoft Data Mover in regular mode. | -CI <i>people</i>   |
| -CW              | (Optional) Specify the password for the Connect ID you specified.<br><br><b>Note:</b> This parameter is required only if you're running PeopleSoft Data Mover in regular mode.         | -CW <i>password</i> |
| -I               | (Optional) Specify the Process Scheduler process instance.   | -I %%INSTANCE%%     |

| <i>Parameter</i> | <i>Argument</i>  | <i>Example</i>                 |
|------------------|--|--------------------------------|
|                  | <p><b>Note:</b> This parameter is required only if you're running PeopleSoft Data Mover from PeopleSoft Process Scheduler. You generally enter the predefined metastring %%INSTANCE%% in the process type definition, and PeopleSoft Process Scheduler inserts the correct value at runtime.</p> |                                |
| -FP              | Specify the file name and path of the PeopleSoft Data Mover script to run.   | -FP \$PS_HOME/scripts/test.dms |
| /help            | No value required.   | <b>psdmtx</b> /help            |

**Note:** When running scripts, be sure to consider your PS\_APP\_HOME location if you've installed your PeopleSoft application outside of PS\_HOME.

Following is an example of a standard **psdmtx** command line on a UNIX system:

```
psdmtx -CT DB2 -CD FS845A1 -CO PSOFT -CP PSOFT
-CI people -CW people -FP fs845aldbo.dms
```

## Using a Parameter File

Rather than submitting parameters manually on the command line, you can have PeopleSoft Data Mover read a file that contains appropriate parameters. Create a text file that contains a complete set of parameters as you would enter them on the command line.

If you submit a parameter file name and path to PeopleSoft Data Mover as the first parameter in the command line, PeopleSoft Data Mover reads the contents of the file and interprets them as parameters entered on the command line. For example:

```
psdmtx c:\dms\myparmfile.txt
```

**Note:** You must enter the full path to the parameter file.

**Warning!** For security reasons, after PeopleSoft Data Mover interprets the contents, it immediately deletes the parameter file.

## Using PeopleSoft Data Mover Commands

This section provides the details of syntax and use for each of the PeopleSoft Data Mover commands. This section also discusses PeopleSoft Data Mover command modifiers, such as AS, WHERE, and IGNORE\_DUPS, which can be used to modify certain commands.

## CHANGE\_ACCESS\_PASSWORD

### Syntax

```
CHANGE_ACCESS_PASSWORD SymbolicID newAccessPswd
```

The following special characters do not work for database passwords:

- double quote (")
- forward slash (/)
- single quote (')
- at sign (@)
- backquote (`)
- backslash (\)

### Description

Use this command to reset the access password and make it transparent to users.

The CHANGE\_ACCESS\_PASSWORD command performs the following operations:

- Selects the access password field from the PSACCESSPROFILE table for the specified symbolic ID.
- Changes the access ID's database password to the new access password that you specify (for Oracle and Microsoft SQL Server only).
- Updates the PSACCESSPROFILE table for the specified symbolic ID with the new access password.

### Parameters

LOG and NO TRACE

## CREATE\_SEQUENCE

### Syntax

```
CREATE_SEQUENCE [* | sequence_name ];
```

### Description

Creates database sequences.

---

**Note:** If a sequence does not exist in the database, then the system creates a new sequence.

---

To define a database sequence as a managed object, refer “Using Maintain Database Sequences” (System and Server Administration)

## CREATE\_TEMP\_TABLE

### Syntax

```
CREATE_TEMP_TABLE {record | *}
```

### Description

Creates temporary table images for use with PeopleSoft Application Engine programs. To customize the number of temporary tables, you need to modify the PeopleTools Options page or updated the PSOPTIONS table using the following SQL:

```
UPDATE PSOPTIONS SET TEMPTBLINSTANCES = number
```

You also need to review the number of temporary tables allotted for PeopleSoft Application Engine programs

---

**Note:** For security reasons, this command is disabled for z/OS.DMS scripts generated by the Database Setup utility.

---

## CREATE\_TRIGGER

### Syntax

```
CREATE_TRIGGER {* | recordname}
```

### Description

Creates database triggers on the specified table.

---

**Note:** If you use CREATE\_TRIGGER in bootstrap mode, the system automatically activates SET IGNORE ERROR. This enables PeopleSoft Data Mover to continue processing until all of the view definitions have been processed, and all errors have been written to the current .LOG file (or an error log file). This is similar to the REPLACE\_VIEW behavior.

---

## ENCRYPT\_PASSWORD

### Syntax

```
ENCRYPT_PASSWORD {userID | *};
```

### Description

Encrypts one or all user passwords (user passwords and access passwords). When encrypting a single user's password, the user ID must be present in PSOPRDEFN. You can use an asterisk instead of a name to encrypt all passwords in PSOPRDEFN.

## Parameters

LOG, NO COMMIT, and NO TRACE.

## Example

Here's an example of how to encrypt a single user password (FS) already listed in PSOPRDEFN:

```
ENCRYPT_PASSWORD FS;
```

To encrypt all user passwords in PSOPRDEFN, enter:

```
ENCRYPT_PASSWORD *;
```

# EXPORT

## Syntax

```
EXPORT {record | *} [WHERE conditions];
```

## Description

Creates a single export file containing the specified database contents. The result set can contain any of the following: a single PeopleSoft record, a group of records, or the entire database. You can use the export file as input for the PeopleSoft Data Mover IMPORT command to migrate the data within the platform or to another platform.

---

**Note:** This command is not available in bootstrap mode.

---

Records exported using EXPORT can have a maximum of 500 total columns and multiple long columns within the limitations for long columns set by the database platform. Check with the database vendor for restrictions on the number of long columns allowed for the platform.

When you export all records using EXPORT\*, PeopleSoft Data Mover orders the records alphabetically (with the exception of PSLOCK, which is the last record exported). After each record, PeopleSoft Data Mover indicates how many records remain. After all the tables are exported, then the views are exported.

---

**Warning!** The WHERE clause, when used in this command, supports only US-ASCII (seven-bit ASCII) values. Characters beyond this range can produce errors in the export file.

---

## Parameters

LOG, NO COMMIT, NO DATA, NO TRACE, NO VIEW, and OUTPUT.

---

**Note:** SET NO VIEW is only valid with EXPORT \*.

---

**Note:** If SET OUTPUT is not used, PeopleSoft Data Mover writes to the default file name, DATAMOVE.DAT.

---

## Example

To export a single record, use an EXPORT command for the specific record. For example:

```
EXPORT PS_JOB;
```

---

**Note:** When specifying a particular record in the EXPORT command (as shown in the previous example), the specified record must be a table, not a view.

---

To export all PeopleSoft records, including views, enter

```
EXPORT *;
```

## IMPORT

### Syntax

```
IMPORT {record | *} [IGNORE_DUPS] [AS new_table_name] [WHERE conditions];
```

### Description

The IMPORT command:

- creates database spaces.
- creates nonexistent tables and indexes.
- appends non-duplicate rows to records.
- creates views if the export file was created using EXPORT \* and imported using IMPORT \*.

---

**Warning!** All duplicate row-checking depends on the existence of a unique index. If no unique indexes are created before loading the data, there is a potential for duplicate data.

---

In the IMPORT statement, the AS clause is only valid if you specify a table name.

Using \* with AS or WHERE is allowed in cases where the imported data file consists *only* of a single table. For example,

```
IMPORT * AS table_name
```

If the data file consists of the more than one table when using \* AS or WHERE, the system returns the following error message:

Error: The Input File *file\_name* contains *number\_of\_records* records.

The table name that you specify immediately after the AS command modifier must not exceed 18 characters (including the *ps\_* prefix). If you do specify a table\_name that exceeds 18 characters, the following error appears: *Error: Unable to process create statement.*

See [WHERE](#).

Records defined using IMPORT can have a maximum of 500 columns with multiple long columns. The number of long columns allowed is determined by the limitations for long columns set by the database

platform. Refer to your database vendor documentation for restrictions on the number of long columns allowed for the platform.

There are two variations of IMPORT that you can use:

- REPLACE\_ALL
- REPLACE\_DATA

## Parameters

All except OUTPUT.

INPUT is a required parameter.

---

**Note:** IGNORE\_DUPS is only valid in bootstrap mode.

---

## Example

To import a single record from an export file, use an IMPORT command for that record. For example:

```
SET INPUT file_name;
IMPORT PS_JOB;
```

To import all PeopleSoft records from an export file, including views, enter:

```
SET INPUT file_name;
IMPORT *;
```

## Globalization Considerations

PeopleSoft Data Mover offers a base-language-independent method for moving application data between databases. PeopleSoft Data Mover loads a single DAT file, detects the target database base language, and inserts the data into the correct base or related language table.

If Oracle provides a software fix, you don't need to swap the base language before importing it into a database with a different base language. For example, suppose that a fix is sent with the base language English (ENG) and the related language Japanese (JAP). In this case, you can import this file directly into a database where the base language is JAP and the related language is ENG.

Upon EXPORT, the system adds the LANGUAGE\_CD (language code) to the generated DAT file. For example:

```
SET BASE_LANGUAGE ENG
```

Then, when you use the IMPORT command to import the generated DAT file, the system detects the LANGUAGE\_CD in the DAT file and compares it with the LANGUAGE\_CD in the target database to determine how to swap the base language and related language tables.

---

**Note:** Base language is the database base language. It can be any PeopleSoft-supported language.

---

Consider the following points when running the IMPORT command:

- This feature is enabled whenever you import a DAT file.

- Running the IMPORT command may have an unavoidable adverse affect on performance.

## Related Links

[REPLACE\\_ALL](#)

[REPLACE\\_DATA](#)

## REM, REMARK, and --

### Syntax

```
REM comments; REMARK comments; -- comments
```

### Description

Each of these three command variations indicates explanatory text in a PeopleSoft Data Mover script.

### Example

Here are three examples demonstrating the use of each:

```
REM This example demonstrates the use of the REM command to set off script
  comments.
  These statements can span multiple lines and must be terminated with a valid
  delimiter;
REMARK The REMARK command variation has the same restrictions as REM
/
-- This example demonstrates the use of two dashes to denote script
-- comments. No delimiters are required, but statements can not
-- exceed one line without using another double-dash.
```

When using a double hyphen (--), as in the third example, you need at least one space after the double hyphen, before the start of the actual text of the comment. Otherwise, you receive a syntax error.

When used in conjunction with a comment prefixed by REM or REMARK, the forward-slash delimiter (/) should be *by itself* on the last line of that comment. In such cases, instead of using a forward-slash (/), you can also use a semicolon (;) by itself on this last line. The forward slash (/) can also be used by itself without a REM or REMARK statement, in lieu of blank lines, which are also allowed in a script.

## RENAME

### Syntax

```
RENAME {RECORD record | FIELD {field | record.field}} AS new_name;
```

### Description

Renames a PeopleSoft record, a field in one record, or a field in all records.

---

**Note:** This command is not available in bootstrap mode.

---

---

**Warning!** Using RENAME only modifies a definition in the PeopleSoft tables. To write the record and field change to the system tables, you must use Application Designer to modify the affected definitions.

---

To rename a record field, you must qualify the original name of the field with the record name. If you don't qualify the record name, PeopleSoft Data Mover attempts to globally change the field name in all records.

Renaming a record field is only possible through PeopleSoft Data Mover.

To rename a record field:

1. Perform the rename in PeopleSoft Data Mover.

For example:

```
RENAME FIELD RECORD.FIELD AS NEWFIELD; COMMIT;
```

2. In Application Designer, create a project that includes the record that contains the field that you renamed, and save the project.

In the case of a subrecord field rename, the subrecord along with *all* tables that contain that subrecord must be inserted into the project.

3. Select Build, Settings.
  - Select the Alter tab.
  - Select **Adds and Renames**.
  - Clear **Changes and Deletes**.

---

**Note:** Drop column and change column length do not apply.

---

- Select the Scripts tab and select output settings.
  - Specify an output file and click OK.
4. Select Build, Project.
    - Select Alter Tables (Create Indexes is selected by default).
    - Click **Build**.
    - Click **Yes** to continue the build process.

5. Run the generated SQL script using the query tool.

This adds the new field to the tables within the project.

---

**Note:** For subrecord field renames *only*, data is not automatically migrated from the old field to the new field. You will need to migrate this data manually.

---

To remove the old field from the tables:

1. In Application Designer, open the project that you created using the preceding steps.
  - Select **Build > Settings**.
  - Select the **Alter** tab.
  - Select **Drop column if data present**.
  - Select **Deletes**.
  - Clear **Adds and Renames**.
  - Select the Scripts tab.
  - Give the output file a different name and click OK.
  
2. Select Build, Project.
  - Select Alter Tables (Create Indexes is automatically selected).
  - Click **Build**.
  - Click **Yes** to continue the build process.

3. Run the generated SQL script using the query tool.

The old field should no longer appear on the tables included in the project.

## Parameters

LOG, NO COMMIT, and NO TRACE.

## Example

Here's an example of how to rename a record:

```
RENAME RECORD absence_hist AS absent_hist;
```

Here's an example of how to globally rename a field:

```
RENAME FIELD effdt AS currdate;
```

Here's an example of how to rename a recfield:

```
RENAME FIELD course_tbl.duration_days AS duration_d;
```

## REPLACE\_ALL

### Syntax

```
REPLACE_ALL {record | *} [AS new_table_name];
```

## Description

This is a variation of the IMPORT command. If a table already exists, use this command to drop the table and its indexes from the database. It then:

1. creates the table.
2. creates any triggers.
3. inserts data.
4. creates indexes.

In the REPLACE\_ALL statement, the AS clause is only valid if you specify a particular record. It is not valid and should not be used with REPLACE\_ALL \*.

The table name that you specify after the AS command modifier should not have more than 18 characters (including the *ps\_* prefix). Specifying a table name that is greater than 18 characters invokes the following error message: *Error: Unable to process create statement.*

---

**Note:** Records defined using REPLACE\_ALL can have a maximum of 500 total columns and multiple long columns within the limitations for long columns set by the database platform. Check with the database vendor for restrictions on the number of long columns allowed for the platform.

---

## Parameters

All except IGNORE\_DUPS and OUTPUT. INPUT is a required parameter.

## REPLACE\_DATA

### Syntax

```
REPLACE_DATA {record | *};
```

### Description

This command is a variation of the IMPORT command. Use it to delete data in existing tables and insert the corresponding data from the export file.

### Parameters

COMMIT, EXECUTE\_SQL, EXTRACT, INPUT, INSERT\_DATA\_ONCE, LOG, NO COMMIT, NO TRACE, NO VIEW, SIZING\_SET, SPACE, START, and VERSION. INPUT is a required parameter.

## REPLACE\_VIEW

### Syntax

```
REPLACE_VIEW {view | *};
```

## Description

Recreates one or all specified views in the database.

## Parameters

LOG, NO COMMIT, NO TRACE, and START.

---

**Note:** If you use REPLACE\_VIEW in bootstrap mode, the system automatically activates SET IGNORE ERROR. This enables PeopleSoft Data Mover to continue processing until all of the view definitions have been processed, and all errors have been written to the current .LOG file.

---

## RUN

### Syntax

```
RUN dms_file_name;
```

### Description

Runs a DMS file from within a script. The specified file can contain any supported SQL commands, PeopleSoft Data Mover commands, or SET statements, but it cannot contain any RUN commands.

The RUN command cannot contain a directory path. The RUN command uses the same directory as the current PeopleSoft Data Mover script in which RUN is used.

## SET

### Syntax

```
SET parameter_1; SET parameter_2; ... SET parameter_n;
```

### Description

The SET command, when combined with valid SET parameters, creates statements that establish the conditions under which PeopleSoft Data Mover runs a script.

A SET statement controls the processing environment for the commands in a script until another SET statement intervenes between commands. At that point, all SET parameters are reset to their default values.

### Example

```
SET LOG c:\temp\new.log
SET OUTPUT c:\temp\new.dat;
/
EXPORT absence_hist;
EXPORT employee_tbl
/
SET NO DATA
/
REMARK All other SET parameters will be reset to defaults at this point;
```

```
EXPORT bank_branch_tbl;
```

In the previous script, the specified log and output files (NEW.LOG and NEW.DAT) are used for the first two EXPORT commands. Then, because SET NO DATA interrupts the script commands, all other SET parameters are reset to their default values. So, for the third EXPORT and any subsequent PeopleSoft Data Mover or SQL commands, the log file used is the default log file, DATAMOVE.LOG, and the output file used is the default output file, DATAMOVE.DAT.

See [Using SET Parameters](#).

## SET BASE\_LANGUAGE

### Syntax

```
SET BASE_LANGUAGE current_language_code; SWAP_BASE_LANGUAGE recordname;
```

### Description

Use only when there is an error with any of the tables after the SWAP\_BASE\_LANGUAGE *new\_language\_code* command.

---

**Note:** Never run SET BASE\_LANGUAGE *current\_language\_code* and SWAP\_BASE\_LANGUAGE *recordname* commands before SWAP\_BASE\_LANGUAGE *new\_language\_code*.

---

## SET IGNORE\_IMPORT\_ERRORS

### Syntax

```
SET IGNORE_IMPORT_ERRORS;
```

### Description

Use this command in conjunction with IMPORT, REPLACE\_DATA or REPLACE\_ALL command.

If there is an import error, processing will continue until the end of the input file. Any records that failed to import will be shown in the Data Mover log. If the Data Mover script is run from the command line, the errors will be shown in the output.

---

**Note:** SET IGNORE\_IMPORT\_ERRORS is only valid in bootstrap mode.

---

### Example

Here is an example to ignore errors when importing import the entire file, when there are errors.

```
SET INPUT in.dat;
SET IGNORE_IMPORT_ERRORS;
IMPORT *;
```

## SET IGNORE\_SPLCHARS

Use this command to ensure that special character, such as colon, is not used as a bind variable, and carriage returns and spaces in a SQL string are not skipped and gets inserted into the database as it is written in the DMS script.

### Syntax

Use the syntax with ON option.

```
SET IGNORE_SPLCHARS ON;
```

### Example

When this example SQL string is run with ON option, the special character colon is retained as it is and the SQL runs to success.

```
SET LOG JOE_DMS.LOG;
SET IGNORE_SPLCHARS ON;
insert into PS_PTIASQLTXDFN select 'ONEROUTECONTROL3','0','GBL','
',TO_DATE('1900-01-01','YYYY-MM-DD'),'00.00.000','0',30,0,'PS',to_timestamp('2021
-02-1903.20.01.03','YYYY-MM-DD HH24.MI.SS.FF'),'0','CEO',TO_CLOB('SELECT RECNAME
,FIELDNAME ,EOCC_CRITERIA_SYM ,EOCC_VALUE_MATCH , EOCC_FIELD_TYPE FROM
PS_EOCC_CONFIG_CRT WHERE PNLGRPNAME=:1 AND MARKET = :2 AND SEQUENCE_NUMBER =
:3 AND EOCC_CONFIG_TYPE = :4
')from dual;
```

## SET COMMIT

### Syntax

```
Set COMMIT level;
```

### Description

Sets the commit level for inserting rows and not for DDL statements. If the level is set to 0, commits are only done when all rows for a record are inserted. Due to the expense of recompiling and rebinding after a commit, the default is 0.

---

**Note:** There are performance implications associated with the SET COMMIT command. For a large database with millions of rows, there is significant degradation in performance. However, for a small database, performance slows down somewhat. Run the SET COMMIT command only as necessary.

---

### Parameters

The default is to commit at the end of the record.

## Example

The following examples demonstrate how to use SET COMMIT in conjunction with SWAP\_BASE\_LANGUAGE:

```
Set COMMIT 2;
SWAP_BASE_LANGUAGE FRA;
```

or

```
Set COMMIT 2;
SET_BASE_LANGUAGE ENG;
SWAP_BASE_LANGUAGE MY_RECORD;
```

## SWAP\_BASE\_LANGUAGE

### Syntax

```
SWAP_BASE_LANGUAGE new_language_code;
```

or

```
SET_BASE_LANGUAGE current_language_code; SWAP_BASE_LANGUAGE recordname;
```

### Description

Installs any language other than English.

The command swaps all the language tables from PSRECDEFN. It gets all table names that contain related tables, and it swaps one table at a time. It copies the base table into the related table, updates the related record into the base table, and then deletes the related record from the related table.

If successful, the command updates PSOPTIONS SET LANGUAGE\_CD to the new base language.

Swapping an individual table (SET\_BASE\_LANGUAGE *current\_language\_code* and SWAP\_BASE\_LANGUAGE *recordname*) is used only when there is an error with any of the tables after the SWAP\_BASE\_LANGUAGE *new\_language\_code* command has been run.

---

**Note:** Never run a combination of SET\_BASE\_LANGUAGE *current\_language\_code* and SWAP\_BASE\_LANGUAGE *recordname* command before SWAP\_BASE\_LANGUAGE *new\_language\_code*.

---

### Example

To swap English for Canadian French, enter the following:

```
SWAP_BASE_LANGUAGE CFR
```

CFR is the new language code.

---

**Note:** During the initial installation, the Database Setup utility generates a script that automatically swaps the base language if, while in the Database Setup interface, you select a base language other than English.

---

## Using PeopleSoft Data Mover Command Modifiers

The following commands enable you to modify a PeopleSoft Data Mover command to limit its scope, rename the item being processed, or control error messaging.

### AS

#### Syntax

```
{IMPORT | REPLACE_ALL} record AS table_name;
```

#### Description

Changes the name of a record and then imports it. When using this modifier, keep the following points in mind:

- If used with an IMPORT, the record is not imported if the table name specified in the IMPORT command already exists in the database.
- When using the AS command modifier, you can specify either the record or table name for the record or table specified preceding the AS.

However, you must always specify the table name (not the record name) for the record or table specified following the AS. The name specified following the AS is the actual name that is used for the table to be created.

- This modifier is not supported for records containing trigger definitions.

#### Parameters

IMPORT and REPLACE\_ALL

#### Example

The following example imports a new record or table originally named PS\_JOB and creates it as PS\_PROCESS:

```
IMPORT job
  AS ps_process;
```

Also correct:

```
IMPORT ps_job
  AS ps_process;
```

Incorrect:

```
IMPORT ps_job
  AS process;
```

Incorrect:

```
IMPORT job
  AS process;
```

The last two examples are incorrect because process is specified, instead of ps\_process. This means that the table created is named PROCESS, but it should be named PS\_PROCESS to comply with the convention that all non-PeopleTools tables have the prefix PS\_.

The table name that you specify following the AS command modifier should not have more than 18 characters (including the ps\_ prefix). Specifying a table name that is greater than 18 characters invokes the following error message: *Error: Unable to process create statement.*

When you import a record in this way, it is only created in the system tables, not in the PeopleSoft tables. You must also create the record in the PeopleSoft tables, such as PSRECDEFN.

To create a table after running the IMPORT command:

1. Launch Application Designer.
2. Create or clone the new record.

Using the job and process example from the previous discussion, you would open JOB and then select File, Save As and rename the record to PROCESS.

---

**Note:** The PS\_ prefix does not appear in Application Designer.

---

3. Select Build, Current Object.
4. In the Build dialog box, select Create Tables under Build Options.

You may also want to make sure that all the appropriate options are set on the Build Settings tabs.

## IGNORE\_DUPS

### Syntax

```
SET IGNORE_DUPS; IMPORT {record | *};
```

### Description

Ignores duplicate-row error messages from the database. The IMPORT process continues despite any duplicate-rows errors in the output window and log file. When IGNORE\_DUPS is set, bulk loading, the ability to load more than one row at a time, is turned off. By default, bulk loading is on and inserts up to 100 rows into a table at a time. Because turning off bulk loading slows performance, you should use this feature only when required.

---

**Note:** SET IGNORE\_DUPS is only valid in bootstrap mode.

---

### Parameters

IMPORT

## UPDATE\_DUPS

### Syntax

```
SET UPDATE_DUPS; IMPORT {record | *};
```

### Description

On command, PeopleSoft Data Mover imports a new row and updates an existing row.

---

**Note:** This command is valid for both bootstrap mode and regular mode. In regular mode, if the table is identified as a language table, the system automatically resolves and swaps the base and related language tables.

---

See [IMPORT](#).

### Parameters

IMPORT.

## WHERE

### Syntax

```
Data Mover Command {record | *} WHEREcondition(s)[;var#1_type,_var#1_value,var#2_ty→  
pe, var#2_value,...var#n_type,var#n_value];
```

---

**Note:** In an EXPORT statement, the WHERE modifier must be on the same line as the EXPORT command.

---

### Description

Retrieves a partial set of rows from the data source. The data source could be a data file or the database. The syntax and conditions of a Data Mover WHERE clause are similar to a WHERE clause in SQL. For EXPORT, you can write the WHERE clause with comparison operands in-line or as bind variables. For IMPORT the WHERE clause only supports comparison operators as bind variables. Parentheses are not support in IMPORT. You can also use nested SELECT statements.

---

**Warning!** When comparing string or character values, use only US-ASCII (seven-bit ASCII) values. Characters beyond this range can produce errors in the export file.

---

### Parameters

EXPORT

IMPORT

## Example

Here's an example of a WHERE clause using both an inline operand and bind variables in an EXPORT script:

```
EXPORT JOB WHERE
  EFFDT > :1 AND
  HOURLY_RT > :2
  AND GRADE = 'ADV';DATE,1994-01-01,NUMBER,100;
```

There are no single or double quotation marks around the bind data, as they are not necessary, and dates are formatted as YYYY-MM-DD. The valid data types for binding are CHAR, NUMBER, DATE, TIME, DATETIME, LONG, and IMAGE. Not all database platforms support LONG or IMAGE data types in the WHERE clause, so you should not use WHERE clauses with these data types.

The following operators are supported in an import WHERE clause: =, <>, <, >, <=, >=, and simple uses of AND and OR. For example, in the following formula, if A, B, and C are true, or if D is true, or if E is true, then the whole statement is true

```
WHERE
  A = :1 AND B = :2 AND C = :3
  OR D = :4
  OR E = :5;NUMBER,10,NUMBER,20,NUMBER,30,NUMBER,0,NUMBER,1;
```

## Using SET Parameters

The following parameters can be appended to a SET command to create a valid SET statement.

## COMMIT

### Syntax

```
SET COMMIT #of_rows;
```

### Description

Sets the commit level only for inserting rows and not for DDL statements. If the level is set to 0, commits are only done when all rows for a record are inserted. Due to the expense of recompiling and rebinding after a commit, the default is 0.

### Parameters

IMPORT, REPLACE\_ALL, and REPLACE\_DATA.

## CREATE\_INDEX\_BEFORE\_DATA

### Syntax

```
SET CREATE_INDEX_BEFORE_DATA;
```

## Description

Creates the index before inserting rows into a record. The default method is to insert rows into a record and then create the index.

## Parameters

IMPORT and REPLACE\_ALL.

## DBSPACE

### Syntax

```
SET DBSPACE {old_dbname.old_spacename} AS {new_dbname.new_spacename};
```

### Description

The DBSPACE command is applicable only to PeopleSoft application databases installed with segmented tablespaces. It cannot be used with databases installed with universal tablespaces. See the *PeopleTools Installation Guide for DB2 for z/OS* for additional details.

The DBSPACE command is similar to the SPACE command, but it is designed to handle the combination of DBNAME.DDLSPACENAME. On DB2 UDB, the DBNAME or DDLSPACENAME alone is not necessarily unique. However, the combination of the two (DBNAME.DDLSPACENAME) provides a unique relationship. For example, DBSPACE would be needed in the following scenario:

```
PSFSDMO.HRAPP
PSHRDMO.HRAPP
PSPDMDMO.HRAPP
```

---

**Note:** This command is supported only on DB2 UDB for z/OS. You use this command in place of the SPACE command used on other platforms.

---

### Parameters

IMPORT and REPLACE\_ALL.

### Example

The wildcard (\*) character is permitted for the database name and space name parameters to apply to all values being processed for the specific parameter in which the wildcard character is used. The following are examples of using this command to achieve one of the following:

To change a specific DBNAME/DDLSPACENAME combination to a single new combination:

```
SET DBSPACE old_dbname.old_spacename AS new_dbname.new_spacename
```

To keep the current database name the same but change the specific space name to a new name:

```
SET DBSPACE *.old_spacename AS *.new_spacename
```

To keep the current space name the same, but change the specific database name to a new name:

```
SET DBSPACE old_dbname.* AS new_dbname.*
```

---

**Warning!** Because of the large number of objects delivered in the PeopleSoft logical databases, do not override all old database name or space name values to a single new database name or space name value when building a SYS or DMO database. However, this feature may be useful in working with smaller data files that contain a smaller number of objects.

---

For large databases, do not use the following commands:

```
SET DBSPACE *.* AS new_dbname.new_spacename
```

```
SET DBSPACE *.* AS *.new_spacename
```

```
SET DBSPACE *.* AS new_dbname.*
```

You can use multiple SET DBSPACE statements to override the space name in the .DAT file. This enables you to override multiple databases in the same section of the script. For example:

```
SET DBSPACE PSFSDMO.* AS MYFSDMO1.*;
SET DBSPACE PSFSDMOF.* AS MYFSDMO2.*;
SET DBSPACE PSFSDMOD.* AS MYFSDMO3.*;
SET DBSPACE PSFSDMOM.* AS MYFSDMO4.*;
```

## ENABLE\_DB2UTS

### Syntax

```
SET ENABLE_DB2UTS;
```

### Description

This command enables PeopleTools to support universal tablespaces for DB2 for z/OS during database installation. Use this only if you plan to use universal tablespaces. See the *PeopleTools Installation Guide for DB2 for z/OS* for additional details.

## DDL

### Syntax

```
SET DDL {RECORD
| INDEX | UNIQUE INDEX | SPACE} {object_name |
*} INPUT parm AS value;
```

---

**Note:** The object\_name is only available for the SPACE option, not the RECORD, INDEX, and UNIQUE INDEX. The RECORD, INDEX, and UNIQUE INDEX are available for the \*, not the object\_name.

---

### Description

Substitutes values for the parameters specified in the DDL template commands. Substitute the *parm* and *value* placeholders for an actual parameter and its value. If an asterisk is used instead of an object name, a SQL update on PSDDLDEFPARMS is performed on the parameter and value upon successful completion of the IMPORT or REPLACE\_ALL command that corresponds to the SET DDL statement.

## Parameters

IMPORT and REPLACE\_ALL.

## Example

Below are some examples of DDL template SET commands from a DB2 UDB import script:

```
SET DDL RECORD * INPUT dbname AS ps910dg0;
SET DDL INDEX * INPUT stogroup AS wps04sg;
SET DDL SPACE * INPUT stogroup AS wps04sg;
```

## EXECUTE\_SQL

### Syntax

```
SET EXECUTE_SQL
[AFTER] sql_statement;
```

### Description

Performs the SQL statement specified at the beginning of a transaction. Typically, this command is used to set up a specific cursor environment before PeopleSoft Data Mover begins processing. For example, in DB2 UDB, use this command to set the current setID, or for Oracle, use this command to designate a specific rollback segment.

This command doesn't run for DDL SQL statements. For example, in DB2 UDB, you cannot set the current setID before creating spaces, tables, indexes, or views.

### Parameters

IMPORT, REPLACE\_ALL, and REPLACE\_DATA.

## EXTRACT

### Syntax

```
SET EXTRACT {COMMAND
| DDL | INPUT | SPACE | OUTPUT file_name};
```

### Description

Extracts various types of information from an export file (the DAT file specified in the corresponding SET INPUT command that precedes the IMPORT or REPLACE ALL command) and writes this information to the user-defined output file specified in the SET EXTRACT OUTPUT *file\_name* statement.

---

**Note:** You must use SET EXTRACT OUTPUT before issuing any other SET EXTRACT statements.

---

EXTRACT INPUT writes out any statements from the DAT file that are associated with the tables being imported. EXTRACT DDL writes out any CREATE TABLE, CREATE INDEX, or CREATE UNIQUE

INDEX statements from the DAT file. EXTRACT COMMAND writes out the EXPORT statements from the DAT file.

When EXTRACT statements are issued, no SQL CREATE or INSERT statements are executed. The associated IMPORT or REPLACE\_ALL command is not actually executed, so no import is performed.

## Parameters

IMPORT and REPLACE\_ALL.

## IGNORE\_DUPS

### Syntax

```
SET IGNORE_DUPS;
```

### Description

Ignores duplicate-row error messages from the database; the IMPORT process continues despite any duplicate-row errors displayed in the output window and log file. You can set this command for the entire import script or by record, using IGNORE\_DUPS as a command modifier.

When IGNORE\_DUPS is set, bulk loading, the ability to load more than one row at a time, is turned off (to allow checking for duplicates, so that duplicate rows can be ignored or bypassed). By default, bulk loading is on and inserts many (100) rows into a table at a time. Because turning off bulk loading slows performance, use this feature only when required or by record.

See [IMPORT](#).

See [IGNORE\\_DUPS](#).

### Parameters

IMPORT.

---

**Note:** The command SET IGNORE\_DUPS is only valid in bootstrap mode. This prevents the loss of data during a PeopleSoft Data Mover import of a language table in regular mode.

---

## INPUT

### Syntax

```
SET INPUT file;
```

### Description

Specifies the name of the exported file to import; typically this file has a .DAT extension, though this is not a requirement. Because this statement is required to do an import, there is no default file.

If you don't specify a path for this file, PeopleSoft Data Mover searches for the file in the following locations in the order presented:

- It searches the Data Mover input directory as defined in PeopleSoft Configuration Manager on the Edit Profile, Common tab.
- If the input directory setting is blank (not set) on the Edit Profile, Common tab, PeopleSoft Data Mover searches the C:\TEMP directory.

## Parameters

IMPORT, REPLACE\_ALL, and REPLACE\_DATA.

## INSERT\_DATA\_ONCE

### Syntax

```
SET INSERT_DATA_ONCE record;
```

### Description

Skips (that is, bypasses importing) the specified record if there is already one or more rows in the table corresponding to that record. If the table is empty, only a single row is inserted.

### Parameters

IMPORT, REPLACE\_ALL, and REPLACE\_DATA.

## LOG

### Syntax

```
SET LOG file;
```

---

**Note:** You must specify a file name for the SET LOG statement or else a log file is not created. If you do not want to specify a log file name, omit the SET LOG statement completely.

---

### Description

Specifies a user-defined file name for the log file that is created when running a PeopleSoft Data Mover script or command. If the SET LOG statement is omitted completely, a default log file is created with the name DATAMOVE.LOG. PeopleSoft Data Mover writes this DATAMOVE.LOG file to the default log directory, which is *DM\_HOME*\log.

The system uses the PeopleSoft Data Mover log directory specified on the Edit Profile, Common tab in PeopleSoft Configuration Manager. If the preceding setting is blank, the log file is written to C:\TEMP.

---

**Note:** If you use the SET LOG statement but do not specify a file name and path, PeopleSoft Data Mover writes the user-defined log file to the default log directory according to the same rule.

---

When checking the DATAMOVE.LOG file in a multi database environment, make sure you are examining the correct log file. At the top of the output file, verify the date and the database name.

```
Logging status in C:\TEMP\datamove.log
Started: Fri Mar 17 13:47:15 2001
Data Mover Release: 8.4
Database: HR702U40
...
Ended: Fri Mar 17 13:47:20 2001
Successful completion
```

### Parameters

All.

## NO DATA

### Syntax

```
SET NO DATA;
```

### Description

During an export, the NO DATA command prevents data from being exported. In an import, this command prevents data from being inserted.

### Parameters

EXPORT, IMPORT, and REPLACE\_ALL.

## NO INDEX

### Syntax

```
SET NO INDEX;
```

### Description

Prevents indexes from being created during an IMPORT or a REPLACE\_ALL command.

### Parameters

IMPORT and REPLACE\_ALL.

## NO RECORD

### Syntax

```
SET NO RECORD;
```

## Description

Prevents records from being created during an import.

## Parameters

IMPORT and REPLACE\_ALL.

## NO SPACE

### Syntax

```
SET NO SPACE;
```

### Description

Prevents tablespaces from being created. This is the default setting. You can use this statement to reset the default after executing a SET SPACE statement.

### Parameters

IMPORT and REPLACE\_ALL.

## NO TRACE

### Syntax

```
SET NO TRACE;
```

### Description

Sets the PeopleSoft trace flag (TraceSQL) in PeopleSoft Configuration Manager to *Off* for the commands that follow, until the next SET statement. This is the recommended method of executing commands. If SET NO TRACE is specified, then no trace file is created, even if you specify a trace file in PeopleSoft Configuration Manager on the Trace tab. Commands that you run *without* specifying SET NO TRACE do trace SQL, if SQL tracing is enabled in PeopleSoft Configuration Manager.

By default, the trace file is written to *DM\_HOME\trace*. The default trace file name is *datamover.trc*.

---

**Note:** This statement cannot be used with an INSERT command.

---

### Parameters

All.

## NO VIEW

### Syntax

```
SET NO VIEW;
```

### Description

Prevents views from being created.

### Parameters

EXPORT \* only, IMPORT \* only, REPLACE\_ALL \* only, and REPLACE\_DATA \* only.

## OUTPUT

### Syntax

```
SET OUTPUT file;
```

---

**Note:** You must specify a file name for the SET OUTPUT statement or else an output file is not created. If you do not want to specify an output file name, omit the SET OUTPUT statement completely.

---

### Description

Specifies a user-defined file name for the output file that is created by the corresponding EXPORT statement. If the SET OUTPUT statement is omitted completely, a default output file with the name DATAMOVE.DAT is created. The location that the output file is created is determined by the following:

- The system uses the PeopleSoft Data Mover output directory specified on the Edit Profiles, Common tab in PeopleSoft Configuration Manager.
- If the previous setting is blank, the output file is created in the C:\TEMP directory.

---

**Note:** If you use the SET OUTPUT statement but do not specify a file name and path, PeopleSoft Data Mover writes the user-defined output file to the default output directory.

---

### Parameters

EXPORT.

## OUTPUTDb2DBDDL

### Syntax

```
SET OutputDb2DBDDL file;
```

## Example

This is the example:

```
SET OutputDb2DBDDL C:\temp\DB_DDL_only.txt;
```

## Description

Specifies the path and file name for the script that will contain extracted CREATE DATABASE DDL statements.

---

**Note:** The DDL scripts will only be generated for PeopleSoft Db2 databases for which Universal Tablespace support has been enabled.

---

Review the sample script in the example section of SET Db2UTSDDL topic.

## OUTPUTDb2UTSDDL

### Syntax

```
SET OUTPUTDb2UTSDDL file;
```

### Example

This is the example:

```
SET OUTPUTDb2UTSDDL C:\temp\UTS_DDL_only.txt;;
```

### Description

Specifies the path and file name of the script that will contain extracted CREATE TABLESPACE (UTS) DDL statements.

---

**Note:** The DDL scripts will only be generated for PeopleSoft Db2 databases for which Universal Tablespace support has been enabled.

---

Review the sample script in the example section of SET Db2UTSDDL topic.

## SET Db2DBDDL

### Syntax

```
SET Db2DBDDL;
```

### Description

Specifies the Data Mover to write CREATE DATABASE DDL to the script identified by OutputDb2DBDDL.

SET NO RECORD and SET NO INDEX continues to work as expected.

Review the sample script in the example section of SET Db2UTSDDL topic.

---

**Note:** The DDL scripts will only be generated for PeopleSoft Db2 databases for which Universal Tablespace support has been enabled.

---

## SET Db2UTSDDL

### Syntax

```
SET Db2UTSDDL;
```

### Description

Specifies the Data Mover to write CREATE TABLESPACE (UTS) DDL to the script identified by OutputDb2UTSDDL.

SET NO RECORD and SET NO INDEX continues to work as expected.

---

**Note:** The DDL scripts will only be generated for PeopleSoft Db2 databases for which Universal Tablespace support has been enabled.

---

### Example

The following is the sample Data Mover scripts for OutputDb2DBDDL, OutputDb2UTSDDL, Db2DBDDL, and Db2UTSDDL.

---

**Note:** SET ENABLE DB2UTS and SET EXTRACT DDL statements are prerequisites to generate Db2 database and UTS DDLs using SET Db2DBDDL and SET Db2UTSDDL statements respectively.

---

```
SET LOG c:\temp\ptengs1.log;
SET INPUT C:\PT860P02B_2211160502-retail\DATA\ptengs.db;
SET OutputDb2DBDDL C:\temp\DB_DDL_only.txt;
SET OutputDb2UTSDDL C:\temp\UTS_DDL_only.txt;
SET OUTPUT C:\temp\table_and_indexDDL.txt;
SET EXECUTE_SQL SET CURRENT SQLID = 'Q8602D7P';
....etc....
REM uncomment the following line to enable UTS ;
SET ENABLE_DB2UTS;
SET Db2DBDDL;
SET Db2UTSDDL;
....etc....
SET EXTRACT DDL;
IMPORT *;
```

## SIZING SET

### Syntax

```
SET SIZING_SET n;
```

## Description

Specifies the sizing set number as defined on the DDL Model Defaults page. The default is 0. To use this parameter, the specified sizing set must be defined in the export file.

See *System and Server Administration*.

## Parameters

IMPORT and REPLACE\_ALL.

## SPACE

### Syntax

```
SET SPACE old
spcname AS new_spcname;
```

### Description

Use for all operating systems other than z/OS.

Renames the default space names to customized space names. To name all record default space names to a single space name, substitute \* for a space name.

### Parameters

IMPORT and REPLACE\_ALL.

### Example

```
SET SPACE * AS PS;
```

## START

### Syntax

```
SET START [AFTER] record;
```

### Description

Designates where in the export file to start the import process. The default is to start at the beginning of the file. To start immediately after a particular PeopleSoft record in the file, use SET START AFTER. This SET statement is useful for restarting a script after an error.

If the AFTER parameter is omitted, the import process starts at the record that is specified in the SET START statement. If the AFTER parameter is specified, the import process starts after the record specified in the SET START statement.

---

**Note:** If the same record name appears multiple times in the same DAT file, the SET START AFTER command begins after the last occurrence of the record name in the DAT file.

---

When you use the SET START command with REPLACE\_VIEW and no DAT file specified, you designate at which (or after which) view in the database to start. Views are created in alphabetical order.

## Parameters

IMPORT, REPLACE\_ALL, REPLACE\_DATA and REPLACE\_VIEW.

## STATISTICS

### Syntax

```
SET STATISTICS  
{ ON | OFF };
```

### Description

Sets UPDATE STATISTICS to on or off. The default value is on. Set the value to off if you do not want to update statistics after an IMPORT. This command works only in bootstrap mode.

### Parameters

IMPORT and REPLACE\_ALL.

## UNICODE

### Syntax

```
SET UNICODE {  
ON | OFF }
```

### Description

This command is recommended for use in bootstrap mode for an initial database load. It specifies whether the database is Unicode or non-Unicode.

---

**Warning!** If the database is already fully loaded, DO NOT use this command because it could result in the wrong value ENABLE\_UNICODE flag being set on the PSSTATUS table.

---

### Parameters

IMPORT and REPLACE\_ALL.

## VERSION

### Syntax

```
SET VERSION sql_table.column condition;
```

### Description

Verifies the version of the database for importing.

### Parameters

IMPORT, REPLACE\_ALL and REPLACE\_DATA.

### Example

Suppose that you state the following:

```
SET VERSION PSLOCK.TOOLSREL="8.4"
```

PeopleSoft Data Mover verifies that the TOOLSREL column in PSLOCK equals 8.4. This avoids importing an export file into the wrong database. Use the SQL table name to indicate which PeopleSoft record to check.

---

## Using Script Examples

This section provides several example script files. Review these scripts to see how you can use PeopleSoft Data Mover to accomplish various tasks.

## Exporting Databases

### Description

This example shows how to export a database.

### Example

```
SET OUTPUT c:\temp\pt.dat;  
SET LOG c:\temp\pt.log;  
EXPORT *;
```

## Building Databases

### Description

This example shows how to build a database.

## Example

```

set log c:\temp\hcengd.log;
set input c:\HRDMO\data\hcengd.db;
set no view;
set no space;
set no trace;
import *;
update PSLOCK set OWNERID = <OWNER_ID>;
update PSOPRDEFN set ACCESSID = <ACCESS_ID>, ACCESSPSWD = <ACCESS_ID_PSWD>,
  PTOPERPSWDV2= '0000000000000000' where OPRTYPE = 0;
update PSACCESSPROFILE set STM_ACCESS_ID = <ACCESS_ID>, STM_ACCESS_PSWD = <ACCESS_I⇒
D_PSWD>,
  VERSION = 0, ENCRYPTED = 0;
set log c:\temp\grant.log;
encrypt_password *;

```

Then run the resetpswd.dms data mover script from the PS\_HOME/scripts directory.

## Recreating All Views

### Description

This example shows how to recreate all views.

### Example

```

SET LOG c:\temp\view.log;
REPLACE_VIEW *;

```

## Importing with REPLACE\_ALL with a Commit Level

### Description

This example shows how to import with REPLACE\_ALL with a commit level.

### Example

```

SET INPUT c:\ptdvl\bin\exp2.dat;
SET LOG c:\ptdvl\bin\exp2.log;
SET COMMIT 2;
REPLACE_ALL employee_review;
REPLACE_ALL course_tbl
  WHERE days_duration = :1 AND course_type > :2;number,1,char,C;
REPLACE_ALL absence_hist
  WHERE return_dt > :1;date,1988-01-01;

```

## Combining SQL Commands and IMPORT

### Description

This example shows how to combine SQL commands and IMPORT.

## Example

```
SET INPUT c:\ptdvl\bin\exp2.dat;
SET COMMIT 10;
SET START AFTER course_tbl;
SET IGNORE_DUPS;
DELETE FROM ps_absence_hist WHERE emplid = '8001';
IMPORT *;
```

