

---

# PeopleTools 8.62: PS/nVision

---

**April 2025**

PeopleTools 8.62: PS/nVision  
Copyright © 1988, 2025, Oracle and/or its affiliates.

This software and related documentation are provided under a license agreement containing restrictions on use and disclosure and are protected by intellectual property laws. Except as expressly permitted in your license agreement or allowed by law, you may not use, copy, reproduce, translate, broadcast, modify, license, transmit, distribute, exhibit, perform, publish, or display any part, in any form, or by any means. Reverse engineering, disassembly, or decompilation of this software, unless required by law for interoperability, is prohibited.

The information contained herein is subject to change without notice and is not warranted to be error-free. If you find any errors, please report them to us in writing.

If this is software, software documentation, data (as defined in the Federal Acquisition Regulation), or related documentation that is delivered to the U.S. Government or anyone licensing it on behalf of the U.S. Government, then the following notice is applicable:

U.S. GOVERNMENT END USERS: Oracle programs (including any operating system, integrated software, any programs embedded, installed, or activated on delivered hardware, and modifications of such programs) and Oracle computer documentation or other Oracle data delivered to or accessed by U.S. Government end users are "commercial computer software," "commercial computer software documentation," or "limited rights data" pursuant to the applicable Federal Acquisition Regulation and agency-specific supplemental regulations. As such, the use, reproduction, duplication, release, display, disclosure, modification, preparation of derivative works, and/or adaptation of i) Oracle programs (including any operating system, integrated software, any programs embedded, installed, or activated on delivered hardware, and modifications of such programs), ii) Oracle computer documentation and/or iii) other Oracle data, is subject to the rights and limitations specified in the license contained in the applicable contract. The terms governing the U.S. Government's use of Oracle cloud services are defined by the applicable contract for such services. No other rights are granted to the U.S. Government.

This software or hardware is developed for general use in a variety of information management applications. It is not developed or intended for use in any inherently dangerous applications, including applications that may create a risk of personal injury. If you use this software or hardware in dangerous applications, then you shall be responsible to take all appropriate fail-safe, backup, redundancy, and other measures to ensure its safe use. Oracle Corporation and its affiliates disclaim any liability for any damages caused by use of this software or hardware in dangerous applications.

Oracle®, Java, MySQL, and NetSuite are registered trademarks of Oracle and/or its affiliates. Other names may be trademarks of their respective owners.

Intel and Intel Inside are trademarks or registered trademarks of Intel Corporation. All SPARC trademarks are used under license and are trademarks or registered trademarks of SPARC International, Inc. AMD, Epyc, and the AMD logo are trademarks or registered trademarks of Advanced Micro Devices. UNIX is a registered trademark of The Open Group.

This software or hardware and documentation may provide access to or information about content, products, and services from third parties. Oracle Corporation and its affiliates are not responsible for and expressly disclaim all warranties of any kind with respect to third-party content, products, and services unless otherwise set forth in an applicable agreement between you and Oracle. Oracle Corporation and its affiliates will not be responsible for any loss, costs, or damages incurred due to your access to or use of third-party content, products, or services, except as set forth in an applicable agreement between you and Oracle.

## **Documentation Accessibility**

For information about Oracle's commitment to accessibility, visit the Oracle Accessibility Program website at <https://docs.oracle.com/pls/topic/lookup?ctx=acc&id=docacc>.

## **Access to Oracle Support**

Oracle customers that have purchased support have access to electronic support through My Oracle Support. For information, visit <https://docs.oracle.com/pls/topic/lookup?ctx=acc&id=info> or visit <https://docs.oracle.com/pls/topic/lookup?ctx=acc&id=trs> if you are hearing impaired.

# Contents

- Preface: Preface.....ix**
- Understanding the PeopleSoft Online Help and PeopleBooks..... ix
- Hosted PeopleSoft Online Help..... ix
- Locally Installed PeopleSoft Online Help..... ix
- Downloadable PeopleBook PDF Files.....ix
- Common Help Documentation.....ix
- Field and Control Definitions..... x
- Typographical Conventions..... x
- ISO Country and Currency Codes..... xi
- Region and Industry Identifiers..... xi
- Translations and Embedded Help..... xii
- Using and Managing the PeopleSoft Online Help..... xii
- PeopleTools Related Links..... xii
- Contact Us..... xii
- Follow Us..... xiii
- Chapter 1: Getting Started with PS/nVision..... 15**
- PS/nVision Overview..... 15
- PS/nVision Implementation..... 18
- Chapter 2: Understanding PS/nVision.....21**
- Accessing PS/nVision..... 21
- Creating Report Instances and Layouts..... 22
- Layout and Instance Example..... 23
- Using Microsoft Excel Features..... 24
- Inserting Formulas..... 24
- Inserting and Formatting Text..... 25
- Chapter 3: Using Layouts..... 27**
- Understanding Layouts..... 27
- Converting Existing Layouts and Reports to OpenXML Format..... 27
- Comparing Tabular Layouts, Matrix Layouts, and QueryLink..... 29
- Working With Layouts..... 30
- Specifying Criteria..... 31
- Using nPlosion..... 31
- Setting a TimeSpan..... 31
- Specifying SetIDs and Business Units..... 32
- Entering Effective Dates..... 32
- Enter Comments in OpenXML Mode..... 32
- Creating Layouts..... 32
- Planning a Layout..... 32
- Opening an Existing Layout..... 33
- Creating a New Layout..... 33
- Saving a Spreadsheet as a Layout..... 34
- Choosing a Layout Type..... 34
- Specifying a Layout Definition..... 36
- Chapter 4: Creating Tabular Layouts..... 41**
- Understanding Tabular Layouts..... 41
- Creating Tabular Layouts..... 41

|   |           |
|---|-----------|
| Mapping Tabular Layout Columns.....                         | 42        |
| Defining Layout Options.....                                | 43        |
| Creating Report Titles.....                                 | 47        |
| <b>Chapter 5: Creating Matrix Layouts.....</b>              | <b>49</b> |
| Understanding Matrix Layouts.....                           | 49        |
| Common Elements Used in This Product Documentation.....     | 50        |
| Matrix Layout Components.....                               | 50        |
| Criteria Types.....   | 51        |
| Criteria Inheritance Rules.....                             | 53        |
| Criteria Usage.....   | 54        |
| Creating Matrix Layouts.....                                | 57        |
| Defining Matrix Layout Criteria.....                        | 58        |
| Defining Query or Ledger Criteria.....                      | 59        |
| Selecting Ledger Criteria.....                              | 60        |
| Choosing Query Criteria.....                                | 61        |
| Applying Filter Criteria.....                               | 62        |
| Understanding Filter Criteria.....                          | 63        |
| Selecting Filter Criteria Options.....                      | 63        |
| Adding Field and Tree Node Values to Filter Criteria.....   | 66        |
| Adding Field and Detail Values to Filter Criteria.....      | 68        |
| Adding Criteria Values.....                                 | 70        |
| Removing Fields and Values from Filter Criteria.....        | 70        |
| Using Label Criteria.....                                   | 70        |
| Adding Variable Criteria.....                               | 72        |
| Understanding Variable Criteria.....                        | 72        |
| Defining Variable Criteria.....                             | 76        |
| Defining String Criteria.....                               | 77        |
| <b>Chapter 6: Creating Ledger-Based Matrix Layouts.....</b> | <b>81</b> |
| Understanding Ledger-Based Matrix Layouts.....              | 81        |
| Defining Ledger Criteria.....                               | 81        |
| Using TimeSpans.....  | 83        |
| Using Filter Criteria.....                                  | 83        |
| Using Summary ChartField Nodes.....                         | 84        |
| Adding Label Criteria.....                                  | 84        |
| Using nPlosion.....   | 84        |
| <b>Chapter 7: Defining Report Scopes.....</b>               | <b>87</b> |
| Understanding Report Scopes.....                            | 87        |
| Multiple Scope Fields.....                                  | 87        |
| Defining Scopes.....  | 88        |
| Creating New Scopes.....                                    | 88        |
| Selecting Scope Fields.....                                 | 90        |
| Choosing Tree Levels and Tree Nodes.....                    | 92        |
| Working With Existing Scopes.....                           | 93        |
| Opening Existing Scopes.....                                | 93        |
| Deleting Existing Scopes.....                               | 94        |
| Adding Fields and Values to Existing Scopes.....            | 94        |
| Removing Fields and Values from Existing Scopes.....        | 95        |
| Using Scope-Related Variables.....                          | 96        |
| <b>Chapter 8: Using DrillDown.....</b>                      | <b>97</b> |
| Using DrillDown.....  | 97        |
| Using Inherited Criteria.....                               | 99        |

|   |            |
|---|------------|
| Using DrillDown Instances.....                                      | 100        |
| Using DrillDown Navigation.....                                     | 100        |
| Using DrillDown Layout Formats.....                                 | 102        |
| DrillDown and Summary Ledger.....                                   | 102        |
| DrillDown and Queries.....  | 103        |
| Naming Conventions.....   | 103        |
| DrillDown Layout Directory.....                                     | 104        |
| <b>Chapter 9: Using nPlosion.....</b>                               | <b>105</b> |
| Understanding nPlosion.....   | 105        |
| Defining nPlosion Criteria.....                                     | 106        |
| Defining nPlosion Defaults.....                                     | 107        |
| Enabling nPlosion for Specific Situations.....                      | 109        |
| Using Style Sheets with nPlosion Layouts.....                       | 110        |
| Understanding Style Sheets.....                                     | 110        |
| Using the Style Sheet Wizard.....                                   | 111        |
| Opening the Style Sheet Wizard.....                                 | 111        |
| Modifying a Style.....  | 112        |
| Applying Styles to a Report Layout.....                             | 113        |
| Modifying Styles Using the Excel Menu Bar.....                      | 113        |
| Configuring the Style Sheet Directory Location.....                 | 114        |
| Using Multiple Chart-field nPlosion.....                            | 115        |
| Understanding Multiple Chart-field nPlosion.....                    | 115        |
| Defining Multiple Chart-field nPlosion.....                         | 116        |
| Enabling Multiple Chart-field nPlosion for Specific Situations..... | 118        |
| <b>Chapter 10: Using Advanced PS/nVision Options.....</b>           | <b>121</b> |
| Enhancing Report Layouts.....                                       | 121        |
| Setting PS/nVision Options.....                                     | 121        |
| Creating Virtual Ledgers.....                                       | 123        |
| Using PS/nVision-Defined Names.....                                 | 124        |
| Formatting Dates.....   | 130        |
| Setting Trace Files.....  | 131        |
| Enabling Trace Files.....   | 131        |
| Tracing Levels.....   | 132        |
| Viewing Trace Files.....  | 133        |
| Dismissing Unattended Dialogs.....                                  | 134        |
| <b>Chapter 11: Using PeopleCode APIs for Excel.....</b>             | <b>135</b> |
| Understanding PeopleCode APIs for Excel.....                        | 135        |
| Using PeopleCode APIs for Excel.....                                | 135        |
| Testing PeopleCode APIs.....  | 136        |
| Pre-requisites for Using the SpreadSheet API Sample Page.....       | 136        |
| Using the SpreadSheet API Sample Page.....                          | 137        |
| Generating Excel Output File.....                                   | 138        |
| <b>Chapter 12: Personalizing PS/nVision.....</b>                    | <b>141</b> |
| Understanding PS/nVision Personalization.....                       | 141        |
| Using Configuration Manager.....                                    | 141        |
| Changing Configuration Manager Settings.....                        | 141        |
| Specifying the AsofDateForLabels Option.....                        | 145        |
| Defining Directory Paths.....                                       | 150        |
| Specifying Formatting Options.....                                  | 151        |
| Personalizing NVSUSER.XLS.....                                      | 151        |
| Customizing Buttons.....  | 152        |

|   |            |
|---|------------|
| Adding Buttons With the Button Wizard.....                          | 152        |
| Customizing Menus.....  | 153        |
| Making Microsoft Excel Row and Column Indicators Visible.....       | 154        |
| Changing the Toolbar.....   | 154        |
| Setting Report Preferences.....                                     | 155        |
| Setting Report Request Preferences.....                             | 155        |
| Copying a User’s Report Request Preferences.....                    | 156        |
| Customizing the Report Instance View.....                           | 157        |
| Customizing Delivered Visual Basic Application Wizards.....         | 157        |
| Changing the Startup File.....                                      | 158        |
| Using PS/nVision API Functions.....                                 | 159        |
| <b>Chapter 13: Using the PS/nVision Visual Basic Interface.....</b> | <b>165</b> |
| Using Designer Object Methods.....                                  | 165        |
| Designer Object Methods.....  | 165        |
| Connect.....  | 165        |
| Disconnect.....   | 166        |
| ResetEnvironment.....   | 166        |
| StartMenu.....  | 166        |
| OnWindow.....   | 166        |
| OpenFile.....   | 166        |
| OpenLayout.....   | 167        |
| NewLayout.....  | 167        |
| SaveAsLayout.....   | 167        |
| DefineLayout.....   | 167        |
| LayoutOptions.....  | 168        |
| ReportRequest.....  | 168        |
| RunCurrent.....   | 168        |
| RunReport.....  | 168        |
| Options.....  | 169        |
| PerfOpts.....   | 169        |
| OpenScope.....  | 169        |
| ScopeDefn.....  | 169        |
| DrillDown.....  | 170        |
| DrillLayout.....  | 170        |
| AutoDrill.....  | 170        |
| ReDrill.....  | 170        |
| DrillQuery.....   | 171        |
| JumpBack.....   | 171        |
| RunQuery.....   | 171        |
| Using Session Object Methods.....                                   | 171        |
| Session Object Methods.....   | 172        |
| DBType.....   | 172        |
| DBName.....   | 172        |
| ToolsRelDB.....   | 172        |
| ServerName.....   | 172        |
| OprId.....  | 173        |
| TwoTier.....  | 173        |
| ShowWarnings.....   | 173        |
| AmountSql.....  | 173        |
| ReadConfig.....   | 174        |
| ReadConfigDir.....  | 174        |

|   |            |
|---|------------|
| Instance Hooks.....   | 175        |
| <b>Chapter 14: Setting Up PS/nVision Security.....</b>        | <b>179</b> |
| Securing PS/nVision Elements.....                             | 179        |
| Securing PS/nVision Menu Items.....                           | 179        |
| Securing Report Layouts.....                                  | 182        |
| Securing and Sharing Report Requests in PIA.....              | 182        |
| Securing and Sharing Report Requests in Windows Clients.....  | 186        |
| Securing Reports.....   | 188        |
| Securing Report Distribution.....                             | 188        |
| Masking of Data in Reports.....                               | 189        |
| Implementing PS/nVision Ledger-Based Data Security.....       | 190        |
| Understanding PS/nVision Ledger-Based Data Security.....      | 190        |
| Using the Reporting View.....                                 | 190        |
| Using the Authorization Table.....                            | 192        |
| Using Ledger Reporting View Access.....                       | 192        |
| Restricting Ledger Access.....                                | 192        |
| Implementing PS/nVision Query-Based Data Security.....        | 193        |
| <b>Chapter 15: Tuning PS/nVision Performance.....</b>         | <b>195</b> |
| Understanding PS/nVision SQL.....                             | 195        |
| PS/nVision SQL Basics.....                                    | 195        |
| Tree Joins.....   | 195        |
| Combination Rules.....  | 196        |
| Capture of PS/nVision SQL.....                                | 197        |
| Assigning Ledger Tables.....                                  | 197        |
| Using Indexes and PS/nVision Tuning.....                      | 197        |
| Understanding Indexes.....                                    | 198        |
| Optimizers.....   | 198        |
| Filter Factors.....   | 198        |
| Index Matching.....   | 199        |
| Ledger Access Paths.....                                      | 200        |
| Access Path Analysis.....                                     | 200        |
| Index Suggestions.....  | 201        |
| Using Trees.....  | 202        |
| Understanding Trees and PS/nVision.....                       | 202        |
| Enhancing Tree Performance with SQL Techniques.....           | 203        |
| Setting Tree Performance Options.....                         | 206        |
| Understanding Restrictions on Tree Performance Options.....   | 209        |
| Optimizing Indexes With Dynamic Selectors.....                | 210        |
| Using Tree Tables.....  | 211        |
| PSTREEDEFN: Tree Definition.....                              | 211        |
| PSTREELEAF: Tree Leaf.....                                    | 212        |
| PSTREESELCTL: Tree Selection Control.....                     | 213        |
| PSTREESELECTnn: Tree Select Work-Size nn.....                 | 214        |
| PSTREESELNUM: Tree Selector Number.....                       | 214        |
| <b>Chapter 16: Running PS/nVision Reports on the Web.....</b> | <b>217</b> |
| Understanding PS/nVision Reporting on the Web.....            | 217        |
| Configuring PS/nVision on the Web.....                        | 218        |
| Configuring the Report Node.....                              | 218        |
| Creating Scope Definitions.....                               | 219        |
| Setting Up Report Requests.....                               | 221        |
| Creating Report Requests.....                                 | 222        |

|  |            |
|--|------------|
| Configuring Delivery Templates.....  | 223        |
| Configuring Report Request Template Options.....                                   | 226        |
| Using Portal Folders.....  | 226        |
| Copying Requests.....  | 228        |
| Setting Advanced Options.....  | 229        |
| Setting Query Prompts.....   | 230        |
| Submitting Report Requests.....  | 231        |
| Running Reports.....   | 232        |
| Setting Report Distribution.....   | 234        |
| Using Report Books.....  | 236        |
| Understanding Report Books.....  | 236        |
| Defining Report Books.....   | 237        |
| Running Report Books.....  | 239        |
| Selecting Type and Output Options.....   | 240        |
| Running Multiple Report Books.....   | 240        |
| Using the PS/nVision DrillDown on the Web.....                                     | 240        |
| Registering DrillDown Layouts.....   | 240        |
| Using DrillDown.....   | 241        |
| Running Specific PS/nVision Reports.....   | 247        |
| Using nVision Run API.....   | 247        |
| Using QUICKNVISION REST Service.....   | 248        |
| <b>Chapter 17: Running PS/nVision Reports in the Microsoft Windows Client.....</b> | <b>249</b> |
| Creating Report Requests.....  | 249        |
| Creating Requests.....   | 249        |
| Applying Scopes to Your Reports.....   | 257        |
| Opening Existing Report Requests.....  | 257        |
| Deleting Report Requests.....  | 258        |
| Running Reports.....   | 259        |
| Understanding Running Reports.....   | 259        |
| Running a Report from a Report Request.....  | 259        |
| Running a Report from the NVSUSER Home Page.....                                   | 260        |
| Working With Report Instances.....   | 260        |
| <b>Chapter 18: Distributing Reports in PS/nVision.....</b>                         | <b>263</b> |
| Understanding Report Distribution.....   | 263        |
| Distributing Reports for Scopes Based on Tree Nodes.....                           | 263        |
| Cloning Tree Node Table — Creating Record DEPT_NODE_TBL.....                       | 264        |
| Cloning Tree Node Page - Creating Page DEPT_NODE_TBL.....                          | 265        |
| Granting Access to Tree Node Pages.....  | 265        |
| Updating Tree Structures to Use the New Node Table and Node Page.....              | 266        |
| Populating Routing Information.....  | 267        |
| Linking Routing Information Into PS/nVision.....                                   | 268        |
| Distributing Reports for Scopes Based on Value Tables.....                         | 269        |

# Preface

---

## Understanding the PeopleSoft Online Help and PeopleBooks

The PeopleSoft Online Help is a website that enables you to view all help content for PeopleSoft applications and PeopleTools. The help provides standard navigation and full-text searching, as well as context-sensitive online help for PeopleSoft users.

### Hosted PeopleSoft Online Help

You can access the hosted PeopleSoft Online Help on the [Oracle Help Center](#). The hosted PeopleSoft Online Help is updated on a regular schedule, ensuring that you have access to the most current documentation. This reduces the need to view separate documentation posts for application maintenance on My Oracle Support. The hosted PeopleSoft Online Help is available in English only.

To configure the context-sensitive help for your PeopleSoft applications to use the Oracle Help Center, see [Configuring Context-Sensitive Help Using the Hosted Online Help Website](#).

### Locally Installed PeopleSoft Online Help

If you're setting up an on-premises PeopleSoft environment, and your organization has firewall restrictions that prevent you from using the hosted PeopleSoft Online Help, you can install the online help locally. Installable PeopleSoft Online Help is made available with selected PeopleSoft Update Images and with PeopleTools releases for on-premises installations, through the [Oracle Software Delivery Cloud](#).

Your installation documentation includes a chapter with instructions for how to install the online help for your business environment, and the documentation zip file may contain a README.txt file with additional installation instructions. See *PeopleSoft 9.2 Application Installation* for your database platform, "Installing PeopleSoft Online Help."

To configure the context-sensitive help for your PeopleSoft applications to use a locally installed online help website, see [Configuring Context-Sensitive Help Using a Locally Installed Online Help Website](#).

### Downloadable PeopleBook PDF Files

You can access downloadable PDF versions of the help content in the traditional PeopleBook format on the [Oracle Help Center](#). The content in the PeopleBook PDFs is the same as the content in the PeopleSoft Online Help, but it has a different structure and it does not include the interactive navigation features that are available in the online help.

### Common Help Documentation

Common help documentation contains information that applies to multiple applications. The two main types of common help are:

- Application Fundamentals

- Using PeopleSoft Applications

Most product families provide a set of application fundamentals help topics that discuss essential information about the setup and design of your system. This information applies to many or all applications in the PeopleSoft product family. Whether you are implementing a single application, some combination of applications within the product family, or the entire product family, you should be familiar with the contents of the appropriate application fundamentals help. They provide the starting points for fundamental implementation tasks.

In addition, the *PeopleTools: Applications User's Guide* introduces you to the various elements of the PeopleSoft Pure Internet Architecture. It also explains how to use the navigational hierarchy, components, and pages to perform basic functions as you navigate through the system. While your application or implementation may differ, the topics in this user's guide provide general information about using PeopleSoft applications.

## Field and Control Definitions

PeopleSoft documentation includes definitions for most fields and controls that appear on application pages. These definitions describe how to use a field or control, where populated values come from, the effects of selecting certain values, and so on. If a field or control is not defined, then it either requires no additional explanation or is documented in a common elements section earlier in the documentation. For example, the Date field rarely requires additional explanation and may not be defined in the documentation for some pages.

## Typographical Conventions

The following table describes the typographical conventions that are used in the online help.

| <b><i>Typographical Convention</i></b> | <b><i>Description</i></b>   |
|--|---|
| <b>Key+Key</b>                         | Indicates a key combination action. For example, a plus sign (+) between keys means that you must hold down the first key while you press the second key. For <b>Alt+W</b> , hold down the <b>Alt</b> key while you press the <b>W</b> key. |
| ... (ellipses)                         | Indicate that the preceding item or series can be repeated any number of times in PeopleCode syntax.  |
| { } (curly braces)                     | Indicate a choice between two options in PeopleCode syntax. Options are separated by a pipe ( ).  |
| [ ] (square brackets)                  | Indicate optional items in PeopleCode syntax.   |
| & (ampersand)                          | When placed before a parameter in PeopleCode syntax, an ampersand indicates that the parameter is an already instantiated object.<br><br>Ampersands also precede all PeopleCode variables.  |

| <b>Typographical Convention</b> | <b>Description</b>   |
|---------------------------------|--|
| ⇒                               | This continuation character has been inserted at the end of a line of code that has been wrapped at the page margin. The code should be viewed or entered as a single, continuous line of code without the continuation character. |

## ISO Country and Currency Codes

PeopleSoft Online Help topics use International Organization for Standardization (ISO) country and currency codes to identify country-specific information and monetary amounts.

ISO country codes may appear as country identifiers, and ISO currency codes may appear as currency identifiers in your PeopleSoft documentation. Reference to an ISO country code in your documentation does not imply that your application includes every ISO country code. The following example is a country-specific heading: "(FRA) Hiring an Employee."

The PeopleSoft Currency Code table (CURRENCY\_CD\_TBL) contains sample currency code data. The Currency Code table is based on ISO Standard 4217, "Codes for the representation of currencies," and also relies on ISO country codes in the Country table (COUNTRY\_TBL). The navigation to the pages where you maintain currency code and country information depends on which PeopleSoft applications you are using. To access the pages for maintaining the Currency Code and Country tables, consult the online help for your applications for more information.

## Region and Industry Identifiers

Information that applies only to a specific region or industry is preceded by a standard identifier in parentheses. This identifier typically appears at the beginning of a section heading, but it may also appear at the beginning of a note or other text.

Example of a region-specific heading: "(Latin America) Setting Up Depreciation"

### Region Identifiers

Regions are identified by the region name. The following region identifiers may appear in the PeopleSoft Online Help:

- Asia Pacific
- Europe
- Latin America
- North America

### Industry Identifiers

Industries are identified by the industry name or by an abbreviation for that industry. The following industry identifiers may appear in the PeopleSoft Online Help:

- USF (U.S. Federal)

- E&G (Education and Government)

## Translations and Embedded Help

PeopleSoft 9.2 software applications include translated embedded help. With the 9.2 release, PeopleSoft aligns with the other Oracle applications by focusing our translation efforts on embedded help. We are not planning to translate our traditional online help and PeopleBooks documentation. Instead we offer very direct translated help at crucial spots within our application through our embedded help widgets. Additionally, we have a one-to-one mapping of application and help translations, meaning that the software and embedded help translation footprint is identical—something we were never able to accomplish in the past.

---

## Using and Managing the PeopleSoft Online Help

Select About This Help in the left navigation panel on any page in the PeopleSoft Online Help to see information on the following topics:

- Using the PeopleSoft Online Help.
- Managing hosted Online Help.
- Managing locally installed PeopleSoft Online Help.

---

## PeopleTools Related Links

[PeopleTools 8.62 Home Page](#)

[PeopleSoft Search and Insights Home Page](#)

“PeopleTools Product/Feature PeopleBook Index” (Getting Started with PeopleTools)

[PeopleSoft Online Help](#)

[PeopleSoft Information Portal](#)

[PeopleSoft Spotlight Series](#)

[PeopleSoft Training and Certification | Oracle University](#)

[My Oracle Support](#)

[Oracle Help Center](#)

---

## Contact Us

Send your suggestions to [psoft-infodev\\_us@oracle.com](mailto:psoft-infodev_us@oracle.com).

Please include the applications update image or PeopleTools release that you’re using.

---

## Follow Us

| <i>Icon</i>   | <i>Link</i>  |
|---|--|
|  | <a href="#"><u>Watch PeopleSoft on YouTube</u></a>         |
|  | <a href="#"><u>Follow @PeopleSoft_Info on X.</u></a>       |
|  | <a href="#"><u>Read PeopleSoft Blogs</u></a>               |
|  | <a href="#"><u>Connect with PeopleSoft on LinkedIn</u></a> |



## Chapter 1

# Getting Started with PS/nVision

---

## PS/nVision Overview

PS/nVision retrieves information from your PeopleSoft database and places it into a Microsoft Excel spreadsheet, in a form that helps you see the big picture, explore details, and make decisions. You use familiar Excel commands to format and analyze the data. With PS/nVision, you spend your time analyzing results rather than summarizing data and entering it into a spreadsheet.

PS/nVision works within spreadsheets. You access PS/nVision features from a special PS/nVision menu within Microsoft Excel to create templates (layouts) for data retrieval. Once you create a report layout (XNV file), you can use it to format data automatically.

The PS/nVision interface is similar to a Web browser, with buttons and displays that can be customized. You can also create a custom front-end macro sheet for point-and-click access to reports and reporting functions.

PS/nVision selects data from your PeopleSoft database using ledgers, trees, and queries. Queries are useful for extracting data from sources other than ledgers, so you should be familiar with PeopleSoft Query concepts, especially query result sets, before working with PS/nVision. Also, tree data is used to limit the query results, so you should be familiar with nodes and detail values.

On the Web version, PS/nVision works closely with Process Scheduler and Distribution Agent and forms a report server with them in a Windows NT machine. When running and drilling a PS/nVision report, Process Scheduler is the bridge between nVision engine and PeopleSoft Pure Internet Architecture applications that launch nVision engine and communicate the report running status back to the applications. PS/nVision uses Distribution Agent to transfer the report instances between nVision file server and the report repository. The report repository servlet in the Web server enables users to access PS/nVision reports in Report Manager.

Similar to the Web version, on the UNIX version, the Process Scheduler is the bridge between nVision engine and PeopleSoft Pure Internet Architecture applications. On the UNIX version, the Process Scheduler should run on a UNIX machine.

PS/nVision works in three modes:

- OpenXML mode.
- Excel Automation mode.
- Cross Platform mode.

---

**Note:** On the Web version, the OpenXML, Excel Automation, and Cross Platform modes are mutually exclusive. Only one mode is in effect at any given time. On the UNIX version, Cross Platform mode is the only mode currently available.

---

## PS/nVision – OpenXML Mode

nVision uses the OpenXML mode on the batch server that uses Microsoft's OpenXML SDK to generate Excel-compatible documents.

---

**Note:** The OpenXML mode is the default mode in PeopleTools, and the default setting of the *UseExcelAutomationMode* flag in *psprcs.cfg* is 0.

---

This diagram illustrates the Web version of PS/nVision in OpenXML mode.

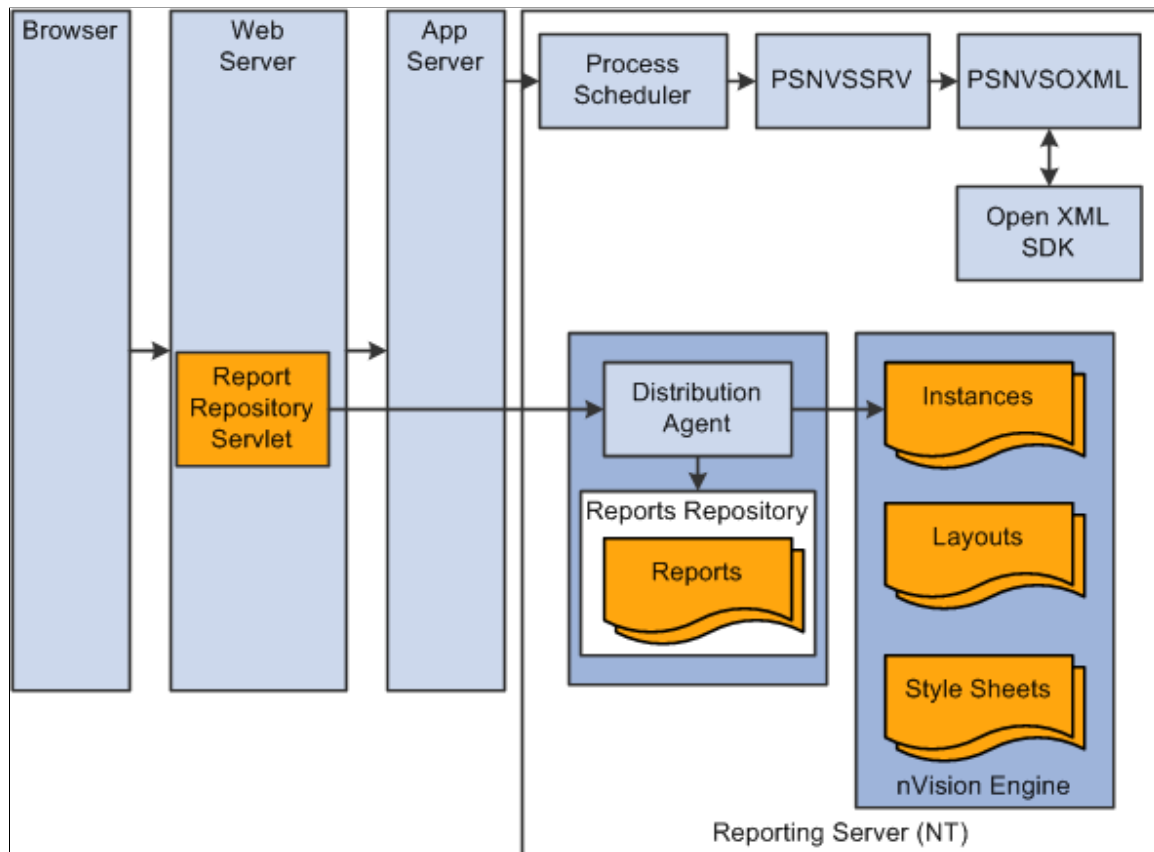

## PS/nVision - Excel Automation Mode

PS/nVision continues using the operation mode called Excel automation mode that automates the Excel application to generate spreadsheet documents in PeopleTools PIA architecture.

---

**Note:** To enable the Excel automation mode in nVision, you need to set the *UseExcelAutomationMode* flag in *psprcs.cfg* to 1.

---

This diagram illustrates the Web version of PS/nVision in Excel automation mode.

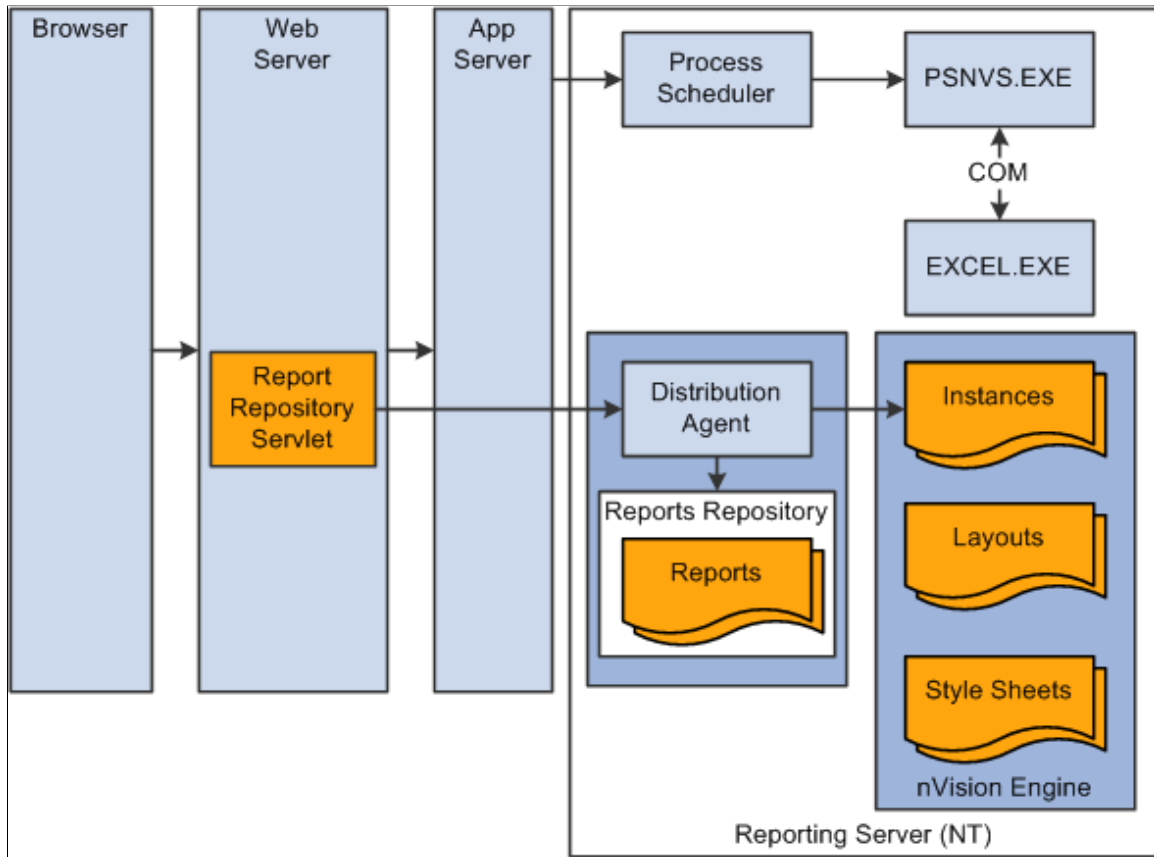

### PS/nVision - Cross Platform Mode

PS/nVision uses the Cross Platform mode to generate spreadsheet documents in PeopleTools PIA architecture.

---

**Note:** To enable the Cross Platform mode in the Web version of PS/nVision, you set the *UseExcelAutomationMode* flag in *psprcs.cfg* to 2.

In the UNIX version, the Cross Platform mode is the default mode and the only mode currently available.

---

This diagram illustrates the Web/UNIX version of PS/nVision in Cross Platform mode.

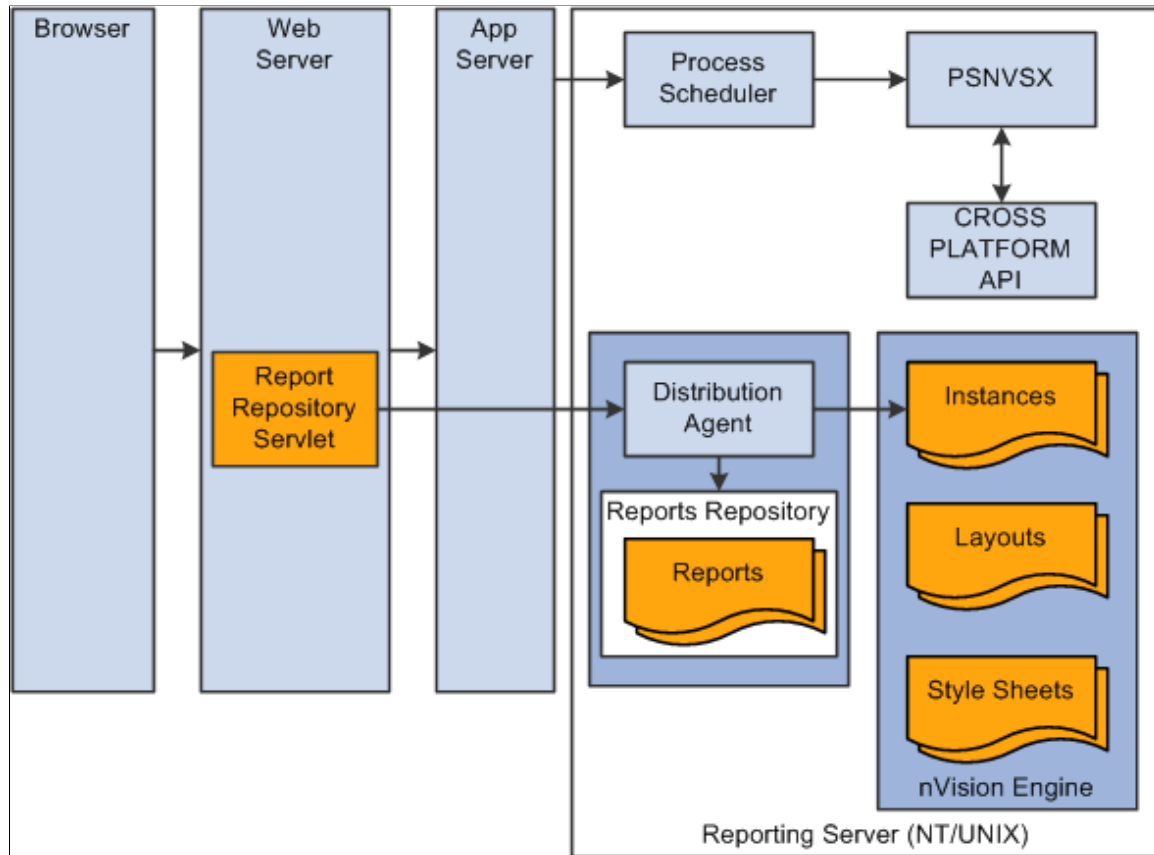

## PS/nVision Implementation

Although PeopleSoft delivers a number of PS/nVision layouts that you can use to run PS/nVision reports, you probably want to create your own report layouts and set up PS/nVision to suit your particular needs. Use the following steps, as appropriate.

**Note:** These setup steps assume that you have already installed and implemented your PeopleSoft applications, that you are familiar with PeopleSoft Query, that you have set up your ledgers in PeopleSoft General Ledger (if you are using PS/nVision to run ledger-based reports), and that you have set up ChartField trees in PeopleSoft Tree Manager (if you are using PS/nVision to run reports based on tree nodes and detail values).

### Basic PS/nVision Setup

The following table lists the basic setup tasks that you perform to create and run your own PS/nVision report layouts.

| <b>Step</b>  | <b>Reference</b>  |
|--|---|
| <p>Set up the PeopleSoft Configuration Manager settings for your Microsoft Windows client.</p> <p>You must define the directories where PS/nVision looks for various file types on the nVision tab on the Edit Profile dialog box in Configuration Manager.</p> <hr/> <p><b>Note:</b> If, when you first try to access PS/nVision, an error message indicates that your client machine is not configured for nVision, you may also need to click the <b>Install Workstation</b> button on the Client Setup tab in Configuration Manager to load important PS/nVision DLL files to your machine's Windows registry.</p> <hr/> | <p>See <a href="#">Using Configuration Manager</a>.</p>   |
| <p>Set up PeopleSoft Process Scheduler settings for the PeopleSoft Pure Internet Architecture.</p>   | <p>See <a href="#">Configuring PS/nVision on the Web</a>.</p>   |
| <p>Plan your layouts.</p>  | <p>See <a href="#">Understanding Layouts</a>, <a href="#">Converting Existing Layouts and Reports to OpenXML Format</a>, <a href="#">Comparing Tabular Layouts, Matrix Layouts, and QueryLink</a>, <a href="#">Working With Layouts</a>.</p>                    |
| <p>Create layouts.</p>   | <p>See <a href="#">Creating Layouts</a>, <a href="#">Creating Tabular Layouts</a>, <a href="#">Understanding Matrix Layouts</a>, <a href="#">Creating Matrix Layouts</a>, <a href="#">Understanding Ledger-Based Matrix Layouts</a>.</p>                        |
| <p>Define report scopes (optional).</p>  | <p>See <a href="#">Understanding Report Scopes</a>, <a href="#">Defining Scopes</a>, <a href="#">Working With Existing Scopes</a>, <a href="#">Using Scope-Related Variables</a>, <a href="#">Creating Scope Definitions</a>.</p>                               |
| <p>Define DrillDown layouts (optional).</p>  | <p>See <a href="#">Using DrillDown</a>, <a href="#">Using DrillDown Navigation</a>, <a href="#">Using DrillDown Layout Formats</a>, <a href="#">Using the PS/nVision DrillDown on the Web</a>.</p>  |
| <p>Define nPlosion criteria, defaults, and style sheets (optional).</p>  | <p>See <a href="#">Understanding nPlosion</a>, <a href="#">Defining nPlosion Criteria</a>, <a href="#">Defining nPlosion Defaults</a>, <a href="#">Enabling nPlosion for Specific Situations</a>, <a href="#">Using Style Sheets with nPlosion Layouts</a>.</p> |
| <p>Define report distributions based on tree nodes and other scope variables (optional).</p>   | <p>See <a href="#">Understanding Report Distribution</a>, <a href="#">Distributing Reports for Scopes Based on Tree Nodes</a>, <a href="#">Distributing Reports for Scopes Based on Value Tables</a>, <a href="#">Configuring the Report Node</a>.</p>          |

| <b>Step</b>                 | <b>Reference</b>   |
|-----------------------------|--|
| Set up PS/nVision security. | See <a href="#">Securing PS/nVision Elements</a> , <a href="#">Securing Report Distribution</a> , <a href="#">Implementing PS/nVision Ledger-Based Data Security</a> , <a href="#">Implementing PS/nVision Query-Based Data Security</a> . |

## Advanced PS/nVision Setup

The following table lists advanced setup tasks you can perform to configure PS/nVision to meet your needs.

| <b>Task</b>   | <b>Reference</b>  |
|---|---|
| Set up advanced PS/nVision options (optional).<br><br>This task includes selecting whether to display warning messages and dialog boxes when PS/nVision runs reports, creating virtual ledgers, and enabling trace files. | See <a href="#">Enhancing Report Layouts</a> , <a href="#">Setting PS/nVision Options</a> , <a href="#">Creating Virtual Ledgers</a> , <a href="#">Using PS/nVision-Defined Names</a> , <a href="#">Formatting Dates</a> , <a href="#">Setting Trace Files</a> , <a href="#">Dismissing Unattended Dialogs</a> .  |
| Personalize PS/nVision (optional).  | See <a href="#">Understanding PS/nVision Personalization</a> , <a href="#">Using Configuration Manager</a> , <a href="#">Personalizing NVSUSER.XLS</a> , <a href="#">Setting Report Preferences</a> , <a href="#">Customizing Delivered Visual Basic Application Wizards</a> , <a href="#">Changing the Startup File</a> , <a href="#">Using PS/nVision API Functions</a> , <a href="#">Configuring PS/nVision on the Web</a> . |
| Develop Visual Basic applications that call PS/nVision features (optional).   | See <a href="#">Using Designer Object Methods</a> , <a href="#">Designer Object Methods</a> , <a href="#">Using Session Object Methods</a> , <a href="#">Session Object Methods</a> , <a href="#">Instance Hooks</a> .  |
| Tune PS/nVision performance (optional).   | See <a href="#">Understanding PS/nVision SQL</a> , <a href="#">Assigning Ledger Tables</a> , <a href="#">Using Indexes and PS/nVision Tuning</a> , <a href="#">Using Trees</a> , <a href="#">Setting Tree Performance Options</a> , <a href="#">Using Tree Tables</a> .   |

## Other Sources of Information

In the implementation planning phase, take advantage of all PeopleSoft sources of information, including the installation and upgrade guides, release notes, red papers, updates and fixes posted to My Oracle Support, PeopleSoft curriculum guides, and other product documentations.

## Chapter 2

# Understanding PS/nVision

---

## Accessing PS/nVision

You can access PS/nVision from the web or from Windows. You can use any of the following three navigation paths:

- From the *PeopleSoft Windows-based application* (Application Designer): Select **Go > nVision**.
- From *Microsoft Windows*: Select **Start > Programs > PeopleSoft 8.x > nVision**. Enter a database name, user ID, and password as you would to start any PeopleSoft application.
- From the *Web*: Select **Reporting Tools > PS/nVision**.

If you are using Windows, PS/nVision automatically opens Microsoft Excel when it starts. The PS/nVision program itself appears minimized on the Windows taskbar. You can click the **PS/nVision** icon to open the PS/nVision window, but unless a specific PS/nVision dialog box is currently active in Excel, the PS/nVision window is blank.

---

**Important!** Don't close this window—it will end your PS/nVision session, even though Excel is still running.

---

You initiate PS/nVision commands using the nVision menu in the Excel menu bar or—depending on your setup—by using a special spreadsheet file, NVSUSER.xls, which opens when you start PS/nVision. When you close Excel, PS/nVision closes automatically as well.

---

**Note:** Your Windows locale must support the sign-on language.

For PS/nVision to appear in the Microsoft Windows navigation path, select the **nVision** option located under the Configuration Manager – Client Setup dialog box.

In PS/nVision for Microsoft Windows, you use the PeopleSoft Configuration Manager to configure the locations of various PS/nVision files, such as layouts, templates, and spreadsheets.

When you first access PS/nVision in Microsoft Windows, if an error message indicates that PeopleSoft PeopleTools DSN is missing in ODBC data sources, you need to run the psodbcinst.exe to install the PS ODBC driver. If an error message indicates that your client machine is not configured for nVision, you need to click the **Install Workstation** option on the Client Setup tab in the Configuration Manager to load important PS/nVision DLL files to your machine's Windows registry.

---

See *PeopleTools Installation Guide: Setting Up the Install Workstation*.

## Related Links

[Personalizing NVSUSER.XLS](#)

“Configuring nVision” (System and Server Administration)

---

## Creating Report Instances and Layouts

Each Excel spreadsheet created with PS/nVision is a report *instance* or a report *layout*. A report instance contains data that PS/nVision has retrieved from your PeopleSoft database. Every report instance is based on a report layout. PS/nVision uses the specified layout to determine the data to retrieve for the report and how to display it.

---

**Note:** Beginning from PeopleTools release 8.51, all PS/nVision layouts and all report instances (that are used to perform drilldown) must be in OpenXML (.xlsx) format. If you want to use existing layouts and reports that are in Excel 2003 (.xls) format, you must convert their format to .xlsx.

---

See [Converting Existing Layouts and Reports to OpenXML Format](#).

Creating a PS/nVision report is a three-step process:

1. Define a *report layout* that specifies the ledgers, criteria, or queries to use for the report and how to format the report.

The report layout is an Excel spreadsheet that does not include actual PeopleSoft data; it defines the structure of the report—query information, criteria, text, formulas, graphics, formatting, or other information. After a layout has been saved, you can use it repeatedly to run reports.

2. Create a report *request*, specifying the layout and runtime options for the report.
3. Run the report request, using the nVision menu in Microsoft Excel, the **Run** button on the request dialog box, or a button/macro that calls PS/nVision to run the report.

As the report runs, a copy of the layout—an instance—is populated with data and is saved as a normal spreadsheet file. You can produce multiple instances of the report. For example, you might provide an inventory report for each location within your organization. Each instance is an individual report with current data from your database, selected and formatted according to the instructions in the report layout.

---

**Note:** If you are using a scope with your report, you can produce several instances from one layout with one report request.

---

Most PeopleSoft applications deliver predefined PS/nVision report layouts (such as Salaries by Department, Balance Sheet, Profit and Loss, and Operations Summary). Like any spreadsheet, a layout spreadsheet can be cloned and modified; you may rarely need to build one from scratch.

Besides the features that are available through PS/nVision, you can use Excel features to personalize layouts (and the resulting reports). For example, Excel includes dynamically linked charting and drawing tools for creating colorful graphs and diagrams. Because the layout is the basis for all reports produced from it, you can format and enhance the report once and get the benefits automatically each time the report is run.

---

**Note:** If you're working with PeopleSoft Financials products, you may be interested in using ledgers with PS/nVision and taking advantage of the TimeSpan feature to define reports that roll from period to period without any changes to the layout. Using TimeSpans, you can have the same layout retrieve year-to-date data based on the as of date for which the report is requested.

---

See [Understanding Ledger-Based Matrix Layouts](#), [Defining Ledger Criteria](#), [Understanding Report Scopes](#), [Defining Scopes](#).

## Layout and Instance Example

To help you visualize the relationship between a report layout and a report instance, this section includes a sample matrix layout with unique data selection criteria for individual rows and columns.

The following layout is an example of a report based on the layout. The Sales and Costs columns specify account numbers, and the rows specify department numbers.

| %APN%                      |  |   |  |
|----------------------------|--|---|--|
| Department                 | Description                            | Sales                                   | Costs                                    |
| Tree Node for Sales Depts. | Label Associated with Department Table | Software License Revenue Account 600000 | Sales Expense Accounts 800000 and 801000 |
| Sales Departments          |  | sum                                     | sum                                      |

In the final report, each cell contains the data for the account number (column) and department number (row) that intersect at that cell.

| October           |               |        |        |
|-------------------|---------------|--------|--------|
| Department        | Description   | Sales  | Costs  |
| 0200              | San Francisco | 4,800  | 2,774  |
| 0210              | Chicago       | 3,500  | 1,883  |
| 0220              | New York      | 4,800  | 2,774  |
| 0230              | Paris         | 3,800  | 1,994  |
| 0240              | Tokyo         | 5,700  | 1,778  |
| Sales Departments |               | 23,600 | 11,203 |

The sample layout contains several types of information:

- Text

This refers to text that appears as-is in all report instances. In the sample above, the column headings—Department, Description, and so on—are standard text that remains the same in all reports created from the layout.

- PS/nVision variables

PS/nVision replaces variables with values when you run a report. The sample layout uses the %APN % variable for the time period reported on. When PS/nVision creates a report with this layout, it replaces the variable with the period covered by the report. If you use a scope to produce multiple instances of a report, you can use variables in the report heading so each reader knows what data the report contains.

- PS/nVision labels

PS/nVision examines the tree structure and determines where to obtain the appropriate label for either a tree node or a detail value. In the example, PS/nVision relates a sales department description to the department table entry for each department corresponding to the Sales Depts tree node.

- PS/nVision selection criteria

Selection criteria specify the data to retrieve from your PeopleSoft database. For example, the Sales column in the sample layout has criteria that direct PS/nVision to retrieve data from the Sales account.

- Microsoft Excel formulas

These formulas perform calculations on the report data. In the example, the bottom row automatically displays totals of the Sales and Costs columns. You could add a calculated column, Gross Income, calculated via an Excel formula that subtracted Costs from Sales.

- Formatting

Formatting information includes attributes such as font size, underlining, column width, print options, and so on. You design your layouts using familiar Excel methods; any formatting and enhancements you place in the layout appear in all reports created from it.

## Using Microsoft Excel Features

In addition to the PS/nVision functionality for retrieving data from your PeopleSoft database, you still have all of Microsoft Excel's features at your disposal. This section describes how to:

- Insert formulas
- Insert and format text

### Inserting Formulas

Formulas enable you to perform calculations such as adding column or row data, computing variances, calculating ratios, and so forth. You can use cell references such as `=C2+C3`, name references such as `=Revenue-Expenses`, or worksheet functions (see the Excel documentation or online help for a list of commands). All formulas begin with an equal sign (`=`). You can use a number of formula operators for calculations.

The following table lists the most common operators.

| <b>Symbol</b> | <b>Description</b> | <b>Purpose</b> |
|---------------|--------------------|----------------|
| +             | Plus sign          | Addition       |
| -             | Minus sign         | Subtraction    |
| *             | Asterisk           | Multiplication |

| <b>Symbol</b> | <b>Description</b> | <b>Purpose</b>              |
|---------------|--------------------|-----------------------------|
| /             | Slash              | Division                    |
| :             | Colon              | Range                       |
|               | Space              | Intersection                |
| ,             | Comma              | Union                       |
| –             | Hyphen             | Negation                    |
| %             | Percent sign       | Percent                     |
| &             | Ampersand          | Text concatenation operator |

To enter a formula, click in the worksheet cell where you want the formula or text to appear, and begin typing. As you type, your cursor appears in the Excel formula bar (the rectangular box just below the menu bar, above the worksheet). The Cancel and Enter buttons appear to the left of the cursor.

This example shows the Excel and nVision formula bar.

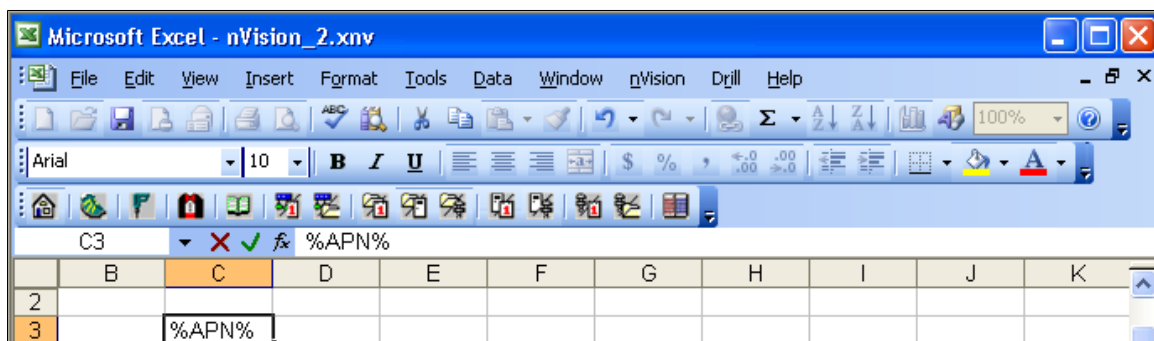

## Inserting and Formatting Text

Text is used mainly for column and row headings, captions, and callouts. Excel has a number of formatting features to enhance the appearance of text in your worksheet.

Formatting is also straightforward, provided that you know where to look for the commands. To resize columns and rows in Excel, either highlight the row or column and drag its border, or select **Format**, **Column**, **Width** or **Format**, **Row**, **Height**. You can also select **Column Width**, **Best Fit** to automatically set the width for headings. Do not select **Best Fit** until you have typed the longest line in the column.

To wrap column headings within a cell, select **Format** > **Cells** and then select the **Wrap Text** on the **Alignment** tab.

---

**Note:** You can use conventional Excel commands for additional formatting.

---

See the *Microsoft Excel User's Guide*.

## Chapter 3

# Using Layouts

---

## Understanding Layouts

PS/nVision enables you to import information directly from your database into an Excel spreadsheet, so you can spend your time analyzing results rather than summarizing data and entering it into your spreadsheet.

To specify the data you want to bring into Excel, you use a report layout. A report layout is an Excel spreadsheet used as a template to define how a report looks and the type of information that goes into the spreadsheet's different cells. A layout does not contain data from the database. Rather, it specifies what data should be mapped directly into your report.

You do not need to create a new layout every time you run a report. After you have created a library of report layouts, select the existing layout that best suits your needs. PS/nVision keeps track of the layout used in any given report, so to run an existing report you simply select *nVision, Report Request* and specify the report name or simply click the **Run Reports** button from the NVUSER home page. The correct layout is loaded automatically.

---

## Converting Existing Layouts and Reports to OpenXML Format

All PS/nVision layouts and all report instances (that are used to perform drilldown) must be in OpenXML format (.xlsx). If you want to use existing layouts and reports that are in previous Excel format (.xls), you must convert their format to .xlsx.

To convert layouts and reports from .xls format to .xlsx format, perform one of these methods on the PS/nVision client desktop:

- Manual and individual conversion.
- Mass conversion using Microsoft conversion utility.

### Manual and Individual Conversion

To manually and individually convert layout or report from .xls format to .xlsx format:

1. Open the .xls layout or report in Microsoft Excel 2007.
2. Click on the **Office** button on the upper-left corner.
3. Select *Save As, Excel Workbook* for the layout or report that does not contain macros.

Otherwise, select *Save As, Excel Macro-Enabled Workbook* for the layout or report that contains macros.

4. Enter the name of the layout or report using the .xnv format.

For example, *ExpenseDetail.xnv*.

5. Set the *Save As* type in .xlsx for the layout or report that does not contain macros.  
Otherwise, set the *Save As* type in .xlsm for the layout or report that contains macros.
6. Click the **Save** button to complete the conversion, and close the layout or report.
7. Repeat step 1 through step 6 for each layout or report that needs to be converted.

## Mass Conversion Using Microsoft Conversion Utility

Microsoft provides these free software toolset for converting .xls format to .xlsx format:

- MigrationPlanningManager.exe, which includes the ofc.exe file and other tools used for mass conversion.
- FileFormatConverters.exe Office Pack, which installs binaries used for format conversion.

To convert layouts from .xls format to .xlsx format using the Microsoft conversion utility:

1. Download the MigrationPlanningManager.exe folder and extract it into a new folder.

For example, *C:\Office*.

2. Download and install the FileFormatConverters.exe Office Pack.

---

**Note:** This step is required even if Microsoft Office 2007 is already installed on your computer.

---

3. Access *C:\Office\tools* and open the ofc.ini file using Notepad.

4. In Notepad, set the following values:

- *MacroControl=1*

This setting processes the macros associated with the layouts.

- *fldr=<PS\_HOME>/nVision/Layouts*

This setting refers to the source folder location that contains the layouts to be converted.

5. Backup all layouts that need to be converted and move them to a separate folder.
6. Rename all nVision layouts from \*.xnv to \*.xls.

This step is required because the utility does not recognize any file types other than Excel's native file types.

7. Open the command prompt and access *C:\Office\Tools*.

8. Run the ofc.exe file.

This utility converts all .xls files present in the source folder, which are stored in the ofc.ini file, to .xlsx format.

9. Rename the layouts from \*.xlsx or \*.xlsm to \*.xnv.

---

**Note:** Microsoft conversion utility may not successfully convert password-protected layouts; password-protected layouts should be manually or individually converted.

---

## Comparing Tabular Layouts, Matrix Layouts, and QueryLink

PS/nVision offers two kinds of report layouts: tabular layouts and matrix layouts. The major difference between them is how they specify the data to retrieve from the database. In general, tabular layouts lend themselves to detailed transaction reporting, while matrix layouts are more appropriate for summarized reporting and analysis.

*Tabular layouts* are simpler than matrix layouts. They use a query defined in PeopleSoft Query to retrieve data. The columns in the report correspond to the fields returned by the query; the rows in the report correspond to the rows in the query result set. You can specify a heading row, a first result row, and a totals row (if you need one). You can also use scopes in a tabular layout to filter your results.

*Matrix layouts* have data selection criteria based on the intersection of columns and rows in the spreadsheet, creating a criteria matrix. The data retrieved for an individual cell is determined by a combination of the criteria for its column and its row. Unless you are specifying a query in the matrix layout, all matrix layouts must have at least one TimeSpan, at least one ledger, and at least one ChartField as criteria.

You can specify a ledger, a query, or both a ledger and a query to retrieve data. For PeopleSoft Financials applications, matrix layouts most often use ledgers for data retrieval. PS/nVision knows automatically the tables to access and the fields to retrieve based on the ledger definition.

*QueryLink* is a PeopleSoft Query feature that enables you to send the results of a query directly to an Excel spreadsheet, bypassing the need for a PS/nVision layout. Any query results sent to Excel through QueryLink are based on the QUERY.XLT Excel template. To make any permanent changes to spreadsheets derived through QueryLink, make the changes to QUERY.XLT.

The following table shows some of the key differences between tabular layouts, matrix layouts, and QueryLink.

| <b>Feature/Function</b> | <b>Matrix Layout</b>   | <b>Tabular Layout</b>  | <b>QueryLink</b>  |
|-------------------------|--|--|---|
| Data sources            | Multiple queries and ledgers; labels.  | Single query.  | Single query.   |
| Data                    | Numbers in matrix, text in labels and variables.   | Text and numbers.  | Text and numbers.   |
| Data delivery           | Matrix intersections of field criteria and queries (amounts) of label and field criteria (text). | Selected query result columns, one data row per spreadsheet row. | All query result columns, one data row per spreadsheet row. |

| <b>Feature/Function</b>         | <b>Matrix Layout</b>  | <b>Tabular Layout</b>                        | <b>QueryLink</b>   |
|---------------------------------|---|--|--|
| Layouts                         | One per workbook.   | Multiple worksheets per workbook.            | None: produces one sheet in template workbook (QUERY.XLT). |
| Selection criteria              | Scope<br>Business Unit<br>Effective Dates<br>Query/Ledger<br>TimeSpan<br>Field<br>Label<br>String | Scope<br>Query                               | Query  |
| PS/nVision variables            | Yes   | No   | No   |
| Scope                           | Multiple instances from the layout workbook.  | Multiple instances from the layout workbook. | None   |
| nPlosion                        | Rows and columns.   | None   | None   |
| Drilldown from instance         | Yes   | No   | No   |
| TimeSpans                       | Yes, with data keyed by year, period.   | No   | No   |
| Number of layout sheets allowed | One   | Many   | One  |

---

## Working With Layouts

In general, how you create a layout depends on the layout type. However, some basic tasks are common to all layout types. This section discusses how to:

- Specify criteria.
- Use nPlosion (matrix layouts only).
- Set a TimeSpan.
- Specify setIDs and business units.

- Enter effective dates.
- Enter comments in OpenXML mode.

## Specifying Criteria

Data selection is the heart of the PS/nVision layout. The database values retrieved for a matrix-based report are the results of intersecting criteria defined in the matrix layout. These criteria tell PS/nVision exactly which database values to retrieve and where to put them. The values retrieved from a tabular layout are not row and column intersections but the results of a query. Each instance is a list file representing either a partial or complete answer set for that query.

You can specify data selection criteria at the level of the entire spreadsheet, a row or column, or an individual cell. Generally, you specify criteria at the highest level applicable. So, if you have criteria that apply to the entire worksheet, you specify them at the worksheet level; if you have criteria that are unique to a single cell, you apply them to that cell only.

If there is a conflict between row and column criteria, the row overrides the column criteria. Cell criteria override all other criteria, followed by row, column, and finally worksheet criteria at the lowest level of the hierarchy.

---

**Note:** nVision should not use trees with a mixture of dynamic details and range details. The results returned from the reports using such trees could be inaccurate.

---

### Related Links

[Criteria Types](#)

## Using nPlosion

nPlosion is a feature that you can specify within your field criteria. If field criteria uses a tree node value, nPlosion automatically adds rows or columns that contain the sublevels (while sub-totaling) as well as detail values found under the tree nodes that you specify. This creates a group of rows or columns that can be summarized—showing just the tree node value—or expanded to show the detail values *and* the summarized value.

You can also use nPlosion to show detailed TimeSpan information.

See [Understanding nPlosion](#), [Defining nPlosion Criteria](#), [Defining nPlosion Defaults](#), [Enabling nPlosion for Specific Situations](#), [Using Style Sheets with nPlosion Layouts](#).

## Setting a TimeSpan

A TimeSpan limits query or ledger results to those from a particular period of time. Although you can use TimeSpan in a query-based matrix layout, it is more commonly used in ledger-based matrix layouts.

### Related Links

[Using TimeSpans](#)

## Specifying SetIDs and Business Units

PS/nVision uses the setID you specify when creating a matrix layout to determine available choices when you define layout criteria. If the **Use Business Unit in nVision** option is clear, you can omit the setID. If you enter one, it must be valid. To set the **Use Business Unit in nVision** option on or off, select **PeopleTools > Utilities > Administration > PeopleTools Options**.

---

**Note:** The **Use Business Unit in nVision** option is selected by default because essentially all PeopleSoft applications now use business units.

---

## Entering Effective Dates

When you define a matrix layout, you must always enter an effective date. Like the setID, this controls which values are available for you to select when defining criteria. For some criteria, you can override the global effective date. Generally, it's a good idea to use an effective date as late as any control (tree, department, and so on) you might want to use in the layout. The effective date used for prompting while designing a layout is not used when running the report; instead, the as of date for trees and other controls is specified in the report request when running a report.

## Enter Comments in OpenXML Mode

You can enter comments in Excel layouts in the OpenXML mode of nVision for better clarity of actions during processing. Once you run the layout, the comment takes an appropriate position according to the insertion or deletion of rows and columns in the final report.

---

**Note:** Comments in Excel layouts are also handled in Excel automation mode in a similar manner.

---

---

## Creating Layouts

This section describes how to:

- Plan a layout.
- Open an existing layout.
- Create a new layout.
- Save a spreadsheet as a layout.
- Select a layout type.
- Specify a layout definition.

## Planning a Layout

Before you begin to define a layout online, you should do some planning and outlining on paper so you fully understand what data you want to retrieve, what you want the resulting reports to look like, and so on. The following checklist is a good way to make sure that you cover all bases before you start defining a layout.

- Outline your report specifications on paper, showing the desired rows, columns, and headings.
- Examine existing layouts and copy them, if possible, instead of starting from scratch.
- Determine the naming convention for your layout, scope, report request, and instances.
- Determine at which levels (worksheet, column, row, or cell) you should specify the queries and ledgers, fields, and labels you want to use as your criteria.
- Identify existing PeopleSoft queries that might support your query criteria. If they don't exist, you'll have to create them. Do you want to use TimeSpans?
- Identify existing PeopleSoft trees that might support your field criteria, because it's simpler to use tree nodes than to specify detail values as your field criteria. Do you want to use nPlosion?

## Opening an Existing Layout

You can open an existing layout to copy the report and then make minor changes to it. To open an existing layout in PS/nVision:

1. Select **nVision** > **Open Layout** from the nVision menu of PS/nVision (Nvsuser.)

Alternatively, click the **Open Layout** button.

The Open nVision Layout dialog box appears.

2. Select a layout (.xnv) file.

The directory this dialog box opens to is defined in the Configuration Manager.

3. Specify whether to create the layout as read-only.
4. Click the **Open** button.
5. After the file is open, select the **Save as Layout** option from the nVision menu and give the layout a new name.

---

**Note:** If you used Microsoft Excel 2007 to save a layout with named cell using the **File Name** field, when you open this layout file through PS/nVision, the named cell reference might be corrupted and the named cell details are not properly shown.

---

### Related Links

[Using Configuration Manager](#)

## Creating a New Layout

You can create a new layout from scratch rather than basing a new layout on an existing one.

To create a new layout in PS/nVision:

1. Select **nVision** > **New Layout** from the nVision menu.

The Create New nVision Layout dialog box appears.

2. Enter a name in the *File name* field.

PS/nVision supports file names of up to 50 characters in length. You cannot change the default .xnv extension.

3. Specify whether you want to open the new layout as read-only.

Selecting this option enables you to open layouts in read-only mode. This protects shared layouts from accidental changes and eliminates Excel messages indicating that the layout is in use (or resides on a read-only network drive). Changes made to a read-only layout are not saved and are not reflected in the report instances produced.

4. Click the **Save** button.

The new layout is created, saved, and opened for you to define.

## Related Links

[Choosing a Layout Type](#)

## Saving a Spreadsheet as a Layout

You can save an existing Excel spreadsheet or layout as a new layout.

To save an Excel spreadsheet or layout as a new layout:

1. From PS/nVision, open the spreadsheet by selecting **File** > **Open** from the nVision menu.
2. Select **nVision** > **Save As Layout** from the nVision menu.

The Save As nVision Layout dialog box appears, which enables you to save an opening Excel spreadsheet (.xls file) as an nVision layout (.xnv file), or to save an opening layout as a new layout.

3. Type in a file name and click the **Save** button.

An Excel spreadsheet opens in PS/nVision.

4. Enter any text, such as headings in the columns and rows, that you need to type in manually.

## Choosing a Layout Type

When you first create a new layout, the type – matrix or tabular – is not yet defined. You use the PeopleSoft nVision Layout Options dialog box to specify the layout type.

This example illustrates the fields and controls on the PeopleSoft nVision Layout Options dialog box.

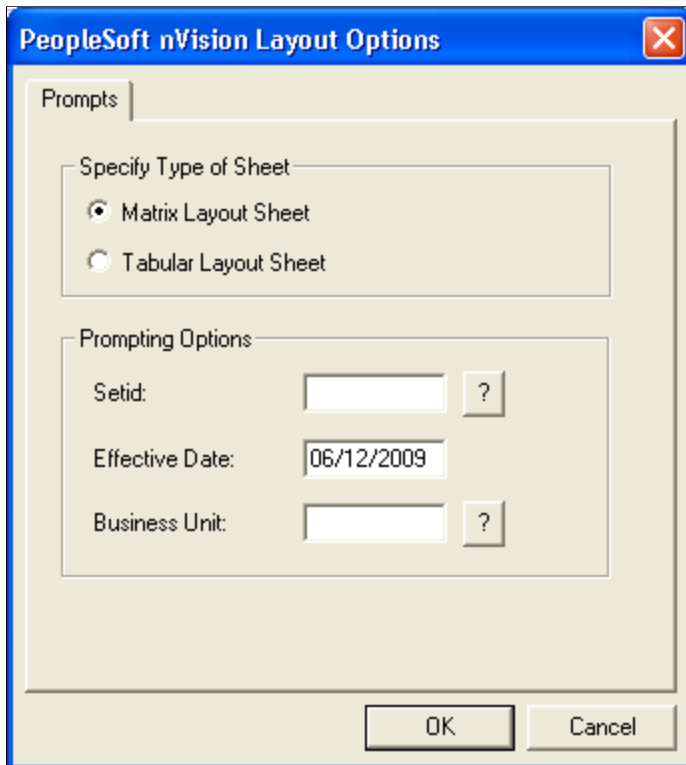

To specify a layout type in PS/nVision:

1. Select **nVision** > **Layout Definition** from the nVision menu.

The PeopleSoft nVision Layout Options dialog box appears.

2. Select either the **Matrix Layout Sheet** option or the **Tabular Layout Sheet** option.
3. Enter a setID, effective date, and business unit.

A setID identifies the table set you want to work with and corresponds to the set control value used in establishing table set sharing within the PeopleSoft database.

The effective date determines which values in PeopleSoft tables are valid at the time you develop the report. The effective date is not the same as the as of date that is entered in the report request. (The as of date determines the current period for data retrieval.)

The business unit represents part of your corporation that is independent with regard to one or more operational or accounting functions. PeopleSoft General Ledger business units typically comprise individual entities for accounting purposes.

---

**Note:** The values you enter here do not determine the setID and effective date used for the reports—runtime controls are specified on the report request. Instead, PS/nVision uses the setID and effective date you enter here to determine the data you can select from while creating your layout.

---

4. Click the **OK** button.

The nVision Layout Definition dialog box appears prompting you to define your layout further.

## Specifying a Layout Definition

You set layout options for your report using the nVision Layout Definition dialog box. The tabs at the top of the dialog box vary depending on the type of layout you are creating. Select a tab to select layout criteria or special nVision functionality for your worksheet.

---

**Note:** You are able to run nVision reports that include up to 16384 columns of data if your nVision layouts are in Microsoft Excel 2007 file formats. Notice that nVision report execution time is directly proportional to the number of columns of data returned. When you design the nVision layout, the location of column criteria can also be set at up to column 16384. However, nVision report execution time is dependent on the location of column criteria; for example, if the column criteria is defined at column 16384 instead of the same column criteria at the column 100, then the report execution time increase because the used area of the worksheet increases when the criteria is defined at the farthest column.

---

### Informational Group Boxes

A group box in the upper-left corner of the Summary tab displays information about the contents and location of the selected cells.

This example illustrates the fields and controls on the PeopleSoft nVision Layout Definition dialog box: Summary tab.

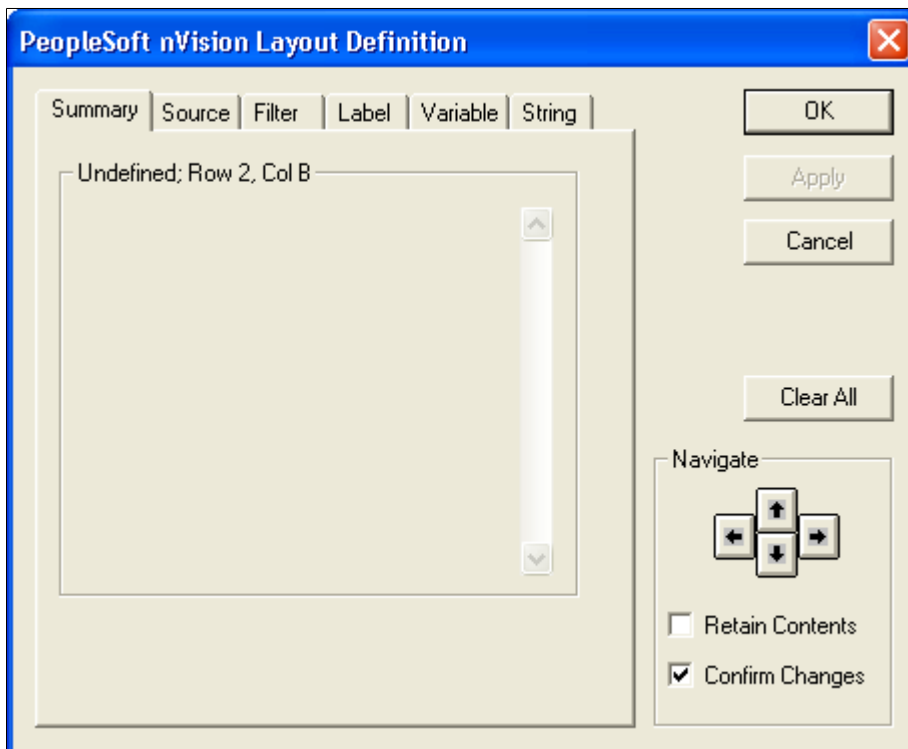

When no PS/nVision information is stored in the current selection, the group box appears as it does in this dialog box. The box is titled *Undefined*, followed by the location of the cells selected. If you have an entire row selected, the name of that row appears; the same applies to columns. If you have the entire worksheet selected, the location text is Sheet Defaults.

If the current selection contains PS/nVision information, the title of the group box reflects it. Also, the details about that information appear as the contents of the group box.

This example shows the informational group box displaying PS/nVision cell contents.

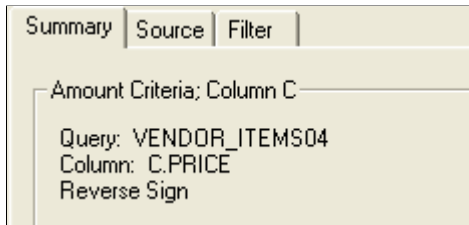

**Note:** When you view a PS/nVision layout, you'll notice that Row 1 and Column A are always hidden. PS/nVision reserves them to store control information, such as data selection criteria; you cannot use Row 1 or Column A in your layout. The first available column is B, and the first available row is 2. Whenever you open a new layout definition, the cell pointer is automatically placed at cell B2—the upper-left cell available for use in the layout.

## Navigating Within Layouts

To move between cells and columns, use the navigate buttons in the dialog box.

For example, clicking the right arrow moves the cell pointer in Excel one cell to the right. You can select individual cells, or you can select entire rows and columns by navigating to the uppermost and left-most sides of the layout. You can also select the entire worksheet by navigating to the upper-left corner of the layout. The new cell selection appears in the informational section title.

This is an example of the navigate section.

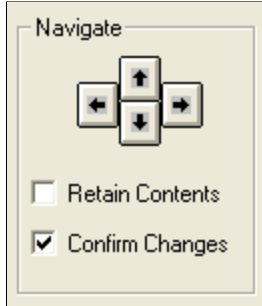

Select the **Retain Contents** option to preserve the currently displayed information in the informational group box when you navigate elsewhere. You can then apply the same information to the new cells and make only minor changes, if necessary.

Clear the **Confirm Changes** option to stop being prompted to save your changes each time you change the PS/nVision information and navigate elsewhere. This can save time if you are creating a new layout. When this option is cleared, changes you have made to the current row, column, and so on are automatically saved when you use the arrow keys.

## Dialog Box Control Buttons

| <i>Field or Control</i> | <i>Description</i>   |
|-------------------------|--|
| <b>OK</b>               | Click this button to close the dialog box and you are able to access the Microsoft Excel menus, or to enter text into the worksheet manually.  |
| <b>Clear All</b>        | Click this button to remove any existing criteria from the current selection.<br><br><b>Note:</b> If you clicked the <b>Clear All</b> button and you navigate to another cell or other area of the layout, your criteria are permanently deleted unless you click the <b>Cancel</b> button before you move the cursor. |
| <b>Apply</b>            | This button is only available after you click the <b>Clear All</b> button.<br><br>Click this button to apply your changes.   |
| <b>Cancel</b>           | Click this button to exit the sheet without clearing criteria.   |

## Layout Definition Tabs

Six tabs appear at the top of most Layout Definition dialog boxes. Not all layout types require the same information, so not all of these tabs appear with each type of layout.

This is an example of six tabs in the PeopleSoft nVision Layout Definition dialog box.

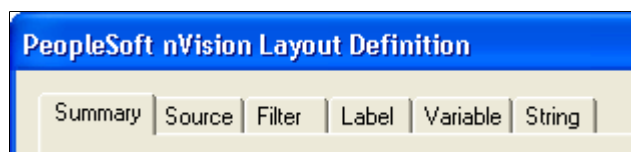

Using these tabs, you can specify options for your worksheet and for rows and columns. The controls on the dialog box vary depending on whether you have a cell, row, column, or the entire worksheet selected.

| <i>Field or Control</i> | <i>Description</i>   |
|-------------------------|--|
| <b>Summary</b>          | Displays the information about the contents and location of the selected cell.               |
| <b>Source</b>           | Enables you to select query, ledger, and TimeSpan criteria as well as some nPlosion options. |

| <b>Field or Control</b> | <b>Description</b>   |
|-------------------------|--|
| <b>Filter</b>           | Identifies specific detail values from PeopleSoft trees. These act to limit query, ledger, and label criteria.   |
| <b>Label</b>            | Retrieves descriptive field values from either tree nodes or detail values. Like queries and ledgers, these criteria also perform the role of a data source—although the data is always textual rather than numeric.                                       |
| <b>Variable</b>         | Displays information that is specific to each report request and report instance—for example, scope instance number, reporting period, and other information that can change when you use a different scope.   |
| <b>String</b>           | Enables you to build multilingual layouts. Certain text strings are replaced by specially formatted strings whose user-language equivalents are retrieved from a table in the database.  |
| <b>Column</b>           | Enables you to map the layout columns to the appropriate query columns. The columns contain the data that the query returns. This tab is only available if you have selected a tabular layout.<br><br>See <a href="#">Mapping Tabular Layout Columns</a> . |
| <b>Options</b>          | Enables you to select one of the <i>Sheet Options</i> , <i>Row Options</i> and <i>Column Options</i> . This tab is only available if you have selected a tabular layout.<br><br>See <a href="#">Defining Layout Options</a> .                              |



## Chapter 4

# Creating Tabular Layouts

---

## Understanding Tabular Layouts

Tabular layouts use PeopleSoft queries to retrieve data. Unlike matrix layouts, tabular layouts do not rely on the intersection of rows and columns to retrieve data. The columns in the report correspond to the fields selected by the query. The rows display the entire query result set, although you can use a scope to limit the results. By using query criteria, you can retrieve data from almost any table in a PeopleSoft database.

When defining a tabular layout, you select a query and then select the query columns to use and the layout columns to map them to.

See [Understanding Matrix Layouts](#).

---

## Creating Tabular Layouts

To create a tabular layout in PS/nVision:

1. Create a new layout by selecting nVision, New Layout from the nVision menu.

See [Creating a New Layout](#).

2. Define the layout as a tabular layout.
3. Select **nVision > Layout Definition** from the nVision menu.

The Layout Options dialog box appears.

4. Select the **Tabular Layout Sheet** option and click the **OK** button.

You can also optionally select a setID, effective date, and business unit to be used as prompts when searching for your layouts.

The Layout Definition dialog box appears.

5. Select the Source tab to specify the query name you want to use.
6. Select a query name from the drop-down list and click the **OK** button.

Because you have chosen to create a tabular layout sheet, PS/nVision knows that you will be basing this layout on a query. Therefore, the only option available in the Type drop-down list is *Query*.

7. Map the layout columns to query columns.

See [Mapping Tabular Layout Columns](#).

- Define options for your worksheet, rows, and columns.

See [Defining Layout Options](#).

## Related Links

[Creating Layouts](#)

## Mapping Tabular Layout Columns

Make sure that the layout columns are mapped to the appropriate query columns. When you run a report based on the layout, these columns contain the data that the query returns.

This example illustrates the fields and controls on the PeopleSoft nVision Layout Definition dialog box: Column Tab.

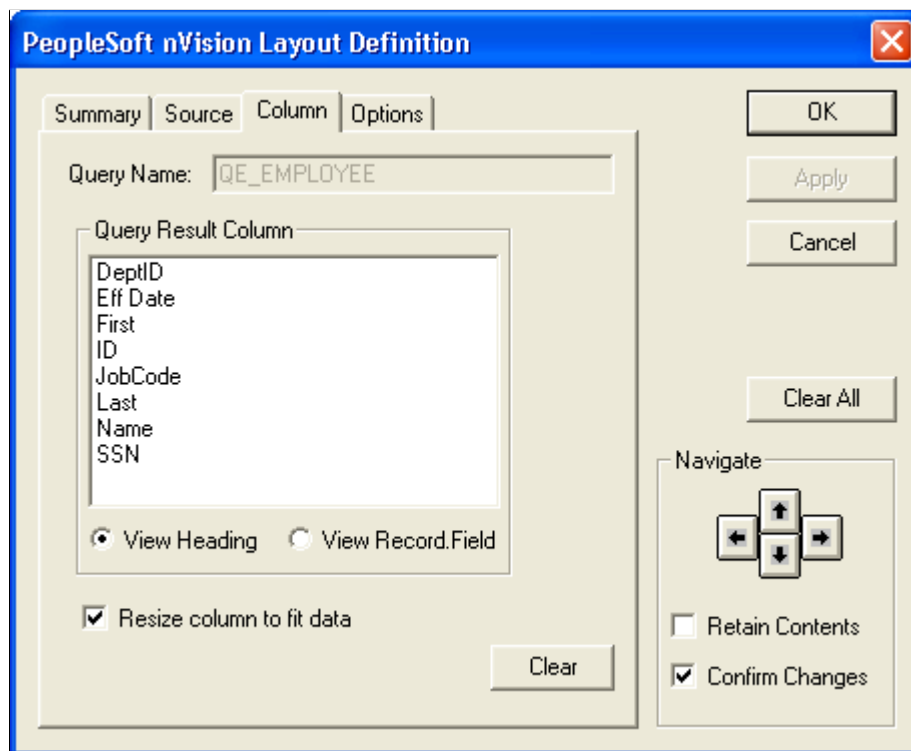

To map layout columns to query columns in PS/nVision:

- With a nVision layout open, select **nVision** > **Layout Definition** from the nVision menu.
- Select the **Tabular Layout Sheet** option from the Layout Options dialog box, and click the **OK** button.
- From the Layout Definition dialog box, select a layout column to map to a query column.

Use the Navigate buttons to select a result column in the layout. The column appears as dark gray when selected, and the column tab appears on the Layout Definition dialog box.

- Select the Column tab that appears on the Layout Definition dialog box.

You use this tab to map a query result column to the selected layout column.

5. Select a query result column.

The list box shows the output columns associated with the selected query. By default, the list box displays the headings assigned to the result columns in PeopleSoft Query, and the **View Heading** option is selected. To see the names of record fields associated with each result column, select the **View Record Field** option.

6. Select *Resize column to fit data* to use the Microsoft Excel AutoFit command to adjust column width at runtime.

This selection makes the column as wide as the defined field length when a report is run.

7. Click the **Apply** button to save your changes and map a different query column to a different layout column, or click the **OK** button to save your changes and close the dialog box.

The name of the column you selected is inserted into the third cell of the selected column as a temporary label. When you run a report, this label does not appear. However, you can define a row to display column headings in the report.

If you clicked the **Apply** button, navigate to a new column and repeat steps 3 and 4 to map another query result column.

Before PeopleTools release 8.48, if a query had a self-join and, therefore, had more than one column with the same record.field name, then nVision could not distinguish between those two columns.

For example, consider the following query SQL:

```
Select A.EmpName, B.EmpName from EMPLOYEE A, EMPLOYEE B where A.MgrNo = B.EmpNo
```

If A.EmpName and B.EmpName were mapped to two columns in a tabular layout, then the results for A.EmpName will also be used for B.EmpName.

In PeopleTools 8.48 and later, nVision can distinguish between two columns having same *record.field* in a query with a self-join. Also, the criteria string for a column in a tabular layout will now include a new code "A<xyz>", where <xyz> represents the alias for that record as shown in the following table.

| <b>Employee</b><br><b>%,HEmployee,REMPLOYEE,FEmpName,AA</b> | <b>Manager</b><br><b>%,HManager,REMPLOYEE,FEmpName,AB</b> |
|---|---|
| Smith, John   | Wilson, Dave  |
| Patterson, William  | Adams, Tracie   |

## Defining Layout Options

Use these steps to access the PeopleSoft nVision Layout Definition – Options dialog box:

1. With a nVision layout open, select **nVision > Layout Definition** from the nVision menu.
2. From the Layout Definition dialog box, select a layout column to map to a query column.
3. Select the Column tab.

The PeopleSoft nVision Layout Definition – Options dialog box appears.

This example illustrates the fields and controls on the PeopleSoft nVision Layout Definition dialog box: Options tab.

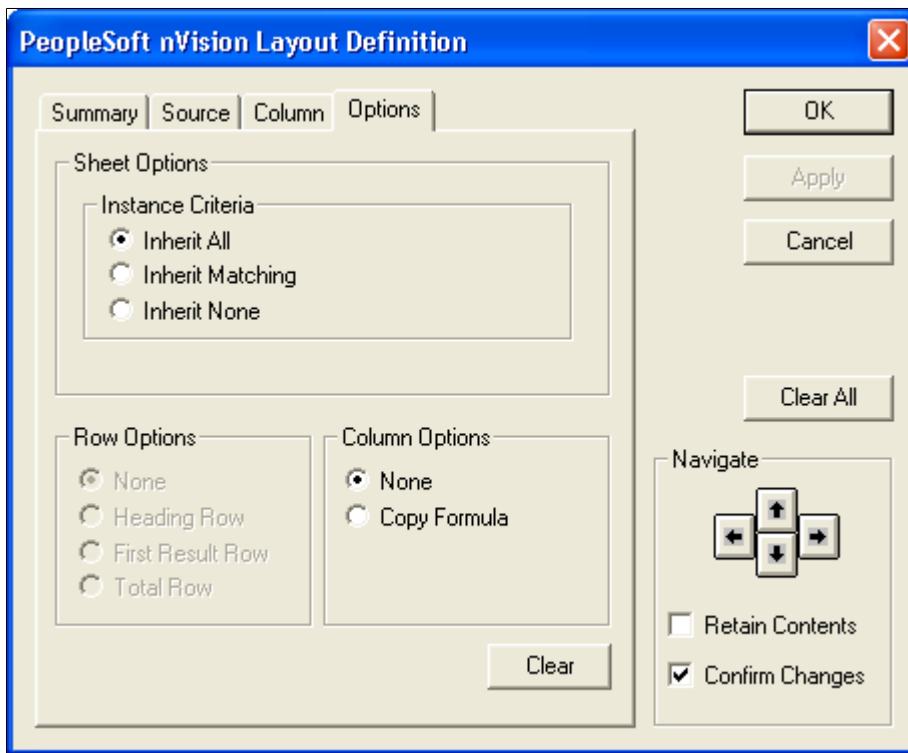

The controls available in the dialog box vary depending on whether you have a cell, row, column, or the entire worksheet selected.

---

**Note:** If the Options tab does not appear in the PeopleSoft nVision Layout Definition dialog box, you may have to clear a column or the worksheet.

---

## Sheet Options

These options apply to the entire layout.

| <b>Field or Control</b>  | <b>Description</b>  |
|--------------------------|---|
| <b>Instance Criteria</b> | <p>Select an option to dictate how PS/nVision applies the scope specified in the report request. With a tabular layout, PS/nVision implements scope by adding selection criteria to the query that the layout uses. For each report instance, it adds a criterion that restricts the returned values to those subsets that correspond to the current value of the scope variables. Options include:</p> <ul style="list-style-type: none"> <li>• <b>Inherit All:</b> Select to have criteria specified in the scope definition apply to the layout. If PS/nVision does not find scope definition criteria in the query's table, it displays an error message.</li> <li>• <b>Inherit Matching:</b> Select to specify that only the scope definition criteria found in the query are inherited. PS/nVision ignores all scope definition criteria not found in the query's table.</li> <li>• <b>Inherit None:</b> Select to indicate that PS/nVision should not use the assigned scope when processing the query.</li> </ul> |

## Row Options

These options are available only if you have selected a layout row.

| <b>Field or Control</b> | <b>Description</b>  |
|-------------------------|---|
| <b>None</b>             | No special functionality is applied to the selected row. This is the default option.  |
| <b>Heading Row</b>      | The selected row displays the heading of each query column in the layout. If you don't select a heading row, the layout uses Row 3 as the heading row.  |
| <b>First Result Row</b> | <p>The selected row displays the first row of data returned by the query. The rest of the data rows are inserted immediately below this row.</p> <hr/> <p><b>Note:</b> You must define one first result row in your layout.</p> <hr/> |

| <b>Field or Control</b>    | <b>Description</b>   |
|----------------------------|--|
| <b>Total Row</b> total row | <p>The selected row can contain Excel formulas that perform calculations on the result rows in the column. You define the total row in position relative to the first result row; in the report instances, the total row actually appears relative to the last data row. For example, if you leave one blank row in the layout between the first result row and the total row, there will be one blank row between the end of the query data and the totals.</p> <hr/> <p><b>Note:</b> After you select this option, you must manually enter the Excel formulas you want in your total row.</p> <hr/> <p>All PS/nVision dialog boxes must be closed before you can manually insert cell contents.</p> <hr/> <p>If a formula is to operate on an entire column, be sure to specify a range starting with the first result row and ending one row down. When reports are run, the range is expanded to include all the inserted result rows.</p> |

### Column Options

These options are available only if you have selected a layout column.

| <b>Field or Control</b> | <b>Description</b>  |
|-------------------------|---|
| <b>None</b>             | No special functionality is applied to the selected column. This is the default.  |
| <b>Copy Formula</b>     | <p>Any Excel formula found at the intersection of the selected column and the total row is copied to all rows in the column. This option enables you to easily create columns that perform calculations based on the other layout columns. For example, if your query returns projected and actual budget data, you might want to add a column that displays the variance.</p> <hr/> <p><b>Note:</b> After you select this option, close the PeopleSoft nVision Layout Definition dialog box and access the layout. Highlight the cell at the intersection of the total row and the calculated column and enter the Excel formula you want to use for the column.</p> <hr/> |

See [Understanding Report Scopes](#), [Defining Scopes](#).

---

## Creating Report Titles

Because you cannot insert variables into a tabular layout, you cannot generate report titles automatically, as you would using a matrix layout. To create a report title in a tabular layout, insert a second sheet into your Excel workbook and create a matrix layout. Use the %RTT% variable to create the report title in the matrix layout, and then do an intra-sheet reference in Excel; the report title appears on your tabular report.

See the *Microsoft Excel documentation*.



## Chapter 5

# Creating Matrix Layouts

---

## Understanding Matrix Layouts

Typically, the PeopleSoft data you report on is in one or more large tables with lots of details—usually ledgers. Using a PS/nVision matrix layout, you can fashion that raw data into a summarized form.

Matrix layouts have data selection criteria associated with columns and rows in the spreadsheet, creating a criteria matrix. The data retrieved for an individual cell is determined by combining the criteria for its column and row.

### Example

To illustrate a matrix layout, assume that a table in the database appears as the following table.

| <i>Office</i> | <i>Product</i> | <i>Sales</i> |
|---------------|----------------|--------------|
| CHICAGO       | PAPER          | 1,000        |
| BOSTON        | SODA           | 2,000        |
| BOSTON        | BOXES          | 1,200        |
| TORONTO       | PAPER          | 1,500        |
| VANCOUVER     | BOXES          | 5,000        |
| COPENHAGEN    | PAPER          | 2,000        |
| PARIS         | SODA           | 1,200        |
| TOKYO         | PAPER          | 4,000        |
| SINGAPORE     | SODA           | 1,000        |
| SINGAPORE     | PAPER          | 2,000        |

A table like this one could become very large in a typical business—too large to tell the manager of sales how the enterprise is doing. From this very large and detailed table, PS/nVision can build a report that

summarizes sales by region and product category, with the option to break these down into offices and individual products.

Assuming that the company defines a tree that groups offices into a hierarchy of sales districts, countries, and international regions, we could use that tree to define rows of a PS/nVision report, with one row for each region. Similarly, we could use a tree of products to put different types of products—office supplies, consumer products, and so on—into separate columns.

The following table shows how the summarized report is displayed.

| <i><b>Region</b></i> | <i><b>Beverages</b></i> | <i><b>Office Supplies</b></i> |
|----------------------|-------------------------|-------------------------------|
| Asia-Pacific         | 1,000                   | 6,000                         |
| North America        | 2,000                   | 8,700                         |
| Western Europe       | 1,200                   | 2,000                         |

## Common Elements Used in This Product Documentation

| <i><b>Field or Control</b></i> | <i><b>Description</b></i>   |
|--------------------------------|---|
| Navigate buttons               | Use these buttons in the PeopleSoft nVision Layout Definition dialog box to select a row, column, or cell.  |
| Retain Contents                | If you clicked the <b>Apply</b> button in the Layout Definition dialog box and you want to reuse all or part of the criteria you just applied, select this option. It preserves all the dialog box information when you navigate to a new cell selection. |

---

## Matrix Layout Components

To create a matrix-based report, you define intersecting criteria in the layout. For example, the Beverages column in the example displays sales data where the product type is a beverage. The row criterion limits the displayed data even further. The first row displays only the data for the Asia Pacific region. The second row displays only the data for the North America region, and so on.

You can specify data selection criteria at the level of the entire spreadsheet, or at the level of a row, column, or individual cell. Generally, you specify criteria at the highest applicable level to avoid repeating criteria at the lower levels. If you have criteria that apply to the entire worksheet, (ledgers and TimeSpans are common global criteria), you specify them at the worksheet level (cell A1). If you have criteria that apply to a row, you enter the criteria in column A for that row. You enter column criteria in Row 1 in the applicable column, and you enter criteria that are unique to a single cell in that cell only.

---

**Note:** Cell criteria affect the efficiency of the report, so you should use them only when necessary.

---

## nPlosion

If a field criterion uses a tree node value, nPlosion automatically adds rows or columns that contain the detail values found under that tree node in the format you specify in your layout. This creates a group of rows or columns that can be summarized—showing just the tree node value—or expanded to show the detail values and the summarized values.

You can also use nPlosion to show detailed TimeSpan information.

## TimeSpan

A TimeSpan limits query or ledger results to those from a particular time period. Although you can use TimeSpans in a query-based matrix layout, they are more commonly used in ledger-based layouts.

## SetIDs and Business Units

PS/nVision uses the setID you specify when creating a matrix layout to determine available choices when you define layout criteria. If the **Use Business Unit in nVision** option is clear, you can omit the setID, but it is recommended that you specify one. If you enter one, it must be valid. To set the **Use Business Unit in nVision** option, select **PeopleTools > Utilities > Administration > PeopleTools Options**.

## Effective Dates

When you define a matrix layout, you must always enter an effective date. Like a setID, this controls available values for defining criteria. For some criteria, you can override the global effective date.

## Related Links

[Defining Query or Ledger Criteria](#)

[Using TimeSpans](#)

[Defining nPlosion Criteria](#)

## Criteria Types

Six types of matrix-layout criteria are available:

- Query criteria

These criteria retrieve an aggregate results column from a PeopleSoft query. The criteria act as data sources for the selected cells.

- Ledger criteria

Using ledger criteria is an alternative to using query criteria as a data source. While you can use both ledger and query criteria in the same layout, typically you use one or the other.

---

**Note:** You select either Query or Ledger criteria on the PeopleSoft nVision Layout Definition – Source dialog box.

---

- Label criteria

These criteria retrieve descriptive field values from either tree nodes or detail values. Like queries and ledgers, these criteria also act as data sources—although the data is always textual rather than numeric.

- Filter criteria

These criteria identify specific detail values from PeopleSoft trees. They act to limit query, ledger, and label criteria.

- Variable criteria

Because you can generate many different report instances from one layout—using report scopes—hard-coded text is not an effective way of labeling a layout. Using PS/nVision variables, you can display information that is specific to each report request and report instance (for example, scope instance number, reporting period, and so on).

- String criteria

You can include strings from the PeopleTools Strings table in a matrix layout. These strings are language-sensitive and are automatically translated into a user's selected language when the report runs.

There are four kinds of criteria—query, ledger, filter, and label—that you can combine with other criteria to retrieve specific values. In fact, two of these types—filter and label—return nothing when used alone. You *must* combine them with another criteria type to retrieve and display any data. You can only use the two remaining criteria types—variable and string—alone. You can use the criteria types in the following ways:

- Query or ledger only

When you use only a query or only a ledger as criteria, the retrieved data for the specified cell is the same as if you ran the query externally. All values for the specified column are aggregated and displayed.

- Query/ledger with field (Field selected as filter criteria)

This is the most commonly used criteria combination. It enables you to limit the values retrieved from the data source (the query or ledger criteria). Essentially, the filter criteria act as a SQL Where clause, limiting the data source results to the rows in which a particular field is found to have the values you specify. You can specify more than one field or field value, in which case the cell displays the combined value of all the query or ledger results that match the filter criteria.

- Label with field

As with query and ledger criteria, filter criteria act as a SQL Where clause to limit label criteria to specific values. You use this combination to retrieve descriptive data to identify rows or columns in a report. If you specify more than one field value in this criteria combination, however, the results are not combined. Instead, only one value (label) appears.

- Variable only

You can only define variable criteria at the cell level—one variable per cell—and only for cells containing no other criteria.

- String only

You can only define string criteria at the cell level—one string per cell—and only for cells containing no other criteria.

In addition to the rules defined above, criteria must not return values for an infinite number of cells. For example, you can define query criteria alone at the cell level because the results are displayed in just one cell. But query criteria in a column with no intersecting filter criteria would—if they were allowed to—return cell after cell of the same value, throughout the entire column. The same situation would occur if you defined criteria at the worksheet level and intersected them with criteria in a row or column.

PS/nVision does not prevent you from defining your criteria in this way, but it does not return any data for these situations. To define criteria at the worksheet level, define the intersecting criteria at the cell level, ensuring data retrieval for a finite number of cells.

For combined criteria, valid level combinations are worksheet and cell, row and cell, column and cell, cell and cell, and row and column.

See [Understanding Ledger-Based Matrix Layouts](#), [Defining Ledger Criteria](#).

## Criteria Inheritance Rules

Cells specified by intersection or by single-cell criteria inherit their selection criteria according to the following rules:

- Criteria defined at the worksheet level specify defaults for the entire worksheet. Criteria at the worksheet level are combined with criteria for columns, rows, and cells, except where the row, column, or cell criteria give a different value for the same criterion. In this case, the worksheet criteria are overridden.
- For the intersection of row and column criteria, criteria are combined where possible. For example, if a row with vendor ID filter criteria intersects with a column using query criteria, both criteria determine the resulting cell value. But if a row and column conflict—for example, if both specify a training location—the row overrides the column criteria.

However, there is a distinction between filter criteria (for example, Product tree nodes), and criteria types limited to one source, such as query or ledger data source, TimeSpan, and reversal. Data source, TimeSpan and reversal criteria follow the override rules, but filter criteria are added as you go through the sheets, columns, and rows (but not cells). Filter criteria accumulate through this process without regard for the fields they reference.

- A cell can inherit other criteria, such as ledger or TimeSpan, from the sheet, column, and row levels. A cell's individual criteria, such as a ledger, overrides anything inherited from another level. However, because a cell might need to exclude criteria for a field, PS/nVision ignores inherited filter criteria at the cell level.
- After the above rules have been applied to constructing a query to retrieve data for a group of rows and columns, any instance criteria (from either a scope or the parent instance of a DrillDown) are applied. These do not replace filter criteria from the layout; the instance criteria are added to the other filter criteria (either sheet, column, row, or cell).

The following illustration summarizes inheritance rules for non-filter criteria.

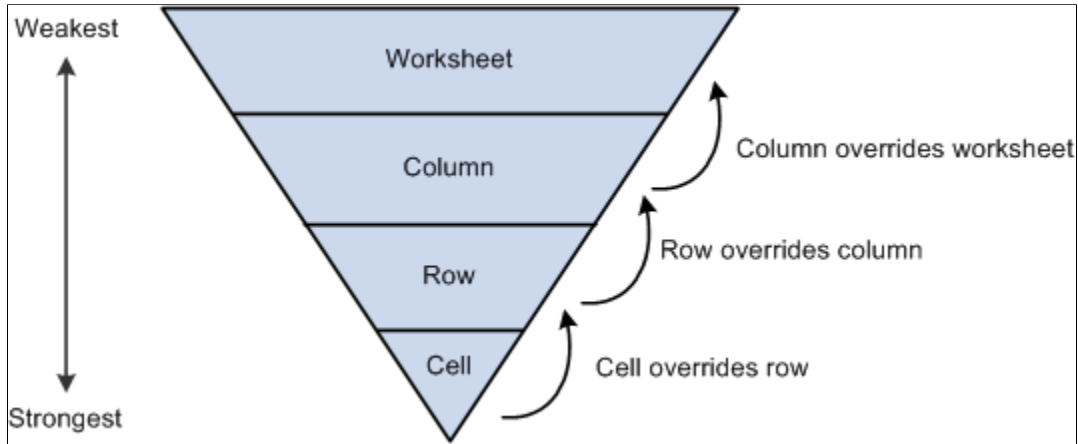

### Criteria Usage

The following tables show the usage for each criteria type at each level.

#### Query Criteria

This table lists the usage for the query criteria type at each level.

| <b>Level</b> | <b>Used at this level?</b> | <b>Used alone?</b> | <b>Combined with other criteria?</b> | <b>Restrictions</b>   |
|--------------|----------------------------|--------------------|--------------------------------------|---|
| Cell         | Yes                        | Yes                | Filter                               | When used alone, filter criteria return query column totals. When combined, the filter criteria must be defined in same cell. |
| Row          | Yes                        | No                 | Filter                               | Filter criteria can be defined in cells or intersecting columns.  |
| Column       | Yes                        | No                 | Filter                               | Filter criteria can be defined in cells or intersecting rows.   |
| Worksheet    | Yes                        | No                 | Filter                               | Filter criteria can be defined in cells only.   |

#### Ledger Criteria

This table lists the usage for the ledger criteria type at each level.

| <b>Level</b> | <b>Used at this level?</b> | <b>Used alone?</b> | <b>Combined with other criteria?</b> | <b>Restrictions</b>   |
|--------------|----------------------------|--------------------|--------------------------------------|---|
| Cell         | Yes                        | Yes                | Filter                               | When used alone, ledger criteria return ledger amount column totals. When combined, the filter criteria must be defined in same cell. |
| Row          | Yes                        | No                 | Filter                               | Filter criteria can be defined in cells or intersecting columns.  |
| Column       | Yes                        | No                 | Filter                               | Filter criteria can be defined in cells or intersecting rows.   |
| Worksheet    | Yes                        | No                 | Filter                               | Filter criteria can be defined in cells only.   |

### Label Criteria

This table lists the usage for the label criteria type at each level.

| <b>Level</b> | <b>Used at this level?</b> | <b>Used alone?</b> | <b>Combined with other criteria?</b> | <b>Restrictions</b>  |
|--------------|----------------------------|--------------------|--------------------------------------|--|
| Cell         | No                         | N/A                | N/A                                  | N/A  |
| Row          | Yes                        | No                 | Filter                               | Filter criteria can be defined in cells or intersecting columns. |
| Column       | Yes                        | No                 | Filter                               | Filter criteria can be defined in cells or intersecting rows.    |
| Worksheet    | No                         | N/A                | N/A                                  | N/A  |

### Filter Criteria

This table lists the usage for the filter criteria type at each level.

| <b>Level</b> | <b>Used at this level?</b> | <b>Used alone?</b> | <b>Combined with other criteria?</b> | <b>Restrictions</b>   |
|--------------|----------------------------|--------------------|--------------------------------------|---|
| Cell         | Yes                        | No                 | Query, Ledger, and Label.            | Query/ledger criteria can be defined in same cell, intersecting rows or columns, or the entire worksheet.<br><br>Label criteria can be defined in intersecting rows or columns. |
| Row          | Yes                        | No                 | Query, Ledger, and Label.            | Query, ledger, and label criteria can be defined in intersecting columns.   |
| Column       | Yes                        | No                 | Query, Ledger, and Label.            | Query, ledger, and label criteria can be defined in intersecting rows.  |
| Worksheet    | Yes                        | N/A                | N/A                                  | N/A   |

### Variable Criteria

This table lists the usage for the variable criteria type at each level.

| <b>Level</b> | <b>Used at this level?</b> | <b>Used alone?</b> | <b>Combined with other criteria?</b> | <b>Restrictions</b>                                     |
|--------------|----------------------------|--------------------|--------------------------------------|---|
| Cell         | Yes                        | Yes                | None                                 | Variables can only be used alone and at the Cell level. |
| Row          | No                         | N/A                | N/A                                  | N/A   |
| Column       | No                         | N/A                | N/A                                  | N/A   |
| Worksheet    | No                         | N/A                | N/A                                  | N/A   |

### String Criteria

This table lists the usage for the string criteria type at each level.

| <b>Level</b> | <b>Used at this level?</b> | <b>Used alone?</b> | <b>Combined with other criteria?</b> | <b>Restrictions</b>                                   |
|--------------|----------------------------|--------------------|--------------------------------------|---|
| Cell         | Yes                        | Yes                | None                                 | Strings can only be used alone and at the Cell level. |
| Row          | No                         | N/A                | N/A                                  | N/A   |
| Column       | No                         | N/A                | N/A                                  | N/A   |
| Worksheet    | No                         | N/A                | N/A                                  | N/A   |

---

## Creating Matrix Layouts

To create a matrix layout in PS/nVision:

1. Create a new layout by selecting **nVision > New Layout** from the nVision menu.
2. Enter a name for your layout.

It is saved as an XNV file.

3. Enter descriptive titles as appropriate in the rows and columns that you plan to use.

These titles are not required, but they can be helpful to mark the rows and columns for which you will define criteria.

4. Select **nVision > Layout Definition** to display the PeopleSoft nVision Layout Options dialog box.
5. Define your layout as a matrix layout and define prompting options.
6. Click the **OK** button.
7. Open a criteria row and column by selecting **nVision > Options > Show Row and Column Criteria**.
8. Place your cursor in the cell where you want to add criteria.
9. Double-click the cell or select **nVision > Layout Definition** to display the PeopleSoft nVision Layout Definition dialog box.
10. Add criteria to the layout.

The type of criteria you define determine the tabs on the PeopleSoft nVision Layout Definition dialog box you use. Add worksheet-level criteria first. This always is cell A1.

To add row criteria, place your cursor on column A, rows 2 through xxx.

To add column criteria, place your cursor on row 1, columns B through xxx.

To add cell criteria, place your cursor anywhere within the spreadsheet that you want the result to appear.

See [Defining Matrix Layout Criteria](#).

---

**Note:** As you create a matrix layout, occasionally run a report request based on the layout to ensure that the layout will work as you expect.

---

## Related Links

[Creating Layouts](#)

---

# Defining Matrix Layout Criteria

This section provides an overview of the process of defining layout criteria. For details about implementing different criteria types, see the sections that follow.

To define matrix layout criteria in PS/nVision:

1. With a nVision layout open, select **nVision** > **Layout Definition** from the nVision menu.
2. From the Layout Definition dialog box, select a layout column to map to a query column.
3. Select the Source tab.

In most cases, you select the Source tab first to define worksheet-level criteria (cell A1).

Define the data source and general TimeSpan for the layout. Applying criteria at the worksheet level helps make the report run more efficiently because you do not have to restate the general criteria in the rows, columns, or cells. You can assign any criteria at the worksheet level that you want (including data from the Filter tab). Whatever criteria you assign in cell A1 can be overridden in the row, column, or cell criteria.

A restriction exists on returning infinite cell values. If you define query or ledger criteria at the worksheet level, you can only display results by using cell-level intersections. Row, column, or worksheet-level intersecting criteria are ignored.

---

**Note:** The **Ledger Type** option is not available if you do not use PeopleSoft Financials products.

---

4. Select the Filter tab.

Use the options on this tab to establish criteria based on ChartFields and to define nPlosion for the ChartFields you selected. This tab is used for defining row, column, or cell criteria.

---

**Note:** Based on the current cell selection and layout criteria previously applied, some buttons on the Filter tab may not be available.

---

5. Define nPlosion defaults.

Setting nPlosion defaults can save time when defining row and column criteria. You set these defaults using the PeopleSoft nVision Layout Options dialog box (**nVision > Layout Options**).

6. Define column, row, and cell criteria—in that order.

Use the **Navigate** buttons to select each column, row, or cell. Then, apply criteria types by selecting the appropriate tabs:

- At the column level—with no previously defined criteria—use the Summary and Label tabs.
- At the row level—with no previously defined criteria—use the Summary, Source, Filter, and Label tabs.
- At the cell level—with no previously defined criteria—use the Summary, Source, Filter, Label, Variable, and String tabs.

By defining worksheet, column, row, and cell criteria—in that order—you define layout criteria in ascending order of precedence. At the cell level, any criteria you enter override conflicting criteria defined at higher levels. Therefore, if you have defined column-level query criteria and you define a different query for a cell in that column, then the query criteria for the cell overrides the column criteria. Remember that if you define filter criteria at the cell level, they are combined with other filter criteria defined at higher levels.

7. Define other layout features.

You may want to provide additional text and Microsoft Excel formulas to the report layout. Now is also a good time to specify the fonts and formatting that you want to apply to any report instances based on this layout.

To enter cell information manually, you must close the PeopleSoft nVision Layout Definition dialog box.

8. Save the new layout.

Click the **Save** button on the Microsoft Excel toolbar or select **File > Save** from the nVision menu to save the layout with the name you established earlier.

9. Run a test report.

You should run a report request based on this layout to verify that the report layout works properly. When you make the report request, PS/nVision should populate a report instance with data from your PeopleSoft database.

## Related Links

[Specifying a Layout Definition](#)

[Creating Report Requests](#)

---

## Defining Query or Ledger Criteria

This section describes how to:

- Select ledger criteria.
- Select query criteria.

## Selecting Ledger Criteria

To select ledger criteria in PS/nVision:

1. With a nVision layout open, select **nVision > Layout Definition** from the nVision menu.
2. Select the Source tab on the PeopleSoft nVision Layout Definition dialog box.
3. Select Ledger from the drop-down list.

The PeopleSoft nVision Layout Definition – Source dialog box appears.

Like query criteria, you can apply ledger criteria at the worksheet, column, row, or cell level.

This example illustrates the fields and controls on the PeopleSoft nVision Layout Definition dialog box: Source tab.

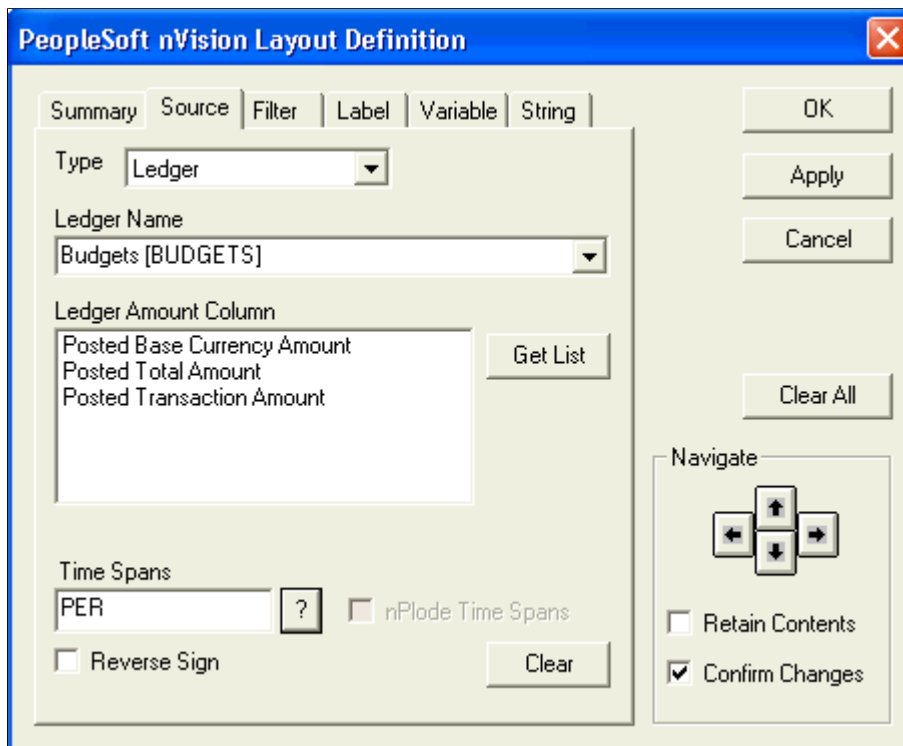

| <b>Field or Control</b>     | <b>Description</b>  |
|-----------------------------|---|
| <b>Ledger Name</b>          | Select the ledger to use.   |
| <b>Ledger Amount Column</b> | Click the <b>Get List</b> button and select an amount column from the list. |

| <i>Field or Control</i> | <i>Description</i>   |
|-------------------------|--|
| <b>TimeSpans</b>        | Select a TimeSpan to limit the amount of information returned in your report.    |
| <b>Reverse Sign</b>     | Select this option to change the sign of the amounts returned from the database. |

See [Understanding Ledger-Based Matrix Layouts](#), [Defining Ledger Criteria](#).

## Choosing Query Criteria

You use a query created with PeopleSoft Query to specify data to be returned to the matrix. Query criteria specify both a query and a query column. You can select only columns that are the result of a SQL aggregate function, such as Sum or Count.

---

**Note:** The aggregate function must return a numeric value for nVision to process this value properly.

---

This example illustrates the fields and controls on the PeopleSoft nVision Layout Definition dialog box: Source tab.

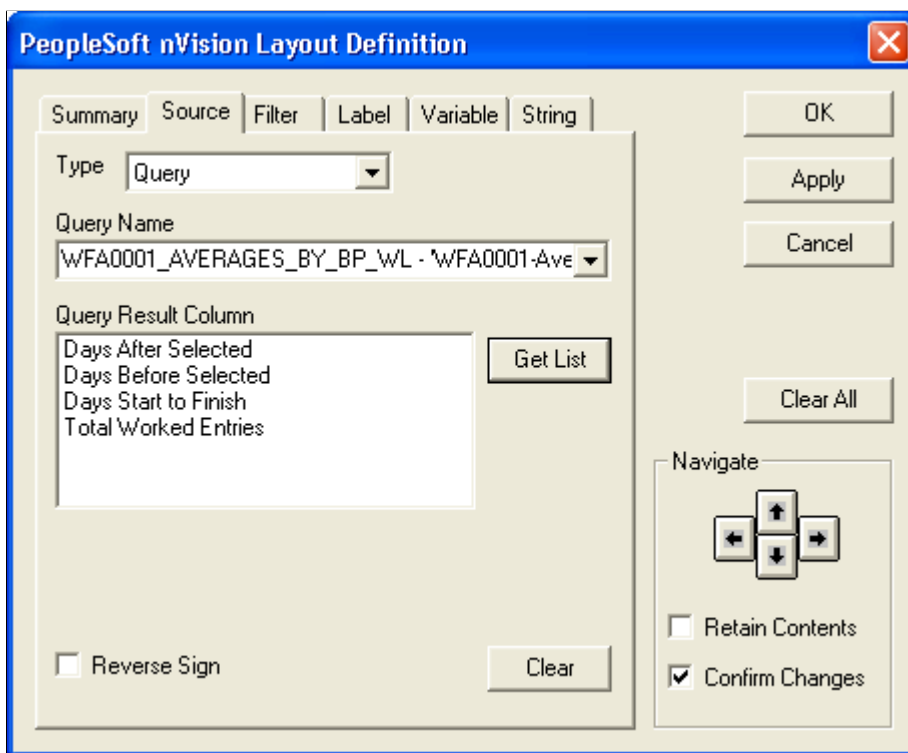

To define query criteria in PS/nVision:

1. With a nVision layout open, select **nVision > Layout Definition** from the nVision menu.
2. From the PeopleSoft nVision Layout Definition dialog box, select the row, column, or cell that you want to apply query criteria.

3. Click the Source tab to view the query criteria options.

The Source tab of the PeopleSoft nVision Layout Definition dialog box appears. Use it to specify the aggregate query column that you want to use as a data source.

4. Select the *Query* option from the Type drop-down list box.

You can also select the *None* option.

5. Specify the query name and click the **Get List** button.

A list of aggregate columns appear in the Query Result Column drop-down list box.

6. Select an aggregate column from the list.

If the query does not contain any aggregate columns, there is *(no entries)* in the drop-down list box.

An aggregate query column is either:

- A data column with an aggregate function (such as Sum or Count).
- An expression containing an aggregate function, with the **Aggregate** option selected.

7. Optionally, select a TimeSpan to limit the query data.

8. To have columns or rows containing TimeSpan details automatically inserted, select **nPlode Time Spans**.

9. To reverse the sign of the amounts returned from the database, select the **Reverse Sign** button.

For example, you might want to see revenue reported as a positive number. This value is normally set for query criteria at the cell, row, or column level rather than at the worksheet level.

10. Click the **Apply** button to save your changes and define query criteria for a different group of cells, or click the **OK** button to save your changes and close the dialog box.

## Related Links

[Using TimeSpans](#)

“Working with Aggregate Functions” (Query)

---

## Applying Filter Criteria

This section provides an overview of filter criteria and discusses how to:

- Select filter criteria options.
- Add field and tree node values to filter criteria.
- Add field and detail values to filter criteria.
- Add criteria values.

- Remove fields and values from criteria.

## Understanding Filter Criteria

Filter criteria comprise field or dimension criteria combined with query or ledger criteria. They display a value from the query column results. You can combine filter criteria with label criteria to display a tree node or detail value as a descriptive label. Using nPlosion, one row or column of filter criteria can generate multiple detail rows or columns.

You can apply filter criteria at the column, row, or cell level.

Filter criteria consist of one or more tree detail values. If you select more than one value for your filter criteria, the total of all specified values is used to limit intersecting query or ledger criteria, and the results appear as one consolidated value. However, where multi-value filter criteria intersect with label criteria, the label values cannot be combined. Only the first label retrieved appears.

You can accept tree effective date when you define criteria. This option enables you to have multiple trees in the layout with different effective dates, and you can compare the results of the reports based on different effective dates. In addition, when you run a report request, you can specify a new effective date that overrides effective date of all trees if effective date was specified in the layout.

---

**Note:** Accept tree effective date at the time of criteria definition is available only in nVision windows client.

---

When defining filter criteria, you can use detail values summarized under particular tree nodes, or detail values from value tables. If a value table is entered in filter criteria, it will be used for prompting and nPlosion labeling. During nPlosion, if some field values do not exist in the value table or if nVision cannot find corresponding labels in the value table for some field values, nVision will not include the amount for those values in the nPloded result.

---

**Note:** If the value table specified for nPloded labels has an incomplete set of values, the total may differ from a non-nPloded total.

---

### Related Links

[Using DrillDown](#)

[Creating Report Requests](#)

## Selecting Filter Criteria Options

Use the PeopleSoft nVision Filter Criteria dialog box to add, modify, and delete the nodes from the criteria.

In addition, you can use this dialog box to include fields that build negative criteria; for example, to select nodes for Not In Criteria of the query. With this feature, you can select multiple values, tree nodes, and dimensions as part of Not In criteria query. After making a list of values to be part of the Select clause with Not-In Criteria, this criterion is inserted as any other criteria into the selected cell of the layout.

To define filter criteria in Windows client:

1. Open nVision client by selecting **Start > Program > nVision.**

2. Open any existing layout or create a new one.
3. If you create a new layout, select the **Matrix Layout Sheet** option, define required values, and click the **OK** button.
4. Select **nVision > Layout Definition** from the menu.

The PeopleSoft nVision Layout Definition dialog box appears.

5. Select the Filter tab, and click the **Add** button.

The PeopleSoft nVision Filter Criteria dialog box appears.

---

**Note:** The PeopleSoft nVision Filter Criteria dialog box can only be opened in nVision's Windows client.

---

This example illustrates the fields and controls on the PeopleSoft nVision Layout Definition - Filter dialog box.

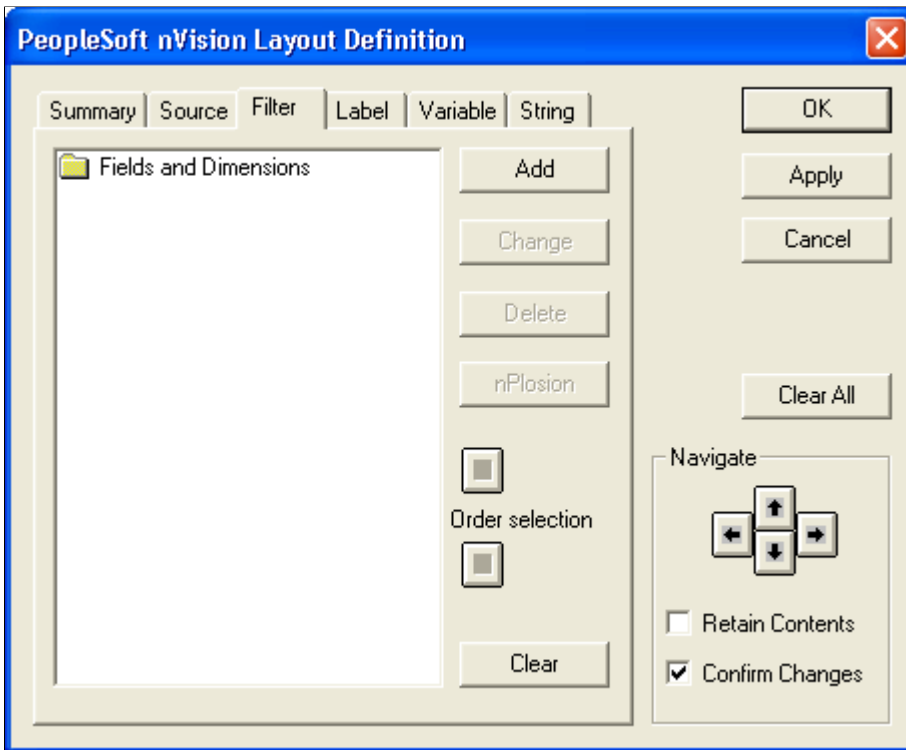

This example illustrates the fields and controls on the PeopleSoft nVision Filter Criteria dialog box, which enables you to select the fields and field values to use as filter criteria.

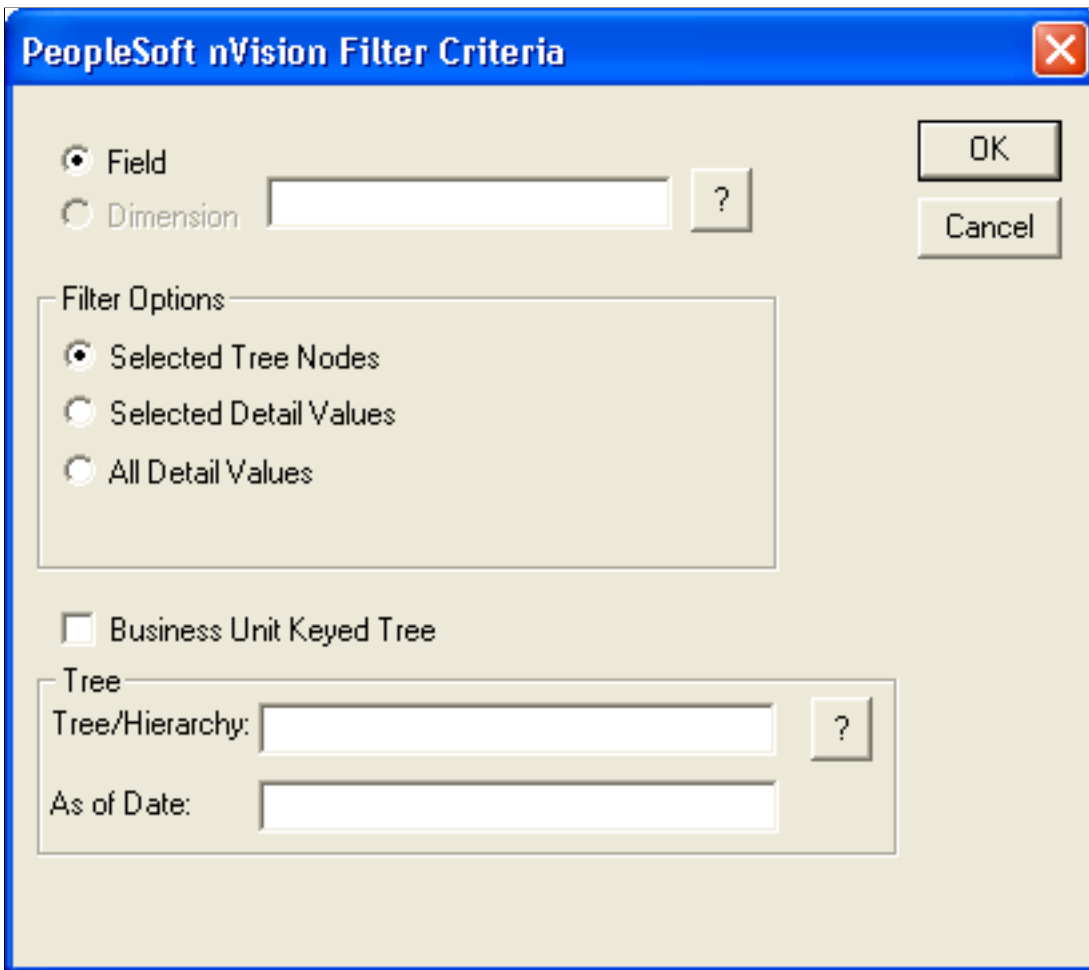

| <b>Field or Control</b> | <b>Description</b>   |
|-------------------------|--|
| <b>Field</b>            | <p>The text box to the right of the <b>Field</b> option displays the field that will be used as criteria. It displays value for only one field at a time—whichever field is selected in the upper text box.</p> <p>You add fields to this list by clicking the <b>Search (?)</b> button and selecting field names. To select from a list of fields, type in a partial name before clicking the <b>Search</b> button.</p>   |
| <b>Filter Options</b>   | <p>Use the Filter Options section to specify the source of the field values that you want to add to the filter criteria: <b>Selected Tree Nodes</b>, <b>Selected Detail Values</b>, or <b>All Detail Values</b>.</p> <p>If your database contains ledgers, the <b>Selected Summary ChartField Nodes</b> option appears. If the <b>Selected Summary ChartField Nodes</b> option is selected, the <b>Tree</b> fields appear prompting you to select a tree from which you select node values to use as criteria. You can select any tree that uses the specified field for its node values and is defined for the setID and effective date associated with the layout.</p> |

| <b>Field or Control</b>         | <b>Description</b>   |
|---------------------------------|--|
| <b>Business Unit Keyed Tree</b> | Select this option if your criteria is based on a business unit keyed tree.  |
| <b>Tree/Hierarchy</b>           | <p>Displays the name of the tree.</p> <hr/> <p><b>Note:</b> In a dynamic detail tree structure, the field name of the detail values should match the field name of the tree nodes. If these two field names do not match, then an error message appears indicating that the tree is invalid.</p> <hr/> |
| <b>As of Date</b>               | <p>Optionally, enter the As of Date values for the tree.</p> <p>If the As of Date value is earlier than the effective date of the tree or is invalid, an error message appears when you save the criteria.</p>   |

**Related Links**

[Using Filter Criteria](#)

[Using Summary ChartField Nodes](#)

[Multiple Scope Fields](#)

[Creating Requests](#)

**Adding Field and Tree Node Values to Filter Criteria**

To access the PeopleSoft nVision Tree Nodes dialog box:

1. Open nVision client.
2. Open any existing layout or create a new one.
3. If you create a new layout, select the **Matrix Layout Sheet** option, define required values, and click the **OK** button.
4. Select **nVision > Layout Definition** from the menu.

The PeopleSoft nVision Layout Definition dialog box appears.

5. Select the Filter tab, and click the **Add** button.

The PeopleSoft nVision Filter Criteria dialog box appears.

6. Click the **OK** button.

The PeopleSoft nVision Tree Nodes dialog box appears.

This example illustrates the fields and controls on the PeopleSoft nVision Tree Nodes dialog box.

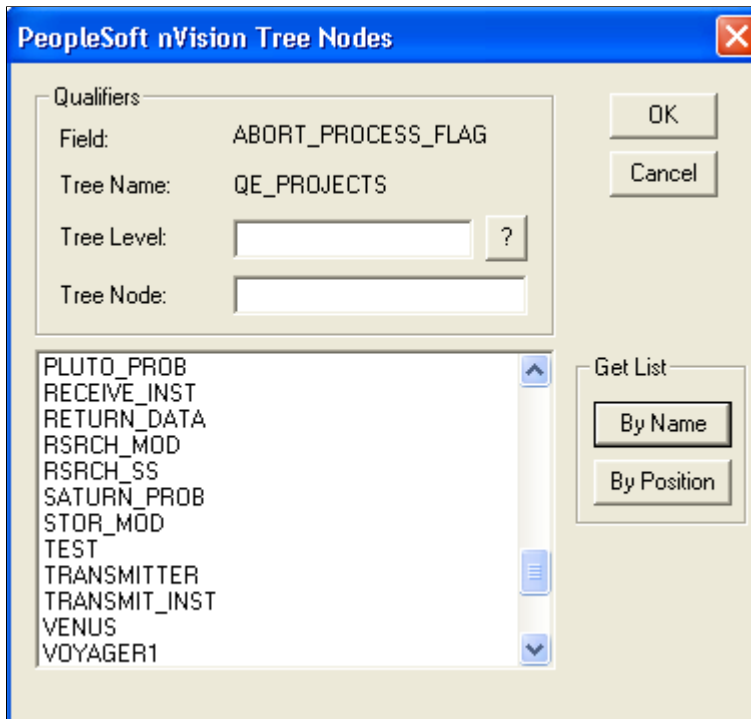

To add a field and tree node values to filter criteria in PS/nVision:

1. Open any existing layout or create a new one.
2. Select **nVision** > **Layout Definition** from the menu.
3. Select the Filter tab, and click the **Add** button.

The PeopleSoft nVision Filter Criteria dialog box appears.

4. In the PeopleSoft nVision Filter Criteria dialog box, click the prompt button to the right of the **Field** option.
5. Select a field name and click the **OK** button.
6. Enter a partial tree name in the **Tree/Hierarchy** field and click the prompt button.
7. Select a tree and click the **OK** button.

The Tree Nodes dialog box appears.

8. If you know the exact node you want to add, enter it in the **Tree Node** field and click the **OK** button.

The Tree Nodes dialog box closes and you are returned to the PeopleSoft nVision Layout Definition – Filter Criteria dialog box, which has an added node in the list box.

9. Optionally, apply a node list filter.

To limit node choices to a particular level, select a valid tree level.

To limit node choices to a particular tree branch, enter the tree node at the top of the branch.

10. Display the node list.

To see an alphabetical list of the tree nodes, click the **By Name** button. Use this button if you have specified a tree level. If you have also specified a tree node, it must be a valid node in the level or no nodes will appear in the list.

To see the hierarchical node structure of the tree—similar to what you would see in Tree Manager—click the **By Position** button. Use this button if you have specified a tree node. If you also specified a tree level, it is ignored.

---

**Note:** You can use the two list filtering buttons together to help you find the nodes you want. For example, you might first want to see nodes at a particular tree level, in alphabetical order, using the **By Name** button to find the higher-level node that you want. Then, you can specify that tree node and click the **By Position** button to see the portion of the tree headed by that node.

---

11. Highlight the nodes you want to add.

12. Click the **OK** button to add the highlighted nodes.

The Tree Nodes dialog box closes. You can now see the new node values listed in the tree control list box of the PeopleSoft nVision Layout Definition – Filter dialog box.

## Adding Field and Detail Values to Filter Criteria

This example illustrates the fields and controls on the PeopleSoft nVision Criteria Values dialog box.

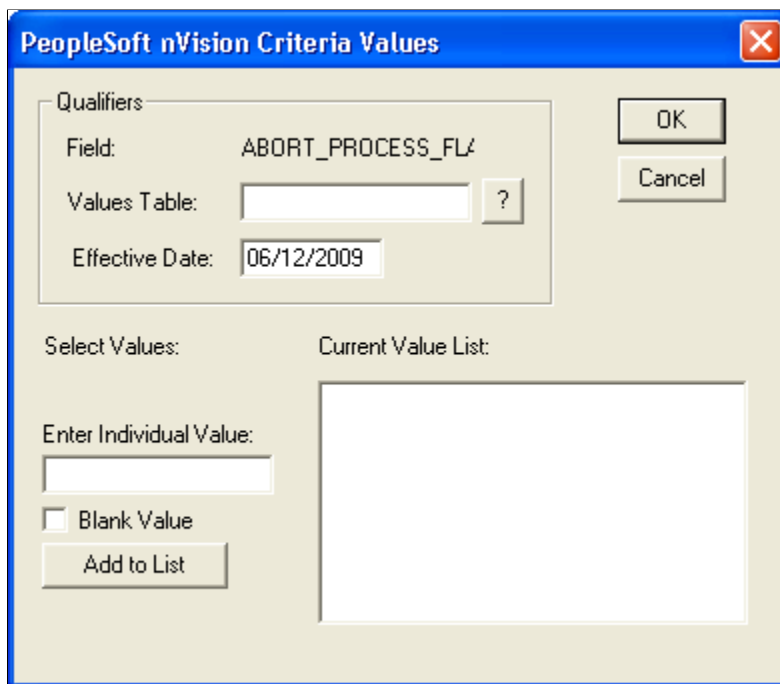

To add a field and detail values to filter criteria in PS/nVision:

1. Open any existing layout or create a new one.
2. Select **nVision > Layout Definition** from the menu.

3. Select the Filter tab, and click the **Add** button.

The PeopleSoft nVision Filter Criteria dialog box appears.

4. Enter a field name.
5. Select either the *Selected Detail Values* option or the *All Detail Values* option.

---

**Note:** If the field is a DrillDown child layout, you can select all detail values from a tree node. The *All Detail Values* option is used primarily with nPlosion and DrillDown features.

---

6. If you selected the *All Detail Values* option, enter a values table name.
7. Click the **OK** button.

If you selected the *All Detail Values* option, the Field Name dialog box closes and the PeopleSoft nVision Layout Definitions – Filter dialog box appears again. You can skip the rest of this procedure if you do not need to add specific values and you are using all of them.

If you select the **Selected Detail Values** option, the PeopleSoft nVision Criteria Values dialog box appears. You use this dialog box to specify the tree detail values you want to add to your filter criteria.

8. In the **Qualifiers** group box of the PeopleSoft nVision Criteria Values dialog box, specify a values table.
9. Optionally, enter a new effective date.

The default effective date is the value you specified when creating the layout definition.

10. Select the values to add.

If you know the value you want, enter it in the **Enter Individual Value** field and click the **OK** button. Otherwise, use the prompt button to display a list of detail values from the Values Table that you specified. You can select multiple values before clicking the **Add to List** button.

11. Select the **Blank Value** option—with the **Enter Individual Value** field empty—to include a null value.
12. Click the **Add to List** button.

Clicking the **Add to List** button adds a null value to the list, represented graphically by *(None)* in the Current Value List text box. The null value appears at the top of the list in the list box, but the actual null value is inserted at the bottom of the list on the PeopleSoft nVision Layout Definition – Filter dialog box.

You can change the order of a value by using the order selection controls on the PeopleSoft nVision Layout Definition – Filter dialog box.

13. Click the **OK** button to save your changes and to close the PeopleSoft nVision Criteria Values dialog box.
14. Click the **OK** button again to close the PeopleSoft nVision Layout Definition dialog box.

See [Using DrillDown](#), [Using DrillDown Navigation](#), [Using DrillDown Layout Formats](#).

## Adding Criteria Values

To add criteria values in PS/nVision:

1. Open any existing layout or create a new one.
2. Select **nVision > Layout Definition** from the menu.
3. Select the Filter tab, and click the **Add** button.
4. On the PeopleSoft nVision Filter Criteria dialog box, select a specified field.

If you have not specified any fields, you must do so now. During that procedure, you are prompted to add criteria values.

5. Click the **Add** button.
6. At the new dialog box, add your values.

## Removing Fields and Values from Filter Criteria

In PS/nVision, to remove a field and its values from filter criteria:

1. Open any existing layout or create a new one.
2. Select **nVision > Layout Definition** from the menu.
3. Select the Filter tab, and click the **Add** button.
4. On the PeopleSoft nVision Filter Criteria dialog box, select the field to remove.
5. Click the **Delete** button.

In PS/nVision, to remove a field value from filter criteria:

1. Open any existing layout or create a new one.
2. Select **nVision > Layout Definition** from the menu.
3. Select the Filter tab, and click the **Add** button.
4. On the PeopleSoft nVision Filter Criteria dialog box, select the field value you want to remove.
5. Click the **Delete** button.

---

## Using Label Criteria

You can use label criteria to add descriptive information that corresponds to filter criteria you have defined in the rows and columns of the layout. When you define label criteria, you specify a tree node name or a detail value as the label source. PS/nVision uses this information to generate row and column labels automatically at runtime from detail or tree node records in the database. When you run the report, the rows and columns appear with their labels. Report labels are particularly useful with nPloded rows

and columns, because these are generated by PS/nVision, and you do not have a chance to label them yourself.

You can define label criteria at the row or column level. You cannot define them in any row or column that already contains other criteria types. To label filter criteria entered in the rows of the layout, specify the label criteria in an intersecting column; if you are labeling filter criteria columns, put the label criteria in a row.

This example illustrates the fields and controls on the PeopleSoft nVision Layout Definition dialog box: Label tab.

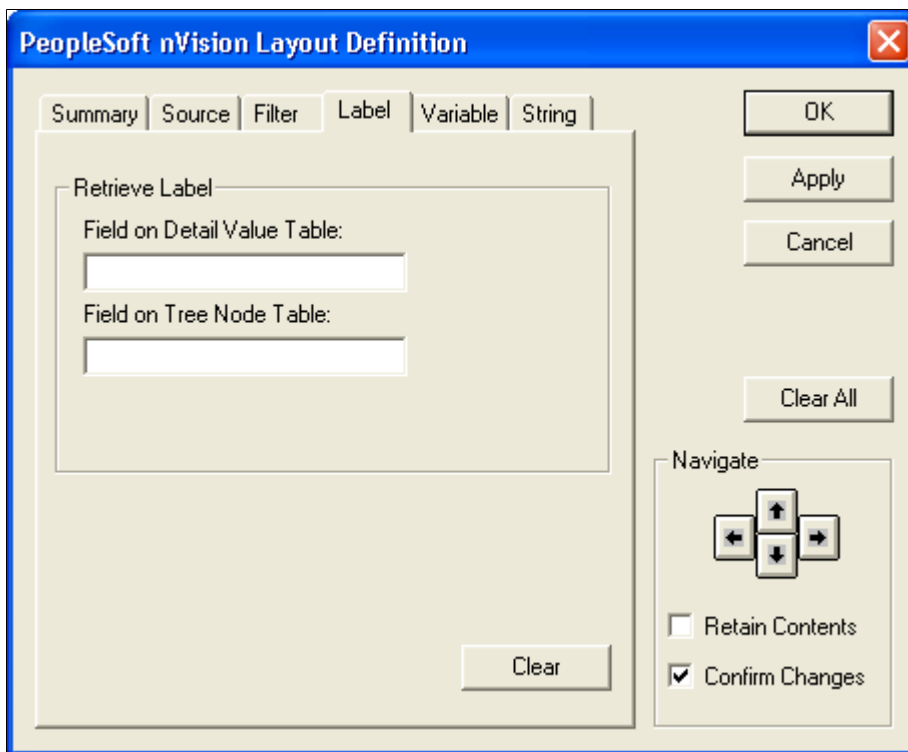

To define label criteria in PS/nVision:

1. Open any existing layout or create a new one.
2. Select **nVision > Layout Definition** from the menu.
3. In the PeopleSoft nVision Layout Definition dialog box, select the row or column to which you want to apply label criteria.
4. Select the Label tab.
5. Use the **Retrieve Label** group box to specify where you want the label to be retrieved from.

If you are labeling filter criteria that are based on detail table values, use the **Field on Detail Value Table** field to specify a label source. You should also use this field if you want to label the nPloded rows or columns of node-based filter criteria. Enter either the field name itself or a descriptive field from the detail value table, which is defined in the tree structure.

---

**Note:** If you are using fiscal year TimeSpans, you can also specify a special label for nPloded TimeSpans by entering *ACCOUNTING\_PERIOD* in the **Field on Detail Value Table** field.

---

If you are labeling filter criteria based on tree node values, use the **Field on Tree Node Table** field to specify a label source. For detail or summary tree node values, enter either *TREE\_NODE* or *DESCR*, as these are the only descriptive fields on the *TREE\_NODE\_TBL* (as delivered).

For node-oriented trees, enter either the field name itself or another descriptive field from the table that supplies the node values, as defined in the tree structure. For example, for filter criteria based on nodes in the *DEPT\_SECURITY* tree, you might use *DEPTID*, *DESCR*, or *SHORTDESCR*.

6. Select your runtime options.

The **Runtime Options** group box is not visible until you enter a field name in the **Retrieve Label** group box.

If you select the *Put labels in blank cells only* option, the labels will not overwrite any text, PS/nVision variable, or strings that you have inserted in the layout.

If you have selected a column, you can also select the *Resize column for labels* option. This value automatically applies the Excel AutoFit command to the column at runtime, which makes the column as wide as the widest label.

7. Click the **Apply** button to save your changes and define label criteria for a different row or column.

Alternatively, click the **OK** button to save your changes and close the dialog box.

## Related Links

“Understanding Types of Trees” (Tree Manager)

---

## Adding Variable Criteria

This section provides an overview of variable criteria and explains how to define the criteria.

## Understanding Variable Criteria

You insert PS/nVision variables into the layout to display heading information that might change from report to report, or between report runs. For example, you could use a variable to automatically insert the report ID you specify in the Report Request dialog box, so you do not restrict this layout to a single purpose. Remember that your layout may be used with a scope that changes its contents, which could make a hard-coded title misleading.

You can define variable criteria at the cell level only—one variable per cell—and the variable must be the only element in that cell.

---

**Note:** Besides using PS/nVision variables in your layouts, you can use some of these variables in the Instance Controls section of the PeopleSoft nVision Report Request dialog box.

---

When inserting a variable into a cell, you select it from the Variable tab of the PeopleSoft nVision Layout Definition dialog box. Because there are many different variables to select from, the dialog box displays them by category. Tables describing the variables in each category follow.

**Note:** When you select a variable, you select its three-letter code. However, when a variable is used in a layout or report request, its code must be enclosed within percent signs (for example, %RID%). The following tables omit the percent signs.

## Report Request Variables

The Report Request dialog box defines most of the values that are returned by using the variables in the following table.

| <i>Variable</i> | <i>Returned Value</i>                            | <i>Sample Value</i>          | <i>Remarks</i>   |
|-----------------|--|------------------------------|--|
| <i>DTS</i>      | Detail or Summary (nPlosion enabled or disabled) | S                            | Defined in the Report Request dialog box: S= Summary (nPlosion disabled)D= Detail (nPlosion enabled).      |
| <i>ICT</i>      | Instance Counter                                 | 1                            | Starts at 1 and is increased by increments of 1 for each additional instance.                              |
| <i>IDN</i>      | Instance Directory Name                          | C:\USER\NVISION<br>\INSTANCE | Full path.<br><br>The Directory Template field defines the full path in the Report Request dialog box.     |
| <i>IFN</i>      | Instance Output File Name                        | <Various>.XLS                | The File Template field defines the path in the Report Request dialog box. The .XLS extension is included. |
| <i>LAN</i>      | Language Template                                | ENG                          | Defined in the Report Request dialog box.  |
| <i>LYN</i>      | Layout Name                                      | <Various>                    | Defined in the Report Request dialog box. (Does not include the .XNV extension.)                           |
| <i>OPC</i>      | User Class                                       | ALLPANLS                     | Provided by the PeopleSoft security tables.  |
| <i>OPL</i>      | User Language                                    | ENG                          | Provided by the PeopleSoft security tables.  |

| <b>Variable</b> | <b>Returned Value</b> | <b>Sample Value</b> | <b>Remarks</b>                              |
|-----------------|-----------------------|---------------------|---|
| <i>OPR</i>      | User ID               | WPS004              | Provided by the PeopleSoft security tables. |
| <i>RID</i>      | Report Name           | <Various>           | Defined in the Report Request dialog box.   |
| <i>RBK</i>      | Report Book Name      | N/A                 | N/A   |
| <i>RTT</i>      | Report Title          | <Various>           | Defined in the Report Request dialog box.   |

### Date and Time Period Variables

This table lists the values that enable you to label layouts where different accounting periods are reported in each instance.

| <b>Variable</b> | <b>Name</b>                | <b>Sample Value</b> | <b>Remarks</b>                            |
|-----------------|----------------------------|---------------------|---|
| <i>APA</i>      | Period Abbreviation        | DEC                 | N/A                                       |
| <i>APN</i>      | Period Name                | December            | N/A                                       |
| <i>ASD</i>      | As of Reporting Date       | 2003-12-31          | Defined in the Report Request dialog box. |
| <i>AST</i>      | As of Tree Date            | 2004-01-01          | Defined in the Report Request dialog box. |
| <i>FY2</i>      | Year (YY)                  | 04                  | N/A                                       |
| <i>FY4</i>      | Year (YYYY)                | 2004                | N/A                                       |
| <i>PED</i>      | End Date of Current Period | 2004-12-31          | N/A                                       |
| <i>PER</i>      | Accounting Period          | 12                  | N/A                                       |

### Scope-Related Variables

The following table lists the values that enable you to label layouts for which you have defined a report scope. A scope is used to define multiple instances of a report based on different field values. For

example, you could produce an instance of an expense report for each department, or an operations summary for each business unit.

| <b>Variable</b> | <b>Name</b>                  | <b>Sample Value</b>         | <b>Remarks</b>   |
|-----------------|------------------------------|-----------------------------|--|
| <i>BUV</i>      | Business Unit Name           | M04                         | Defined in the Report Request dialog box.  |
| <i>BUN</i>      | Business Unit Description    | US1 Manufacturing           | N/A  |
| <i>SCN</i>      | Scope Name                   | DEPARTMENT                  | N/A  |
| <i>SCD</i>      | Scope Description            | Sales Departments           | N/A  |
| <i>SFN</i>      | Scope Field Name             | DEPTID                      | N/A  |
| <i>SFV</i>      | Scope Field Value            | FINDEVELOP                  | N/A  |
| <i>SFD</i>      | Scope Field Description      | Financial Development       | N/A  |
| <i>STN</i>      | Scope Tree Name              | FUNCROLLUP                  | N/A  |
| <i>STD</i>      | Scope Tree Description       | Functional Organization     | N/A  |
| <i>SLN</i>      | Scope Tree Level Name        | DIVISION                    | N/A  |
| <i>SLD</i>      | Scope Tree Level Description | Instances for each division | N/A  |
| <i>DES</i>      | Scope Descriptive Field      | FINDEVELOP                  | A user-defined variable that retrieves descriptive information from a field in either the detail value table or the tree node table. |

## **Related Links**

[Understanding Report Scopes](#)

[Defining Scopes](#)

[Creating Requests](#)

## Defining Variable Criteria

This example illustrates the fields and controls on the PeopleSoft nVision Layout Definition dialog box: Variable tab.

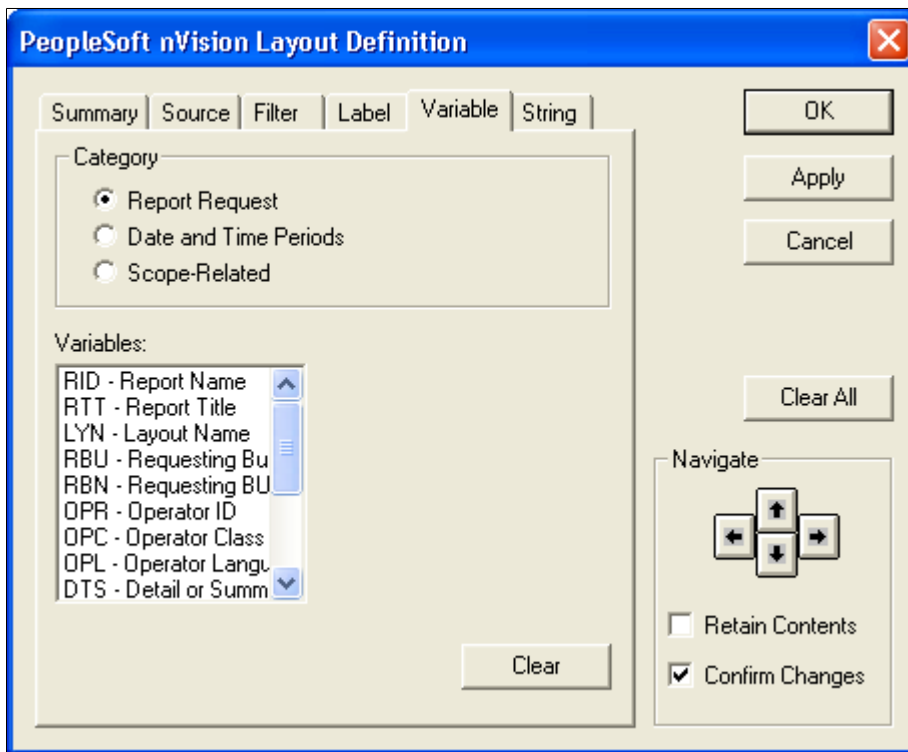

To define variable criteria in nVision:

1. Open any existing layout or create a new one.
2. Select **nVision > Layout Definition** from the menu.
3. In the PeopleSoft nVision Layout Definition dialog box, select the cell to which you want to apply variable criteria.
4. Select the Variable tab.
5. Select the appropriate category, and then select a variable.
6. If you selected one of the **Date and Time Periods** variables, specify a ledger.

When you select the **Date and Time Periods** option and you click a variable in the Variables list, the **Ledger** field appears.

7. If you selected one of the **Scope-Related** variables, fill in the **Scope Field** field, if necessary.

When you select any Scope Related variable except SCN or SCD, the **Scope Field** text box appears to the right of the **Variables** field.

If the layout uses a scope that has multiple fields, use the **Scope Field** option to specify the scope field on which to base the variable you want to insert. For example, if you defined a scope using the **Department** and **Product** fields, and wanted a descriptive field from the Department table to appear on your report, you would enter *DEPTID* as the scope field.

---

**Note:** If you do not specify a scope field, the default value is the first field defined in the scope.

---

8. If you selected the DES variable, indicate where to retrieve the descriptive information.

The Descriptive Field (DES) variable is user-defined and retrieves text information from either the tree node table or detail value table associated with a field in the scope. For example, if your scope is based on DEPTID, and creates an instance for each tree node at the Division level, you can use variables to identify each instance with the division name and related information from the tree node.

Use the **Field on Detail Value Table** field to retrieve descriptive information from any text field on the detail values table that is associated with the scope field. For example, if you were generating instances of a report using a scope based on detail values of the Department field, you could enter the name of any descriptive field, such as the Manager\_Name field, on the Department table, and the text contained in that field would appear on each department's instance of the report.

Use the **Field on Tree Node Table** field to retrieve descriptive information from any text field on the tree node table (usually named TREE\_NODE\_TBL) when using a tree-based scope. For example, if you added a field for the manager responsible for each node in your tree, you could retrieve this information by specifying the field name, such as Mgr\_Name, from the tree node table.

9. Click the **Apply** button to save your changes and define filter criteria for a different cell.

Alternatively, click the **OK** button to save your changes and close the dialog box.

---

## Defining String Criteria

Layouts typically contain a considerable amount of constant text, such as the column headings “Last Year to Date” or “Current Budget.” With PS/nVision, you can build multilingual layouts where these text strings are replaced by specially formatted strings whose user-language equivalent is retrieved from a table in the database. These string names are somewhat like user-defined PS/nVision variables.

You insert string criteria into layout cells with the following format:

```
%.<name>,R<program>%
```

*Name* is the string name as described in the following table and *program* is the program ID group that contains the string definition. In this example

```
%.STDHDG_PAGE_NO,RSTDHDGTR%
```

the string name is STDHDG\_PAGE\_NO and the program ID is STDHDGTR.

When you select a string to insert, you can select from strings created specifically for use with PS/nVision—that is, strings with a program ID of NVISION. If you insert one of these strings, the program name does not appear in the string. For example:

```
%.DATE_LABEL%
```

This example illustrates the fields and controls on the PeopleSoft nVision Layout Definition dialog box: String tab.

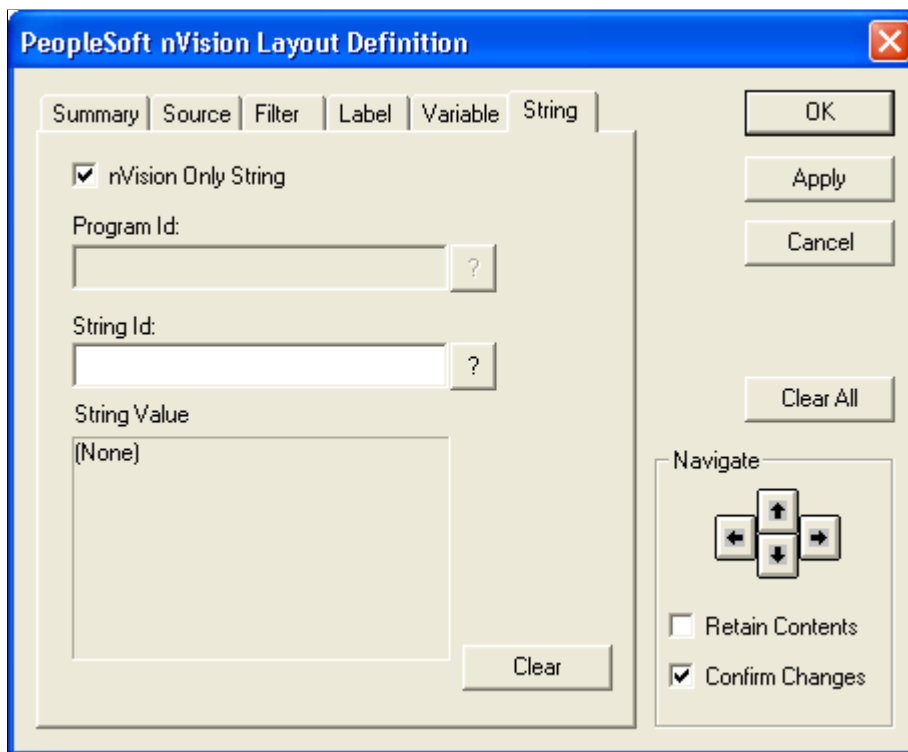

To define string criteria in PS/nVision:

1. Open any existing layout or create a new one.
2. Select **nVision > Layout Definition** from the menu.
3. On the PeopleSoft nVision Layout Definition dialog box, select the cell to which you want to apply string criteria.
4. Select the String tab.
5. Clear the **nVision Only String** option if appropriate.

By default, the String tab displays only strings that were created for use with PS/nVision—those with a program ID of NVISION.

To select from all available strings, clear the **nVision Only String** option.

6. If the **nVision Only String** option is cleared, select a program ID.
7. Select the String ID of the string you want to insert.

You can select from the strings assigned to the program ID that you specified.

---

**Note:** If the **nVision Only String** option is selected, the program ID is NVISION.

---

8. Click the **Apply** button to save your changes and define string criteria for a different cell.

Alternatively, click the **OK** button to save your changes and close the dialog box.



# Creating Ledger-Based Matrix Layouts

---

## Understanding Ledger-Based Matrix Layouts

A ledger is a special type of query in PS/nVision, with an implied aggregate operation (sum) and record and field names specified through the ledger definition. In PS/nVision, a ledger-based layout is essentially a matrix layout that uses the ledger table in place of a query. Typically, you use ledger-based layouts with applications such as PeopleSoft General Ledger or Enterprise Performance Management. Although you can use ledgers and queries in the same report, ledger and query specifications are mutually exclusive for a row or column, because a row, column, or cell can have only one data source.

These topics discuss the differences between ledger-based layouts and reports and query-based matrix layouts.

### Related Links

[Understanding Matrix Layouts](#)

[Creating Matrix Layouts](#)

---

## Defining Ledger Criteria

When you define ledger criteria, you can select the same options as with query-based matrix layouts. As with query criteria, you can apply ledger criteria at the worksheet, column, row, or cell level.

This example illustrates the fields and controls on the PeopleSoft nVision Layout Definition dialog box: Source tab.

To define ledger criteria in PS/nVision:

1. Open any existing layout or create a new one.
2. Select **nVision** > **Layout Definition** from the menu.
3. In the PeopleSoft nVision Layout Definition dialog box, select the row, column, or cell that apply ledger criteria.

Use the Navigate controls to select the location.

4. Select the Source tab, and then select *Ledger* as the source type.
5. Select a ledger from the **Ledger Name** drop-down list box.
6. Select a ledger amount column by clicking the **Get List** button and clicking the available columns that appear.
7. Select a TimeSpan to limit the ledger data.
8. To have columns or rows containing TimeSpan details automatically inserted, select the **nPlode Time Spans** option.

The **nPlode Time Spans** option appears only if you have a row or column selected.

9. To reverse the sign of the amounts returned from the database, select the **Reverse Sign** option.

For example, you may want to see revenue reported as a positive number. This setting is normally selected for query criteria at the cell, row, or column level, not the worksheet level.

10. In the **Ledger Amount Column** field, select the ledger amount to report on.

---

**Note:** If the ledger contains separate credit and debit columns, they appear in the **Ledger Amount Column** field.

---

11. Click the **Apply** button to save your changes and define ledger criteria for a different group of cells.

Alternatively, click the **OK** button to save your changes and close the dialog box.

If you clicked the **Apply** button and you want to reuse all or part of the criteria you just applied, select the **Retain Contents** option. This selection preserves the dialog box information when you navigate to a new cell selection. Then, repeat the procedure to define more ledger criteria.

---

## Using TimeSpans

TimeSpans express fiscal-year and accounting-period ranges relative to the main as-of date specified in the report request. TimeSpans control the periods for which data is extracted from the database. Many TimeSpans are expressed relative to the current period, so that they automatically adapt the content of a report to the report as-of date. TimeSpans are required when you use ledgers, but they are optional with queries.

An example of using TimeSpans is an earnings summary report that compares earnings from the end of 2000 to the end of 2001, broken down by four quarters. Revenue from operations and net earnings are listed down the left side of the report, while quarterly earnings appear across the top of the report as column headings. You select the appropriate QTR TimeSpan for each quarter at the column level. Then, you specify the Accounts ledger in the criteria for the entire spreadsheet. For the rows, specify the individual accounts whose earnings you want to report on.

### Relative Adjustment Periods

Use the following example to specify the Relative Adjustment Period. To retrieve  $x$  number of periods back:

```
"BaseAdjustmentPeriod - x"
where BaseAdjustmentPeriod = (FirstAdjustmentPeriod - 1).
```

For example, FirstAdjustmentPeriod = 901 (for period 1). BaseAdjustmentPeriod = 900. To specify the last two adjustment periods, Relative StartAdjustmentPeriod should be 898.

To retrieve  $x$  number of periods ahead:

```
"BaseAdjustmentPeriod + x".
```

Using the example above, to retrieve two periods ahead, define Relative EndAdjustmentPeriod as  $900 + 2 = 902$ .

---

## Using Filter Criteria

As with other matrix layouts, you use filter criteria to specify the character field values (such as ACCOUNT) selected for rows and columns of the report.

As in query-based layouts, filter criteria can be expressed in terms of detail values or tree nodes, and can be nPloded to generate multiple detail rows or columns. However, with ledger-based layouts, filter criteria also can be expressed as summary ChartField nodes.

## Using Summary ChartField Nodes

When defining filter criteria for a database containing ledgers, you can use summary ChartField nodes as criteria values. This use of summary ChartField nodes retrieves data from a summary ledger ChartField that contains tree nodes as values. Detail ledger ChartFields serve as keys to the detail ledger by categorizing posted total amounts. You can create summary ledgers that roll up detail amounts based on specific detail values or on selected tree nodes. When detail values are summarized using tree nodes, you must use summary ChartFields in the summary ledger data record. The maximum length of a node name is 20 characters.

For example, values contained in a Department ChartField (such as DEPTID 0100, 0200, 0300, and so forth) on a detail ledger can be rolled up (using an organizational tree) into a Division ChartField on a summary ledger. You can store these values with summary ChartField node names such as Sales, Marketing, and Administration.

You can use summary trees or summary ChartField nodes to access data from a summary ledger of this type. You should use summary trees because then you can create different rollups of the summarized nodes and use nPlosion on them. When you drill down, summary trees also let you translate summary criteria to the corresponding detail criteria back in the general ledger. When specifying criteria via a summary tree, click the **Selected Tree Nodes** option in conjunction with the summary ChartField.

---

**Note:** PS/nVision does not support the translation of summary ChartField nodes when you are drilling down to the detail ledger. Use the summary tree criteria.

---

To add a field and summary ChartField node values to filter criteria in PS/nVision:

1. Follow the procedure for adding tree node values.  
See [Using Filter Criteria](#).
2. From the Field Name dialog box, select the *Selected Summary ChartField Nodes* option.

---

## Adding Label Criteria

Label controls are available on ledger-based layouts, just as they are on any matrix layout.

If you are basing the layout on a ledger, you can retrieve label text from a number of fields defined in Application Designer for the detail or tree node table of a ChartField. You can also specify a special label for nPloded TimeSpans in the format YYYY-PP (year-period) by entering *ACCOUNTING\_PERIOD* in the **Detail Values** field.

---

## Using nPlosion

For PeopleSoft General Ledger, note that nPlosion is available for detail ledger ChartFields or summary ledger ChartFields that contain detail values, and for summary ledger ChartFields accessed through

summary trees. nPlosion is not available for summary ledger ChartFields specified as Selected Summary ChartField Nodes. For other applications, nPlosion is available for criteria fields that have value tables listing the valid values of the field (usually, this is the prompt table for that field).

### **Related Links**

[Understanding nPlosion](#)



## Chapter 7

# Defining Report Scopes

---

## Understanding Report Scopes

A report scope enables you to create multiple instances of a report using a single report layout and report request. Using a scope, each report instance contains data specific to an individual field value, such as a business unit or department, or to a group of values, such as a tree node that summarizes all sales departments. In this way, each report instance can share the same layout, while containing data unique to these field values. You might run three instances of an expense report that share the same layout but contain the expenses of one division each.

When defining a report request, you can use the scope feature to create multiple instances of a report from a single request.

You can specify more than one field in the scope to create instances that represent combinations of values of multiple fields. For example, you can use a multi-field scope to create an instance for each product line (a grouping of products) within each region (a grouping of departments).

Whenever you use scope to produce multiple instances of a report, use PS/nVision variables in the layout headings to identify the content of each report.

### Related Links

[Adding Variable Criteria](#)

## Multiple Scope Fields

When you define a new scope, you must determine how many instances to produce and how each instance is summarized.

If your scope is based on two or more fields (such as business unit and product), PS/nVision normally produces a report instance for each combination of the selected nodes or detail values for all specified fields. However, you might have data for only a subset of these combinations—for example, if each business unit sells only a subset of the total list of products. You could limit the number of report instances produced by defining multiple scopes, specifying only the valid combinations, and using different report requests to apply these scopes to appropriate layouts. But if you are working with many combinations, a better solution is to create a field combination table containing only the field value combinations you want for your scope. If you specify a field combination table, PS/nVision generates an instance of the report for only those field values that are listed as valid combinations on the table.

You create a field combination table in Application Designer just as you would create any other custom table. After creating the table with the combinations of fields to use, you point to that table from the **Field Combination Table** field in the PeopleSoft nVision Scope Definition dialog box.

You can also create a dynamic record that is populated by a query and includes only the combinations of field values that actually have data for that reporting period. This eliminates printing blank pages (report instances) when you have fields that have no data for a particular reporting period.

---

**Note:** When you create a combination table, you need only include the scope fields whose values you want to limit, but you can also include SETID and EFFDT. You can populate the table using a SQL tool as well, but a better option might be to create a simple page to update the table.

---

If you specify field values using tree nodes, PS/nVision uses the combination table to determine whether the underlying details are valid before producing an instance for a tree node. For example, if an instance is requested for each product and division (a rollup of departments on an organization tree), PS/nVision determines whether any departments in each division are valid in combination with a particular product. In this case, the combination table should contain a **DEPTID** and **PRODUCT** field, with each row containing the valid department/product combinations.

### Using Business Unit Keyed Trees

You can define report scopes using business unit keyed trees by adding a valid business unit to the scope definition. You must still enter a setID as the key field for the scope, and the business unit you enter is used for selecting business unit keyed trees. At the field level, you must select the **BU Keyed Tree** option to limit the tree selection list to those trees keyed by the business unit entered.

At runtime, the requesting business unit is used as a replacement for the business unit that you entered when defining the scope. Therefore, if you define a tree with the same name for multiple business units, you can use the same scope for each version.

---

## Defining Scopes

This section discusses how to:

- Create new scopes.
- Select scope fields.
- Select tree levels and tree nodes.

### Creating New Scopes

Access the PeopleSoft nVision Scope Definition dialog box by selecting **nVision > Scope Definition** from the nVision menu.

This example illustrates the fields and controls on the PeopleSoft nVision Scope Definition dialog box.

To define a new scope in PS/nVision:

1. Select **nVision** > **Scope Definition** from the nVision menu.
2. Click the **New** button.
3. Enter a scope name and a description.

You may use up to 10 characters for the scope name and up to 30 characters for the scope description.

4. Enter the setID for this scope.
5. If you are defining your scope using business unit keyed trees, enter the business unit.
6. If you are using multiple scope fields, enter the appropriate tables in the **Field Combination Table** field.
7. Add fields to the scope definition by clicking the **Add** button.

The PeopleSoft nVision Scope Field dialog box appears.

## Selecting Scope Fields

This example illustrates the fields and controls on the PeopleSoft nVision Scope Field dialog box.

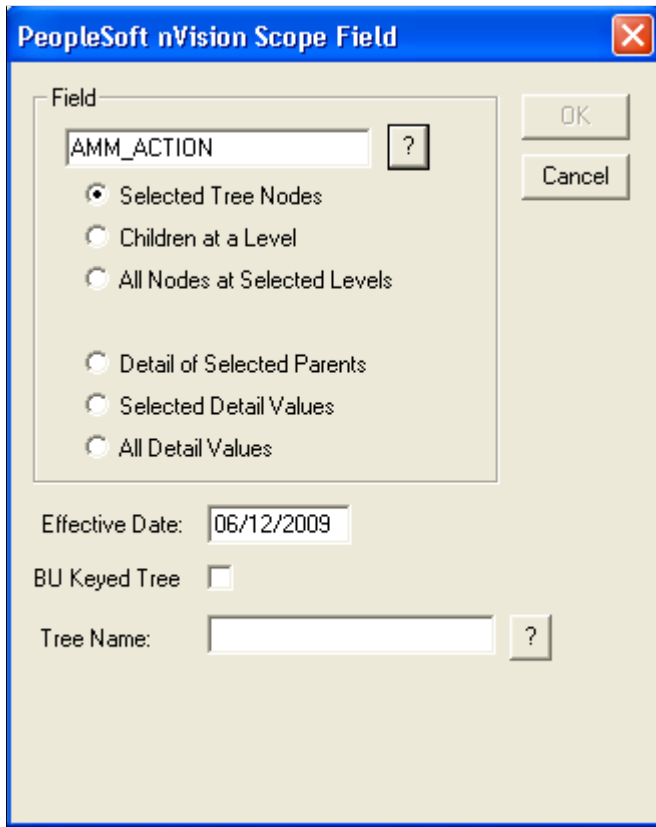

For each field that you add to a scope, you specify the source of the field values and the values to use. This process is similar to defining field criteria in a matrix layout.

Each of the options in the PeopleSoft nVision Scope Field dialog box selects a different set of these values for building your scope:

- Tree Node (Summary) Instances: Selected Tree Nodes, Children at a Level, All Nodes at Selected Levels.
- Used with Summary Ledgers only: Selected Summary ChartField Nodes.
- Detail Value (Detail) Instances: Detail of Selected Parents, Selected Detail Values, All Detail Values.

| <b>Field or Control</b>    | <b>Description</b>  |
|----------------------------|---|
| <b>Field</b>               | Enter a field to add to your scope.   |
| <b>Selected Tree Nodes</b> | Select this option to create an instance for each tree node that you select. When you type the field name, you are prompted to enter a tree name and level. |

| <b>Field or Control</b>                  | <b>Description</b>   |
|--|--|
| <b>Children at a Level</b>               | Select this option to create an instance for each tree node at a specified tree level that is a child of the parent node. The parent nodes need not be the immediate parent of nodes at the specified level. When you type the field name, you are prompted to specify a tree name and level.  |
| <b>All Nodes at Selected Levels</b>      | Select this option to create an instance for every node at each selected level. When you type the field name, you are prompted to specify a tree name and level.   |
| <b>Selected Summary ChartField Nodes</b> | Select this option to create an instance for every specified node in a tree used to create a summary ledger. (This option applies only to users of PeopleSoft General Ledger.) You should use summary trees rather than the summary ChartField nodes.<br><br>When detail values are summarized into tree nodes, you must use a different ChartField in the summary ledger data record to accommodate the maximum length of a node name (20 characters). When you type a field name, you are prompted to specify a tree name and level. |
| <b>Detail of Selected Parents</b>        | Select this option to create an instance for each detail value associated with the specified tree nodes.   |
| <b>Selected Detail Values</b>            | Select this option to create an instance for each detail value that you specify. This option activates the <b>Value Table</b> field, where you can specify the table that contains the values that you want to select.   |
| <b>All Detail Values</b>                 | Select this option to create an instance for all detail values. This option activates the <b>Value Table</b> field, where you can specify the table that contains the values that you want to use.   |
| <b>Effective Date</b>                    | Enter a date to determine the trees you can select from.   |
| <b>BU Keyed Tree</b>                     | Select this option to limit tree selection to trees keyed by the business unit entered on the PeopleSoft nVision Scope Definition dialog box.  |
| <b>Tree Name</b>                         | Select the required tree for your scope. The list is filtered based on the setID or business unit, and field entered.  |

## Related Links

“Working with Tree Concepts” (Tree Manager)

## Choosing Tree Levels and Tree Nodes

If you selected the **All Nodes at Selected Levels**, **Selected Tree Nodes**, **Children at a Level**, or **Detail of Selected Parents** options in the PeopleSoft nVision Scope Field dialog box, the PeopleSoft nVision Tree Nodes dialog box appears prompting you to specify the tree levels that contain the nodes you want to use.

This example illustrates the fields and controls on the PeopleSoft nVision Tree Nodes dialog box.

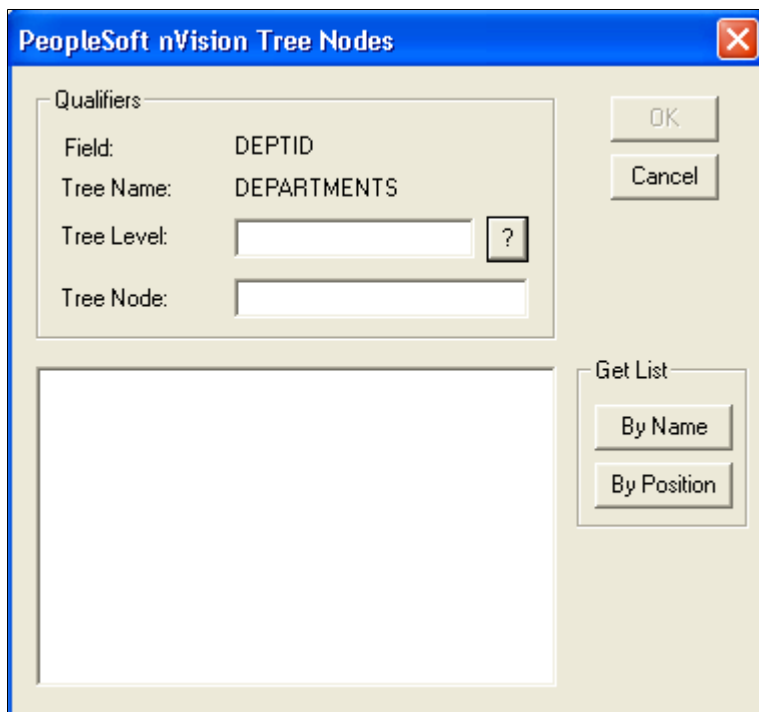

To select tree levels and nodes in PS/nVision:

1. Select **nVision** > **Scope Definition** from the nVision menu.
2. Click the **New** button.
3. Enter a scope name and a description.

You may use up to 10 characters for the scope name and up to 30 characters for the scope description.

4. Enter the setID and other values for this scope.
5. Add fields to the scope definition by clicking the **Add** button.

The PeopleSoft nVision Scope Field dialog box appears.

6. Select **All Nodes at Selected Levels**, **Selected Tree Nodes**, **Children at a Level**, or **Detail of Selected Parents** option.

The PeopleSoft nVision Tree Nodes dialog box appears.

7. In the PeopleSoft nVision Tree Nodes dialog box, select a level.
8. Place the cursor in the **Tree Node** field and click to see a list of nodes either by name or by position.

9. Select the nodes to use for your report.
10. Click the **OK** button.

The PeopleSoft nVision Scope Definition dialog box shows your fields and tree nodes.

11. Click the **Save** button to save the scope.

---

**Note:** Make sure to click the **Save** button when you are finished with your scope. Clicking the **OK** button closes the PeopleSoft nVision Scope Definition dialog box without saving your scope.

---

## Working With Existing Scopes

This section discusses how to:

- Open existing scopes.
- Delete existing scopes.
- Add fields and values to existing scopes.
- Remove fields and values from existing scopes.

### Opening Existing Scopes

This example illustrates the fields and controls on the PeopleSoft nVision Open Scope Definition dialog box.

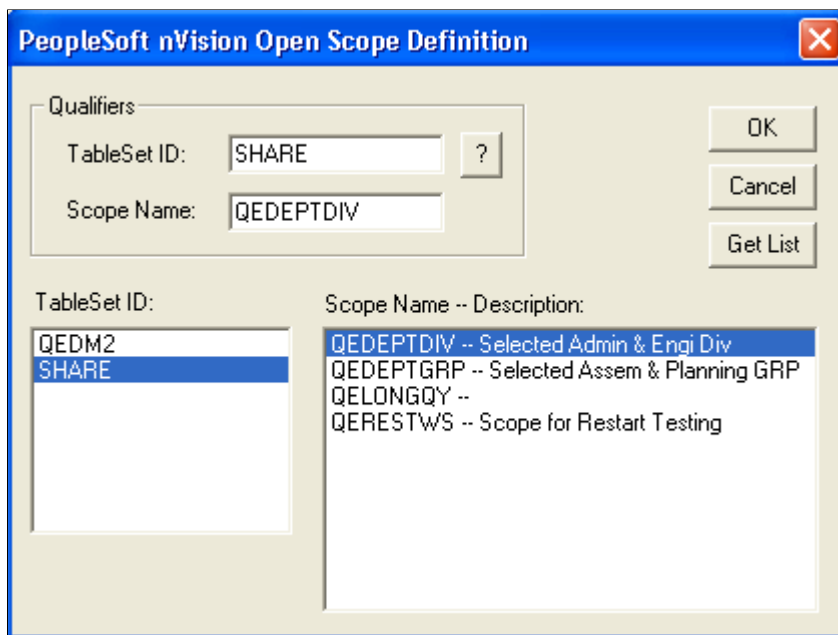

To open an existing scope in PS/nVision:

1. Select **nVision** > **Scope Definition** from the nVision menu.

2. Click the **New** button, and enter a scope name and a description.
3. Enter the setID and other values for this scope.
4. Add fields to the scope definition by clicking the **Add** button.
5. Select either **All Nodes at Selected Levels**, **Selected Tree Nodes**, **Children at a Level**, or **Detail of Selected Parents** option.
6. In the PeopleSoft nVision Tree Nodes dialog box, select a level.
7. Place the cursor in the **Tree Node** field and click to see a list of nodes either by name or by position.
8. Select the nodes to use for your report.
9. Click the **OK** button.
10. From within the PeopleSoft nVision Scope Definition dialog box, click the **Open** button.

The PeopleSoft nVision Open Scope Definition dialog box appears.

11. Click the **Get List** button to see a list of available scope definitions.

In the **TableSet ID** list box, there is a list of setIDs; in the Scope Name – Description list box, there is a list of scope definitions for each setID.

You can limit the list by entering qualifiers into either the **TablesSet ID** or **Scope Name** fields before clicking the **Get List** button.

12. Select a scope definition from the list.
13. Click the **OK** button.

## Deleting Existing Scopes

To delete an existing scope in PS/nVision:

1. Open the scope that you want to delete.
2. Click the **Delete** button.

## Adding Fields and Values to Existing Scopes

To add additional field values to a scope in PS/nVision:

1. Select **nVision > Scope Definition** from the nVision menu.
2. Click the **New** button, and enter a scope name and a description.
3. Enter the setID and other values for this scope.
4. Add fields to the scope definition by clicking the **Add** button.
5. Select either **All Nodes at Selected Levels**, **Selected Tree Nodes**, **Children at a Level**, or **Detail of Selected Parents** option.

6. In the PeopleSoft nVision Tree Nodes dialog box, select a level.
7. Place the cursor in the **Tree Node** field and click to see a list of nodes either by name or by position.
8. Select the nodes to use for your report.
9. Click the **OK** button.
10. In the PeopleSoft nVision Scope Definition dialog box, click the **Add** button in the Fields selection area.

The PeopleSoft nVision Scope Field dialog box appears.

11. Enter the new scope fields and related values, and click the **Save** button.
12. Click the **OK** button to return to the NVSUSER home page.

## Related Links

[Selecting Scope Fields](#)

## Removing Fields and Values from Existing Scopes

To remove a field from a scope definition in PS/nVision:

1. Select **nVision > Scope Definition** from the nVision menu.
2. Click the **New** button, and enter a scope name and a description.
3. Enter the setID and other values for this scope.
4. Add fields to the scope definition by clicking the **Add** button.
5. Select either **All Nodes at Selected Levels**, **Selected Tree Nodes**, **Children at a Level**, or **Detail of Selected Parents** option.
6. In the PeopleSoft nVision Tree Nodes dialog box, select a level.
7. Place the cursor in the **Tree Node** field and click to see a list of nodes either by name or by position.
8. Select the nodes to use for your report.
9. Click the **OK** button.
10. In the PeopleSoft nVision Scope Definition dialog box, select the field to remove.
11. Click the **Delete** button in the **Fields** group box.

To remove a field value from a scope definition in PS/nVision:

1. In the PeopleSoft nVision Scope Definition dialog box, select the field whose value you want to remove.
2. In the right-hand list box, select the value to remove.
3. Click the **Delete** button in the right-hand group box.

---

## Using Scope-Related Variables

---

**Note:** Using scope-related variables is discussed in the *Creating Matrix Layouts* topics.

---

See [Understanding Matrix Layouts](#), [Creating Matrix Layouts](#), [Adding Variable Criteria](#).

## Chapter 8

# Using DrillDown

## Using DrillDown

DrillDown enables you to select a cell in your report and expand it according to new criteria contained in a special DrillDown layout. This is useful when reporting is based on summary ledgers, as it provides underlying details when and where they are needed.

**Note:** Although you create DrillDown layouts in PS/nVision on the Windows client, you can run DrillDown with a browser on any report that you have access to in Report Manager.

The following report was run based on the Emplsal layout delivered with the PeopleTools Demo database (PTDMO). By expanding the nPloded rows, you can review details about the data in the report. But what if you want to review the monthly salaries of individual employees, and this is not in your original report layout? With DrillDown, you can create a DrillDown layout that expands cell data to show the monthly employee salary rates.

In this example, L5 is the cell we are drilling down on, representing the total monthly rate for the Human Resources department.

| Department | Description                    | Head Count | FTE  | Total Monthly Rate |
|------------|--------------------------------|------------|------|--------------------|
| 10200      | Human Resources                | 23         | 22.5 | \$95,018           |
| 10300      | Controllers                    | 13         | 12.5 | \$41,750           |
| 10400      | Retail Services                | 24         | 24.0 | \$77,581           |
| 10500      | Business Services              | 6          | 6.0  | \$22,844           |
| 10600      | Branch Office Administration   | 3          | 3.0  | \$8,447            |
| 10700      | Walnut Creek Office            | 7          | 7.0  | \$18,417           |
| 10800      | Lafayette Office               | 5          | 5.0  | \$13,365           |
| 10900      | Operations Administration      | 3          | 3.0  | \$14,242           |
| 11000      | Information Systems & Technlgy | 8          | 7.8  | \$21,084           |
| 11100      | Item Processing                | 13         | 12.0 | \$37,200           |
| 10900      | Operations Administration      | 24         | 22.8 | \$72,525           |

After selecting a cell, pick the DrillDown layout you want to use from the nVision, DrillDown menu. The results appear in a DrillDown report.

This example shows the results in a DrillDown report.

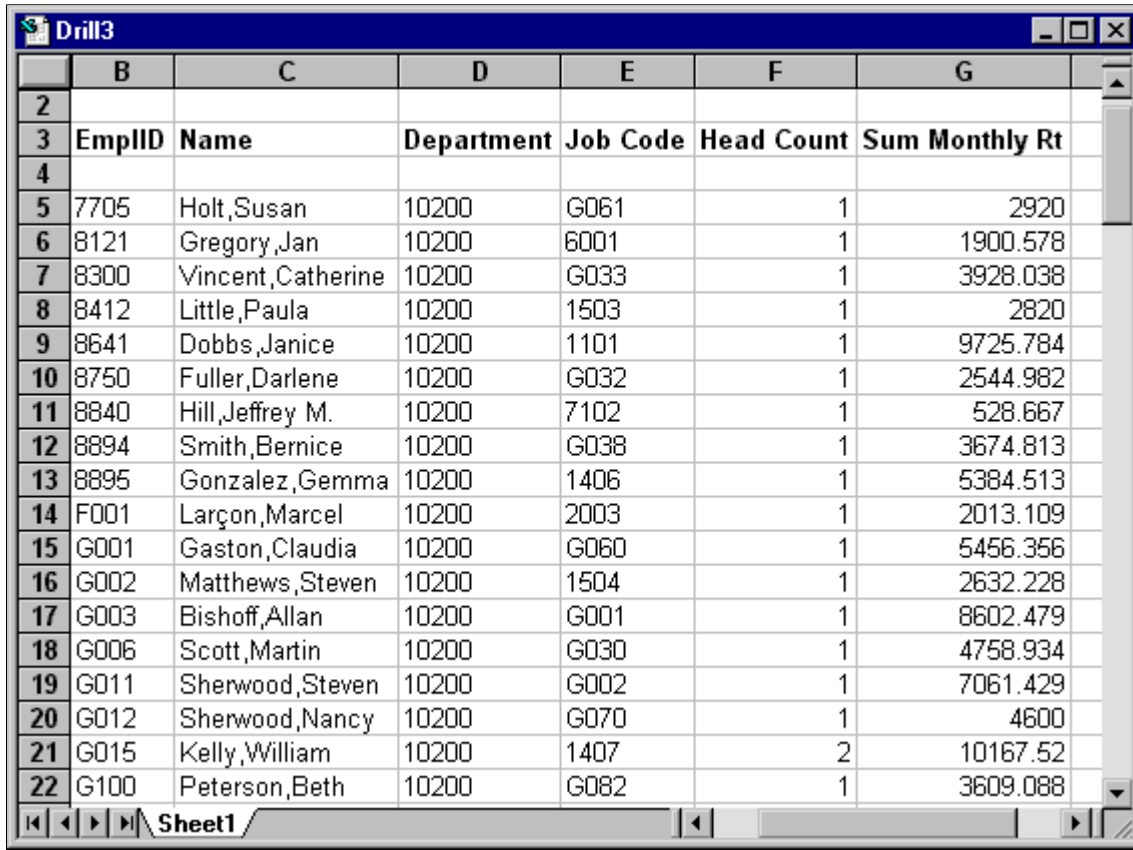

|    | B             | C                 | D                 | E               | F                 | G                     |
|----|---------------|-------------------|-------------------|-----------------|-------------------|-----------------------|
| 2  |               |                   |                   |                 |                   |                       |
| 3  | <b>EmpIID</b> | <b>Name</b>       | <b>Department</b> | <b>Job Code</b> | <b>Head Count</b> | <b>Sum Monthly Rt</b> |
| 4  |               |                   |                   |                 |                   |                       |
| 5  | 7705          | Holt,Susan        | 10200             | G061            | 1                 | 2920                  |
| 6  | 8121          | Gregory,Jan       | 10200             | 6001            | 1                 | 1900.578              |
| 7  | 8300          | Vincent,Catherine | 10200             | G033            | 1                 | 3928.038              |
| 8  | 8412          | Little,Paula      | 10200             | 1503            | 1                 | 2820                  |
| 9  | 8641          | Dobbs,Janice      | 10200             | 1101            | 1                 | 9725.784              |
| 10 | 8750          | Fuller,Darlene    | 10200             | G032            | 1                 | 2544.982              |
| 11 | 8840          | Hill,Jeffrey M.   | 10200             | 7102            | 1                 | 528.667               |
| 12 | 8894          | Smith,Bernice     | 10200             | G038            | 1                 | 3674.813              |
| 13 | 8895          | Gonzalez,Gemma    | 10200             | 1406            | 1                 | 5384.513              |
| 14 | F001          | Larçon,Marcel     | 10200             | 2003            | 1                 | 2013.109              |
| 15 | G001          | Gaston,Claudia    | 10200             | G060            | 1                 | 5456.356              |
| 16 | G002          | Matthews,Steven   | 10200             | 1504            | 1                 | 2632.228              |
| 17 | G003          | Bishoff,Allan     | 10200             | G001            | 1                 | 8602.479              |
| 18 | G006          | Scott,Martin      | 10200             | G030            | 1                 | 4758.934              |
| 19 | G011          | Sherwood,Steven   | 10200             | G002            | 1                 | 7061.429              |
| 20 | G012          | Sherwood,Nancy    | 10200             | G070            | 1                 | 4600                  |
| 21 | G015          | Kelly,William     | 10200             | 1407            | 2                 | 10167.52              |
| 22 | G100          | Peterson,Beth     | 10200             | G082            | 1                 | 3609.088              |

The DrillDown layout inherits all the criteria of the selected cell on the original report and provides a sub-report with the details you need.

Because DrillDown depends on child layouts, you might want to create a library of common layouts to use. These might include:

- Accounts by department.
- Products by cost center.
- Accounts by period.
- Departments by benefit plan.

Your system comes with a number of generic reports, and you can tailor or clone these reports as needed. Many of these layouts employ nPlosion, so you can view both summary and detail levels in your sub-report.

You can also perform a series of DrillDowns on cells in reports until you have reached the level of detail that you need.

DrillDown is available from matrix layouts only. However, the layout that displays the results of the DrillDown can be either matrix or tabular. For example, you might produce a financial report using a matrix layout, and then select one of the amounts and drill down to another matrix layout that breaks down the departments and products that were summarized into that amount. From that report, you might select a department/product combination and drill down, this time using a tabular layout that queries the

individual sales transactions. This is the end of the DrillDown trail, because you can drill further only from a matrix report.

---

**Note:** A PeopleTools upgrade may change the web server domain name, port number, or servlet path required to access web server resources in the PeopleSoft Pure Internet Architecture. As a result, PS/nVision drilldown operations on reports that were created before upgrade would fail, primarily because drilldown links are, by design, hard-coded into PS/nVision reports. This is UpdateNvsDrill.xls. We have provided a simple search and replace utility that you can use to replace old links with new ones. This Excel macro, along with all other Excel macros, is located in the PS\_HOME\Excel directory.

---

## Related Links

[Using the PS/nVision DrillDown on the Web](#)

## Using Inherited Criteria

The key to DrillDown is the passing of selection criteria from a parent cell to its child using the DrillDown layout. The child layout may have criteria of its own (possibly on other fields than those mentioned in the parent), but any conflicts in criteria must be resolved so that the child query accesses a subset of the data selected from the parent query.

Think of inherited criteria as the equivalent of a scope for the resulting report. The DrillDown layout can have criteria (including nPlosion) for fields that were not included in the original report, and it can have criteria for fields that defined the selected amount from the original report.

Criteria for fields from the original report override any specified in the DrillDown layout, with the exception of nPlosion options, which enable you to see more detail than in the original report.

Within a DrillDown layout, you can specify TimeSpan nPlosion without entering a TimeSpan, since the DrillDown layout inherits the TimeSpan of the original report.

## Ledger Inheritance

Ledger criteria can be overridden in a child layout, either by ledgers specified in the child layout or by queries to access tables that do not contain the LEDGER field.

An example of a ledger-based DrillDown that expands ledger criteria compares budget to actual expenditures. Assume that you want to drill down from a budget variance report produced at the business unit level and compare the actual to budget for each department. You can construct a DrillDown layout with DEPTID nPloded in the rows and columns for actuals, budget, and variance. Because PS/nVision allows this layout to override the inherited ledger, you can see each department's budget performance in a single picture.

## Soft Inheritance

You can create a DrillDown with multiple TimeSpans. It is called *soft inheritance* for TimeSpans. To create a soft inheritance for TimeSpans, you define a DrillDown layout with multiple columns and various combinations of ledgers and TimeSpans.

For example, suppose you have a ledger total posted amount for the year 2001. You want to show year 2001's detail amounts, which make up this total amount in one column, with 2000's detail amounts in the column beside it. You define a DrillDown layout with two amount columns. One column has no TimeSpan, (although you might specify nPlode TimeSpans), and the other column specifies a TimeSpan,

such as YTD-1YR. When you drill down, the first column inherits the TimeSpan, year 2001, from the parent cell; and the other overrides the TimeSpan from the parent cell and uses its own defined year 2000 TimeSpan.

---

**Note:** Soft inheritance only controls when you drill down to a tabular layout. It does not function for matrix layouts.

---

## Using DrillDown Instances

Because DrillDown instances may be numerous and temporary, PS/nVision does not save them automatically as it does for parent instances. Also, since these instances are generated without a report request, there are no directory and file name templates. Therefore, PS/nVision performs the following operations when creating the instances:

1. Saves the layout as a temporary template sheet (DRILL.XLT) in your TEMP directory.
2. Opens an instance of the template; this causes Excel to assign a name such as DRILL1.
3. Populates the instance as usual but neither saves nor closes it. You can save it (assigning a name at save time) or close it without saving it once you are finished using it.

---

## Using DrillDown Navigation

Unlike nPlosion, DrillDown does not require you to enable it before running your report. Run a report, select a cell to expand, select the *DrillDown* option from the nVision menu, and then click the **Drill** button on the toolbar, or use a predefined item on the Drill menu. The predefined Drill menu items are most convenient because you can personalize them to express common DrillDown actions for your organization.

To create a new DrillDown layout, select the New Layout option from the nVision menu and define your selection criteria just as you would a report layout. Save the layout in the directory identified as DrillDown Layouts on the nVision tab of the PeopleSoft Configuration Manager.

Remember that criteria from the selected cell in the parent instance are inherited in the child layout. Reports inherit criteria from the parent cell so you get the same summary amount in the detail report, but you also get the summary amount broken into its component details. This produces a single report instance containing a subset of the data selected in the parent instance, but the data is separated into one or two dimensions to show more detail.

### Jump Back

After you have reviewed the result of a DrillDown report, the Jump Back command from the nVision menu (CTRL+SHIFT+J) returns you to the cell from which you drilled down. This occurs even if you closed the parent report.

### ReDrill

To repeat a DrillDown starting from a different cell on the parent report, press **CTRL+SHIFT+I**. For example, suppose that you have drilled down from the current year's Travel Expense amount, showing

balances by detail account and department. Now you want to see the same breakout for last year's amount. Jump back to the original report, select last year's amount, and press **CTRL+SHIFT+I**.

## AutoDrill

For both ledger-based and query-based matrix reports, AutoDrill is a quick and easy DrillDown method. To use AutoDrill, define a default DrillDown layout within the parent layout by using the Excel Insert, Name, Define command to define the name NvsDefaultDrill as a string with the name of the default DrillDown layout in the parent layout.

This example illustrates the fields and controls on the Define Name dialog box.

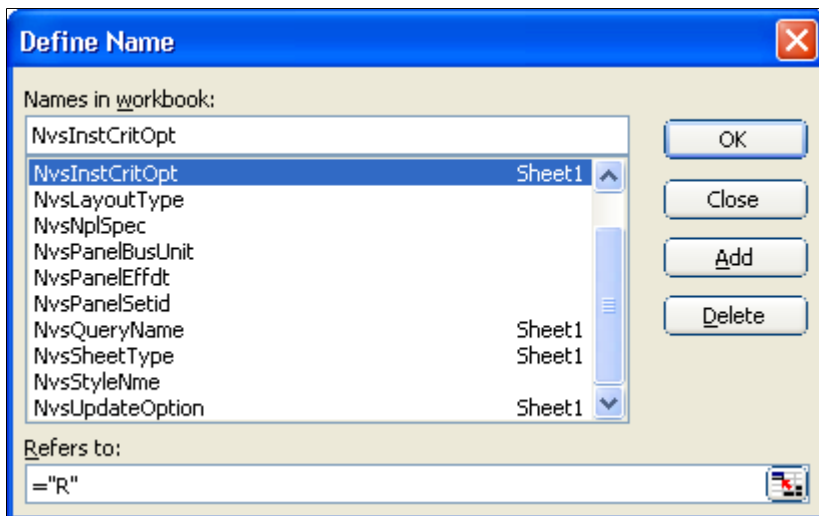

After running a report, you can use AutoDrill in various ways:

- Double-click one of the amount cells.  
The Nvsuser front end generally sets double-click to call the PS/nVision AutoDrill function.
- Select the **AutoDrill** option from the nVision menu in Microsoft Excel.
- Click the **AutoDrill** button on the nVision toolbar.

AutoDrill checks whether the instance you are drilling from has a default DrillDown layout. If so, PS/nVision runs that layout.

---

**Note:** The default DrillDown layout may contain a matrix layout, a tabular layout, or both.

---

If no default DrillDown layout exists, PS/nVision checks the data source in the parent instance for the cell you are drilling from. If it is a ledger, PS/nVision asks you to select a DrillDown layout. If it is a query, PS/nVision adds the inherited criteria to the same query and then runs the query in QueryLink mode. To show the underlying detail from a query designed for matrix reporting, PS/nVision removes aggregate functions, such as Sum, from the query. This causes the query to show the lowest level of the detail from the database. This modification of the query happens only when drilling down in QueryLink mode.

To get an intermediate level of detail in a query-based report using AutoDrill, define a default tabular layout in NvsDefaultDrill. You might want to define a slightly different query to aggregate the intermediate level of detail you need, and then build the default DrillDown layout using this query.

## Related Links

[Using Configuration Manager](#)

[Personalizing NVSUSER.XLS](#)

---

## Using DrillDown Layout Formats

Basic DrillDown layouts typically have one data row and one data column. These simple layouts take data already selected on a report and expand it in two dimensions. Both columns and rows may specify nPlosion and automatic labeling of inherited and nPloded data.

---

**Note:** A DrillDown layout can be as complex as you like. For example, if you are building a DrillDown layout you expect to be used from a corporate-level management report, you could design it with departments grouped into regions, with nPlosion to detail. If you drill down to this layout from a regional report, PS/nVision filters the layout criteria through the inherited criteria, and all the other regions have zeros.

---

Because DrillDown layouts are based on a simple matrix, you can set up a library of layouts based on the field and TimeSpan combinations most common for your reporting and analysis needs.

For example, if you frequently select an amount from a summary income statement and expand it to show that amount broken down by individual accounts, you could create a DrillDown layout that uses nPlosion to expand account detail in the rows and that breaks out a TimeSpan to the individual accounting periods in the columns. Alternatively, you might want to see the value broken out by department in the rows and product in the columns.

Let's say that you specify All Detail Values in the DrillDown layout as the selection criterion for a field, and the cell you are drilling down from on the original report used a specific tree node for its criteria. In this case, the report from the DrillDown nPlodes only the detail values for that tree node, creating a row or column for each in addition to a summary column based on the tree node.

If the parent cell had no criteria for a field specified on the child as all detail values, the child report lists amounts for all values in the specified field.

## DrillDown and Summary Ledger

When using DrillDown from a report based on a summary ledger, you can either translate summary ledger criteria into the corresponding detail ledger or drill down within the summary ledger.

To drill down within the summary ledger using the web, define the name *NvsTranslateLedger* in the DrillDown layout. PS/nVision reads this defined name at runtime.

- If the value is *Y*, summary ledger criteria is translated into the corresponding detail ledger.
- If the value is *N*, DrillDown within summary ledger is selected.
- If *NvsTranslateLedger* is not defined, summary ledger criteria is translated into the corresponding detail ledger.

To define the name *NvsTranslateLedger* in the DrillDown layout:

1. Use the Excel Insert, Name, Define command to define the name *NvsTranslateLedger*.

2. Define the name as a string with either *Y* or *N* for the value.

---

**Note:** If you are using the Windows client, PS/nVision continues to ask whether to drill within the summary ledger or drill to the corresponding detail ledger.

---

## DrillDown and Queries

When drilling down from a ledger-based report, you can use predefined queries (built into PeopleSoft Query) in the following ways:

- Use a matrix DrillDown layout that specifies query, rather than ledger, criteria.

This provides a matrix report that accesses tables other than ledgers, but inherits all the field criteria (business unit, account, and so on) from the parent report.

- Drill down to a tabular layout, inheriting the field criteria from the parent report.

This is useful for seeing the details of transaction data, such as journals and voucher lines.

- Drill down to a query without a layout.

The query inherits the criteria and runs to Excel in QueryLink mode.

When drilling down from a query-based report, you can use another query in a matrix layout, in a tabular layout, or without a layout. The query you use must be capable of inheriting the criteria from the cell you are drilling down from.

In any case, PS/nVision bends the rules of inheritance slightly to enable you to see the needed data. The ledger construct (which implies a special query against a specific type of table defined in PeopleSoft General Ledger) is replaced by the query specification. The implied field criteria for the inherited ledger (for example, LEDGER = ACTUALS) may or may not be inherited. While drilling down to journals within the PeopleSoft General Ledger application requires criteria for the LEDGER field (because journals may exist for various ledgers), drilling down to Accounts Payable voucher data only makes sense from the Actuals ledger, and the voucher tables do not include the LEDGER field. PS/nVision thus looks at the records being queried and includes criteria for the Ledger field only if it is present.

## Naming Conventions

Use a three-character naming convention for DrillDown layouts, so that the fields and accounting periods in the layout are easily identified in the Open Layout dialog box. The PS/nVision DrillDown layouts supplied with the system use the abbreviations described in the following table.

| <b>Abbreviation</b> | <b>DrillDown Layout</b> |
|---------------------|-------------------------|
| ACT                 | Account                 |
| BUS                 | Business Unit           |
| DEP                 | Department ID           |

| <b>Abbreviation</b> | <b>DrillDown Layout</b> |
|---------------------|-------------------------|
| PRD                 | Product                 |
| PRJ                 | Project                 |
| PER                 | Accounting Period       |

Each layout is named *RRRCCCXX.XNV*, where *RRR* is the abbreviation for a field expanded in the rows, *CCC* is the abbreviation for a field expanded in the columns, and *XX* is an optional identifier for a specific layout or version of *RRRCCC*.

---

**Note:** With recent versions of Windows, file names can be long and descriptive, but a consistent convention is still a good idea. For example, you might want to name a DrillDown layout *DepartmentByProduct*.

---

## DrillDown Layout Directory

Store DrillDown layouts in a separate directory from the parent standalone layouts. You specify the directory path on the nVision tab of the PeopleTools Configuration Manager. The DrillDown layout path can contain multiple directories, which are searched in sequence. The DrillDown directory is also defined in the PeopleSoft Process Scheduler configuration for your report server.

### Related Links

[Using Configuration Manager](#)

## Chapter 9

# Using nPlosion

---

## Understanding nPlosion

You use nPlosion to expand rows or columns containing field criteria. When enabled, nPlosion automatically creates individual rows or columns for each detail value defined in the criteria—whether those values are defined specifically or implicitly (by association with a parent tree node). A detail row or column is generated for the blank [or (*None*)] value if you are nPloding a tree containing a blank.

You can only enable nPlosion at the row or column level. When you enable nPlosion for a row, PS/nVision inserts the detail or summary value rows immediately above the nPloded row. When you enable it for a column, PS/nVision inserts detail and summary value columns to the left of an nPloded column. If you have intersected label criteria with an nPloded row or column, descriptive text identifies each nPloded amount. (If you do not use labels, you may have trouble identifying the detail rows that are dynamically included in the report.)

---

**Note:** For Oracle's PeopleSoft General Ledger, nPlosion is available for detail ledger ChartFields or summary ledger ChartFields that contain detail values. You may also use nPlosion for summary ledger ChartFields accessed through summary trees. nPlosion is not available for summary ledger ChartFields specified as selected summary ChartField nodes.

You cannot use nPlosion for a summary tree ChartField filter if the ledger's corresponding ChartField type is detail. Nor can you use nPlosion for a detail ChartField filter if the ledger's corresponding ChartField type is summary. Attempting to nPlode in these situations returns a Microsoft Excel error, "PS/nVision returning the Excel error code #N/A to the affected cells."

For other applications, nPlosion is available for criteria fields that have value tables with field values (usually, this is the prompt table for that field).

nVision does not support duplicate detail values when using nPlosion. Trees with duplicate detail values could return incorrect results in nPlosion. To perform nPlosion in such a case, you need to use different trees for the different parts of the report so that nVision would retrieve the overlapping nodes separately.

---

When processing nPlosion, PS/nVision uses the Excel outline feature to group the detail or summary rows or columns and associate them with their total. After a report containing nPloded values has been generated, you can use the Excel outlining symbols to collapse and expand the nPloded entries. Outlining symbols automatically appear in the report's left margin (for rows) or above the worksheet (for columns).

In web-based PS/nVision reporting, you can still use outlining in full nPlosion. With Internet Explorer and the Excel add-in, reports produced in XLS format can be displayed with full Excel features, including outlining.

The nPlosion feature is particularly useful with the DrillDown feature, which enables you to select cells in your report and expand them to intermediate or detailed levels of summarization in an ancillary sub-report.

## Defining nPlosion Criteria

Use these step to access the PeopleSoft nVision nPlosion Criteria dialog box in PS/nVision:

1. With a layout opens in nVision, select a column or a row to nPlode.
2. Select **nVision > Layout Definition** from the nVision menu.
3. Select the Filter tab.
4. Select the required fields and click the **nPlosion** button.

The PeopleSoft nVision nPlosion Criteria dialog box appears.

This example illustrates the fields and controls on the PeopleSoft nVision nPlosion Criteria dialog box.

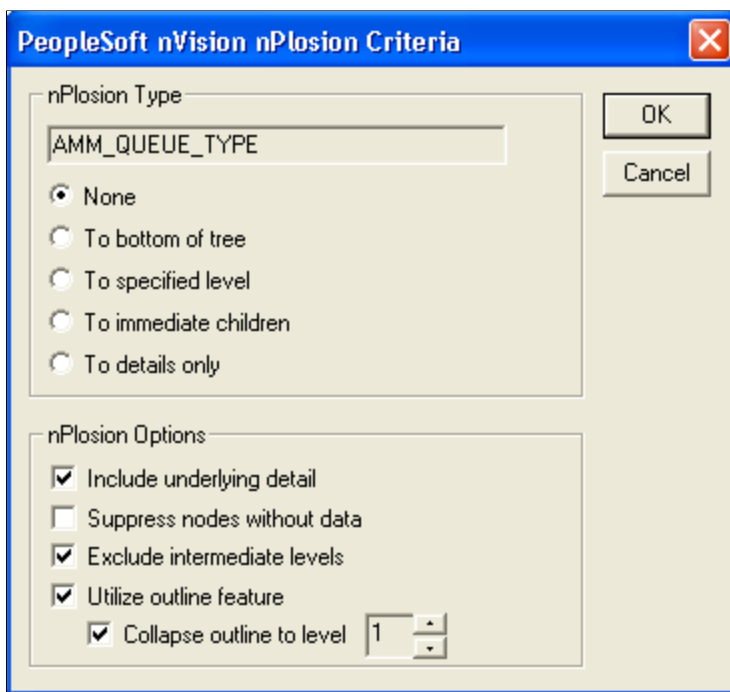

### nPlosion Type

There are four different nPlosion types, which can be combined with nPlosion options to create different reports depending on the data you want to retrieve.

| <i>Field or Control</i> | <i>Description</i>  |
|-------------------------|---|
| <b>None</b>             | Select to disable nPlosion for this field.<br><br>If you have previously selected a type of nPlosion, you must select the <b>None</b> option to remove the selection. |

| <b>Field or Control</b>      | <b>Description</b>   |
|------------------------------|--|
| <b>To bottom of tree</b>     | Select to nPlode all the way to the bottom of a tree (including detail values) from a selected node.<br><br>If you decide to include detail, all sub-nodes are also displayed with summary values of the rollup for those nodes. |
| <b>To specified level</b>    | Select to nPlode down a tree to the specified node, including or excluding intermediate data.<br><br>This option enables you to retrieve any branch of data from a given tree.   |
| <b>To immediate children</b> | Select to nPlode one level below a selected tree node.   |
| <b>To details only</b>       | Select to nPlode from a given node to all its detail values.   |

## nPlosion Options

| <b>Field or Control</b>            | <b>Description</b>  |
|------------------------------------|---|
| <b>Include Underlying Detail</b>   | When trying to nPlode from a node to another sub-node or to the bottom of the tree, select to include all of the detail and summary sub-values for each sub-node. |
| <b>Suppress Nodes Without Data</b> | Select to suppress nodes or sub-nodes with a value of zero from the report instance.  |
| <b>Exclude Intermediate Levels</b> | Select to exclude intermediate sub-nodes if a report is being nPloded from a node to another level or to the bottom of the tree.                                  |
| <b>Utilize Outline Feature</b>     | Select to roll up summary and detail information using Excel outline functionality. If this option is cleared, none of the information is rolled up.              |

---

## Defining nPlosion Defaults

Use these steps to access the PeopleSoft nVision Layout Options dialog box:

1. With a layout opens in nVision, select a column or a row to nPlode.

2. Select **nVision > Layout Options** from the nVision menu.

The PeopleSoft nVision Layout Options dialog box appears.

This example illustrates the fields and controls on the PeopleSoft nVision Layout Options dialog box.

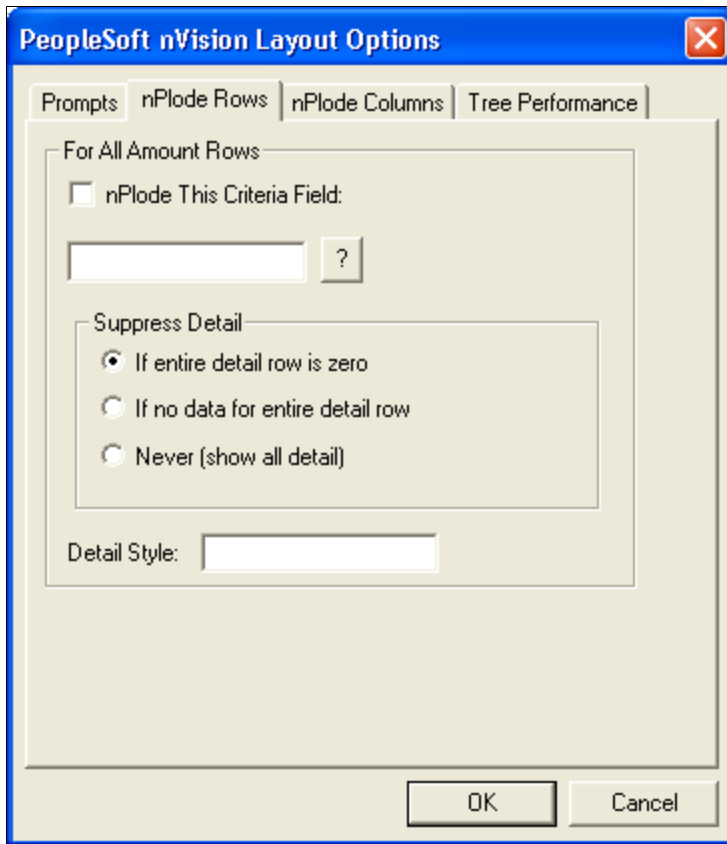

To define nPlosion defaults in PS/nVision:

1. With a layout open in PS/nVision, select any row, column, or cell that does not contain selection criteria—or select the entire worksheet.
2. Select **nVision > Layout Options** from the nVision menu.
3. Select the nPlode Rows tab from the PeopleSoft nVision Layout Options dialog box.

The PeopleSoft nVision Layout Options – nPlode Rows dialog box appears.

4. Select whether to enable a default nPloded criteria field for all rows, or columns, or both.

To define a default nPloded field for all rows, select the **nPlode This Criteria Field** option in the **For All Amount Rows** group box. And then enter or select a field name in the editable field below the check box.

To define a default nPloded field for all columns, select the nPlode Columns tab, and then select the **nPlode This Criteria Field** option in the **For All Amount Columns** group box.

---

**Note:** Enabling row- or column-wide nPlosion can be useful when, for example, you have a large layout where you would not want to specify nPlosion for each individual row or column.

---

- Optionally, specify the default fields to be nPloded.

If a column or row contains multiple criteria fields, nPlosion only occurs for the single field that you select here—unless you have specifically enabled nPlosion for those other fields on the PeopleSoft nVision Layout Definition – Criteria dialog box.

- Select the conditions under which you want to suppress nPlosion for rows and columns.

The Suppress Detail options enable you to suppress the creation of detail rows and columns under certain circumstances, as follows:

- **If entire detail column/row is zero:** Creates detail columns or rows for a field value only if there is a corresponding positive or negative amount. Suppresses rows with zero amounts in all columns, or columns with zero amounts in all rows.
- **If no data for entire detail column/row:** Creates detail columns or rows for each field value if amounts for that value are present on the query, even if those amounts net to zero.
- **Never (show all detail):** Creates detail columns or rows for all details under the nodes being nPloded.

The zero suppression options are independent. The node suppression option overrides the detail suppression option when they are in conflict. In other words, if zero nodes are suppressed, their underlying details are also suppressed. To see all details for all nodes, even if zero, you should turn off zero suppression at both levels.

- Specify a detail style to be applied to the detail rows and columns.

Style selection and defaults appear in the Excel Format – Style dialog box. The column format is used for nPloded values if a row style is not specified.

## Related Links

[Setting Tree Performance Options](#)

---

## Enabling nPlosion for Specific Situations

You can enable or disable nPlosion for specific:

- Criteria fields

To enable or disable nPlosion for a specific criteria field, select a field from the Fields and Dimensions list on the PeopleSoft nVision Layout Definition – Filter dialog box, and then click the **nPlode** button. This generates underlying details only for the criteria fields you specify.

- Query or ledger TimeSpans

To enable or disable nPlosion for a query or ledger TimeSpan, select or clear the **nPlode TimeSpan** option on the PeopleSoft nVision Layout Definition – Source dialog box. This option is only available if you have a TimeSpan specified. This option generates detail rows and columns for the individual periods in the TimeSpan; for example, the periods comprising year-to-date.

- Report requests

To enable or disable nPlosion for a report request, open the PeopleSoft nVision Report Request dialog box and select or clear the **Enable nPlosion If Specified In Layout** option. You can specify summary rows or columns before or after nPlode rows or columns based on an Excel option in layout. To set this, open your layout in Excel and select **Data > Group and Outline > Settings**.

### Related Links

[Applying Filter Criteria](#)

[Using TimeSpans](#)

[Creating Report Requests](#)

---

## Using Style Sheets with nPlosion Layouts

This section provides an overview of style sheets and discusses how to:

- Use the style sheet wizard.
- Open the Style Sheet Wizard.
- Modify a style.
- Apply styles to a report layout.
- Modify styles using the Excel menu bar.
- Configure the style sheet directory location.

---

**Note:** If a level is missing within the hierarchy, the next-lower-numbered level that is defined takes on the missing level's style attributes.

---

## Understanding Style Sheets

With nPlosion styles, you can control the layout and appearance of the multilevel hierarchy of rows and columns nPlosion generates. In PS/nVision, the styles for your summary rows and columns come directly from the styles that you have defined in the summary rows and columns in your layout. The styles for all nPloded rows or columns in your report are controlled by nPlosion styles, but not the styles defined in the summary rows or columns. You define nPlosion styles either by using Style Sheet Wizard or by directly applying the styles from the Excel menu bar using PS/nVision nPlosion style naming conventions.

---

**Note:** You can also format nPloded detail rows or columns by selecting **Format > Cells** from the Microsoft Excel menu bar when you create a report layout. However, by default, PS/nVision nPlosion style sheets override any such manual formatting of nPloded detail rows or columns. If you want nPloded details to appear in the format that you applied from the Excel menu bar rather than the nPlosion style sheet, you must define the name NvsSkipDetailStyles using the Define Name dialog box (by selecting **Insert > Name > Define** from the Excel menu bar), entering the value =1 in the **Refers To** field.

---

## Using the Style Sheet Wizard

You can use the Style Sheet Wizard exclusively to create and edit nPlosion styles, which are stored in a special Excel worksheet provided with PS/nVision.

This example illustrates the fields and controls on the nVision nPlosion Style Wizard window.

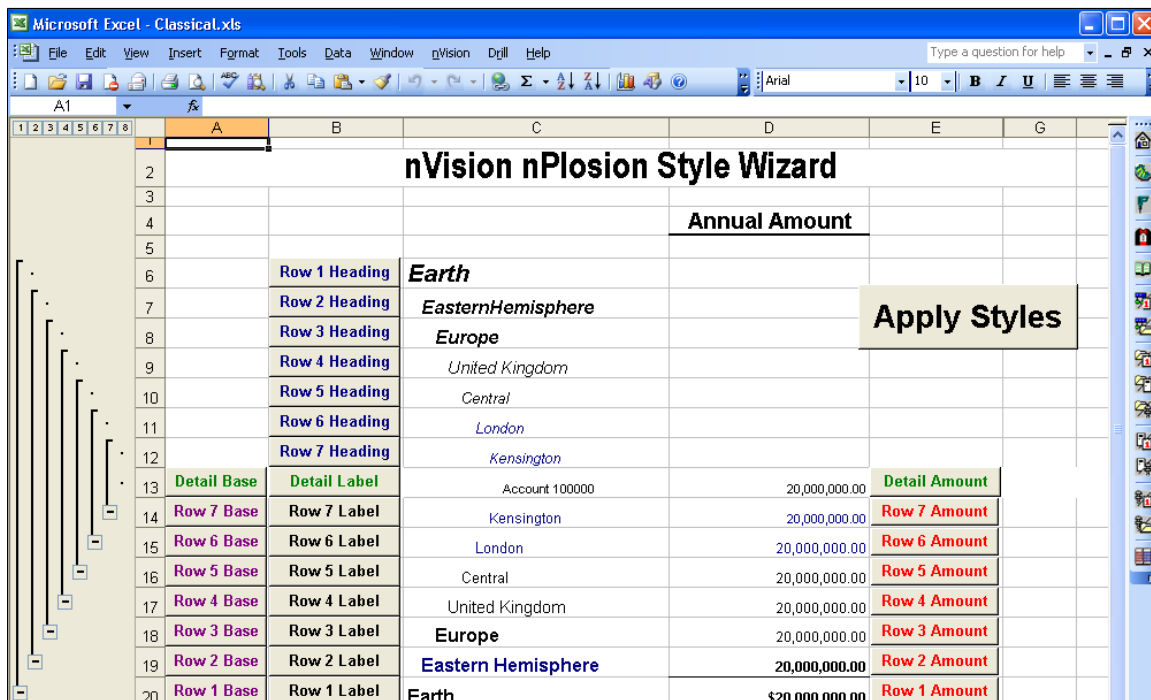

There are two nPlosion styles:

- The RowStyles tab displays Row styles.
- The ColumnStyles tab displays Column styles.

Seven levels of each style are provided, as well as a separate style for detail values.

The Style sheet Classical.xls is delivered with PS/nVision. You can create your own style sheet wizard by saving the Classical.xls file under a different name in the Style Sheet directory location. Configure the Style Sheet directory location using the Configuration Manager.

---

**Note:** You can override the base style by modifying any of the other styles that come after it. For example, you could make a particular field shaded, even though the base style for that row or column does not include shading.

---

## Opening the Style Sheet Wizard

To open the Style Sheet Wizard:

1. With an layout opens in PS/nVision, click the **Format Style Sheets** button on the nVision toolbar.
2. Select the *Classical.xls* style sheet and click the **OK** button.

The RowStyles tab of the Style Sheet Wizard appears.

The Style Sheet Wizard displays a rollup of data for eight rows and eight columns (Excel has a limitation of rolling data up into only eight outlines).

| <b>Field or Control</b> | <b>Description</b>  |
|-------------------------|---|
| <b>Heading</b>          | An outlined row or column of data has two parts.<br><br>When opened, the top portion of the outline is considered the header, and the bottom portion is considered the Label. The Heading does not contain any data; it is strictly for display purposes. |
| <b>Label</b>            | The bottom portion of the outline.<br><br>The Label is the only thing displayed if the outline is collapsed.  |
| <b>Amount</b>           | Any numeric data that will be a result of an nPlosion.  |
| <b>Base</b>             | The formatting options for the Heading, Label, and Amount styles.<br><hr/> <b>Note:</b> If there are style settings for the Label, Heading, or Amount, they will override the Base Style setting. <hr/>   |

## Modifying a Style

To modify a style:

1. With an layout opens in PS/nVision, click the **Format Style Sheets** button on the nVision toolbar.
2. Select the *Classical.xls* style sheet and click the **OK** button.

The RowStyles tab of the Style Sheet Wizard appears.

3. Click the button with the name of the style you want to modify.

The Style dialog box of Excel appears.

4. Click the **Modify** button to modify the style's display attributes, and then click the **OK** button.

The Format Cells dialog box of Excel appears.

5. Make more changes to styles by clicking the appropriate **Style** button.
6. If you do not have any PS/nVision report layouts open, you can save the current styles by selecting **File > Save** from the nVision menu.

This saving enables you to modify styles globally in the style worksheet, and then apply the new styles to any report layout you want.

If you have a style at the Label, Heading, or Amount level, this saving overrides the base style.

---

**Note:** All Row Style settings override the Column Style settings.

---

See the *Microsoft Excel documentation* for more information about how to use the Excel Format Cells dialog.

## Applying Styles to a Report Layout

To apply styles to a report layout in PS/nVision:

1. Open a report layout in nVision by selecting nVision, Open Layout.
2. Click the **Format Style Sheets** button on the nVision toolbar to open the Style Sheet Wizard and modify styles as needed.
3. When you have finished modifying styles, click the **Apply Styles** button on the Style Sheet Wizard.

A list of all open layouts appears.

4. Select the required layout and click the **OK** button.

## Modifying Styles Using the Excel Menu Bar

The Style Sheet Wizard is designed so you can easily take advantage of the Excel Style formatting settings and properly use the designed nVision Style naming convention. You can accomplish the same thing simply by opening a layout and selecting **Format > Styles** from the Excel menu bar. The Style dialog appears and you can create styles using the same naming convention as the Style Sheet Wizard.

The following examples show the naming convention for PS/nVision nPlosion styles. Note that if you apply the styles both from the Style Sheet Wizard and the Excel Menu Bar, the last applied style takes effect:

| <i>Field or Control</i> | <i>Description</i>  |
|-------------------------|---|
| <b>RxxH</b>             | The Header Style for any given level of a Row, where <i>R</i> represents a row, <i>xx</i> represents the number of the level (that is, 01, 02, and so on—00 represents the detail level), and <i>H</i> represents the Header Style.       |
| <b>RxxL</b>             | The Label Style for any given level of a Row, where <i>R</i> represents a row, <i>xx</i> represents the number of the level (that is, 01, 02, and so on—00 represents the detail level), and <i>L</i> represents the Label Style.         |
| <b>CxxA</b>             | The Amount Style for any given level of a column, where <i>C</i> represents a column, <i>xx</i> represents the number of the level (that is, 01, 02, and so on—00 represents the detail level), and <i>A</i> represents the Amount Style. |

| <b>Field or Control</b> | <b>Description</b>  |
|-------------------------|---|
| <b>CxxB</b>             | The Base Style for any given level of a column, where <i>C</i> represents a column, <i>xx</i> represents the number of the level (that is, 01, 02, and so on—00 represents the detail level), and <i>B</i> represents the Base Style. |

---

**Note:** Detail Row and Column Style settings are represented by the 00 level.

---

## Configuring the Style Sheet Directory Location

Your style sheet directory is indicated by PeopleSoft Configuration Manager for PS/nVision on Windows or by the Process Scheduler configuration file for PS/nVision on the web.

To configure the style sheet directory using the Configuration Manager for PS/nVision on Windows:

1. Open the Configuration Manager by double clicking the **Configuration Manager** icon on your desktop.

Alternatively, select **Start > Program > PeopleTools 8.x > Configuration Manager**.

2. Select the Profile tab, select a profile to edit, and then select the nVision tab to view or change PS/nVision settings.
3. Enter the location of the PeopleSoft style sheets.

The Oracle PeopleSoft application delivers a set of style sheets that can be located at **<PS\_HOME>\Excel\Style Sheets**.

To configure the style sheet directory using the Process Scheduler configuration file for PS/nVision on the web:

1. Select **Start > Command Prompt**.
2. Change the directory to **<PS\_HOME>\appserv\**.
3. Type *psadmin* and press **ENTER**.

The PeopleSoft Server Administration menu appears.

4. Select option 2 (Process Scheduler) and press **ENTER**.

The PeopleSoft Process Scheduler Administration menu appears.

5. Select option 3 (Configure a Process Scheduler Configuration) from the Process Scheduler Administration menu.
6. Enter the number that corresponds to the desired database and press **ENTER**.

A message about shutting down the Process Scheduler is displayed.

7. Enter *y* to continue.

8. Reply *n* to the questions *Do you want to change any values <y/n> [n]?* for all sections, except the nVision section.
9. For the nVision section, reply *y* to the questions *Do you want to change any values <y/n> [n]?*
10. Use the following information to modify the nVision section:
  - Parameter: StyleDir
  - Description: Enter the default location where PS/nVision keeps nPlosion Styles (these are usually inherited by the layout that the user is designing).
11. Accept the default values for the remaining options.

### Related Links

“Understanding PeopleSoft Configuration Manager” (System and Server Administration)

“Starting PeopleSoft Configuration Manager” (System and Server Administration)

## Using Multiple Chart-field nPlosion

The Multiple Chart-field nPlosion feature is an extension of the existing nPlosion feature. You can specify any number of fields for nPlosion with Multiple Chart-field nPlosion.

### Related Links

[Understanding nPlosion](#)

## Understanding Multiple Chart-field nPlosion

Multiple Chart-field nPlosion is used to provide functionality for data in financial reports to show detailed data values when there are multiple chart fields specified in the report. This data view helps people performing detailed financial analysis to get the data at the most granular level, and to do a comparative study across different entities like Account, Department and Business Units.

This feature offers:

- nPlosion on more than two chart-fields using a single criterion.
- Detailed data view at every entity or level.
- A summary or roll-up view at every level.

**Note:** Multiple chart-field nPlosion does not combine with a cell criteria.

**Note:** Filter criteria must be defined as a row criteria and all chart-fields for nPlosion must be added in this criteria.

### Related Links

[Understanding nPlosion](#)

[Defining nPlosion Criteria](#)

[Defining nPlosion Defaults](#)

[Enabling nPlosion for Specific Situations](#)

[Using Style Sheets with nPlosion Layouts](#)

## Defining Multiple Chart-field nPlosion

This example illustrates how to define Multiple Chart-field nPlosion using the existing functionality in nVision:

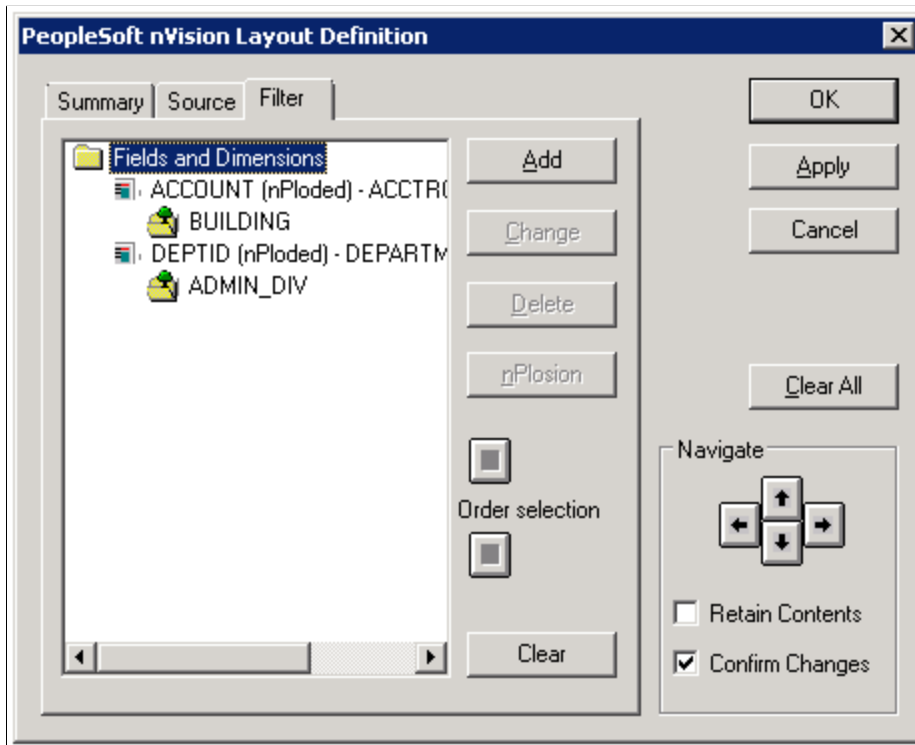

This example illustrates the fields and controls on the multiple chart-field nPlosion Layout window:

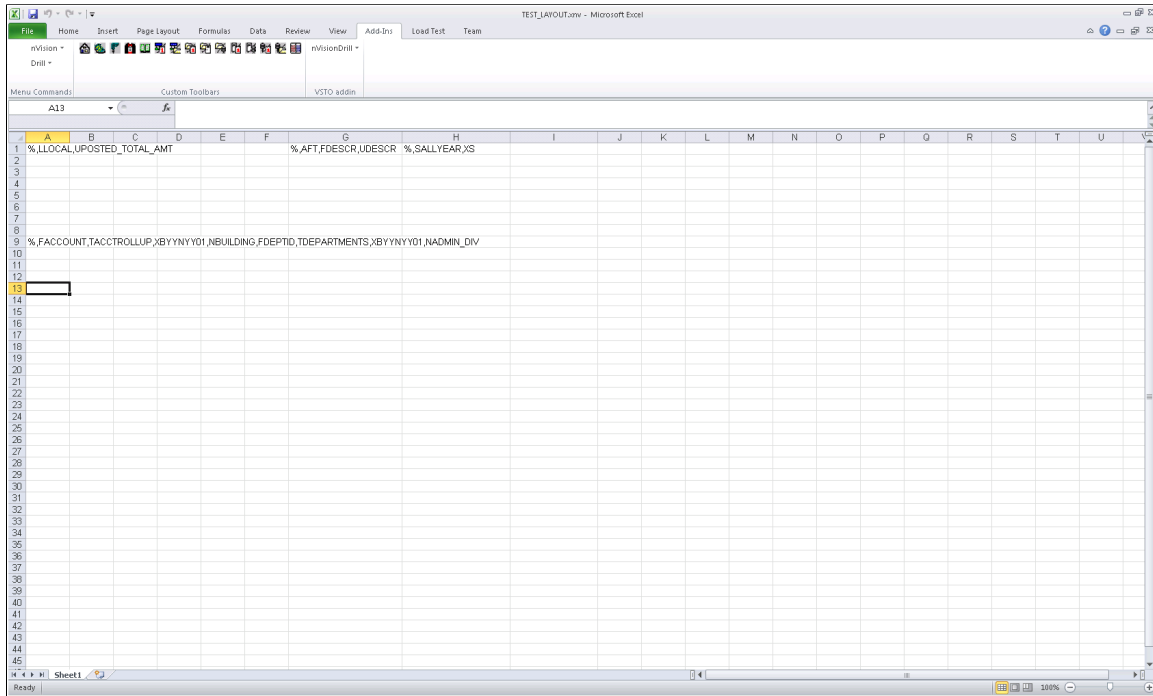

To define Multiple Chart-field nPlosion in nVision:

1. Open any existing layout or create a new one.
2. Select **nVision > Layout Definition** from the menu.
3. In the PeopleSoft nVision Layout Definition dialog box, select the cells to which you want to apply multiple chart-field nPlosion.
4. Select the Filter tab.
5. Click the Add button to add the chartfield.
6. Select the chart-field and then select the tree.
7. Add the node for which nPlosion is required.
8. Repeat steps 6 through 8 to add subsequent chart-fields.
9. Click OK.

This example illustrates the fields and controls on the multiple chart-field nPlosion Style Wizard window:

|    | A                        | B | C | D                    | E | F           | G           | H           | I           | J            | K | L | M | N | O | P | Q |
|----|--------------------------|---|---|----------------------|---|-------------|-------------|-------------|-------------|--------------|---|---|---|---|---|---|---|
| 1  | %LLOCALUPOSTED_TOTAL_AMT |   |   | %AFT_FDESCR,UDESCR   |   | %Y2000001   | %Y2000004   | %Y2000009   | %Y2000012   | %SALLYEAR.XS |   |   |   |   |   |   |   |
| 8  | %V61000                  |   |   | Insurance            |   | \$1,060.00  | \$1,040.00  | \$1,060.00  | \$1,060.00  | \$4,220.00   |   |   |   |   |   |   |   |
| 9  | %V61000                  |   |   | Telephone            |   | \$3,506.72  | \$3,440.56  | \$3,506.72  | \$3,506.72  | \$13,960.72  |   |   |   |   |   |   |   |
| 10 | %V640000                 |   |   | Rent                 |   | \$15,900.00 | \$15,600.00 | \$15,900.00 | \$15,900.00 | \$63,300.00  |   |   |   |   |   |   |   |
| 11 | %V10000                  |   |   | Human Resources      |   | \$20,466.72 | \$20,080.56 | \$20,466.72 | \$20,466.72 | \$81,480.72  |   |   |   |   |   |   |   |
| 12 | %NHR_GRP                 |   |   | Human Resource-Group |   | \$20,466.72 | \$20,080.56 | \$20,466.72 | \$20,466.72 | \$81,480.72  |   |   |   |   |   |   |   |

## Enabling Multiple Chart-field nPlosion for Specific Situations

You can enable or disable nPlosion for specific:

- Criteria fields

To enable or disable nPlosion for a specific criteria field, select a field from the Fields and Dimensions list on the PeopleSoft nVision Layout Definition – Filter dialog box, and then click the nPlode button. This generates underlying details only for the criteria fields you specify.

- Query or ledger TimeSpans

To enable or disable nPlosion for a query or ledger TimeSpan, select or clear the nPlode TimeSpan option on the PeopleSoft nVision Layout Definition – Source dialog box. This option is only available if you have a TimeSpan specified. This option generates detail columns for the individual periods in the TimeSpan; for example, the periods comprising year-to-date.

---

**Note:** TimeSpan must be specified as a column criteria for multiple ChartField nPlosion.

---

- Report requests

To enable or disable nPlosion for a report request, open the PeopleSoft nVision Report Request dialog box and select or clear the Enable nPlosion If Specified In Layout option. You can specify summary rows before or after nPlode rows based on an Excel option in layout. To set this, open your layout in Excel and select Data, then select Group and Outline, then select Settings.

---

**Note:** DrillDowns are not allowed for multiple ChartField nPlosion.

---

## **Related Links**

[Enabling nPlosion for Specific Situations](#)



# Using Advanced PS/nVision Options

## Enhancing Report Layouts

You can use Microsoft Excel to personalize the display and printing of your layout, including the use of built-in graphics and charts. Any elements that you define in the layout carry into the reports that you run.

This example illustrates the fields and controls on the Microsoft Excel window.

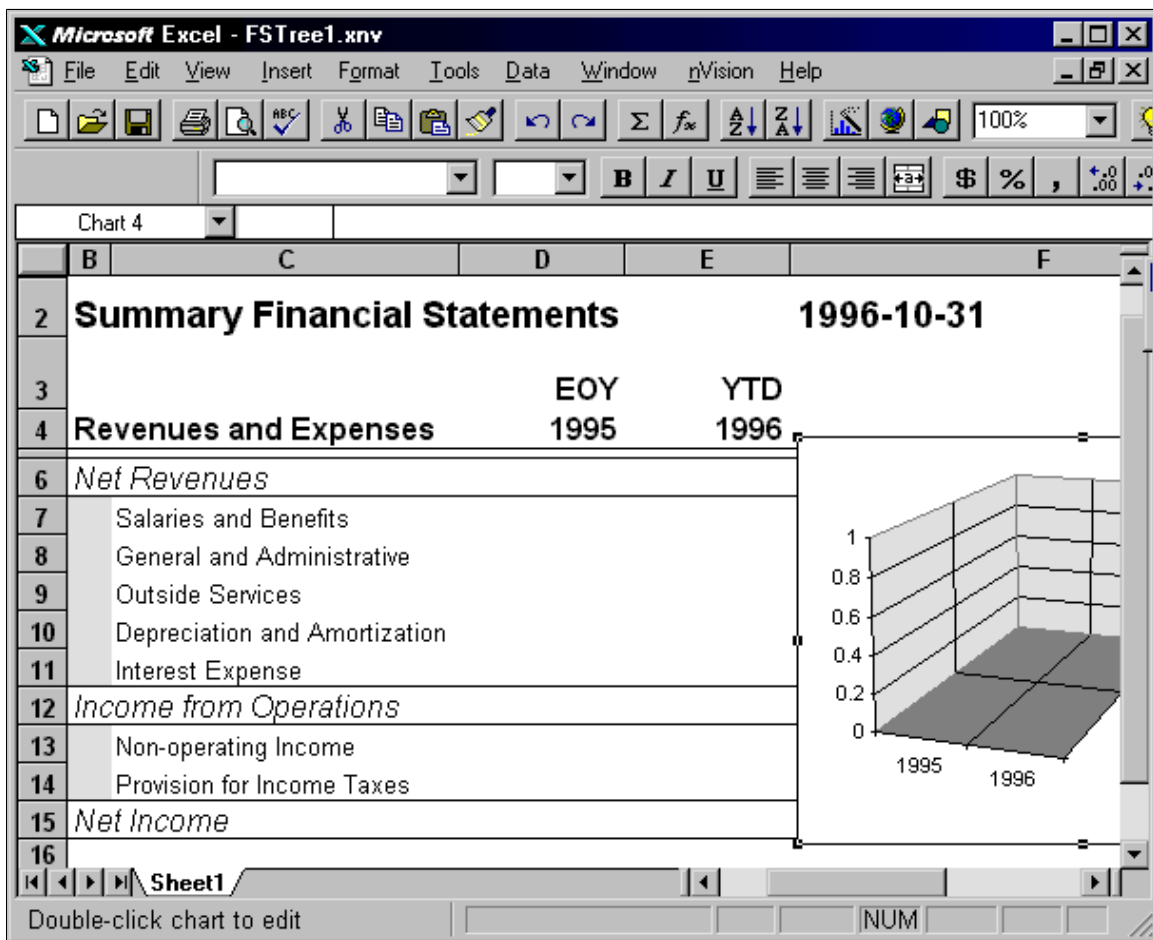

When you have completed refinements to the layout, remember to select **File > Save** from Microsoft Excel.

## Setting PS/nVision Options

Access the Options dialog box by opening an layout in PS/nVision and selecting **nVision > Options** from the toolbar.

This example illustrates the fields and controls on the PeopleSoft nVision Options dialog box.

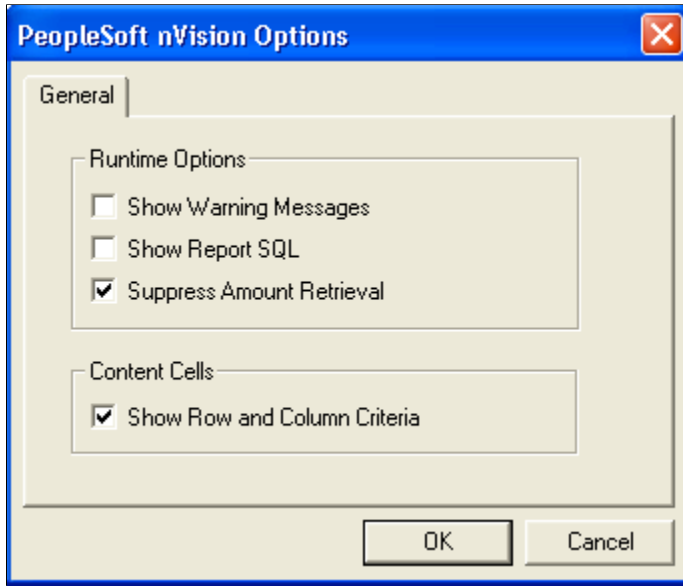

| <i>Field or Control</i>          | <i>Description</i>  |
|----------------------------------|---|
| <b>Show Warning Messages</b>     | <p>Select this option to display warning messages and dialog boxes when PS/nVision creates a new directory or overwrites a file.</p> <p>If you do not select this option, PS/nVision runs with as little prompting as possible.</p> <p>This option is ideal if you plan overnight or lunch-time report runs.</p>  |
| <b>Show Report SQL</b>           | <p>Select this option to display the SQL statements that retrieve the labels and amounts for your report. As PS/nVision prepares to execute each statement, a SQL reference dialog box appears. Click the <b>OK</b> button to continue or the <b>Cancel</b> button to stop the report at that point.</p> <p>You can copy the SQL statements to the Microsoft Windows Clipboard by pressing the <b>TAB</b> key until the text is selected, then pressing <b>CTRL+INS</b> or <b>CTRL+C</b>.</p> <p>Select this option only if you intend to step through the report run, as you must click the <b>OK</b> button after each statement.</p> |
| <b>Suppress Amount Retrieval</b> | <p>Select this option to have PS/nVision run the layout to make sure that all selection criteria are valid. PS/nVision does not retrieve amounts, so you can test the layout without waiting for data to be selected.</p> <p>This option is useful in combination with other options when you are debugging a report. If you also select the <b>Show Report SQL</b> option, you can determine whether the displayed SQL retrieves the data you want.</p>  |

| <i>Field or Control</i>             | <i>Description</i>  |
|-------------------------------------|---|
| <b>Show Row and Column Criteria</b> | Select this option to display the contents of Row 1 and Column A, PS/nVision reserves for data selection criteria when you create a layout. Content cells typically contain codes that relate to the ledger, TimeSpan, field criteria, and query names. |

## Creating Virtual Ledgers

A *virtual ledger* is an alternate view of ledger data used only for PS/nVision reporting. For instance, you might want to join data from another table (such as a product category table) with ledger data at reporting time.

You can also use a virtual ledger to provide an alternate security view for different groups of users. For example, you might want to provide an alternate view of the LOCAL ledger for users who need data secured by PROJECT, while other ledger users have access secured by DEPTID. You can set up a virtual ledger called PROJLOCAL, which is a view of the LOCAL ledger secured by PROJECT.

To create a virtual ledger called PROJLOCAL:

1. Select **Start > Programs > PeopleTools 8.x > Application Designer**.
2. In Application Designer, create an authorization table (AUTH\_PROJ\_TBL) with OPRID and PROJECT columns.
3. Create a page to maintain the authorization table.
4. Open the LEDGER record and use Save As to create a new record.
5. Name this new record *LED\_PROJLOCAL\_VW*.
6. Delete any unnecessary columns and create any additional columns.

In this example, we add the OPRID column because this view is used for security, and we delete PROCESS\_INSTANCE and TIMESTAMPS columns because these columns are not used for reporting.

The view text must contain the following features:

- Since we are using this view for security, it must deliver the OPRID (or OPRCLASS or ROWSECCLASS) field.

This is the first item in the SELECT list below.

- To get security by Project, the view joins the project authorization table to the ledger, making only the rows with matching projects visible for each user.
- The SELECT list must deliver the name of the virtual ledger to satisfy the PS/nVision "...LEDGER='PROJLOCAL'..." criteria, even though the rows retrieved are really ACTUALS.

See the third item in the SELECT list of the sample view text that follows.

- The Where clause must include "... AND LEDGER = 'LOCAL' ..." to select the desired rows from the real ledger .

This is example of the view text:

```
select b.oprid,
       a.business_unit,
       'PROJLOCAL',
       a.fiscal_year,
       a.accounting_period,
       a.account,
       a.deptid,
       a.product,
       a.project,
       a.affiliate,
       a.currency_cd,
       a.statistics_code,
       a.posted_total_amt
from   ps_ledger a,
       ps_auth_proj_tbl b
where  a.ledger='LOCAL'
       and a.project=b.project
```

7. Save the record definition and create the SQL view.
8. Create a ledger definition for PROJLOCAL, specifying LED\_PROJLOCAL\_VW as the reporting view record name.

The other record and field names can be the same as for LOCAL.

9. Use the Ledgers for a Business Unit page to associate the new ledger with the business units that will be using it.

In PS/nVision layouts, use PROJLOCAL, rather than LOCAL, in the Ledger criteria for reports to be run by the project accounting users.

## Using PS/nVision-Defined Names

This section describes the names that PS/nVision defines and looks up in layout and instance files. Many of these names are used for internal purposes, but several, such as NvsEndTime, are intended for users.

**Warning!** The values of these names, except for rare exceptions, are managed by PS/nVision and are not intended to be changed by customers. It's much safer to think of them as read-only. The names whose values you may change are indicated in italics in the following table. Never change the value of the names *not* highlighted in italics.

**Note:** Some names are used only in matrix or tabular layouts, but many apply to both as listed in the Sheet Type column. The Level column indicates whether the name is defined at the file (workbook) level or at the sheet level. Some strings begin with *V* to avoid problems if the string was null. Names of this type show *V* at the beginning of the Values column.

| <b>Name</b>              | <b>Sheet Type</b> | <b>Level</b> | <b>Values</b>   | <b>Comments</b>  |
|--------------------------|-------------------|--------------|-----------------|--|
| <i>NvsDateToNumber</i>   | Both              | File         | Y/N             | Y indicates to convert database dates (for example, the %ASD% variable) to the Excel native date format. Default N.  |
| <i>NvsDrillHyperLink</i> | Both              | File         | URL string      | Stores the static part of the DrillDown URL. PS/nVision generates a DrillDown URL for each drillable cell in the delivery instance to invoke the Run DrillDown page. The full URL stores the information about the Run DrillDown page (static) and location of the drillable cell (dynamic). |
| <i>NvsElapsedTime</i>    | Both              | File         | Excel date/time | Indicates the elapsed time to produce this instance. To see this elapsed time in the instance, enter the formula = <i>NvsElapsedTime</i> in a cell and format the cell with a time format.   |
| <i>NvsEndTime</i>        | Both              | File         | Excel date/time | Indicates the time this instance was saved. To see this time in the instance, enter the formula = <i>NvsEndTime</i> in a cell and format the cell with a date or date/time format.   |
| <i>NvsHiddenSheet</i>    | Both              | Sheet        | Y               | Used on hidden layout sheets only to enable data retrieval on the sheet.<br><br>By default, nVision will not process hidden layout sheets.   |
| <i>NvsInstanceHook</i>   | Both              | Sheet        | Reference       | Indicates the name or reference of the macro to be run on completion of the instance.  |

| <b>Name</b>               | <b>Sheet Type</b> | <b>Level</b> | <b>Values</b> | <b>Comments</b>   |
|---------------------------|-------------------|--------------|---------------|---|
| NvsLayoutType             | Both              | Sheet        | M3            | Indicates the layout version (unchanged for several years).   |
| NvsParentRef              | Both              | File         | Reference     | Stores the reference of the cell from which this instance drilled down.   |
| NvsSheetType              | Both              | Sheet        | M/T           | <i>M</i> = matrix, <i>T</i> = tabular, <i>undefined</i> = non-layout.   |
| NvsASD                    | Both              | File         | Vyyyy-mm-dd   | Stores the as of date from the report request.  |
| NvsAutoDrillOk            | Matrix            | File         | Y/N           | Indicates whether this instance includes a PeopleSoft Query data source; this controls whether the AutoDrill menu appears.  |
| <i>NvsDefaultDrill</i>    | Matrix            | File         | layout[,D]    | In layout, specifies default DrillDown layout for NvsAutoDrill (usually associated with double-click). Appending <i>D</i> to the layout name causes PS/nVision to translate summary ledgers to detail for this layout, without asking the user. For example, NvsDefaultDrill might be defined as = <i>ActPer</i> ; <i>D</i> . |
| <i>NvsTranslateLedger</i> | Matrix            | File         | Y/N           | Indicates whether the DrillDown is within a summary ledger ( <i>N</i> ) or detail ledger ( <i>Y</i> ).  |

| <b>Name</b>                      | <b>Sheet Type</b> | <b>Level</b> | <b>Values</b>   | <b>Comments</b>   |
|----------------------------------|-------------------|--------------|-----------------|---|
| NvsInstSpec                      | Both              | File         | Criteria string | Specifies the instance criteria. An instance for a division might look like %, <i>FDEPTID</i> , <i>TMFG</i> , <i>_DEPARTMENTS</i> , <i>NPRODUCTS</i> . On a DrillDown instance, it may also include TimeSpan and other criteria.  |
| NvsInstSpec1 ...<br>NvsInstSpec9 | Both              | File         | Criteria string | Continues NvsInstSpec. This enables PS/nVision (beginning in PeopleTools 8.1) to handle larger strings of instance criteria despite the Excel limitation of 255 characters per defined name. Because null strings cause problems, PS/nVision defines unused criteria continuations as a single comma, "=", ".". |
| NvsNplSpec                       | Matrix            | File         | Criteria string | Specifies nPlosion Options, from nPlosion Options dialog box. Contains the default nPlosion fields, as well as zero-suppression options, for rows and columns.  |

| <b>Name</b>     | <b>Sheet Type</b> | <b>Level</b> | <b>Values</b> | <b>Comments</b>   |
|-----------------|-------------------|--------------|---------------|---|
| NvsPanelBusUnit | Both              | File         | Vbusunit      | <p>Indicates the business unit used for prompting when designing a layout. Trees can be keyed by either setID or SETCNTRLVALUE, and PS/nVision supports the use of business unit as SETCNTRLVALUE.</p> <p>This value is entered on the Prompt dialog box and used only during layout design to retrieve trees keyed by Business Unit.</p> <p>When running reports, PS/nVision uses either the requesting business unit or its designated setID as the key for a given tree.</p> |
| NvsPanelEffdt   | Both              | File         | Vyyyy-mm-dd   | Indicates the layout effective date (governs prompting). Entered on the Prompt dialog box.  |
| NvsPanelSetid   | Both              | File         | Vsetid        | Indicates the setID used for prompting while entering layout criteria.  |
| NvsReqBU        | Both              | File         | Vbusunit      | Stores the requesting business unit from the report request.  |
| NvsReqBUOnly    | Both              | File         | VY/VN         | Stores the Data from Requesting Business Unit only option from the report request.  |

| <b>Name</b>               | <b>Sheet Type</b> | <b>Level</b> | <b>Values</b> | <b>Comments</b>   |
|---------------------------|-------------------|--------------|---------------|---|
| <i>NvsSkipDetailStyle</i> | Both              | File         | 0/1           | <p>The value <i>0</i> indicates that nPloded details appear in the format applied using the nPlosion style sheet.</p> <p>The value <i>1</i> indicates that nPloded details ignore the nPlosion style sheet applied to the report layout, and take their style attributes from the Microsoft Excel formatting.</p> |
| NvsTransLed               | Matrix            | File         | VY/VN         | Indicates whether summary ledgers were translated to detail when producing this instance. Used during DrillDown to know whether inherited criteria are already translated.  |
| NvsTreeASD                | Matrix            | File         | Vyyyy-mm-dd   | Stores the tree as of date from the report request.   |
| NvsTree.treename          | Matrix            | Sheet        | yyyyy         | Indicates tree performance options for a tree name. Each character is a Y/N option corresponding to an option on the Tree Performance Options dialog box, in sequence.  |
| NvsValTbl.fieldname       | Matrix            | File         | Record name   | In a layout, identifies the record name of the value table from which values and labels come for a criteria field. For DEPTID, the defined name for the value table is NvsValTbl.DEPTID, and its value might be "DEPARTMENT_TBL".   |

| <b>Name</b>    | <b>Sheet Type</b> | <b>Level</b> | <b>Values</b> | <b>Comments</b>  |
|----------------|-------------------|--------------|---------------|--|
| NvsAnswerCol   | Tabular           | Sheet        | Reference     | Refers to a column of data returned in a tabular report. Can be used to create references to any column of data, including all delivered answer rows.  |
| NvsQueryName   | Tabular           | Sheet        | Query name    | Stores the name of the query that provides the data for this tabular layout or instance.   |
| NvsRowCount    | Tabular           | Sheet        | Integer       | Records the number of rows delivered to this tabular instance sheet.   |
| NvsInstCritOpt | Tabular           | Sheet        | R/S/I         | Dictates how inherited criteria are to be handled for fields that do not appear in the current data source.<br><i>R</i> = required (error if inherited fields not present); <i>S</i> = Select criteria for those fields that match, ignore others; <i>I</i> = Ignore all inherited criteria. |

---

## Formatting Dates

PS/nVision can deliver dates in two different formats, which can be applied to matrix layouts (for variables such as %ASD%), tabular layouts, and the Excel template QUERY.XLT. (This is used in QueryLink when PeopleSoft Query delivers a query answer to Excel). These two formats are:

- Excel format, in which a date is represented by a number (12/31/99 is represented as 36525).

Excel formatting can be used to display the date in a variety of formats.

- String format ('1999-12-31').

You define the name NvsDateToNumber in your layout or QUERY.XLT to indicate the format you want to use. *Y* in NvsDateToNumber means to force dates to Excel numeric format, while *N* indicates to use the string format. The default for NvsDateToNumber is *N* for backward compatibility.

This is an example of the definition (accessed through the Excel menus: **Insert** > **Name** > **Define**).

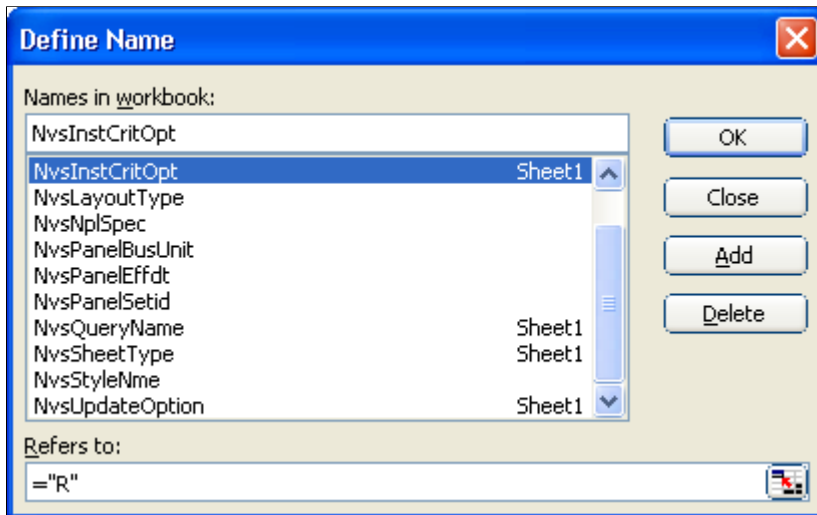

Unlike `NvsInstanceHook`, `NvsDateToNumber` is defined at the workbook level. You do not qualify the name using the sheet name.

## Setting Trace Files

Trace files are useful for generating troubleshooting and debugging information. You can configure trace files to be generated for PS/nVision processes: each nVision process generates its own trace file with time stamped entries, making troubleshooting easier. You can set the trace level to specify how much detail the trace files will show.

## Enabling Trace Files

By default, PS/nVision does not generate trace files because extensive tracing can affect system performance. You can enable tracing and determine the tracing level when you need debugging.

### Tracing for PS/nVision on Windows

You configure tracing in PS/nVision on Windows using the `Trace_Level` setting in PeopleSoft Configuration Manager. The default value is 0.

See “Understanding PeopleSoft Configuration Manager” (System and Server Administration), “Starting PeopleSoft Configuration Manager” (System and Server Administration).

### Tracing for PS/nVision on the Web

You configure PS/nVision tracing on the web using the **Trace Level** setting in the PeopleSoft Process Scheduler configuration file's nVision section. The default value is 0.

See “Using PSADMIN with PeopleSoft Process Scheduler” (Process Scheduler).

## Tracing Levels

PS/nVision supports five tracing levels: 0, 1, 2, 3, and 4. The following table shows the level of tracing for each value.

| <i>Tracing Level</i> | <i>Description</i>  |
|----------------------|---|
| 0                    | No tracing; no log files are generated. This is the default setting.  |
| 1                    | The lowest level of tracing. With this setting, nVision generates basic, high-level process flow and status information. You can use this setting to check whether nVision was launched successfully and whether it can connect to Microsoft Excel and process requests. Some of the key entries in Level 1 settings are: Command Line arguments, Trace Level, Excel Process ID, Run Control Name, Report Name, Business Unit, Drill Layout, and Instance Name.<br><br>A common scenario for which to use this level is if a PS/nVision process exits immediately after processing. |
| 2                    | This level contains entries from level 1 plus additional information. A high-level code flow is recorded with this setting.   |
| 3                    | This level includes tracing up to level 2 and SQL statements. For Microsoft Windows, PS/nVision runtime SQL can be displayed by selecting the <b>Show Report SQL</b> option from the <b>nVision &gt; Options</b> menu. The same SQL statements will be written into the log file by changing the trace level to 3.  |
| 4                    | This level is the highest and includes tracing up to level 3 plus additional function calls, output values, and other detail information. You can use this setting for identifying intermittent problems and random behaviors.  |

In addition to the above trace levels, there are two additional levels available for extended nVision tracing for identifying critical issues at OpenXML engine level. These levels are available only for OpenXML mode. The following table shows the level of tracing for each value.

| <i>Tracing Level</i> | <i>Description</i>   |
|----------------------|--|
| 100                  | This enables extended nVision tracing for function level Entry Exit in OpenXML engine that logs the details of Line number, Function Name and File Name in the psnvs_%pid%.nvt trace file. |

| <b>Tracing Level</b> | <b>Description</b>   |
|----------------------|--|
| 200                  | This level contains entries from level 100 and also generates stack trace of OpenXML engine. This generates two additional files in the log_output folder namely psnamsrv_stack.txt and psnvssrv_stack.txt |

---

**Note:** The extended nVision tracing is a tool for PeopleSoft product support to use for better supportability. We recommend that this feature be disabled in production mode.

---

## Viewing Trace Files

The trace file's output filename has the format *psnvs\_[process ID of psnvs.exe].nvt*. For example: *psnvs\_123.nvt*. You can view the trace file from both Windows-based and web-based PS/nVision.

---

**Note:** The server module PSNVSOXML generates an .nxt trace file in the same location as the .nvt file. The .nxt trace file contains log information from the server module PSNVSOXML. The trace settings of PS/nVision are applicable to both .nvt and .nxt trace files. Naming convention of the .nxt file is psnvsoxml\_[process ID of psnvs.exe].nxt; for example, psnvsoxml\_123.nxt.

---

### Viewing the Trace Files for PS/nVision on Windows

In Microsoft Windows PS/nVision, the trace file is generated in your system temporary directory; for example *c:\temp\psnvs\_123.nvt*.

---

**Note:** PS/nVision does not delete files generated in tracing for Microsoft Windows PS/nVision. You can delete the trace files from the temporary directory to save disk space.

---

### Viewing the Trace Files on the Web

On the web, because PeopleSoft Process Scheduler initiates all PS/nVision processes, it is also responsible for displaying PS/nVision trace information in the Process Monitor after PS/nVision reports are run to completion. The PS/nVision trace files are independent of the Process Scheduler's status of the report running, and are always posted regardless of your output types or formats. Trace files are secured by the same user list as the report, so only the same set of users can view them.

PS/nVision trace files are automatically purged when the reports are purged in the time frame that you have set from the Process Scheduler System Purge Option. You can view trace files from the View Trace/Log page in Process Monitor for your completed process instance.

To view a trace file:

1. Select **PeopleTools > Process Scheduler > Process Monitor**.
2. Find the process instance that runs your nVision report, and then click the **Details** link to access the Process Details page.
3. Click the **View/Trace Log** link to access the Message Log page.
4. Click the **nVision Trace** link to view the trace file.

If Process Scheduler has restarted your nVision report running process, this procedure generates multiple nVision trace files (one for each retry).

### Related Links

“Defining System Settings” (Process Scheduler)

---

## Dismissing Unattended Dialogs

PS/nVision can detect and close unattended dialog boxes on the batch server. To use this feature, you must enable the `EnablePollDialogs` and set the `PollDialogSeconds` parameters in the PeopleSoft Process Scheduler.

The `EnablePollDialogs` parameter is disabled (with setting equal to 0) by default, but if you have problems with unattended dialogs generated from PS/nVision in batch mode, you should change the setting to *Enabled* for debugging purposes. You can do this using the Process Scheduler's PSADMIN utility. Use the `PollDialogSeconds` parameter to specify how often to cycle polling for unattended dialogs. When `EnablePollDialogs` is enabled, you must set the `PollDialogSeconds` parameter to a value greater than 0.

---

**Note:** PS/ nVision will close only the dialogs originating from PS/nVision and Microsoft Excel.

---

See “Using PSADMIN with PeopleSoft Process Scheduler” (Process Scheduler).

# Using PeopleCode APIs for Excel

---

## Understanding PeopleCode APIs for Excel

PeopleCode APIs for Excel is a framework solution for easier interaction with Excel files or spreadsheets within PeopleCode. This feature provides the user the ability to interact with Excel spreadsheets by using PeopleCode APIs. These PeopleCode APIs work across multiple platforms which include Windows, UNIX and Linux.

This feature allows the user to:

- Develop PeopleCode functionality to interactively generate Excel reports in real-time.
- Read or write data from PIA to Excel documents and vice versa.
- Output Excel data on a pre-defined template.

### Related Links

[Using PeopleCode APIs for Excel](#)

“PSSpreadsheet Class Methods” (PeopleCode API Reference)

---

## Using PeopleCode APIs for Excel

Following are the operations that a user can perform via PeopleCode :

| <b><i>PeopleCode API</i></b> | <b><i>Description</i></b>                                  |
|------------------------------|--|
| Open                         | Opens existing workbook or creates new workbook.           |
| SaveAs                       | Saves existing template file to new workbook.              |
| Save                         | Saves generated excel file to output location.             |
| GetFileContent               | Retrieves generated excel file data from output directory. |
| SetCellNumber                | Sets number data into the cell within the workbook.        |
| SetCellString                | Sets string data into the cell within the workbook.        |
| SetCellFormula               | Sets formula data into the cell within the workbook.       |

| <b><i>PeopleCode API</i></b> | <b><i>Description</i></b>                                   |
|------------------------------|---|
| SetCellDate                  | Sets Date data into the cell within the workbook.           |
| SetColumnWidth               | Sets the width of the column within the workbook.           |
| SetCellHyperlink             | Sets hyperlink data in the cell.                            |
| SetCellHeaderStyle           | Sets cell header style.                                     |
| SetSheetActivate             | Sets the active sheet in the workbook.                      |
| SetActiveSheetName           | Updates the name of the existing sheet within the workbook. |
| CreateSheet                  | Creates new sheet within the workbook.                      |
| RangeRowOutline              | Enables or disables outline on the range of rows.           |
| RangeColOutline              | Enables or disables outline on the range of columns.        |
| RangeApplyStyle              | Sets style of the range of cells.                           |
| InsertRows                   | Inserts rows in the active sheet.                           |
| InsertColumns                | Inserts columns in the active sheet.                        |
| SetRowSetData                | Sets scroll rowset data into the sheet.                     |

### **Related Links**

[Understanding PeopleCode APIs for Excel](#)

“PSSpreadsheet Class Methods” (PeopleCode API Reference)

[Testing PeopleCode APIs](#)

## **Testing PeopleCode APIs**

To test the PeopleCode APIs, a PIA sample test page called ‘SpreadSheet API Sample Page’ is available to the users. This section tells you how to use this page to test the PeopleCode APIs.

### **Pre-requisites for Using the SpreadSheet API Sample Page**

1. Output Path should always be specified with the full path and name of file to be created or updated.

- Output Directory should always exist. Otherwise, there will be an error displaying “Directory cannot be created.”

## Using the SpreadSheet API Sample Page

To access the SpreadSheet API Sample Page, select **Reporting Tools > PS/nVision > PSSpreadsheet API Sample Page**.

This example illustrates the fields and controls on the SpreadSheet API Sample Page. You can find definitions for the fields and controls later on this page.

| <b>Field or Control</b> | <b>Description</b>   |
|-------------------------|--|
| <b>Input Path</b>       | Input path of existing template file.  |
| <b>Output Path</b>      | Output path where generated excel file is to be saved.   |
| <b>Enable Rowset</b>    | <p>This field has two modes — enable and disable rowset.</p> <p>When the Enable Rowset check box is selected, the entire rowset data is saved as is to the output excel file in a single operation.</p> <p>When the Enable Rowset check box is deselected, only the cell data field within the rowset is saved to the output excel file in a single operation.</p> |
| <b>Row Number</b>       | Cell row number within the excel file.   |
| <b>Col Number</b>       | Cell column number within excel file.  |

| <b>Field or Control</b> | <b>Description</b>  |
|-------------------------|---|
| <b>Cell Type</b>        | Type of cell data (number, string, formula, date).<br>Following are the defined values of this field: <ul style="list-style-type: none"> <li>• Number = 0</li> <li>• String = 1</li> <li>• Formula = 2</li> <li>• Date = 6</li> </ul> |
| <b>Cell Data</b>        | Cell data to be saved into the excel file.  |
| <b>Save</b>             | Invokes Spreadsheet APIs to generate and save the field data into the output excel file.  |

### Related Links

[Understanding PeopleCode APIs for Excel](#)

[Using PeopleCode APIs for Excel](#)

“PSSpreadsheet Class Methods” (PeopleCode API Reference)

[Testing PeopleCode APIs](#)

## Generating Excel Output File

When the user supplies all the input data and clicks on the Save button, it triggers the Spreadsheet PeopleCode APIs. As a result of this, an excel file is generated and saved to the given output path location. The user receives the same output file in their browser as a download option, allowing the user to either open or save the file.

The following example illustrates a spreadsheet that shows the entire rowset data as output.

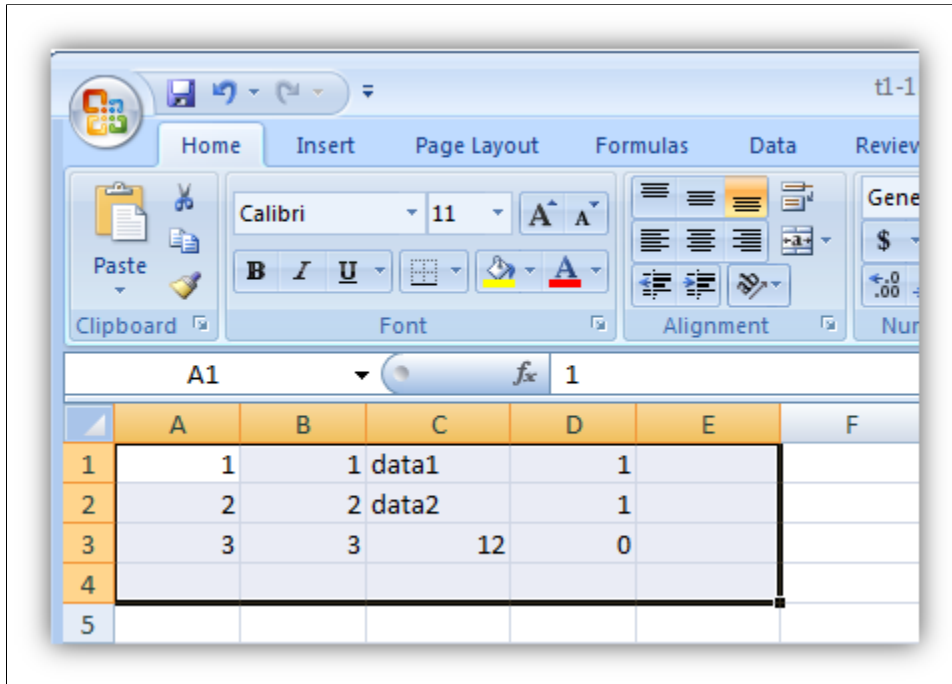

### Related Links

[Understanding PeopleCode APIs for Excel](#)

[Using PeopleCode APIs for Excel](#)

[Testing PeopleCode APIs](#)

“PSSpreadsheet Class Methods” (PeopleCode API Reference)



# Personalizing PS/nVision

---

## Understanding PS/nVision Personalization

You can personalize numerous PS/nVision options through the Configuration Manager and can even change the user interface for reporting and DrillDown. PS/nVision provides a Microsoft Excel workbook (NVSUSER.XLS) with a custom DrillDown menu and buttons for common actions. From this starting point, you can construct a custom user interface for your organization or for a select groups of users.

---

**Note:** PS/nVision also supports previous versions of personalized and non-personalized NVSUSER.XLM files.

---

PS/nVision product delivers NVSUSER as a starting point. You can use it with minimal modifications, make major enhancements, or replace it altogether.

---

## Using Configuration Manager

The PeopleTools Configuration Manager enables you to maintain PeopleSoft-specific configuration information in the Windows Registry. You should use the Configuration Manager to maintain PS/nVision settings (and other PeopleTools settings) rather than editing the Windows Registry directly.

This section describes how to:

- Change the Configuration Manager settings.
- Define the directory paths.
- Specify the formatting options.
- Specify the AsofDateforLabels option.

## Changing Configuration Manager Settings

The settings in the Edit Profile – nVision dialog box control where PS/nVision looks for various file types. PeopleSoft Query Link, the feature that enables you to send PeopleSoft Query output to a spreadsheet, also refers to these Configuration Manager settings.

Use these steps to access the Configuration Manager:

1. Open the Configuration Manager by double clicking the **Configuration Manager** icon on your desktop.

Alternatively, select **Start > Program > PeopleTools 8.x > Configuration Manager**.

2. Select the Profile tab.

3. Select the profile to edit, and click the **Edit** button.
4. Select the nVision tab in the Edit Profile dialog box to view or change PS/nVision settings.

The Edit Profile – nVision dialog box appears.

This example illustrates the fields and controls on the Edit Profile dialog box: nVision tab.

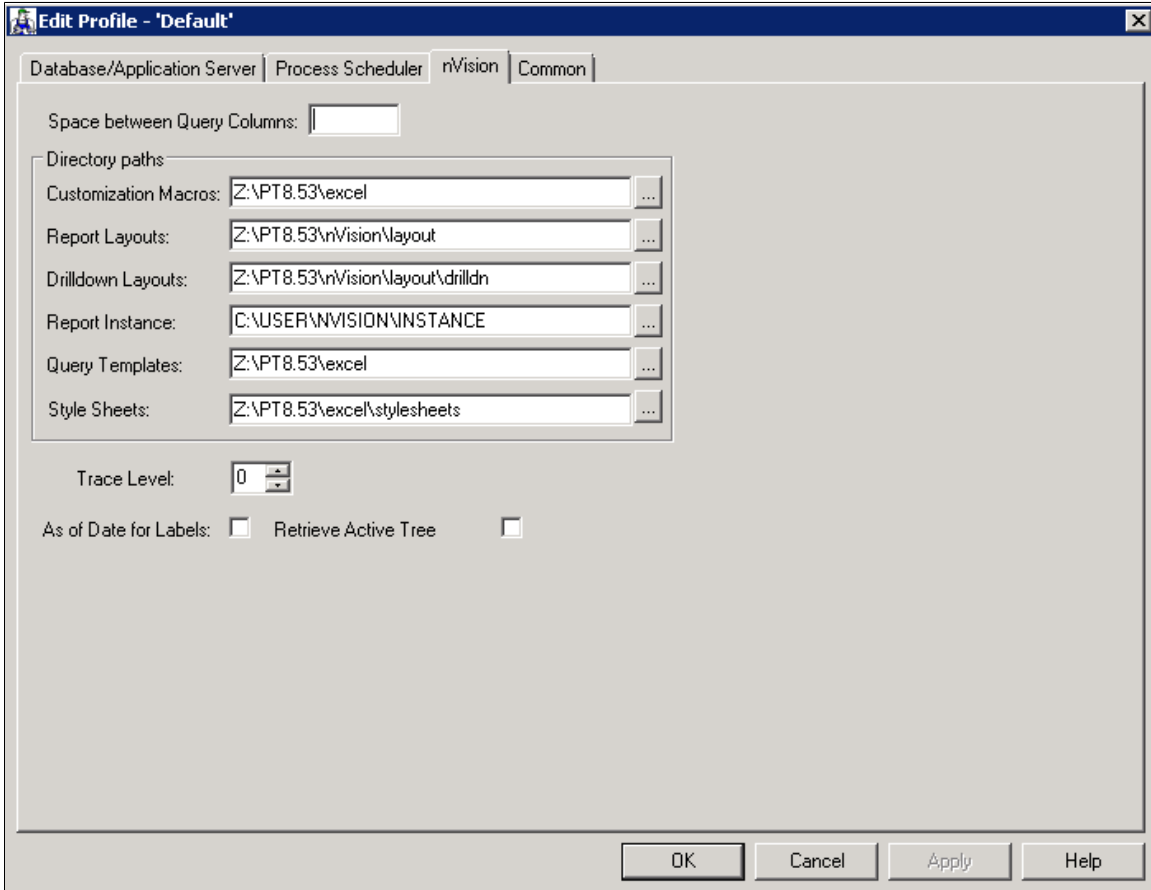

**Note:** Changes made with the Configuration Manager do not take effect until you sign on to the system. If you are signed on while making changes to Configuration Manager, you have to sign off and sign back on to see the effect of the changes.

The following table lists and describes the controls that are available for PS/nVision in the Configuration Manager.

| <b>Control</b>              | <b>Description</b>  |
|-----------------------------|---|
| Space Between Query Columns | Sets the number of blank Microsoft Excel characters that PeopleSoft Query Link places between query output columns. To eliminate spacer columns, set this value to 0. Spacer columns improve readability, but they can be problematic with Microsoft Excel list features (such as filters or subtotals) or if you want to export data to another program. |

| <b>Control</b>       | <b>Description</b>   |
|----------------------|--|
| Customization Macros | Specifies the directory path PS/nVision should search for macros used with PS/nVision and PeopleSoft Query Link. It is usually %PS_HOME%\EXCEL. This is also the path PS/nVision searches for the user macro sheet (normally NVUSER.XLS) if it is not found in the layout directory path.  |
| Report Layouts       | Specifies the directory path PS/nVision should search for layout files. They are usually in \USER\NVISION\LAYOUT, but you might also have a shared layout directory on the network. The layout directory path is also searched first for the user macro file (normally NVUSER.XLS), enabling you to use a personalized front-end macro sheet rather than the standard one for the organization.  |
| DrillDown Layouts    | Specifies the directory that contains PS/nVision DrillDown layouts, usually \USER\NVISION\LAYOUT\DRILLDN.  |
| Report Instance      | Specifies the directory into which PS/nVision places report instances. This value can be overridden via the directory template in the Report Request dialog box.   |
| Query Templates      | Specifies where to look for the QUERY.XLT file. This file defines the Microsoft Excel styles used to format output. If no template directory is specified, or if PS/nVision doesn't find Query.XLT there, it searches in the personalization macro path.   |
| Style Sheets         | Specifies the directory of predefined nPlosion styles for the style sheet.   |
| AsofDateforLabels    | <p>Specifies whether the as-of date or the maximum-effective date will be used to retrieve label descriptions of nVision reports and drilldowns.</p> <ul style="list-style-type: none"> <li>• Deselect this option to enable PS/nVision to always display maximum-effective dated label descriptions of tree nodes and detail values.</li> </ul> <p>By default, this option is deselected and PS/nVision shows the same behavior as earlier versions of PS/nVision.</p> <hr/> <p><b>Note:</b> PS/nVision has been applying the maximum-effective date logic in releases prior to PeopleTools 8.52.</p> <hr/> <ul style="list-style-type: none"> <li>• Select this option to enable PS/nVision to effectively process date for label descriptions and retrieves descriptions using the as-of date of the nVision report being run.</li> </ul> <p>See <a href="#">Using Configuration Manager</a>.</p> |

| <b>Control</b>           | <b>Description</b>   |
|--------------------------|--|
| RetrieveActiveTreeLabels | <p>Specifies whether only active tree node label descriptions are retrieved for nVision reports and drilldowns.</p> <ul style="list-style-type: none"> <li>Deselect this option to enable PS/nVision to disregard the activeness of the tree node label descriptions.</li> </ul> <p>By default, this option is deselected and PS/nVision shows the same behavior as earlier versions of PS/nVision.</p> <hr/> <p><b>Note:</b> PS/nVision has been disregarding the activeness of the tree node label descriptions in releases prior to PeopleTools 8.52.</p> <hr/> <ul style="list-style-type: none"> <li>Select this option to enable PS/nVision to strictly use the activeness of the tree node label descriptions. Only active tree node label descriptions are retrieved by PS/nVision.</li> </ul> |

**Note:** These settings are for the Windows version of PS/nVision. To run PS/nVision through Process Scheduler, the configuration settings are in the [nVision] section of **\$PSHOME\APPSERV\PRCS\ \$databasename\psprcs.cfg**.

In the Process Scheduler Configuration file (psprcs.cfg), the default directory of the report instance is **%PS\_SERVDIR%\NVISION\INSTANCE**.

The report layout and drilldown layouts are located under %PSHOME%; for example, **%PSHOME%\NVISION\LAYOUT** and **%PSHOME%\NVISION\LAYOUT\DRILLDN**.

%PSHOME% is read-only and only an administrator can add a new layout or modify existing layouts. You can relocate these two directories outside of PSHOME if all users need the write access to these directories.

General configuration settings in Process scheduler configuration (psprcs.cfg) for PS/nVision are:

```
DrillDownDir=%PS_HOME%\NVISION\LAYOUT\DRILLDN
InstanceDir=%PS_SERVDIR%\NVISION\INSTANCE
LayoutDir=%PS_HOME%\NVISION\LAYOUT
MacroDir=%PS_HOME%\EXCEL
StyleDir=%PS_HOME%\EXCEL\STYLESHEETS
TemplateDir=%PS_HOME%\EXCEL
EnableDrillDownForFile=0
EnablePollDialogs=0
PollDialogSeconds=30
TraceLevel=4
SaveTempFile=0
UseExcelAutomation=0
AsofDateForLabels=0
RetrieveActiveTreeLabels=0
```

*UseExcelAutomation* is used to enable or disable Excel automation mode. The default setting, *UseExcelAutomation=0*, should not be changed because this is the only mode under which nVision can run currently.

*RetrieveActiveTreeLabels* is used to specify whether only active tree node label descriptions are retrieved for nVision reports and drilldowns. The default setting *RetrieveActiveTreeLabels=0* enables PS/nVision to disregard the activeness of the tree node label descriptions. When *RetrieveActiveTreeLabels=1*, nVision strictly use the activeness of the tree node label descriptions.

## Specifying the AsofDateForLabels Option

*AsofDateForLabels* is used to specify whether the as-of date or the maximum-effective date will be used to retrieve label descriptions of nVision reports and drilldowns. The default setting *AsofDateForLabels=0* enables nVision to always display maximum-effective dated label descriptions of tree nodes and detail values. When *AsofDateForLabels=1*, nVision effectively processes date for label descriptions and retrieves descriptions using the as-of date of the nVision report being run.

## Deselecting the AsofDateforLabels Option

If you deselect the **AsofDateforLabels** option in the Edit Profile – nVision dialog box of the Configuration Manager, PS/nVision applies the maximum effective dated logic that retrieves the row descriptions only from the maximum effective dated entries for the tree nodes and detail values. In other words, labels are retrieved from tree node descriptions and data are retrieved from detail values associated with the tree leaves and mapped to application data. This maximum effective dated logic is also inherited when you perform a drilldown from nVision reports.

In this example, tree nodes and detail values show multiple effective-dated tree node with descriptions.

The screenshot shows a 'Tree Node' dialog box with the following details:

- SetID:** SHARE
- Tree Node:** CGSDetail
- Tree Node Information** (with Find | View 1, First, 1-2 of 2, Last navigation)
- Entry 1:**
  - \*Effective Date: 01/01/2001
  - \*Status: Active
  - \*Description: Detailed Cost of Goods Sold
- Entry 2:**
  - \*Effective Date: 01/01/1900
  - \*Status: Active
  - \*Description: Cost of Goods Sold Detail

This example shows multiple effective-dated account details with different descriptions.

Account | Map to Alternate Account

SetID: SHARE Account: 500000

Effective Date Find | View 1 First 1-2 of 2 Last

\*Effective Date: 01/01/2001 \*Status: Active

\*Description: Cost of Goods - Latest Account

\*Short Description: COGS

Monetary Account Type: Expense

Balance Sheet Indicator: Balance Sheet

\*VAT Account Flag: VAT Applicable Account

Performance Measurement

General Ledger Account  Performance Measurement Acct  ABM Account

\*Effective Date: 01/01/1900 \*Status: Active

\*Description: Cost of Goods Sold

\*Short Description: COGS

Even though the descriptions of the tree nodes and detail values are different for 01/01/2000 and 01/01/2001, report results show only the descriptions of 01/01/2001 (*Cost of Goods – Latest Account* and *Detailed Cost of Goods Sold*), which is the maximum effective dated descriptions for both reports.

Report results of nVision report run as of 01/01/2000.

|                                |       |   |       |
|--------------------------------|-------|---|-------|
| Cost of Goods - Latest Account | 18147 | 0 | 18147 |
| Detailed Cost of Goods Sold    | 18147 | 0 | 18147 |

Report results of nVision report run as of 01/01/2001.

|                                |         |   |         |
|--------------------------------|---------|---|---------|
| Cost of Goods - Latest Account | 1598031 | 0 | 1598031 |
| Detailed Cost of Goods Sold    | 1598031 | 0 | 1598031 |

Similarly, when you perform a drilldown from an nVision report as of 01/01/2000, report results show the descriptions of 01/01/2001, which is invalid in 01/01/2000.

Drilldown report results as of 01/01/2000.

| Breakdown by Account & Period |                                |        |        |
|-------------------------------|--------------------------------|--------|--------|
| Account                       | Description                    | 2000-7 | Amount |
| 500000                        | Cost of Goods - Latest Account | 18,147 | 18,147 |
|                               | Detailed Cost of Goods Sold    | 18,147 | 18,147 |

When PS/Vision applies maximum effective dated logic:

- Future effective dated descriptions, which are invalid at present, may be used.
- The descriptions and the actual data can be out of synchronization, as the data is retrieved using the as-of date of the report and the descriptions are retrieved only for maximum effective dated values, irrespective of whether the label is set to *Active* or *Inactive*.
- Drilldown report results are retrieved using the maximum-effective date of the parent report.

### Selecting the AsofDateForLabels Option

If you select the **AsofDateForLabels** option in the Edit Profile – nVision dialog box of the Configuration Manager, PS/nVision applies the as-of dated logic that effectively processes date for label descriptions and retrieves labels using the As of Date of the nVision report being run. Therefore, nVision report results display accurate label descriptions.

In this example, tree nodes and detail values show multiple effective-dated tree node with descriptions.

Tree Node

---

**SetID:** SHARE    **Tree Node:** CGSDetail

Tree Node Information

[Find](#) | [View 1](#)    First 1 1-2 of 2 2 Last

|                         |   |                 |  |     |
|-------------------------|---|-----------------|--|-----|
| <b>*Effective Date:</b> | 01/01/2001 <span style="border: 1px solid black; padding: 0 2px;">31</span> | <b>*Status:</b> | Active <span style="border: 1px solid black; padding: 0 2px;">▼</span> | + - |
| <b>*Description:</b>    | Detailed Cost of Goods Sold   |                 |  |     |
|                         |   |                 |  |     |
| <b>*Effective Date:</b> | 01/01/1900 <span style="border: 1px solid black; padding: 0 2px;">31</span> | <b>*Status:</b> | Active <span style="border: 1px solid black; padding: 0 2px;">▼</span> | + - |
| <b>*Description:</b>    | Cost of Goods Sold Detail   |                 |  |     |

This example shows multiple effective-dated account details with different descriptions.

Account | Map to Alternate Account

SetID: SHARE Account: 500000

Effective Date Find | View 1 First 1-2 of 2 Last

\*Effective Date: 01/01/2001 \*Status: Active

\*Description: Cost of Goods - Latest Account

\*Short Description: COGS

Monetary Account Type: Expense

Balance Sheet Indicator: Balance Sheet

\*VAT Account Flag: VAT Applicable Account

Performance Measurement

General Ledger Account  Performance Measurement Acct  ABM Account

---

\*Effective Date: 01/01/1900 \*Status: Active

\*Description: Cost of Goods Sold

\*Short Description: COGS

When PS/nVision applies the as-of dated logic, the report results display accurate label descriptions for both tree nodes and detail values.

Report results of nVision report run as of 01/01/2000.

|                           |       |   |       |
|---------------------------|-------|---|-------|
| Cost of Goods Sold        | 18147 | 0 | 18147 |
| Cost of Goods Sold Detail | 18147 | 0 | 18147 |

Report results of nVision report run as of 01/01/2001.

|                                |         |   |         |
|--------------------------------|---------|---|---------|
| Cost of Goods - Latest Account | 1598031 | 0 | 1598031 |
| Detailed Cost of Goods Sold    | 1598031 | 0 | 1598031 |

Report results of nVision drilldown report run as of 01/01/2000.

| Breakdown by Account & Period |                           |        |        |
|-------------------------------|---------------------------|--------|--------|
| Account                       | Description               | 2000-7 | Amount |
| 500000                        | Cost of Goods Sold        | 18,147 | 18,147 |
|                               | Cost of Goods Sold Detail | 18,147 | 18,147 |

Report results of nVision drilldown report run as of 01/01/2001.

| Account | Description                    | 2001-1    | Amount    |
|---------|--------------------------------|-----------|-----------|
| 500000  | Cost of Goods - Latest Account | 1,598,031 | 1,598,031 |
|         | Detailed Cost of Goods Sold    | 1,598,031 | 1,598,031 |

When PS/Vision applies the as-of dated logic, PS/nVision:

- Retrieves label descriptions that are effective *less than* or *equal to* the As of Date of the report.
- Retrieves label descriptions of drilldown reports using the As of Date of the parent report.
- Only uses label descriptions of the active tree nodes.

In this example, the tree node corresponding to 01/01/2001 is set to *Inactive*. When you run the nVision report as of 01/01/2001, PS/nVision uses the next nearest active effective-dated record 01/01/1900 for label descriptions.

**Tree Node**

SetID: SHARE Tree Node: CGSDETAIL

---

**Tree Node Information** Find | View 1 First 1-2 of 2 Last

|                  |                             |  |          |          |
|------------------|-----------------------------|--|----------|----------|
| *Effective Date: | 01/01/2001                  |  | *Status: | Inactive |
| *Description:    | Detailed Cost of Goods Sold |  |          |          |

---

|                  |                           |  |          |        |
|------------------|---------------------------|--|----------|--------|
| *Effective Date: | 01/01/1900                |  | *Status: | Active |
| *Description:    | Cost of Goods Sold Detail |  |          |        |

|                                |         |   |         |
|--------------------------------|---------|---|---------|
| Cost of Goods - Latest Account | 1598031 | 0 | 1598031 |
| Cost of Goods Sold Detail      | 1598031 | 0 | 1598031 |

- May returns empty label description.

In this example, the descriptions of tree nodes for 01/01/1900 is *Inactive* and for 01/01/2001 is *Active*. When a report is run as of 01/01/2000, PS/nVision displays empty label description in report results because none of the descriptions are effective as of 01/01/2000

Tree Node

**SetID:** SHARE    **Tree Node:** CGSDETAIL

Tree Node Information

Find | View 1    First 1-2 of 2 Last

**\*Effective Date:** 01/01/2001 31    **\*Status:** Active ▼

**\*Description:** Detailed Cost of Goods Sold

---

**\*Effective Date:** 01/01/1900 31    **\*Status:** Inactive ▼

**\*Description:** Cost of Goods Sold Detail

|  |                    |       |   |       |  |
|--|--------------------|-------|---|-------|--|
|  | Cost of Goods Sold | 18147 | 0 | 18147 |  |
|  |                    | 18147 | 0 | 18147 |  |

**Note:** To avoid having empty descriptions in nVision report results, deselect the **AsofDate for Labels** option in the Edit Profile – nVision dialog box of the Configuration Manager.

## Defining Directory Paths

You can specify paths containing multiple directory locations for layouts and several other types of files. Within a path, semicolons separate directory names, and the directories in the path are searched in the order listed. For example, the layout path might contain:

```
C:\USER\NVISION\LAYOUT;N:\PS\NVISION\LAYOUT
```

When PS/nVision starts, it searches the layout directories in sequence for NVUSER.XLS. If PS/nVision cannot find it in any of these directories, it looks in the macro directory path. If it cannot find NVUSER.XLS, it looks for NVUSER.XLM. Similarly, when PS/nVision opens or runs a report, it searches the layout directories in sequence until it finds the layout. The same path options exist for the Excel installation path, macros, templates, and DrillDown layouts.

In addition, when searching a directory path, PS/nVision looks first for a subdirectory with the name of language of the current user. This functionality enables users of different languages to share the same settings while maintaining layouts in multiple languages. For example, if the language setting in Configuration Manager is French, then PS/nVision searches the following directories in sequence for the layout directory in the previous example:

```
C:\USER\NVISION\LAYOUT\FRA
C:\USER\NVISION\LAYOUT
N:\PS\NVISION\LAYOUT
N:\PS\NVISION\LAYOUT\FRA
```

## Specifying Formatting Options

The PeopleSoft Query Link portion of PS/nVision uses a standard Microsoft Excel template, QUERY.XLT, to format data retrieved from a query. QUERY.XLT contains some special styles that you can personalize. Use the Excel Format, Styles option and save your changes to QUERY.XLT.

---

**Note:** The location of QUERY.XLT is specified on the nVision tab of the Configuration Manager in the Query Templates dialog box.

---

The following table lists the special PeopleSoft styles that you can apply to QUERY.XLT.

| <b>Style Name</b> | <b>Data Type Formatted</b>                          |
|-------------------|---|
| PSChar            | Character fields (such as names)                    |
| PSDate            | Dates   |
| PSDec             | Numbers with decimal places, such as dollar amounts |
| PSInt             | Integers (such as years)                            |
| PSHeading         | Column headings                                     |
| PSSpacer          | Space between data columns                          |

---

## Personalizing NVSUSER.XLS

The NVSUSER worksheet provided by PeopleSoft includes macros to personalize the user menu and toolbar.

This section describes how to:

- Customize buttons.
- Add buttons with the button wizard.
- Customize menus.
- Make Excel row and column indicators visible.
- Change the toolbar.

### Related Links

[Using PS/nVision API Functions](#)

## Customizing Buttons

Each button on the NVSUSER sheets has a macro assigned to it to perform a function. As delivered, NVSUSER buttons are grouped into Run, View, and Command groups. You can change the groupings and meanings of the buttons. You can also format the button sheet to personalize its color and appearance.

To change the macro, a button is assigned to:

1. Position the mouse pointer over the button (it becomes a hand), but do not click it.
2. Right-click and select **Assign** > **Macro** from the shortcut menu.
3. Enter the name of the macro you want to run when the button is clicked.
4. Click the **OK** button to complete the assignment.

---

**Note:** If you have macros that were created using Microsoft Excel 95, the Excel Edit Name dialog box appears when you define the name for the cell in which the macro begins. Select the **Command-type** option to identify your macro as a Command macro. The Excel Edit Name dialog box does not appear for later versions of Microsoft Excel.

---

## Adding Buttons With the Button Wizard

To use the button wizard in PS/nVision:

1. Select **Start** > **Programs** > **PeopleTools 8.x** > **nVision**.
2. Click the **Add Buttons** from the NVSUSER.XLS home page.
3. Select whether to run a report or view a report, and click the **Next** button.
4. Select either your report request or your instance.

You can navigate to an instance from the button with ellipses on it.

5. Click the **Next** button.
6. Type in a caption for your button.
7. Optionally, select a picture for your button by clicking the **Image** button and navigating to the location of an image file.
8. Click the **Finished** button.

The new button is placed directly below the lowest-positioned button in a specific Run or View category. After initially placed on the sheet, the button can be moved or changed. However, try not to ungroup buttons with images. If necessary, remember the defined button name before ungrouping; then, when regrouped, rename the button group accordingly.

To ungroup the button, right-click it, select the ungroup function from the menu, and make your changes.

To regroup, right-click it again and select the regroup function from the menu.

## Customizing Menus

Access the PeopleSoft nVision Menu Control Table window by clicking the PSMenu tab on the nVision home page NVSUSER.XLS.

This example illustrates the fields and controls on the PeopleSoft nVision Menu Control Table window.

| Menu Name: | D&riil | Appli-cation | Active (Y) | Menu Command                        | DrillDown Layout | DrillDown Query | Macro | Description   |
|------------|--------|--------------|------------|-------------------------------------|------------------|-----------------|-------|---|
|            | GL     | Y            | Y          | Business Unit by Period             | BusPer           |                 |       | Breakdown by Business Unit and Period                 |
|            | GL     | Y            | Y          | Business Unit by Account            | BusAct           |                 |       | Breakdown by Business Unit and Account                |
|            | GL     | Y            | Y          | Business Unit by Department         | BusDep           |                 |       | Breakdown by Business Unit and Department             |
|            | GL     | Y            | Y          | Business Unit by Product            | BusPrd           |                 |       | Breakdown by Business Unit and Product                |
|            | GL     | Y            | Y          | .                                   |                  |                 |       |   |
|            | GL     | Y            | Y          | Account by Period                   | ActPer           |                 |       | Breakdown by Account and Period                       |
|            | GL     | Y            | Y          | Account by Department               | ActDep           |                 |       | Breakdown by Account and DeptId                       |
|            | GL     | Y            | Y          | Account by Product                  | ActPrd           |                 |       | Breakdown by Account and Product                      |
|            | GL     | Y            | Y          | Account by Business Unit            | ActBus           |                 |       | Breakdown by Account and Business Unit                |
|            | GL     | Y            | Y          | .                                   |                  |                 |       |   |
|            | GL     | Y            | Y          | Department by Period                | DepPer           |                 |       | Breakdown by DeptId and Period                        |
|            | GL     | Y            | Y          | Department by Account               | DepAct           |                 |       | Breakdown by DeptId and Account                       |
|            | GL     | Y            | Y          | Department by Product               | DepPrd           |                 |       | Breakdown by DeptId and Product                       |
|            | GL     | Y            | Y          | Department by Business Unit         | DepBus           |                 |       | Breakdown by DeptId and Business Unit                 |
|            | GL     | Y            | Y          | .                                   |                  |                 |       |   |
|            | GL     | Y            | Y          | Product by Period                   | PrdPer           |                 |       | Breakdown by Product and Period                       |
|            | GL     | Y            | Y          | Product by Account                  | PrdAct           |                 |       | Breakdown by Product and Account                      |
|            | GL     | Y            | Y          | Product by Department               | PrdDep           |                 |       | Breakdown by Product and Department                   |
|            | GL     | Y            | Y          | Product by Business Unit            | PrdBus           |                 |       | Breakdown by Product and Business Unit                |
|            | GL     | Y            | Y          | .                                   |                  |                 |       |   |
|            | GL     | Y            | Y          | Business Unit by Actuals/Buc BusVar |                  |                 |       | Breakdown by Business Unit and Actual/Budget Variance |
|            | GL     | Y            | Y          | Accounts by Actuals/Budget: ActVar  |                  |                 |       | Breakdown by Account and Actual/Budget Variance       |
|            | GL     | Y            | Y          | Departments by Actuals/Bud: DepVar  |                  |                 |       | Breakdown by Department and Actual/Budget Variance    |
|            | GL     | Y            | Y          | Products by Actuals/Budgets: PrdVar |                  |                 |       | Breakdown by Product and Actual/Budget Variance       |
|            | GL     | Y            | Y          | .                                   |                  |                 |       |   |

**Note:** You can select a DrillDown layout, DrillDown query, or a macro to run when a menu command is selected.

| Field or Control        | Description  |
|-------------------------|--|
| <b>Application</b>      | Identifies the application that uses this menu item.<br><br>This identification makes it easier to enable or disable the actions associated with an application by setting its <b>Active</b> option. The <b>Application</b> field is not used by the supplied macros, but it acts as a description on this page. |
| <b>Active</b>           | Enter <i>Y</i> to make the menu item active or <i>N</i> to keep it in the table but deactivated.   |
| <b>Menu Command</b>     | Enter the text that appears when the user pulls down the menu.   |
| <b>DrillDown Layout</b> | Select a layout, present in your DrillDown layout path, to be used in a matrix or tabular DrillDown.   |
| <b>DrillDown Query</b>  | Enter a query name to be used in a PeopleSoft Query Link-style tabular DrillDown.  |

| <b>Field or Control</b> | <b>Description</b>   |
|-------------------------|--|
| <b>Macro</b>            | Enter the name of a macro to run when the item is selected.                            |
| <b>Description</b>      | Enter descriptive text to appear in the status bar when a user highlights the command. |

## Rebuilding the Menu

To rebuild the menu with new information that has been entered, click the **Rebuild Menu** button.

## Making Microsoft Excel Row and Column Indicators Visible

To make Microsoft Excel row and column indicators visible for both the PeopleSoft menu and toolbar sheets:

1. Open Microsoft Excel and select **Tools > Options** from the Excel menu.
2. On the View tab, select the **Row & column headers** option and click the OK button.  
Row indicators *1,2,3*, and so on. Column indicators *A,B,C*, and so on.
3. Insert or delete rows or columns by clicking a row or column indicator to highlight the row or column.
4. After you have made your changes to the PeopleSoft menu or toolbar sheet, hide the row and column indicators by clearing the **Row & column headers** option before you save the modified NVSUSER.XLS.

## Changing the Toolbar

To personalize the toolbar in PS/nVision:

1. Access PS/nVision and select the Toolbar tab on the nVision home page NVSUSER.xls.
2. Optionally, edit the name of the toolbar in the Toolbar Name box.
3. Set the location of the toolbar in the Docking Position box.  
You can enter left, right, top, or bottom to have the toolbar docked accordingly; or you can select *Float* to have the toolbar float over the spreadsheet.
4. Edit the table of tool commands, adding, changing, and deleting items to get the toolbar you want.
5. For each tool you add or change, specify one of the following actions:
  - A layout, present in your DrillDown layout path, to be used in a matrix or tabular DrillDown.
  - A query name to be used in a PeopleSoft Query Link-style tabular DrillDown.
  - The name of a macro to run when the tool button is clicked.
6. For each tool, specify the following:

- Active: Select *Y* to make the tool active; select *N* to keep it in the table but not in the toolbar.
  - Face: The name of the picture that identifies the tool. Either use a picture already defined in the Toolbar worksheet or design your own using a drawing program such as Paintbrush. The picture must be 16 pixels square. Copy the picture from the drawing program and paste it into the Toolbar worksheet. While it is selected, enter a name for it, and enter this name in the Face column.
  - Gap: To leave a gap between tools, enter *gap* in the Face column.
  - Status text: Enter descriptive text to appear in the status bar when the mouse rests over the tool.
  - Tip text: Enter a brief description to appear in a tool tip when the mouse rests over the tool.
7. When the table is as you want it, click Rebuild Toolbar to build the new toolbar.

---

## Setting Report Preferences

NVSUSER enables you to store personalized, categorized report requests. You can quickly view frequently used requests by category and run them with a click of a button. One NVSUSER can be stored on a remote server location and still enable individual users to view requests from any client workstation. In addition, you can view and copy other users' Report Request preferences if given the proper security access to alleviate the redundancy setup process.

This section describes how to:

- Set report request preferences.
- Copy a user's report request preferences.
- Customize the report instance view.

## Setting Report Request Preferences

Use the Personal Report Settings dialog box to set report request preferences in PS/nVision.

This example illustrates the fields and controls on the Personal Report Settings dialog box.

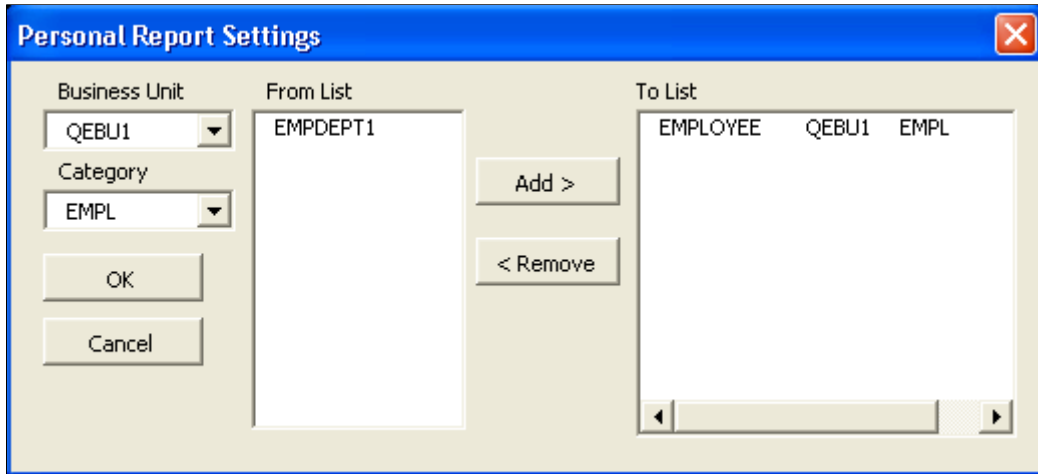

To set report request preferences in PS/nVision:

1. Open PS/nVision and click the Report Preferences menu button on the NVSUSER.xls home page.  
The Personal Report Settings dialog box appears.
2. Select an appropriate business unit.
3. Optionally, enter a new category or select an existing one.
4. Select the reports you want for that category, and click the **Add** or the **Remove** button.
5. Click the **OK** button.

The information is stored in the NVSReports tab of NVSUSER.xls.

## Copying a User's Report Request Preferences

To view or copy another user's report request preferences in PS/nVision:

1. Open PS/nVision, and click the **Operator** button on the NVSUSER.xls home page.  
A dialog box appears with a drop-down list of all users who have already set and stored report request preferences on this NVSUSER.xls.
2. Select a user from the list to access that user's report references and personalized categories.
3. Click the **Copy** button to copy the other user's preferences.
4. Click the **Report Preferences** button to see your report settings.

---

**Note:** When you copy another user's preferences, your previous preferences are deleted. You cannot change another user's report request preferences without copying them first.

---

## Customizing the Report Instance View

From the NVSUSER home page, you can pull in report instances from folders that you specify. You can then select reports from the list and open them without having to navigate through a file directory system. For example, if a series of report books were being run overnight and placed into a common file location, a manager could log in to the NVSUSER home page and all the reports would be pulled from the specified directories.

This is an example of the View Reports group box from the NVSUSER.xls home page.

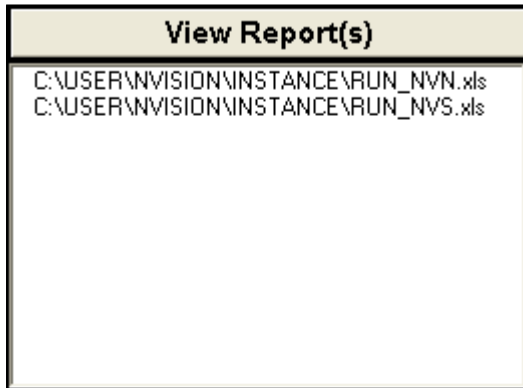

To personalize the report instance view in the Configuration Manager:

1. Select **Start > Programs > PeopleTools 8.x > Configuration Manager**.
2. Select the Profile tab from the Configuration Manager dialog box.
3. Select the profile to change and click the **Edit** button.
4. Select the nVision tab in the Edit Profile dialog box.
5. Enter or navigate to the location of your report instance files.

You can have more than one folder listed, but they must be separated by semicolons. However, Microsoft Excel has a limit of 255 characters.

---

## Customizing Delivered Visual Basic Application Wizards

NVSUSER delivers Visual Basic Application (VBA) forms to perform functions ranging from storing information in the PeopleSoft system to creating a button to run a report. To find the VBA forms in PS/nVision, open an report layout and select **Tools > Macros > Visual Basic Editor** from the Excel menu bar.

The VBA forms provide several examples of using Visual Basic PeopleSoft APIs to personalize PS/nVision. These features can add depth to your reporting ability.

Several VBA wizards take advantage of the PeopleSoft Open Query method to pull information from the PeopleSoft system. To use this method, you need to create a query in the PeopleSoft system.

VBA forms also pass prompt values to the queries. The following table lists the queries that PS/nVision accesses and the wizards that use the listed queries.

| <b>Query</b>      | <b>VBA Wizard</b>                |
|-------------------|----------------------------------|
| NVS_OPERATORS     | NVSUSER.xls                      |
| NVS_PERSNL_RPTS   | NVSUSER.xls, Personal_Settings   |
| NVS_CATEGORY      | NVSUSER.xls, Personal_Settings   |
| NVS_RPT_ID        | Personal_Settings, Button Wizard |
| NVS_MENU          | PSDrill                          |
| NVS_MENU_BAR      | PSDrill                          |
| NVS_MENU_ITEM     | PSDrill                          |
| NVS_MENU_PANEL    | PSDrill                          |
| NVS_MENU_PNL_KEYS | PSDrill                          |

## Related Links

[Using Designer Object Methods](#)

[Designer Object Methods](#)

[Using Session Object Methods](#)

[Session Object Methods](#)

[Instance Hooks](#)

---

## Changing the Startup File

When you start PS/nVision, it opens NVSUSER.XLS by default. If it cannot locate NVSUSER.XLS, it looks for the NVSUSER.XLM file.

If you start PS/nVision from a Microsoft Windows shortcut, you can specify a different startup file in the PS/nVision command line. Include the *-SF* argument followed by the name of the startup file. For example, to have PS/nVision open the file NVSDEV.XLS, enter a command similar to the following in the **Target** edit box in the Properties dialog box for the shortcut:

```
c:\pt800\bin\client\winx86\psnvs.exe -SFNVSDEV.XLS
```

This feature enables you to provide different startup files for different classes of users.

---

**Note:** PS/nVision searches for the startup file in the same directories where it looks for its default startup file.

---

## Related Links

[Using Configuration Manager](#)

---

## Using PS/nVision API Functions

PS/nVision has an API function interface. The Excel macros that you write can use these functions to gain access to PS/nVision features.

**Note:** In Microsoft Excel, there are two macro programming languages: Microsoft Visual Basic for Applications (VBA) and the Microsoft Excel 4.0 macro language. VBA is recommended over Excel 4.0 macros because VBA is more flexible and more powerful than the Excel 4.0 macros. In addition, Visual Basic may be the only programming language offered in future versions of Microsoft Excel. The following API functions can only be invoked from Microsoft Excel 4.0 macros.

To use nVision functions from VBA, see [Using Designer Object Methods](#), [Designer Object Methods](#), [Using Session Object Methods](#), [Session Object Methods](#), [Instance Hooks](#).

The following table lists and describes the API functions, which may not be run within a macro called via NvsInstanceHook.

| <b>Interface Function</b> | <b>Purpose</b>  | <b>Arguments</b> | <b>Example</b>                |
|---------------------------|---|------------------|-------------------------------|
| NvsAutoDrill              | Performs an AutoDrill, similar to selecting the AutoDrill menu item. AutoDrill is only usable in reports based on queries, and in ledger-based reports for which the NvsDefaultDrill name is defined in the layout, specifying the name of the layout to run as an AutoDrill. | None             | =NvsAutoDrill()               |
| NvsDrillDown              | Start a matrix DrillDown. Similar to using the DrillDown item on the nVision menu. The user selects a DrillDown layout from the Open dialog box.  | None             | =NvsDrillDown()               |
| NvsDrillLayout            | Run a matrix DrillDown using a specified layout.  | Layout name      | =NvsDrillLayout("ACTPER.XNV") |
| NvsDrillQuery             | Run a tabular DrillDown using a specified query.  | Query name       | =NvsDrillQuery("Journals")    |
| NvsJumpBack               | Return to the sheet and cell from which the current sheet drilled down (same as the Jump Back command).   | None             | =NvsJumpBack()                |

| <b>Interface Function</b> | <b>Purpose</b>   | <b>Arguments</b>             | <b>Example</b>                           |
|---------------------------|--|------------------------------|--|
| NvsLayoutDefn             | Show the PeopleSoft nVision Layout Definition dialog box for the selected row, column, or cell. This is the equivalent of the <b>nVision &gt; Layout Definition</b> menu item.   | None                         | =NvsLayoutDefn()                         |
| NvsNewLayout              | Create a new layout. Similar to using the <b>nVision &gt; New Layout</b> menu item.  | None                         | =NvsNewLayout()                          |
| NvsOnWindow               | Activate PS/nVision menus for the current window. This activation is required when your macro opens a sheet, since Microsoft Excel does not signal PS/nVision that the new sheet has been activated.   | None                         | =NvsOnWindow()                           |
| NvsOpenFile               | Open a Microsoft Excel worksheet, waiting if necessary in case another user on the network is accessing the file. If the file opens successfully, call NvsOnWindow to update menus. Optional arguments say whether to update links to other documents and if file is to be opened read-only. | filespec, uplinks, read-only | =NvsOpenFile ("FSDEMO.XLS", TRUE, FALSE) |
| NvsOpenLayout             | Open a layout. Similar to using the <b>nVision &gt; Open Layout</b> menu item.   | None                         | =NvsOpenLayout()                         |
| NvsOpenReport             | Open a report request. Similar to clicking the <b>Open</b> button in the PeopleSoft nVision Report Request dialog box.   | None                         | =NvsOpenReport()                         |
| NvsOpenScope              | Open an existing scope definition. Similar to clicking the <b>Open</b> button in the PeopleSoft nVision Scope Definition dialog box.   | None                         | =NvsOpenScope()                          |
| NvsReDrill                | Repeat the most recent DrillDown from the currently selected amount cell.  | None                         | =NvsReDrill()                            |

| <b>Interface Function</b> | <b>Purpose</b>   | <b>Arguments</b>         | <b>Example</b>                    |
|---------------------------|--|--------------------------|-----------------------------------|
| NvsReport Request         | Display the PeopleSoft nVision Report Request dialog box. This activation is similar, to the <b>nVision &gt; Report Request</b> menu item.   | None                     | =NvsReportRequest()               |
| NvsRunCurrent             | Runs the current report. This activation is similar to the <b>nVision &gt; Run Current Report</b> menu item.   | None                     | =NvsRunCurrent()                  |
| NvsRunQuery               | Run a specified query, without inheriting DrillDown criteria.  | Query name               | =NvsRunQuery ("AP Journals")      |
| NvsRunReport              | When used without a parameter, prompts the user to select a report to run, and then runs the selected report. With a parameter, runs a specified matrix report, without showing the report key dialog or Report Request. | Business Unit, Report ID | =NvsRunReport() ("M04", "ISDEMO") |
| NvsSaveAsLayout           | Prompt user to save the layout with a new name. This activation is similar to using the <b>nVision &gt; Save As Layout</b> menu item.  | None                     | =NvsSaveAsLayout()                |
| NvsScopeDefn              | Open the PeopleSoft nVision Scope Definition dialog box. This activation is similar to using the <b>nVision &gt; Scope Definition</b> menu item.   | None                     | =NvsScopeDefn()                   |

This table lists the nVision command line parameters and their corresponding fields in the Define Report Request page.

| <b>Parameter</b> | <b>Corresponding Field</b> |
|------------------|----------------------------|
| NRN              | Report ID                  |
| NBU              | Business Unit              |
| NLN              | Layout                     |
| NRT              | Report Title               |

| <b>Parameter</b> | <b>Corresponding Field</b>   |
|------------------|--|
| NSN              | Report Scope   |
| NDT              | Directory Template   |
| NFT              | File Template  |
| NLT              | Language   |
| NET              | Email Template   |
| NDET             | Content Description Template   |
| NAT              | Security Template  |
| NPF              | Folder Name  |
| NTM              | Time-out Minutes   |
| NRET             | Retention Days   |
| NRB              | Data From Requesting B.U. Only   |
| NEN              | Enable nPlosion If Specified In Layout   |
| NTL              | Translate Summary Ledgers to Detail  |
| NADO             | As Of Reporting Date   |
| NTDO             | Tree As Of Date  |
| NASD             | As of Reporting Date (for specify option)  |
| NTED             | Tree As Of Date (for specify option)   |
| NHL              | <b>Note:</b> This parameter is the generated hyper link.   |
| NDL              | <b>Note:</b> This parameter indicates whether the output options are overridden on the Process Scheduler Request page. |

This example shows the nVision command line parameters used in the Define Report Request page:

```
PSNVS.EXE -CTORACLE -CDT853IB02 -COPASSWORD -CP%OPRPSWD% -R" " -I10502 -OT6 -OF8 -O⇒  
PDistribution List -NRNFSDETAIL -NBUUS001 -NHLhttp://qt-ibm12.us.oracle.com:17320/p⇒  
sp/t853ib02x_newwin/EMPLOYEE/QE_IBTGT/c/REPORT_BOOKS.IC_RUN_DRILLDOWN.GBL?Action=A ⇒  
-NDL0 -NLN"FSDETAIL" -NRT"Detailed Financial Statement" -NSNDEPTID -NRBY -NENY -NTL⇒  
Y -NADOU -NASD1999-12-31 -NTDOR -NTED -NDT"C:\TEMP" -NFT"%RID%.XLS" -NLTDUT -NETnvs⇒  
@example.com -NDET"%RTT%" -NATU:PASSWORD -NPFGENERAL -NOT6 -NOF8 -NTM10 -NRET2
```



## Chapter 13

# Using the PS/nVision Visual Basic Interface

---

## Using Designer Object Methods

---

**Note:** You can develop powerful Visual Basic applications (VBA) with the PS/nVision Visual Basic programming interface. The objects and related methods referenced in this section provide the ability to call PS/nVision features programmatically for common reporting and analysis tasks. Object methods are listed in order based on their functionality.

---

Creates an instance of PS/nVision as in the following example:

```
Dim objnVision As Object
Dim objDesignerCmd As Object
Dim strAppName As String
strAppName = "PSnvision.nvsdesigner"
Set objnVision = CreateObject(strAppName)
Set objDesignerCmd = objnVision.DesignerCmd
```

After you finish with the Designer object, clear the PS/nVision object by setting it equal to nothing, as in the following example:

```
Set objnVision = Nothing
```

---

## Designer Object Methods

The following shows details of designer object methods.

### Connect

#### Syntax

```
Connect([in, optional] BSTR startMacro)
```

#### Description

This method enables the user to sign on to the PeopleTools application.

#### Example

```
` Straight Connection
objDesignerCmd.Connect
` Connection and run macro
objDesignerCmd.Connect("MacroName")
```

## Disconnect

### Description

This method enables the user to sign off from the PeopleTools application.

### Example

```
objDesignerCmd.Disconnect
```

## ResetEnvironment

### Description

This method resets the working directory and other environment settings needed for PS/nVision to process reports.

### Example

```
objDesignerCmd.ResetEnvironment
```

## StartMenu

### Description

This method causes the designer to register its menu within the grid.

### Example

```
objDesignerCmd.StartMenu
```

## OnWindow

### Description

This method refreshes the designer window, including PS/nVision menus.

### Example

```
objDesignerCmd.OnWindow
```

## OpenFile

### Syntax

```
OpenFile([in] BSTR filename, [in, optional] BOOL updatelinks, [in, optional] BOOL ⇒  
readonly)
```

## Description

This method opens a new or existing PS/nVision report layout.

## Parameters

There are three arguments associated with this method: the file name (with full path) and two optional arguments: update links and read-only.

## Example

```
ObjDesignerCmd.OpenFile("c:\user\BALANCE.xls", TRUE, FALSE)
```

## OpenLayout

### Description

This method opens an existing layout.

### Example

```
objDesignerCmd.OpenLayout
```

## NewLayout

### Description

This method creates a new layout.

### Example

```
objDesignerCmd.NewLayout
```

## SaveAsLayout

### Description

This method saves the worksheet as a layout.

### Example

```
objDesignerCmd.SaveAsLayout
```

## DefineLayout

### Description

This method invokes the PeopleSoft nVision Layout Definition dialog box.

### Example

```
objDesignerCmd.DefineLayout
```

## LayoutOptions

### Description

This method invokes the PeopleSoft nVision Layout Options dialog box.

### Example

```
objDesignerCmd.LayoutOptions
```

## ReportRequest

### Description

This method opens an existing report request.

### Example

```
objDesignerCmd.ReportRequest
```

## RunCurrent

### Description

This method runs a defined or previously opened report request.

### Example

```
objDesignerCmd.RunCurrent
```

## RunReport

### Syntax

```
RunReport([in] BSTR BusUnit, [in] BSTR RptRqst)
```

### Description

This method runs a specific report.

### Parameters

There are two arguments required for this request: business unit and report request name. The report request must be in uppercase letters.

### Example

```
objDesignerCmd.RunReport("M04", "BALANCE")
```

## Options

### Description

This method to opens the PeopleSoft nVision Options dialog box.

### Example

```
objDesignerCmd.Options
```

## PerfOpts

### Description

This method is same as LayoutOptions with just one selection.

### Example

```
objDesignerCmd.PerfOpts
```

## OpenScope

### Description

This method displays the PeopleSoft nVision Open Scope dialog box and then the PeopleSoft nVision Scope Definition dialog box, assuming the user selects a scope.

### Example

```
objDesignerCmd.OpenScope
```

## ScopeDefn

### Description

This method invokes the PeopleSoft nVision Scope Definition dialog box.

### Example

```
objDesignerCmd.ScopeDefn
```

## DrillDown

### Description

This method initiates DrillDown sequence.

### Example

```
objDesignerCmd.DrillDown
```

## DrillLayout

### Description

This method performs a DrillDown using the specified child layout.

### Example

```
objDesignerCmd.DrillLayout
```

## AutoDrill

### Description

If a default DrillDown layout is defined (as DefaultDrill) in the active instance, drills down using that layout.

For ledger reports, the default drill string may include a *D*, which indicates that any summary ledgers should be translated to detail. If no default layout is defined, for a query-based instance, drill down to that query in DrillQuery (QueryLink) mode. For a ledger-based instance, have the user select the DrillDown layout, as in DrillDown.

### Example

```
objDesignerCmd.AutoDrill
```

## ReDrill

### Description

This method drills the selected cell using the most recently selected DrillDown layout.

### Example

```
objDesignerCmd.ReDrill
```

## DrillQuery

### Description

This method performs a DrillDown using the specified query.

### Example

```
objDesignerCmd.DrillQuery
```

## JumpBack

### Description

This method implements commands to activate the parent instance of the current child DrillDown.

### Example

```
objDesignerCmd.JumpBack
```

## RunQuery

### Description

This method runs the specified query with no inherited criteria, and is not used for DrillDown.

### Example

```
objDesignerCmd.RunQuery
```

---

## Using Session Object Methods

This object retrieves information about the current session.

The following is an example.

```
Dim objnVision As Object
Dim objSessionCmd As Object
Dim strAppName As String
Dim strDatabaseType As String
strAppName = "PSnvision.nvsdesigner"
Set objnVision = CreateObject(strAppName)
Set SessionCmd = objnVision.SessionCmd
```

After finishing with the session object, clear the PS/nVision object by setting it equal to nothing, as in the following example:

```
Set objnVision = Nothing
```

---

## Session Object Methods

The following shows details of the session object methods.

### DBType

#### Description

This property retrieves database types for the current session.

#### Example

```
strDatabaseType = SessionCmd.DBType
```

### DBName

#### Description

This property retrieves the database's name for the current session.

#### Example

```
strDatabaseName = SessionCmd.DBName
```

### ToolsRelDB

#### Description

This property retrieves the tool release database version for the current session.

#### Example

```
strToolReleaseDatabase = SessionCmd.ToolsRelDB
```

### ServerName

#### Description

This property retrieves the server's name for the current session. It retrieves nothing if the user is logged on in two-tier.

#### Example

```
strServerName = SessionCmd.ServerName
```

## OprId

### Description

This property retrieves the user's ID for the current session.

### Example

```
strOperatorId = SessionCmd.OprId
```

## TwoTier

### Description

This property identifies whether the current session is two-tier. If the return value is TRUE (or a value of 1), the current session is two-tier.

### Example

```
bTwoTier = SessionCmd.TwoTier
```

## ShowWarnings

### Description

This property retrieves or sets a *ShowWarnings* option for the current session.

### Example

Retrieve Example:

```
Dim bShowWarnings As Boolean  
bShowWarnings = SessionCmd.ShowWarnings
```

Set Example:

```
Dim bShowWarnings as Boolean  
bShowWarnings = True  
SessionCmd.ShowWarnings = bShowWarnings
```

## AmountSql

### Description

The AmountSql property retrieves or sets an Amount SQL option for the current session.

## Example

Retrieve Example:

```
Dim bAmountSql As Boolean  
bAmountSql = SessionCmd.AmountSql
```

Set Example:

```
Dim bAmountSql as Boolean  
bAmountSql = True  
SessionCmd.AmountSql = bAmountSql
```

## ReadConfig

### Syntax

```
ReadConfig([in] BSTR ConfigDir)
```

### Description

This method retrieves the directory paths of a given PS/nVision Configuration Manager setting (as defined in the Windows Registry). If the user has multiple directory paths in the same configuration setting, it retrieves them all. The available configuration settings that can be retrieved are:

- InstanceDir
- LayoutDir
- TemplateDir
- MacroDir
- StyleDir
- DrillDownDir

### Example

```
Dim strDirPath as String  
strDirPath = SessionCmd.ReadConfig("LayoutDir")
```

## ReadConfigDir

### Syntax

```
ReadConfigDir([in] BSTR ConfigDir, [in] WORD nPosition)
```

### Description

This method retrieves one directory path of a given PS/nVision Configuration Manager setting (as defined in the Windows Registry). This method differs from the ReadConfig method: it parses out the list of available directories by providing a number representing the position of the directory in the list.

For example, if you had two directories, such as `c:\user\nVision\layout` and `c:\user`, and you wanted just the `c:\user` directory, you would pass in the number two. If the user is looking for the second directory and there is only one, then nothing is retrieved. The list of available configuration settings that can be retrieved is as follows:

- InstanceDir
- LayoutDir
- TemplateDir
- MacroDir
- StyleDir
- DrillDownDir

### Example

```
Dim strDirPath as String
strDirPath = SessionCmd.ReadConfig("LayoutDir", 2)
```

This retrieves the second directory listed.

---

## Instance Hooks

Beginning with Excel 97, Microsoft began using Visual Basic as the programming language to write macros. In earlier versions of Excel, you had to create a macro sheet to use the `NvsInstanceHook`. Now, whether recording your macro or writing Visual Basic code within the Visual Basic Editor, you can invoke the PS/nVision Instance Hook directly from the module within a Visual Basic project without having to create a macro sheet.

Instance hooks enable user-written macros to be executed by PS/nVision after delivering the data to a report instance but before saving the instance. Instance hooks are supported for both matrix and tabular layout sheets. With an instance hook, you can:

- Refresh a pivot table based on data delivered in the instance.
- Change the delivered outline level.

For example, compress reports so the user starts with the top level.

- Apply subtotals or AutoFilter to data delivered in a tabular instance.
- Do high-level zero-suppression or resort data.
- In general, use Excel features that can't be applied in the layout because they require data.

Within an Instance Hook macro, you can call any other Visual Basic methods or functions. But you should avoid calling PS/nVision functions and closing Excel.

To use instance hooks, identify the layout sheets in the layout workbook (.XNV file) to which you want to apply post-delivery processing. For each sheet, define the name `NvsInstanceHook` to refer to the name of the first cell of an Excel 4 macro sheet or the name of a Visual Basic procedure.

The defined name *NvsInstanceHook* is sheet-specific. You need to either define the same name on multiple sheets or, the preferred method, enter the sheet name and an exclamation point (!) with the name when defining it. By doing this you can fire different macros for different layout sheets in the same workbook. The resulting name looks like *Sheet1!NvsInstanceHook*.

To record a macro from within Microsoft Excel, select **Tools > Macro > Record a Macro**.

To write a macro from within Microsoft Excel, select **Tools > Macro > Visual Basic Editor**.

This example shows a module that combines a recorded macro with additional code that has been added through the editor.

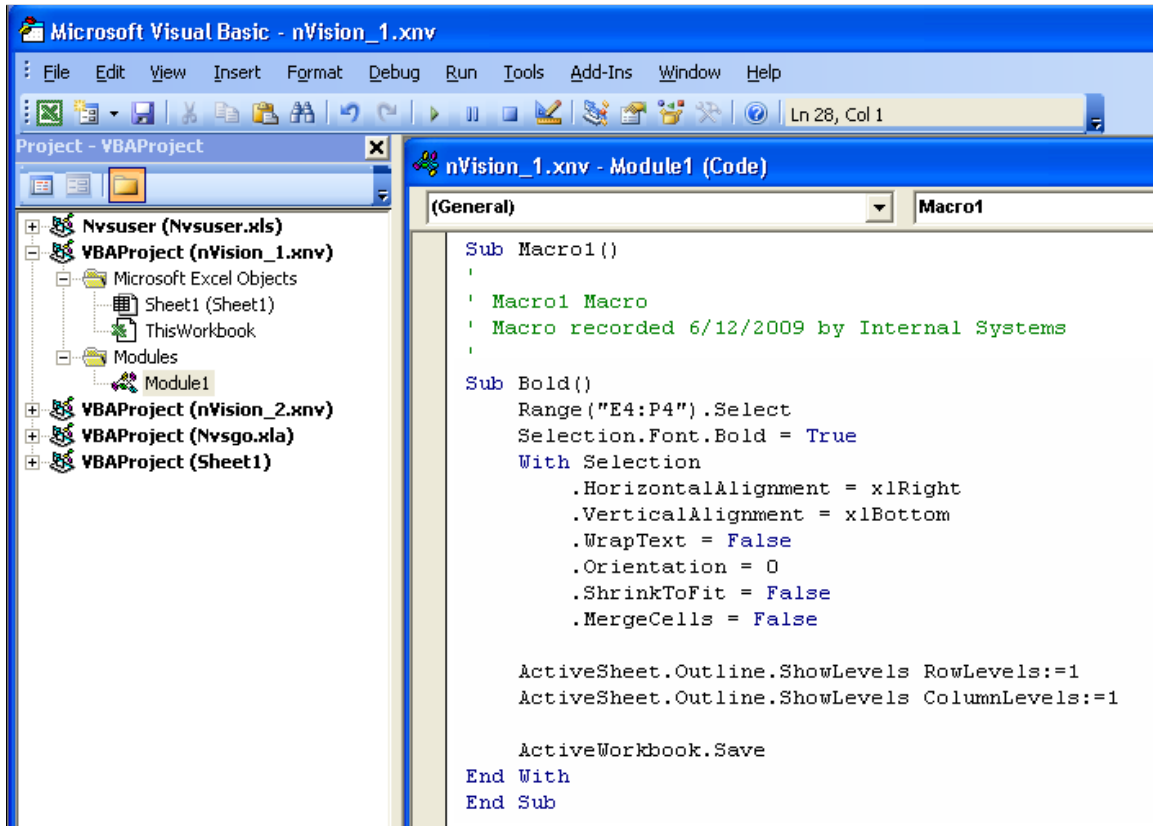

The macro applies bold and right-aligns the nPloded TimeSpan columns, collapses the outline of the nPloded rows and columns, and saves the instance.

After creating the macro module, return to your PS/nVision layout and attach it using *NvsInstanceHook*.

To attach a macro using *NvsInstanceHook* in PS/nVision:

1. Select the cell in the layout in PS/nVision.
2. Select **Insert > Name > Define** from the toolbar.

For the name, enter the sheet name followed by an exclamation point and the text *NvsInstanceHook*. For example, *Sheet 1!NvsInstanceHook*.

3. Enter the name of the macro in the *Refers to* field.

For the name, enter the name of Excel Visual Basic Module, where the macro is located, followed by a period and the name of the Excel VB Macro. For example, *Module1.MacroName*.

4. Click the **Add** button.
5. Click the **OK** button.

Your macro is executed after the PS/nVision Instance is created.



## Chapter 14

# Setting Up PS/nVision Security

---

## Securing PS/nVision Elements

This section describes how to:

- Secure PS/nVision menu items.
- Secure report layouts.
- Secure and share report requests in PIA.
- Secure and share report request in Windows client.

## Securing PS/nVision Menu Items

Use the Page Permissions page (ACL\_PAGES2) in PeopleSoft Security to specify the page permissions that control the operations users can perform in PS/nVision. Authorizations specified at the Page Permissions page are applied to both the Windows client and the PeopleSoft Pure Internet Architecture (PIA).

Navigation:

**PeopleTools > Security > Permissions and Roles > Permission Lists > Pages**

This example illustrates the fields and controls on the Page Permissions page.

**Page Permissions**

NVISION / nVision / Define Layout

| Panel Item Name | Authorized?                         | Display Only             |
|-----------------|-------------------------------------|--------------------------|
| Define Layout   | <input checked="" type="checkbox"/> | <input type="checkbox"/> |

**Actions**

Add

Update/Display

Update/Display All

Correction

Select All

Deselect All

OK Cancel

To set component permissions in PIA:

1. Select **PeopleTools > Security > Permissions and Roles > Permission Lists**.
2. Select the required nVision Permission list.
3. Select the Pages tab.
4. Click the **Edit component** link, corresponding to the required menu, to display the Component Permissions page.
5. Click the **Edit Pages** button for a component to display the Page Permissions page.
6. Change the settings to authorize the action or leave the settings as display-only.

When selecting page permissions, you must select both an action and the **Authorized** option. For example, when you allow a user to run report requests, you must select the **Update/Display** button and the **Authorized** option adjacent to the RUN\_REPORT page name on the Page Permissions page.

7. Click the **OK** button.

---

**Important!** If no items are authorized, you cannot run PS/nVision at all.

---

nVision is controlled through individual components associated with the REPORT\_BOOKS and NVISION menus.

The following table lists the available PS/nVision page permissions and describes the actions they control.

| <b>Page Permission</b> | <b>Action Controlled</b>   |
|------------------------|--|
| DEFINE_LAYOUT          | Allows the user to use the Open Layout, Layout Definition, and similar menus in Excel.   |
| OPEN_REPORT            | Enables the <b>Open</b> button in the PeopleSoft nVision Report Request dialog box on the Windows client.  |
| EDIT_REPORT            | Allows the user to modify values in the PeopleSoft nVision Report Request dialog box.<br><br><b>Note:</b> The EDIT_REPORT setting does not control access to report layout (Excel XNV) files. To restrict users from accessing XNV files entirely, use the Network Security settings.  |
| RUN_REPORT             | Allows the user to run report requests using the <b>Run</b> button in the PeopleSoft nVision Report Request dialog box, the Run Current Request menu item in the Windows client, and the <b>Run</b> button in the web report request.  |
| SAVE_REPORT            | Enables the <b>Save</b> button in the PeopleSoft nVision Report Request dialog box on both the Windows client and the web.<br><br><b>Note:</b> When you make changes to a report request, it is automatically saved when you run the request. To save a report request without running it, click the <b>Save</b> button. You cannot change a report request without saving it. |
| DELETE_REPORT          | Enables the <b>Delete</b> button in the PeopleSoft nVision Report Request dialog box on both the Windows client and the web.   |
| OPEN_SCOPE             | Enables the <b>Open</b> button in the PeopleSoft nVision Scope Definition dialog box on the Windows client.  |
| EDIT_SCOPE             | Allows the use to modify values in the PeopleSoft nVision Scope Definition dialog box on the Windows client.   |
| SAVE_SCOPE             | Enables the <b>Save</b> button in the PeopleSoft nVision Scope Definition dialog box on the Windows client.  |
| DELETE_SCOPE           | Enables the <b>Delete</b> button in the PeopleSoft nVision Scope Definition dialog box on the Windows client.  |
| PERFORMANCE_OPTS       | Enables the nVision Performance menu item, by which you access the Tree Performance Options dialog box.  |

## Related Links

“Understanding Permission Lists” (Security Administration)

“Managing Permission Lists” (Security Administration)

“Defining Permissions” (Security Administration)

## Securing Report Layouts

Report layouts (XNV files) are stored on a file server and not in the PeopleSoft database. Set up network security so that only appropriate users are able to modify or delete report layout (XNV) files in the report layout directories of the network.

With web-based PS/nVision reporting, reports launched from the browser are run through PeopleSoft Process Scheduler and executed on a report server. The file server that stores the layouts is associated with the report server.

A report server is a Windows NT machine with PS/nVision (PeopleTools client software), Microsoft Excel, and PeopleSoft Process Scheduler installed. Process Scheduler selects the layout from the PS/nVision layout directory path defined in the Process Scheduler configuration. If you restrict access to this directory on the report server, unauthorized users cannot modify shared report layouts. Additionally, access to the PS/nVision directories on the Process Scheduler report server should be restricted.

If the report is run using the Windows client, a user authorized to define layouts can point to the PS/nVision layout directory (as defined in Configuration Manager) on the local drive and then modify and save the layout.

If a user has a PS/nVision user profile defined in PeopleSoft Security where only RUN\_REPORT is selected, and all other settings (for example, EDIT\_REPORT, SAVE\_REPORT) are cleared, the user cannot create a new report request, because the **Save** button is disabled.

---

**Note:** When the report request is run, access to ledger or record data itself is still controlled by the row-level security defined for that user.

---

### Related Links

“PeopleSoft Process Scheduler” (Process Scheduler)

## Securing and Sharing Report Requests in PIA

You can either share and secure nVision reports in PIA or in Windows client.

In web-based PS/nVision reporting, the procedures and processes used to run a report are performed using the different pages of the Report Book menu. Those actions include defining and running report requests, defining and running report books, defining scopes, and running DrillDowns. You can control access to these menu items and customize the pages to allow users restricted access to certain report requests.

---

**Note:** For the **Scope and Delivery Templates** link on the nVision Report Request page (NVS\_REPORT\_RQST), the system automatically displays an nVision output option page based on the output type. Security permissions for these secondary pages are inherited from the parent Report Request page, and the **Display Only** option set in the nVision Report Request component for these pages is ignored.

---

By default, only the creator of a report request has full access to that request. The creator can select to share the report request with other users or to change the access mode using the **Share This Report Request** link on the nVision Report Request page.

You can select **Reporting Tools > PS/nVision > PS/nVision Schedule Requests** to access the nVision Report Request page. In this page, click the **Share This Report Request** link to display the nVision Share Report Request page, where report request creators can view or change the access mode.

---

**Note:** You can share and secure nVision reports either in PIA or in Windows client.

---

This example illustrates the fields and controls on the nVision Share Report Request page. Definitions for the fields and controls appear following the example.

**nVision Share Report Request**

**Business Unit:** QEBU1 **Report ID:** EMPLOYEE

**Last Update User ID:** **Last Update Date/Time:**

---

**Access Mode**

Public  Secured

**Report Request shared with:** Customize | Find | View All | [Print] | [Grid] | First [Left Arrow] 1 of 1 [Right Arrow] Last

| ID | ID Type | *Distribution ID |          |         |
|----|---------|------------------|----------|---------|
| 1  | User    | QEDMO            | [Search] | [+] [-] |

OK Cancel

| <b>Field or Control</b> | <b>Description</b>  |
|-------------------------|---|
| <b>Access Mode</b>      | <p>Specifies the access availability for the report request. Select the <b>Public</b> option for all users to view or modify the request. Select the <b>Secured</b> option to specify which users have full access to the report.</p> <p>By default, users have the right to share report requests and access the Security Report Request page. You can change the default value using the <b>Use Secure Rep Rqst in nVision</b> (Use Secure Report Request in nVision) option on the PeopleTools Options page to restrict the users with this right.</p> <p>See “PeopleTools Options” (System and Server Administration).</p> <hr/> <p><b>Note:</b> If you change the access mode from secured to public, all the users and groups who had access to the report will be removed. If you then change the access mode back to secured, you will need to reassign the users and groups.</p> <hr/> |
| <b>ID Type</b>          | Select the <b>User</b> option to add a user, or the <b>Role</b> option to add a user role.  |
| <b>Distribution ID</b>  | Enter a valid user or role name, or select one from the list. You can add more users by clicking the + sign. If you selected <b>User</b> from the <b>ID Type</b> list, valid users appear; if you selected the <b>Role</b> option in the <b>ID Type</b> field, user roles appear.   |

Since report requests are keyed by business unit, the business unit validation is done for each shared user or role when a report request is opened. If a user or role does not have access to a business unit, that user does not have access to the report request even if she or he is given access through the Access Mode page.

**Note:** If a report book contains a report request to which a user does not have access, that user will not be able to view that report request. A message appears when the user opens the report book.

In Windows-client PS/nVision reporting, you can use the PS/nVision VBA interface to programmatically create a customized report request that will restrict users to certain parameters and functions of the report requests.

## Administering Report Requests

Use the nVision Report Request Admin page to administer your report requests, including:

- Removing a request.
- Transferring a request from one user to another.
- Making a request public.

Navigation:

**PeopleTools > Utilities > Administration > nVision Report Request Admin**

This example illustrates the fields and controls on the nVision Report Request Admin page. Definitions for the fields and controls appear following the example.

| nVision Report Request Admin                           |   |
|--|---|
| Source User ID: <input type="text"/>                   | <input type="button" value="Move Report Request"/>        |
| Target User ID: <input type="text"/>                   | <input type="button" value="Transfer Report Request"/>    |
| No.Of records affected: <input type="text" value="0"/> | <input type="button" value="Make Report Request Public"/> |

| <i>Field or Control</i>           | <i>Description</i>   |
|-----------------------------------|--|
| <b>Source User ID</b>             | The user whose report requests will be administered.   |
| <b>Target User ID</b>             | The user ID to which the selected report requests will be transferred if the <b>Transfer Report Request</b> button is clicked.   |
| <b>No. of Records Affected</b>    | The number of records that will be affected (moved, transferred, or made public) by the selected operation.  |
| <b>Move Report Request</b>        | Click to remove the source user's report request.<br><br>If the report request is not shared by any other user, the report request will be deleted. If the report request has been shared by users other than the source user, only the source user will be removed. |
| <b>Transfer Report Request</b>    | Click to remove the source user from the report request and grant access to the target user.   |
| <b>Make Report Request Public</b> | Click to make all report requests owned by the source user available for any user to view and edit.  |

## Related Links

“Understanding Permission Lists” (Security Administration)

“Managing Permission Lists” (Security Administration)

“Defining Permissions” (Security Administration)

## Securing and Sharing Report Requests in Windows Clients

In Windows Client of PeopleSoft nVision, you have the flexibility of making report request either public or private. By default, all nVision report requests created in Windows clients are public.

All users who create and view reports must have the required privileges to use the Business Unit from which the reports are generated. If the report creators define the report as secured, other users can use the secured reports only if the report creators have transferred the reports to them. For example, if user A creates a report request and shares it with user B, then only user B will have access to that report request. However, in the same client session, if the Open PeopleSoft nVision Report Request dialog box or the PeopleSoft nVision Report Request dialog box still retains the shared report request information, user A will have a temporary access to the shared report request. When these dialog boxes are refreshed with other report requests information or the client session is closed, then user A will no longer have the access to the shared report request.

Report creators can use the nVision Share Report Request dialog box to change the access mode of reports from public to private, and vice versa.

This example illustrates the fields and controls on the nVision Share Report Request dialog box.

| ID Type | *Distribution ID |
|---------|------------------|
| User    | QEDMO            |
|         |                  |
|         |                  |
|         |                  |
|         |                  |
|         |                  |

### Securing Report Requests in PS/nVision Windows Clients

To secure report requests in PS/nVision Windows clients:

1. Select **nVision** > **Report Request** from the nVision toolbar.  
The PeopleSoft nVision Report Request dialog box appears.
2. Enter the required values for the new report request, and click the **Save** button.
3. Click the **Run** button to generate the report instance.

4. Select **nVision > Share Report Request** from the nVision menu.

The Share Report Request dialog box appears.

5. Accept the default settings of *Secured*.

6. Double-click the **ID Type** field.

A list of contain values for ID type appears.

7. Select an user to share this report instance with.

Alternatively, select a roles to share this report instance to users with certain roles.

8. After selecting ID type or role, double-click the Distribution ID field or the Distribution List field.

If the ID type cell is *User*, a list of users appears. If the ID type cell is *Roles*, a list of roles appears.

9. Optionally, repeat step 6 to 8 for adding other users and roles.

10. Click the **OK** button to make the report instance secured.

### Sharing Report Requests in PS/nVision Windows Clients

To share report requests in PS/nVision Windows clients:

1. Select **nVision > Report Request** from the nVision toolbar.

The PeopleSoft nVision Report Request dialog box appears.

2. Enter the required values for the new report request, and click the **Save** button.

3. Click the **Run** button to generate the report instance.

4. Select **nVision > Share Report Request** from the nVision menu.

The Share Report Request dialog box appears.

5. Select the **Public** option to make the report instance public.

A message appears for confirmation of this report instance to be available to all users.

6. Click the **OK** button to make the report instance public.

Alternatively, click the **Cancel** button to keep the report instance secured and viewed only by the shared users.

### Removing User or Role From the Secured Distribution List

To remove an user or a role from the secured distribution list:

1. Select **nVision > Report Request** from the nVision toolbar.

The PeopleSoft nVision Report Request dialog box appears.

2. Enter the required values for the new report request, and click the **Save** button.

3. Click the **Run** button to generate the report instance.

4. Select **nVision** > **Share Report Request** from the nVision menu.

The Share Report Request dialog box appears.

5. Select the required user to be removed, and click the **Delete** button.

Alternatively, select the required role to be removed, and click the **Delete** button.

6. Click the **OK** button to confirm that the selected user or role will be deleted.
7. Optionally, repeat step 5 and 6 for removing other users and roles.

## Setting Report Request Admin

Report creators can also use the PS/nVision Report Request Admin dialog box to transfer the private reports to other users for use.

To access the PS/nVision Report Request Admin dialog box:

1. Open nVision client by selecting **Start** > **Programs** > **PeopleSoft 8.x** > **nVision**.
2. Create a new nVision report, or open an existing one.
3. Select **nVision** > **Transfer Report** from the menu.

The PS/nVision Report Request Admin dialog box appears.

This example illustrates the fields and controls on the nVision Report Request Admin dialog box, which enables report creators to move reports from one user to another user.

| PS/nVision Report Request Admin |   |
|---------------------------------|---|
| Source User Id                  | <input type="text"/> <input type="button" value="Move Report Request"/>     |
| Target User ID                  | <input type="text"/> <input type="button" value="Transfer Report Request"/> |
| No of Records Effected.         | <input type="text"/> <input type="button" value="Make Report Public"/>      |

---

## Securing Reports

This section discusses about:

- Secure Report Distribution
- Masked Data in Reports

## Securing Report Distribution

You have different security considerations for distribution based on the type of output: file, email, or web.

When you output reports as files, remember that files are stored in the directories and files that you specified in the directory templates and file templates. These directories and files are on your file server and are not stored in the PeopleSoft database. You must set up network security to map the accessibility of the reports and ensure that unauthorized users do not have access to these reports on your file server.

When you output reports as email, you control who receives the reports using the email template in the report request. You can specify precise email addresses in the email template, or indirectly specify email addresses by user ID or role ID. If you specify your email recipients using role or user IDs, then the email addresses from those profiles are used.

When you output reports using the web, the reports are distributed through Report Manager. You control who receives the reports using security templates in the report requests. If nothing is entered in the security template, the default recipient is the user who runs the report.

You can associate a scope with the email template or the web security template using %DES% variables. You must specify who can modify the email template or the security template from the report request, and who can access the values of the %DES% variable in the table associated with the scope.

Additionally, when a report is distributed through email or web, it uses the report server to run the report and then distribute the output. In the report server, the directory templates and file templates from the report requests are used as temporary locations to store the intermediate files before the reports are transferred to the report repository or to the email system. Access to the file server that stores the intermediate reports should be secured through your network security. Set up PeopleSoft Process Scheduler as a Tuxedo Service so that PS/nVision reports can be run in the background and no data can be viewed during the report execution time.

## Masking of Data in Reports

PS/nVision reports that use query, connected query, or composite query as a data source may include data fields containing sensitive information, which should be masked with a masking character, for example, an asterisk (\*).

The data fields that are masked in the data source will appear as masked in the PS/nVision report.

If a PS/nVision layout query fails due to data masking, the PS/nVision report using this layout will fail and data permission error will be displayed in the message log.

This example illustrates an nVision report with masked values for the Number field because this field is masked in the query data source.

| Date       | Date Time       | Number |
|------------|-----------------|--------|
| 2/17/1978  | 2/14/1993 19:11 | *****  |
| 2/17/1978  | 2/14/1993 19:11 | *****  |
| 11/11/1987 | 2/14/1993 13:10 | *****  |

---

**Note:** Data masking is not implemented for matrix reports.

---

### Related Links

“Data Privacy Framework” (Security Administration)

## Implementing PS/nVision Ledger-Based Data Security

This section provides an overview of PS/nVision ledger-based data security and discusses how to:

- Use the Reporting view.
- Use the Authorization table.
- Use ledger reporting view access.
- Restrict ledger access.

### Understanding PS/nVision Ledger-Based Data Security

With PS/nVision row-level ledger security, you can restrict access to specified rows of ledger data. PS/nVision employs a view that joins an Authorization table (maintained by you through a page) with the Ledger table to select the rows a user is authorized to see. You can set up an Authorization table based on any ChartField.

When you define a ledger, you specify the physical table that stores the ledger data in the database. You can also define a record (view) for reporting purposes. If you define a reporting view, PS/nVision uses this record in place of the physical Ledger table. By joining the Ledger table with the Authorization table, the user only sees the rows that they're authorized to see.

This diagram illustrates the PS/nVision security customization.

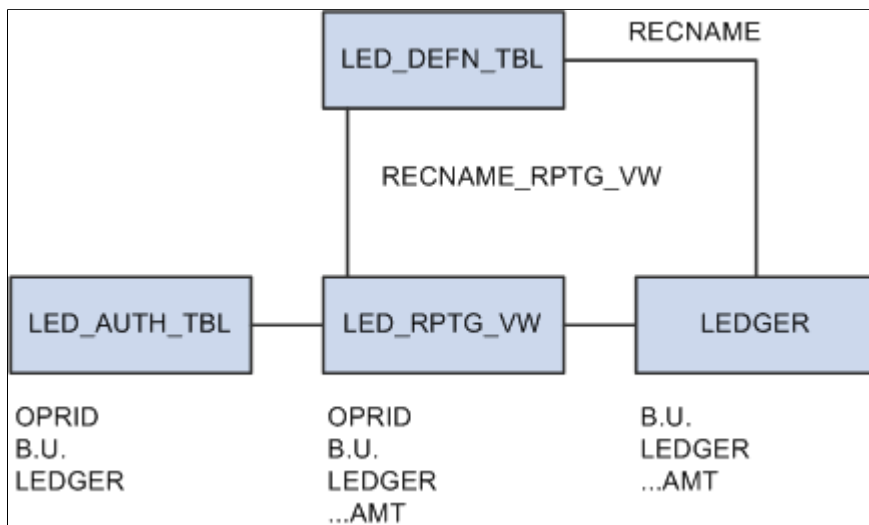

### Using the Reporting View

The reporting view, like the Ledger table, is named on the Ledger template in the **Secured Rptg Vw** (Secured Reporting View) field.

To open the Ledger template, select **General Ledgers > Ledgers > Templates > Record Definitions**.

In the following example, this view (LED\_RPTG\_VW) is defined as:

```
SELECT A.OPRID, L.BUSINESS_UNIT, L.LEDGER, L.ACCOUNT, ...
FROM PS_LEDGER L, PS_AUTH_TBL A
WHERE L.BUSINESS_UNIT = A.BUSINESS_UNIT
      AND L.LEDGER = A.LEDGER
```

Example of the Record Definitions page that displays the Ledger Template and the Secured Rptg Vw field.

The screenshot shows the 'Record Definitions' page with the 'Field Definitions' tab selected. The 'Ledger Template' is 'STANDARD' with a description of 'Standard Detail Ledger'. The 'Default Ledger Type' is 'Standard General Ledger'. The 'Secured Rptg Vw' field is set to 'LED\_RPTG\_VW'. Other fields include 'Ledger Load Staging table' (LED\_LOAD\_STG), 'Led Load Temp Record' (LED\_LOAD\_WK1), and 'Led Load Temp Record 2' (LED\_LOAD\_WK2).

Normally, the view includes all the columns in the Ledger table, plus the **OPRID** field, but you are not required to include all ledger columns. The **OPRID** field is defined as a key to the view. Reporting views can be defined differently for different ledgers. The **OPRCLASS** or **ROWSECCLASS** fields, or any combination of the **OPRID**, **OPRCLASS**, and **ROWSECCLASS** fields can be used instead of the **OPRID** field. In the user profile found in PeopleSoft Security, you can use the **OPRID** field as the user ID, the **OPRCLASS** field as the primary permission list, and the **ROWSECCLASS** field as the row-level security permission list for the user.

With this example view, only users that belong to the specified **OPRID**, **OPRCLASS**, or **ROWSECCLASS** from the LED\_AUTH\_TBL can see those business units and ledgers.

The application provides a template Authorization table and Reporting view. By changing the definition of the view and the underlying Authorization table, you can revise the security to be at the department level or any other ChartField. The personalized view can use BETWEEN, OR, and LIKE statements to implement more flexible (though less efficient) security views.

For example, you could add DEPT\_FROM and DEPT\_TO to the Authorization table. Each user would have access to all departments that fall within the ranges for their user ID and role. The Reporting view could include:

```
WHERE ... L.DEPTID BETWEEN A.DEPT_FROM AND A.DEPT_TO
```

This setting might carry a performance cost on some database platforms, but it can ease the process of maintaining the Authorization table, all transparent to PS/nVision.

Changes to the view are made using Application Designer. Changes to authorizations are made through a page that maintains authorized ChartField values for each user. No changes are required to PS/nVision.

To ignore security on a ledger, leave the **Secured Rprt Vw** (Secured Reporting View) field on the Ledger Definition page blank. PS/nVision will access the base ledger record.

## Related Links

- “Security Basics” (Security Administration)
- “PeopleSoft Online Security” (Security Administration)
- “PeopleSoft Authorization IDs” (Security Administration)
- “PeopleSoft Sign In” (Security Administration)

## Using the Authorization Table

The Authorization table is maintained by a page that can be personalized. Each valid combination of user ID or role and the secured ChartField values (or ranges) must be defined in this table. Since the system administrator who has access to this page (through the Administer Security pages) can change all security provisions, trickle-down authority does not occur.

## Using Ledger Reporting View Access

To get data from a ledger, PS/nVision uses a Select statement from the Reporting view, not the actual Ledger table, using the user’s ID or primary permission list as part of the Where clause. PS/nVision checks the record definition of the Reporting view and determines whether it includes OPRID, OPRCLASS, or ROWSECCLASS in its keys, and generates the appropriate phrase in its Where clause. Individual users are not given direct database access, for example, using a GRANT to either the Ledger table or the Reporting view. (Using GRANT is specific to Oracle.)

This example shows Select of ledger data as used by PS/nVision, in which both OPRID and OPRCLASS are specified in the Authorization table:

```
SELECT ACCOUNT, SUM(POSTED_TOTAL_AMT)
FROM PS_LED_RPTG_VW
WHERE BUSINESS_UNIT = 'NEWGN'
  AND LEDGER = 'ACTUALS'
  AND FISCAL_YEAR = 1993
  AND ACCOUNTING_PERIOD BETWEEN 9 AND 12
  AND ACCOUNT IN ('800100', '800200', '800300')
  AND DEPTID = '0300'
  AND OPRID = 'GLUSER' and OPRCLASS = 'MANAGER'
GROUP BY ACCOUNT
```

## Restricting Ledger Access

Use the nVision Ledger Security page in PeopleSoft Security to restrict what ledgers a user is authorized to access.

Navigation:

**Set Up Financials/Supply Chain > Security > nVision Ledger Security**

This example illustrates the fields and controls on the nVision Ledger Security page.

### nVision Ledger Security

User ID: BICF01

| Business Unit/Ledger |                             | Customize   Find   View All   [Grid Icon]   First   1-3 of 3   Last |
|----------------------|-----------------------------|---|
| Business Unit        | Description                 | Ledger  |
| US001                | US001 NEW YORK OPERATIONS   | BUDGETS   |
| BLG01                | BELGIUM OPERATIONS          | CC_ORG_EXP  |
| US003                | US003 CALIFORNIA OPERATIONS | ADJ-LOCAL   |

## Implementing PS/nVision Query-Based Data Security

PeopleSoft Query restricts users to specific rows of data by employing a similar approach to the ledger Reporting view. Each record definition can have a query security record defined that joins the record data with authorization record data to restrict the returned result set.

Navigation:

1. Select **Start > PeopleTools > Application Designer**.
2. Open the record on which you want to apply row-level security.
3. Select **File > Definition Properties**.
4. Select the Use tab from the Record Properties dialog box.

This example illustrates the fields and controls on the Record Properties – Use dialog box.

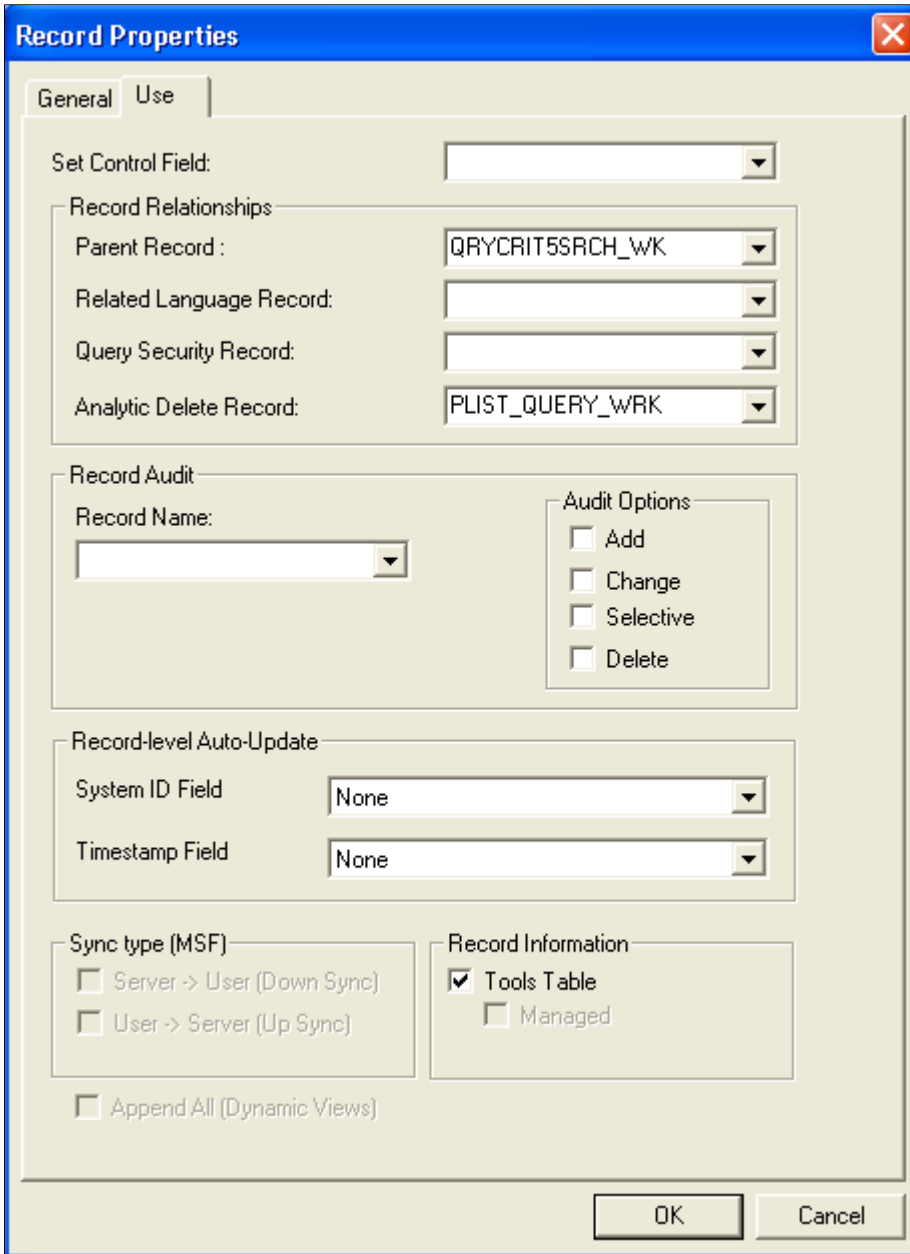

**Related Links**

“Record Definition Planning” (Application Designer Developer’s Guide)

# Tuning PS/nVision Performance

---

## Understanding PS/nVision SQL

This section discusses:

- PS/nVision SQL basics.
- Tree joins.
- Combination rules.
- Capture of PS/nVision SQL.

### PS/nVision SQL Basics

PS/nVision produces a great variety of reports from multiple database tables. The SQL statements it generates are not overly complex but are sensitive to the performance of the underlying database, especially in the following areas:

- Large tables (ledgers often have millions of rows) make efficient use of essential indexes.
- The use of trees and reporting (security) views causes multiple tables to be joined. The database's efficiency in processing these joins dictates most PS/nVision performance.
- Most PS/nVision aggregate queries are defined with minimal built-in criteria and could tire your database server if executed without the added criteria of a PS/nVision layout.

Unlike traditional batch-reporting tools, PS/nVision supports interactive, focused reporting using a probing or querying approach to database access. PS/nVision queries tend to be more numerous than traditional report writers but also more focused on the specific data the user needs to see.

Much of these topics focus on the performance aspects of retrieving information from ledgers for financial reporting. However, most of the information is equally applicable to other types of fact tables, particularly when trees are used to retrieve the data.

### Tree Joins

PS/nVision often relates tree node criteria to data tables by joining the data table to a tree selector table. This selector table contains a row for every detail range defined for the tree in PeopleSoft Tree Manager and is keyed by SELECTOR\_NUM (a system-generated constant number for all the rows representing a particular tree) and the tree node number. Because some database platforms join tables efficiently only if the field sizes match, we use up to 30 selector tables, one for each supported field length. Each selector table has RANGE\_FROM\_nn and RANGE\_TO\_nn columns matching the corresponding field size.

The following is a typical Select statement for selection via nodes on a single tree.

```
SELECT L.TREE_NODE_NUM, SUM(POSTED_TOTAL_AMT)
FROM PS_LEDGER A, PSTREESELECT06 L
WHERE A.LEDGER='ACTUALS'
      AND A.FISCAL_YEAR=1991
      AND A.ACCOUNTING_PERIOD BETWEEN 1 AND 9
      AND A.ACCOUNT>=L.RANGE_FROM_06
      AND A.ACCOUNT<=L.RANGE_TO_06
      AND L.SELECTOR_NUM=198
      AND (L.TREE_NODE_NUM BETWEEN 1612345 AND 3098765
           OR L.TREE_NODE_NUM BETWEEN 3512345 AND 4098765)
GROUP BY TREE_NODE_NUM
```

The bold part of this statement accomplishes the tree criteria selection. If the report had tree criteria for other fields, their selector tables would be added to the From list and similar Join criteria to the Where clause. The Group By clause returns an answer row for each node that has a detail range attached to it; these node numbers are used to post amounts from the answer set into the appropriate rows or columns of the report.

## Related Links

[Using Tree Tables](#)

## Combination Rules

PS/nVision tries to retrieve the data for each report instance with as few Select statements as possible. It examines all row and column criteria to determine which can be combined. It then builds a Select statement to retrieve each intersection of a combined group of rows with a combined group of columns. The following built-in rules should be understood when you design indexes:

- Different ledgers cannot be combined.
- Different TimeSpans cannot be combined.
- nPloded rows or columns cannot be combined with non-nPloded rows or columns.
- To be combined, multiple rows or columns must have criteria for the same set of fields, and each field's criteria must be of the same type. (For example, selected tree nodes cannot be combined with selected detail values).
- If criteria for a field are specified by tree node, they can be combined only if they use the same tree.
- If the combined rows or columns have identical criteria for a particular field, the criteria are included in the Where clause, but a Group By clause on that field is not required. But if different rows or columns in the group have different criteria, PS/nVision adds this field (or the corresponding tree node number) to the Group By clause to retrieve a value for use in posting the answer set to the appropriate rows or columns of the report.
- A single Select statement can retrieve amounts for multiple combined rows and columns.
- Different scope instances are retrieved with separate Select statements.

Some additional rules apply for layouts defined using queries rather than ledgers:

- Different queries are not combined.

- References to different answer columns in the same query can be retrieved with a single Select statement if they meet the above tests.

## Capture of PS/nVision SQL

To examine the SQL produced by PS/nVision, you can capture the statements in one of two ways:

- Use the **Show Report SQL** option in the PeopleSoft nVision Options dialog box. This option causes PS/nVision to display each Select statement used to retrieve labels or amounts in a dialog box. You can select the text with the mouse, then copy (CTRL+C) it to the Clipboard, then paste (CTRL+V) the text into another application, such as Notepad, WordPad, an interactive SQL tool, or a text editor. You can then save the text to a file or work with it within the application.

---

**Note:** To capture the SQL without waiting for it to execute, you can also select the **Suppress Amount Retrieval** option. PS/nVision generates all the SQL but does not execute Select statements for amounts.

---

- Turn on the PeopleTools SQL trace through the Trace tab on the Configuration Manager. The SQL statements executed by PeopleTools will be written to a file that you specify.

---

## Assigning Ledger Tables

Each ledger is assigned to a database table, but different ledgers might not be stored in the same table. Some ledgers need different amount formats (for example, number of decimal places) or a different field configuration than others. Summary ledgers must be stored in different tables than their corresponding detail ledgers.

Because each installation of PeopleSoft General Ledger has different ChartFields and reporting requirements, each installation must assign ledger tables and indexes to meet its requirements and ensure good reporting performance.

---

## Using Indexes and PS/nVision Tuning

This section provides an overview of indexes and discusses how to use:

- Optimizers.
- Filter factors.
- Index matching.
- Ledger access paths.
- Access path analysis.
- Index column suggestions.

## Understanding Indexes

An index is a fast way to find data. At a simple level, an index works like the tabs on a large dictionary; you can go directly to all the words that begin with a particular letter. After that, you need to do some additional searching, taking advantage of the fact that the words are stored in alphabetical sequence. The range of words on a page is generally printed at the top, so you do not have to scan through individual words until you find the page you want. Many database systems include a type of index, often called a primary or clustered index, that has the same sequence as the data.

But suppose you are searching an atlas, where data is generally stored in geographical sequence. If you are looking up Majorca, you are likely to look it up first in the alphabetical index, and then search the page that has a map of the Mediterranean. Data is accessed through an attribute different from its storage attribute.

Suppose you want to find all the words in the dictionary derived from Finnish words. Unless you had a dictionary with an etymological index, your scan of the data pages would be very time-consuming. This type of access should be avoided when accessing large database tables, because it is slow even on the fastest server.

Typically, the Where clause in a query contains a mixture of criteria resolvable through an index and criteria resolvable only through access to the data pages. To be efficient, use the index criteria to limit the number of data rows searched.

### Multi-Column Indexes

Relational databases allow indexes over multiple columns, so that if you have Where criteria for two or more columns in the index, the database manager can use one index to satisfy criteria on multiple columns at a time. Having the pertinent criteria columns in an index, however, does not guarantee that index will be used or that it will be used effectively on all the columns that have criteria.

## Optimizers

Most relational database systems include a cost-based optimizer, a complex program responsible for choosing an access path to satisfy a particular query, such as a Select statement issued by PS/nVision. Using statistics stored in the database, the optimizer tries to determine the index to use for each of the tables accessed in the query and the table access sequence that yields the data with minimal searching.

Some database optimizers have a choice between cost-based and rule-based optimizers. For PS/nVision, and for most PeopleSoft software, you should use the cost-based optimizer because:

- PS/nVision creates dynamic SQL based on the report criteria you provide.  
Rule-based optimizers are designed for static SQL that is written following its rules.
- Cost-based optimizers adapt much better to changes in data and indexes because they use statistics in their optimum access path calculations.

This discussion of tuning PS/nVision's SQL performance assumes use of a cost-based optimizer.

## Filter Factors

Although it might be named differently, a *filter factor* applies to all optimizers. It estimates how effective a particular index will be in narrowing a search.

Assume we have a table in which financial results are stored by fiscal year, period, and account number. The table has two indexes, one on fiscal year and another on account. Assume that our query contains the following:

```
WHERE FISCAL_YEAR = 1994 AND ACCOUNT='500120'
```

If the table has data for 4 fiscal years and 800 accounts, then the filter factor for the fiscal year index is  $\frac{1}{4}$  or 0.25; and the filter factor for the account index is  $\frac{1}{800}$  or 0.00125. Using the index for fiscal year narrows the search to about one fourth of the total table, which is not that great. But using the index for account narrows the data searched to about one eight hundredth of the total table and will be much more efficient. Of course, an index combining fiscal year and account would be even better.

The measure of the selectivity of an index, or a column within an index, is often called its *cardinality*. Cardinality is the number of discrete values in that column or the number of discrete combinations represented by a multi-column index. Cardinality is one of the most important statistics used by optimizers to select indexes and access paths. Like most other statistics, cardinality is updated on request rather than constantly.

When data changes substantially, update the statistics so the optimizer has accurate information. Updating statistics requires different processes on different database platforms.

See the *PeopleTools Installation Guide*.

## Index Matching

The effective filter factor for an index is the combined cardinalities for the index columns actually used in a particular access. For example, if an index is built over FISCAL\_YEAR, LEDGER, and ACCOUNT, and the table contains 4 years, 5 ledgers, and 800 accounts, the potential filter factor is  $\frac{1}{(4*5*800)}$ , or  $\frac{1}{16000}$ , or 0.0000625. However, if the ACCOUNT field in the index couldn't be used because of the nature its criteria, the filter factor would be only  $\frac{1}{20}$ , which isn't very selective.

These general rules apply to matching index columns:

- Database systems provide direct access to data very quickly if the criteria can be processed through an optimized look-up process (such as searching a tree structure) within the index.

Scanning index pages to satisfy criteria is much slower, although it is usually much faster than scanning the corresponding data.

- Columns are matched from left to right in the order they were specified when the index was created.

If, for example, an index is created over DEPTID, BUSINESS\_UNIT, and ACCOUNT, but no criteria were provided for BUSINESS\_UNIT, only the DEPTID field in the index would be matched, even if criteria were specified for ACCOUNT.

- To get index matching on multiple columns, the leftmost columns must have simple criteria, often equality (such as FISCAL\_YEAR=1996).

More complex criteria, such as In (...), Between, or a Join to another table, generally either prevent a random-access match on the index column or prevent matching any of the columns to its right.

## Ledger Access Paths

As a general rule, it is most efficient to access ledger data through trees by accessing the tree table first, then using the detail ranges (or values) for the selected nodes to select the desired rows from the ledger. If the Select statement joins multiple trees, the database engine should select the one that best fits the available indexes or the one with the highest cardinality (if multiple indexes are possible).

## Access Path Analysis

Different techniques exist for showing the access path for a given SQL statement.

### Db2

First, create a PLAN\_TABLE if your database doesn't already have one. You can find a sample Create statement in the Db2 Performance Tuning guide.

Include the SQL statement in the following and execute it via a utility like SPUFI:

```
DELETE FROM PLAN_TABLE WHERE QUERYNO=nnn;
EXPLAIN PLAN SET QUERYNO=nnn FOR statement;
```

where *nnn* is a number you assign to this statement.

Retrieve the plan from the PLAN\_TABLE with the following Select statement:

```
SELECT QBLOCKNO, PLANNO, TNAME, ACCESSNAME, METHOD, ACCESSTYPE, MATCHCOLS, INDEXONL⇒
Y, PREFETCH, SORTC_GROUPBY
FROM PLAN_TABLE
WHERE QUERYNO=nnn
ORDER BY QBLOCKNO, PLANNO;
```

The table contains other plan information; these are generally the most pertinent columns for PS/nVision queries.

### Oracle

First, create a PLAN\_TABLE if your database does not already have one. Here is a sample Create statement:

```
CREATE TABLE PLAN_TABLE (STATEMENT_ID VARCHAR2(254),
TIMESTAMP DATE,
REMARKS VARCHAR2(80),
OPERATION VARCHAR2(30),
OPTIONS VARCHAR2(30),
OBJECT_NODE VARCHAR2(128),
OBJECT_OWNER VARCHAR2(30),
OBJECT_NAME VARCHAR2(30),
OBJECT_INSTANCE NUMERIC,
OBJECT_TYPE VARCHAR2(30),
OPTIMIZER VARCHAR2(255),
SEARCH_COLUMNS NUMERIC,
ID NUMERIC,
PARENT_ID NUMERIC,
POSITION NUMERIC,
other long);
```

You can use SQL\*Plus to evaluate access plans interactively. First, include the SQL statement in the following code and execute it.

```
DELETE FROM PLAN_TABLE WHERE QUERYNO=nnn;
EXPLAIN PLAN SET STATEMENT_ID = 'nnn' FOR
statement;
```

where *nnn* is an identifier you assign to this statement.

Retrieve the plan from the PLAN\_TABLE with the following Select statement:

```
SELECT LPAD(' ', 2*LEVEL) || OPERATION, OPTIONS, OBJECT_NAME,
       OBJECT_INSTANCE, SEARCH_COLUMNS
FROM PLAN_TABLE
WHERE STATEMENT_ID='nnn'
CONNECT BY PRIOR ID = PARENT_ID
       AND STATEMENT_ID='nnn'
START WITH ID = 1
       AND STATEMENT_ID='nnn'
ORDER BY ID;
```

The plan is retrieved in a hierarchical tree format, in which the steps are evaluated from inside out, and then top to bottom. The first step listed (not indented) is actually the final step in the plan, and it is preceded by the step on the following line. For example, a Join is presented first, followed by two indented lines showing the two tables joined and the indexes used to access them.

## Index Suggestions

Designing indexes for PS/nVision can be difficult because different reports can have different criteria. The following table lists the index columns and suggestions.

| <b><i>Index Column</i></b> | <b><i>Suggestions</i></b>   |
|----------------------------|---|
| Fiscal_Year                | <p>When using a TimeSpan (required for ledger reporting but optional for queries), PS/nVision always generates an equality for fiscal year (for example, FISCAL_YEAR=1996).</p> <p>If the TimeSpan requires data from multiple fiscal years, then PS/nVision generates multiple Select statements, one for each fiscal year, which makes Fiscal_Year a good candidate for the first column in a multi-column index.</p> |
| Ledger                     | <p>When accessing ledger data, PS/nVision retrieves data from only one ledger at a time, so this column is guaranteed to have an equality. Thus, Ledger is a good choice as the second column in a multi-column index.</p>  |

| <b>Index Column</b> | <b>Suggestions</b>   |
|---------------------|--|
| Business_Unit       | <p>If you use the report request option to retrieve data from the requesting business unit only, PS/nVision generates an equality (for example, BUSINESS_UNIT='M04') for this column.</p> <p>If this is the most common way of requesting reports or if you use a scope to get instances by business unit, then use business unit as the second or third column in a multi-column index, especially if you have many business units in the same ledger table.</p> <p>If most of your reporting accesses multiple business units in a single instance, position it in the index as you would any other field.</p> |
| Accounting_Period   | <p>When using TimeSpans, accounting period is specified using either an equality (ACCOUNTING_PERIOD=12) or a range (ACCOUNTING_PERIOD BETWEEN 10 AND 12).</p> <p>If you do a lot of reporting for the current period or other single periods (such as current period a year ago), performance may be improved using an alternate index beginning with accounting period. A good optimizer uses this index only when accounting period has an equality.</p>   |
| Account             | <p>In many companies, Account is the field with the highest cardinality. It also has criteria in almost all ledger reports, in part because PS/nVision enforces this rule. Use it as the next index column following the columns that you expect to have equalities.</p>   |

---

## Using Trees

This section provides an overview of using trees with PS/nVision and discusses how to:

- Enhance tree performance with SQL techniques.
- Set tree performance options.

## Understanding Trees and PS/nVision

PS/nVision performance may suffer when trees are used, especially when the SQL statements used to retrieve data access two or more trees at once. On some database platforms, the Where criteria used with most tree joins can cause the database optimizer to select the wrong access path, making the PSTREESELECTnn table an obstacle to performance rather than an aid. This often happens when the tree uses ranges of detail values.

To address these performance issues, PS/nVision includes techniques for building SQL that implement tree criteria, and it also implements SQL that is readily understood by database optimizers, yielding better

access paths with less need for index tuning and so on. Additionally, you have control over the techniques used, so you can tune the performance of individual reports.

## Enhancing Tree Performance with SQL Techniques

PS/nVision includes a number of SQL techniques to improve performance whenever trees are used. You can use static selectors or dynamic selectors. You can specify *where* or *how to* use selectors. A *selector* represents nodes of a single tree and is represented by the set of rows in the PSTREESELECTnn table having a single SELECTOR\_NUM value.

### Static Selectors

A static selector represents the entire tree, and it remains valid until the tree changes. For all database platforms, these selectors contain ranges (unless the tree had no ranges).

Static selectors do not need to be rebuilt except when the tree changes. However, the SQL statements that join static selectors to fact tables (such as ledgers) can be complex because they include both range predicates (if the tree has ranges) and node criteria to select that portion of the tree required on a particular section of a report. This can be difficult for database optimizers to process, especially if multiple trees use this technique.

---

**Note:** You should not run reports while you are modifying trees; it could lead to incorrect results.

---

### Dynamic Selectors

A dynamic selector is created for use in a section of a single report, so it only lasts to the end of the report request. This section, however, may be selected several times, especially if the report uses a scope to produce multiple instances.

In addition to the ability to use a pre-existing (static) selector, PS/nVision can build one on the fly when preparing to run a report. This technique can boost performance, but can also create more overhead, especially if there are multiple users running the same report (using static selectors, users can share selectors).

PS/nVision builds each dynamic tree selector for a specific set of criteria (such as a set of rows or the current instance node), so that a selector (SELECTOR\_NUM value) has exactly the nodes needed for a group of rows or columns to be retrieved with a Select statement. This eliminates the need for the often-cumbersome selection criteria PS/nVision generates for a static selector:

```
TREE_NODE_NUM BETWEEN x AND y OR TREE_NODE_NUM BETWEEN...
```

A dynamic selector creates a new SELECTOR\_NUM value that PS/nVision uses and then deletes once the report is complete. Therefore, distribution statistics (or *skew* statistics) are not present for that selector. (Distribution statistics are still a factor for static selectors.) With certain PS/nVision reports, the absence of distribution statistics can improve performance significantly; that's because distribution statistics can make the SELECTOR\_NUM criteria appear less selective to the database system optimizer, preventing the optimizer from accessing the selector table first.

The disadvantage of dynamic selectors is that one or more selectors may be needed to process a single report. In some cases, the time used to create the selectors can exceed the time saved by using them. Dynamic selectors are most effective on joins that drive the access path; static selectors may be just as fast, or faster, for additional criteria that do not affect the access plan.

## Single-Value Selectors

Use single-value selectors only in conjunction with dynamic selectors. Combining dynamic and single-value selector techniques improves the performance of PS/nVision in many cases where trees are used.

Single-value selectors enable a more efficient equi-join between PSTREESELECTnn.RANGE\_FROM\_nn and the criteria field in the fact table (the one you are selecting data from). In building the dynamic selector, we do not merely copy the ranges of values (such as account numbers) from PSTREELEAF into PSTREESELECTnn. Instead, we join the tree ranges to the underlying detail table (such as the GL\_ACCOUNT\_TBL), and insert the individual detail values into the RANGE\_FROM\_nn column of PSTREESELECTnn. This may generate more rows in this table, but it can also generate a more efficient join without maintaining the tree with individual detail values (the only way you could get equi-joins without this option).

A disadvantage of this technique is that, especially where the tree has large ranges containing many detail values, single value selectors can contain many more rows than ranged selectors have. Unless the join is processed in a more efficient manner, the number of rows in the selector can mean slower join processing.

## Suppress Join

The suppress join technique eliminates a SQL join by retrieving the detail ranges associated with the selected node and coding them in the Select statement. This technique is most effective in the following cases:

- The selected tree is used in the scope you expect to be used with this report, and each instance of that report is a tree node.
- The node or nodes selected represent a relatively small number of detail values or ranges.

The suppress join technique cannot be used where PS/nVision needs to group the answer set by tree node number, because these numbers are not available without joining the data to the tree. This happens, for example, if multiple rows or columns with otherwise similar criteria select different nodes of this tree. This is typical in the rows of most financial reports. However, if nPlosion to underlying details is specified for these rows or columns, the suppress join technique can be used, because PS/nVision can Group By the detail values rather than tree nodes.

Additionally, when the selected node (or nodes) includes large numbers of detail ranges, the suppress join technique may not be practical or efficient. While PS/nVision can build the very large statements that can result in this case, use of the suppress join technique when tree nodes refer to very large lists of detail ranges can be slower than the other techniques, or even fail to run because the statements exceed the size limits imposed by your database platform.

## Sub-Select Tree Selector

The sub-select method is very similar to a join. Instead of adding the tree selector to the From list of the main query, the tree selector criteria and its relation to the data (for example, DEPTID) in the main query is within an "Exists (Select ...)" clause in the Where portion of the main query. This is called a correlated sub-query, because part of the criteria in the sub-select relates to data in the main query (A.DEPTID=B.RANGE\_FROM\_05). This is what makes it so much like a join. Database engines and optimizers differ in how they handle this syntax. Some process a correlated sub-query just like a join, while others are subtly different. You may need to experiment to determine which works better for which reports on your database platform.

Data from the sub-select statement cannot be included in the main Select list; thus, none can be visible to the program (for example, PS/nVision) that is running the query. This is because the sub-select statement is hidden in the Where clause, rather than appearing in the From clause. When PS/nVision retrieves multiple nodes of data for different rows or columns of a report, it uses the node number (from the tree selector) to distinguish the data, and this means a join is required. If you specify either sub-select or Suppress Join in this case, PS/nVision ignores the option and forces a join. You need to specify join options even if not using a join method, because you may get a join after all. If you don't see a performance benefit using the sub-select method, we recommend using join instead, because it can be used whether or not tree node criteria are needed in the answer set.

## Additional Options

Before the tree performance options were added, PS/nVision invoked the following type of syntax when joining a selector for a tree with ranges:

```
WHERE _ field >= L.RANGE_FROM_nn AND field <= L.RANGE_TO_nn _
```

This syntax is equivalent to using the Between predicate. It resulted in better access plans on the Db2/MVS platform. PS/nVision now includes an option to generate the following syntax:

```
WHERE _ field BETWEEN L.RANGE_FROM_nn AND L.RANGE_TO_nn _
```

This syntax should result in better access plans on certain database platforms.

---

**Note:** This option is only relevant to trees that use range selectors.

---

## SQL Examples

Below is an example of the SQL alternatives made possible through the use of tree performance options. Here is the default query (with the node criteria highlighted):

```
SELECT L1.TREE_NODE_NUM, SUM(A.POSTED_TOTAL_AMT)
FROM PS_LEDGER A, PSTREESELECT05 L, PSTREESELECT06 L1
WHERE A.LEDGER='ACTUALS' AND
      A.FISCAL_YEAR=1996 AND
      A.ACCOUNTING_PERIOD BETWEEN 1 AND 8 AND
      L.SELECTOR_NUM=216 AND
      A.BUSINESS_UNIT>=L.RANGE_FROM_05 AND
      A.BUSINESS_UNIT<=L.RANGE_TO_05 AND
      (L.TREE_NODE_NUM BETWEEN 1000000000 AND 1666666665) AND
      A.CURRENCY_CD='USD' AND
      L1.SELECTOR_NUM=215 AND
      A.ACCOUNT>=L1.RANGE_FROM_06 AND
      A.ACCOUNT<=L1.RANGE_TO_06 AND
      (L1.TREE_NODE_NUM BETWEEN 1916275676 AND 1923430847) AND
      A.STATISTICS_CODE=' '
GROUP BY L1.TREE_NODE_NUM;
```

Here's an alternative query using the Suppress Join technique for business unit criteria and a dynamic, single-value selector for ACCOUNT:

```
SELECT L1.TREE_NODE_NUM, SUM(A.POSTED_TOTAL_AMT)
FROM PS_LEDGER A, PSTREESELECT06 L1
WHERE A.LEDGER='ACTUALS' AND
      A.FISCAL_YEAR=1996 AND
      A.ACCOUNTING_PERIOD BETWEEN 1 AND 8 AND
      (A.BUSINESS_UNIT BETWEEN 'B0006' AND 'B0006'
      OR A.BUSINESS_UNIT BETWEEN 'B5030' AND 'B5030'
      OR A.BUSINESS_UNIT BETWEEN 'B9013' AND 'B9014'
      OR A.BUSINESS_UNIT BETWEEN 'B0015' AND 'B0015'
      OR A.BUSINESS_UNIT BETWEEN 'B9026' AND 'B9026')
```

```

        OR A.BUSINESS_UNIT BETWEEN 'B0019' AND 'B0031'
        OR A.BUSINESS_UNIT BETWEEN 'B0016' AND 'B0018') AND
    A.CURRENCY_CD='USD' AND
    L1.SELECTOR_NUM=1215 AND
    A.ACCOUNT=L1.RANGE_FROM_06 AND
    A.STATISTICS_CODE=' '
GROUP BY L1.TREE_NODE_NUM;

```

Next is another form of the same query, with dynamic business unit selectors and dynamic ACCOUNT selectors:

```

SELECT L1.TREE_NODE_NUM, SUM(A.POSTED_TOTAL_AMT)
FROM PS_LEDGER_A, PSTREESELECT05 L, PSTREESELECT06 L1
WHERE A.LEDGER='ACTUALS' AND
      A.FISCAL_YEAR=1996 AND
      A.ACCOUNTING_PERIOD BETWEEN 1 AND 8 AND
      L.SELECTOR_NUM=1216 AND
      A.BUSINESS_UNIT = L.RANGE_FROM_05 AND
      A.CURRENCY_CD='USD' AND
      L1.SELECTOR_NUM=1215 AND
      A.ACCOUNT=L1.RANGE_FROM_06 AND
      A.STATISTICS_CODE=' '
GROUP BY L1.TREE_NODE_NUM;

```

---

## Setting Tree Performance Options

PS/nVision and PeopleSoft Tree Manager each provide a number of techniques and tuning options that can dramatically improve reporting performance. These performance enhancement techniques apply to both query-based and ledger-based layouts.

To change the technique used for a given tree, you can specify the technique using the Tree Performance Options dialog box in PeopleSoft Tree Manager. To override any Tree Manager settings and specify the technique used for a particular report layout, you specify the technique using the Tree Performance tab on the Layout Options dialog box in PS/nVision.

The tree performance options enable you to control the database access techniques PS/nVision uses to implement tree criteria for your report. These options can have a dramatic effect on how fast your reports run.

In setting these options, work with your database administrator to determine the best options, and to ensure that indexes are tuned for the SQL techniques selected. You should be prepared for some trial and error to find the best settings for your data and reporting requirements.

---

**Note:** The performance-tuning information presented here is intended for database administrators and advanced PS/nVision users who understand how PS/nVision accesses relational databases. The techniques discussed are not useful for casual users or for customizing performance on a workstation-by-workstation basis.

---

Access the Tree Performance tab from Excel, select **nVision > Open Layout > Layout Options**; and then select the Tree Performance tab.

This example illustrates the fields and controls on the PeopleSoft nVision Layout Options dialog box: Tree Performance tab.

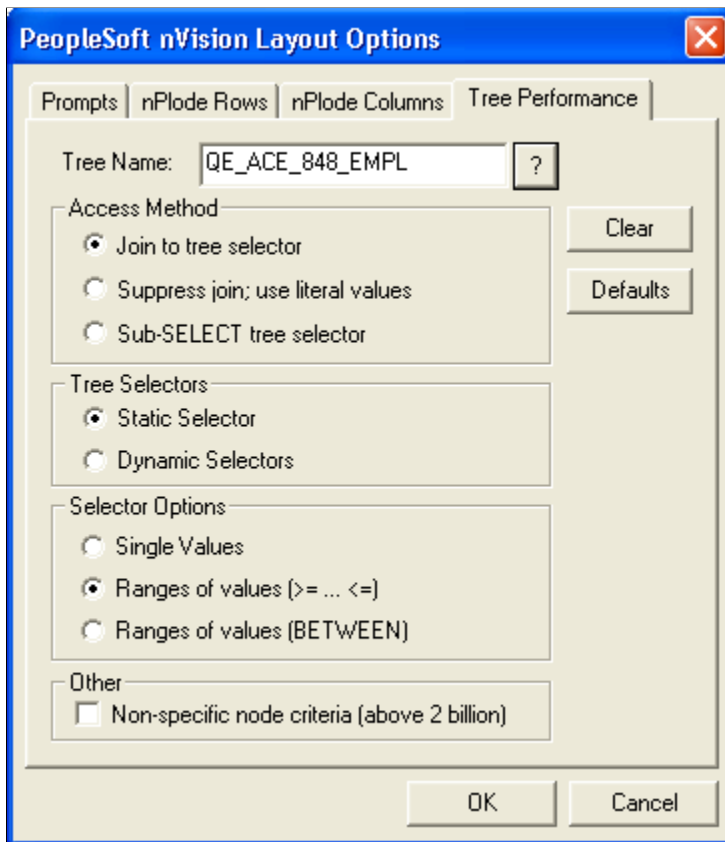

Tree performance options are saved in the sheets named `NvsTree.treename` for each specified tree.

You are setting performance options for a specific layout, one tree at a time. Optimum performance often is achieved using different techniques for different trees, depending on the nature of those trees and the way each tree is used in the report.

If you do not specify the tree performance options for a tree used in a report layout, and no performance options are defined in Tree Manager for that tree, PS/nVision uses the same SQL techniques used in the past on your database platform.

| <b>Field or Control</b>      | <b>Description</b>  |
|------------------------------|---|
| <b>Join to tree selector</b> | <p>Select to include the tree selector table in the From clause and use join criteria to select the appropriate rows from the fact table.</p> <p>This method is sometimes used by PS/nVision even when another method is specified, if tree node information is needed to produce the report.</p> |

| <b>Field or Control</b>                  | <b>Description</b>  |
|--|---|
| <b>Suppress join; use literal values</b> | <p>Select to eliminate a SQL join by retrieving the detail ranges associated with the selected node and coding them in the Select statement.</p> <p>If you select the suppress join technique, but PS/nVision cannot use it because of the need to group results by tree node, it will automatically use the join method you select (that is, either static or dynamic). However, if PS/nVision can use the suppress join technique, it ignores the selector options for this tree. Therefore, pick a selector technique in addition to selecting the suppress join option.</p> <hr/> <p><b>Note:</b> This option is not available for use with winter trees.</p> |
| <b>Sub-SELECT tree selector</b>          | <p>Select to add the tree selector to the From list of the main query.</p> <p>The tree selector criteria and its relation to the data in the main query is within an Exists clause in the Where portion of the main query.</p>  |
| <b>Static Selectors</b>                  | <p>Select to build a selector that represents the entire tree and remains valid until the tree changes.</p>   |
| <b>Dynamic Selectors</b>                 | <p>Select to creates a new tree selector for use in a section of a single report.</p> <p>The dynamic selector represents just the requested nodes.</p>  |
| <b>Single values</b>                     | <p>Used only with dynamic selectors.</p> <p>Select to cause PS/nVision or PeopleSoft Query to build a selector using the individual detail values (from the detail table specified in the tree structure) that fall within the detail ranges of the selected nodes.</p>   |
| <b>Range of values (&gt;= &lt;=)</b>     | <p>For a tree with ranges of values, select to make the selectors more compact (fewer rows) and less likely to become obsolete as detail values are added.</p> <p>For some database optimizers, the syntax “fieldname &gt;= RANGE_FROM_nn AND fieldname &lt;= RANGE_TO_nn” gets a better access plan than BETWEEN.</p> <hr/> <p><b>Note:</b> If you specify one of the range syntax options, but the tree has no ranges, PS/nVision uses the single-value syntax (field = L.RANGE_FROM_nn).</p>   |

| <i>Field or Control</i>                             | <i>Description</i>   |
|---|--|
| <b>Range of Values (BETWEEN)</b>                    | Select to use the syntax “fieldname BETWEEN RANGE_FROM_nn AND RANGE_TO_nn”.<br><br>This choice is best for ranged selectors on most database platforms.  |
| <b>Non-specific node criteria (above 2 billion)</b> | Select to prevent the optimizer from selecting the driving criteria field based on how inclusive the node number criteria are.<br><br>This option has been used on Db2 when criteria for multiple trees were present. Unless you are a Db2 customer who has tuned your database around this extra criteria, we recommend that you not use this option. |

---

**Note:** Trees with a mixture of dynamic detail and range detail are not supported by nVision. Reports generated using such trees may not be accurate.

---

## Related Links

[Using PS/nVision-Defined Names](#)

“Setting Tree Performance Options” (Tree Manager)

## Understanding Restrictions on Tree Performance Options

In certain cases, PS/nVision may override the specified tree SQL technique. The dynamic selector technique is not used when a field has tree criteria in multiple dimensions (for example, both row and column), or when a field has the same tree criteria in multiple places (for example, in both sheet level and row level). This can also happen at DrillDown time if criteria for a field are inherited from multiple dimensions (for example, the scope and column) of the parent report. With the dynamic selector technique unavailable, PS/nVision uses either the suppress join technique (if requested and if feasible) or the static selector technique.

You cannot select the single value option with static selectors because the static selector remains unchanged until the tree changes. However, the addition of single values to the fact table, which the tree detail is based on, doesn't affect a tree change. The single-value options exist for dynamic selectors and for enabling you to control the syntax used with ranged selectors.

PS/nVision ignores the suppress join technique if specified for a tree with summary ChartField node criteria. Summary ChartField nodes, or detail values in summary trees, are tree nodes from a detail tree rather than values from a database field. In addition, PS/nVision does not support translation of summary ChartField nodes when drilling down to the detail ledger, so we recommend that you use the summary tree criteria.

The suppress join technique is available for reports based on summary trees, as long as tree node information is not needed to group the result. It may be possible to recode some reports that use detail value criteria for summary trees for performance reasons.

These performance-enhancement techniques are not used when retrieving labels (such as account descriptions). Labels for detail fields associated with tree criteria are retrieved using static selectors. The

SQL code used to retrieve labels is defined at a different level from the SQL used to retrieve amounts, so it isn't possible to use the same dynamic selectors for both.

Because criteria from multiple rows and columns are combined with the instance (scope) criteria in a single Select statement, SQL statements generated by PS/nVision can be long and complex. While current releases of PS/nVision no longer enforce a statement size limit, every database platform has a maximum statement size, and even statements shorter than the maximum may be inefficient. You control statement size through judicious use of the performance options.

Here are the common causes of oversized SQL statements:

- Use of the suppress join technique on a tree (or trees) from which nodes representing too many detail ranges are requested.

Suppressing a join can be very useful, but is recommended only when criteria from a given tree require a relatively short list of detail values or ranges.

- Use of static selectors with a very long list of nodes.

PS/nVision combines node number ranges for sibling nodes where possible, so it takes lots of nodes to exceed the limit. Use of dynamic selectors makes the SQL much shorter.

- An extremely long list of detail values.

The messages that indicate a statement is too long vary from platform to platform. For statements made long by tree criteria, the most successful solution is generally to use the dynamic selectors technique on one or more of the trees involved.

## Optimizing Indexes With Dynamic Selectors

If you use the dynamic selector technique heavily for certain criteria fields, you should try an index on that field's selector table that is optimized around this technique. For example, a ACCOUNT is a six-character field (meaning its selector table is PSTREESELECT06) and you plan to use dynamic selectors, with single values, for the ACCOUNT trees on most of your production reports. You should create an index on PSTREESELECT06 on SELECTOR\_NUM and RANGE\_FROM\_06, since these are the only fields that will appear in the Where clause with single-value dynamic selectors. But also note that:

- Other fields that are the same size may use the same selector table, so you might not want to eliminate an index if removing it would penalize those reports.
- Although only SELECTOR\_NUM and RANGE\_FROM\_06 will appear in the Where clause, TREE\_NODE\_NUM may appear in the Select list (if PS/nVision needs to Group By tree node).

An index that includes this field as well would enable index-only access (that is, access with no need to read the data table) when using this selector.

- Index use varies depending on the optimizer and the volume and distribution of data, so experiment to get optimum results.

## Using Tree Tables

Understanding the structure of the various tree tables that PS/nVision uses and how they interact is helpful. The main tables used in this example are PSTREEDEFN, PSTREELEAF, PSTREESELCTL, and PSTREESELECTnn.

This example shows the tree tables that are used by PS/nVision.

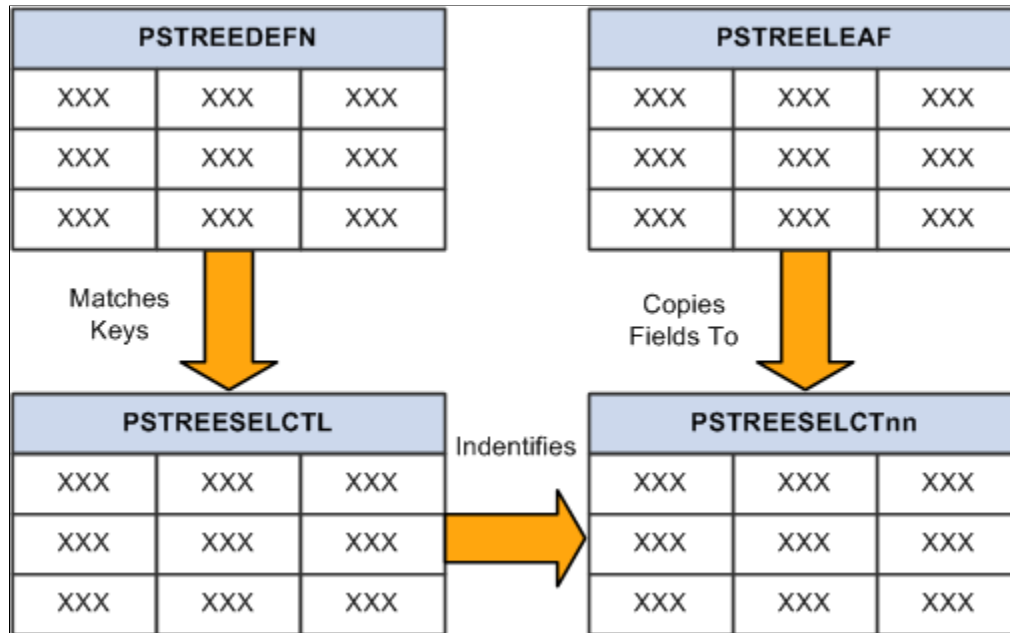

The following sections provide details about each of these tables.

### PSTREEDEFN: Tree Definition

PSTREEDEFN (Tree Definition) table is the system table that defines an effective-dated version of a tree.

The following table lists the field names, types, lengths, formats, and long names of the PSTREEDEFN table.

| <i>Field Name</i> | <i>Type</i> | <i>Length</i> | <i>Format</i> | <i>Long Name</i>                           |
|-------------------|-------------|---------------|---------------|--|
| SETID             | Char        | 5             | Upper         | setID                                      |
| SETCNTRLVALUE     | Char        | 5             | Upper         | Set control value.<br>Alternative to setID |
| TREE_NAME         | Char        | 18            | Upper         | Tree name                                  |
| EFFDT             | Date        | 10            | N/A           | Effective date                             |

| <b>Field Name</b> | <b>Type</b> | <b>Length</b> | <b>Format</b> | <b>Long Name</b>            |
|-------------------|-------------|---------------|---------------|-----------------------------|
| EFF_STATUS        | Char        | 1             | Upper         | Status as of effective date |
| VERSION           | Nbr         | 10            | Raw B         | Version                     |
| TREE_STRCT_ID     | Char        | 18            | Upper         | Tree structure ID           |
| DESCR             | Char        | 30            | Mixed         | Description                 |
| ALL_VALUES        | Char        | 1             | Upper         | All values                  |
| USE_LEVELS        | Char        | 1             | Upper         | Use levels                  |
| VALID_TREE        | Char        | 1             | Upper         | Valid tree                  |
| LEVEL_COUNT       | Nbr         | 3             | N/A           | Level count                 |
| NODE_COUNT        | Nbr         | 5             | Raw B         | Node count                  |
| LEAF_COUNT        | Nbr         | 5             | Raw B         | Leaf count                  |
| TREE_HAS_RANGES   | Char        | 1             | Upper         | Tree has ranges             |
| DUPLICATE_LEAF    | Char        | 1             | Upper         | Allow duplicate leaf        |
| TREE_CATEGORY     | Char        | 18            | Upper         | Category                    |
| TREE_ACC_METHOD   | Char        | 1             | Upper         | Tree access method          |
| TREE_ACC_SELECTOR | Char        | 1             | Upper         | Tree access selector        |
| TREE_ACC_SEL_OPT  | Char        | 1             | Upper         | Tree access selector option |

## **PSTREELEAF: Tree Leaf**

PSTREELEAF (Tree Leaf) table is the user table that defines the data value ranges, which are the leaves of a tree. For each leaf node (nodes without children), one or more ranges define the detail values that correspond to that node.

The following table lists the field names, types, lengths, formats, and long names of the PSTREELEAF table.

| <i>Field Name</i> | <i>Type</i> | <i>Length</i> | <i>Format</i> | <i>Long Name</i>  |
|-------------------|-------------|---------------|---------------|-------------------|
| SETID             | Char        | 5             | Upper         | SetID             |
| SETCNTRLVALUE     | Char        | 5             | Upper         | Set control value |
| TREE_NAME         | Char        | 18            | Upper         | Tree name         |
| EFFDT             | Date        | 10            | N/A           | Effective date    |
| TREE_BRANCH       | Char        | 20            | Upper         | Tree branch name  |
| TREE_NODE_NUM     | Nbr         | 10            | Raw B         | Tree node number  |
| RANGE_FROM        | Char        | 30            | Upper         | Range from        |
| RANGE_TO          | Char        | 30            | Upper         | Range to          |
| DYNAMIC_RANGE     | Char        | 1             | Upper         | Dynamic range     |
| OLD_TREE_NODE_NUM | Char        | 1             | Upper         | Old tree node     |

## PSTREESELCTL: Tree Selection Control

PSTREESELCTL (Tree Selection Control) table is the system table that controls and manages static selectors (see PSTREESELECTnn). Each row in this table corresponds to a row in PSTREEDEFN and to a group of rows (with the same SELECTOR\_NUM) in PSTREESELECTnn.

---

**Note:** PSTREESELCTL table is only used for static selectors.

---

The following table lists the field names, types, lengths, formats, and long names of the PSTREESELCTL table.

| <i>Field Name</i> | <i>Type</i> | <i>Length</i> | <i>Format</i> | <i>Long Name</i>  |
|-------------------|-------------|---------------|---------------|-------------------|
| SETID             | Char        | 5             | Upper         | SetID             |
| SETCNTRLVALUE     | Char        | 5             | Upper         | Set control value |
| TREE_NAME         | Char        | 18            | Upper         | Tree name         |

| <b>Field Name</b> | <b>Type</b> | <b>Length</b> | <b>Format</b> | <b>Long Name</b>            |
|-------------------|-------------|---------------|---------------|-----------------------------|
| EFFDT             | Date        | 10            | N/A           | Effective date              |
| VERSION           | Nbr         | 10            | Raw B         | Version                     |
| SELECTOR_NUM      | Nbr         | 10            | Raw B         | Selector number             |
| SELECTOR_DT       | Date        | 10            | N/A           | Selector date               |
| TREE_ACC_SEL_OPT  | Char        | 1             | Upper         | Tree access selector option |
| LENGTH            | Nbr         | 5             | Raw B         | Length                      |

### PSTREESELECTnn: Tree Select Work-Size nn

PSTREESELECTnn (Tree Select Work-Size nn) are the system tables that define selectors used by PS/nVision to speed tree-based data selection. A selector table is defined for every possible detail field length (nn = 01-30); thus this description applies to tables named PSTREESELECT01, PSTREESELECT02, and so on, through PSTREESELECT30.

The following table lists the field names, types, lengths, formats, and long names of the PSTREESELECTnn table.

| <b>Field Name</b> | <b>Type</b> | <b>Length</b> | <b>Format</b> | <b>Long Name</b> |
|-------------------|-------------|---------------|---------------|------------------|
| SELECTOR_NUM      | Nbr         | 10            | Raw B         | Selector number  |
| TREE_NODE_NUM     | Nbr         | 10            | Raw B         | Tree node number |
| RANGE_FROM_nn     | Char        | n             | Upper         | Range from       |
| RANGE_TO_nn       | Char        | n             | Upper         | Range to         |

### PSTREESELNUM: Tree Selector Number

PS/nVision uses the PSTREESELNUM (Tree Selector Number) table to assign a unique SELECTOR\_NUM value to each tree selector as it is built.

---

**Note:** The PSTREESELNUM table has only one row.

---

The following table lists the field name, type, length, format, and long name of the PSTREESELNUM table.

| <b>Field Name</b> | <b>Type</b> | <b>Length</b> | <b>Format</b> | <b>Long Name</b> |
|-------------------|-------------|---------------|---------------|------------------|
| SELECTOR_NUM      | Nbr         | 10            | Raw B         | Selector number  |



# Running PS/nVision Reports on the Web

---

## Understanding PS/nVision Reporting on the Web

Users with Internet access can run, view, drill down into, and distribute PS/nVision reports through a browser, without needing a PeopleSoft application installed on client machines. Users can send reports as email attachments rather than requiring recipients to navigate to a location on a file server.

PS/nVision on the web includes:

- Internet versions of report requests, report books, and scope definitions.
- Output in Microsoft Excel (.xlsx) format.
- DrillDown for Microsoft Excel reports.
- Email options to send PS/nVision reports to individual users or users in specified roles.
- Integration with PeopleSoft Process Scheduler and PeopleSoft Report Manager to send bursting report instances to designated users or users in specified roles.
- Support for multiple PS/nVision sessions when PS/nVision is invoked from PeopleSoft Process Scheduler.
- A restart feature that allows the system to restart a process if it is marked *No Success*.

---

**Note:** See My Oracle Support, Certifications, for PeopleSoft PeopleTools, to find the versions of Microsoft Excel that are supported with PS/nVision for the current release.

PS/nVision will no longer support the HTML output format because Microsoft Excel 2007 removes certain features when an Excel file is saved in an HTML format. For example, Defined Names and other features are removed when the Excel file is saved in an HTML format. Without the Defined Names feature, you cannot use PS/nVision drilldown. As there will be loss of nVision-specific information in HTML reports, the support for the HTML output format is no longer available beginning with PeopleTools 8.51. Please note that the Microsoft Excel Format is still supported as an output format for nVision reports. The generated reports will be in the Excel 2007 (.xlsx) format beginning with PeopleTools 8.51. All nVision features, including drilldown, are supported with this output format. These features continue to function the same way they did with the Excel 2003 (.xls) output format.

PS/nVision uses Microsoft Office OpenXML SDK (Software Development Kit) to generate Excel-compatible PS/nVision reports on the batch server without using Excel in an unattended mode. Design and usage of PS/nVision windows client are not impacted by the OpenXML SDK, and PS/nVision windows client continue to use Microsoft Excel and Excel API.

---

See *PeopleTools Installation Guide: Installing Products for PS/nVision*.

### Related Links

[Converting Existing Layouts and Reports to OpenXML Format](#)

“Defining Process Definitions” (Process Scheduler)

---

## Configuring PS/nVision on the Web

PS/nVision processes on the web are all run by Process Scheduler. All the equivalent settings that PS/nVision needs in the Windows client (such as layout directory and instance directory) are defined in the nVision section of the Process Scheduler configuration file. Other configurable options include:

- The `EnableDrillDownDownForFile` parameter, which supports DrillDown on File output type reports in the web-based nVision environment.

The setting only takes effect when the report request is defined to run in File output type on the web. By default, `EnableDrillDownDownForFile` is set to be 0 (false). When the option is set to 1, users are able to access the report instances in the instance directory and drill down the report instances on the web. When the option is set to 0, the generated report instances are not drillable.

- The `EnablePollDialogs` and `PollDialogSeconds` parameters, which dismiss unattended PS/nVision dialog boxes.

---

**Note:** Because this option can affect performance, it should be used with caution.

---

- The **TraceLevel** option, which enables you to generate and view trace logs specifically for PS/nVision.
- The `SaveTempFile` parameter enables you to save or delete the temporary reports that are created when running nVision to email, print, or web output.

When `SaveTempFile` parameter is set to true (1), temporary reports will not be deleted. If run to email or print output, the reports will be saved to the folder specified in the Directory Name Template field of the report request. If that field is left blank, the report is saved to the nVision instance directory. If run to web output, the report is always be saved in the nVision instance directory.

### Related Links

[Setting Trace Files](#)

[Dismissing Unattended Dialogs](#)

[Using Configuration Manager](#)

“Using PSADMIN with PeopleSoft Process Scheduler” (Process Scheduler)

---

## Configuring the Report Node

Both PeopleSoft Process Scheduler and Report Manager use report distribution nodes to deliver PS/nVision reports. The distribution node definition specifies the report repository location and the location of the stored content (the files) for Report Manager. When PS/nVision creates a report instance, it passes the physical file location information to PeopleSoft Process Scheduler. Process Scheduler then passes the file to Report Manager using the information defined on the Distribution Node page.

## Related Links

“Setting Distribution Options” (Process Scheduler)

“Defining Report Nodes” (Process Scheduler)

## Creating Scope Definitions

Creating a scope definition on the web is similar to defining it in the Windows client with the following exception: You cannot specify an effective date for the tree node table or value table. The current date is used as the effective date.

Select **Reporting Tools > PS/nVision > PS/nVision Scope Definitions** to access the Scope Definition page where you can create scope definitions.

See [Understanding Report Scopes](#), [Defining Scopes](#), [Creating Report Requests](#).

This example illustrates the fields and controls on the Scope Definition page.

### Scope Definition

SetID: QEDM2      Report Scope: QEDEPTID

Description:       Business Unit:

Field Combination Table:

**Scope Fields** Find | View All    First  1 of 1  Last

\*Field Name:       Department

\*How Specified:

Business Unit Keyed Tree

Tree Name:

Customize | Find | View All |       First  1 of 1  Last

|   |                                     |                                  |                                  |                                  |
|---|-------------------------------------|----------------------------------|----------------------------------|----------------------------------|
| 1 | <input type="text" value="REGION"/> | <input type="button" value="🔍"/> | <input type="button" value="+"/> | <input type="button" value="-"/> |
|---|-------------------------------------|----------------------------------|----------------------------------|----------------------------------|

[Delete Scope](#)

Scopes are defined based on a tree node record or a value table such as Department table or Product table. By defining your scope based on a table that includes an email address or user ID for each value you can direct each scope based-report instance to a different user. For example, the record shown the following table can be used with a scope definition as a value table to have each report instance sent by email or posted to a different user in Report Manager.

| <i>Department</i><br>(DEPTID) | <i>Description</i><br>(DESCR) | <i>Manager</i> | <i>Email Address</i><br>(EMAILID) | <i>User ID</i><br>(OPRID) |
|-------------------------------|-------------------------------|----------------|-----------------------------------|---------------------------|
| 12000                         | Sales Canada                  | John Smith     | john_smith@abc.com                | U:JOHNSMITH               |

| <b>Department</b><br><b>(DEPTID)</b> | <b>Description</b><br><b>(DESCR)</b> | <b>Manager</b> | <b>Email Address</b><br><b>(EMAILID)</b>      | <b>User ID</b><br><b>(OPRID)</b>       |
|--------------------------------------|--------------------------------------|----------------|---|--|
| 13000                                | Sales USA                            | Jane White     | jane_white@abc.com                            | U:JANEWHITE                            |
| 14000                                | Sales Asia                           | Asia Manager   | Kathy_Lin@abc.com;<br>U:PeterYu;R:AsiaManager | U:KathyLin;U:PeterYU;<br>R:AsiaManager |

Scope variables are used in the Email and Security templates the same way that you use them to create unique file names with the File template or directory names with the Directory template in your report request. The Scope Descriptive Variable (%DES%) is used to select a related field value from the Scope Value table or the Tree Node table. You can use values for email addresses, user Ids, or role Ids. The general syntax of the %DES% variable is:

```
%DES.[scope field].[detail field].[node field]%
```

If your scope is based on a value table, replace [node field] with [detail field]. The [detail field] is repeated so that the basic format of the syntax remains the same.

---

**Note:** The %DES% variable requires the associated field value be in the same table that the scope is based on.

---

## Email Template Variables

To have each report instance sent as email to the associated email address of department manager, you would enter the following values in your email template:

```
%DES.DEPTID.EMAILID.EMAILID%
```

This values enables PS/nVision to use the associated email address from the **EMAILID** field from the value table where the DEPTID is located. You need to specify email as the output type on the report request.

The scope descriptive variable (%DES%) is used to select a related field value from the scope value table. For example, if your scope were based on the record shown above, you would produce three report instances, and each instance would be sent to the associated email address. The report for department 12000 would be emailed to john\_smith@abc.com, and the report for 13000 would be emailed to jane\_white@abc.com. The report for department 14000 would be emailed to several recipients—Kathy Lin, Peter Yu, and the email addresses for the users who belong to the role Asia Manager. You can specify the user email addresses associated with users and roles in the user profiles of Maintain Security.

## Security Template Variables

Using the record above for the value table, you could post each report instance to Report Manager for the associated user. In this case you would use web as the output type and enter the following variables in the security template:

```
%DES.DEPTID.OPRID.OPRID%
```

The report for department 12000 would be posted to Report Manager for user JOHNSMITH, and the report for 13000 would be posted for user JANEWHITE. John Smith would not be able to access the

Department 13000 report. The report for department 14000 would be posted to Report Manager for Kathy Lin, Peter Yu, and the other users belonging to the role Asia Manager.

## Sample Record Definition

This example shows the record definition used to create a view that joins the department record (DEPT\_TBL) with a PeopleSoft security record (PSOPRDEFN).

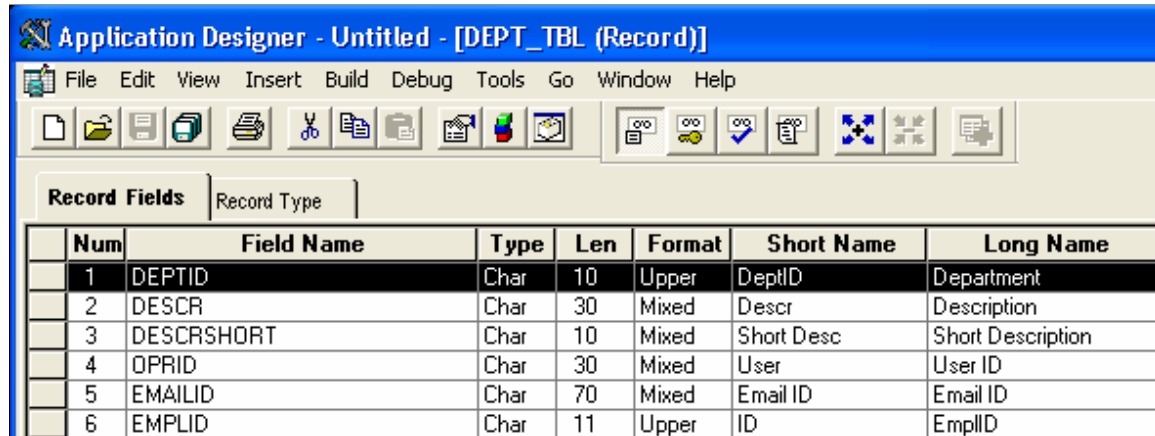

| Num | Field Name | Type | Len | Format | Short Name | Long Name         |
|-----|------------|------|-----|--------|------------|-------------------|
| 1   | DEPTID     | Char | 10  | Upper  | DeptID     | Department        |
| 2   | DESCR      | Char | 30  | Mixed  | Descr      | Description       |
| 3   | DESCRSHORT | Char | 10  | Mixed  | Short Desc | Short Description |
| 4   | OPRID      | Char | 30  | Mixed  | User       | User ID           |
| 5   | EMAILID    | Char | 70  | Mixed  | Email ID   | Email ID          |
| 6   | EMPLID     | Char | 11  | Upper  | ID         | EmplID            |

## SQL View Text

The SQL view text joins the PS\_DEPT\_TBL.MANAGER\_ID with the PSOPRDEFN.EMPLID in security. The email address and user ID (OPRID) are taken from PSOPRDEFN.

```
SELECT B.DEPTID
, B.DESCR
, B.DESCRSHORT
, 'U:' + A.OPRID
, A.EMAILID
, A.EMPLID
FROM PSOPRDEFN A
, PS_DEPT_TBL B
WHERE B.EFFDT = (
SELECT MAX(B_ED.EFFDT)
FROM PS_DEPT_TBL B_ED
WHERE B.DEPTID = B_ED.DEPTID
AND B_ED.EFFDT <= SUBSTRING(CONVERT(CHAR, GETDATE(), 121), 1, 10))
AND A.EMPLID = B.MANAGER_ID AND B.MANAGER_ID <> ''
```

**Note:** This simple example uses Microsoft SQL database platform-specific syntax and should not be used without careful evaluation. You may get unpredictable results if the scope definition returns more than one row from the value table for each scope value.

## Setting Up Report Requests

This section describes how to:

- Create report requests.
- Configure delivery templates.
- Use portal folders.

- Copy report requests.
- Set advanced options.

## Creating Report Requests

To access the nVision Report Request page (NVS\_REPORT\_RQST):

1. Select **Reporting Tools > PS/nVision > PS/nVision Schedule Requests** from PIA.

The Report Request search page appears.

2. Search for an existing business unit, or enter a new one.

The nVision Report Request page appears.

This example illustrates the fields and controls on the nVision Report Request page.

The screenshot displays the 'nVision Report Request' page with the following fields and controls:

- Business Unit:** QEBU1
- Report ID:** EMPLOYEE
- Report Title:** Employee Info
- \*Layout:** employee
- Report Date Selection:**
  - \*As Of Reporting Date:** Specify (dropdown), 12/31/2000 (calendar icon)
  - \*Tree As Of Date:** Use As Of Reporting Date (dropdown)
  - Override Tree As of Date if Specified in Layout**
- Output Options:**
  - \*Type:** File (dropdown)
  - \*Format:** Microsoft Excel Files (\*.xls) (dropdown)
- Run Report** button

Additional links on the right side include: [Copy to Another Business Unit / Clone](#), [Delete This Report Request](#), [Transfer to Report Books](#), [Process Monitor](#), [Report Manager](#), and [Share This Report Request](#).

By default, report requests you create are secure, meaning that they are available only to you and to any users or groups you assign. You can make a report request public and allow access to any user.

The report request security options are configurable using the PeopleTools Options page.

See [Creating Report Requests](#), [Securing and Sharing Report Requests in PIA](#), “PeopleTools Options” (System and Server Administration).

## Searching Report Requests

When you search for report requests, the search returns only the reports to which you have access. These include your own report requests, any to which you have been given access by other users, and any that are public.

## Configuring Delivery Templates

Use the nVision File / Printer Output page (NVS\_RQST\_FILE\_SBP) to configure the nVision delivery templates.

To configure nVision delivery templates:

1. Select **Reporting Tools** > **PS/nVision** > **PS/nVision Schedule Requests** from PIA.
2. Search for an existing business ID, or enter a new one.
3. Click the **Scope and Delivery Templates** link on the nVision Report Request page.

This example illustrates the fields and controls on the nVision File / Printer Output page.

**nVision File / Printer Output**

**Business Unit:** US001    **Report ID:** EARNSU01

---

**Report Scope:**  
  Enter your report scope.    [Scope Definition](#)

**Directory Name Template:**  
 Enter a directory name for your instances. Use variables to create unique directory names. If the directory doesn't exist PS/nVision will create it.  
 Examples: Q:\Reports\%SFV%- %RID%.htm, C:\%FY4% %RTT%\

**File Template:**  
 Enter a file name for your instances. Use variables to create unique report file names.  
 Examples: expense.xls, %RID%.htm, %FY4% %RTT%.xls

See [Creating Report Requests](#).

## Using the Retention Day in the nVision Web Output Page

Report retention days are the number of days a report is stored in the report repository before it is expired and purged by the purge process. Beginning from PeopleTools 8.51, you are able to set the values of retention days for:

- nVision reports at different level: System Settings page, Process Level, Process Type, and Job.
- nVision reports that have the *Web* output type when you run Report Book.
- An individual nVision report request (that has the *Web* output type) in PIA using the nVision Web Output page.
- nVision drilldown reports using the System Settings page and the process type DRILLDOWN.

See “Setting the Value of Retention Days for Drilldown Reports” in [Using the PS/nVision DrillDown on the Web](#) and “Using the Retention Day in the nVision Web Output Page” in [Setting Up Report Requests](#).

---

**Note:** The value of retention days for a Report Request is inherited by all the report instances that are created by the scope attached to the report. The value of retention days set at the Report Request level overrides the settings at the Process Type, Process, Job, and System Settings levels. The value of retention days set at the Distribution Detail page overrides the value of retention days set at the Report Request page.

---

This example illustrates the fields and controls on the nVision Web Output page (NVS\_RQST\_WEB\_SBP).

### nVision Web Output

**Business Unit:** QEBU2 **Report ID:** EMPDEPT2

---

**Report Scope:**  
 Enter your report scope. [Scope Definition](#)

**Folder Name:**  
 GENERAL

**Retention Days:**

**Directory Name Template:**  
 Enter a Folder name for your instances. Use variables to create unique Folder names. If the folder doesn't exist PS/nVision will create the folder in Report Manager.  
 Examples: Reports\%SFV%- %RID%.htm, %FY4% %RTT%\

**Content Description Template:**  
 Enter a description of the report instances for identification in Report Manager. Use variables to dynamically create the descriptions.  
 Examples: Stmt. Rev & Exp, Vacation Register - %SFV%

**Security Template:**  
 Enter user IDs or variables to give access to report instances in the Content Repository.  
 Examples: "U:VP1;U:SMITHJ", "U:VP1;R:Manager", "%DES.DEPTID.OPRID.OPRID%"

To set the value of the retention days using the nVision Web Output page:

1. Select **Reporting Tools** > **PS/nVision** > **PS/nVision Schedule Requests** from PIA.
2. Search for an existing business ID, or enter a new one.  
 The nVision Report Request page appears.
3. In the **Type** drop-down list box, select the *Web* option.
4. In the **Format** drop-down list box, select the *Microsoft Excel File (.xls)* option.
5. Click the **Scope and Delivery Templates** link.  
 The nVision Web Output page appears.

6. Enter an appropriate value in the **Retention Days** field.

## Configuring Report Request Template Options

Report request template options enable you to use PS/nVision variables or static text to specify report delivery options, including using portal folders. Using the nVision File / Printer Output page, you can also specify scope fields to personalize reports. Template options are displayed dynamically based on your output type on the PS/nVision Web Output page—only the options that you must specify for that output type appear. By combining scope and DES variables in templates, you can have different instances of the same report delivered to different email addresses, or posted to individual users in Report Manager.

To see all available template options:

1. Select **Reporting Tools > PS/nVision > PS/nVision Schedule Requests** from PIA.
2. Search for an existing business unit, or enter a new business unit.
3. Select the Advanced Options tab from the nVision Report Request page.
4. Click the **Scope and Delivery Templates - View All** link from the nVision Report Request – Advanced Options page.

The PS/nVision Report Templates page appears.

This example illustrates the fields and controls on the PS/nVision Report Templates page (NVS\_RQST\_TEMPL\_SBP).

**PS/nVision Report Templates**

**Business Unit:** QEBU1 **Report ID:** EMPLOYEE

**Report Scope:**  

**Directory Name Template:**

**File Template:** %RID%.XLS

**Language Template:**

**Email Template:**

**Content Description Template:** %RTT%

**Security Template:**

## Using Portal Folders

You can use portal folders to organize nVision report results into meaningful groups. When creating a report request with the output option of Web or Window, you can select the top level folder, and then define a subfolder where the report result will be posted. Sub-folders can be created dynamically by using

nVision variables to generate the folder names, or statically by entering the actual folder name. Sub-folders are created under the selected top level folder and can be viewed from Report Manager.

To create a subfolder in PIA:

1. Select **Reporting Tools > PS/nVision > PS/nVision Schedule Requests**.
2. Enter report request information.
3. Select the *Web* or the *Window* option as the type in the Output Options section.
4. Click the **Scope and Delivery Templates** link to display the nVision Web Output page.
5. Select the *Top Level Folder* option from the Folder Name drop-down list.
6. Enter the name of your subfolder in the **Directory Name Template** field.

You can use variables to create unique folder names. If the folder does not exist, PS/nVision creates the folder in Report Manager. For example, `Reports\%SFV%- %RID%\My Folder\Finance Reports`.

## Selecting Portal Folders

You can select portal folders from:

- Distribution Detail page.

Select report request and run report. Change Output Type to *Web* or *Window*, and then click the **Distribute To** icon.

- Scope and Delivery Templates - nVision Web Output page.
- Process Definition page.

Select **PeopleTools > Process Scheduler > Process Scheduler Processes**.

Select *Process Type* as nVision-Report and enter *NVSRUN* as the Process Name.

Select the Destination tab.

---

**Note:** Sub-folders can only be created from the Enter Delivery Options - nVision Web Output page.

---

At runtime, Process Scheduler creates the top-level folder based on the following priority order:

- Distribution Detail page.
- Enter delivery Options - nVision Web Output page.
- Process Definition page.

If a folder has not been selected on any of the above pages, Process Scheduler will use the default folder defined by the administrator.

## Related Links

“Understanding PeopleSoft Processes and Reports” (Applications User’s Guide)

- “Requesting Reports in PeopleSoft Applications” (Applications User’s Guide)
- “Checking the Status of Reports” (Applications User’s Guide)
- “Viewing Reports in Report Manager” (Applications User’s Guide)

## Copying Requests

To access the Copy Report Request page (NVS\_RQST\_BUCPY\_SBP):

1. Select **Reporting Tools > PS/nVision > PS/nVision Schedule Requests.**
2. Enter report request information.
3. Select the **Copy to Another Business Unit/Clone** link from the nVision Report Request page.

The Copy Report Request page appears.

This example illustrates the fields and controls on the Copy Report Request page. Definitions for the fields and controls appear following the example.

**Copy Report Request**

**Business Unit:** QEBU1 **Report ID:** EMPLOYEE

**Business Unit:**  **Report ID:**

Enter the Business Unit you wish to copy this nVision Report Request to.  
To clone a Report Request, select the same Business Unit and change the Report Id to a unique value.

Push the OK button when ready..

| <i>Field or Control</i>   | <i>Description</i>  |
|---------------------------|---|
| <b>Business Unit</b>      | Select a business unit to copy the report request to.<br><br>To clone the request, select the same business unit as the original request. |
| <b>Report ID Text Box</b> | Enter a new report ID to copy the report request to another business unit.<br><br>To clone the request, enter the same report ID.         |

## Security and Copying Report Requests

When you copy a secure report request, all the groups and users associated with that request are copied from the original request to the new copy:

- If you copy a report request to another existing report request, the existing request must either be public or you must have access to it.
- If you do not have access, an error message will display.
- If you copy a report request to another report request, only those users and groups with access to the original will have access to the target after the copy.
- Any users or groups who had access to the target prior to the copy but not the original are removed from the access list; if you want them to have access, you must reassign it after the copy is complete.

For example, assume users A and B have access to Report Request 1, and users A and C have access to Report Request 2. If User A copies Report Request 1 to Report Request 2, then following the copy only users A and B will have access to Report Request 2—user C no longer has access.

## Setting Advanced Options

Use the nVision Report Request – Advanced Options page (NVS\_REPORT\_RQST3) to change high level specifications for your report request.

Navigation:

1. Select **Reporting Tools** > **PS/nVision** > **PS/nVision Schedule Requests**
2. Enter report request information.
3. Select the Advanced Options tab from the nVision Report Request page.

This example illustrates the fields and controls on the nVision Report Request – Advanced Options page.

nVision Report Request   **Advanced Options**   Query Prompts

Business Unit: QEBU1   Report ID: EMPLOYEE

▼ **Advanced Report Instance Options**

Enable nPlosion If Specified In Layout

Translate Summary Ledgers to Detail

Data From Requesting B.U. Only

Time-out Minutes

▼ **Foreign Language Translation**

Enter an alternate language code for automatic translation.  
Available if alternate language features are in the layout.

Language:

[Enter Delivery Template Options - View All](#)

## Related Links

[Creating Report Requests](#)

“Using PS/nVision Reporting for Global Implementations” (Global Technology)

## Setting Query Prompts

Use the Query Prompts page (PTNVSREPORTRQST4) to view all run-time parameters of queries that are used in the layout.

---

**Note:** The Query Prompts page is available if the Report Layout uses query as data source.

---

Navigation:

1. Select **Reporting Tools > PS/nVision > PS/nVision Schedule Requests** in PIA.
2. Select an existing report or add a new one.
3. Select the Query Prompts tab.

This example illustrates the fields and controls on the Query Prompts page. Definitions for the fields and controls appear following the example.

The screenshot shows the 'Query Prompts' page. At the top, there are three tabs: 'nVision Report Request', 'Advanced Options', and 'Query Prompts'. Below the tabs, the page displays 'Business Unit: US001' and 'Report ID: MATP1'. There is a link for 'Update Parameters' and a 'Query Prompts' section. The 'Query Prompts' section has a header bar with 'Find', 'First', '1 of 1', and 'Last'. Below this, it shows 'Query Name: QE\_MATPROMPT'. There is another header bar with 'Find', 'View All', '1-2 of 2', and 'Last'. The main content is a table with two columns: 'Prompt Name' and 'Prompt Value'.

| Prompt Name   | Prompt Value |
|---------------|--------------|
| BUSINESS_UNIT | US001        |
| LEDGER        | LOCAL        |

| <b>Field or Control</b>  | <b>Description</b>  |
|--------------------------|---|
| <b>Update Parameters</b> | <p>Click to access a subpage where you can update the query prompts values with the most updated parameters of the query.</p> <p>The Update Parameters link does not appear when the user creates and saves a new query based nVision Report Layout.</p> <p>Do one of the following after creating and saving a new query based nVision Report Layout:</p> <ul style="list-style-type: none"> <li>• Run the layout through the PS/nVision client.</li> </ul> <p>OR</p> <ul style="list-style-type: none"> <li>• Run the layout without defining any Prompt Values.</li> </ul> <p>Thereafter, the Update Parameters link appears in the Query Prompt section and the user can run the layout by clicking on this link.</p> |
| <b>Prompt Value</b>      | <p>Enter prompt values that are used for mapping the parameter with the query at runtime.</p>   |

A query report that runs from PIA and requires run-time prompt input may receive the following errors:

- Missing bind value.

Indicates that the query used in the report layout is modified or a different query was used (there are mismatches between prompt details).

- Empty bind value.

Indicates that an empty value was provided for a prompt in PIA.

- Invalid bind value.

Indicates that there is an invalid value for a prompt.

## Related Links

[Submitting Report Requests](#)

---

## Submitting Report Requests

This section describes how to:

- Run reports.
- Set report distribution.

## Running Reports

Use the Process Scheduler Request (PRCSRQSTDG) page to run nVision reports.

**Note:** Changes to the nVision report request are not saved when the user clicks the **Run** button, thus enabling the user to run ad hoc reports as they would from the nVision windows client. If changes have been made to the report request and the user attempts to navigate to a different page, such as using the **Process Monitor** link, then the user is prompted to either save or discard the changes made to the report request.

Navigation:

1. Select **Reporting Tools** > **PS/nVision** > **PS/nVision Schedule Requests** in PIA.
2. Select a report ID or add a new one.
3. Click the **Run Report** button.

This example illustrates the fields and controls on the Process Scheduler Request page. Definitions for the fields and controls appear following the example.

**Process Scheduler Request**

User ID: PTDOCCD      Run Control ID:

---

Server Name: PSNT      Run Date: 06/04/2009

Recurrence:      Run Time: 11:41:53PM      Reset to Current Date/Time

Time Zone:     

| Process List                        |                |              |                |         |         |
|-------------------------------------|----------------|--------------|----------------|---------|---------|
| Select                              | Description    | Process Name | Process Type   | *Type   | *Format |
| <input checked="" type="checkbox"/> | nVision Report | NVSRUN       | nVision Report | Default | Default |

OK
Cancel

Select the *Default* option in the **Type** and **Format** fields to use the options specified in the report request, or override the request by selecting other options.

The **Type** menu includes these options:

- *Email*

Sends the report instances using email.

The mail server to deliver the reports must be specified in the Process Scheduler Configuration file.

- *File*

Saves the report instances in a specified file directory in the file server of your PS/nVision report server.

The directory of the file server must be specified in the Process Scheduler Configuration file. PS/nVision variables can be used when identifying the output destination.

- *Printer*

Sends the report instances to a network printer.

All destination printers must be set in the PS/nVision report server. The default printer is the default printer for the report server.

- *Web*

Sends each report instance to Report Manager.

The Process Scheduler server that runs the report must be associated with the distribution node to deliver the reports to Report Manager.

---

**Note:** When running the report to *Web* output type, the file template must be within 80 characters in length to prevent any errors. This limitation applies to the completely resolved filename if using variables. The same limitation applies when using the *File* output type if the *EnableDrillDownForFile* flag is enabled in the *psprcs.cfg* file. The report is successfully created, but web drilldown on the report is not possible.

---

- *Window*

Results of the process request is automatically delivered to a new browser window, and a copy is sent to Report Manager.

This option is not valid for report books, or when a scope has been included in the report request. An error message appears and the output type changes to *Default*.

---

**Note:** When you select to run the process request, a new browser window opens and displays the processing page. When processing is complete, the results is delivered to this window. If the window is closed before processing is complete, you need to access the Report Manager to view the results. The Process Scheduler server that runs the report must be associated with the distribution node to deliver the reports to Report Manager.

---

**Important!** This output type is not available if the user does not have *REN Server Report Window* permission, or there is no active REN Server cluster available for Reporting.

To grant access to the new browser window, the permission lists of the users must include full access to the Realtime Event Notification permission for Reporting Window and the *WEBLIB\_RPT* web library with full access.

---

## Running Layouts Containing Macros in OpenXML Mode

---

**Note:** OpenXML mode does not support execution of macros during report generation time, so *NvsInstanceHook* macros are not supported in OpenXML mode.

---

To run layouts that contain macros in OpenXML mode:

1. Open the layout that contains macro.

2. Press ALT+F11 to open the Microsoft Visual Basic Editor window.
3. Double-click the Thisworkbook item list in the left pane.
4. Select the *Workbook* and *Open* options from the drop-down lists provided in the right side code editor window.
5. Add the macro function that is intended to be called via NvsInstanceHook.

This example shows the macro function TestLayout\_123 in the workbook; this macro function will be executed when the report is opened in Excel:

```
Private Sub Workbook_Open()
    TestLayout_123
End Sub
```

See “Instance Hooks” in the [Using Designer Object Methods](#) section.

## Running Layouts Containing Macros in Cross Platform Mode

---

**Note:** Cross Platform mode does not support execution of macros during report generation time, so NvsInstanceHook macros are not supported in Cross Platform mode.

---

To run layouts that contain macros in Cross Platform mode:

1. Open the layout that contains macro.
2. Press ALT+F11 to open the Microsoft Visual Basic Editor window.
3. Double-click the Thisworkbook item list in the left pane.
4. Select the *Workbook* and *Open* options from the drop-down lists provided in the right side code editor window.
5. Add the macro function that is intended to be called via NvsInstanceHook.

This example shows the macro function TestLayout\_123 in the workbook; this macro function will be executed when the report is opened in Excel:

```
Private Sub Workbook_Open()
    TestLayout_123
End Sub
```

See “Instance Hooks” in the [Using Designer Object Methods](#) section.

### Related Links

- “Submitting Process Requests” (Process Scheduler)
- “Scheduling Process Requests” (Process Scheduler)
- “Defining Event Notifications and Configuring a REN Server” (Process Scheduler)
- “Defining Permissions” (Security Administration)

## Setting Report Distribution

Use the Distribution Detail page to select the recipients of your report instances separate from what you have specified in your report request. If the output type is email, you can enter email addresses, email

subject, and message. If you are entering a list of email addresses, make sure to use a semicolon (;) to separate each address from the others.

Navigation:

1. Select **Reporting Tools** > **PS/nVision** > **PS/nVision Schedule Requests** in PIA.
2. Select a report ID or add a new one.
3. Click the **Run Report** button.

The Process Scheduler Request page appears.

4. Select a report type, and click the **Distribution** link.

The Distribution Detail page appears if the output type is *web*, *window*, or *email*.

This example illustrates the fields and controls on the Distribution Detail page.

### Distribution Detail

**Process Name:** NVSRUN

**Process Type:** nVision-Report

**Folder Name:**  ▼

**Retention Days:**

**Email Only**

**Email Subject:**

**Email With Log:**

**Email Web Report:**

**Message Text:**

**Email Address List:**

**Distribute To**

| ID Type | *Distribution ID |   |     |
|---------|------------------|---|-----|
| Role ▼  | PTDOCKN          | 🔍 | + - |

**Note:** To distribute reports to a role ID or a user ID using email, all recipients must have an email address entered in their Security user profile.

## Related Links

- “Understanding User Profiles” (Security Administration)
- “Setting Up Access Profiles” (Security Administration)
- “Setting Up User Profile Types” (Security Administration)

---

## Using Report Books

This section provides an overview of report books and describes how to:

- Define report books.
- Run report books.
- Set type and output options.
- Run multiple report books.

## Understanding Report Books

You can group multiple report requests into a single report book. Report book features include:

- An interface to Process Scheduler Manager.

Using a browser, you schedule a group of reports to run using a Process Scheduler request. Your reports are executed on the server in the format that you select, and you can run the entire report book with the same output type and format without changing any individual component requests. You can also schedule your report books to run at a particular time on a regular basis.

- An effective status associated with each request in the report book.

You can set individual report requests within a report book as inactive. Inactive report requests remain part of the report book but are not run as part of a request.

- Security associated with each request in the report book.

Each individual report request in a report book has its own security setting that allows it to be accessed by specific users and groups or by the public.

- A method for individual report requests to inherit dates from the report book.

You can run an entire report book using the same as of date, without changing any individual component requests.

- Multiple nVision sessions can be scheduled on a single report server.

Each nVision session is associated with its own Excel executable. This enables you to maximize use of your report server without requiring multiple report servers for multiple report books.

- Robust batch processing of message logging.

You can generate an entire set of reports without the process being interrupted due to an error condition.

**Note:** Date and time variables are resolved based on the calendar being used by the PS/nVision report server that runs the report.

## Defining Report Books

Use the Report Books page (IC\_NVSBK) to create a report book. Before creating a report book, make sure you have report requests defined for all the reports you want to include in the book. The report book is a list of requests, not a substitute for the request. You might also want to review the requests you plan to use to ensure they use the desired scope and layout, and ensure that you have access to all the reports you want to include in the report book.

Navigation:

1. Select **Reporting Tools** > **PS/nVision** > **PS/nVision Schedule Books**.
2. From the Define Report Book page, search for an existing report book or create a new one.

This example illustrates the fields and controls on the Report Book page. Definitions for the fields and controls appear following the example.

### Report Book

Run Control ID: PTDMO [Report Manager](#) [Process Monitor](#) Run

**Run Parameters**

As Of Date:  ▼

Tree Effective Date:  ▼  Ignore Runtime Errors



Retention Days:

| Report Requests |                                      |   |  |                                     |   | Personalize   Find   View All      First 1-2 of 2 Last |  |
|-----------------|--------------------------------------|---|--|-------------------------------------|---|--|--|
| Seg             | Business Unit                        | Report ID                               | View   | Run                                 |   |  |  |
| 1               | <input type="text" value="QEBU2"/> 🔍 | <input type="text" value="EMPSCOPE"/> 🔍 | <span style="background-color: #f0f0f0; padding: 2px 5px;">View</span> | <input checked="" type="checkbox"/> | + | -  |  |
| 2               | <input type="text" value="QEBU2"/> 🔍 | <input type="text" value="EMPDEPT2"/> 🔍 | <span style="background-color: #f0f0f0; padding: 2px 5px;">View</span> | <input checked="" type="checkbox"/> | + | -  |  |

Select All
Deselect All
Flip All

| <b>Field or Control</b> | <b>Description</b>  |
|-------------------------|---|
| <b>As Of Date</b>       | <p>Available options are:</p> <ul style="list-style-type: none"> <li><i>Default:</i> To use the As Of Date from the report request.</li> <li><i>Today's Date:</i> To use the current date for the report.</li> <li><i>Business Unit Reporting Date:</i> To use the date specified for the business unit.</li> <li><i>Specify:</i> To enter the date you want to report on.</li> </ul> |

| <b>Field or Control</b>      | <b>Description</b>   |
|------------------------------|--|
| <b>Tree Effective Date</b>   | <p>Available options are:</p> <ul style="list-style-type: none"> <li>• <i>Default</i>: To use the specified Tree Effective Date from the report request.</li> <li>• <i>Specify</i>: To enter the date you want to report on.</li> <li>• <i>Use As of Reporting Date</i>: To create the report based on the As Of Reporting Date that you specified in the report.</li> </ul>   |
| <b>Ignore Runtime Errors</b> | <p>Select to keep the entire Report Book from stopping if one of the reports encounters an error.</p> <hr/> <p><b>Note:</b> In such a case, the completion status will be <i>Success</i>, even though one or more reports may have had errors.</p> <hr/>   |
| <b>Retention Day</b>         | <p>If the report has the output type set to <i>Web</i>, enter the number of retention days.</p> <hr/> <p><b>Note:</b> This field is not available when the output type of the report is not <i>Web</i>.<br/>The value of retention days set at the Distribution Detail page overrides the value of retention days set at the Report Book page.<br/>The value of retention days set at the Report Book level overrides the value set at the individual report request that are attached to the Report Book. When the value of retention days is not set at the Report Book level, the value set at the Report Request level is used.</p> <hr/> <p>See “Using the Retention Day in the nVision Web Output Page” in <a href="#">Setting Up Report Requests</a>.</p> |
| <b>View</b>                  | <p>Click to launch another browser window displaying the report request.</p>   |
| <b>Business Unit</b>         | <p>Select the business unit of the report requests for this report book.</p> <p>To reorder your entries, insert or delete rows as necessary.</p>   |
| <b>Report ID</b>             | <p>Select the report ID of the report requests for this report book.</p> <p>To reorder your entries, insert or delete rows as necessary.</p>   |
| <b>Run</b>                   | <p>Click the <b>Run</b> button for all reports you want to run when this book is requested.</p> <p>For example, you might define a book of reports to be run at month end, and include a report that is only run quarterly, but select its <b>Run</b> button indicator only at quarter end.</p>  |

| <b>Field or Control</b>   | <b>Description</b>   |
|---|--|
|  | Click the <b>Add</b> icon to add a new blank row, and you are enable to enter a new report request.<br><hr/> <b>Note:</b> You cannot add a report request to a report book if you do not have access to the report book.   |
|  | Click the <b>Delete</b> icon to delete the current row.  |
| <b>Select All</b>   | The Select All button selects all reports in the Report Book to be “Run”, i.e. for all the Report Requests on the Report Book, all the Run check boxes are selected.   |
| <b>Deselect All</b>   | The Deselect All button deselects all reports in the Report Book to be “Run”, i.e. for all the Report Requests on the Report Book, all the Run check box are deselected.   |
| <b>Flip All</b>   | The Flip All button flips the status of all the Reports in the Report Book to be “Run”, i.e. if the current status of the Run check box is set as “True” (selected), then by clicking on the Flip All Button, the Run check box is set to “False” (deselected) and vice-versa. |

## Running Report Books

Access the Report Book page (PRCSRQSTDLG) by selecting **Reporting Tools > PS/nVision > PS/nVision Schedule Books**. In the Report Book page, you can run all the reports in a group or select specific reports by selecting their check boxes in the Run column.

---

**Note:** If the report book contains secured report requests to which you do not have access, these report requests appear inactive and you are not able to select them.

---

Report books are run through Process Scheduler Request page. However, when the report begins to run, you are returned to the Report Book page. If you want to check the status of your job, click the Process Monitor link. If you want to view a list of reports that you have access to, click the Report Manager link.

If you run all report requests in a report book that contains secured report requests, only those requests to which you have access are run. If you run reports that you do not have access to, those processes are not success and an error message appears in the error log.

### Related Links

[Securing and Sharing Report Requests in PIA](#)

“Submitting Process Requests” (Process Scheduler)

“Scheduling Process Requests” (Process Scheduler)

## Selecting Type and Output Options

To select type and output options for nVision reports:

1. Select **Reporting Tools > PS/nVision > PS/nVision Schedule Books**.
2. From the Define Report Book page, search for an existing report book or create a new one.
3. Click the **Run Report** button.
4. Select the *Default* option in the **Type** and **Format** menus to use the options specified in the report book, or override the report book by making new choices.

See [Running Reports](#).

## Running Multiple Report Books

To define your process server to handle multiple report book jobs:

1. Select **PeopleTools > Process Scheduler > Server**.
2. Search for the server name that you are using for your report books.

In general, your server name is PSNT. However, a list of available servers appears for your selection.

3. In the process type named *nVision-Report Book*, ensure that the **Max Concurrent** field is set to the required number.

This setting allows multiple report book jobs to run concurrently.

---

## Using the PS/nVision DrillDown on the Web

This section provides an overview of drilldown on Microsoft Excel reports and describes how to:

- Register DrillDown layouts.
- Use DrillDown.
- Set the value of retention days for nVision drilldown reports.

## Registering DrillDown Layouts

All DrillDown layouts are created in the Windows version of PS/nVision, but can be used in both Windows and a browser.

When you register a DrillDown layout, you associate it with a Process Scheduler server. You can have a set of DrillDown layouts specific to financial applications registered to a Process Scheduler server that is dedicated to financial applications and have a set of DrillDown layouts specific to Human Resources registered to its own Process Scheduler server. To make a DrillDown layout available to multiple Process Scheduler servers, register the DrillDown layout on each server. When you drill down, you can select a report server to run the report.

To register a DrillDown Layout:

1. Select **Reporting Tools > PS/nVision > PS/nVision Register Drilldown.**
2. Enter a new server name, or use the **Search** button to select one from a list of available servers.

The Drilldown Layouts page appears.

3. Add a new row to the Drilldown Layouts section.
4. Enter the name of the DrillDown layout and its description.

The name of the layout must match the name of the DrillDown layout that you created in Microsoft Windows.

5. Click the **Save** button.

This example illustrates the fields and controls on the DrillDown Layouts page.

### Drilldown Layouts

**Server Name:** PSNT      **Description:** NT Server Agent

| Drilldown Layout | Description                 |   |   |
|------------------|-----------------------------|---|---|
| APVchr           | AP Detail                   | + | - |
| ActBus           | Account by Business Unit    | + | - |
| ActDep           | Account by Department       | + | - |
| ActPer           | Account by Period           | + | - |
| ActPrd           | Account by Product          | + | - |
| ActVar           | Accounts by Actuals/Budgets | + | - |
| BUSPER           | Business Unit by Period     | + | - |
| BusAct           | Business Unit by Accout     | + | - |

## Related Links

[Using DrillDown Layout Formats](#)

[DrillDown and Summary Ledger](#)

“Setting Report Distribution” (Process Scheduler)

## Using DrillDown

After a report has been run as web, window, or file output, you can open it and run DrillDown on specific amount fields.

To drill down on a report that will be run as *file* output, you must first set the Process Scheduler configuration for the nVision - EnableDrillDownForFile option as *1*. The default value is *0*, which means drilldown is disabled.

If you drill down on a report that has been run to file output, and you are not logged onto a PeopleSoft domain—or the PeopleSoft web server domain that you are logged onto is not the web server domain of the report server—and your ByPassSignOn Web server configuration property is set to *True*, then you will not be able to access the drilldown results. The system will return the login page with an error message indicating that your default password is not authorized.

When you use http/https as the transfer protocol (in report node), there is an additional criterion that needs to be met to enable drill down from a report sent to file output. The security template of the parent report request should be set to specify which Users or Roles will have the authorization to be able to perform a web drilldown on the report. If the Security Template is blank, then only the user that ran the parent report will be able to perform a web drilldown on it. When using file output type, you can access the security template by going into the advanced tab of the report request, and clicking on the **Enter Delivery Template Options - View All** link.

You can use the web drilldown from an Excel report (using the DrillToPIA add-in) if the report sheet name had spaces in it. However, do not use special characters such as ‘ , ’ , < , > , [ , ] , / , \ , \* , ? .

A PeopleTools upgrade may cause the web server domain name, port number, or servlet path to be required to access web server resources in the PeopleSoft PIA to change. As a result, PS/nVision drilldown operations on reports that were created prior to upgrade would fail, primarily because drilldown links are by design hard-coded into PS/nVision reports. This utility is located in UpdateNvsDrill.xls file. Use the simple search and replace utility that is provided to replace old links with new ones. This Microsoft Excel macro is located in the PS\_HOME\Excel directory.

See “Understanding the Sections in PSPRCS.CFG File Based on Operating Systems” (Process Scheduler).

## Performing nVision Drilldowns on Microsoft Excel Reports Using DrillToPIA Add-in

To perform nVision drilldown on a Microsoft Excel report using the DrillToPIA add-in:

1. Open the report in Report Manager.
2. Highlight the field that you want to drill on, and click the Drill menu when the cell is selected.

If the selected cell is not drillable, you receive a warning message that says: *DrillDown only works at the intersection of an amount row and column.*

The Run Drilldown page appears in a new browser window.

This example illustrates the fields and controls on the Run Drilldown page.

## Run Drilldown

**Report Instance:** 61\_71

**Row:** 9 **Column:** 6

**\*Type:**  ▼

| Available Drilldown Layouts    |              |               |
|--------------------------------|--------------|---------------|
| Description                    | *Server Name | Run Drilldown |
| AP Detail                      | PSNT ▼       | Run Drilldown |
| Account by Business Unit       | PSNT ▼       | Run Drilldown |
| Account by Department          | PSNT ▼       | Run Drilldown |
| Account by Period              | PSNT ▼       | Run Drilldown |
| Account by Product             | PSNT ▼       | Run Drilldown |
| Accounts by Actuals/Budgets    | PSNT ▼       | Run Drilldown |
| Business Unit by Period        | PSNT ▼       | Run Drilldown |
| Business Unit by Account       | PSNT ▼       | Run Drilldown |
| Business Unit by Department    | PSNT ▼       | Run Drilldown |
| Business Unit by Product       | PSNT ▼       | Run Drilldown |
| Business Unit by Actuals/Budge | PSNT ▼       | Run Drilldown |
| Department by Account          | PSNT ▼       | Run Drilldown |
| Department by Business Unit    | PSNT ▼       | Run Drilldown |

3. Select output type *Window* or *Web* from the Type drop-down list box.
4. Select the server that you want your report to run on.

The **Server** drop-down list box only includes the servers that have the associated layout registered with them.

5. Click the **Run Drilldown** button for the drilldown layout that you want to use.
6. If the nVision report instance uses the queries that contain run-time prompts, enter the prompt values.

**Note:** If an nVision report instance is generated with one or more queries as data source, and if those queries require prompt inputs, then performing drilldown on this nVision report instance also requires query prompt inputs.

If the prompt values are blank or invalid, an error message appears. If so, you can close the error message and reenter the prompt values.

You can also enter the query prompt values when you perform nVision drilldowns using nVision client. See [Using DrillDown](#).

7. Click the **OK** button on the prompt window.

8. Note that:

- If the output type is Web, the Report Manager - Report List page appears again.
- If the output type is Window, the result of the drilldown is automatically delivered to a new browser window, and a copy is sent to Report Manager.

When you select to run the drilldown, a new browser window opens and displays the processing page. When processing is complete, the results of the drilldown are delivered to this window. If the window is closed before processing is complete, you need to access Report Manager to view the results.

9. On the Report Manager – Report List page, click the **Refresh** link.

After your drilldown runs, it appears as a report in your report list. Drilldown report descriptions always include *DR*, the parent process instance number, and the original report description.

10. Click the **Report** link for the drilldown to display the Report Index page.

11. Click the link for the drilldown to see the drilldown results.

Web-based drilldowns *persist*. They are files that permanently exist on your report server, not just temporary files as in the Windows client. Drilldown instances in the Web can be viewed and distributed in the same manner as any other report that you run on the browser.

## Setting the Value of Retention Days for Drilldown Reports

Retention days for all drilldown reports can be defined at the DRILLDOWN process level. Setting the value of retention days for each individual drilldown report is not available because:

- A PS/nVision drilldown report does not have a report definition of its own.
- Commonly in the PIA, only a list of drilldown layouts is available to end users.
- End users can set the value of retention days for each process request using the Distribution Detail page.

## Performing nVision Drilldowns Using nVisionDrill VSTO Add-in

To perform nVision drilldown on an Excel report using the nVisionDrill VSTO add-in:

1. Generate the parent report to perform the drilldown.
2. Open the parent report from the nVision Instance folder.
3. Highlight the field that you want to drill on for an Excel report.
4. Expand the Add-ins tab in the Ribbon bar to view the nVisionDrill VSTO menu.

---

**Note:** The nVisionDrill VSTO menu appears under the Add-ins tab only if nVisionDrill add-in was successfully installed.

---

5. With a drillable cell in the report selected, click the nVisionDrill VSTO menu.

A login page appears.

---

**Note:** For nVision drilldown to work in VSTO mode, SSL configuration is required. This means that the URL should have https instead of http. Drilldown can be done on those reports that are previously generated using the https url.

---

6. Enter a valid PeopleSoft user ID and password.

If the entered ID and password are valid, a list of drilldown layouts appears.

This example shows the list of drilldown layouts from within the nVisionDrill menu.

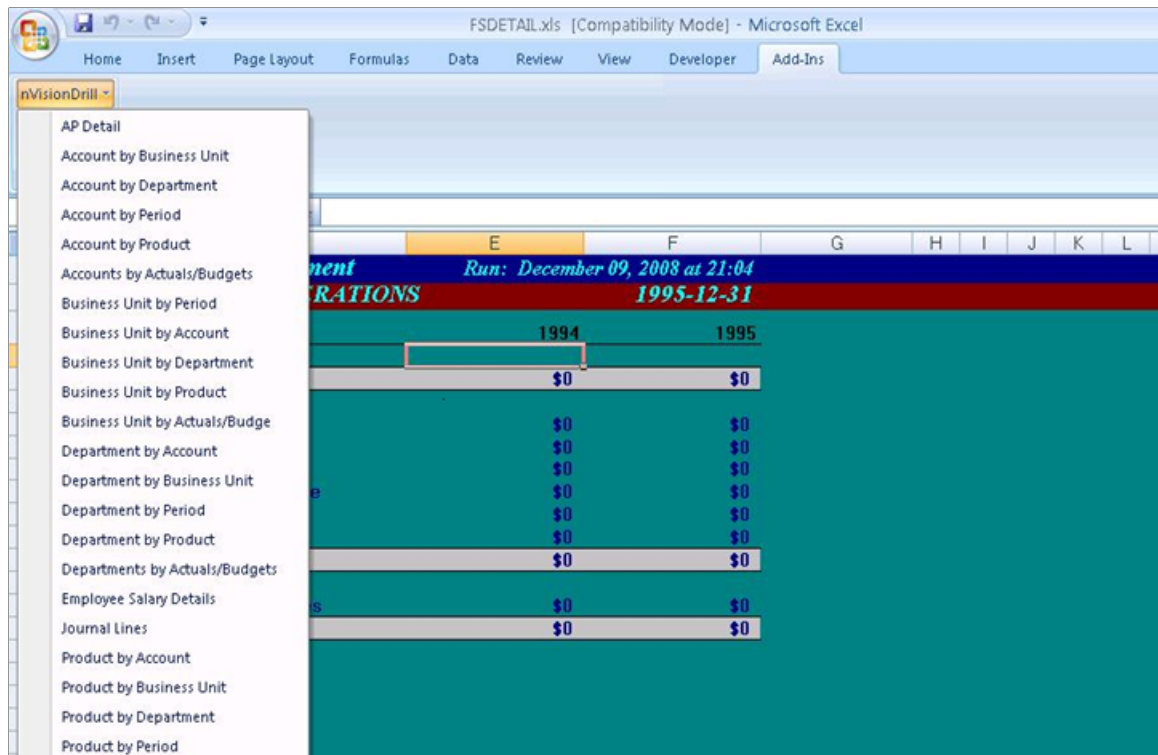

---

**Note:** When you click the nVisionDrill menu, the status of the Process Scheduler server appears to inform you whether the Process Scheduler server is running. If the Process Scheduler server is down, a message appears warning: *Process Scheduler is down. nVision Drilldown is not possible at this time.*

---

7. Select an appropriate layout option from the layout list.

The status bar displays the message: *nVision drilldown has been submitted.*

The nVisionDrill runs and a Save As dialog box appears.

---

**Note:** If the selected cell is not drillable, you receive a warning message that says: *nVision drilldown ran to Error. Check Server log for more details.*

After you submit a drilldown request, the drilldown process gets submitted at the server. The status of this drilldown process is polled at specific time intervals. This polling interval value (PollingTime) is configurable in the nvsdrill.cfg file, which is located in the add-in installed directory. The polling interval value is read once during the opening of the Excel file.

---

8. Click the **Save** button to save the generated drilldown report.

**Note:** You must save the generated drilldown report before it is opened in a new Microsoft Excel window.

This example shows an nVision drilldown report in Microsoft Excel window.

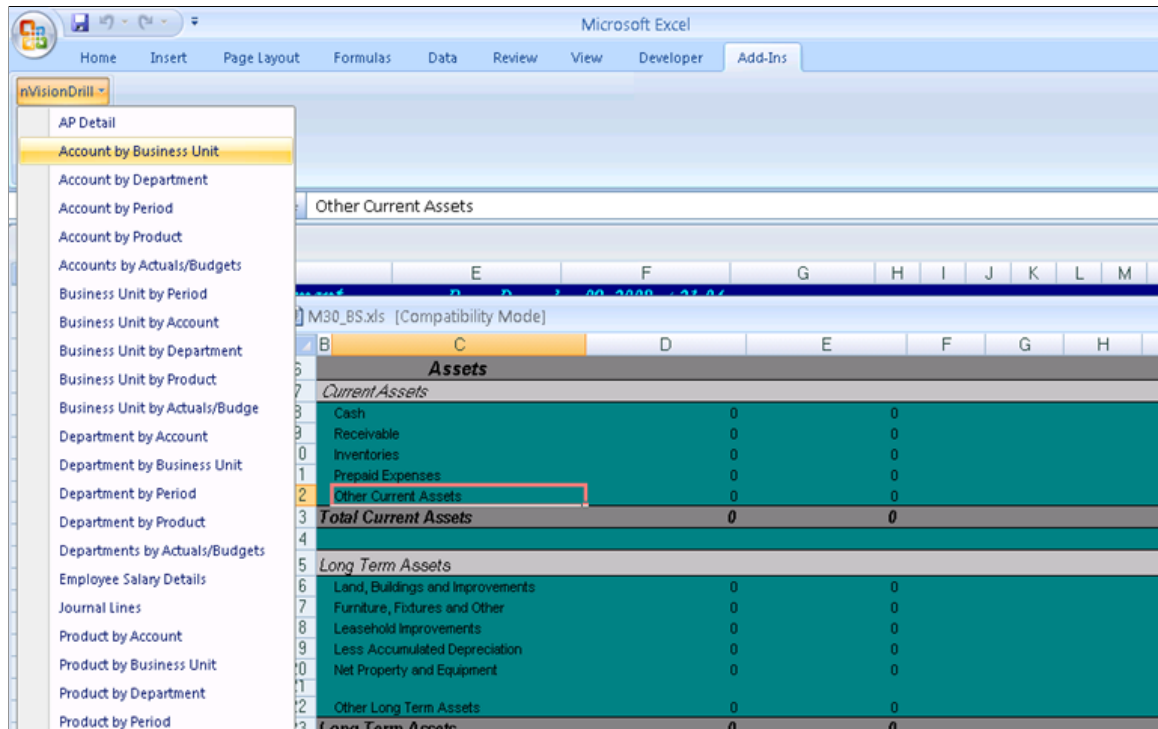

**Note:** By default, the drilldown report is opened in a Microsoft Excel window. You can view the drilldown report in real-time while remaining in Microsoft Excel. The report is also posted to the Report Manager.

## Error Messages While Performing Drilldown on a Report

When you are performing a PS/nVision drilldown on an Excel reports, the system may display the following error messages:

- DrillDown only works at the intersection of an amount row and column.
- No criteria; cannot drill down from this cell.
- DrillDown is not allowed for this file. It is generated with no DrillDown Option. To enable the DrillDown, re-run the report with EnableDrillDownForFile = 1 in the Process Scheduler Configuration File.
- DrillDown can only be performed on a Matrix report.
- nVision drilldown failed. Check Server log for more details.
- nVision drilldown ran to No Success. Check Server log for more details.
- nVision drilldown ran to Error. Check Server log for more details.

- Error retrieving drilldown report.
- Drilldown report is not saved.
- Error opening drilldown report.
- Your User ID and/or Password are invalid.
- Error while retrieving drilldown options.
- Error while Authorization. Try logging in again.
- Communication is secured using SSL. Import Certificate and try again.
- nVision drilldown has been submitted.
- Problem occurred during drilldown. Check Server log for more details.
- Drilldown execution in progress.
- Retrieving drilldown report.
- Process Scheduler is down. nVision Drilldown is not possible at this time.

---

## Running Specific PS/nVision Reports

This section describes how to run specific PS/nVision reports from an application page using the options:

- nVision Run API
- QUICKNVISION REST Service

### Using nVision Run API

To run specific nVision reports from an application page, you have the option to use nVision Run API on a button or hyper link instead of navigating through multiple nVision pages under Reporting Tools (**Reporting Tools > PS/nVision > PS/nVision Schedule Requests**).

The API can be applied on a page control, such as, a button or hyper link, by passing Report ID and Business Unit values. This API abstracts the nVision Run method so that data is secure.

### Verifying User Permission

The user permission to run a report is verified by the nVision\_IsAuthorised API. Based on the permission, the page control such as, button or hyperlink, is enabled or disabled. If an unauthorized user tries to run this report, an authentication failed error message appears.

The following example, where Business Unit is *US001* and Report ID is *FSDETAIL*, shows the syntax and application package details of nVision\_RunReport and nVision\_IsAuthorised APIs.

```
import PT_NVISIONPKG:nvision_Runreport;
import PT_NVISIONPKG:nVision_IsAuthorised;
Local boolean &ret;
```

```

ComponentLife PT_NVISIONPKG:nvision_Runreport &nVis;
ComponentLife PT_NVISIONPKG:nVision_IsAuthorised &nVis1;
&nVis1 = create PT_NVISIONPKG:nVision_IsAuthorised();
&nVis = create PT_NVISIONPKG:nvision_Runreport();
&ret = &nVis1.nVisionIsAuthorised("US001", "FSDETAIL");
If &ret = True Then
    &nVis.nvis_Run("US001", "FSDETAIL");
End-If;

```

---

**Note:** To run the report, you must apply the nVision\_RunReport and nVision\_IsAuthorised APIs on the page control.

---

## Using QUICKNVISION REST Service

To run specific nVision reports from an application page, you have the option to use QUICKNVISION REST service.

The REST service format is: *http://<Server name>:<Port>/PSIGW/RESTListeningConnector/<DBName>/QUICKNVISION.v1/<BusinessUnit>/<ReportID>*.

To run an nVision report:

1. Select **PeopleTools > Integration Broker > Integration Setup > Services**, and search for the REST service QUICKNVISION.
2. Access the operation QUICKNVISION\_POST.v1 on the **Operation** tab.
3. Select the URL from the **REST Base URL** field, and append the Business Unit and Report ID values.

For example, *http://abc.oracle.com:8000/PSIGW/RESTListeningConnector/T57RAKR2/QUICKNVISION.v1/US001/FSDETAIL*, where US001 is the Business Unit and FSDETAIL is the Report ID.

For the report to run successfully, a report with the given business unit and report ID should exist.

4. Enter the basic authentication details. If the user is not authorized to run the selected nVision report, an authorization failed message is displayed.

---

**Note:** To run an nVision report, you must add permission list PTPT1000 to the user role.

---

# Running PS/nVision Reports in the Microsoft Windows Client

---

## Creating Report Requests

This section describes how to:

- Create requests.
- Open existing report requests.
- Delete report requests.

---

**Note:** Most end users create report requests, run and distribute reports, and view reports using Report Manager on the Web in the PeopleSoft Pure Internet Architecture. Topics in this section are used by developers who use the Windows environment to perform the same tasks.

---

### Related Links

[Understanding Report Scopes](#)

[Defining Scopes](#)

[Understanding PS/nVision Reporting on the Web](#)

[Configuring PS/nVision on the Web](#)

[Setting Up Report Requests](#)

## Creating Requests

Before you can run a PS/nVision report, you must create a corresponding report request. Each report request is a collection of report-specific information such as request name, report title, associated layout, scope, and so on. In a report request, you can use the Scope feature to create multiple instances of a report from a single request.

Use the PeopleSoft nVision Report Request dialog box to enter information about the report that you're running, such as what layout to use, what time period to report on, and where to store the reports. This information makes up a report request, which you can save and reuse.

To access the PeopleSoft nVision Report Request dialog box:

1. Open nVision client by selecting **Start > Programs > PeopleTools 8.x > PS/nVision**.
2. Select **nVision > Report Request** from the nVision menu.

The PeopleSoft nVision Report Request dialog box appears.

**Note:** You can specify effective date for trees either when you run the report request or when you define criteria.

This example illustrates the fields and controls on the PeopleSoft nVision Report Request dialog box in Windows.

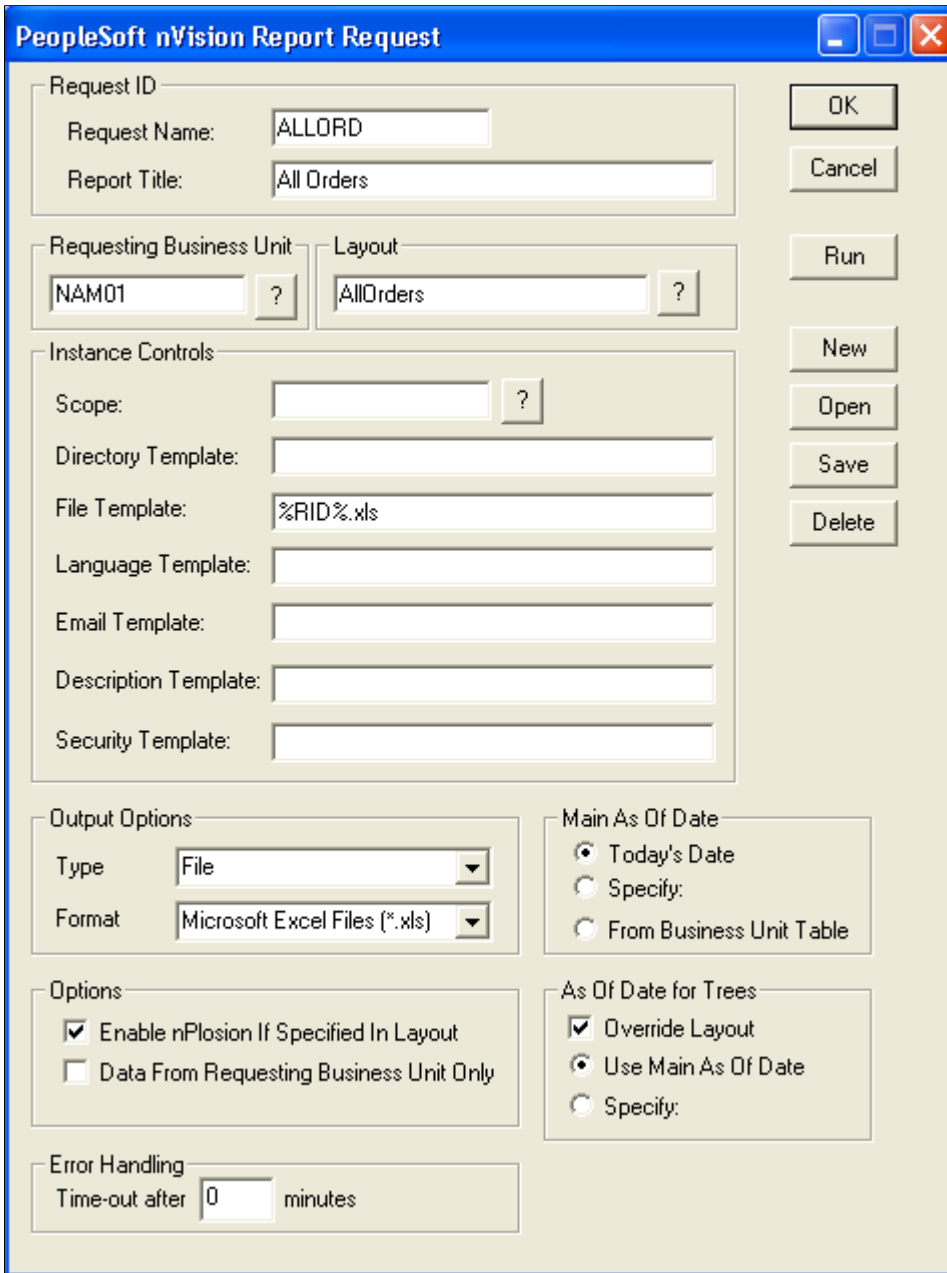

While you run the report, its layout file is opened in read-only mode to protect the layout from accidental changes while the report runs. To modify the layout file, open the layout from the nVision menu or from the Open Layout button on the NVSUSER home page.

**Note:** Microsoft Excel does not support the following characters in its file names: < > ? [ ] : | or \*. PS/nVision has an additional restriction of not allowing the characters of / \ “ or ‘ in report names and not allowing % or a space at the beginning of report names.

Report requests that are created in PS/nVision for Windows are public. If you want to create secured report requests, you must use PS/nVision on the web, where requests are secured by default.

## Request ID

| <i>Field or Control</i>         | <i>Description</i>   |
|---------------------------------|--|
| <b>Request Name</b>             | <p>Enter a name to identify your report request.</p> <p>By naming and saving report requests, you can retrieve all the information of a report request the next time you run the report. You can use the %RID% variable within a layout to display name of a report instance.</p>  |
| <b>Report Title</b>             | <p>Enter a description to describe your report request.</p> <p>Use the %RTT% variable within a layout to display this title on a report instance.</p>  |
| <b>Requesting Business Unit</b> | <p>Enter the business unit that the report belongs to.</p> <p>You can retrieve data for this business unit alone or for several business units. Use the %RBN% variable on your layout to show the description of the requesting business unit on a report instance. To show the value of the requesting business unit, use the %RBU% variable.</p> |
| <b>Layout</b>                   | <p>Select the report layout (the XNV file) to use for this report.</p> <p>The directory for saving layouts is found in Configuration Manager on Windows and in Process Scheduler Configuration file on Web. Use the %LYN% variable on your layout to show the layout name on a report instance.</p>  |

**Note:** The table that stores nVision report definitions (PS\_NVS\_REPORT) now has a related language table, so the description of the reports are translatable.

## Instance Controls

Most report layouts enable you to create multiple instances of a report using a single report request. For example, you might run three instances of an expense report that differ only in the division they report on.

**Note:** If you enter a list of values in any template field, make sure to use a semicolon to separate each item.

| <b>Field or Control</b>   | <b>Description</b>   |
|---------------------------|--|
| <b>Scope</b>              | <p>Select a scope definition to specify the data each report instance includes and how many instances PS/nVision creates.</p> <p>For example, you can select a scope to create multiple instances of a report based on specific values for a field, such as instances for business unit, department, or product. Use the %SCN% variable on your layout to show the scope name on the report instance.</p> <p>See <a href="#">Adding Variable Criteria</a>.</p> <p>If you create multiple report instances, you must ensure that each instance has a unique directory or file name, or each new instance will overwrite the previous one. Use variables in the <b>Directory Template</b> and <b>File Template</b> fields to have PS/nVision generate directories or names on each instance it creates. For example, if you are running a report for multiple business units, you can have the business unit appear as part of the file name, or you can opt to save each instance into a different directory.</p>   |
| <b>Directory Template</b> | <p>Enter a directory name from the nVision report server for your instances.</p> <p>Use variables to create unique directory names. If a directory does not exist, PS/nVision creates one. If this field is blank, PS/nVision on Windows uses the directory specified in the Report Instance path setting in Configuration Manager. PS/nVision on the Web uses the path specified in Process Scheduler Configuration file.</p> <p>For example, you can use <code>\\&lt;servername&gt;\Directory 1\Directory 2</code>, but you have to make sure all the subdirectories under the servername (which comes from the combination of directory template and file template) are accessible from your client machine. Examples are:</p> <ul style="list-style-type: none"> <li>• <code>Q:\Reports\%SFV%-%RID%.htm</code></li> <li>• <code>C:\%FY4%%RTT%</code></li> </ul> <p>Include the %BUV% and %APA% variables to yield directories that indicate the business unit and as of accounting period for which the report was produced. Example: <code>C:\User\nVision\%BUV% and %APA%</code>.</p> <p>A directory for each business unit and as-of date combination is created.</p> |

| <b>Field or Control</b>  | <b>Description</b>   |
|--------------------------|--|
| <b>File Template</b>     | <p>Enter the file name to give report instances.</p> <p>You can include PS/nVision to dynamically create file names at runtime. The %RID% variable instructs PS/nVision to use the Request Name value as the file name, with the appropriate extension according to your output format. Use the %IFN% variable to use the file name in the layout. If this field is blank, PS/nVision uses the layout name as the default file name.</p> <p>For example:</p> <ul style="list-style-type: none"> <li>• <i>expense.xls</i></li> <li>• <i>%RID%.htm</i></li> <li>• <i>%FY4%%RTT%.xls</i></li> </ul> <p>The instance counter variable %ICT% causes each instance to be consecutively numbered. For example, for a report named OPSUM, the file template %RID%%ICT% creates files named OPSUM1.XLS, OPSUM2.XLS, and so on for each instance generated by this report request.</p> |
| <b>Language Template</b> | <p>Enter an alternate language code for automatic translation on the report instances.</p> <p>This option is available only if alternate language design features are included in the layout design. If you are applying a scope to the report request, you can enter a string containing one or more PS/nVision variables (like the <b>File Template</b> and <b>Directory Template</b> fields).</p> <p>For example:</p> <pre>ENG%DES . DEPTID . LANGUAGE_CD . LANGUAGE_CD%</pre>  |

| <b>Field or Control</b>     | <b>Description</b>  |
|-----------------------------|---|
| <b>Email Template</b>       | <p>Enter a list of email addresses or use variables to specify who receives report instances.</p> <p>This template has no default. You must have values in this field if your output type is EMAIL, or the instances will not be sent. If you use role or users in your email templates, the email addresses associated with these users are entered into their user profiles in Security.</p> <p>You can enter up to 254 characters in this field. If you have a long list of email addresses, use the role or user variables. To enter a list of email addresses, separate each address with a semicolon.</p> <p>For example:</p> <ul style="list-style-type: none"> <li>• <i>username@xxx.com</i></li> <li>• <i>username1@xxx.com;username2@yyy.com</i></li> <li>• <i>%DES.DEPTID.EMAILID.EMAILID%</i></li> <li>• <i>R:Manager ;U:SMITHJ</i></li> </ul> <hr/> <p><b>Note:</b> If you want to email a multi-tab spreadsheet or a spreadsheet with an image (a graph, pivot table, or an embedded image), you must run the report with an output type of .XLS or distribute it through the Web using Report Manager.</p> |
| <b>Description Template</b> | <p>Enter a description of the report instances for identification in Report Manager, or use variables to create the descriptions dynamically. For example:</p> <p>Stmt. Rev &amp; Exp or Vacation Register%SFV⇒<br/>%</p>   |
| <b>Security Template</b>    | <p>Enter user IDs, role IDs, or variables to give specific users access to report instances in Report Manager.</p> <p>To authorize a user ID, enter a <i>U</i> followed by a colon before the user ID. To authorize a role, enter an <i>R</i> followed by a colon before the role ID. If this field is blank, the report is automatically distributed to the user running the report. For example:</p> <p>R:VP1U:SMITHJ%DES.DEPTID.OPRID.OPRID%</p>   |

## Output Options

| <b>Field or Control</b> | <b>Description</b>   |
|-------------------------|--|
| <b>Type</b>             | Select between sending output to a file or sending it to a local printer.<br><br>Email, window, and web output types are not valid selections unless you are running a report from your browser. |
| <b>Format</b>           | Select an appropriate file format.   |

## Main As Of Date

Set the reporting period for this report. Many report layouts associated with PeopleSoft Financials applications report on data over a given accounting period, such as the current quarter or year-to-date. PS/nVision uses the main as of date to determine the meaning of any TimeSpans used in the layout. The date you select is compared to the calendar to determine the current period, and TimeSpans are then evaluated relative to that period. Available options are:

| <b>Field or Control</b>         | <b>Description</b>  |
|---------------------------------|---|
| <b>Today's Date</b>             | Select this option to use date of today.                                    |
| <b>From Business Unit Table</b> | Select this option to use the date as specified on the business unit table. |
| <b>Specify</b>                  | Select this option to specify another date for the report.                  |

## Options

| <b>Field or Control</b>                       | <b>Description</b>  |
|---|---|
| <b>Enable nPlosion If Specified In Layout</b> | Select this option to enable nPlosion.<br><br>This specification overrides the specification in layout. If you do not select this option, nPlosion is disabled—even if the layout definition uses it. |

| <b>Field or Control</b>                        | <b>Description</b>  |
|--|---|
| <b>Data From Requesting Business Unit Only</b> | <p>Select this option to make the report reflect data from the requesting business unit only. nVision will add the WHERE criteria for requesting business, either from layout or scope definition, <i>if</i> there is no any explicit BUSINESS_UNIT criteria. This option is selected by default.</p> <p>Clear this option for PS/nVision to extract data for all business units with the criteria specified within the layout unless the business unit is specified in report scope.</p> |
| <b>Translate Summary Ledgers to Detail</b>     | <p>Select this option to retrieve data from the underlying detail ledger whenever you specify a summary ledger in a layout.</p> <p>This option is not available if the Selected Summary ChartField Nodes method was used in the layout to retrieve summary ledger balances.</p>   |

## As Of Date for Trees

Use these options to specify trees that are in effect as of the reporting date by selecting the Use Main As Of Date option. Or, you can specify a different date and use a set of trees in effect on that date. For example, you may have a reporting structure set to go into effect in three months (remember that trees are effective-dated). You can select to run the report using the new tree structure by specifying the future effective date of the new tree.

The **Override Layout** option enables you to define layout-specified As of Date criteria, if any. This **Override Layout** option is selected by default, and:

- If this **Override Layout** option is selected, the As of Date for trees specified in layout definition is overridden when you run report request.
- If this **Override Layout** option is cleared, the As of Date for trees specified in layout definition is used.
- If this **Override Layout** option is cleared and the As of Date for a tree is not specified during the time of layout definition, the As of Date for the tree from Report Request is used.

See [Selecting Filter Criteria Options](#).

## Error Handling (Time-out)

Use this option to specify the maximum processing time for this process and enable the system to kill the process if processing exceeds this time. The default value is specified in the Process Definition. If a nonzero value is specified in the report request, that value is used—if the report request's value is zero, the value from the Process Definition is used. If no value is specified in the Process Definition, a default value of 15 minutes is used.

## Related Links

[Selecting Filter Criteria Options](#)

[Adding Variable Criteria](#)

[Using TimeSpans](#)

[Defining Scopes](#)

[Defining nPlosion Criteria](#)

[Defining nPlosion Defaults](#)

[Using Configuration Manager](#)

[Securing and Sharing Report Requests in PIA](#)

## Applying Scopes to Your Reports

A report scope enables you to create multiple instances of a report using a single report layout and report request. Using a scope, each report instance is generated with data specific to an individual field value (such as a business unit or department) or to a group of values (such as a tree node summarizing all sales departments). In this way, each report instance can share the same layout, while containing data unique to these field values.

For example, if you have a report request with a scope that produces one income statement for each division in the company, you could use a scope variable in the Email template to have each divisional report emailed to VP of that division. Alternatively, you could make each VP's report available in Report Manager by using a scope variable in the Security template.

Scope variables are used in the Email and Security templates the same way that you use them to create unique file names with the File template or directory names with the Directory template in your report request. The Scope Descriptive Variable (%DES%) is used to select a related field value from the Scope Value table or the Tree Node table. You can use values for email addresses, user Ids, or role Ids. The general syntax of the %DES% variable is:

```
%DES.[scope field].[detail field].[node field]%
```

---

**Note:** The %DES% variable requires the associated field value be in the same table that the scope is based on.

---

## Opening Existing Report Requests

Use the Open PeopleSoft nVision Report Request dialog box to enter the Business Unit and the Report Name.

This example illustrates the fields and controls on the Open PeopleSoft nVision Report Request dialog box.

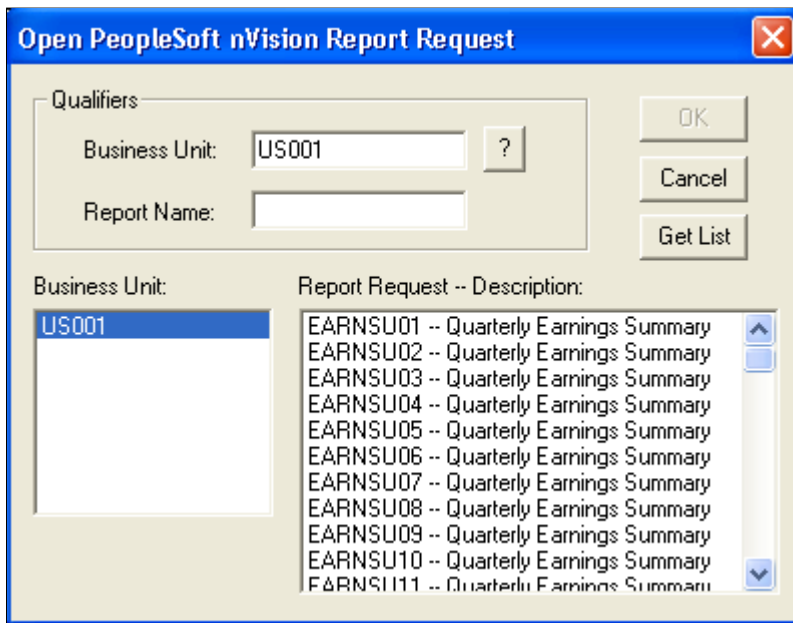

To open an existing report request in PS/nVision:

1. With a layout opens, selecting **nVision, Report Request** from the nVision menu.
2. Click the **Open** button on the PeopleSoft nVision Report Request dialog box.
3. Enter a business unit.
4. Click the **Get List** button to display a list of report requests in the Report Request list box.

After you click the **Get List** button, if the Report Request list box is too long to scroll through, enter a partial report name and click the **Get List** button again.

5. Click a report request and click the **OK** button, or double-click a request name in the Report Request list box.

The Open PeopleSoft nVision Report Request dialog box closes and the report request information appears in the PeopleSoft nVision Report Request dialog box.

## Deleting Report Requests

To delete a report request in PS/nVision:

1. With a layout opens, selecting **nVision, Report Request** from the nVision menu.
2. Select **nVision > Report Request** from the nVision menu.
3. Open the report request that you want to delete.
4. Click the **Delete** button.

---

## Running Reports

This section describes how to:

- Run a report from a report request.
- Run a report from the NVUSER home page.

## Understanding Running Reports

As PS/nVision runs the report, it does the following:

- Creates a copy of the layout for each instance of the report.
- Calls the database to extract information defined in the layout of the report, replacing the selection criteria with specific values.
- Examines the report request, scope, and accounting calendars to transform PS/nVision variables into values.

Microsoft Excel then performs the calculations you entered on the layout. The finished report—a normal Microsoft Excel spreadsheet—appears on your screen. This spreadsheet is also saved in the directory you specified.

If you produced multiple instances of a report, each instance is saved in the specified directory, all instance are closed except the last instance to save Microsoft Excel memory.

## Running a Report from a Report Request

When you run a report from the PeopleSoft nVision Report Request dialog box, PS/nVision opens the layout for you, checks the detail values and trees that you've specified as valid, extracts the data from your database, and enables Microsoft Excel to run its functions.

To run a report from the PeopleSoft nVision Report Request dialog box in PS/nVision:

1. Select **nVision** > **Report Request** from the nVision menu.

The Report Request dialog box appears.

2. Create a new report request or search for an existing one.
3. Modify the report request as necessary.
4. Click the **Save** button to save your settings.

---

**Note:** When you run the report, the dialog box closes and unsaved changes are lost.

---

5. Click the **Run** button.

---

**Note:** To run the last opened report request, select **nVision** > **Run Current Report** from the nVision menu. The report request last opened in the PeopleSoft nVision Report Request dialog box runs automatically.

---

## Running a Report from the NVSUSER Home Page

You can run a report from the NVSUSER home page in several ways. If you have a report layout open on your screen, click the **Run Current Report** icon from the toolbar. The report runs and the results appears on your screen.

To run a report from your Preferences list:

1. In the NVSUSER home page, select any number of report requests from your Report Request list.
2. Click the arrow buttons to move the reports to other positions in the queue, if necessary.
3. Click the **Run Report(s)** button.

The reports are run in sequential order from top to bottom.

### Related Links

[Setting Report Request Preferences](#)

## Working With Report Instances

After running a report, the last report instance created remains open. If other report instances were also created, you can select **File > Open** to review those reports. For the reports that you view frequently, you can create buttons in the NVSUSER home page to open these report instances. NVSUSER also displays a list of files in the **View Reports** list. This list comes from the directory that you specify in the Configuration Manager.

This example shows the View Reports list displaying current instances.

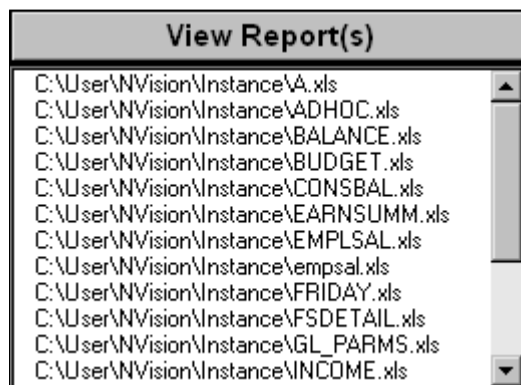

The layout upon which a report instance is based is never modified when the report is run. You can return to the layout by selecting it from the Window menu; or selecting **nVision > Open Layout** if PS/nVision is not open.

You print a report instance just as you would print any other Microsoft Excel spreadsheet by selecting **File > Print**. If you select the Printer as your output type when you request the report, your reports are printed as they are generated.

## **Related Links**

[Understanding PS/nVision Personalization](#)

[Personalizing NVSUSER.XLS](#)



# Distributing Reports in PS/nVision

---

## Understanding Report Distribution

Email and security templates in a report request are the key entries for PS/nVision report distribution. In most of cases you use the scope variable %DES% for the distribution setting so the reports can be distributed to different recipients according to different values in its scope field. However, you can also override the distribution recipients in Process Scheduler Request page for a particular running of a report request.

In general, you specify the content of email and security templates in either of these ways:

1. You can specify the same set of recipients for all report instances from a report request.

In this way, you specify a set of user IDs (U:<user id>) or role IDs (R:<role id>) in the email or security template, or a set of email addresses for the email template.

If you use user IDs or role IDs in the email template, you need to make sure that the corresponding users have valid email addresses specified in their User Profile settings.

2. You can use scope variable %DES% in the email and security templates to select a related field value from a value table or a tree node table that the scope field is based on.

The field values in the scope table need to be populated in the same way, as you would specify them in the first option. The general syntax of the %DES% variable is the following:

```
%DES%.[scope field].[detail field].[node field]
```

PS/nVision evaluates the %DES% variable to the value of the detail field in the value table or the node field in the tree node table for the scope field. In all cases, the detail fields or the node fields are the email and web distribution fields, and they must be presented in the scope tables.

---

## Distributing Reports for Scopes Based on Tree Nodes

If your scope is defined based on PeopleSoft tree nodes, you can attach routing information to the tree that can be used for bursting PS/nVision reports.

The following section provides an example how to distribute PS/nVision reports for scopes based on tree nodes. The basic steps include:

1. Clone tree node table—create record DEPT\_NODE\_TBL.
2. Clone tree node page—create page DEPT\_NODE\_TBL.
3. Grant access to tree node pages.

4. Update tree structures to use the new node table and node page.
5. Populate routing information.
6. Link routing information into PS/nVision.

In this example, you have a scope DIVISIONS with scope field DEPTID based on the node table in DEPARTMENTS tree. The tree structure for DEPARTMENTS tree is DEPTID. In tree structure DEPTID, the node table is TREE\_NODE\_TBL, the node page is DEPARTMENT, and the detail field is DEPTID.

## Cloning Tree Node Table — Creating Record DEPT\_NODE\_TBL

Since your scope is based on tree nodes, the key to entering appropriate distribution information into the tree is to modify the tree node table to include additional distribution fields. You need to add the additional fields, **DISTLIST** and **EMAIL\_TO**, to the node table to be the distribution fields for web and email distribution separately. You can run the following SQL scripts to move the nodes from record **TREE\_NODE\_TBL** to record **DEPT\_NODE\_TBL**, while adding the two new fields to record **DEPT\_NODE\_TB**.

To move all nodes where the tree has detail values based on a given field (such as DEPTID), use the following script:

---

**Note:** You need to change the field name in quotes to the field you want to key from.

---

```
INSERT INTO PS_DEPT_NODE_TBL
SELECT DISTINCT A.SETID, A.TREE_NODE, A.EFFDT, A.EFF_STATUS, A.DESCR, ' ', ' '
  FROM PS_TREE_NODE_TBL A, PSTREENODE B
 WHERE A.TREE_NODE = B.TREE_NODE
       AND B.TREE_NAME IN (SELECT C.TREE_NAME
                          FROM PSTREEDEFN C, PSTREESTRCT D
                          WHERE D.TREE_STRCT_ID = C.TREE_STRCT_ID
                                AND ( C.EFFDT = B.EFFDT
                                      AND C.SETID = B.SETID
                                      AND D.DTL_FIELDNAME = 'DEPTID' ))
```

To move all nodes for a given tree name, use the following script:

---

**Note:** You need to change the tree name in quotes to the tree name you want to key from.

---

```
INSERT INTO PS_DEPT_NODE_TBL
SELECT DISTINCT A.SETID, A.TREE_NODE, A.EFFDT, A.EFF_STATUS, A.DESCR, ' ', ' '
  FROM PS_TREE_NODE_TBL A, PSTREENODE B
 WHERE A.TREE_NODE = B.TREE_NODE
       AND B.TREE_NAME = 'DEPARTMENTS'
```

To move all nodes where the tree is based on a specific tree structure ID, use the following script:

---

**Note:** You need to change the structure name in quotes to the structure ID you want to key from.

---

```
INSERT INTO PS_DEPT_NODE_TBL
SELECT DISTINCT A.SETID, A.TREE_NODE, A.EFFDT, A.EFF_STATUS, A.DESCR, ' ', ' '
  FROM PS_TREE_NODE_TBL A, PSTREENODE B
 WHERE A.TREE_NODE = B.TREE_NODE
       AND B.TREE_NAME IN (SELECT C.TREE_NAME
                          FROM PSTREEDEFN C
                          WHERE C.TREE_STRCT_ID = 'DEPTID'
                                AND ( C.EFFDT = B.EFFDT
                                      AND C.SETID = B.SETID ))
```

## Cloning Tree Node Page - Creating Page DEPT\_NODE\_TBL

In Application Designer, clone the DEPARTMENT page to get a new DEPT\_NODE\_TBL (Department Node Table) page.

In this table, add new page fields (as in the Routing Information section of the example below) to be the data population area for record fields DISTLIST and EMAIL\_TO.

---

**Note:** The page DEPT\_NODE\_TBL has associated PeopleCode to construct a single DISTLIST and EMAIL\_TO field for each node in the node table with the multiple recipients (Email ID or Distribution ID) that users enter in the Routing Information of the page.

---

Also in Application Designer, create a new component DEPT\_NODE and include the DEPT\_NODE\_TBL page in it. And then, make this new component DEPT\_NODE a part of the Tree Manager page system.

This example illustrates the fields and controls on the DEPT\_NODE\_TBL page.

| Routing Information |         |                 |
|---------------------|---------|-----------------|
| Email ID            | ID Type | Distribution ID |
| 1 VP2@abc.com       | User    | VP2             |
| 2 Fred Smith        | Role    | CUSTOMER        |
| 3                   | User    | APA1            |

## Granting Access to Tree Node Pages

Use the Page Permissions page (ACL\_PAGES2) to grant security permissions, set distribution information, and make the new node pages available to users when they maintain the tree.

Navigation:

**PeopleTools > Security > Permissions and Roles > Permission Lists > Pages > Edit Components > Edit Pages**

This example illustrates the fields and controls on the Page Permissions page.

**Page Permissions**

TREEMANAGER / Use / Dept Dist List

| Panel Item Name | Authorized?                         | Display Only             |
|-----------------|-------------------------------------|--------------------------|
| Dept Node Tbl   | <input checked="" type="checkbox"/> | <input type="checkbox"/> |

**Actions**

- Add
- Update/Display
- Update/Display All
- Correction

Select All

Deselect All

OK Cancel

To grant security permissions for the tree in PIA:

1. Select **PeopleTools > Security > Permissions and Roles > Permission Lists**.
2. Open a permission list.

For example, to grant user VP1 to maintain the tree when VP1 belongs to the ALLPNLS permission list, open the permission list for ALLPNLS.

3. Select the Pages tab.
4. Find the TREE\_MANAGER item in the list and click the **Edit Components** link.

The Component Permissions page appears, and the Dept Node (Department Node) component should be in the list and not authorized.

5. Click the **Edit Pages** link in the row where the Dept Node component is listed.
6. Click the **Select All** button to grant access to the page, and then click the **OK** button.
7. Click the **OK** button on the Component Permissions page.
8. Click the **Save** button on the Permission List page.

## Updating Tree Structures to Use the New Node Table and Node Page

Use the Tree Structure – Nodes page to modify the tree structure to use the new node table and node page.

This example shows a version of tree structure (TREE\_NODE\_DISTRIB) that was modified to use the new node table (DEPT\_NODE\_TBL) and node page (DEPT\_NODE\_TBL).

The screenshot shows a web interface with four tabs: Structure, Levels, Nodes, and Details. The 'Nodes' tab is active. Below the tabs is a section titled 'Tree Nodes' containing several configuration fields:

- Structure ID: TREE\_NODE\_DISTRIB
- \*Record Name: DEPT\_NODE\_TBL
- \*Field Name: TREE\_NODE
- \*Page Name: DEPT\_NODE\_TBL
- Component Name: DEPT\_NODE
- Menu Name: TREEMANAGER
- Menu Bar Name: USE
- Menu Item Name: DEPTNODE

To set up Tree Manager in PIA to use the new page:

1. Select **Tree Manager** > **Tree Structure**.
2. Select a structure.
3. Select the Nodes tab to change where the node information is stored.
4. Modify the structure to use the new DEPT\_NODE\_TBL record and new DEPT\_NODE\_TBL page.

## Populating Routing Information

Use the Dept Node Tbl (Department Node Table) page to enter either email addresses, distribution IDs, or a combination of both in the new node page DEPT\_NODE\_TBL. When populating distribution IDs, you are populating the users or roles that Report Manager uses.

To add distribution route information to a tree:

1. Select **Tree Manager** > **Tree Manager** > **and select the required tree**.
2. Highlight the tree nodes and click the **Edit Data** icon to add the distribution routing information.

The Dept Node Tbl page appears.

3. Add the distribution routing information.
4. Click the **OK** button to save.

## Linking Routing Information Into PS/nVision

When Security and Tree Manager have the correct information, the final step is to connect it to PS/nVision.

This section describes the steps to complete this task:

- Check scope definition.
- Specify scope in report request.
- Specify email and security delivery template options.

### Checking Scope Definition

The following example shows the scope definition DIVISIONS, which is on the field DEPTID against all nodes at the level DIVISION using the DEPARTMENTS tree.

This example illustrates the fields and controls on the Scope Definition page.

**Scope Definition**

SetID: QEDM2      Report Scope: DIVISIONS

Description:       Business Unit:

Field Combination Table:

---

**Scope Fields** Find | View All    First  1 of 1  Last

[Delete Scope](#)   

\*Field Name:   Department

\*How Specified:  All Nodes at Selected Levels

Business Unit Keyed Tree

Tree Name:

| Select Value |   | First                            | 1 of 1 | Last                             |
|--------------|---|----------------------------------|--------|----------------------------------|
| 1            | <input type="text" value="DIVISIONS"/> <input type="button" value="🔍"/> | <input type="button" value="+"/> |        | <input type="button" value="-"/> |

### Specify Scope in Report Request

Specify the scope for which the report is being run. The scope drives the distribution process. So in this example, make sure scope DIVISIONS is used in your report request.

To specify scope in nVision report request:

1. Select **Reporting Tools** > **PS/nVision** > **PS/nVision Schedule Requests**.
2. Search for an existing business unit or create a new one.
3. Click the **Scope and Delivery Templates** link in the nVision Report Request page.
4. Click the **Scope Definition** link in the output page.

5. Enter the set ID and report scope, as needed.

The Scope Definition page appears.

6. Specify the scope for which the report is being run.

## Specifying Email and Security Template Options

The Email and Security template fields in the report request tell PS/nVision who to distribute the report to and by what route, for example, email or via the web. To route each scope-based report instance to the person associated with each scope value that drives the generation of the report, use the %DES% variable to pick a field value from the tree node table.

1. Select **Reporting Tools > PS/nVision > PS/nVision Schedule Requests** in PIA.
2. Click the **Scope and Delivery Templates** link.
3. To distribute the report by email, enter %DES...EMAIL\_TO% in the **Email Template** field.

When you run the report, PS/nVision bursts report instances based on the nodes in DIVISION level of the DEPARTMENT tree and delivers the results through email to the email addresses associated with each node. Those email addresses are the ones specified in the Email ID in NODE\_DEPT\_TBL page.

Alternatively, to distribute the report via the web, enter %DES...DISTLIST% in the **Security Template** field.

When you run the report, PS/nVision bursts report instances based on the nodes in DIVISION level of the DEPARTMENT tree and delivers the results to the Report Managers of associated users of each node. Those users are specified in the Distribution ID in NODE\_DEPT\_TBL page.

## Related Links

[Creating Scope Definitions](#)

## Distributing Reports for Scopes Based on Value Tables

If your scope is defined in a value table, such as Department table or Product table, you can create a database view based on the value table to include additional email and web distribution fields. For each scope field value in the value table, you can direct each scope-based report instance to a different user.

In the following example, NVS\_DEPT\_VW below is a SQL View with all the DEPT\_TBL characteristics and OPRIDs of department managers as distribution fields:

```
SELECT B.DEPTID
, B.DESCR
, B.DESCRSHORT
, 'U:' + A.OPRID AS OPRID
, A.EMAILID
, A.EMPLID
FROM PSOPRDEFN A
, PS_DEPT_TBL B
WHERE B.EFFDT = (
SELECT MAX(B_ED.EFFDT)
FROM PS_DEPT_TBL B_ED
WHERE B.DEPTID = B_ED.DEPTID AND
B_ED.EFFDT <= SUBSTRING(CONVERT(CHAR, GETDATE(), 121), 1, 10)) AND
```

```
A.EMPLID = B.MANAGER_ID AND  
B.MANAGER_ID <> ''
```

---

**Note:** This example shows the SQL Viewer for Microsoft SQL database platform. You need to alter the syntax if you want to use it for other database platforms.

---

You can now create a scope with scope field DEPTID based on the value table and use this scope in your report request. To have each department report instance sent, either by email or web distribution, to each associated department manager, you would enter the following value in your Email or Security template:

```
%DES.DEPTID.OPRID.OPRID% or %DES...OPRID%
```

This value allows PS/nVision to use the value in the **OPRID** field to distribute each department report to its department manager. The report is distributed by either email or web, based on the output type specified in your report request.