

**Oracle® Communications  
EAGLE Application Processor  
Upgrade/Installation Guide**

Release 17.1

G35527-06

April 2026

**ORACLE®**

Copyright © 2000, 2026, Oracle and/or its affiliates. All rights reserved.

This software and related documentation are provided under a license agreement containing restrictions on use and disclosure and are protected by intellectual property laws. Except as expressly permitted in your license agreement or allowed by law, you may not use, copy, reproduce, translate, broadcast, modify, license, transmit, distribute, exhibit, perform, publish, or display any part, in any form, or by any means. Reverse engineering, disassembly, or decompilation of this software, unless required by law for interoperability, is prohibited.

The information contained herein is subject to change without notice and is not warranted to be error-free. If you find any errors, please report them to us in writing.

If this is software or related documentation that is delivered to the U.S. Government or anyone licensing it on behalf of the U.S. Government, the following notices are applicable:

U.S. GOVERNMENT END USERS: Oracle programs, including any operating system, integrated software, any programs installed on the hardware, and/or documentation, delivered to U.S. Government end users are "commercial computer software" pursuant to the applicable Federal Acquisition Regulation and agency-specific supplemental regulations. As such, use, duplication, disclosure, modification, and adaptation of the programs, including any operating system, integrated software, any programs installed on the hardware, and/or documentation, shall be subject to license terms and license restrictions applicable to the programs. No other rights are granted to the U.S. Government.

This software or hardware is developed for general use in a variety of information management applications. It is not developed or intended for use in any inherently dangerous applications, including applications that may create a risk of personal injury. If you use this software or hardware in dangerous applications, then you shall be responsible to take all appropriate fail-safe, backup, redundancy, and other measures to ensure its safe use. Oracle Corporation and its affiliates disclaim any liability for any damages caused by use of this software or hardware in dangerous applications.

Oracle and Java are registered trademarks of Oracle and/or its affiliates. Other names may be trademarks of their respective owners.

Intel and Intel Xeon are trademarks or registered trademarks of Intel Corporation. All SPARC trademarks are used under license and are trademarks or registered trademarks of SPARC International, Inc. AMD, Opteron, the AMD logo, and the AMD Opteron logo are trademarks or registered trademarks of Advanced Micro Devices. UNIX is a registered trademark of The Open Group.

This software or hardware and documentation may provide access to or information about content, products, and services from third parties. Oracle Corporation and its affiliates are not responsible for and expressly disclaim all warranties of any kind with respect to third party content, products, and services unless otherwise set forth in an applicable agreement between you and Oracle. Oracle Corporation and its affiliates will not be responsible for any loss, costs, or damages incurred due to your access to or use of third-party content, products, or services, except as set forth in an applicable agreement between you and Oracle.



**CAUTION:** Use only the guide downloaded from the Oracle Technology Network (OTN) (<http://www.oracle.com/technetwork/indexes/documentation/oracle-comms-tekelec-2136003.html>). **Before running upgrade on your system, access the My Oracle Support web portal (<https://support.oracle.com>) and review any Knowledge Alerts that may be related to the System Health Check or the I Upgrade.**

## MY ORACLE SUPPORT

My Oracle Support (<https://support.oracle.com>) is your initial point of contact for all product support and training needs. A representative at Customer Access Support can assist you with My Oracle Support registration.

Call the Customer Access Support main number at 1-800-223-1711 (toll-free in the US) or call the Oracle Support hotline for your local country from the list at <http://www.oracle.com/us/support/contact/index.html>. When calling, make the selections in the sequence shown below on the Support telephone menu:

- For Technical issues such as creating a new Service Request (SR), select **1**.
- For Non-technical issues such as registration or assistance with My Oracle Support, select **2**.
- For Hardware, Networking and Solaris Operating System Support, select **3**.

You are connected to a live agent who can assist you with My Oracle Support registration and opening a support ticket.

My Oracle Support is available 24 hours a day, 7 days a week, 365 days a year.

## Acronyms

This section provides an alphabetized list of acronyms used in the document.

**Table 1. Acronyms**

AS	Application Server
E5-APP-B	E5 Based Application Card
OCEPAP	Oracle Communication EAGLE Provisioning Application Processor
GA	General Availability
IPM	Initial Product Manufacture
LA	Limited Availability
MPS	Multi-Purpose Server
MOS	My Oracle Support
OSDC	Oracle Software Delivery Cloud
SM	Service Module
TPD	Tekelec Platform Distribution

## What's New in this Guide

This section introduces the documentation updates for Release 17.1 in Oracle Communications EAGLE Application Processor Upgrade/Installation Guide.

### Release 17.1 – G35527-06, April 2026

- Added a new step (step 2) to [Procedure 13](#) to verify if DSM\_MIN\_MEM\_SIZE is set correctly.
- Added a new step (step 12) to [Procedure A.43](#) to verify if PDB\_RTDB\_SYNC is set to "YES".
- Updated steps 5, 12, 18 and 23 of [Procedure A.35](#).
- Updated the second note in the [Purpose and Scope](#) section of the document.
- Added a new note under the following tables:
  - Table 9: Full Upgrade Phases for Mixed and Non-Provisionable EPAP
  - Table 11: Full Upgrade Phases for Dual Mixed with Live Provisioning
  - Table 12: Full Upgrade Phases on Standalone PDB
  - Table 13: Full Upgrade Phases Dual PDBonly
- Added a new step (step 7) under [Procedure A.32](#).

### Release 17.1 – G35527-05, February 2026

- Updated step 4 in [Procedure A.12](#) with a table containing DIU ISO names.
- Added a new step (step 6) in [Procedure A.12](#) to copy the diuPreUpgrade.sh from the source path.
- Added new steps (step 1 and step 2) to [Procedure A.44](#) to login as root user.
- Updated the code in step 5 of [Procedure A.47](#).
- Updated the commands in step 16 of [Procedure A.47](#).
- Updated step 1 of [Procedure A.50](#) with the images of the screen when DIU upgrade is rejected.
- Updated the command in the note under [Procedure A.50](#).
- Added a new step (step 3) in [Procedure 4, System Health Check](#) to check the disk size for Active and Standby PDBA.
- Added a new step (step 4) in [Procedure A.32, Post Upgrade EuiDB Database Restore](#) to update the HTTP/HTTPS variable in EuiDB.
- Added [Procedure A.54](#) to configure PDB Capacity.
- Added configuring PDB capacity as a phase under [Section 3.1.6](#) and [Section 3.1.7](#).
- Updated the command in [Procedure 11](#), step 33.

### Release 17.1 – G35527-04, January 2026

- Updated PDB database backup procedure in step 5 of [Procedure 15](#).
- Added a new step "Check Disk Space" under [Procedure A.1](#).

### Release 17.1 – G35527-03, October 2025

Updated the command in step 13 of the Switch Configuration procedure.

### Release 17.1 – G35527-02, September 2025

- Added steps to run PDB Restore\_Monitor.h script in step 4 in [Procedure A33](#).
- Added EPAP versions 17.0.0.5.0 and beyond as the latest supported versions for PV tool in step 4 in [Procedure A33](#).
- Added EPAP version 17.0.0.4.0 as the last supported version to run PDB Restore\_Monitor.h script in step 4 in [Procedure A33](#).
- Removed all information related to fresh installation of Eagle Query Server from this document.
- MySQL Command updates have been made in the following sections:
  - [Procedure 24](#), step 18
  - [Procedure 25](#), step 34
  - [Procedure A.27](#), step 3
  - [Procedure A.31](#), step 4
  - [Procedure A.33](#), step 4
  - [Procedure A.51](#), step 8

### Release 17.1 – G35527-01, June 2025

- Added [Appendix A.53](#) to list the steps to exchange keys between OL8 based PDBonly and OL6 based Non-Prov.
- Added step 40 in [Procedure 11](#) to add reference to the procedure to exchange keys between OL8 based PDBonly and OL6 based Non-Prov.
- Added steps 1 and 5 in [Procedure A.32, Post upgrade EuiDB database restore](#) to add the commands to verify verify the MIN\_DSM\_MEM\_SIZE and PDB\_SUB\_CAPACITY.
- Added the phase “Change DB architecture from Compact to eXtreme on Non-Prov site” in sections [3.1.6](#) and [3.1.7](#).
- Added the notes in [Procedure A.51, MySQL RPM Upgrade Procedure](#) to mention this procedure is only applicable if upgrading from EPAP 17.0.0.x to 17.0.0.y (where  $0 \leq x \leq 5$  and  $y \geq 6$ ) or from 17.0.0.x (where  $0 \leq x \leq 5$ ) to 17.1.y via migration and The EPAP GUI will not be accessible after this procedure.
- Updated step 5 in [Procedure 15, Preupgrade Backups](#) to provide information about upgrading via migration from EPAP 17.0.0.x to 17.0.0.y.

# TABLE OF CONTENTS

<b>1</b>	<b>INTRODUCTION.....</b>	<b>13</b>
	Purpose and Scope.....	13
	References.....	14
	1.1.1 External .....	14
	1.1.2 Internal (Oracle).....	14
	Software Release Numbering.....	14
	Terminology .....	14
	Recommendations .....	16
	Requirements.....	17
<b>2</b>	<b>GENERAL DESCRIPTION .....</b>	<b>18</b>
	Upgrading Provisionable mixed EPAP Mated Pairs.....	19
	Backout Provisionable mixed EPAP Mated Pairs .....	20
	Upgrading EPAP Non-Provisionable MPS Servers .....	20
	2.1.1 Upgrading Non-Provisional MPS pairs in Mixed EPAP configuration .....	20
	2.1.2 Upgrading Non-Provisional MPS pairs in dual PDBonly configuration.....	21
	Backout EPAP Non-provisionable MPS servers.....	22
	2.1.3 Backout Non-Provisionable MPS pairs in dual PDBonly configuration .....	22
	2.1.4 Backout Non-Provisionable MPS pairs in mixed EPAP configuration.....	22
<b>3</b>	<b>UPGRADE OVERVIEW .....</b>	<b>23</b>
	Upgrade Provisioning Rules .....	23
	Required Materials .....	24
	Installation Phases .....	26
	3.1.1 Installation Phases for Mixed and Non-Provisionable EPAP .....	26
	3.1.2 Installation Phases for Standalone PDB.....	27
	Full Upgrade Phases.....	28
	3.1.3 Full Upgrade Phases for Mixed EPAP without live provisioning .....	29
	3.1.4 Full Upgrade Phases for Non-Provisionable EPAP with or without live provisioning.....	33
	3.1.5 Full Upgrade Phases for Dual Mixed with live provisioning.....	38
	3.1.6 Full Upgrade Phases for Standalone PDB without live provisioning .....	44
	3.1.7 Full upgrade Phases for Dual PDBonly with live provisioning .....	48
	Dual Upgrade Phases.....	54
	3.1.8 Dual Image Upgrade Phases for Mixed EPAP without Live Provisioning .....	54
	3.1.9 Dual Image Upgrade Phases for Dual Mixed EPAP without Live Provisioning...56	
	3.1.10 Dual Image Upgrade Phases for Non-Provisionable EPAP with or without live provisioning.....	57
	3.1.11 Dual Image Upgrade Phases for Dual Mixed with live provisioning.....	59
	3.1.12 Dual Image Upgrade Phases for Standalone PDB without live provisioning .....	62
	3.1.13 Dual Image Upgrade Phases for Dual PDBonly with live provisioning .....	64
	Backout Phases .....	66
	3.1.14 Backout Phases for Mixed and Non-Provisionable EPAP .....	67
	3.1.15 Backout Phases for Standalone PDB .....	67
	Log Files .....	68
<b>4</b>	<b>DB ARCHITECTURE OVERVIEW .....</b>	<b>69</b>

Overview of DB architecture change in Customer Network .....	69
Overview of DB architecture change from Compact to Extreme .....	70
Change DB Architecture from COMPACT to eXtreme to support EAGLE release 46.7.0.0.0(eXtreme feature) .....	71
4.1.1 Phases to change DB Architecture to eXtreme (Standalone PDB).....	72
4.1.2 Phases to change DB architecture to eXtreme (First Non-Prov site) .....	72
4.1.3 Phases to change DB architecture to eXtreme (Remaining Non-Prov sites) .....	74
<b>5 UPGRADE PREPARATION .....</b>	<b>75</b>
Setting up the upgrade environment.....	75
Determine if upgrade or installation is required.....	78
Pre-upgrade requirements.....	81
System Health check.....	82
<b>6. SOFTWARE INSTALLATION PROCEDURES.....</b>	<b>84</b>
Pre-Install configuration on server A.....	84
Pre-Install configuration on server B.....	90
Install Application on server B .....	96
Procedure 8 Install Application on server A .....	103
Procedure 9 Switch Configuration .....	110
Procedure 10 Configure Sync Network Redundancy.....	122
Procedure 11 Configuring the application.....	128
Procedure 12 Provision data from GUI.....	153
Procedure 13 Change DB Architecture .....	158
<b>7 SOFTWARE UPGRADE PROCEDURES.....</b>	<b>166</b>
Procedure 14 Assess MPS server's readiness for upgrade .....	166
Procedure 15 Preupgrade Backups.....	168
Procedure 16 Preupgrade system time check .....	170
Procedure 17 Check 9dig counts before moving to eXtreme architecture.....	172
Procedure 18 Upgrade Server B .....	173
Procedure 19 Upgrade server A.....	189
Procedure 20 Run RTDB Converter .....	204
Procedure 21 Reboot EAGLE Cards .....	205
Procedure 22 Accept Upgrade .....	206
Procedure 23 Keys exchange between active and standby PDB .....	209
<b>8 SOFTWARE RECOVERY PROCEDURES.....</b>	<b>211</b>
8.1 Backout Setup.....	211
8.2 Perform Backout.....	211
Procedure 24 Server B Backout .....	212
Procedure 25 Backout both Server A and B .....	220
Procedure 26 Stop the Pdba software.....	233
Procedure 27 Restart PDBA Software (Post-Backout and Post-Upgrade).....	234
<b>APPENDIX A GENERIC PROCEDURES.....</b>	<b>239</b>
Procedure A.1 Perform System Health Check .....	239
Procedure A.2 Validate Upgrade Media.....	242
Procedure A.3 System Configuration Backup .....	247

Procedure A.4	Execute parse9Dig script .....	249
Procedure A.5	Increase rtVolume size for Non-prov .....	251
Procedure A.6	PDB Backup.....	254
Procedure A.7	RTDB Backup .....	258
Procedure A.8	EuiDB Backup .....	261
Procedure A.9	RTDB Reload from PDBA .....	263
Procedure A.10	RTDB Restore.....	266
Procedure A.11	RTDB Reload from Remote.....	270
Procedure A.12	ISO Image download from Oracle Software Delivery Cloud.....	274
Procedure A.13	IPM MPS Server with TPD 8.6.0 .....	277
Procedure A.14	Standalone PDB Segmented Configuration.....	288
Procedure A.15	Password change for EPAP System Users .....	293
Procedure A.16	E5-APP-B Halt/Shutdown.....	295
Procedure A.17	Procedure to Configure EPAP switch ports and EAGLE SM cards to support 1G EPAP-to-Eagle RTDB download speed .....	297
Procedure A.18	Upgrade SSL certificate from SHA-1 to SHA-512.....	318
Procedure A.19	Disable Epap VIP And Deactivate PDBA Proxy Feature .....	319
Procedure A.20	Enable EPAP PDBA Proxy and EPAP VIP Optional Features.....	328
Procedure A.21	Configure DSM Min Mem Size .....	340
Procedure A.22	Restart Mysql service for PDB on Query Server.....	341
Procedure A.23	Get parse9Dig file from EPAP 16.3 ISO .....	342
Procedure A.24	Procedure to add/edit the /etc/minirc.mate file.....	345
Procedure A.25	Configure the Auto Backup .....	347
Procedure A.26	STOP ACTIVE PDBA AND VERIFY REPL LOGS.....	348
Procedure A.27	PDB Backup before upgrade .....	351
Procedure A.28	Clear replication logs .....	352
Procedure A.29	Remove remote PDBA IP .....	354
Procedure A.30	Reset RTDB Homing Policy to remote PDBA .....	357
Procedure A.31	Change MySql engine schema .....	360
Procedure A.32	Post upgrade EuiDB database restore.....	362
Procedure A.33	Post upgrade PDB database restore.....	364
Procedure A.34	Add Remote PDBA IP Address.....	365
Procedure A.35	Keys exchange between active PDB and standby PDB .....	367
Procedure A.36:	RTDB restore after Upgrade .....	381
Procedure A.37:	Resolve the false accept upgrade alarm situation .....	385
Procedure A.38	Conversion from mixed EPAP to StandalonePDB+Non-Prod EPAP .....	387
Procedure A.39	Take snapshot of uiEdit parameters.....	388
Procedure A.40	Save the EPAP 16.3/16.4 additional configurations .....	390
Procedure A.41	Reconfigure Additional EPAP configurations .....	394
Procedure A.42	Compare EuiDB parameters .....	399
Procedure A.43	PDB Restore.....	399
Procedure A.44	RTDB Homing Policy to self PDBA .....	404
Procedure A.45	Backout of MPS A and MPS B in Mixed and Non-Prod .....	408
Procedure A.46	Backout of PDBonly site .....	409
Procedure A.47	Dual Image Upgrade Procedure .....	410
Procedure A.48	Switchover PDBA state.....	422
Procedure A.49	Dual Image Upgrade Known Issues Fix .....	425
Procedure A.50	Accept/Reject the Dual Image Upgrade .....	425
Procedure A.51	MySQL RPM Upgrade Procedure.....	428

Procedure A.52 Post MySQL RPM upgrade PDB Restore Procedure .....	434
Procedure A.53 Keys exchange between OL 8 based PDBonly and OL6 based Non-prov 436	
<b>APPENDIX B INTERCONNECTION DIAGRAM.....</b>	<b>441</b>
<b>APPENDIX C TELCO TO CISCO SWITCH REPLACEMENT .....</b>	<b>443</b>
<b>SWITCH REPLACEMENT.....</b>	<b>443</b>
<b>SWITCH CONFIGURATION.....</b>	<b>449</b>
<b>APPENDIX D SWOPS SIGN OFF.....</b>	<b>460</b>
<b>APPENDIX E CUSTOMER SIGN OFF .....</b>	<b>461</b>
<b>APPENDIX F MAJOR CHANGES IN EPAP 17.0.....</b>	<b>462</b>

## List of Figures

Figure 1: Example of a step that indicates the Server on which it needs to be executed.....	15
Figure 2: Initial Application Installation Path.....	18
Figure 3: Full upgrade Path – EPAP 17.0.0.0-b.b.b .....	18
Figure 4: Dual Image Upgrade Path – EPAP 17.0.0.0-b.b.b .....	<b>Error! Bookmark not defined.</b>
Figure 5: EPAP Mated Pairs.....	19
Figure 6: EPAP Mated Pairs with Non-Provisioning MPS Servers.....	21
Figure 7: Slide the Ejector Switch.....	296
Figure 8: Release Lever .....	297
Figure 9: Interconnectivity Diagram for Sync Network Redundancy (Eth04 used for Sync Network) .....	441
Figure 10: Default Interconnectivity Diagram (Eth04 used for Backup Provisioning Network) .....	442

## List of Tables

Table 1. Acronyms.....	4
Table 2. Terminology .....	15
Table 3: Upgrade time for EPAP 17.0 PROV EPAP - Mixed EPAP (Compact DB)/ PDBOnly(eXtreme DB)...	23
Table 4: Upgrade time for EPAP 17.0 Non-PROV EPAP .....	24
Table 5: System Configuration Information.....	25
Table 6: User Password Table .....	25
Table 7: Installation Phases for Mixed EPAP and Non-Provisional EPAP.....	27
Table 8: Installation Phases for Standalone PDB .....	28
Table 9: Full Upgrade Phases for Mixed and Non-Provisionable EPAP .....	32
Table 10: 3.1.4 Full Upgrade Phases for Non-Provisionable EPAP with or without live provisioning.....	33
Table 11: Full Upgrade Phases for Dual Mixed with live provisioning.....	44
Table 12: Full Upgrade Phases on Standalone PDB.....	47
Table 13: Full Upgrade Phases Dual PDBOnly.....	52
Table 14: Dual Image Upgrade Phases for Mixed EPAP without Live Provisioning.....	53
Table 15: Dual Image Upgrade Phases for Non-Provisionable EPAP with or without live provisioning.....	56
Table 16: Dual Image Upgrade Phases with Dual Mixed with Live Provisioning .....	57
Table 17: Dual Image Upgrade Phases for Standalone PDB without Live Provisioning.....	681
Table 18: Backout Phases for Mixed and Non-Provisionable EPAP .....	65
Table 19: Backout Phases for Standalone PDB.....	66
Table 20: DB Conversion.....	68
Table 21: Phases to change DB Architecture to eXtreme (Standalone PDB).....	70
Table 22: Phases to change DB Architecture to eXtreme (First Non-Prov site).....	71
Table 23: Phases to change DB Architecture to eXtreme (Remaining Non-Prov sites).....	72

## List of Procedures

Procedure 1: Setting up the upgrade environment.....	75
Procedure 2: Determine if upgrade or installation is required.....	78
Procedure 3: Verifying Pre-Upgrade Requirements and Capturing Upgrade Data .....	81
Procedure 4: System Health Check.....	82
Procedure 5: Pre-Install Configuration on Server A.....	84
Procedure 6: Pre-Install Configuration on Server B.....	90
Procedure 7: Install the Application on Server B .....	96
Procedure 8: Install the Application on Server A.....	103
Procedure 9: Switch Configuration .....	110
Procedure 10: Procedure to Configure Sync Network Redundancy.....	123
Procedure 11: Configuring the Application .....	128
Procedure 12: Provision data from GUI (Active Provisionable(mixed-EPAP or PDBonly) Site as designated by customer).....	153
Procedure 13: Change the DB Architecture.....	158
Procedure 14: Assess the MPS Server's Readiness for Upgrade .....	166
Procedure 15: Pre Upgrade Backups .....	168
Procedure 16: Pre-Upgrade System Time Check .....	170
Procedure 17: Check 9dig counts before moving to eXtreme architecture .....	172
Procedure 18: Upgrade Server B .....	173
Procedure 19: Upgrade Server A .....	189
Procedure 20: Run RTDB Converter.....	204
Procedure 21: Reboot EAGLE Cards.....	205
Procedure 22 : Accept upgrade .....	206
Procedure 23: Keys exchange between active PDB and standby PDB .....	209
Procedure 24: Server B Backout .....	212
Procedure 25: Backout both MPS A and B.....	220
Procedure 26: Stop the PDBA Software.....	233
Procedure 27: Restart the PDBA Software Post-Backout and Post-Upgrade .....	235

# 1 INTRODUCTION

## Purpose and Scope

This document describes methods utilized and procedures executed to perform the following tasks:

- a. An initial installation of the EPAP 17.1 application software if it is not currently installed on an in-service E5-APP-B system running a release of TPD 8.X
- b. A full upgrade on an in-service E5-APP-B system running an EPAP Release 16.3.x/16.4.x
- c. A dual image upgrade on an in-service E5-APP-B system running an EPAP release 17.0.x

The audience for this document consists of Oracle customers and the following groups: Software System, Product Verification, Documentation, and Customer Service including Software Operations and NPI. This document provides step-by-step instructions to execute any MPS upgrade or installation using an ISO image.

This document does not address requirements relating to the interaction, if any, between EAGLE and MPS upgrade. This document does not address feature activation.

### Note:

1. Service <service name> start/stop should not be used on EPAP 17.1 onwards. Instead, systemctl start/stop <service name> should be used.
2. EPAP 16.4 introduced a new parameter, LSBLSET, in the DN\_BL and DNB\_BL tables of the PDB database. EPAP releases prior to 16.4 do not have LSBLSET in their DN\_BL and DNB\_BL tables. Customers who use LSBLSET in their provisioning and are upgrading their EPAP network from EPAP 16.3 to a higher release (16.4/17.x) must ensure that LSBLSET is provisioned only after the entire network has been upgraded to EPAP 17.0. The following key points must be observed when upgrading from 16.3 to 16.4/17.x:
  - Do not provision LSBLSET in the network while any provisioning node (Active or Standby PDBA site) is still on 16.3, as older nodes will reject the update and cause replication failures.
  - Ensure that no provisioning is performed in this state (17.x Active PDB / 16.x Standby PDB). If the EPAP 17.0 Active PDB site upgrades a DN with the LSBLSET parameter, EPAP 16.3 EPAPs will reject the update because they do not have the LSBLSET parameter in their database. Further provisioning at the Standby PDBA and Non-PROVs will be blocked once any update fails to replicate to the Standby PDBA or Non-PROVs.
  - Provision LSBLSET only after all nodes/sites have been upgraded to EPAP 17.x (or 16.4+). After this, any site running 17.x can be made Active.
  - In a dual PDBonly/dual Mixed server setup, if one PROV (StandAlone/Mixed-EPAP) site is upgraded to EPAP 17.x while the other PROV site remains on EPAP 16.x, do not designate the EPAP 17.x site as the Active provisioning server. Ensure that no provisioning is performed while EPAP 17.x is active

and EPAP 16.x is on standby. Only after both sites have been upgraded to EPAP 17.x may either site running EPAP 17.x be designated as the Active Provisioning site.

In addition, EPAP 17.x will be made the Active provisioning server during the maintenance window, just before upgrading EPAP 16.3 (or lower) to 17.x. During this maintenance window when 17.x is active and 16.3 (or lower) is upgrading, no provisioning should be performed.

Failure to follow the above may result in replication issues and provisioning being blocked.

## References

### 1.1.1 External

[1] *EAGLE Application Processor (EPAP) Administration Guide*, E54368-01, latest revision, Oracle

[2] *EPAP 16.4 Administration Manual*, Oracle

### 1.1.2 Internal (Oracle)

The following are references internal to Oracle. They are provided here to capture the source material used to create this document. Internal references are only available to Oracle's personnel.

[1] *TEKELEC Acronym Guide*, MS005077, revision 2.35, September 2005.

[2] *Software Upgrade Procedure Template*, TM005074, Current Version

[3] *Integrating MPS into the Customer Network*, TR005014, version 3.1, October 2009

[4] *TPD Initial Product Manufacture – TPD 8.6*, Latest revision

[5] *PFS EPAP 17.1*, Latest revision

[6] *EPAP Administration Manual for EPAP 17.1*, Latest version

[7] EPAP Linkset Based Blocklisting, CGBU\_042015

## Software Release Numbering

Refer to Engineering Release Notes or other appropriate document with the most recent build numbers in order to identify the proper components (software loads, GPLs, etc.) that comprise the product's software release.

## Terminology

Multiple servers may be involved with the procedures in this manual. Therefore, most steps in the written procedures begin with the name or type of server to which the step applies. For example:

*Each step has a checkbox for every command within the step that the technician should check to keep track of the progress of the procedure.*

*The title box describes the operations to be performed during that step.*

*Each command that the technician is to enter is in 9 point Lucida Console font*

1 <input type="checkbox"/>	MPS A: Verify all materials required are present	Materials are listed in Material List ( <a href="#">Section 3.2</a> )
-------------------------------	--	---

**Figure 1: Example of a step that indicates the Server on which it needs to be executed**

Other terminology follows.

**Table 2. Terminology**

<b>Backout</b>	The process to take a system back to a Source Release prior to completion of upgrade to Target release. Includes preservation of databases and system configuration.
<b>Mixed EPAP</b>	An EPAP where both PDB and RTDB databases reside.
<b>Non-provisionable (Non-prov) EPAP</b>	An EPAP server hosting a Real Time DB without any provisioning interfaces to external provisioning applications. Non-Prov servers are connected to a pair of Provisionable EPAP(mixed-EPAP or PDBonly) from where they get their updates.
<b>Provisionable EPAP</b>	An EPAP server hosting PDB with provisioning interfaces to AS. Both Mixed EPAP and Standalone PDB are Provisionable EPAP.
<b>Source release</b>	Software release to upgrade from.

<b>Split Mirror</b>	<p>Systems that use software RAID instead of hardware RAID can use the software RAID mirrors as a backout mechanism.</p> <p>Conceptually in a software RAID1 with two disks there are two sides to the mirror; let them be side A and side B. For a system with multiple software RAID devices, each device will have an A side and a B side. For an upgrade with a BACKOUT_TYPE=SPLIT_MIRROR the upgrade will break the mirrors at the beginning of the upgrade and perform the upgrade on the <b>Asides</b> of the mirrors. The other sides of the mirrors (<b>B sides</b>) are left intact in their pre-upgrade state throughout the duration of the upgrade.</p> <p>When a backout is performed the system is rebooted into the same 'backout environment'. Inside this 'backout environment' the RAID mirrors are rebuilt from the <b>B sides</b> of the arrays, thus restoring the system to the pre-upgrade state</p>
<b>Standalone PDB</b>	Also known as 'PDB Only', this type of EPAP shall have PDB database only. No RTDB database shall exist on the standalone PDB site.
<b>Target release</b>	Software release to upgrade to.
<b>Upgrade media</b>	USB media or ISO image for E5-APP-B.
<b>Dual Image Upgrade (DIU)</b>	This process upgrades both the Application as well as the TPD version on the system together. This provides a faster method to upgrade the setup.

## Recommendations

This procedure should be followed thoroughly utilizing the steps as written. **When planning to run upgrade on the server, contact My Oracle Support at least 48 hours before the upgrade process has been planned to be initiated.** In the event any unexpected results are returned while executing steps in this procedure, halt the activity and contact My Oracle Support for assistance.

Read the following notes on procedures:

1. **While performing the upgrade, do not open the `epapconfig` menu if it is not mentioned in the procedure. Do not run anything in the setup that is not documented in the install/upgrade manual.**
2. Any procedure completion times are estimates. Times may vary due to differences in database size, user experience, and user preparation.
3. The shaded area within response steps must be verified in order to successfully complete that step.
4. Output displayed in the procedures' response steps is presented. Actual output varies depending on system. Output is presented for reference only.
5. Where possible, command response outputs are shown as accurately as possible. However, exceptions may include the following:
  - Information such as **time** and **date**.

- ANY information marked with “XXXX.” Where appropriate, instructions are provided to determine what output should be expected in place of “XXXX.”
6. After completing each step and **at each point where data is recorded from the screen, the technician performing the procedure must check each step.** A checkbox has been provided beneath each step number for this purpose.
  7. Captured data is required for future support reference if My Oracle Support is not present during the execution of procedures.
  8. In procedures that require a command to be executed on a specific MPS, the command is prefaced with MPS A: or MPS B:
  9. User Interface menu items displayed in this document were correct at the time the document was published but may appear differently at time that this procedure is executed.
  10. During DIU (Dual Image Upgrade), do not open the GUI or start the software explicitly.
  11. Do not provision data during the DIU process as it might lead to data loss.
  12. Copy the commands in a text editor to verify their format before running them in the CLI rather than pasting them directly from the document to the CLI.

## Requirements

- Screen logging is required throughout the procedure. These logs should be made available to My Oracle Support in the event their assistance is needed.
- Target-release USB media or ISO image

## 2 GENERAL DESCRIPTION

This document defines the step-by-step actions performed to execute a software upgrade of an in-service MPS running the EPAP application from the source release to the target release on **E5-APP-B-01/02**.

For the EPAP application, some steps in this procedure refer to the PDB application feature on the MPS A of the MPS pair. The EPAP application makes it optional for a newly installed MPS A node to be configured as a Provisioning (PDB) node (upgrades of MPS A nodes already configured as a provisioning node does not change this configuration).

**Note: Refer to Media and Documentation section of Release Notes 17.1 for correct TPD and EPAP Release**

The EPAP upgrade paths are shown in the figures below. The general timeline for all processes to perform a software incremental upgrade, from pre-upgrade backups to a final system health check, is also included below.

**Figure 2: Initial Application Installation Path**

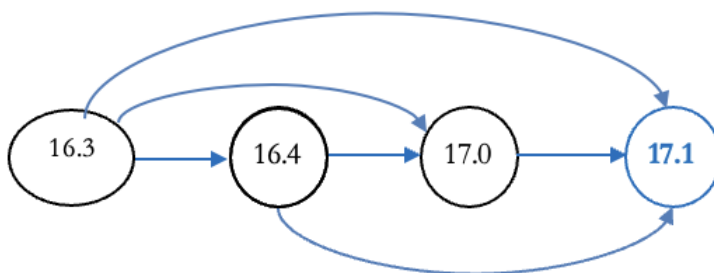
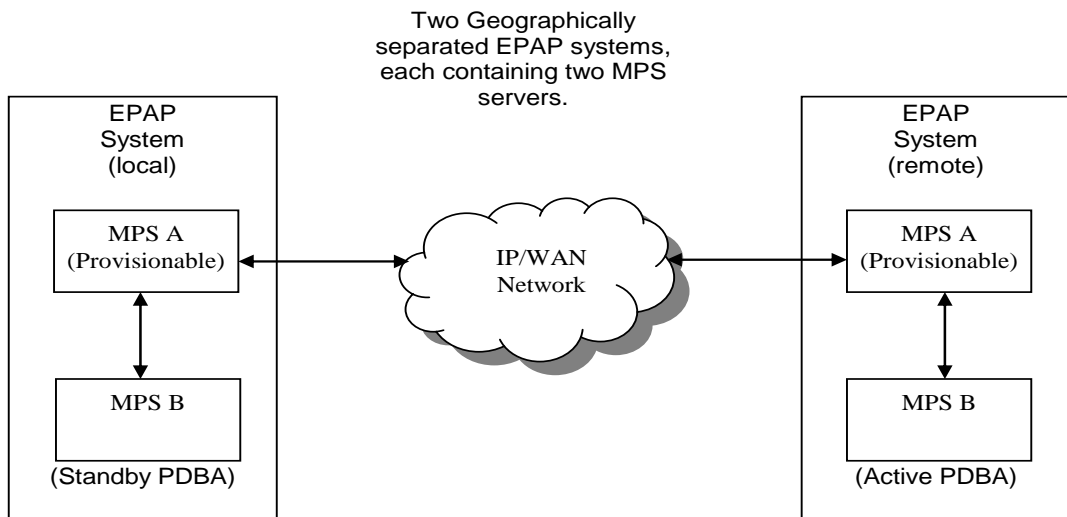

**Figure 3: Upgrade Paths – EPAP 17.1.0.0.0-b.b.b**

## 2.1 Upgrading Provisionable mixed EPAP Mated Pairs

Current deployments of the EPAP support two geographically separated EPAP systems that are “mated”, meaning they communicate and replicate PDB information between the two sites. An EPAP system is a pair of MPS servers (an **A** and a **B** node). Hence, a mated pair of EPAP systems consists of four MPS servers, an **A** and a **B** node for each EPAP system (see Figure 4: EPAP Mated Pairs). EPAP allows more than two EPAP systems in a related configuration (up to 22 Non-Provisionable MPS servers).

This document describes upgrade (and, if necessary, backout) of the EPAP software on one system, that system consisting of two MPS servers (A and B).



**Figure 4: EPAP Mated Pairs**

Upgrade of provisionable EPAP(mixed-EPAP) mated pairs must be carried out in the following order:

1. Ensure PDB databases are at the same level. Make ensure that all PDB databases are in sync before proceeding.
2. Local MPS-B
3. Local MPS-A (Standby PDBA)
4. Remote MPS-B
5. Remote MPS-A (Active PDBA)

NOTE: Since the PDBA software is not running immediately after an upgrade, the syscheck utility will alarm the fact that the PDBA is not running on the local and remote EPAP A-servers.

## **Backout Provisionable mixed EPAP Mated Pairs**

Backout of Provisionable EPAP (mixed-EPAP) Mated Pairs should be done in the reverse order that the upgrade was performed:

1. Identify a PDB backup that was made prior to upgrade, on the EPAP release that backout will target. Note that backout always carries the risk of losing data, should a restore from database backup become necessary.
2. Remote MPS-A (Active PDBA)
3. Remote MPS-B
4. Local MPS-A (Standby PDBA)
5. Local MPS-B

On a backout of an upgrade, the server will remain in runlevel 3 (no applications running). The user will be required to manually reboot the server to bring it back into service and a syscheck can be performed.

## **Upgrading EPAP Non-Provisionable MPS Servers**

EPAP Non-Provisional MPS pairs can connect to: Mixed EPAP or Standalone PDB.

### **2.1.1 Upgrading Non-Provisional MPS pairs in Mixed EPAP configuration**

EPAP provides the ability to expand the concept of a mated pair of EPAP systems to have up to 24 EPAP systems (48 MPS servers total) configured such that two of the MPS-A servers will run the PDBA software and RTDB software both and handle provisioning (Provisionable nodes) and the other 22 MPS-B and 22 MPS-A servers will only run the RTDB software, taking their updates from the two Provisionable (mixed-EPAP or PDBonly) MPS-A servers.

An example showing 4 EPAP systems,  
two of which are provisioning nodes.

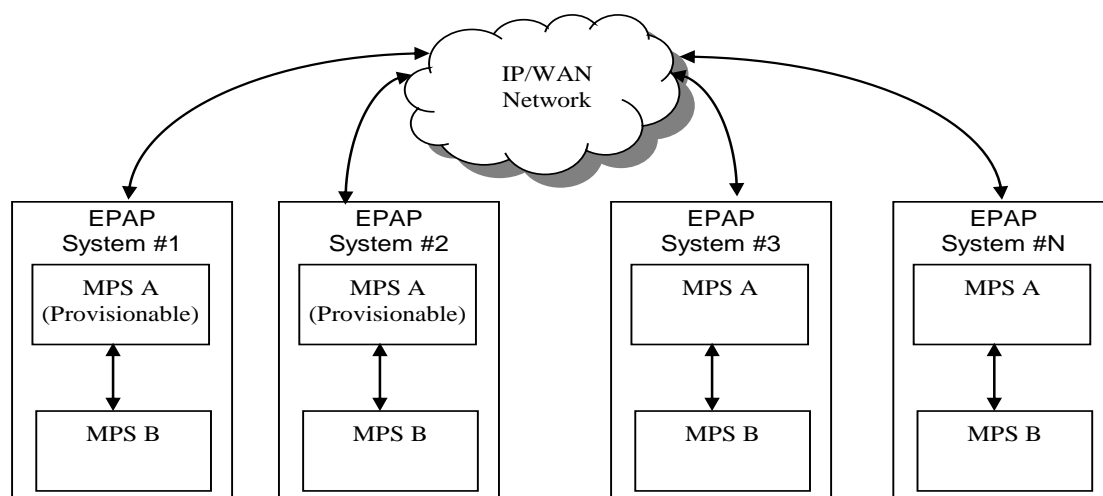

**Figure 5: EPAP Mated Pairs with Non-Provisioning MPS Servers**

In such a configuration, it is required that the EPAP system containing the provisionable MPS servers are upgraded first, before any EPAP system containing the non-provisionable MPS servers are upgraded. Upgrade of such configuration must be carried out in the following order:

**Mixed EPAP (with standby PDBA)**

1. Mixed EPAP (MPS B)
2. Mixed EPAP (MPS A)

**Mixed EPAP (with active PDBA)**

3. Mixed EPAP (MPS B)
4. Mixed EPAP (MPS A)

**Non-provisionable EPAPs (All Non-Provs)**

5. Non-Provisionable (MPS B)
6. Non-Provisionable (MPS A)

**2.1.2 Upgrading Non-Provisional MPS pairs in dual PDBOnly configuration**

EPAP provides the ability to separate the RTDB from PDB to create two architectures: Standalone PDB running PDB process only and Non-Provisionable running RTDB only. Up to 22 Non-Provisional EPAP

mated pairs are connected to 2 Standalone PDB that are configured as Active/Standby. In such a configuration, it is required that the Prov servers must be upgraded first followed by the Non-Provs and should be carried out in the following order:

1. Standby PDBonly
2. Active PDBonly
3. Non-Prov (MPS B)
4. Non-Prov (MPS A)

## **Backout EPAP Non-provisionable MPS servers**

EPAP Non-Provisional MPS pairs can connect to: Mixed EPAP or Standalone PDB.

### **2.1.3 Backout Non-Provisionable MPS pairs in dual PDBonly configuration**

Backout of Non-Provisionable MPS pairs in Standalone configuration should be done in the reverse order that the upgrade was performed. Please follow the below mentioned steps for backout:

1. Non-Provisionable (MPS A)
2. Non-Provisionable (MPS B)
3. Standby PDBonly
4. Active PDBonly

On a backout of an upgrade, the server will remain in runlevel 3 (no applications running). The user will be required to manually reboot the server to bring it back into service and a syscheck can be performed.

### **2.1.4 Backout Non-Provisionable MPS pairs in mixed EPAP configuration**

Backout of EPAP Non-provisionable MPS pairs in mixed EPAP configuration should be done in the reverse order that the upgrade was performed:

Non-provisionable EPAP

1. Non-Provisionable (MPS A)
2. Non-Provisionable (MPS B)

Mixed EPAP (**with Standby PDBA**)

3. Mixed EPAP (MPS A)
4. Mixed EPAP (MPS B)

Mixed EPAP (**with Active PDBA**)

5. Mixed EPAP (MPS A)
6. Mixed EPAP (MPS B)

### 3 UPGRADE OVERVIEW

#### 3.1 Upgrade Provisioning Rules

Provisionable Dual Mixed EPAP and dual PDBonly EPAPs can be upgraded with both live provisioning ON or Off, please refer [section 3.1.6](#) and [section 3.1.8](#).

Provisionable Single Mixed and Single PDBonly EPAPs can be upgraded with live provisioning OFF only, please refer [section 3.1.3](#) and [section 3.1.7](#).

Non-Provisionable EPAPs can be upgraded with both live provisioning ON or OFF, please refer [section 3.1.5](#).

The PDBA software remains stopped on the server which is being upgraded even after upgrade is done until asked to start the software as mentioned in the upgrade procedures.

Note: It is very important that any Legacy UpdateAny legacy update must be accepted before proceeding for Dual Image Upgrade.

The following table describes the typical time required to upgrade to EPAP release 17.1. The data represents what was observed in the lab test. The timing required in actual upgrade might vary. The data is provided to gauge the approximate time required for the upgrade and prepare for proper maintenance window.

**Note:**

All Non-PROVs can be upgraded within normal maintenance window of 6-8 hours. PROV EPAPS (Mixed-EPPA/No-PROVS) might need extended time based on the amount of data. Customers who have DUAL PROV sites (Mixed-EPAP/PDB only EPAP) can upgrade with Live provisioning ON.

**Table 3: Upgrade time for EPAP 17.1 PROV EPAP - Mixed EPAP (Compact DB)/ PDBonly(eXtreme DB)**

DB Architecture	DN Count	IMSI Count	IMEI Count	Backup time	Restore Time	Overall upgrade time (Backup Time + Full Upgrade Time + Restore Time)
Compact	40M	0	0	3 minutes	30 minutes	4 hours
Compact	80M	0	0	6 minutes	1 hour	5 hours
Compact	120M	0	0	12 minutes	2 hour 45 minutes	7 hours

Compact	160M	0	0	15 minutes	4 hours and 30 minutes	8 hours
Compact	200M	0	0	25 minutes	6 hours 20 minutes	10 hours
Compact	240M	0	0	30 minutes	8 hours	12 hours
Compact	240M	240M	48M	27 minutes	7 hours	12 hours
eXtreme	240M	0	0	30 minutes	8 hours	12 hours
eXtreme	300M	0	0	35 minutes	11 hours	15 hours
eXtreme	360M	0	0	40 minutes	11 hours 50 minutes	17 hours
eXtreme	0	240M	0	15 minutes	30 minutes	7 hours
eXtreme	480M	555M	45M	26 minutes	6.5 Hrs	11 hours
eXtreme	420M	300M	180M	45 minutes	13.5 Hr	17 hours
eXtreme	480M	555M	45M	55 Minutes	13 Hours	17 hours

**Table 4: Upgrade time for EPAP 17.1 Non-PROV EPAP**

DB Architecture	DN Count	IMSI Count	IMEI Count	Backup time	Restore Time	Overall upgrade time
Compact	240M DN	240M	48M	30 Minutes	42 minutes	5 hours
eXtreme	0	240M	0	15 minutes	30 minutes	5 hours
eXtreme	480M	555M	45M	1 hour 18 minutes	2 hours	8 hours

### 3.2 Required Materials

- For Mixed EPAP or Non-Provisional EPAP: Two (2) target-release USB media (Greater than 2GB of size) or a target-release ISO file. For Standalone PDB: One (1) target-release USB media(Greater than 2GB of size) or a target-release ISO file
- A terminal and null modem cable to establish a serial connection.
- Write down the system configuration information.

Description	Information
PROVISIONABLE (Yes/No)	
PDBA state (Active/Standby)	
Provisioning IP (IPv4)	
Provisioning Mask (IPv4)	

Provisioning Default Router IP (IPv4)	
Provisioning IP (IPv6)	
Provisioning Netmask (IPv6)	
Provisioning Default Router IP (IPv6)	
NTP1 IP (IPv4/IPv6)	
NTP2 IP (IPv4/IPv6)	
NTP3 IP (IPv4/IPv6)	
Local VIP	
Remote VIP	
Local PDBA IP (IPv4)	
Local PDBA IP (IPv6)	
Remote PDBA IP (IPv4/IPv6)	
Remote PDBA B IP (IPv4/IPv6)	
RTDB Homing	
Time Zone	
PDBA Proxy Feature	
Others	

**Table 5: System Configuration Information**

- Passwords for users on the local system:

EPAP USERS		
login	MPS A password	MPS B password
epapconfig		
epapdev (needed for backout only)		
root		
epapall (needed for GUI access)		
admusr		

**Table 6: User Password Table**

## Installation Phases

The following table illustrates the progression of the installation process by procedure with estimated times. The estimated times and the phases that must be completed may vary due to differences in typing ability and system configuration. The phases outlined in Table 7 and Table 8 are to be performed in the order they are listed.

### 3.1.1 Installation Phases for Mixed and Non-Provisionable EPAP

Phase	Elapsed Time (Minutes)		Activity	Procedure
	This Step	Cum.		
Connectivity setup	15	15	Set up connectivity to the MPS Servers.	<a href="#">Procedure 1</a>
Verify install	5	20	Verify this should be an install.	<a href="#">Procedure 2</a>
Pre-upgrade check	15	35	Verify requirements for install are met.	<a href="#">Procedure 3</a>
Pre-install health check	5	40	Run the syscheck utility to verify that all servers are operationally sound.	<a href="#">Procedure 4</a>
Configure Server 1A	5	45	Set hostname, designation, function and time.	<a href="#">Procedure 5</a>
Configure Server 1B	5	50	Set hostname, designation, function and time.	<a href="#">Procedure 6</a>
Install Servers	30	80	Install software on sides 1A and 1B	<a href="#">Procedure 7</a> <a href="#">Procedure 8</a>
Configure Switches	30*	110*	Configure the Switches	<a href="#">Procedure 9</a>
Post-install application processing	30	140	Perform first time configuration.	<a href="#">Procedure 11</a>
Post-upgrade health check	5	145	Run the syscheck utility to verify all servers are operationally sound.	<a href="#">Procedure 4</a>

Phase	Elapsed Time (Minutes)		Activity	Procedure
	This Step	Cum.		
<b>**Configure Auto Backup</b>  <b>Note: Skip this step if the EPAP is configured as Non-Provisionable.</b>	5	150	Configure Auto Backup from PDB GUI on Provisionable EPAP's, this backup will also get scheduled on attached Non-Prov sites present on the setup.	<a href="#">Procedure A.25</a>
Check EPAP-EAGLE connectivity speed	20	170	Configure and verify that EAGLE SM cards are getting auto-negotiated to 1000Mbps/Full Duplex	0

**Table 7: Installation Phases for Mixed EPAP and Non-Provisional EPAP**

**Note:**

- If configuring 4 switches, add 30 minutes to the current setup. Configuring Auto backup is a compulsory step to enable PDB-RTDB translogs pruning.

### 3.1.2 Installation Phases for Standalone PDB

**Note: In the procedures below, skip the steps which need to be performed on MPS B, since MPS B is not present in the Standalone PDB configuration".**

Phase	Elapsed Time (Minutes)		Activity	Procedure
	This Step	Cum.		
Connectivity setup	15	15	Set up connectivity to the MPS Servers.	<a href="#">Procedure 1</a>
Verify install	5	20	Verify this should be an install.	<a href="#">Procedure 2</a>
Pre-upgrade check	15	35	Verify requirements for install are met.	<a href="#">Procedure 3</a>
Pre-install health check	5	40	Run the syscheck utility to verify that all servers are operationally sound.	<a href="#">Procedure 4</a>

Phase	Elapsed Time (Minutes)		Activity	Procedure
	This Step	Cum.		
Configure Server 1A	5	45	Set hostname, designation, function and time.	<a href="#">Procedure 5</a>
Install Server	30	75	Install software on sides 1A	<a href="#">Procedure 7</a>
Post-install application processing	30	105	Perform first time configuration. Refer to <a href="#">Procedure A.14</a> to configure the Standalone PDB in segmented network configuration.	<a href="#">Procedure 11</a>
Post-upgrade health check	5	110	Run the syscheck utility to verify all servers are operationally sound.	<a href="#">Procedure 4</a>
**Configure Auto Backup. <b>Note: Perform this step once Non-Provisionable EPAPs are attached to this Standalone PDB</b>	5	115	Configure Auto Backup from PDB GUI on Provisionable EPAP's, this backup will also get scheduled on attached Non-Prov sites present on the setup.	<a href="#">Procedure A.25</a>

**Table 8: Installation Phases for Standalone PDB**

**\*NOTE:** The time needed to backup application data is dependent on the amount of application data. This procedure cannot specify an exact length of time since different customers have different amounts of application data.

**\*\*NOTE:** Configuring Auto backup is a compulsory step to enable PDB-RTDB translog pruning.

## Full Upgrade Phases

The following table illustrates the progression of the full upgrade process by procedure with estimated times and may vary due to differences in typing ability and system configuration. The procedures outlined below are to be performed in the order they are listed.

**Note:** Before proceeding with the Full Upgrade process, refer to [Upgrading Provisionable mixed EPAP Mated Pairs](#) and [Upgrading EPAP Non-Provisionable MPS Servers](#) to get the overview of the EPAP setup and upgrade order.

### 3.1.3 Full Upgrade Phases for Mixed EPAP without live provisioning

Note: Do not add DN and DNBlock with lsblset parameter until all nodes in the network are migrated to EPAP 17.1 successfully.

Phase	Elapsed Time (Minutes)		Activity	Procedure
	This Step	Cum.		
Connectivity setup	15	15	Set up connectivity to the MPS servers.	<a href="#">Procedure 1</a>
Verify Full upgrade	5	20	Verify this should be a Full upgrade.	<a href="#">Procedure 2</a>
Pre-upgrade check	15	35	Verify requirements for Full Upgrade are met.	<a href="#">Procedure 3</a>
Pre-upgrade health check	5	40	Run the syscheck utility to verify the MPS server is operationally sound.	<a href="#">Procedure 4</a>
Assess readiness for upgrade	15	55	Assess the server's readiness for upgrade.	<a href="#">Procedure 14</a>
EPAP 16.3/16.4/17.1 RTDB and EuiDB Backups	*See notes below	*See notes below	Backup application databases and other pertinent information in case of backout required	<a href="#">Procedure A.6</a> <a href="#">Procedure A.7</a> <a href="#">Procedure A.8</a>
Take snapshot of uiEdit parameters	15	70	Take a snapshot of uiEdit parameters to be compared after migration is complete	<a href="#">Procedure A.39</a>
Change MySql engine schema	15	85	Change mysql schema from myiasm to innodb  Note: This procedure is not to be performed if migrating from 17.0.0.x.	<a href="#">Procedure A.31</a>
Save the EPAP 16.3/16.4/17.1 additional configurations	20	105	Save the NTP, EMS, QS, Automatic PDB-RTDB backup, Configure file transfer, schedule EPAP Tasks configurations, HTTP configurations	<a href="#">Procedure A.40</a>
Pre-upgrade Backup	*See notes below	*See notes below	Backup application databases and other pertinent information.	<a href="#">Procedure 15</a>

Phase	Elapsed Time (Minutes)		Activity	Procedure
	This Step	Cum.		
Pre-upgrade system time check	5	110	Pre-upgrade system time check.	<a href="#">Procedure 16</a>
IPM E5-APP-B Server	45	155	This Procedure will IPM the E5-APP-B Server  Note: IPM will be performed on both MPS A and B	<a href="#">Procedure A.13</a>
Configure Server 1A	5	160	Set hostname, designation, function and time.	<a href="#">Procedure 5</a>
Configure Server 1B	5	170	Set hostname, designation, function and time.	<a href="#">Procedure 6</a>
Install Servers	30	200	Install software on sides 1A and 1B	<a href="#">Procedure 7</a> <a href="#">Procedure 8</a>
Configure Switches	30	230	Configure the Switches	<a href="#">Procedure 9</a>
Post-install application processing	30	260	Perform first time configuration.	<a href="#">Procedure 11</a>
Post upgrade health check	5	265	Run the syscheck utility to verify the MPS server is operationally sound.	<a href="#">Procedure 4</a>
RTDB Converter	40	305	Run RTDB converter tool from Compact-to-Compact or Extreme-to-Extreme  <b>Note:</b> Applicable only in case of full upgrade from EPAP 16.3.1 to 17.1	<a href="#">Procedure 20</a>
Post upgrade EuiDB restore	5	310	Restore EuiDB database	<a href="#">Procedure A.32</a>
Restore PDB Backup	*See notes below	*See notes below	Restore EPAP 16.3.1/16.4.1/17.0.0.x PDB backup taken before fresh installation	<a href="#">Procedure A.33</a>
Restore RTDB Backup	*See notes below	*See notes below	Restore EPAP 16.3/16.4/17.0.0.x RTDB backup taken before fresh installation	<a href="#">Procedure A.36</a>
Reload RTDB from mate	30	340	Reload RTDB from mate on Non-prov MPS B.	<a href="#">Procedure A.11</a>

Phase	Elapsed Time (Minutes)		Activity	Procedure
	This Step	Cum.		
Reconfigure Additional EPAP configurations  <b>NOTE: After EPAP upgrade, if EMS is not able to receive alarms from EPAP, delete the EPAP from EMS discovery screen and then rediscover the EPAP on EMS.</b>  <b>Also, QS is not supported in EPAP 17.1 release. However, continue to note down the Query server details for future reference.</b>	45	385	Reconfigure the EMS, QS, Automatic PDB-RTDB backup, Configure file transfer, schedule EPAP Tasks configurations  Note: If HTTP was enabled before migration, then reconfigure the HTTP configuration by disabling the configuration first and then enabling the configuration again from EPAP GUI	<a href="#">Procedure A.41</a>
Take snapshot of uiEdit parameters on upgraded EPAP 17.1 servers	10	395	Take a snapshot of uiEdit parameters to be compared after migration is complete.	<a href="#">Procedure A.39</a>
Compare uiEdit parameters	10	405	Compare the snapshot taken in EPAP 17.0.0.y with the one taken on the EPAP 16.3/16.4 /17.1 before migration	<a href="#">Procedure A.42</a>
Start the PDB software	10	415	Re-activate the PDB on the Provisionable MPS A servers (PDBonly in this case).	<a href="#">Procedure 27</a>
Clear the Replication logs.	20	435	Clear the replication logs before connecting both the PDBAs  <b>NOTE:Perform this procedure in case of dual mixed EPAP.</b>	<a href="#">Procedure A.28</a>

Phase	Elapsed Time (Minutes)		Activity	Procedure
	This Step	Cum.		
Exchange the keys between active EPAP site and standby EPAP site	30	465	Keys exchange between active and standby EPAP sites.  <b>NOTE: Perform this procedure in case of dual mixed EPAP.</b>	<a href="#">Procedure A.35</a>
***Configure Auto Backup	5	470	Configure Auto Backup from EPAP GUI on Provisionable EPAP's, this backup will get scheduled on attached Non-Prov sites present on the setup.	<a href="#">Procedure A.25</a>
Reboot EAGLE Cards	*See notes below	*See notes below	Reboot Eagle Cards to reload updated DB	<a href="#">Procedure 21</a>
Accept the upgrade after successful soak period.  NOTE: If the node is to be converted from Compact to eXtreme DB architecture, delay this step until the conversion is done and sufficient soak time is given.	5	This is done in a separate MTC.	Accept the upgrade on both MPS-A and MPS-B after sufficient soak period of around 1-7 days (depending upon customer provisioning volume) to see that everything works fine after the upgrade.	<a href="#">Procedure 22</a>

**Table 9: Full Upgrade Phases for Mixed and Non-Provisionable EPAP**

**Note:**

- The time needed to backup application data is dependent on the amount of application data. This procedure cannot specify an exact length of time since different customers have different amounts of application data. The time needed to restore PDB backup (MysqIDump) is dependent on the amount of PDB database.
- If configuring 4 switches, add 30 minutes to the current setup.
- The time needed to reload EAGLE cards is dependent on the amount of application data. This procedure cannot specify an exact length of time since different customers have different amounts of application data.

- Configuring auto backup is a compulsory step to enable PDB-RTDB translog pruning. Ignore this step if auto-backup is already configured.
- In a dual PDBonly/dual Mixed server setup, if one PROV (StandAlone/Mixed-EPAP) site is upgraded to EPAP 17.x while the other PROV site remains on EPAP 16.x, do not designate the EPAP 17.x site as the Active provisioning server. Ensure that no provisioning is performed while EPAP 17.x is active and EPAP 16.x is on standby. Only after both sites have been upgraded to EPAP 17.x may either site running EPAP 17.x be designated as the Active Provisioning site.

In addition, EPAP 17.x will be made the Active provisioning server during the maintenance window, just before upgrading EPAP 16.3 (or lower) to 17.x. During this maintenance window when 17.x is active and 16.3 (or lower) is upgrading, no provisioning should be performed.

Failure to follow the above may result in replication issues and provisioning being blocked.

### Full Upgrade Phases for Dual Mixed EPAP without live provisioning

This procedure lists the procedure to upgrade Dual Mixed EPAP servers without live provisioning.

Phase	Activity	Procedure
Upgrading when both servers are on EPAP 16.3.1 or 16.4.1 release	Upgrade Standby PDBA site on EPAP 16.3.1 or 16.4.1 to EPAP 17.1	Procedure <a href="#">3.1.3</a>
Upgrading when one server is on EPAP 17.1 and other is on EPAP 16.3.1 or 16.4.1	Switchover PDBA sites to make server on EPAP 17.1 as Active PDBA site and server on EPAP 16.3.1 or 16.4.1 to standby site	If EPAP 16.3.1 or 16.4.1 is Active PDBA site from EPAP GUI, do a switchover PDBA to make it standby site before upgrade.
Upgrade EPAP 16.3.1 or 16.4.1 site	Upgrade Standby PDBA site on EPAP 16.3.1 or 16.4.1 to EPAP 17.1	Procedure <a href="#">3.1.3</a>

### 3.1.4 Full Upgrade Phases for Non-Provisionable EPAP with or without live provisioning

**Note:** This procedure can be used in with or without live provisioning scenario.

**Table 10: Full Upgrade Phases for Non-Provisionable EPAP with or without live provisioning**

Phase	Elapsed Time (Minutes)		Activity	Procedure
	This Step	Cum.		
Connectivity setup	15	15	Set up connectivity to the MPS servers.	<a href="#">Procedure 1</a>
Verify Full upgrade	5	20	Verify this should be a Full upgrade.	<a href="#">Procedure 2</a>
Pre-upgrade check	15	35	Verify requirements for Full Upgrade are met.	<a href="#">Procedure 3</a>
Pre-upgrade health check	5	40	Run the syscheck utility to verify the MPS server is operationally sound.	<a href="#">Procedure 4</a>
Assess readiness for upgrade	15	55	Assess the server's readiness for upgrade.	<a href="#">Procedure 14</a>
<b>EPAP 16.3/16.4/17.1 RTDB and EuiDB Backups</b>	*See notes below	*See notes below	Backup application databases and other pertinent information in case of backout required	<a href="#">Procedure A.7</a> <a href="#">Procedure A.8</a>
Take snapshot of uiEdit parameters	10	65	Take a snapshot of uiEdit parameters to be compared after migration is complete	<a href="#">Procedure A.39</a>
Change MySql engine schema	15	80	Change mysql schema from myiasm to innodb  Note: This procedure is not to be performed if migrating from 17.0.0.x.	<a href="#">Procedure A.31</a>
Pre-upgrade Backup	*See notes below	*See notes below	Backup application databases and other pertinent information.  Note: PDB Backup is not required so steps mentioned in the procedure to take PDB backup can be skipped	<b>Procedure 15</b>
Save the EPAP 16.3/16.4/17.1 additional configurations	20	100	Save the NTP, EMS, QS, Automatic PDB-RTDB backup, Configure file transfer, schedule EPAP Tasks configurations, HTTP configurations	<a href="#">Procedure A.40</a>
Pre-upgrade system time check	5	105	Pre-upgrade system time check.	<a href="#">Procedure 16</a>

Phase	Elapsed Time (Minutes)		Activity	Procedure
	This Step	Cum.		
IPM E5-APP-B Server	45	150	This Procedure will IPM the E5-APP-B Server  Note: IPM will be performed on both MPS A and B	<a href="#">Procedure A.13</a>
Configure Server 1A	5	155	Set hostname, designation, function and time.	<a href="#">Procedure 5</a>
Configure Server 1B	5	160	Set hostname, designation, function and time.	<a href="#">Procedure 6</a>
Install Servers	30	190	Install software on sides 1A and 1B	<a href="#">Procedure 7</a> <a href="#">Procedure 8</a>
Configure Switches	30	210	Configure the Switches	<a href="#">Procedure 9</a>
Post-install application processing	30	240	Perform first time configuration.	<a href="#">Procedure 11</a>
Full upgrade health check	5	245	Run the syscheck utility to verify the MPS server is operationally sound.	<a href="#">Procedure 4</a>
Change DB architecture from Compact to eXtreme on Non-Prov site  Read note carefully.  Note 1: Applicable in case of full upgrade from 16.3.1/16.4.1 in Extreme mode to 17.1 Extreme  Note 2: This step not needed in Compact (16.3/16.4) -> compact (17.1), compact- (16.3/16.4) >eXtreme (17.1)	45	290	Change DB architecture from compact to Extreme	<a href="#">Procedure 13</a>

Phase	Elapsed Time (Minutes)		Activity	Procedure
	This Step	Cum.		
RTDB Converter	*See notes below	*See notes below	Run RTDB converter tool from Compact-to-Compact or Extremet-to-Extreme on non-prov node depending upon the DB architecture before Full upgrade  Note: Applicable only in case of full upgrade from EPAP 16.3.1 to 17.1.	<a href="#">Procedure 20</a>
Post upgrade EuiDB restore	5	295	Restore EuiDB database	<a href="#">Procedure A.32</a>
Restore RTDB Backup	*See notes below	*See notes below	Restore EPAP 16.3/16.4/17.0.0.x RTDB backup taken before fresh installation	<a href="#">Procedure A.36</a>
Reload RTDB from mate	30	325	Reload RTDB from mate on Non-prov MPS B.	<a href="#">Procedure A.11</a>
Reconfigure Additional EPAP configurations  <b>NOTE: After EPAP upgrade, if EMS is not able to receive alarms from EPAP, delete the EPAP from EMS discovery screen and then rediscover the EPAP on EMS.</b>  <b>Also, QS is not supported in EPAP 17.1 release but continue to note down the Query srver details for future reference.</b>	45	370	Reconfigure the EMS, QS, Automatic PDB-RTDB backup, Configure file transfer, schedule EPAP Tasks configurations  Note: If HTTP was enabled before migration, then reconfigure the HTTP configuration by disabling the configuration first and then enabling the configuration again from EPAP GUI	<a href="#">Procedure A.41</a>
Take snapshot of uiEdit parameters on upgraded EPAP 17.1 servers	10	380	Take a snapshot of uiEdit parameters to be compared after migration is complete.	<a href="#">Procedure A.39</a>

Phase	Elapsed Time (Minutes)		Activity	Procedure
	This Step	Cum.		
Compare uiEdit parameters	10	390	Compare the snapshot taken in EPAP 17.0.0.y with the one taken on the EPAP 16.3/16.4/17.0.0.x before migration	<a href="#">Procedure A.42</a>
Reboot EAGLE Cards	*See notes below	*See notes below	Reboot Eagle Cards to reload updated DB	<a href="#">Procedure 21</a>
Accept the upgrade after successful soak period  NOTE: If the node is to be converted from Compact to eXtreme DB architecture, delay this step until the conversion is done and sufficient soak time is given.  <b>NOTE: After EPAP upgrade, if EMS is not able to receive alarms from EPAP, delete the EPAP from EMS discovery screen and then rediscover the EPAP on EMS.</b>	5	This is done in a separate MTC.	Accept the upgrade on both MPS-A and MPS-B after sufficient soak period of around 1-7 days (depending upon customer provisioning volume) to see that everything works fine after the upgrade.	<a href="#">Procedure 22</a>

**Note:**

- The time needed to backup application data is dependent on the amount of application data. This procedure cannot specify an exact length of time since different customers have different amounts of application data.
- The time needed to restore PDB backup (MysqIDump) is dependent on the amount of PDB database.
- This procedure cannot specify an exact length of time since different customers have different amounts of application data.
- If configuring 4 switches, add 30 minutes to the current setup.

- The time needed to reload EAGLE cards is dependent on the amount of application data. This procedure cannot specify an exact length of time since different customers have different amounts of application data.
- Configuring Auto backup is a compulsory step to enable PDB-RTDB translog pruning. Ignore this step if auto-backup is already configured.

### 3.1.4 Full Upgrade Phases for Dual Mixed with live provisioning

**Note:** Refer to [Appendix E](#) for things to be taken care while performing full upgrade with live provisioning.

**Note:** Do not add DN and DNBlock with lsblset parameter until all nodes in the network are migrated to EPAP 17.1 successfully.

Phase	Elapsed Time (Minutes)		Activity	Procedure
	This Step	Cum.		
Connectivity setup	15	15	Set up connectivity to the MPS servers.	<a href="#">Procedure 1</a>
Verify Full upgrade	5	20	Verify this should be a Full upgrade.	<a href="#">Procedure 2</a>
Pre-upgrade check	15	35	Verify requirements for upgrade are met.	<a href="#">Procedure 3</a>
Pre-upgrade health check	5	40	Run the syscheck utility to verify the MPS server is operationally sound.	<a href="#">Procedure 4</a>
Assess readiness for upgrade	15	55	Assess the server's readiness for upgrade.	<a href="#">Procedure 14</a>
<b>EPAP 16.3/16.4/17.1 RTDB, EuiDB and PDB Backups</b>	*See notes below	*See notes below	Backup application databases and other pertinent information in case of backout required	<a href="#">Procedure A.6</a> <a href="#">Procedure A.7</a> <a href="#">Procedure A.8</a>
Take snapshot of uiEdit parameters	15	70	Take a snapshot of uiEdit parameters to be compared after migration is complete	<a href="#">Procedure A.39</a>
Clear the repl logs	15	85	Verify that replication logs are cleared between active and standby EPAP's	<a href="#">Procedure A.28</a>

Reset RTDB homing policy	15	100	Modify the RTDB homing policy	<a href="#">Procedure A.30</a>
Remove remote PDBA IP from Standby PDBA site  <b>Note:</b> Make sure remote PDBA is present in Active PDBA site. Refer <a href="#">Appendix E.</a>	15	115	Delete the remote (Active) PDBA IP on Standby PDBA via epapconfig menu	<a href="#">Procedure A.29</a>
Change MySql engine schema	15	130	Change mysql schema from myiasm to innodb  Note: This procedure is not to be performed if migrating from 17.0.0.x.	<a href="#">Procedure A.31</a>
Save the EPAP 16.3/16.4/17.0.0.x additional configurations	20	150	Save the NTP, EMS, QS, Automatic PDB-RTDB backup, Configure file transfer, schedule EPAP Tasks configurations, HTTP configurations	<a href="#">Procedure A.40</a>
Pre-upgrade Backup  Note: Take PDB backup from the node migrated first in the network. Refer to <a href="#">Procedure A.6.</a>  Note: If the network speed between two PDBAs is very slow, follow the original procedure to perform PDBA backup via MySQL dump process. Refer to <a href="#">Procedure A.27.</a>	*See notes below	*See notes below	Backup application databases and other pertinent information.	<a href="#">Procedure 15</a>
Pre-upgrade system time check	5	155	Pre-upgrade system time check.	<a href="#">Procedure 16</a>
IPM E5-APP-B Server	45	200	This Procedure will IPM the E5-APP-B Server	<a href="#">Procedure A.13</a>

			<b>Note: IPM will be performed on both MPS A and B</b>	
Configure Server 1A	5	205	Set hostname, designation, function and time.	<a href="#">Procedure 5</a>
Configure Server 1B	5	210	Set hostname, designation, function and time.	<a href="#">Procedure 6</a>
Install Servers	30	240	Install software on sides 1A and 1B	<a href="#">Procedure 7</a> <a href="#">Procedure 8</a>
Configure Switches	30	270	Configure the Switches	<a href="#">Procedure 9</a>
Post-install application processing	30	300	Perform first time configuration Refer to <a href="#">Procedure A.14</a> to configure the Standalone PDB in segmented network configuration. <b>Note: Do not start the PDBA software after creating PDB.</b>	<a href="#">Procedure 11</a>
Full upgrade health check	5	305	Run the syscheck utility to verify the MPS server is operationally sound.	<a href="#">Procedure 4</a>
RTDB Converter	40	345	Run RTDB converter tool from Compact-to-Compact or Extreme-to-Extreme  <b>Note:</b> Applicable only in case of full upgrade from EPAP 16.3.1 to 17.1.	<a href="#">Procedure 20</a>
Post upgrade EuiDB restore	5	350	Restore EuiDB database	<a href="#">Procedure A.32</a>
<b>Note:</b> Make sure that before restoring the Standby PDBA, if the extreme DB is present on the setup then the PDB capacity should be set as per the DB capacity via epapconfig menu  Restore PDB Backup.  <b>Note:</b> If Second PDBA site is	*See notes below	*See notes below	Restore EPAP 16.3.1/16.4.1/17.0.0.x PDB backup taken before fresh installation	<a href="#">Procedure A.33</a>

<p>getting migrated, take backup from the already upgraded site and restore it on the PDBA node getting migrated. Refer <a href="#">Procedure A.43</a> and <a href="#">Procedure A.6</a> for PDB Backup.</p> <p>Note: If the network speed between two PDBAs is very slow, follow the original procedure to restore PDBA via MySQL dump process. Refer to <a href="#">Procedure A.33</a>.</p>				
Restore RTDB Backup	*See notes below	*See notes below	Restore EPAP 16.3.1/16.4.1/17.0.0.x RTDB backup taken before fresh installation	<a href="#">Procedure A.36</a>
Reload RTDB from mate	30	380	Reload RTDB from mate on Non-prov MPS B	<a href="#">Procedure A.11</a>
Exchange the keys between active EPAP site and standby EPAP site	30	410	Keys exchange between active and standby EPAP sites.	<a href="#">Procedure A.35</a>
Reset RTDB homing policy on Non-Prov nodes	*See notes below	*See notes below	Modify the RTDB homing to Non-Upgraded PDBA on Non-Prov Nodes	<a href="#">Procedure A.30</a>
<p><b>Note:</b></p> <p>1. Non-Prov must be homed to the Non-Upgraded PDBA (This applicable in case of first PDBA site upgrade)</p>				

2. Skip this step during the second PDBA site migration				
Reset RTDB homing policy on Prov PDBA	15	425	In case of Mixed EPAP node being migrated then RTDB homing must point to its own PDBA (Self)	<a href="#">Procedure A.44</a>
Reconfigure Additional EPAP configurations  <b>NOTE: After EPAP upgrade, if EMS is not able to receive alarms from EPAP, delete the EPAP from EMS discovery screen and then rediscover the EPAP on EMS.</b>  <b>Also, QS is not supported in EPAP 17.1. release but continue to note down the Query srver details for future reference.</b>	45	470	Reconfigure the EMS, QS, Automatic PDB-RTDB backup, Configure file transfer, schedule EPAP Tasks configurations.  Note: If HTTP was enabled before migration, then reconfigure the HTTP configuration by disabling the configuration first and then enabling the configuration again from EPAP GUI	<a href="#">Procedure A.41</a>
Take snapshot of uiEdit parameters on upgraded EPAP 17.0.0.y servers	10	480	Take a snapshot of uiEdit parameters to be compared after migration is complete	<a href="#">Procedure A.39</a>
Compare uiEdit parameters	10	490	Compare the snapshot taken in EPAP 17.0.0.y with the one taken on the EPAP 16.3/16.4 /17.0.0.x before migration	<a href="#">Procedure A.42</a>
Start the PDB software	10	500	Re-activate the PDB on the Provisionable MPS A servers (PDBonly in this case). <b>Note: Step only necessary during upgrade of a Provisionable mated EPAP pair (mixed EPAP).</b>	<a href="#">Procedure 27</a>

**Configure Auto Backup.	5	505	Configure auto backup to schedule RTDB Auto-Backup on NonProvisionable EPAP	<a href="#">Procedure A.25</a>
Accept the upgrade after successful soak period NOTE: If the node is to be converted from Compact to eXtreme DB architecture, delay this step until the conversion is done and sufficient soak time is given.  <b>NOTE: After EPAP upgrade, if EMS is not able to receive alarms from EPAP, delete the EPAP from EMS discovery screen and then rediscover the EPAP on EMS.</b>	5	This is done in a separate MTC.	Accept the upgrade on both MPS-A after sufficient soak period of around 1-7 days (depending upon customer provisioning volume) to see that everything works fine after the upgrade.	<a href="#">Procedure 22</a>

**Table 11: Full Upgrade Phases for Dual Mixed with live provisioning**

**Note:**

- When the Non-Upgraded PDBA site (Currently on 16.3.1/16.4.1) will be upgraded, do the following:
  - a. Perform switchover on the Non-Upgraded site (currently on 16.3.1/16.4.1) to make it as Standby PDBA.
  - b. The already upgraded site (on EPAP 17.1) will be the newly Active PDBA.
  - c. Then follow the Table 11 Full Upgrade Phases Dual Mixed with Live Provisioning to perform the upgrade.
- The time needed to backup application data is dependent on the amount of application data. This procedure cannot specify an exact length of time since different customers have different amounts of application data.

- The time needed to restore PDB backup (MysqIDump) is dependent on the amount of PDB database.
- This procedure cannot specify an exact length of time since different customers have different amounts of application data.
- If configuring 4 switches, add 30 minutes to the current setup.
- The time needed to reload EAGLE cards is dependent on the amount of application data. This procedure cannot specify an exact length of time since different customers have different amounts of application data.
- Configuring auto backup is a compulsory step to enable PDB-RTDB translog pruning. Ignore this step if auto-backup is already configured.
- In a dual PDBonly/dual Mixed server setup, if one PROV (StandAlone/Mixed-EPAP) site is upgraded to EPAP 17.x while the other PROV site remains on EPAP 16.x, do not designate the EPAP 17.x site as the Active provisioning server. Ensure that no provisioning is performed while EPAP 17.x is active and EPAP 16.x is on standby. Only after both sites have been upgraded to EPAP 17.x may either site running EPAP 17.x be designated as the Active Provisioning site.

In addition, EPAP 17.x will be made the Active provisioning server during the maintenance window, just before upgrading EPAP 16.3 (or lower) to 17.x. During this maintenance window when 17.x is active and 16.3 (or lower) is upgrading, no provisioning should be performed. Failure to follow the above may result in replication issues and provisioning being blocked.

### 3.1.6 Full Upgrade Phases for Standalone PDB without live provisioning

Note: Do not add DN and DNBlock with lsblset parameter until all nodes in the network are migrated to EPAP 17.1 successfully.

Phase	Elapsed Time (Minutes)		Activity	Procedure
	This Step	Cum.		
Connectivity setup	15	15	Set up connectivity to the MPS servers.	<a href="#">Procedure 1</a>
Verify Full upgrade	5	20	Verify this should be a Full upgrade.	<a href="#">Procedure 2</a>
Pre-upgrade check	15	35	Verify requirements for upgrade are met.	<a href="#">Procedure 3</a>
Pre-upgrade health check	5	40	Run the syscheck utility to verify the MPS server is operationally sound.	<a href="#">Procedure 4</a>

Assess readiness for upgrade	15	55	Assess the server's readiness for upgrade.	<a href="#">Procedure 14</a>
EPAP 16.3/16.4/17.0.0.x EuiDB and PDB Backups	*See notes below	*See notes below	Backup application databases and other pertinent information in case of backout required	<a href="#">Procedure A.6</a> <a href="#">Procedure A.8</a>
Take snapshot of uiEdit parameters	15	70	Take a snapshot of uiEdit parameters to be compared after migration is complete	<a href="#">Procedure A.39</a>
Change MySql engine schema	15	85	Change mysql schema from myiasm to innoDB  <b>Note:</b> This procedure is not to be performed if migrating from 17.0.0.x.	<a href="#">Procedure A.31</a>
Save the EPAP 16.3/16.4/17.1 additional configurations	20	105	Save the NTP, EMS, QS, Automatic PDB-RTDB backup, Configure file transfer, schedule EPAP Tasks configurations, HTTP configurations	<a href="#">Procedure A.40</a>
Pre-upgrade Backup	*See notes below	*See notes below	Backup application databases and other pertinent information. <b>Note: Copy database files (PDB and EuiDB) to backup server.</b>	<a href="#">Procedure 15</a>
Pre-upgrade system time check	5	110	Pre-upgrade system time check.	<a href="#">Procedure 16</a>
IPM E5-APP-B Server	45	155	This Procedure will IPM the E5-APP-B Server	<a href="#">Procedure A.13</a>
Configure Server 1A	5	160	Set hostname, designation, function, and time.	<a href="#">Procedure 5</a>
Install Server	30	190	Install software on sides 1A	<a href="#">Procedure 7</a>
Post-install application processing	30	220	Perform first time configuration Refer to <a href="#">Procedure A.14</a> to configure the Standalone PDB in segmented network configuration. <b>Note: Do not start the PDBA software after creating PDB.</b>	<a href="#">Procedure 11</a>
Full upgrade health check	5	225	Run the syscheck utility to verify the MPS server is operationally sound.	<a href="#">Procedure 4</a>
Change DB architecture from	45	270	Change DB architecture from compact to Extreme	<a href="#">Procedure 13</a>

<p>Compact to eXtreme on Non-Prov site</p> <p>Read the note carefully.</p> <p>Note 1: Applicable in case of full upgrade from 16.3.1/16.4.1 in Extreme mode to 17.1 Extreme</p> <p>Note 2: This step not needed in Compact (16.3/16.4) -&gt; compact (17.1), compact- (16.3/16.4) &gt;eXtreme (17.1).</p>				
Post upgrade EuiDB restore	5	275	Restore EuiDB database taken before fresh installation	<a href="#">Procedure A.32</a>
Restore PDB Backup	*See notes below	*See notes below	Restore EPAP 16.3/16.4/17.0.0.x PDB backup taken before fresh installation	<a href="#">Procedure A.33</a>
<p>Reconfigure Additional EPAP configurations</p> <p><b>NOTE: After EPAP upgrade, if EMS is not able to receive alarms from EPAP, delete the EPAP from EMS discovery screen and then rediscover the EPAP on EMS.</b></p> <p><b>Also, QS is not supported in EPAP 17.1 release, but continue to note down the Query server details for future reference.</b></p>	45	320	<p>Reconfigure the EMS, QS, Automatic PDB-RTDB backup, Configure file transfer, schedule EPAP Tasks configurations.</p> <p>Note: If HTTP was enabled before migration, then reconfigure the HTTP configuration by disabling the configuration first and then enabling the configuration again from EPAP GUI.</p>	<a href="#">Procedure A.41</a>

Take snapshot of uiEdit parameters on upgraded EPAP 17.0.0.y servers	10	330	Take a snapshot of uiEdit parameters to be compared after migration is complete.	<a href="#">Procedure A.39</a>
Compare uiEdit parameters	10	340	Compare the snapshot taken in EPAP 17.0.0.y with the one taken on the EPAP 16.3/16.4/17.0.0.x before migration.	<a href="#">Procedure A.42</a>
Start the PDB software.	10	350	Re-activate the PDB on the upgraded PDB server	<a href="#">Procedure 27</a>
**Configure Auto Backup.	5	355	Configure auto backup to schedule RTDB Auto-Backup on NonProvisionable EPAP.	<a href="#">Procedure A.25</a>
Configure PDB capacity	5	360	Configure the PDB capacity for 510 M DN's by following the given procedure.  This step is optional. Customers may follow it if they need to configure or update capacity at this stage.	<a href="#">Procedure A.54</a>
Accept the upgrade after successful soak period NOTE: If the node is to be converted from Compact to eXtreme DB architecture, delay this step until the conversion is done and sufficient soak time is given.  NOTE: After EPAP upgrade, if EMS is not able to receive alarms from EPAP, delete the EPAP from EMS discovery screen and then rediscover the EPAP on EMS.	5	This is done in a separate MTC.	Accept the upgrade on both MPS-A after sufficient soak period of around 1-7 days. (Depending upon customer provisioning volume) to see that everything works fine after the upgrade.	<a href="#">Procedure 22</a>

**Table 12: Full Upgrade Phases on Standalone PDB**

**Note:**

- The time needed to backup application data is dependent on the amount of application data. This procedure cannot specify an exact length of time since different customers have different amounts of application data.
- Configuring Auto backup is a compulsory step to enable PDB-RTDB translog pruning. Ignore this step if auto-backup is already configured.
- In a dual PDBonly/dual Mixed server setup, if one PROV (StandAlone/Mixed-EPAP) site is upgraded to EPAP 17.x while the other PROV site remains on EPAP 16.x, do not designate the EPAP 17.x site as the Active provisioning server. Ensure that no provisioning is performed while EPAP 17.x is active and EPAP 16.x is on standby. Only after both sites have been upgraded to EPAP 17.x may either site running EPAP 17.x be designated as the Active Provisioning site.

In addition, EPAP 17.x will be made the Active provisioning server during the maintenance window, just before upgrading EPAP 16.3 (or lower) to 17.x. During this maintenance window when 17.x is active and 16.3 (or lower) is upgrading, no provisioning should be performed. Failure to follow the above may result in replication issues and provisioning being blocked.

**3.1.7 Full upgrade Phases for Dual PDBonly with live provisioning**

**Note:** Refer Appendix E for things to be taken care while performing full upgrade with live provisioning.

**Note:** Do not add DN and DNBlock with lsblset parameter until all nodes in the network are migrated to EPAP 17.1 successfully.

Phase	Elapsed Time (Minutes)		Activity	Procedure
	This Step	Cum.		
Connectivity setup	15	15	Set up connectivity to the MPS servers.	<a href="#">Procedure 1</a>
Verify Full upgrade	5	20	Verify this should be a Full upgrade.	<a href="#">Procedure 2</a>
Pre-upgrade check	15	35	Verify requirements for upgrade are met.	<a href="#">Procedure 3</a>
Pre-upgrade health check	5	40	Run the syscheck utility to verify the MPS server is operationally sound.	<a href="#">Procedure 4</a>

Assess readiness for upgrade	15	55	Assess the server's readiness for upgrade.	<a href="#">Procedure 14</a>
EPAP 16.3/16.4/17.1 EuiDB and PDB Backups	*See notes below	*See notes below	Backup application databases and other pertinent information in case of backout required	<a href="#">Procedure A.6</a> <a href="#">Procedure A.8</a>
Take snapshot of uiEdit parameters	10	65	Take a snapshot of uiEdit parameters to be compared after migration is complete	<a href="#">Procedure A.39</a>
Clear the repl logs	15	80	STOP ACTIVE PDBA AND VERIFY REPL LOGS	<a href="#">Procedure A.28</a>
Remove remote PDBA IP from Standby PDBA site  Note: Make sure remote PDBA is present in Active PDBA site Refer Appendix E.	15	95	Delete the remote (Active) PDBA IP on Standby PDBA via epapconfig menu	<a href="#">Procedure A.29</a>
Reset RTDB homing policy to remote PDB	15	110	Modify the RTDB homing policy to active preferred alternate allowed	<a href="#">Procedure A.30</a>
Change MySql engine schema	15	125	Change mysql schema from myiasm to innnoDB  <b>Note:</b> This procedure is not to be performed if migrating from 17.0.0.x.	<a href="#">Procedure A.31</a>
Save the EPAP 16.3/16.4/17.1 additional configurations	20	145	Save the NTP, EMS, QS, Automatic PDB-RTDB backup, Configure file transfer, schedule EPAP Tasks configurations, HTTP configurations	<a href="#">Procedure A.40</a>
Pre-upgrade Backup  Note: Take PDB backup from the node migrated first in the network Refer to <a href="#">Procedure 6</a> .	*See notes below	*See notes below	Backup application databases and other pertinent information.	<a href="#">Procedure 15</a>
Pre-upgrade system time check	5	150	Pre-upgrade system time check.	<a href="#">Procedure 16</a>

IPM E5-APP-B Server	45	195	This procedure will IPM the E5-APP-B Server	<a href="#">Procedure A.13</a>
Configure Server 1A	5	200	Set hostname, designation, function and time.	<a href="#">Procedure 5</a>
Install Server	30	230	Install software on sides 1A	<a href="#">Procedure 7</a>
Post-install application processing	30	260	Perform first time configuration Refer to <a href="#">Procedure A.14</a> to configure the Standalone PDB in segmented network configuration. <b>Note: Do not start the PDBA software after creating PDB.</b>	<a href="#">Procedure 11</a>
Full upgrade health check	5	265	Run the syscheck utility to verify the MPS server is operationally sound.	<a href="#">Procedure 4</a>
Change DB architecture from Compact to eXtreme  Read the note carefully.  Note 1: Applicable in case of full upgrade from 16.3.1/16.4.1 in Extreme mode to 17.1 Extreme.  Note 2: This step not needed in Compact (16.3/16.4) -> compact (17.1), compact- (16.3/16.4) >eXtreme (17.1).	45	310	Change DB architecture from compact to Extreme	<a href="#">Procedure 13</a>
Post upgrade EuiDB restore	5	315	Restore EuiDB database	<a href="#">Procedure A.32</a>
<b>Note:</b> Make sure that before restoring the Standby PDBA, if the extreme DB is present on the setup then the PDB capacity should be set as per the DB	*See notes below	*See notes below	Restore EPAP 16.3/16.4/17.0.0.x PDB backup taken before fresh installation.	<a href="#">Procedure A.33</a>

<p>capacity via epapconfig menu.</p> <p>Restore PDB Backup.</p> <p><b>Note:</b> If Second PDBA site is getting migrated, take backup from the already upgraded site and restore it on the PDBA node getting migrated.</p> <p>Refer to <a href="#">Procedure A.43</a> for PDB Restore and <a href="#">Procedure A.6</a> for PDB Backup.</p>				
<p>Exchange the keys between active and standby PDB</p>	30	345	<p>Key exchange between Active PDB and Standby PDB</p>	<p><a href="#">Procedure A.35</a></p>
<p>Reconfigure Additional EPAP configurations</p> <p><b>NOTE: After EPAP upgrade, if EMS is not able to receive alarms from EPAP, delete the EPAP from EMS discovery screen and then rediscover the EPAP on EMS.</b></p> <p><b>Also, QS is not supported in EPAP 17.1 release but note down the Query server details for future reference.</b></p>	45	390	<p>Reconfigure the EMS, QS, Automatic PDB-RTDB backup, Configure file transfer, schedule EPAP Tasks configurations.</p> <p><b>Note:</b> If HTTP was enabled before migration, then reconfigure the HTTP configuration by disabling the configuration first and then enabling the configuration again from EPAP GUI.</p>	<p><a href="#">Procedure A.41</a></p>
<p>Take snapshot of uiEdit parameters on EPAP 17.1 servers.</p>	10	400	<p>Take a snapshot of uiEdit parameters to be compared after migration is complete.</p>	<p><a href="#">Procedure A.39</a></p>

Compare uiEdit parameters	10	410	Compare the snapshot taken in EPAP 17.1 with the one taken on the EPAP 16.3/16.4 before migration.	<a href="#">Procedure A.42</a>
Start the PDB software.	10	420	Reactivate the PDB on the Provisionable MPS A servers (PDBonly in this case). <b>Note:</b> Step only necessary during upgrade of a Provisionable mated EPAP pair (mixed EPAP + PDBonly).	<a href="#">Procedure 27</a>
**Configure Auto Backup.	5	425	Configure auto backup to schedule RTDB Auto-Backup on NonProvisionable EPAP.	<a href="#">Procedure A.25</a>
Configure PDB capacity	5	360	Configure the PDB capacity for 510 M DNs by following the given procedure.  This step is optional. Customers may follow it if they need to configure or update capacity at this stage.	<a href="#">Procedure A.54</a>
Reboot EAGLE Cards	*See notes below	*See notes below	Reboot Eagle Cards to reload updated DB	<a href="#">Procedure 21</a>

<p>Accept the upgrade after successful soak period.</p> <p>NOTE: If the node is to be converted from Compact to eXtreme DB architecture, delay this step until the conversion is done and sufficient soak time is given.</p> <p><b>NOTE: After EPAP upgrade, if EMS is not able to receive alarms from EPAP, delete the EPAP from EMS discovery screen and then rediscover the EPAP on EMS.</b></p>	5	This is done in a separate MTC.	<p>Accept the upgrade on both MPS-A after sufficient soak period of around 1-7 days (depending upon customer provisioning volume) to see that everything works fine after the upgrade.</p>	<a href="#">Procedure 22</a>
---	---	---------------------------------	--	------------------------------

**Table 13: Full Upgrade Phases Dual PDBOnly**

**Note:**

- When the Non-Upgraded PDBA site (Currently on 16.3.1/16.4.1) will be upgraded, do the following:
  - a. Perform switchover on the Non-Upgraded site (Currently on 16.3.1/16.4.1) to make it as Standby PDBA.
  - b. The already upgraded site (on EPAP 17.1) will be the newly Active PDBA.
  - c. Then follow the Table 13 Full Upgrade Phases Dual PDBOnly above to perform the upgrade.
- The time needed to backup application data is dependent on the amount of application data. This procedure cannot specify an exact length of time since different customers have different amounts of application data.
- Configuring Auto backup is a compulsory step to enable PDB-RTDB translog pruning. Ignore this step if auto-backup is already configured.
- In a dual PDBOnly/dual Mixed server setup, if one PROV (StandAlone/Mixed-EPAP) site is upgraded to EPAP 17.x while the other PROV site remains on EPAP 16.x, do not designate the EPAP 17.x site as the Active provisioning server. Ensure that no provisioning is performed while EPAP 17.x is active and EPAP 16.x is on standby. Only after both sites have been upgraded to EPAP 17.x may either site running EPAP 17.x be designated as the Active Provisioning site.

In addition, EPAP 17.x will be made the Active provisioning server during the maintenance window, just before upgrading EPAP 16.3 (or lower) to 17.x. During this maintenance window when 17.x is active and 16.3 (or lower) is upgrading, no provisioning should be performed. Failure to follow the above may result in replication issues and provisioning being blocked.

## Dual Image Upgrade Phases

**Note: DIU upgrade is not yet supported in the EPAP 17.1.x.x.x stream.**

The following table illustrates the progression of the various Dual Image Upgrade (DIU) process by procedure with phases, their estimated duration, and the procedure to be performed in every phase. The estimated duration of each upgrade phase may vary due to the differences in the typing ability and system configuration. The procedures outlined in the following tables are to be run in the same order.

**Note:** Before proceeding with the Dual Image Upgrade procedure, refer to section [Upgrading Provisionable mixed EPAP Mated Pairs](#) and [Upgrading EPAP Non-Provisionable MPS Servers](#) to get the overview of the EPAP setup and upgrade order.

### 3.1.8 Dual Image Upgrade Phases for Mixed EPAP without Live Provisioning

Phase	Elapsed Time (Minutes)		Activity	Procedure
	This Step	Cum.		
Connectivity setup	15	15	Set up connectivity to the MPS servers.	<a href="#">Procedure 1</a>
Verify Dual Image Upgrade	5	20	Verify this should be a Dual Image Upgrade.	<a href="#">Procedure 2</a>
Pre-upgrade check	15	35	Verify requirements for upgrade are met.	<a href="#">Procedure 3</a>
Pre-upgrade health check	5	40	Run the syscheck utility to verify the MPS server is operationally sound.	<a href="#">Procedure 4</a>
Assess readiness for upgrade	15	55	Assess the server's readiness for upgrade.	<a href="#">Procedure 14</a>
Pre-upgrade Backup	*See notes below	*See notes below	Backup application databases and other pertinent information.	<a href="#">Procedure 15</a>

Phase	Elapsed Time (Minutes)		Activity	Procedure
	This Step	Cum.		
Pre-upgrade system time check	5	60	Pre-upgrade system time check.	<a href="#">Procedure 16</a>
Upgrade MPS B	30	90	Execute the upgrade procedure on MPS B.	<a href="#">Procedure A.47</a>
Upgrade MPS A	30	120	Execute the upgrade procedure on MPS A.	<a href="#">Procedure A.47</a>
Post-upgrade health check	5	125	Run the syscheck utility to verify the MPS server is operationally sound.	<a href="#">Procedure 4</a>
Clear the Replication logs.	20	430	Clear the replication logs before connecting both the PDBAs.  <b>Note: Perform this procedure in case of dual mixed EPAP.</b>	<a href="#">Procedure A.28</a>
Exchange the keys between active EPAP site and standby EPAP site	30	465	Keys exchange between active and standby EPAP sites.  <b>Note: Perform this procedure in case of dual mixed EPAP.</b>	<a href="#">Procedure A.35</a>
Switchover PDBA to Active	5	130	Switchover the PDBA state to Active	<a href="#">Procedure A.48</a>
Configure Switches	30**	160**	Re-configure the switch and verify that EAGLE SM cards are getting auto negotiated to 1000Mbps/Full Duplex.  <b>Note: Skip this step if speed is already set to 1000Mbps/Full Duplex.</b>	<a href="#">Procedure 9</a>
Post-upgrade Backups	*See notes below	*See notes below	Backup application databases and other pertinent information.	<a href="#">Procedure 15</a>

Phase	Elapsed Time (Minutes)		Activity	Procedure
	This Step	Cum.		
Accept the upgrade after successful soak period.  NOTE: If the node is to be converted from Compact to eXtreme DB architecture, delay this step until the conversion is done and sufficient soak time is given.	5	This is done in a separate MTC.	Accept the upgrade on both MPS-A and MPS-B after sufficient soak period of around 1-7 days (depending upon customer provisioning volume) to see that everything works fine after the upgrade.	<a href="#">Procedure A.50</a>

**Table 14: Dual Image Upgrade Phases for Mixed EPAP without live provisioning**

**Note:**

- The time needed back up PDB data depends on the amount of application data. The duration of this procedure cannot specify an exact length of time to be specified as different customers have different amounts of application data.
- The time needed to restore PDB backup (MysqIDump) depends on the volume of data in the PDB database.
- The time needed to reload EAGLE cards depends on the amount of application data. The duration of this procedure cannot be specified as different customers have different amounts of application data.
- If configuring 4 switches, add 30 minutes to the current setup.
- Configuring auto backup is a compulsory step to enable PDB-RTDB translog pruning. Ignore this step if auto-backup is already configured.

### 3.1. 9 Dual Image Upgrade Phases for Dual Mixed EPAP without Live Provisioning

This procedure lists the procedure to upgrade Dual Mixed EPAP servers without live provisioning.

Phase	Activity	Procedure
Upgrading when both servers are on EPAP are on the 17.0.0.6 and above release.	Upgrade Standby PDBA site on EPAP 17.0.0.6 and above release to the latest EPAP release. After this switchover, upgrade the setup PDBA to Active and then upgrade the Standby PDBA site.	Refer to <a href="#">Procedure 3.1.9</a>

### 3.1.10 Dual Image Upgrade Phases for Non-Provisionable EPAP with or without live provisioning

Phase	Elapsed Time (Minutes)		Activity	Procedure
	This Step	Cum.		
Connectivity setup	15	15	Set up connectivity to the MPS servers.	<a href="#">Procedure 1</a>
Verify Dual Image Upgrade	5	20	Verify this should be a Dual Image Upgrade.	<a href="#">Procedure 2</a>
Pre-upgrade check	15	35	Verify requirements for upgrade are met.	<a href="#">Procedure 3</a>
Pre-upgrade health check	5	40	Run the syscheck utility to verify the MPS server is operationally sound.	<a href="#">Procedure 4</a>
Assess readiness for upgrade	15	55	Assess the server's readiness for upgrade.	<a href="#">Procedure 14</a>
Pre-upgrade Backup	*See notes below	*See notes below	Backup application databases and other pertinent information.	<a href="#">Procedure 15</a>
Pre-upgrade system time check	5	60	Pre-upgrade system time check.	<a href="#">Procedure 16</a>
Upgrade MPS B	30	90	Perform the upgrade procedure on MPS B.	<a href="#">Procedure A.47</a>

Phase	Elapsed Time (Minutes)		Activity	Procedure
	This Step	Cum.		
Upgrade MPS A	30	120	Perform the upgrade procedure on MPS A.	<a href="#">Procedure A.47</a>
Post-upgrade health check	5	125	Run the syscheck utility to verify the MPS server is operationally sound.	<a href="#">Procedure 4</a>
Configure Switches	30**	165**	Re-configure the switch and verify that EAGLE SM cards are getting auto negotiated to 1000Mbps/Full Duplex.  <b>Note: Skip this step if speed is already set to 1000Mbps/Full Duplex.</b>	<a href="#">Procedure 9</a>
Post-upgrade Backups	*See notes below	*See notes below	Back up application databases and other pertinent information.	<a href="#">Procedure 15</a>
Accept the upgrade after successful soak period.  <b>NOTE:</b> If the node is to be converted from Compact to eXtreme DB architecture, delay this step until the conversion is done and sufficient soak time is given.	5	This is done in a separate MTC.	Accept the upgrade on both MPS-A and MPS-B after sufficient soak period of around 1-7 days (depending upon customer provisioning volume) to verify that everything works fine after the upgrade.	<a href="#">Procedure A.50</a>

**Table 15: Dual Image Upgrade Phases for Non-Provisionable EPAP with or without live provisioning**

**Note:**

- The time needed to back up application data depends on the amount of application data. The duration of this procedure cannot specify an exact length of time sincebe specified as different customers have different amounts of application data.
- The time needed to restore PDB backup (MysqLDump) depends on the volume of data in the PDB database.
- The time needed to reload EAGLE cards depends on the amount of application data. The duration of this procedure cannot specify an exact length of time sincebe specified as different customers have different amounts of application data.

- If configuring 4 switches, add 30 minutes to the current setup.
- Configuring auto backup is a mandatory step to enable PDB-RTDB translog pruning. Ignore this step if auto-backup is already configured.

### 3.1.11 Dual Image Upgrade Phases for Dual Mixed with live provisioning

Phase	Elapsed Time (Minutes)		Activity	Procedure
	This Step	Cum.		
Connectivity setup	15	15	Set up connectivity to the MPS servers.	<a href="#">Procedure 1</a>
Verify Dual Image Upgrade	5	20	Verify this should be a Dual Image Upgrade.	<a href="#">Procedure 2</a>
Pre-upgrade check	15	35	Verify requirements for upgrade are met.	<a href="#">Procedure 3</a>
Pre-upgrade health check	5	40	Run the syscheck utility to verify the MPS server is operationally sound.	<a href="#">Procedure 4</a>
Assess readiness for upgrade	15	55	Assess the server's readiness for upgrade.	<a href="#">Procedure 14</a>
Pre-upgrade Backup Note: Take PDB backup from the node migrated first in the network. Refer to <a href="#">Procedure A.6</a> .  <b>Note:</b> If the network speed between two PDBA's is very slow, follow the original procedure to perform PDBA backup via MySQL dump process. Refer to <a href="#">Procedure A.27</a> .	*See notes below	*See notes below	Back up application databases and other pertinent information.	<a href="#">Procedure 15</a>

Phase	Elapsed Time (Minutes)		Activity	Procedure
	This Step	Cum.		
Clear the repl logs	15	85	Verify that replication logs are cleared between active and standby EPAPs.	<a href="#">Procedure A.28</a>
Reset RTDB homing policy	15	100	Modify the RTDB homing policy.	<a href="#">Procedure A.30</a>
Remove remote PDBA IP from Standby PDBA site  Note: Make sure remote PDBA is present in Active PDBA site. Refer <a href="#">Appendix E</a> .	15	115	Delete the remote (Active) PDBA IP on Standby PDBA via epapconfig menu.	<a href="#">Procedure A.29</a>
Pre-upgrade system time check	5	60	Pre-upgrade system time check.	<a href="#">Procedure 16</a>
Upgrade MPS B	30	90	Perform the upgrade procedure on MPS B.	<a href="#">Procedure A.47</a>
Upgrade MPS A	30	120	Perform the upgrade procedure on MPS A.	<a href="#">Procedure A.47</a>
Post-upgrade health check	5	125	Run the syscheck utility to verify the MPS server is operationally sound.	<a href="#">Procedure 4</a>
Exchange the keys between active EPAP site and standby EPAP site	30	410	Keys exchange between active and standby EPAP sites.	<a href="#">Procedure A.35</a>

Phase	Elapsed Time (Minutes)		Activity	Procedure
	This Step	Cum.		
Reset RTDB homing policy on Non-Prov nodes  <b>Note:</b> 1. Non-Prov must be homed to the Non-Upgraded PDBA (This applicable in case of first PDBA site upgrade)  2. Skip this step during the second PDBA site migration.	*See notes below	*See notes below	Modify the RTDB homing to Non-Upgraded PDBA on Non-Prov Nodes	<a href="#">Procedure A.30</a>
Reset RTDB homing policy on Prov PDBA.	15	425	If Mixed EPAP node is migrated, then RTDB homing must point to its own PDBA (Self).	<a href="#">Procedure A.44</a>
Configure Switches	30**	165**	Re-configure the switch and verify that EAGLE SM cards are getting auto negotiated to 1000Mbps/Full Duplex.  <b>Note: Skip this step if speed is already set to 1000Mbps/Full Duplex.</b>	<a href="#">Procedure 9</a>
Post-upgrade Backups	*See notes below	*See notes below	Back up application databases and other pertinent information.	<a href="#">Procedure 15</a>

Phase	Elapsed Time (Minutes)		Activity	Procedure
	This Step	Cum.		
Accept the upgrade after successful soak period  <b>NOTE:</b> If the node is to be converted from Compact to eXtreme DB architecture, delay this step until the conversion is done and sufficient soak time is given.	5	This is done in a separate MTC.	Accept the upgrade on both MPS-A and MPS-B after sufficient soak period of around 1-7 days (depending upon customer provisioning volume) to see that everything works fine after the upgrade.	<a href="#">Procedure A.50</a>

**Table 16: Dual Image Upgrade Phases for Dual Mixed with live provisioning**

**Note:**

- When the non-upgraded PDBA site (Currently on 17.1) will be upgraded, do the following:
  - a. Perform switchover on the non-upgraded site (Currently on 17.y) to make it as Standby PDBA.
  - b. The already upgraded site (on EPAP 17.1) will be the newly Active PDBA.
  - c. Then follow the above table Dual Image Upgrade Phases Dual Mixed with Live Provisioning to perform the upgrade.
- The time needed to back up application data depends on the amount of application data. The duration of this procedure cannot specify an exact length of time to be specified as different customers have different amounts of application data.
- The time needed to restore PDB backup (MysqLDump) depends on the amount of data in the PDB database.
- The duration of this procedure cannot specify an exact length of time sincebe specified as different customers have different amounts of application data.
- The time needed to reload EAGLE cards depends on the amount of application data. The duration of this procedure cannot specify an exact length of time to be specified as different customers have different amounts of application data.
- If configuring 4 switches, add 30 minutes to the current setup.
- Configuring auto backup is a compulsory step to enable PDB-RTDB translog pruning. Ignore this step if auto-backup is already configured.

### 3.1.12 Dual Image Upgrade Phases for Standalone PDB without live provisioning

Phase	Elapsed Time (Minutes)		Activity	Procedure
	This Step	Cum.		
Connectivity setup	15	15	Set up connectivity to the MPS servers.	<a href="#">Procedure 1</a>
Verify incremental upgrade	5	20	Verify this should be an incremental upgrade.	<a href="#">Procedure 2</a>
Pre-upgrade check	15	35	Verify requirements for upgrade are met.	<a href="#">Procedure 3</a>
Pre-upgrade health check	5	40	Run the syscheck utility to verify the MPS server is operationally sound.	<a href="#">Procedure 4</a>
Assess readiness for upgrade	15	55	Assess the server's readiness for upgrade.	<a href="#">Procedure 14</a>
Pre-upgrade Backup	*See notes below	*See notes below	Backup application databases and other pertinent information.	<a href="#">Procedure 15</a>
Pre-upgrade system time check	5	60	Pre-upgrade system time check.	<a href="#">Procedure 16</a>
Upgrade MPS A	30	90	Perform the upgrade procedure on MPS A.	<a href="#">Procedure A.47</a>
Post-upgrade health check	5	95	Run the syscheck utility to verify the MPS server is operationally sound.	<a href="#">Procedure 4</a>
Switchover PDBA to Active	5	100	Switchover the PDBA state to Active	<a href="#">Procedure A.48</a>
Post-upgrade Backups	*See notes below	*See notes below	Back up application databases and other pertinent information.	<a href="#">Procedure 15</a>

Phase	Elapsed Time (Minutes)		Activity	Procedure
	This Step	Cum.		
Accept the upgrade after successful soak period.  <b>NOTE:</b> If the node is to be converted from Compact to eXtreme DB architecture, delay this step until the conversion is done and sufficient soak time is given.	5	This is done in a separate MTC.	Accept the upgrade on both MPS-A and MPS-B after sufficient soak period of around 1-7 days (depending upon customer provisioning volume) to see that everything works fine after the upgrade.	<a href="#">Procedure A.50</a>

**Table 17: Dual Image Upgrade Phases for Standalone PDB without live provisioning**

**\*NOTE:** The time needed to backup application data is dependent on the amount of application data. This procedure cannot specify an exact length of time since different customers have different amounts of application data.

### 3.1.13 Dual Image Upgrade Phases for Dual PDBonly with live provisioning

Phase	Elapsed Time (Minutes)		Activity	Procedure
	This Step	Cum.		
Connectivity setup	15	15	Set up connectivity to the MPS servers.	<a href="#">Procedure 1</a>
Verify incremental upgrade	5	20	Verify this should be an incremental upgrade.	<a href="#">Procedure 2</a>
Pre-upgrade check	15	35	Verify requirements for upgrade are met.	<a href="#">Procedure 3</a>
Pre-upgrade health check	5	40	Run the syscheck utility to verify the MPS server is operationally sound.	<a href="#">Procedure 4</a>

Phase	Elapsed Time (Minutes)		Activity	Procedure
	This Step	Cum.		
Assess readiness for upgrade	15	55	Assess the server's readiness for upgrade.	<a href="#">Procedure 14</a>
Remove remote PDBA IP from Standby PDBA site  Note: Make sure remote PDBA is present in Active PDBA site Refer Appendix E.	15	95	Delete the remote (Active) PDBA IP on Standby PDBA via epapconfig menu	<a href="#">Procedure A.29</a>
Clear the repl logs	15	80	STOP ACTIVE PDBA AND VERIFY REPL LOGS	<a href="#">Procedure A.28</a>
Reset RTDB homing policy to remote PDB	15	110	Modify the RTDB homing policy to active preferred alternate allowed	<a href="#">Procedure A.30</a>
Pre-upgrade Backup	*See notes below	*See notes below	Backup application databases and other pertinent information.	<a href="#">Procedure 15</a>
Pre-upgrade system time check	5	60	Pre-upgrade system time check.	<a href="#">Procedure 16</a>
Upgrade MPS A	30	90	Execute the Upgrade procedure on MPS A.	<a href="#">Procedure A.47</a>
Post-upgrade health check	5	95	Run the syscheck utility to verify the MPS server is operationally sound.	<a href="#">Procedure 4</a>
Exchange the keys between active and standby PDB	30	300	Key exchange between Active PDB and Standby PDB	<a href="#">Procedure A.35</a>
Post-upgrade Backups	*See notes below	*See notes below	Backup application databases and other pertinent information.	<a href="#">Procedure 15</a>

Phase	Elapsed Time (Minutes)		Activity	Procedure
	This Step	Cum.		
Accept the upgrade after successful soak period  <b>NOTE:</b> If the node is to be converted from Compact to eXtreme DB architecture, delay this step until the conversion is done and sufficient soak time is given.	5	This is done in a separate MTC.	Accept the upgrade on both MPS-A and MPS-B after sufficient soak period of around 1-7 days (depending upon customer provisioning volume) to see that everything works fine after the upgrade.	<a href="#">Procedure A.50</a>

**NOTE:**

- When the non-upgraded PDBA site (Currently on 17.x) will be upgraded, do the following:
  - a. Perform switchover on the non-upgraded site (Currently on 17.xy) to make it as Standby PDBA.
  - b. The already upgraded site (on EPAP 17.y.0) will be the newly Active PDBA.
  - c. Then follow the above table Dual Image Upgrade Phases for Dual PDBOnly with live provisioning to perform the upgrade.
- The time needed to back up application data depends on the amount of application data. The duration of this procedure cannot specify an exact length of time to be specified as different customers have different amounts of application data.
- The time needed to restore PDB backup (MysqIDump) depends on the volume of data in the PDB database. The duration of this procedure cannot be specified as different customers have different amounts of application data.
- The time needed to reload EAGLE cards depends on the amount of application data. The duration of this procedure cannot be specified as different customers have different amounts of application data.
- If configuring 4 switches, add 30 minutes to the current setup.
- Configuring auto backup is a compulsory step to enable PDB-RTDB translog pruning. Ignore this step if auto-backup is already configured.

## Backout Phases

**Note:** Before proceeding with the backout process, refer to [section 2.1](#), [section 2.2](#), [section 2.3](#) and [section 2.4](#) to get the overview of the EPAP setup and the backout order.

### 3.1.14 Backout Phases for Mixed and Non-Provisionable EPAP

Phase	Elapsed Time (Hours or Minutes)		Activity	Impact	Procedure
	This Step	Cum .			
Determine state of system	15-30	15-30	Investigate and determine the state of the MPS system. This may take anywhere from 15 to 30 minutes.	Cannot proceed with backout until failure analysis is complete. Some hand-fixes may be required before proceeding with backout.	Contact My Oracle Support following the instructions on the front page or the instructions in the <b>My Oracle Support</b> section.
Backout MPS A and B	900	915-930	Backout MPS A and B.		<a href="#">Procedure A.45</a>
Configure Switches	30*	945-960*	Re-configure the switch and verify that EAGLE SM cards are getting auto negotiated to previous speed. <b>Note: Skip this step if speed before upgrade was 1000Mbps/Full Duplex.</b>	Verify that speed of switch is negotiated to previous speed.	<a href="#">Procedure 9</a>

**Table 108: Backout Phases for Mixed and Non-Provisionable EPAP**

\*NOTE: If configuring 4 switches, add 30 minutes to the current setup.

### 3.1.15 Backout Phases for Standalone PDB

Phase	Elapsed Time (Hours or Minutes)		Activity	Impact	Procedure
	This Step	Cum .			
Determine state of system	15-30	15-30	Investigate and determine the state of the MPS system. This may take anywhere from 15 to 30 minutes.	Cannot proceed with backout until failure analysis is complete. Some hand-fixes may be required before	Contact My Oracle Support following the instructions on the front page or the instructions in the

Phase	Elapsed Time (Hours or Minutes)		Activity	Impact	Procedure
	This Step	Cum .			
				proceeding with backout.	<b>My Oracle Support</b> section.
Backout PDBonly site.	600	615-630	Backout MPS A.		<a href="#">Procedure A.46</a>
Start the PDBA software	5	620-635	Re-activate the PDB on the Provisionable(PDBonly) MPS A servers.		<a href="#">Procedure 27</a>

**Table 119: Backout Phases for Standalone PDB**

### 3.1.16 Log Files

All commands executed during an upgrade or installation, are logged in the “/var/TKLC/log/upgrade/upgrade.log” file. This log file is automatically initiated when upgrade software is invoked. This log file is rolled every time an upgrade is initiated. A total of up to five upgrade log files are stored on the server.

The upgrade wrapper script, ugwrap, logs its actions also to the “/var/TKLC/log/upgrade/ugwrap.log” file. This log file is rolled every time ugwrap is initiated. A total of up to five ugwrap log files are stored on the server.

## 4 DB ARCHITECTURE OVERVIEW

A new parameter LSBLSET would be added to DN and DN Block tables. This parameter will be used along with CGPNBLSET parameter on EAGLE that would be configured in the linkset table on EAGLE. If the value of LSBLSET parameter for a DN/DN Block on EPAP is found to match with the CGPNBLSET parameter of linkset table on EAGLE, it will be considered as blocklisted DN/DN Block. IAM message will be released (i.e. send back to originator) from EAGLE for the corresponding DN/DN Block. In all other cases, the existing functionality will continue to hold true.

The existing DN/ DN Block table parameters that are configured in the GUI are stored in multiple SQL tables, the DN table for example has only two parameters dnID and PT(port type) parameters in it.

There are other tables (example dn\_bl, dn\_asd etc. ) which help in storing the other parameters entered in GUI forms for DN and DNBlock.

While entering values write operation, is performed with the help of multiple joins with these supporting tables.

Finally, while displaying these values during retrieve operation the join of all the supporting tables is taken and the values fetched are displayed together.

The new parameter LSBLSET is part of dn\_bl table and dnB\_bl SQL tables for DN and DN Block respectively. This new parameter will be compatible only with eagle 46.9 release.

From EPAP 16.3 onwards different DB architectures are supported i.e., “Compact” and “Extreme”. This was done to support enhanced DB capacity.

EPAP 16.4 also supports both compact and extreme architecture. Post upgrade user will remain on existing architecture and will have to change the architecture from compact to extreme as an optional step if required. In changing the DB Architecture from “Compact” to “eXtreme”, the EPAP software shall restart to support the capacity expansion. Before the change in DB Architecture on EPAP, the connecting EAGLE must upgrade to the new release with SLIC cards. Also, the user has-to enable the EPAPX feature on eagle card to support the eXtreme feature. Refer to section [4.3](#) to change DB Architecture from Compact to eXtreme.

**NOTE:** Section [4.2](#) and [4.3](#) are only required if customer setup is on compact architecture and wants to change architecture to extreme. Others i.e. those who are already on extreme architecture or doesn't want to change to extreme architecture can skip these sections.

### Overview of DB architecture change in Customer Network

Upgrade from EPAP 16.3.1/16.4.1 to EPAP 17.1 followed by DB Architecture conversion to support new LSBLSET parameter must be carried out as per the below table after upgrade is completed in same MTC window. Based on the existing DB Architecture either compact to compact converter script will be executed or extreme to extreme converter script will be executed. Follow procedure to identify DB architecture and run conversion script.

**Table 20: DB Conversion**

Base Release	Target Release	Data Base Architecture	Target Architecture	Converter Required
16.3.1	17.1	Compact	Compact	Compact to Compact converter to accommodate lsblset parameter
16.3.1	17.1	Extreme	Extreme	Extreme to Extreme converter to accommodate lsblset parameter
16.4.1	17.1	Compact	Compact	Compact to Compact converter to accommodate lsblset parameter
16.4.1	17.1	Extreme	Extreme	Extreme to Extreme converter to accommodate lsblset parameter

**\*Note: Allow soak period of around 1-7 days (depending upon customer provisioning volume) to see that everything works fine after the upgrade. After getting convinced that system is working fine, accept the upgrade.**

### Overview of DB architecture change from Compact to Extreme

Upgrade from EPAP 16.3.1/16.4.1 to EPAP 17.1 followed by DB Architecture conversion from Compact to Extreme must be carried out in following order with different MTC window:

**Note:** This step is required only when EPAP 17.1 and Eagle are to run in eXtreme mode. If EPAP and Eagle are to run in COMPACT mode, skip this section.

#### Phase-1 (Upgrade the EPAPs to EPAP 17.1 release in COMPACT mode):

NOTE: If the network consists of Non-PROVs and Mixed-EPAP, move to Phase-2 (Change the Mode from COMPACT mode to eXtreme mode for one Non-PROV site) otherwise continue with the following steps if the setup consists of StandAlonePDB + Non-PROVS.

1. First the Standalone PDBs will be upgraded to EPAP 16.4 in COMPACT mode. Refer to [section 3.4](#) for the upgrade process.
2. All non-PROVs should be upgraded to EPAP 17.1 in COMPACT mode. Refer to [section 3.4](#) for the upgrade process.

After this phase all EPAPs in the customer network are in EPAP 17.1 and are working in COMPACT mode.

#### Phase 2: Change the Mode from COMPACT mode to eXtreme mode for one Non-PROV site:

Execute the procedure in the following sequence.

1. Choose one EPAP-Eagle site from the customer network, which will be converted to eXtreme mode.
2. On the EAGLE, replace all non-SLIC SCCP cards to SLIC 64-bit SCCP cards. Change stpopts:EPAPX ON.
3. On the connecting Non-Prov, change the mode from COMPACT to eXtreme. Refer to [section 4.3](#) to change DB Architecture to eXtreme. The StandalonePDB should remain in COMPACT mode at this stage.
4. Restore RTDB on Non-Prov EPAP-A (refer to [Procedure A.10](#)) and after successfully restored RTDB on EPAP-A(refer to [Procedure A.11](#)), perform reload from mate on Non-Prov EPAP-B. Reload the Eagle from EPAP. Check that the DB downloads and EPAP-Eagle network work normally. Live provisioning flows all the way to Eagle. Let the node soak for some \*time-period.

### **Phase 3: Change the Mode from COMPACT mode to eXtreme mode for whole network:**

At this stage, we have seen that EPAP and Eagle are working fine in eXtreme mode. All the remaining Non-PROVs and StandAlone PDBs will be converted to eXtreme mode now. All the remaining Non-PROVs will be converted to eXtreme mode first. After all Non-PROVs are converted to eXtreme, the StandalonePDBs will be converted to eXtreme. For every site, before converting the EPAPs, connected eagles will have EPAPx feature ON.

1. First on the EAGLE, replace all non-SLIC SCCP cards to SLIC 64-bit SCCP cards. Change stpopts:EPAPX ON. Upgrade/Installation Guide 33 of 292 February 2023
2. On the connected Non-Prov, change the mode from Compact to eXtreme. Refer to [section 4.3](#) to change DB Architecture to eXtreme.
3. Reload the RTDB from already converted eXtreme mode RTDB in phase 1. Refer to [Procedure A.11](#).
4. Reload the Eagle SM cards from the EPAP.
5. Repeat steps 1 to 4 for all remaining Non-PROVs in the Customers network
6. Convert the StandalonePDBs to eXtreme mode.

### **Change DB Architecture from COMPACT to eXtreme to support EAGLE release 46.7.0.0.0 (eXtreme feature)**

The following table illustrates the progression of the movement of DB Architecture from COMPACT to eXtreme by procedure with estimated times and may vary due to differences in typing ability and system configuration. The procedures outlined in below Table 21 are to be executed in the order they are listed.

Before proceeding with the change DB Architecture process, refer to section 4 and section 5 to get the overview of the DB Architecture and upgrade order.

- Notes:**
1. Skip this section for mixed EPAP as eXtreme feature not supported on mixed EPAP.
  2. DB Architecture cannot be reverted to COMPACT once moved to eXtreme architecture.

#### 4.1.1 Phases to change DB Architecture to eXtreme (Standalone PDB)

Phase	Elapsed Time (Minutes)		Activity	Procedure
	This Step	Cum.		
Check database before changing DB architecture to eXtreme.	40	40	Check 9dig counts for all DN/IMSI and IMEI before changing DB architecture to eXtreme.	<a href="#">Procedure 17</a>
Change DB Architecture to eXtreme	40	80	<p><b>Note: Skip this procedure on Mixed EPAP.</b></p> <p>Change DB Architecture from COMPACT to eXtreme.</p> <p>Note: If parsing gets failed at this stage then user needs to run it manually. Check 0 to execute it manually.</p>	<a href="#">Procedure 13</a>
Accept the upgrade after successful soak period	5	This is done in a separate MTC	Accept the upgrade after sufficient soak period of around 1-7 days (depending upon customer provisioning volume) to see that everything works fine after the upgrade.	<a href="#">Procedure 21</a>

Table 21: Phases to change DB Architecture to eXtreme (Standalone PDB)

#### 4.1.2 Phases to change DB architecture to eXtreme (First Non-Prov site)

Phase	Elapsed Time (Minutes)		Activity	Procedure
	This Step	Cum.		
Check database before changing DB architecture to eXtreme.	*see notes below	*see notes below	<b>NOTE: Perform this step on attached PDBonly EPAP if not already executed.</b>  Check 9dig counts for all DN/IMSI and IMEI before changing DB architecture to eXtreme.	<a href="#">Procedure 17</a>
Take backup before moving to eXtreme architecture	**See notes below	**See notes below	Take RTDB backup if not already taken, before moving to eXtreme architecture.  <b>Note: Skip this step for PDBonly.</b>	<b>0</b>
Change DB Architecture to eXtreme	5	5	Change DB Architecture from COMPACT to eXtreme  <b>Note:</b> EPAPX feature must be "ON" on the connected eagle before procedure 13	<a href="#">Procedure 13</a>
Restore RTDB backup on Non-prov.	240	245	Restore RTDB backup on Non-prov MPS A.	<b>0</b>
Reload RTDB from mate	10	255	Reload RTDB from mate on Non-prov MPS B.	<b>0</b>
Accept the upgrade after successful soak period	5	This is done in a separate MTC	Accept the upgrade on both MPS-A and MPS-B after sufficient soak period of around 1-7 days (depending upon customer provisioning volume) to see that everything works fine after the upgrade.	<a href="#">Procedure 21</a>

**Table 22: Phases to change DB Architecture to eXtreme (First Non-prov site)**

**\*NOTE:** The time for checking database will be added for attached PDBonly EPAP (Added in section 4.2.1).

**\*\*NOTE:** The time needed to backup application data is dependent on the amount of application data. This procedure cannot specify an exact length of time since different customers have different amounts of application data.

### 4.1.3 Phases to change DB architecture to eXtreme (Remaining Non-Prov sites)

Phase	Elapsed Time (Minutes)		Activity	Procedure
	This Step	Cum.		
Take backup before moving to eXtreme architecture	*See notes below	*See notes below	Take RTDB backup if not already taken, before moving to eXtreme architecture.  <b>Note: Skip this step for PDBonly.</b>	<b>0</b>
Change DB Architecture to eXtreme	5	5	Change DB Architecture from COMPACT to eXtreme  <b>Note:</b> EPAPX feature must be "ON" on the connected eagle before procedure 13	<a href="#">Procedure 13</a>
Reload RTDB from remote	10	15	Reload the RTDB from remote(already in eXtreme mode)  <b>Note: Remote Non-Prov EPAP must be in eXtreme mode.</b> (Which may be the first Non-Prov site converted in table 19 or any other remote EPAP which is already in eXtreme mode)	<b>0</b>
Reload RTDB from mate	10	25	Reload RTDB from mate on Non-prov MPS B.	<b>0</b>
Accept the upgrade after successful soak period	5	This is done in a separate MTC	Accept the upgrade on both MPS-A and MPS-B after sufficient soak period of around 1-7 days (depending upon customer provisioning volume) to see that everything works fine after the upgrade.	<a href="#">Procedure 21</a>

**Table 23: Phases to change DB Architecture to eXtreme (Remaining Non-Prov sites)**

**\*NOTE:** The time needed to backup application data is dependent on the amount of application data. This procedure cannot specify an exact length of time since different customers have different amounts of application data.

## 5 UPGRADE PREPARATION

### Setting up the upgrade environment

#### Procedure 1: Setting up the upgrade environment

<b>S T E P #</b>	<p>This procedure sets up the upgrade environment. Windows are opened for both MPS servers.</p> <p><b>NOTE: Call My Oracle Support for assistance if modem access is the method use for upgrade.</b></p> <p>Check off (✓) each step as it is completed. Boxes have been provided for this purpose under each step number.</p> <p>IF THIS PROCEDURE FAILS, CONTACT MY ORACLE SUPPORT AND <b>ASK FOR <u>UPGRADE ASSISTANCE</u></b>.</p>	
1.	<p>Upgrade can be done in two ways:</p> <p>A. Remotely</p> <p>B. Locally</p>	<p>Refer to Step 2 to 6 for executing remotely.</p> <p>Refer to Step 7 to 19 for executing locally.</p>
2. <input type="checkbox"/>	<p><b>Ensure MPS X:</b></p> <p>All the console/PuTTY Sessions.</p>	<p>On all the console/PuTTY sessions, make sure that the logging in enabled and logs are written to a file. For example, on a PuTTY session, do the following.</p> <ol style="list-style-type: none"> <li>1. Right click on the top bar in the PuTTY and choose “change setting”.</li> <li>2. Click on “Logging”.</li> <li>3. Select “Printable output”.</li> <li>4. Click on “Browse” and choose where you want the logs to be written so that you can collect those later, if needed. Put a name which will serve better on a later date to understand, for example, name of the log file can be <b>&lt;server name&gt;_active_pdba_A_server_puttylog_ddmmyyyy</b>.</li> <li>5. Click on “Save”.</li> <li>6. Type a text “Putty Logging starts” in the PuTTY session and check that above text is logged in the PuTTY log file.</li> </ol> <p>Repeat the above six steps on every console/PuTTY session that will be used to enter commands or execute procedure of this document.</p>

## Procedure 1: Setting up the upgrade environment

3.	<p>Access to the MPS servers is available through an IP network.</p> <p>Step 3 and 4 provide console access to MPS-B from a remote location.</p> <p><b>MPS A:</b> Log in to the server as user "admusr".</p>	<p>If not already logged in, then log in.</p> <pre>&lt;hostname&gt; console login: admusr Password: &lt;password&gt;</pre>
4.	<p><b>MPS A:</b> Start screen session</p> <p><b>MPS A:</b> Connect to the console of MPS B.</p>	<p>Run the following commands to start screen and establish a console session to MPS B.</p> <pre>\$ screen -L</pre> <p>Run the following command on E5-APP-B:</p> <pre>\$ sudo minicom mate</pre> <p><b>Note:</b> Now user is connected to the console of MPS-B from a remote location.</p>
5.	<p>Step 5 and 6 provide console access to MPS-A from a remote location.</p> <p><b>MPS B:</b> Log in to the server as user "admusr".</p>	<p>If not already logged in, then log in.</p> <pre>&lt;hostname&gt; console login: admusr Password: &lt;password&gt;</pre>
6.	<p><b>MPS B:</b> Start screen session</p> <p><b>MPS B:</b> Connect to the console of MPS A.</p> <p>Note down the timestamp in log.</p>	<p>Run the following commands to start screen and establish a console session to MPS A.</p> <pre>\$ screen -L</pre> <p>Run the following command on E5-APP-B:</p> <pre>\$ sudo minicom mate</pre> <p>Run the following command:</p> <pre>\$ date</pre> <p><b>Note:</b> Now user is connected to the console of MPS-A from a remote location.</p>

## Procedure 1: Setting up the upgrade environment

		<p><b>Note:</b> If upgrade is to be performed from a remote location skip rest of the procedure.</p> <p>If upgrade is to be performed locally then follow step 7 to 19.</p>
7.	<p><b>Ensure MPS X:</b> All the console/PuTTY Sessions.</p>	<p>On all the console/PuTTY sessions, make sure that the logging is enabled and logs are written to a file. For example, on a PuTTY session, do the following.</p> <ol style="list-style-type: none"> <li>1. Right click on the top bar in the PuTTY and choose “change setting”.</li> <li>2. Click on “Logging”.</li> <li>3. Select “Printable output”.</li> <li>4. Click on “Browse” and choose where you want the logs to be written so that you can collect those later, if needed. Put a name which will serve better on a later date to understand, for example, name of the log file can be <b>&lt;server name&gt;_active_pdba_A_server_puttylog_ddmmyyyy</b>.</li> <li>5. Click on “Save”.</li> <li>6. Type a text “Putty Logging starts” in the PuTTY session and check that above text is logged in the PuTTY log file.</li> </ol> <p>Repeat the above six steps on every console/PuTTY session that will be used to enter commands or execute procedure of this document.</p>
8.	<p>Establish a connection to MPS A.</p>	<p>Access to the MPS servers is not available through an IP network, Connect to the E5-APP-B card via the serial port</p> <p>For connecting the E5-APP-B A card, disconnect the console cable from the serial port on the E5-APP-B B card’s adapter. The cable should be disconnected at the point where it connects to the serial port labeled ‘S1’ on the E5-APP-B B card’s adapter and use it for serial access by connecting the serial cable to the customer laptop’s serial port. Cable part numbers - 830-1220-xx</p>
9.	<p><input type="checkbox"/> Create a terminal window for MPS A. <b>Note:</b> Steps 9 to 12 make the serial connection to MPS-A</p>	<p>Create a terminal window e.g. open a putty session on the workstation and give it a title of <b>“MPS A”</b></p>
10.	<p><input type="checkbox"/> <b>MPS A:</b> Enable capture file and verify the correspondent file is created.</p>	<p>Enable the data capture and verify that the data capture file is created at the path specified.</p>
11.	<p><input type="checkbox"/> Log in to MPS A.</p>	<p><b>&lt;hostname&gt; console login: admusr</b> <b>password: &lt;password&gt;</b></p>

### Procedure 1: Setting up the upgrade environment

12. <input type="checkbox"/>	<b>MPS A:</b> Start screen Session.	Run the following command to start screen and establish a console session with MPS A. <b>\$ screen -L</b>  If for Standalone PDB, the procedure is complete. Otherwise, continue with the next step.
13. <input type="checkbox"/>	Establish a connection to MPS B.  <b>Note:</b> Steps 13 to 17 make the serial connection to MPS-B	Access to the MPS servers is not available through an IP network, connect to the E5-APP-B card via the serial port.  For connecting the E5-APP-B B card, disconnect the console cable from the serial port on the E5-APP-B A card's adapter. The cable should be disconnected at the point where it connects to the serial port labeled 'S1' on the E5-APP-B A card's adapter and use it for serial access by connecting the serial cable to the customer laptop's serial port. <b>Cable part numbers - 830-1220-xx</b>
14. <input type="checkbox"/>	Create a terminal window for MPS B.	Create a terminal window e.g. open a putty session on the workstation and give it a title of " <b>MPS B</b> "
15. <input type="checkbox"/>	<b>MPS B:</b> Enable capture file and verify a correspondent file is created.	Enable the data capture and verify that the data capture file is created at the path specified.
16. <input type="checkbox"/>	Log in to MPS B.	<b>&lt;hostname&gt; console login: admusr password: &lt;password&gt;</b>
17. <input type="checkbox"/>	<b>MPS B:</b> Start screen Session.	Run the following command to start screen and establish a console session with MPS B. <b>\$ screen -L</b>
18. <input type="checkbox"/>	<b>MPS A and B:</b> Procedure Complete.	This procedure is complete.
19. <input type="checkbox"/>	Note down the timestamp in log.	Run the following command: <b>\$ date</b>

### Determine if upgrade or installation is required

#### Procedure 2: Determine if upgrade or installation is required

<b>S T E P #</b>	This procedure executes the steps required to determine if an upgrade of the system is required or an initial application installation is required. Check off (✓) each step as it is completed. Boxes have been provided for this purpose under each step number.  IF THIS PROCEDURE FAILS, CONTACT MY ORACLE SUPPORT AND <b>ASK FOR UPGRADE ASSISTANCE.</b>	
	1.	<b>MPS A:</b> Log in to MPS A. If not already logged in, login at MPS A as 'admusr'.

**Procedure 2: Determine if upgrade or installation is required**

<input type="checkbox"/>		<pre>&lt;hostname&gt; console login: admusr password: &lt;password&gt;</pre>
<input type="checkbox"/>	<p>2. <b>MPS B:</b> Log in to MPS B.</p>	<p>If not already logged in, login at MPS B as 'admusr'.</p> <pre>&lt;hostname&gt; console login: admusr password: &lt;password&gt;</pre>
<input type="checkbox"/>	<p>3. <b>MPS B:</b> Determine if the application is currently installed on the servers.</p> <p>(MPS B will be used to determine the current state of the servers. We will assume that the state of the A server is the same).</p>	<p>Execute an rpm query command and examine the output:</p> <pre>\$ rpm -qi TKLCepap</pre> <pre>Name       : TKLCepap           Relocations: (not relocatable) Version    : 170.0.8           Vendor: Tekelec Release    : 0.68940          Build Date: Thu 29 Dec 2022 04:10:07 AM EST Install Date: Mon 02 Jan 2023 02:11:44 AM EST  Build Host: localhost Group      : Development/Build Source RPM: TKLCepap-170.0.8-0.68940.src.rpm Size       : 119091549         License: © TEKELEC 2005-2018 Signature  : (none) Packager   : &lt;@tekelec.com&gt; URL        : http://www.tekelec.com/ Summary    : Oracle Communications EPAP Package Description:</pre> <p>This is the Oracle Communications EAGLE Application Processor(EPAP) Package. The Package installs EPAP software. EPAP provides Provisioning Database Application (PDBA on A side) and Real Time Database (RTDB).</p>
<input type="checkbox"/>	<p>4. <b>MPS B:</b> Observe the output from the rpm query.</p>	<p>The following is an example of what the output may look like:</p> <pre>\$ appRev</pre> <pre>Install Time: Tue Jul 3 03:52:57 2018 Product Name: EPAP Product Release: 16.3.0.0.0_163.8.0 Base Distro Product: TPD Base Distro Release: 7.6.0.0.0_88.48.0 Base Distro ISO: TPD.install-7.6.0.0.0_88.48.0-OracleLinux6.9-x86_64.iso ISO name: EPAP-16.3.0.0.0_163.8.0-x86_64.iso</pre>

## Procedure 2: Determine if upgrade or installation is required

		OS: OracleLinux 6.9  If the output similar-to the above example is displayed, then skip to step 6. Otherwise, proceed to the next step.
5. <input type="checkbox"/>	<b>MPS B:</b> Installation is required if the application is not present on the server, else upgrade is required.	If the application is not currently installed, output similar-to the example below will be returned from the <b>rpm -qi</b> command in step-3. If this is the case, then an application <b>installation</b> is required. Refer to <a href="#">section 3.1.1</a> to perform EPAP installation.  <pre>\$ rpm -qi TKLCepap package TKLCepap is not installed</pre> Skip to step 10.
6. <input type="checkbox"/>	<b>MPS B:</b> Determine which version of the application is present.	Write Down the Release Number:  Release Number: _____  If the release number on the MPS is less than the release number on the upgrade media, then an upgrade is required.
7. <input type="checkbox"/>	Determine if Full Upgrade is required.	If the current release is 16.3.1/16.4.1 and target release is 17.1, it is a <b>FULL UPGRADE</b> .
8. <input type="checkbox"/>	Determine if an incremental Upgrade is required.	If the current release is 17.0.x.x and target release is 17.1 (x.x is less than the number y.y on the upgrade media), it is a <b>Dual Image Upgrade</b> .
9. <input type="checkbox"/>	<b>MPS A:</b> Determine if it is Provisionable (either mixed-EPAP or PDBonly) or Non-Provisionable EPAP setup.	Run the following command to determine if the EPAP is Provisionable (either mixed-EPAP or PDBonly) or Non-Provisionable.  <pre>\$ uiEdit   grep "PROVISIONABLE" "PROVISIONABLE_MPS" is set to "YES"</pre> If the above output contains "YES", then the EPAP is Provisionable (either mixed-EPAP or PDBonly). Otherwise, the EPAP is Non-Provisionable. Write down this information.  EPAP setup type: _____
10. <input type="checkbox"/>	<b>MPS B:</b> Determine if the current DB Architecture is	Run the following command to determine if the EPAP DB Architecture is Extreme or Compact.

**Procedure 2: Determine if upgrade or installation is required**

	<p>compact or extreme.</p> <p>(MPS B will be used to determine the current state of the servers. We will assume that the state of the A server is the same).</p>	<pre>\$ uiEdit   grep "DB_ARCHITECTURE" "DB_ARCHITECTURE" is set to "COMPACT"</pre> <p>If the above output contains "COMPACT" or no output is displayed, then the EPAP DB Architecture is Compact.</p> <p>If the above output contains "EXTREME", then the EPAP DB Architecture is Compact. Write down this information.</p> <p>EPAP DB Architecture type: _____</p> <p>Based on this information DB converter will be run.</p>
<p>11. <input type="checkbox"/></p>	<p><b>MPS A and B:</b> Procedure Complete.</p>	<p>This procedure is complete.</p>
<p>12. <input type="checkbox"/></p>	<p>Note down the timestamp in log.</p>	<p>Run the following command: <b>\$ date</b></p>

**Pre-upgrade requirements**

**Procedure 3: Verifying Pre-Upgrade Requirements and Capturing Upgrade Data**

<p><b>S T E P #</b></p>	<p>This procedure verifies that all pre-upgrade requirements have been met.</p> <p>Check off (✓) each step as it is completed. Boxes have been provided for this purpose under each step number.</p> <p>IF THIS PROCEDURE FAILS, CONTACT MY ORACLE SUPPORT AND ASK FOR <u>UPGRADE ASSISTANCE</u>.</p>	
<p>1. <input type="checkbox"/></p>	<p>Verify all required materials are present.</p>	<p>Verify that the materials listed in Upgrade Material List (<a href="#">Section 3.2</a>) are present.</p>
<p>2. <input type="checkbox"/></p>	<p>Verify the availability of passwords for MPS systems.</p>	<p>Refer to <a href="#">Table 6</a> <b>Error! Reference source not found.</b> for the list of users.</p>
<p>3. <input type="checkbox"/></p>	<p>Review provisioning rules.</p>	<p>Please review the Provisioning information as defined in <a href="#">Section 3.1</a>. If you do not understand the information provided in this section, contact My Oracle Support following the instructions on the front page or the instructions in the <b>My Oracle Support</b> section</p>
<p>4. <input type="checkbox"/></p>	<p>Verify and close active GUI Sessions.</p> <p>On the menu, click User Administration-&gt;HTTP(s) Support-&gt;Terminate UI Sessions</p>	<p><b>Skip this step for fresh install.</b></p> <p>Log in to EPAP GUI as uiadmin user. Terminate all the active GUI sessions from EPAP GUI.</p>

		<p style="text-align: right;">A <span style="float: right;">Terminate Active UI Sessions</span></p> <hr/> <table border="1"> <thead> <tr> <th>Delete?</th> <th>Session Id</th> <th>User Id</th> <th>User Name</th> <th>Admin</th> <th>IP Addr</th> <th>Last Access</th> </tr> </thead> <tbody> <tr> <td><input type="radio"/></td> <td>44</td> <td>99</td> <td>wiadmin</td> <td>YES</td> <td>10.250.32.216</td> <td>2017-06-20 07:04:11</td> </tr> <tr> <td><input type="radio"/></td> <td>45</td> <td>99</td> <td>wiadmin</td> <td>YES</td> <td>10.250.32.216</td> <td>2017-06-20 07:04:20</td> </tr> <tr> <td><input type="radio"/></td> <td>46</td> <td>99</td> <td>wiadmin</td> <td>YES</td> <td>10.250.32.216</td> <td>2017-06-20 07:04:33</td> </tr> </tbody> </table> <p><input type="button" value="Delete Selected Active Session"/></p> <p>Select all sessions and click on “Delete Selected Active Session” to delete all active sessions.</p>	Delete?	Session Id	User Id	User Name	Admin	IP Addr	Last Access	<input type="radio"/>	44	99	wiadmin	YES	10.250.32.216	2017-06-20 07:04:11	<input type="radio"/>	45	99	wiadmin	YES	10.250.32.216	2017-06-20 07:04:20	<input type="radio"/>	46	99	wiadmin	YES	10.250.32.216	2017-06-20 07:04:33
Delete?	Session Id	User Id	User Name	Admin	IP Addr	Last Access																								
<input type="radio"/>	44	99	wiadmin	YES	10.250.32.216	2017-06-20 07:04:11																								
<input type="radio"/>	45	99	wiadmin	YES	10.250.32.216	2017-06-20 07:04:20																								
<input type="radio"/>	46	99	wiadmin	YES	10.250.32.216	2017-06-20 07:04:33																								
5. <input type="checkbox"/>	Procedure Complete.	This procedure is complete.																												
6. <input type="checkbox"/>	Note down the timestamp in log.	Run the following command: <b>\$ date</b>																												

## System Health check

### Procedure 4: System Health Check

<b>S T E P #</b>	<p>This procedure determines the health of the MPS System before beginning an upgrade.</p> <p>Check off (✓) each step as it is completed. Boxes have been provided for this purpose under each step number.</p> <p><b>IF THIS PROCEDURE FAILS, CONTACT MY ORACLE SUPPORT AND ASK FOR UPGRADE ASSISTANCE.</b></p>	
1. <input type="checkbox"/>	<b>MPS A:</b> Verify health of MPS A.	Follow <a href="#">Procedure A.1</a> on MPS A to verify the health of MPS A.
2. <input type="checkbox"/>	<b>MPS B:</b> Verify health of MPS B.	Follow <a href="#">Procedure A.1</a> on MPS B to verify the health of MPS B.
3. <input type="checkbox"/>	Check disk size for Active and Standby PDBA.	<p>Active and Standby PDBA should have the same disk size i.e. 300G or 480G. If the disk sizes are not the same, please contact Oracle Support before proceeding further.</p> <p>Run the following command:</p> <pre># fdisk -l   grep disk -i Disk /dev/sda: 447.1 GiB, 480103981056 bytes, 937703088 sectors Disklabel type: gpt Disk identifier: 7BCD8D33-BF69-421C-BB2B-D0BDA8CB97C8 Disk /dev/sdb: 447.1 GiB, 480103981056 bytes, 937703088 sectors Disklabel type: gpt</pre>

#### Procedure 4: System Health Check

4. <input type="checkbox"/>	Procedure Complete.	This procedure is complete.
5. <input type="checkbox"/>	Note down the timestamp in log.	Run the following command: <b>\$ date</b>

## 6. SOFTWARE INSTALLATION PROCEDURES

Pre install configuration and initial installation of EPAP can be done on any of the server in the mated pair in any order. These operations can be done simultaneously on both the servers.

### Pre-Install configuration on server A

#### Procedure 5: Pre-Install Configuration on Server A

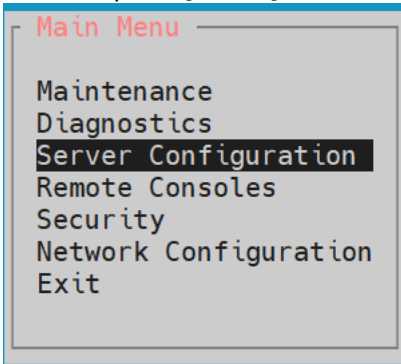
S T E P #	<p>This procedure provides instructions to perform pre-configuration for an initial install of the application.</p> <p>Check off (✓) each step as it is completed. Boxes have been provided for this purpose under each step number.</p> <p>IF THIS PROCEDURE FAILS, CONTACT MY ORACLE SUPPORT AND ASK FOR ASSISTANCE.</p>	
<p><b>IMPORTANT: Installation of the Operating System on an Oracle Application Server should be completed before starting installation procedure. Refer to <a href="#">Procedure A.13</a> or [4] for TPD installation guide.</b></p>		
1. <input type="checkbox"/>	Connect to the Server.	<p>If not already connected, connect to the E5-APP-B card via the serial port.</p> <p>For connecting the E5-APP-B A card, disconnect the console cable from the serial port on the E5-APP-B B card's adapter. The cable should be disconnected at the point where it connects to the serial port labeled 'S1' on the E5-APP-B B card's adapter and use it for serial access. <b>Cable part numbers - 830-1220-xx</b></p>
2. <input type="checkbox"/>	Log in as "admusr" user.	<p>If not already logged in, then log in as "admusr":</p> <p><b>[hostname] consolelogin: admusr</b>  <b>password: password</b></p>
3. <input type="checkbox"/>	Start platcfg utility.	<p><b>\$ sudo su - platcfg</b></p>
4. <input type="checkbox"/>	Navigate to the <b>Server Configuration</b> screen.	<p>Select <b>Server Configuration</b> and press [ENTER]</p>  <p>The screenshot shows a terminal window titled 'Main Menu' with the following options listed: Maintenance, Diagnostics, Server Configuration (highlighted with a black bar), Remote Consoles, Security, Network Configuration, and Exit.</p>

## Procedure 5: Pre-Install Configuration on Server A

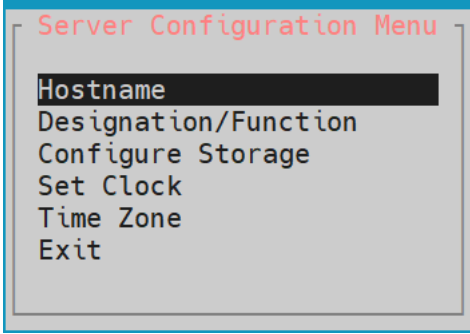
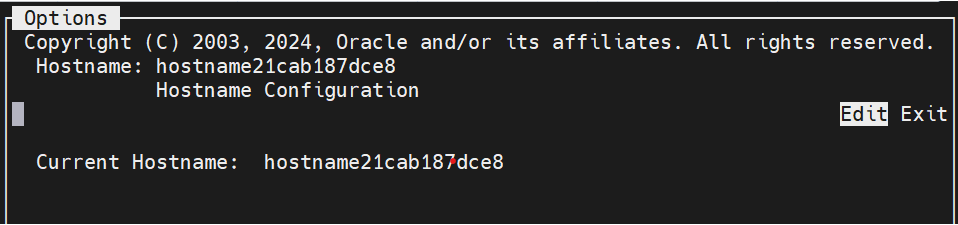
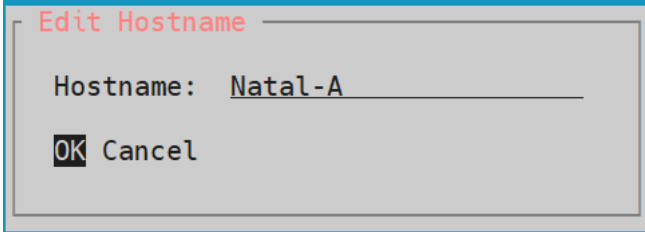
<p>5. <input type="checkbox"/></p>	<p>Navigate to the <b>Hostname</b> screen.</p>	<p>Select <b>Hostname</b> and press [ENTER]</p>  <p>The screenshot shows a terminal window titled "Server Configuration Menu" with the following options: Hostname, Designation/Function, Configure Storage, Set Clock, Time Zone, and Exit. The "Hostname" option is highlighted with a black bar.</p>
<p>6. <input type="checkbox"/></p>	<p>Select <b>Edit</b> to edit the hostname.</p>	<p>Select <b>Edit</b> and press [ENTER].</p>  <p>The screenshot shows a terminal window titled "Options" with the following text: "Copyright (C) 2003, 2024, Oracle and/or its affiliates. All rights reserved. Hostname: hostname21cab187dce8 Hostname Configuration". The "Edit" option is highlighted with a black bar.</p>
<p>7. <input type="checkbox"/></p>	<p>Enter the hostname and press ok.</p>	<p>Delete the default entry and enter the Hostname as mps-xxxx-a where xxxx is the last 4 digits of server serial number. Press OK when done.</p>  <p>The screenshot shows a dialog box titled "Edit Hostname" with the text "Hostname: Natal-A" and "OK Cancel" buttons.</p> <p>While connected to the serial console, some console output might come when the user is using the serial console to configure the EPAP. Those serial output are harmless and can be ignored.</p>
<p>8. <input type="checkbox"/></p>	<p>Exit Back to the Server Configuration Menu.</p>	<p>Press any key to exit back to the Server Configuration Menu. Verify that the hostname has been properly set.</p>

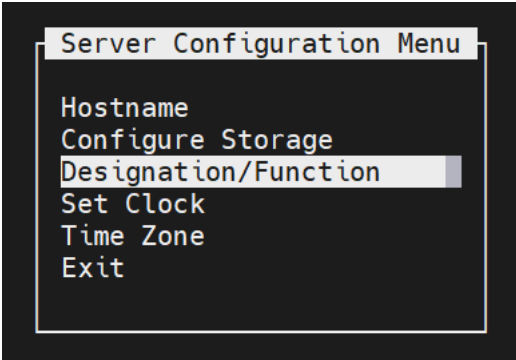
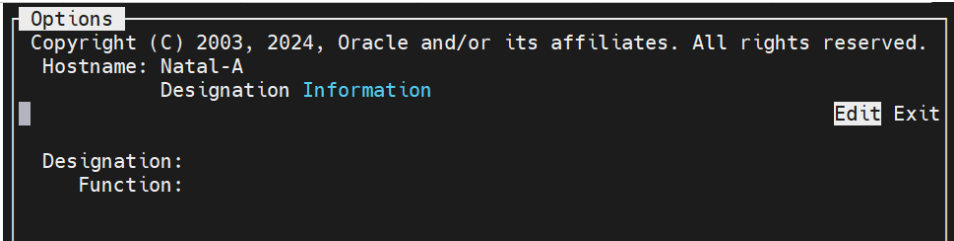

**Procedure 5: Pre-Install Configuration on Server A**

		
<p>9. <input type="checkbox"/></p>	<p>Navigate to the <b>Designation/Function</b> menu option.</p>	<p>Select <b>Designation/Function</b> and press [ENTER]</p> 
<p>10. <input type="checkbox"/></p>	<p>View the current designation and function.</p>	<p>The screen will show the current designation and function setting. On initial install, these fields are blank.</p> 

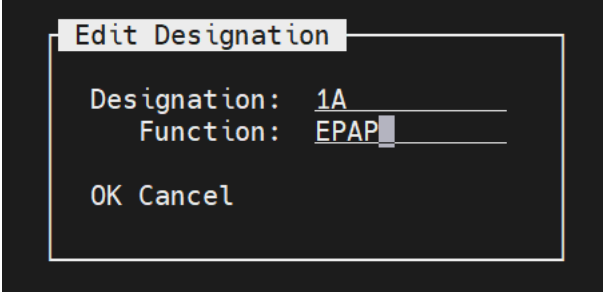
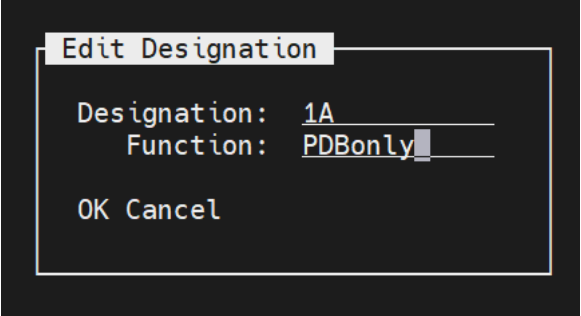
## Procedure 5: Pre-Install Configuration on Server A

		<p>If not blank, the values should be as follows for Mixed EPAP and Non-Provisional EPAP:</p> <ol style="list-style-type: none"><li>1. The Designation is "1A" for the A server</li><li>2. The Function field should be set to EPAP.</li></ol> <p>If not blank, the values should be as follows for Standalone PDB.</p> <ol style="list-style-type: none"><li>1. The Designation is "1A" for the A server</li><li>2. The Function field should be set to PDBonly.</li></ol> <p>If both the fields are blank or either value is not correct, then select <b>Edit</b> and press [ENTER].</p> <p>If both values are correct, select <b>Exit</b>, press [ENTER] and skip the next step.</p>
11. <input type="checkbox"/>	View the current designation and function.	<p>Skip to Step 13 if Exit was selected in the previous step, otherwise if Edit was selected, delete the current designation and function if already set, and type in the desired values. Enter the appropriate designation in the Designation field (Note: the designation must be capitalized). Select OK and press [ENTER].</p> <p>For Mixed EPAP or Non-Provisional EPAP, the following is a correct example:</p>  <p>For Standalone PDB, the following is a correct example:</p> 

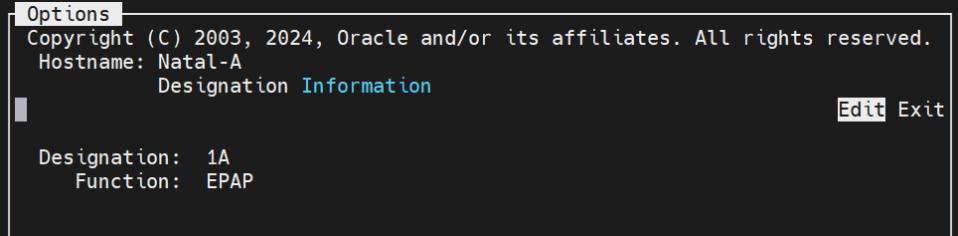
**Procedure 5: Pre-Install Configuration on Server A**

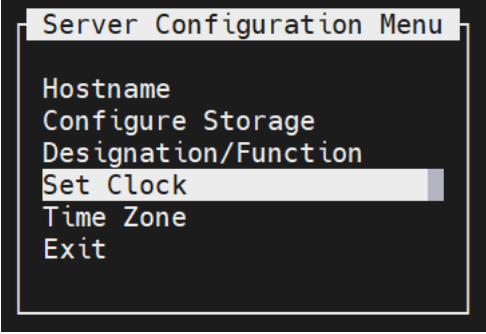
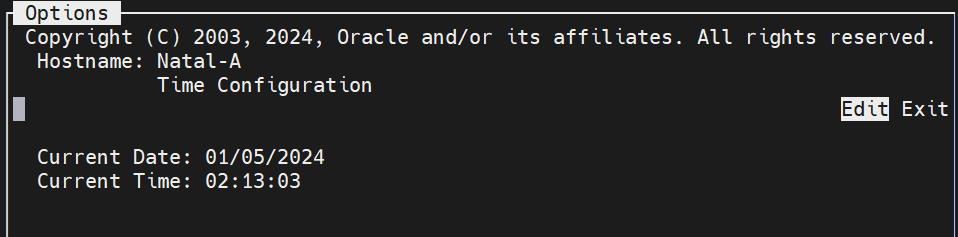
<p>12. <input type="checkbox"/></p>	<p>Verify that the Designation and Function information is correct then select and press "Exit".</p>	<p>For Mixed EPAP or Non-Provisional EPAP, the following is a correct example:</p>  <p>For Standalone PDB, the following is a correct example:</p> 
<p>13. <input type="checkbox"/></p>	<p>Select "Set Clock" Menu.</p>	
<p>14. <input type="checkbox"/></p>	<p>1) Select "Edit" from the options dialogue box.  2) Using an NTP source, set the Date/Time to be correct for the</p>	

**Procedure 5: Pre-Install Configuration on Server A**

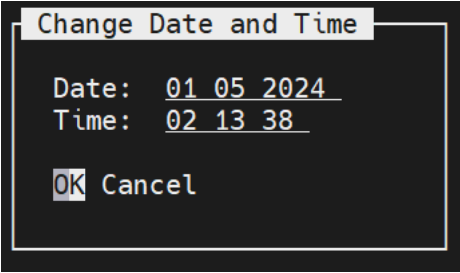
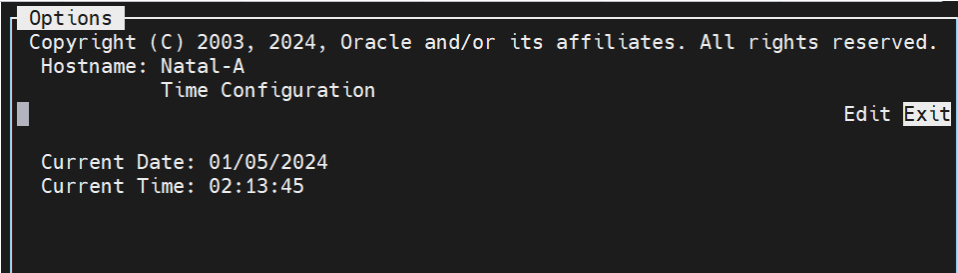
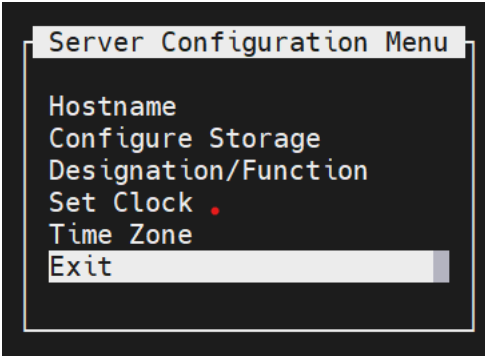
	<p>Eastern Time zone (GMT -5) and press "OK".</p> <p>NOTE: All systems default to Eastern time post IPM. It is important to set the time for the Eastern Time zone at this time.</p>	
<p>15. <input type="checkbox"/></p>	<p>Verify that the Date and Time is correct then select and press "Exit".</p>	
<p>16. <input type="checkbox"/></p>	<p>Exit from platcfg menu.</p>	<p>Select <b>EXIT</b> until the platcfg menu is closed and the command line is displayed.</p> 

### Procedure 5: Pre-Install Configuration on Server A

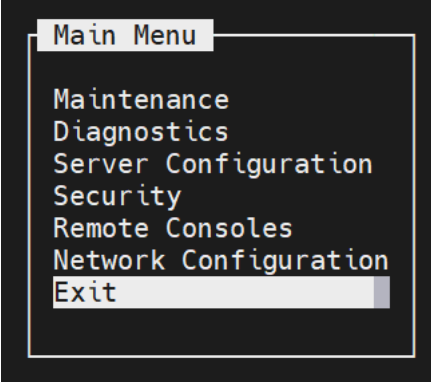
		
17. <input type="checkbox"/>	Reboot the Server.	<b>\$ sudo reboot</b>
18. <input type="checkbox"/>	Procedure complete.	Procedure is complete.
19. <input type="checkbox"/>	Note down the timestamp in log.	Run the following command:  <b>\$ date</b>

### Pre-Install configuration on server B

#### Procedure 6: Pre-Install Configuration on Server B

S T E P #	This procedure provides instructions to perform pre configuration for an initial install of the application.	
	Check off (✓) each step as it is completed. Boxes have been provided for this purpose under each step number.	
	IF THIS PROCEDURE FAILS, CONTACT MY ORACLE SUPPORT AND ASK FOR ASSISTANCE.	
<b>IMPORTANT: Installation of the Operating System on an Oracle Application Server should be completed before starting installation procedure. Refer to <a href="#">Procedure A.13</a> or [4] for TPD installation.</b>		
1. <input type="checkbox"/>	Connect to the Server.	If not already connected, connect to the E5-APP-B card via the serial port.  For connecting the E5-APP-B B card, disconnect the console cable from the serial port on the E5-APP-B A card's adapter. The cable should be disconnected at the point where it connects to the serial port labeled 'S1' on the E5-APP-B A cards' adapter and use it for serial access. <b>Cable part numbers - 830-1220-xx</b>
2. <input type="checkbox"/>	Log in as "admusr" user.	If not already logged in, then log in as 'admusr':

**Procedure 6: Pre-Install Configuration on Server B**

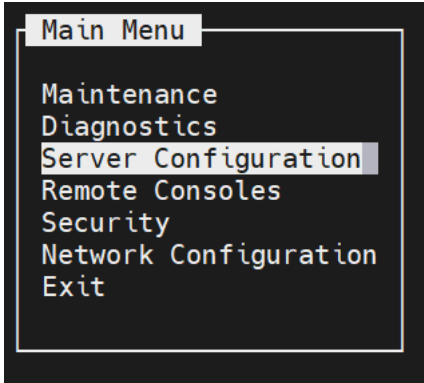
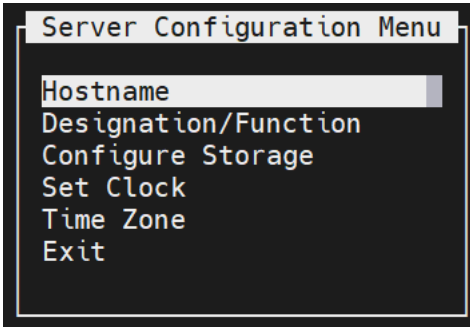
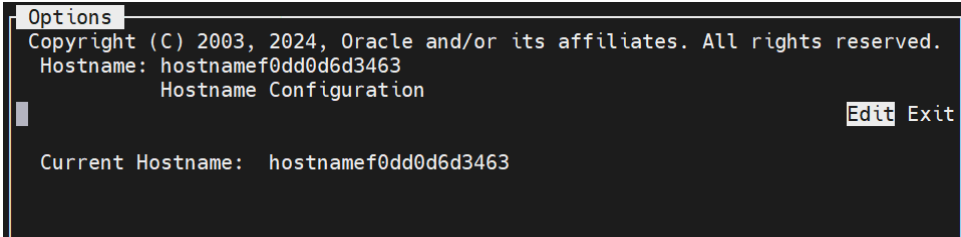
		[hostname] consolelogin: admusr password: <i>password</i>
3. <input type="checkbox"/>	Start platcfg utility.	\$ sudo su - platcfg
4. <input type="checkbox"/>	Navigate to the <b>Server Configuration</b> screen.	Select <b>Server Configuration</b> and press [ENTER]  
5. <input type="checkbox"/>	Navigate to the <b>Hostname</b> screen.	Select <b>Hostname</b> and press [ENTER]  
6. <input type="checkbox"/>	Select <b>Edit</b> to edit the hostname.	Select <b>Edit</b> and press [ENTER]  
7. <input type="checkbox"/>	Enter the hostname and press ok.	Delete the default entry and enter the Hostname as mps-xxxx-b where xxxx is the last 4 digits of server serial number. Press OK when done.

**Procedure 6: Pre-Install Configuration on Server B**

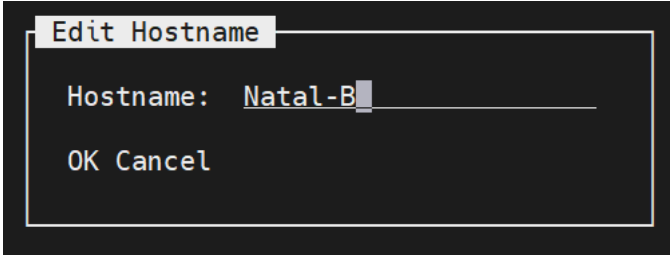
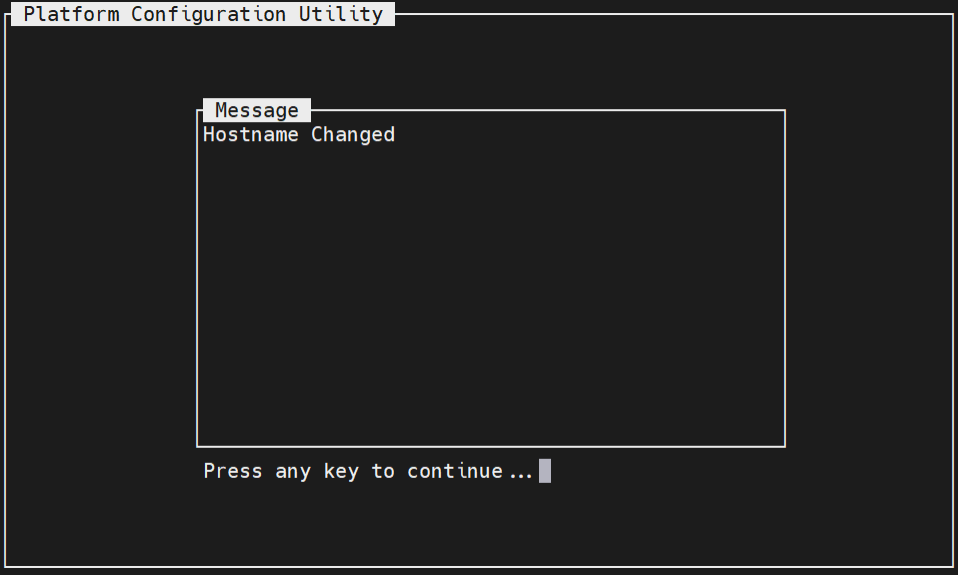
		 <p>While connected to the serial console, some console output might come when the user is using the serial console to configure the EPAP. Those serial output are harmless and can be ignored.</p>
<p>8. <input type="checkbox"/></p>	<p>Exit Back to the Server Configuration Menu.</p>	<p>Press any key to exit back to the Server Configuration Menu. Verify that the hostname has been properly set.</p> 
<p>9. <input type="checkbox"/></p>	<p>Navigate to the <b>Designation/Function</b> menu option.</p>	<p>Select <b>Designation/Function</b> and press [ENTER]</p>

**Procedure 6: Pre-Install Configuration on Server B**

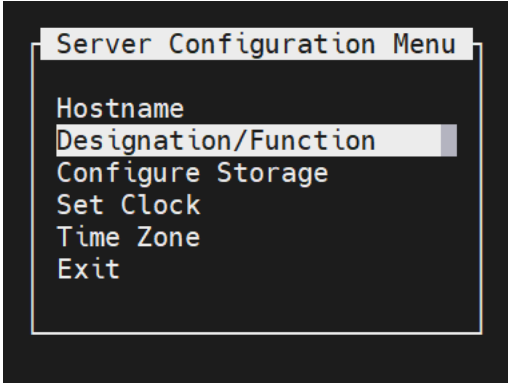
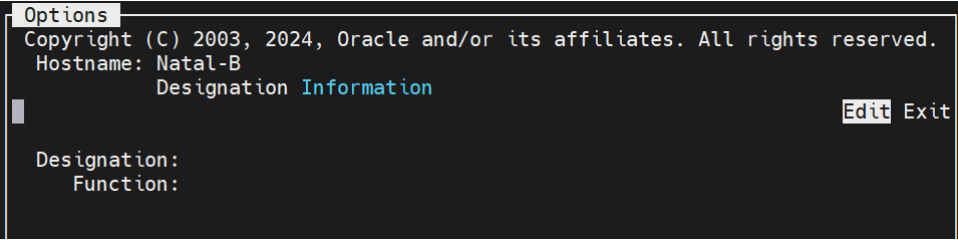
		
<p>10. <input type="checkbox"/></p>	<p>View the current designation and function.</p>	<p>The screen will show the current designation and function setting. On initial install, these fields are blank.</p>  <p>If not blank the values should be as follows for Mixed EPAP and Non-Provisional EPAP:</p> <ol style="list-style-type: none"> <li>1. The Designation is "1B" for the B server</li> <li>2. The Function field should be set to EPAP.</li> </ol> <p>If either value is not correct, then select <b>Edit</b> and press [ENTER].          If both values are correct, select <b>Exit</b>, press [ENTER] and skip the next step.</p>
<p>11. <input type="checkbox"/></p>	<p>View the current designation and function.</p>	<p>Skip to Step 13 if Exit was selected in the previous step, otherwise if Edit was selected, delete the current designation and function if already set, and type in the desired values. Enter the appropriate designation in the Designation field (Note: The designation must be capitalized).          Select <b>OK</b> and press [ENTER].</p>

**Procedure 6: Pre-Install Configuration on Server B**

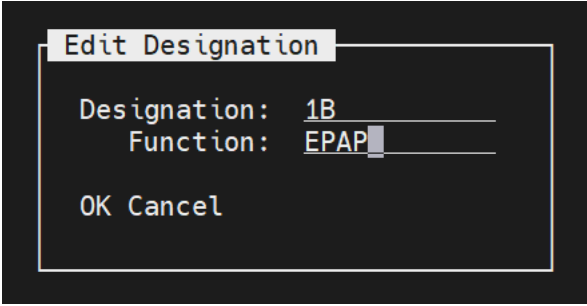
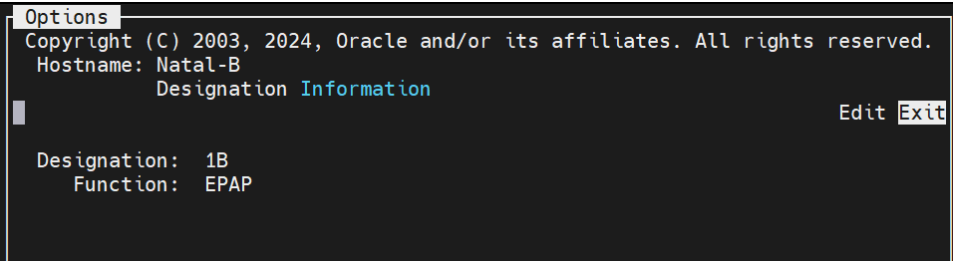
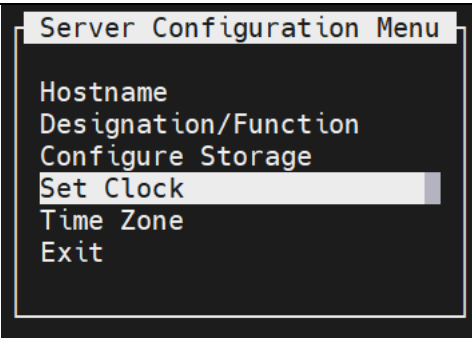
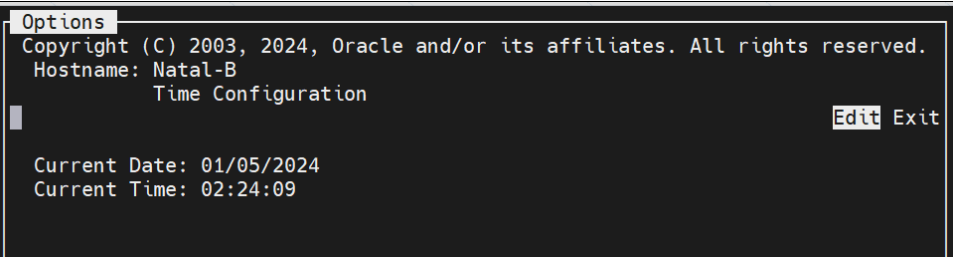
		
<p>12. <input type="checkbox"/></p>	<p>Verify that the Designation and Function information is correct then select and press “Exit”.</p>	
<p>13. <input type="checkbox"/></p>	<p>Select “Set Clock” Menu.</p>	
<p>14. <input type="checkbox"/></p>	<p>1) Select “Edit” from the options dialogue box.  2) Using an NTP source, set the Date/Time to be correct for the Eastern Time zone (GMT -5) and press “OK”.</p>	

**Procedure 6: Pre-Install Configuration on Server B**

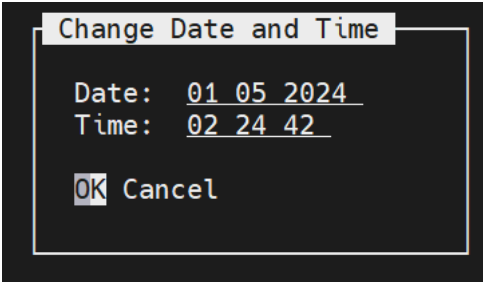
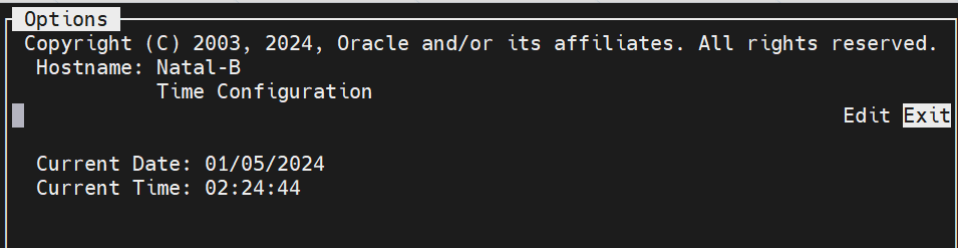
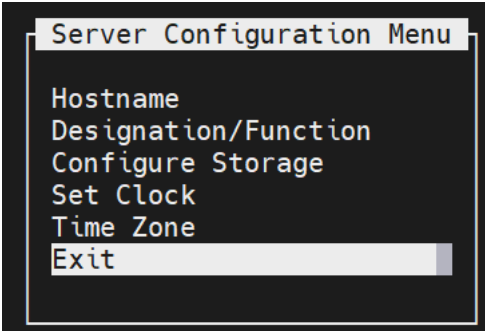
	<p>NOTE: All systems default to Eastern time post IPM. It is important to set the time for the Eastern Time zone at this time.</p>	
<p>15. <input type="checkbox"/></p>	<p>Verify that the Date and Time is correct then select and press "Exit".</p>	
<p>16. <input type="checkbox"/></p>	<p>Exit from platcfg menu.</p>	<p>Select <b>EXIT</b> until the platcfg menu is closed and the command line is displayed.</p> 

### Procedure 6: Pre-Install Configuration on Server B

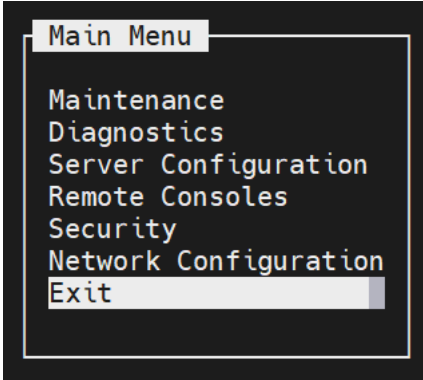
		
17. <input type="checkbox"/>	Reboot the Server.	<b>\$ sudo reboot</b>
18. <input type="checkbox"/>	Procedure complete.	Procedure is complete.
19. <input type="checkbox"/>	Note down the timestamp in log.	Run the following command: <b>\$ date</b>

### Install Application on server B

#### Procedure 7: Install the Application on Server B

S T E P #	This procedure installs the application on the server.	
	Check off (✓) each step as it is completed. Boxes have been provided for this purpose under each step number.	
	IF THIS PROCEDURE FAILS, CONTACT MY ORACLE SUPPORT AND ASK FOR ASSISTANCE.	
1. <input type="checkbox"/>	<b>MPS B: Install 1B.</b>	Perform Procedure in 0 or copy EPAP 16.3 ISO to /var/TKLC/upgrade directory.
2. <input type="checkbox"/>	Create a terminal window Log in to MPS B.	If not already connected, connect to the E5-APP-B card via the serial port.  For connecting the E5-APP-B B card, disconnect the console cable from the serial port on the E5-APP-B A card's adapter. The cable should be disconnected at the point where it connects to the serial port labeled 'S1' on the E5-APP-B A card's adapter and use it for serial access. <b>Cable part numbers - 830-1220-xx</b>
3. <input type="checkbox"/>	<b>MPS B: Login</b> prompt is displayed.	<hostname> console login:  Note: Hit enter if no login prompt is displayed.

## Procedure 7: Install the Application on Server B

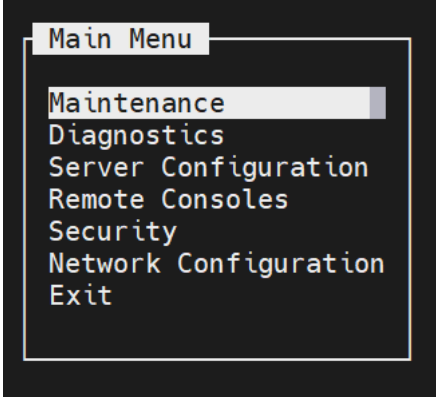
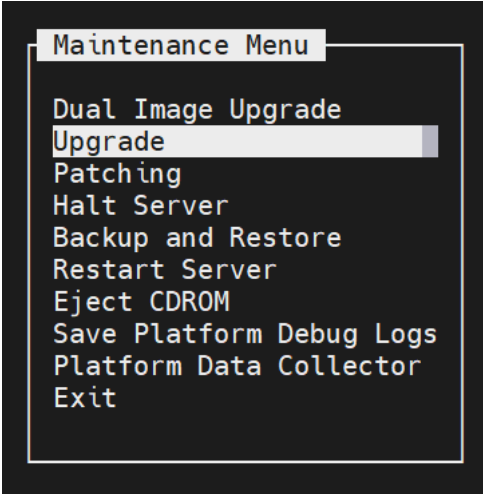
4. <input type="checkbox"/>	<b>MPS B:</b> log in as “admusr” user.	<code>[hostname] consolelogin: admusr password: password</code>
5. <input type="checkbox"/>	<b>MPS B:</b> Start platcfg utility.	<code>\$ sudo su - platcfg</code>
6. <input type="checkbox"/>	<b>MPS B:</b> Navigate to the Upgrade menu.	<p>The platcfg <b>Main Menu</b> appears. On the <b>Main Menu</b>, select <b>Maintenance</b> and press [ENTER].</p>  <p>Select the <b>Upgrade</b> menu and press [ENTER].</p> 
7. <input type="checkbox"/>	<b>MPS X:</b> Validate ISO file.	Validate ISO file using <b>0</b> .

## Procedure 7: Install the Application on Server B

8.  **MPS A:** Select Early Upgrade Checks

Select the “Early Upgrade Checks” menu to verify that the system is ready for upgrade.

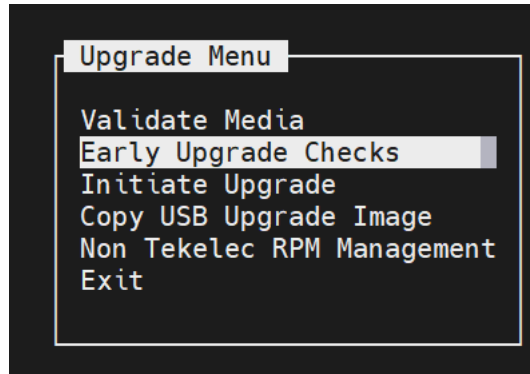

If the Early Upgrade Checks fail due to the ongoing syncing of raid mirrors, then wait until the resync is completed and run the “Early Upgrade Checks” again.

```
Early Checks failed for the next upgrade
Look at earlyChecks.log for more info
tarting Early Upgrade Checks at 1011413059
Running earlyUpgradeChecks() for Upgrade::EarlyPolicy::TPDEarlyChecks upgrade policy...
Verified server is not pending accept of previous upgrade
ERROR: Raid mirrors are syncing!
ERROR: md2 is syncing!
ERROR: earlyUpgradeChecks() code failed for Upgrade::EarlyPolicy::TPDEarlyChecks
ERROR: Failed running earlyUpgradeChecks() code
Hardware architectures match
Install products match.
No Application installed yet.. Skip alarm check!
ERROR: Early Upgrade Checks Failed!
User has requested just to run early checks.
No upgrade will be performed...
Early Upgrade Checks finished at 1011413059
```

```
[admusr@epappri ~]$ cat /proc/mdstat
Personalities : [raid1]
md1 : active raid1 sdb2[1] sda2[0]
      262080 blocks super 1.0 [2/2] [UU]

md2 : active raid1 sda1[0] sdb1[1]
      468447232 blocks super 1.1 [2/2] [UU]
[====>.....]    resync = 29.7% (139377920/468447232) finish=73.0min speed=75060K/sec
bitmap: 4/4 pages [16KB], 65536KB chunk

unused devices: <none>
```

Contact My Oracle Support following the instructions on the front page or the instructions in the **My Oracle Support** section, if the early upgrade checks fail due to any other reason.

## Procedure 7: Install the Application on Server B

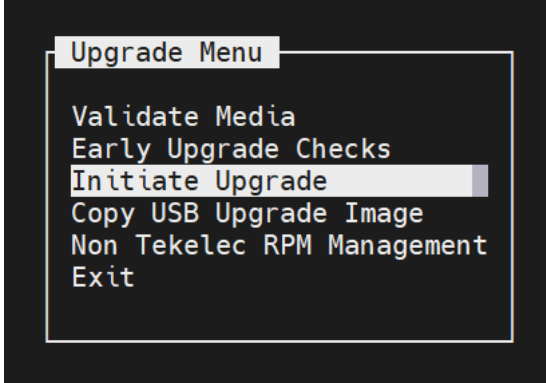
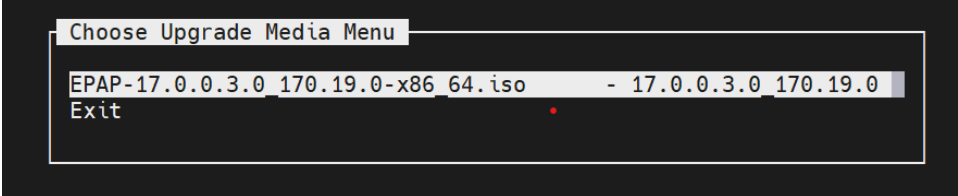
<p>9. <input type="checkbox"/></p>	<p><b>MPS A:</b> Navigate to the Initiate Upgrade menu</p>	<p>Select the <b>Initiate Upgrade</b> menu and press [ENTER].</p> 
<p>10. <input type="checkbox"/></p>	<p><b>MPS B:</b> Select the Upgrade Media.</p>	<p>The screen displays a message that it is searching for upgrade media. When the upgrade media is found, an Upgrade Media selection menu appears similar-to the example below. Select the desired upgrade media and press [ENTER].</p> 
<p>11. <input type="checkbox"/></p>	<p><b>MPS B:</b> Upgrade proceeds.</p>	<p>The screen displays the following, indicating that the upgrade software is first validating the media, and then proceeding with the upgrade.</p> <pre>No Application installed yet.. Skip alarm check! Verified all raid mirrors are synced. Early Upgrade Checks Have Passed! Early Upgrade Checks finished at 1447429031 Initializing upgrade information...</pre>
<p>12. <input type="checkbox"/></p>	<p><b>MPS B:</b> Upgrade proceeds.</p>	<p>Many informational messages appear on the terminal screen as the upgrade proceeds. The messages are not shown here for clarity sake.</p> <p>When installation is complete, the server reboots.</p>
<p>13. <input type="checkbox"/></p>	<p><b>MPS B:</b> Upgrade completed.</p>	<p>After the final reboot, the screen displays the login prompt as in the example below.</p> <pre>Starting atd: [ OK ] ~~ /etc/rc4.d/S98ExQueue start ~~ ExQueue started. Starting TKLCe5appb: [ OK ]</pre>

## Procedure 7: Install the Application on Server B

		<pre> Checking network config files: [ OK ] Daemon is not running... AlarmMgr daemon is not running, delaying by 1 minute ~~ /etc/rc4.d/S99Epap start ~~ EPAP configuration data not found. Exiting... ~~ /etc/rc4.d/S99Pdba start ~~ EPAP configuration data not found. Exiting... Starting smartd: [ OK ] Daemon is not running... AlarmMgr daemon is not running, delaying by 1 minute TPDhpDiskStatus stop/pre-start, process 5527                                 TKLChwmgmtcli stop/pre-start, process 5508  Oracle Linux Server release 6.9 Kernel 2.6.32-642.6.2.el6prere17.4.0.0.0_88.32.0.x86_64 on an x86_64 </pre>
14. <input type="checkbox"/>	<b>MPS B:</b> Log in as “epapdev” user.	<pre> [hostname] consolelogin: epapdev password: password </pre>
15. <input type="checkbox"/>	<b>MPS B:</b> Check the Upgrade log.	<pre> Examine the upgrade logs in the directory /var/TKLC/log/upgrade and verify that no errors and warnings were reported.  \$ grep -i error /var/TKLC/log/upgrade/upgrade.log  Check the output of the upgrade log. Contact My Oracle Support following the instructions on the front page or the instructions in the <b>My Oracle Support</b> section, if the output contains any error except the following:  [root@Salta-B core]# grep -i error /var/TKLC/log/upgrade/upgrade.log 1673985608::ERROR: run-r1841b65093e14801be5696ea62d92ac2 is not recognized as a systemd service! 1673985608::ERROR: Could not stop run-r1841b65093e14801be5696ea62d92ac2! 1673985608::ERROR: service_conf reconfig failed! [root@Salta-B core]#  \$ grep -i warning /var/TKLC/log/upgrade/upgrade.log  Examine the output of the above command to determine if any warnings were reported. </pre>

**Procedure 7: Install the Application on Server B**

		<p>Contact My Oracle Support following the instructions on the front page or the instructions in the <b>My Oracle Support</b> section, if the output contains any warnings beside the following:</p> <pre>[root@Salta-B core]# grep -i error /var/TKLC/log/upgrade/upgrade.log 1673985608::ERROR: run-r1841b65093e14801be5696ea62d92ac2 is not recognized as a systemd service! 1673985608::ERROR: Could not stop run- r1841b65093e14801be5696ea62d92ac2! 1673985608::ERROR: service_conf reconfig failed! [root@Salta-B core]# grep -i warning /var/TKLC/log/upgrade/upgrade.log 1673985030::* write: WARNING:: Could not find configured path "/var/TKLC/epap/db". 1673985031::* write: WARNING:: Could not find configured path "/var/TKLC/epap/logs". 1673985031::* write: WARNING:: Could not find configured path "/var/TKLC/epap/free". 1673985031::* write: WARNING:: Could not find configured path "/var/TKLC/epap/db". 1673985031::* write: WARNING:: Could not find configured path "/var/TKLC/epap/logs". 1673985031::* write: WARNING:: Could not find configured path "/var/TKLC/epap/free". 1673985033::useradd: warning: the home directory already exists. 1673985476::2023-01-17T19:57:57.683121Z 0 [Warning] [MY-013746] [Server] A deprecated TLS version TLSv1 is enabled for channel mysql_main 1673985478::2023-01-17T19:57:57.683144Z 0 [Warning] [MY-013746] [Server] A deprecated TLS version TLSv1.1 is enabled for channel mysql_main 1673985478::2023-01-17T19:57:57.808924Z 6 [Warning] [MY-010453] [Server] root@localhost is created with an empty password ! Please consider switching off the --initialize-insecure option. 1673985551::WARNING: A new file was added to xml alarm files...reparsing xml... 1673985551::WARNING: FILE: /usr/TKLC/plat/etc/alarms/alarms_mps.xml 1673985571::TKLCepap-HA #####warning: group root} does not exist - using root [root@Salta-B core]#</pre>
16.	<input type="checkbox"/> <b>MPS B:</b> Check that the upgrade	<pre>\$ grep "Upgrade returned success" /var/TKLC/log/upgrade/upgrade.log</pre>

## Procedure 7: Install the Application on Server B

	completed successfully.	
17. <input type="checkbox"/>	<b>MPS B:</b> Check that the upgrade completed successfully.	Verify that the message “Upgrade returned success!” is displayed. If it is not, contact My Oracle Support following the instructions on the front page or the instructions in the <b>My Oracle Support</b> section. 1399367207:: Upgrade returned success!
18.	Log in to MPS A via epapdev user and go to directory /usr/TKLC/epap/bin and Run the following command: ./mysql_setup.pl	[epapdev@Salta-A ~]# ./mysql_setup.pl
19. <input type="checkbox"/>	<b>MPS B:</b> Log in to MPS A via root user and update ssh_config to disable MD5 and MAC algorithm for security	Perform following steps to disable unsecure algorithm for ssh:  1. <b>\$ grep "MACs hmac-md5,hmac-md5-96," /etc/ssh/ssh_config</b> If output contains “MACs hmac-md5,hmac-md5-96”, execute the below steps 2, 3 and 4. Else go to step 5. 2. <b>\$ sudo rcstool co /etc/ssh/ssh_config</b>  3. <b>\$ sudo sed -i -e '/MACs hmac-md5,hmac-md5-96,hmac-sha1-96/d' /etc/ssh/ssh_config</b>  4. <b>\$ sudo rcstool ci /etc/ssh/ssh_config</b>  5. <b>\$ grep "MACs hmac-sha2-256,hmac-sha2-512" /etc/ssh/sshd_config</b> If no output is displayed for above command continue to next command in steps else skip these steps  6. <b>\$ sudo rcstool co /etc/ssh/sshd_config</b>  7. <b>\$ sudo sed -i '\$ a \\tMACs hmac-sha2-256,hmac-sha2-512' /etc/ssh/sshd_config</b>  8. <b>\$ sudo rcstool ci /etc/ssh/sshd_config</b> 9. <b>\$ sudo systemctl restart sshd</b>
20. <input type="checkbox"/>	Update the httpd.conf file to disable the Cache	Perform the following steps to disable Cache control no-store policy:

### Procedure 7: Install the Application on Server B

	control no-store policy.	<p><b>1. \$ grep "Header set Cache-Control no-store" /etc/httpd/conf/httpd.conf</b></p> <p>If the output contains "Header set Cache-Control no-store", Execute the below steps. If no output is displayed for the above command, skip the steps mentioned below.</p> <p><b>2. \$ sudo sed -i '/Cache-Control no-store/c\#Header set Cache-Control no-store' /etc/httpd/conf/httpd.conf</b></p> <p><b>3. \$ grep "Header set Cache-Control no-store" /etc/httpd/conf/httpd.conf</b></p> <p>The output should be "#Header set Cache-Control no-store" showing that the line has been commented.</p>
21. <input type="checkbox"/>	<b>MPS B:</b> Install Complete.	Install Procedure is complete.
22. <input type="checkbox"/>	Note down the timestamp in log.	Run the following command: <b>\$ date</b>

### Procedure 8 Install Application on server A

#### Procedure 8: Install the Application on Server A

<b>S T E P #</b>	This procedure installs the application on the server.	
	Check off (✓) each step as it is completed. Boxes have been provided for this purpose under each step number.	
	IF THIS PROCEDURE FAILS, CONTACT MY ORACLE SUPPORT AND ASK FOR ASSISTANCE.	
1. <input type="checkbox"/>	<b>MPS A:</b> Install EPAP on 1A.	Perform Procedure in 0 or copy EPAP 16.4 ISO to /var/TKLC/upgrade directory.
2. <input type="checkbox"/>	Create a terminal window and Log in to MPS A.	<p>If not already connected, connect to the E5-APP-B card via the serial Port.</p> <p>For connecting the E5-APP-B A card, disconnect the console cable from the serial port on the E5-APP-B B card's adapter. The cable should be disconnected at the point where it connects to the serial port labeled 'S1' on the E5-APP-B B card's adapter and use it for serial access. <b>Cable part numbers - 830-1220-xx</b></p>
3. <input type="checkbox"/>	<b>MPS A:</b> Login prompt is displayed.	<p>&lt;hostname&gt; console login:</p> <p>Note: Hit enter if no login prompt is displayed.</p>

## Procedure 8: Install the Application on Server A

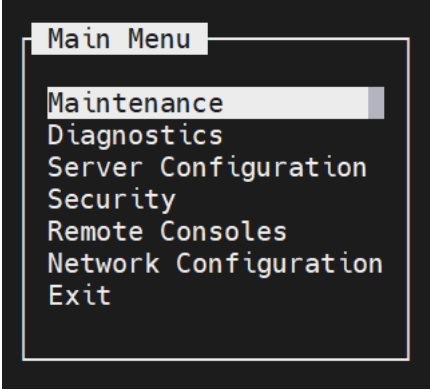
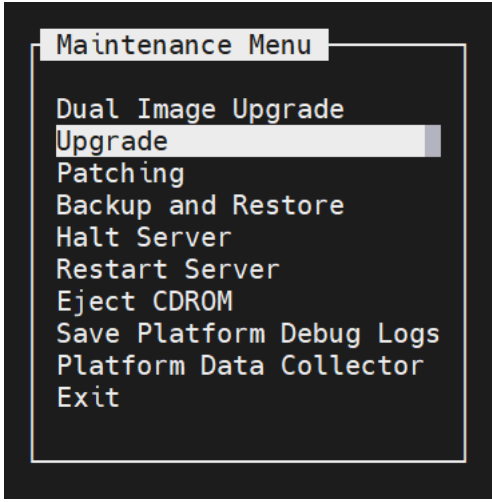
4. <input type="checkbox"/>	<b>MPS A:</b> log in as “admusr” user.	<code>[hostname] consolelogin: admusr password: password</code>
5. <input type="checkbox"/>	<b>MPS A:</b> Start platcfg utility.	<code>\$ sudo su - platcfg</code>
6. <input type="checkbox"/>	<b>MPS A:</b> Navigate to the Upgrade menu.	<p>The platcfg <b>Main Menu</b> appears. On the <b>Main Menu</b>, select <b>Maintenance</b> and press [ENTER].</p>  <p>Select the <b>Upgrade</b> menu and press [ENTER].</p> 
7. <input type="checkbox"/>	<b>MPS X:</b> Validate ISO file.	Validate ISO file using <b>0</b> .

**Procedure 8: Install the Application on Server A**

<p>8. <input type="checkbox"/></p>	<p><b>MPS A: Select Early Upgrade Checks</b></p>	<p>Select the “Early Upgrade Checks” menu to verify that the system is ready for upgrade.</p> <div data-bbox="671 331 1198 696" data-label="Image"> <p>The image shows a terminal window with a black background and white text. At the top, there is a title bar that says 'Upgrade Menu'. Below it, a list of options is displayed: 'Validate Media', 'Early Upgrade Checks', 'Initiate Upgrade', 'Copy USB Upgrade Image', 'Non Tekelec RPM Management', and 'Exit'. The 'Early Upgrade Checks' option is highlighted with a white rectangular bar behind it.</p> </div> <p>If the Early Upgrade Checks fail due to the ongoing syncing of raid mirrors, then wait until the resync is completed and run the “Early Upgrade Checks” again.</p> <pre> Early Checks failed for the next upgrade Look at earlyChecks.log for more info tarting Early Upgrade Checks at 1011413059 Running earlyUpgradeChecks() for Upgrade::EarlyPolicy::TPDEarlyChecks upgrade policy... Verified server is not pending accept of previous upgrade ERROR: Raid mirrors are syncing! ERROR: md2 is syncing! ERROR: earlyUpgradeChecks() code failed for Upgrade::EarlyPolicy::TPDEarlyChecks ERROR: Failed running earlyUpgradeChecks() code Hardware architectures match Install products match. No Application installed yet.. Skip alarm check! ERROR: Early Upgrade Checks Failed! User has requested just to run early checks. No upgrade will be performed... Early Upgrade Checks finished at 1011413059  [admsr@epappri ~]\$ cat /proc/mdstat Personalities : [raid1] md1 : active raid1 sdb2[1] sda2[0]       262080 blocks super 1.0 [2/2] [UU]  md2 : active raid1 sda1[0] sdb1[1]       468447232 blocks super 1.1 [2/2] [UU] [====&gt;.....]  resync = 29.7% (139377920/468447232) finish=73.0min speed=75060K/sec bitmap: 4/4 pages [16KB], 65536KB chunk  unused devices: &lt;none&gt; </pre> <p>Contact My Oracle Support following the instructions on the front page or the instructions in the <b>My Oracle Support</b> section if the early upgrade checks fail due to any other reason</p>
<p>9. <input type="checkbox"/></p>	<p><b>MPS A: Navigate to the Initiate Upgrade menu</b></p>	<p>Select the <b>Initiate Upgrade</b> menu and press <b>[ENTER]</b>.</p>

## Procedure 8: Install the Application on Server A

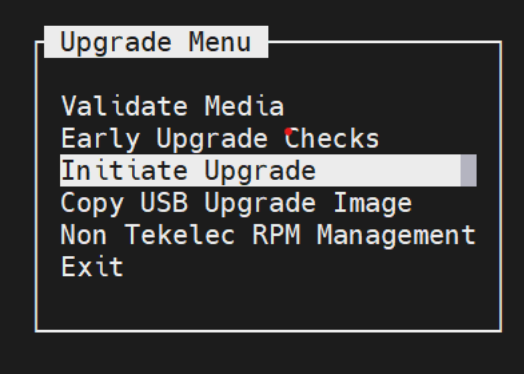
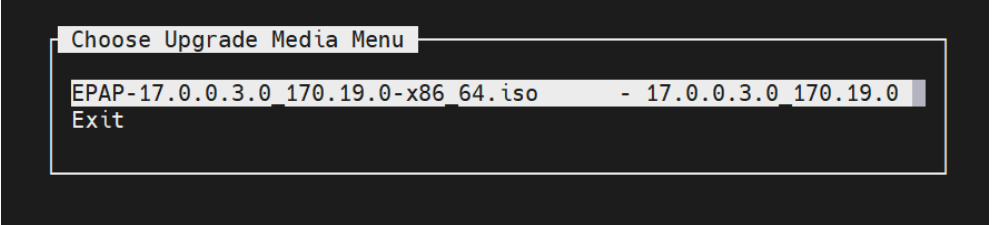
		
<p>10. <input type="checkbox"/></p>	<p><b>MPS A:</b> Select the Upgrade Media.</p>	<p>The screen displays a message that it is searching for upgrade media. When the upgrade media is found, an Upgrade Media selection menu appears similar-to the example below.</p> <p>Select the desired upgrade media and press [ENTER].</p> 
<p>11. <input type="checkbox"/></p>	<p><b>MPS A:</b> Upgrade proceeds.</p>	<p>The screen displays the output like following, indicating that the upgrade software is first running the upgrade checks, and then proceeding with the upgrade.</p> <pre>No Application installed yet.. Skip alarm check! Verified all raid mirrors are synced. Early Upgrade Checks Have Passed! Early Upgrade Checks finished at 1447429031 _ Initializing upgrade information...</pre>
<p>12. <input type="checkbox"/></p>	<p><b>MPS A:</b> Upgrade proceeds.</p>	<p>Many informational messages appear on the terminal screen as the upgrade proceeds. The messages are not shown here for clarity sake.</p> <p>When installation is complete, the server reboots.</p>
<p>13. <input type="checkbox"/></p>	<p><b>MPS A:</b> Upgrade completed.</p>	<p>After the final reboot, the screen displays the login prompt as in the example below.</p> <pre>Starting atd: [ OK ] ~~ /etc/rc4.d/S98ExQueue start ~~ ExQueue started. Starting TKLCe5appb: [ OK ] Checking network config files: [ OK ] Daemon is not running...</pre>

## Procedure 8: Install the Application on Server A

		<pre>AlarmMgr daemon is not running, delaying by 1 minute ~~ /etc/rc4.d/S99Epap start ~~ EPAP configuration data not found. Exiting... ~~ /etc/rc4.d/S99Pdba start ~~ EPAP configuration data not found. Exiting... Starting smartd: [ OK ] Daemon is not running... AlarmMgr daemon is not running, delaying by 1 minute TPDhpDiskStatus stop/pre-start, process 5527 TKLChwmgmtcli stop/pre-start, process 5508  Oracle Linux Server release 6.9 Kernel 2.6.32-642.6.2.el6prere17.4.0.0.0_88.32.0.x86_64 on an x86_64</pre>
<p>14. <input type="checkbox"/></p>	<p><b>MPS A:</b> Log in as “epapdev” user.</p>	<pre>[hostname] consolelogin: epapdev password: <i>password</i></pre>
<p>15. <input type="checkbox"/></p>	<p><b>MPS A:</b> Check the Upgrade log.</p>	<pre>Examine the upgrade logs in the directory /var/TKLC/log/upgrade and verify that no errors and warnings were reported.  \$ grep -i error /var/TKLC/log/upgrade/upgrade.log  Check the output of the upgrade log. Contact My Oracle Support following the instructions on the front page or the instructions in the <b>My Oracle Support</b> section, if the output contains any errors beside the following:  [root@Salta-B core]# grep -i error /var/TKLC/log/upgrade/upgrade.log 1673985608::ERROR: run-r1841b65093e14801be5696ea62d92ac2 is not recognized as a systemd service! 1673985608::ERROR: Could not stop run-r1841b65093e14801be5696ea62d92ac2! 1673985608::ERROR: service_conf reconfig failed!  [root@Salta-B core]#  \$ grep -i warning /var/TKLC/log/upgrade/upgrade.log  Examine the output of the above command to determine if any warnings were reported. Contact My Oracle Support following the instructions on the front page or the instructions in the <b>My Oracle Support</b> section, if the output contains any warnings beside the following:</pre>

**Procedure 8: Install the Application on Server A**

		<pre>[root@Salta-B core]# grep -i error /var/TKLC/log/upgrade/upgrade.log 1673985608::ERROR: run-r1841b65093e14801be5696ea62d92ac2 is not recognized as a systemd service! 1673985608::ERROR: Could not stop run-r1841b65093e14801be5696ea62d92ac2! 1673985608::ERROR: service_conf reconfig failed! [root@Salta-B core]# grep -i warning /var/TKLC/log/upgrade/upgrade.log 1673985030::* write: WARNING:: Could not find configured path "/var/TKLC/epap/db". 1673985031::* write: WARNING:: Could not find configured path "/var/TKLC/epap/logs". 1673985031::* write: WARNING:: Could not find configured path "/var/TKLC/epap/free". 1673985031::* write: WARNING:: Could not find configured path "/var/TKLC/epap/db". "/var/TKLC/epap/rt". 1673985031::* write: WARNING:: Could not find configured path 1673985031::* write: WARNING:: Could not find configured path "/var/TKLC/epap/logs". 1673985031::* write: WARNING:: Could not find configured path "/var/TKLC/epap/free". 1673985033::useradd: warning: the home directory already exists. 1673985476::2023-01-17T19:57:57.683121Z 0 [Warning] [MY-013746] [Server] A deprecated TLS version TLSv1 is enabled for channel mysql_main 1673985478::2023-01-17T19:57:57.683144Z 0 [Warning] [MY-013746] [Server] A deprecated TLS version TLSv1.1 is enabled for channel mysql_main 1673985478::2023-01-17T19:57:57.808924Z 6 [Warning] [MY-010453] [Server] root@localhost is created with an empty password ! Please consider switching off the --initialize-insecure option. 1673985551::WARNING: A new file was added to xml alarm files...reparsing xml... 1673985551::WARNING: FILE: /usr/TKLC/plat/etc/alarms/alarms_mps.xml 1673985571::TKLCepap-HA #####warning: group root} does not exist - using root [root@Salta-B core]#</pre> <p>Refer to <a href="#">section 3.7</a> to know more about logging.</p>
<p>16. <input type="checkbox"/></p>	<p><b>MPS A:</b> Check that the upgrade completed successfully.</p>	<p><b>\$ grep "Upgrade returned success" /var/TKLC/log/upgrade/upgrade.log</b></p>

## Procedure 8: Install the Application on Server A

17. <input type="checkbox"/>	<b>MPS A:</b> Check that the upgrade completed successfully.	Verify that the message “Upgrade returned success!” is displayed. If it is not, contact My Oracle Support following the instructions on the front page or the instructions in the <b>My Oracle Support</b> section.  1399367207:: Upgrade returned success!
18. <input type="checkbox"/>	Log in to MPS B via epapdev user and go to directory /usr/TKLC/epap/bin and Run the following command: <b>./mysql_setup.pl</b>	[epapdev@Salta-A ~]# <b>./mysql_setup.pl</b>
19.	<b>MPS B:</b> : Log in to MPS A via root user and update ssh_config to disable MD5 and MAC algorithm for security	Perform following steps to disable unsecure algorithm for ssh:  1. <b>\$ grep "MACs hmac-md5,hmac-md5-96," /etc/ssh/ssh_config</b> If output contains “MACs hmac-md5,hmac-md5-96”, execute the below steps 2, 3 and 4. Else go to step 5. 2. <b>\$ sudo rcstool co /etc/ssh/ssh_config</b>  3. <b>\$ sudo sed -i -e '/MACs hmac-md5,hmac-md5-96,hmac-sha1-96/d' /etc/ssh/ssh_config</b>  4. <b>\$ sudo rcstool ci /etc/ssh/ssh_config</b>  5. <b>\$ grep "MACs hmac-sha2-256,hmac-sha2-512" /etc/ssh/sshd_config</b> If no output is displayed for above command continue to next command in steps else skip these steps  6. <b>\$ sudo rcstool co /etc/ssh/sshd_config</b>  7. <b>\$ sudo sed -i '\$ a \\tMACs hmac-sha2-256,hmac-sha2-512' /etc/ssh/sshd_config</b>  8. <b>\$ sudo rcstool ci /etc/ssh/sshd_config</b> 9. <b>\$ sudo systemctl restart sshd</b>
20. <input type="checkbox"/>	Update the httpd.conf file to disable the Cache control no-store policy	Perform the following steps to disable Cache control no-store policy:  1. <b>\$ grep "Header set Cache-Control no-store" /etc/httpd/conf/httpd.conf</b>

## Procedure 8: Install the Application on Server A

		<p>If the output contains "Header set Cache-Control no-store", Execute the below steps. If no output is displayed for the above command, skip the steps mentioned below.</p> <ol style="list-style-type: none"> <li>2. <b>sudo sed -i '/Cache-Control no-store/c\#Header set CacheControl no-store' / etc/httpd/conf/httpd.conf</b></li> <li>3. <b>\$ grep "Header set Cache-Control no-store" /etc/httpd/conf/httpd.conf</b></li> </ol> <p>The output should be "#Header set Cache-Control no-store" showing that the line has been commented.</p>
21.	<input type="checkbox"/> <b>MPS A:</b> Install Complete.	Install Procedure is complete.
22.	<input type="checkbox"/> Note down the timestamp in log.	Run the following command: <b>\$ date</b>

## Procedure 9 Switch Configuration



### Procedure 9: Switch Configuration

<b>S T E P #</b>	<p>This procedure Configures the Switches of a new Installed E5-APP-B EPAP Server Pair.</p> <p>Check off (✓) each step as it is completed. Boxes have been provided for this purpose under each step number.</p> <p>IF THIS PROCEDURE FAILS, CONTACT MY ORACLE SUPPORT AND ASK FOR ASSISTANCE.</p>	
	<p>1. <input type="checkbox"/> Make the cross-over cable connections.</p>	<p style="text-align: center;"><b>NOTE: THIS IS IMPORTANT</b></p> <p>CONNECT the cross-over cable from <b>Port 1 of Switch1A</b> to <b>Port 1 of Switch1B</b>.</p> <p>DISCONNECT the cross-over cable from <b>Port 2 of Switch1A</b> to <b>Port 2 of Switch1B</b>.</p> <p>Please make a note that the switch configuration should only be attempted by a skilled technician and not all.</p> <p>All uplinks should be removed while switch configuration.</p> <p>There should not be any loop in the switches during their configuration.</p>

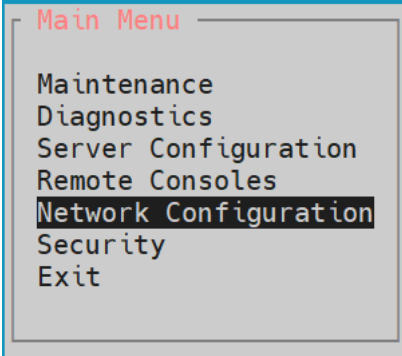
## Procedure 9: Switch Configuration

		Make sure to enable and start tftp service by using following commands if not started earlier :- <pre>sudo systemctl start tftp sudo systemctl enable tftp</pre>
2. <input type="checkbox"/>	<b>MPS B:</b> log in as “admusr” user.	<code>[hostname] consolelogin: admusr</code> <code>password: <i>password</i></code>
3. <input type="checkbox"/>	<b>MPS B:</b> Set Telco Switch with non-default speed.	<b>Note:</b> The default speed to be set on the switch is 1000Mbps. However, the recommended setting can be changed to ‘auto’, ‘1000/full’ or ‘100/full’. At the EAGLE end, the operator can set the IP LINK to ‘auto’.
4. <input type="checkbox"/>	<b>MPS B:</b> Start platcfg utility.	<code>\$ sudo su - platcfg</code>
5. <input type="checkbox"/>	<b>MPS B:</b> Navigate to the Network Configuration Menu.	On the platcfg <b>Main Menu</b> , select <b>Network Configuration</b> and press [ENTER].   <p>The screenshot shows a terminal window titled "Main Menu" with the following options listed: Maintenance, Diagnostics, Server Configuration, Remote Consoles, Network Configuration (highlighted with a black bar), Security, and Exit.</p>
6. <input type="checkbox"/>	<b>MPS B:</b> Navigate to the Configure Switch Menu.	On the Network Configuration menu, select <b>Configure Switch</b> and press [ENTER].

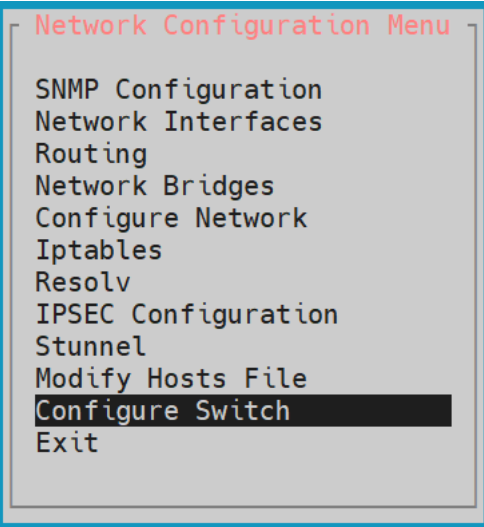
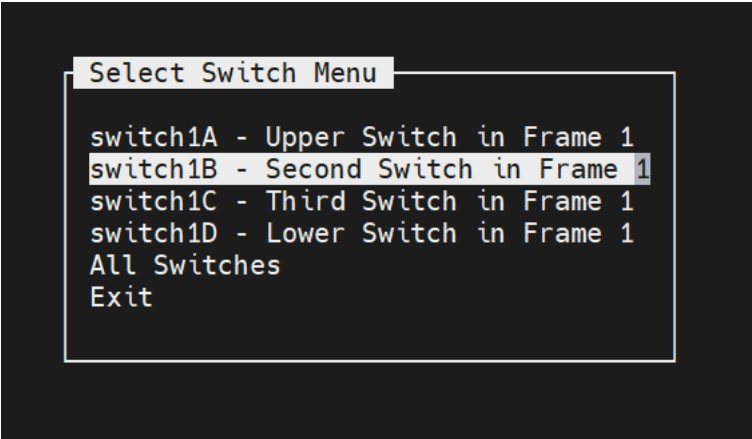
**Procedure 9: Switch Configuration**

		 <p>Network Configuration Menu</p> <ul style="list-style-type: none"> <li>SNMP Configuration</li> <li>Network Interfaces</li> <li>Routing</li> <li>Network Bridges</li> <li>Configure Network</li> <li>Iptables</li> <li>Resolv</li> <li>IPSEC Configuration</li> <li>Stunnel</li> <li>Modify Hosts File</li> <li><b>Configure Switch</b></li> <li>Exit</li> </ul>
<p>7. <input type="checkbox"/></p>	<p><b>MPS B:</b> Select Switch1B.</p>	<p>On the Select Switch Menu, select <b>Switch1B – Second Switch in Frame 1</b> and press [ENTER].</p>  <p>Select Switch Menu</p> <ul style="list-style-type: none"> <li>switch1A - Upper Switch in Frame 1</li> <li><b>switch1B - Second Switch in Frame 1</b></li> <li>switch1C - Third Switch in Frame 1</li> <li>switch1D - Lower Switch in Frame 1</li> <li>All Switches</li> <li>Exit</li> </ul>
<p>8. <input type="checkbox"/></p>	<p><b>MPS B:</b> Confirm Switch 1B Configuration.</p>	<p>Select <b>Yes</b> and press [ENTER] to configure Switch 1B.</p>  <p>Really configure switch switch1B? Disrupt network connectivity?</p> <p><b>Yes</b> No</p>

## Procedure 9: Switch Configuration

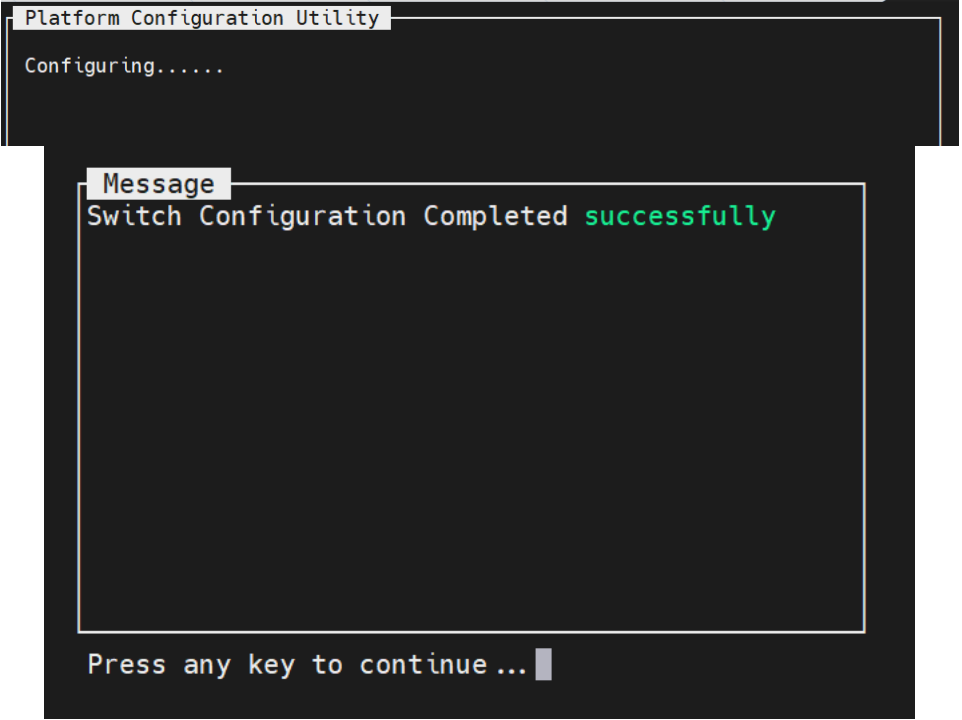
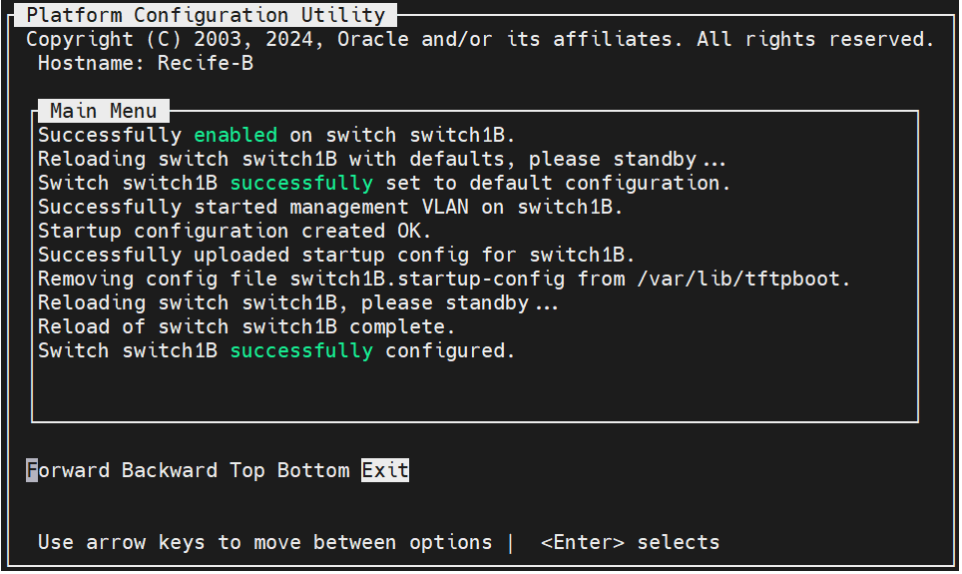
<p>9. <input type="checkbox"/></p>	<p><b>MPS B: Switch Configuration Screen.</b></p>	<p>Configuring the switch takes about 10 minutes, once completed press any key to continue and then click Exit.</p>  
<p>10. <input type="checkbox"/></p>	<p><b>MPS B: Exit out of platcfg.</b></p>	<p>Select Exit and press [ENTER] to return to the Network Configuration Menu. Select Exit and press [ENTER] to return to the Main Menu.</p>

## Procedure 9: Switch Configuration

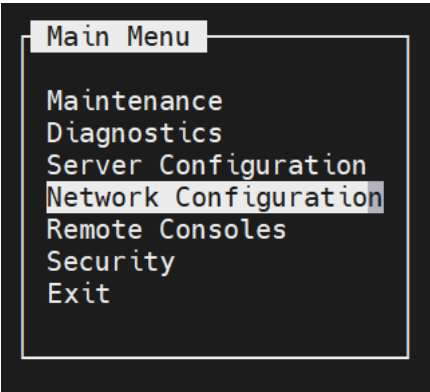
		Select Exit and press [ENTER] to exit out of platcfg.
11. <input type="checkbox"/>	<b>MPS A:</b> Connect to Server 1A.	Now that Switch 1B is configured, we need to configure switch 1A. Connect to server 1A to configure switch 1A  [hostname] consolelogin: admusr password: <i>password</i>
12. <input type="checkbox"/>	<b>MPS A:</b> Set Telco Switch with non-default speed.	Note: The default speed to be set on the switch is 1000Mbps. However, the recommended setting can be changed to 'auto', '1000/full' or '100/full'. At the EAGLE end, the operator can set the IP LINK to 'auto'. Otherwise proceed to step 13.
13. <input type="checkbox"/>	<b>MPS A:</b> Start platcfg. utility	\$ sudo su - platcfg
14. <input type="checkbox"/>	<b>MPS A:</b> Navigate to the Network Configuration Menu.	On the platcfg <b>Main Menu</b> , select <b>Network Configuration</b> and press [ENTER].  
15. <input type="checkbox"/>	<b>MPS A:</b> Navigate to the Configure Switch Menu.	On the Network Configuration menu, select <b>Configure Switch</b> and press [ENTER].

**Procedure 9: Switch Configuration**

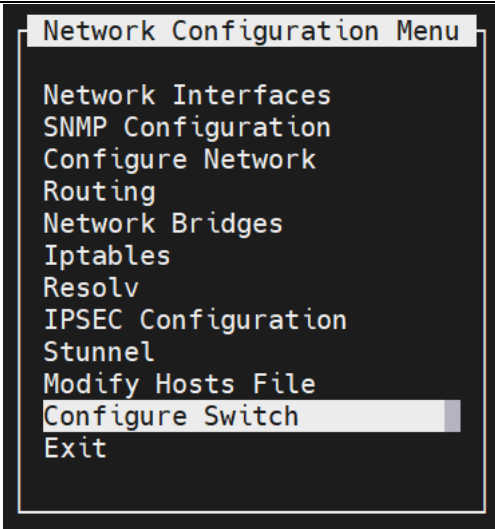
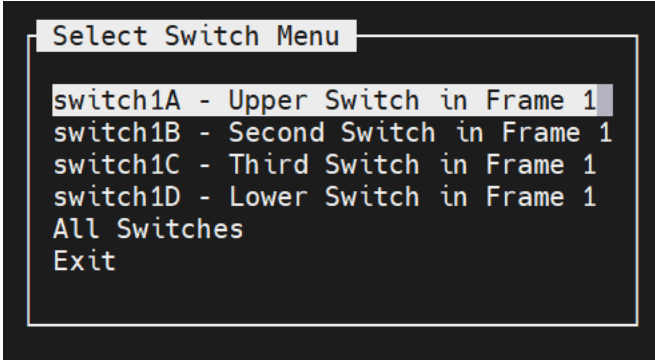
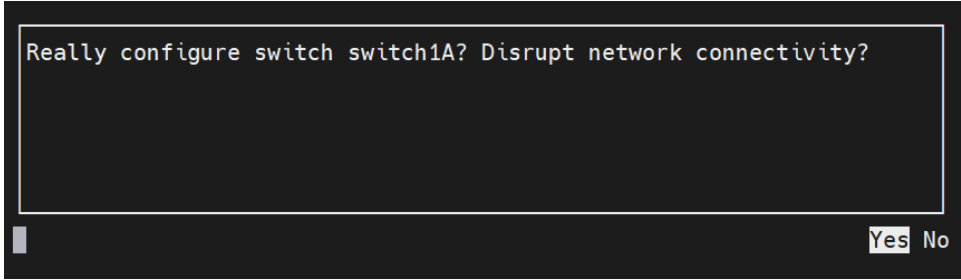
		 <pre> Network Configuration Menu Network Interfaces SNMP Configuration Configure Network Routing Network Bridges Iptables Resolv IPSEC Configuration Stunnel Modify Hosts File Configure Switch Exit         </pre>
<p>16. <input type="checkbox"/></p>	<p><b>MPS A:</b> Select Switch1A.</p>	<p>On the Select Switch Menu, select <b>Switch1A – Upper Switch in Frame 1</b> and press [ENTER].</p>  <pre> Select Switch Menu switch1A - Upper Switch in Frame 1 switch1B - Second Switch in Frame 1 switch1C - Third Switch in Frame 1 switch1D - Lower Switch in Frame 1 All Switches Exit         </pre>
<p>17. <input type="checkbox"/></p>	<p><b>MPS A:</b> Confirm Switch 1A Configuration.</p>	<p>Select <b>Yes</b> and press [ENTER] to configure Switch 1A.</p>  <pre> Really configure switch switch1A? Disrupt network connectivity? Yes No         </pre>
<p>18. <input type="checkbox"/></p>	<p><b>MPS A:</b> Navigate to the Configure Switch Menu.</p>	<p>Configuring the switch takes about 10 minutes, once completed press <b>any key</b> to continue and then click Exit.</p>

## Procedure 9: Switch Configuration

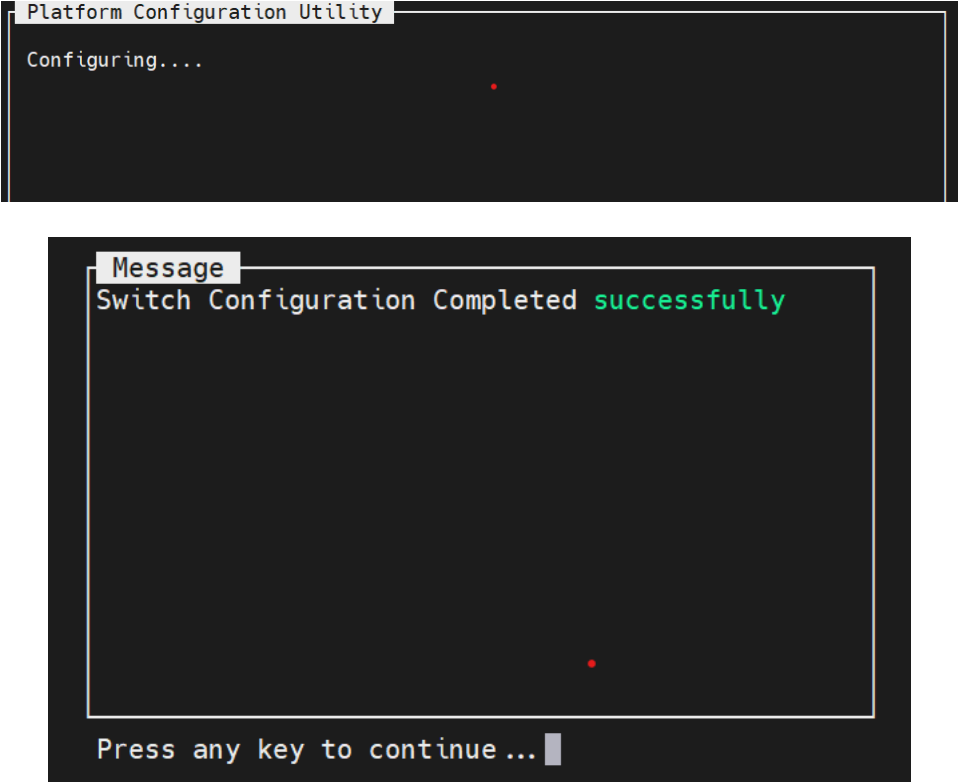
		 <p>Platform Configuration Utility Configuring...</p> <p>Message Switch Configuration Completed <b>successfully</b></p> <p>Press any key to continue ...</p> <p>Platform Configuration Utility Copyright (C) 2003, 2024, Oracle and/or its affiliates. All rights reserved. Hostname: Recife-A</p> <p>Main Menu Successfully <b>enabled</b> on switch switch1A. Reloading switch switch1A with defaults, please standby... Switch switch1A <b>successfully</b> set to default configuration. Successfully started management VLAN on switch1A. WARNING: File '/var/lib/tftpboot/switch1A.startup-config' already exists , and will be overwritten! Startup configuration created OK. Successfully uploaded startup config for switch1A. Removing config file switch1A.startup-config from /var/lib/tftpboot. Reloading switch switch1A, please standby... Reload of switch switch1A complete. Switch switch1A <b>successfully</b> configured.</p> <p>Forward Backward Top Bottom <b>Exit</b></p> <p>Use arrow keys to move between options   &lt;Enter&gt; selects</p>
<p>19. <input type="checkbox"/></p>	<p><b>MPS A:</b> Exit out of platcfg.</p>	<p>Select Exit and press [ENTER] to return to the Network Configuration Menu. Select Exit and press [ENTER] to return to the Main Menu. Select Exit and press [ENTER] to exit out of platcfg.</p>

## Procedure 9: Switch Configuration

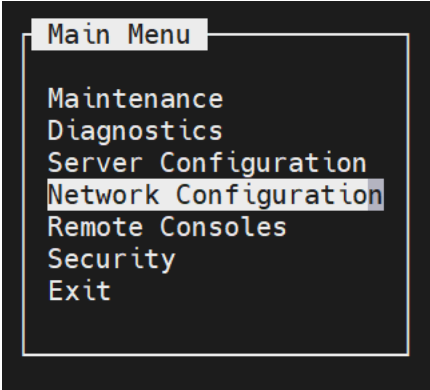
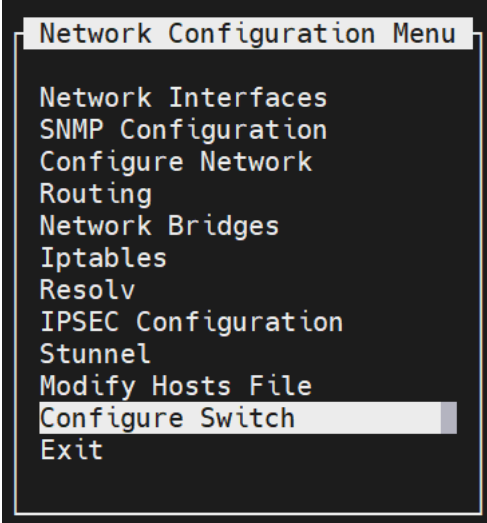
<p>20. <input type="checkbox"/></p>	<p><b>MPS A:</b> Optional Configuration of Switch 1C.</p>	<p>If the system is installed with 4 switches, proceed with the next step, otherwise skip to step 37.</p>
<p>21. <input type="checkbox"/></p>	<p>Move Serial Cables.</p>	<p>On the front of switches 1A and 1B, unplug the serial cables connected to Console port and plug them in switches 1C and 1D Console port respectively.</p>
<p>22. <input type="checkbox"/></p>	<p><b>MPS A:</b> Start platcfg utility.</p>	<p><b>\$ sudo su - platcfg</b></p>
<p>23. <input type="checkbox"/></p>	<p><b>MPS A:</b> Navigate to the Network Configuration Menu.</p>	<p>On the platcfg <b>Main Menu</b>, select <b>Network Configuration</b> and press [ENTER].</p> 
<p>24. <input type="checkbox"/></p>	<p><b>MPS A:</b> Navigate to the Configure Switch Menu.</p>	<p>On the Network Configuration menu, select <b>Configure Switch</b> and press [ENTER].</p> 

**Procedure 9: Switch Configuration**

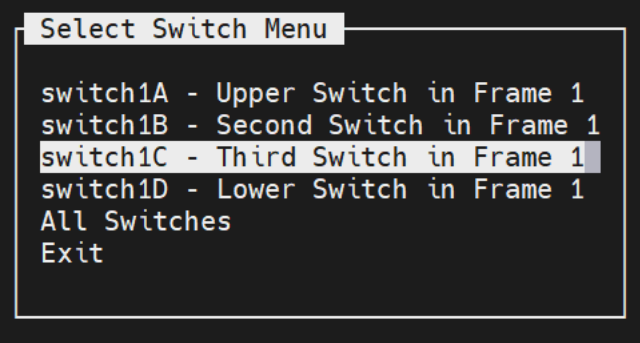
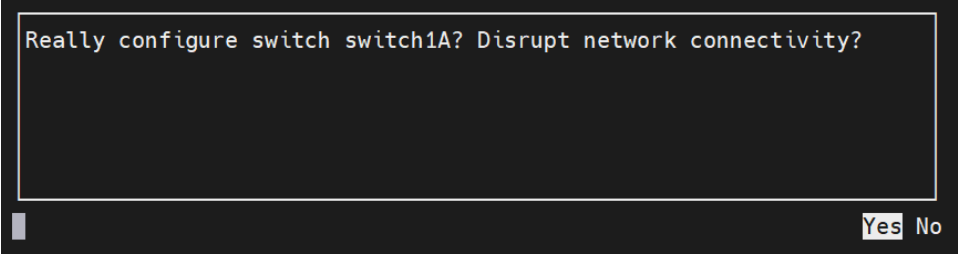
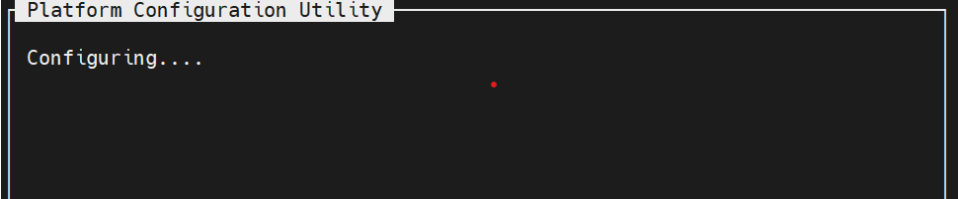
<p>25. <input type="checkbox"/></p>	<p><b>MPS A:</b> Select Switch1C.</p>	<p>On the Select Switch Menu, select <b>Switch1C – Third Switch in Frame 1</b> and press [ENTER].</p> 
<p>26. <input type="checkbox"/></p>	<p><b>MPS A:</b> Confirm Switch 1C Configuration.</p>	<p>Select <b>Yes</b> and press [ENTER] to configure Switch 1C</p> 
<p>27. <input type="checkbox"/></p>	<p><b>MPS A:</b> Navigate to the Configure Switch Menu.</p>	<p>Configuring the switch takes about 10 minutes, once completed press any key to continue and then click Exit.</p> 

## Procedure 9: Switch Configuration

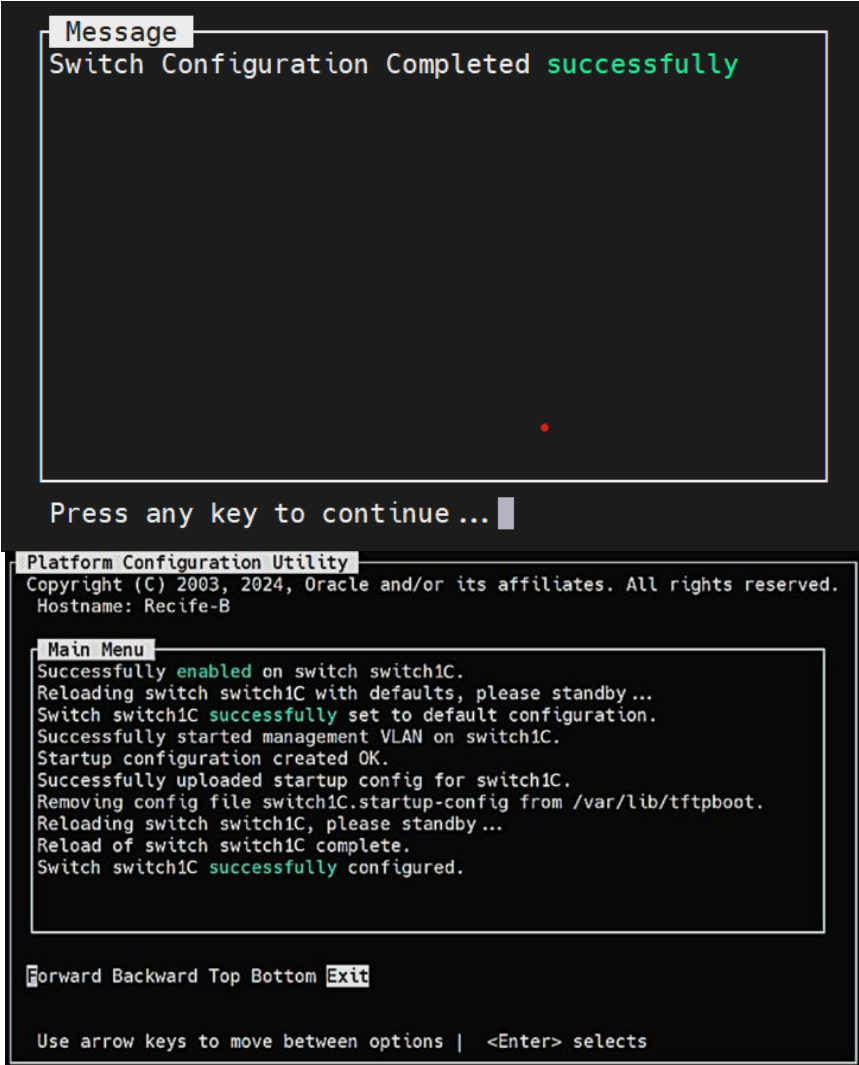
		 <p>The screenshot shows the Platform Configuration Utility (platcfg) interface. At the top, a message box displays "Switch Configuration Completed successfully". Below this, it prompts "Press any key to continue ...". The main menu lists several options, including "Network Configuration". The bottom of the screen shows navigation instructions: "Use arrow keys to move between options   &lt;Enter&gt; selects".</p>
<p>28. <input type="checkbox"/></p>	<p><b>MPS A:</b> Exit out of platcfg.</p>	<p>Select Exit and press [ENTER] to return to the Network Configuration Menu.          Select Exit and press [ENTER] to return to the Main Menu.          Select Exit and press [ENTER] to exit out of platcfg.</p>
<p>29. <input type="checkbox"/></p>	<p><b>MPS B:</b> Connect to Server 1B.</p>	<pre>[hostname] consolelogin: admusr password: password</pre>
<p>30. <input type="checkbox"/></p>	<p><b>MPS B:</b> Start platcfg utility.</p>	<pre>\$ sudo su - platcfg</pre>
<p>31. <input type="checkbox"/></p>	<p><b>MPS B:</b> Navigate to the Network</p>	<p>On the platcfg <b>Main Menu</b>, select <b>Network Configuration</b> and press [ENTER].</p>

## Procedure 9: Switch Configuration

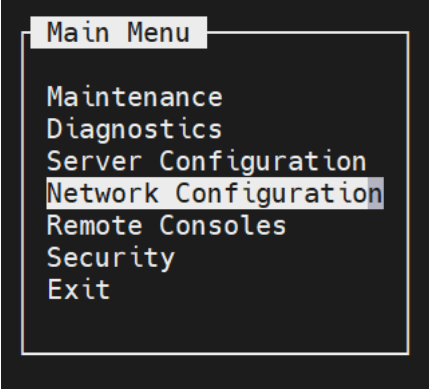
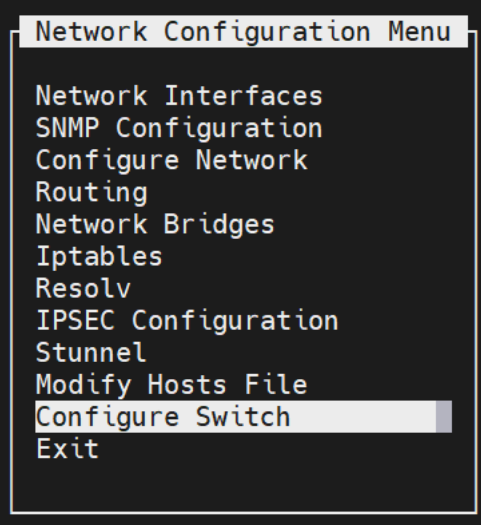
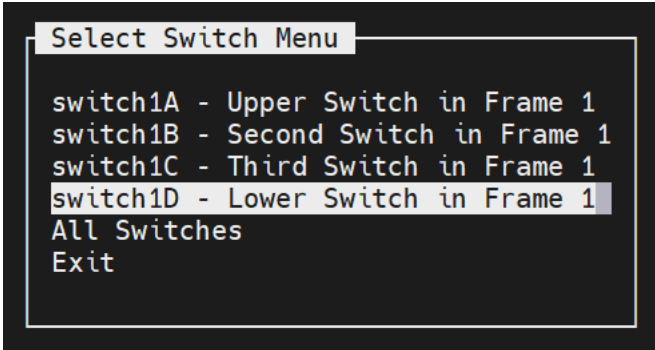
	<p>Configuration Menu.</p>	
<p>32. <input type="checkbox"/></p>	<p><b>MPS B:</b> Navigate to the Configure Switch Menu.</p>	<p>On the Network Configuration menu, select <b>Configure Switch</b> and press [ENTER].</p> 
<p>33. <input type="checkbox"/></p>	<p><b>MPS B:</b> Select Switch1D.</p>	<p>On the Select Switch Menu, select <b>Switch1D – Lower Switch in Frame 1</b> and press [ENTER].</p> 

### Procedure 9: Switch Configuration

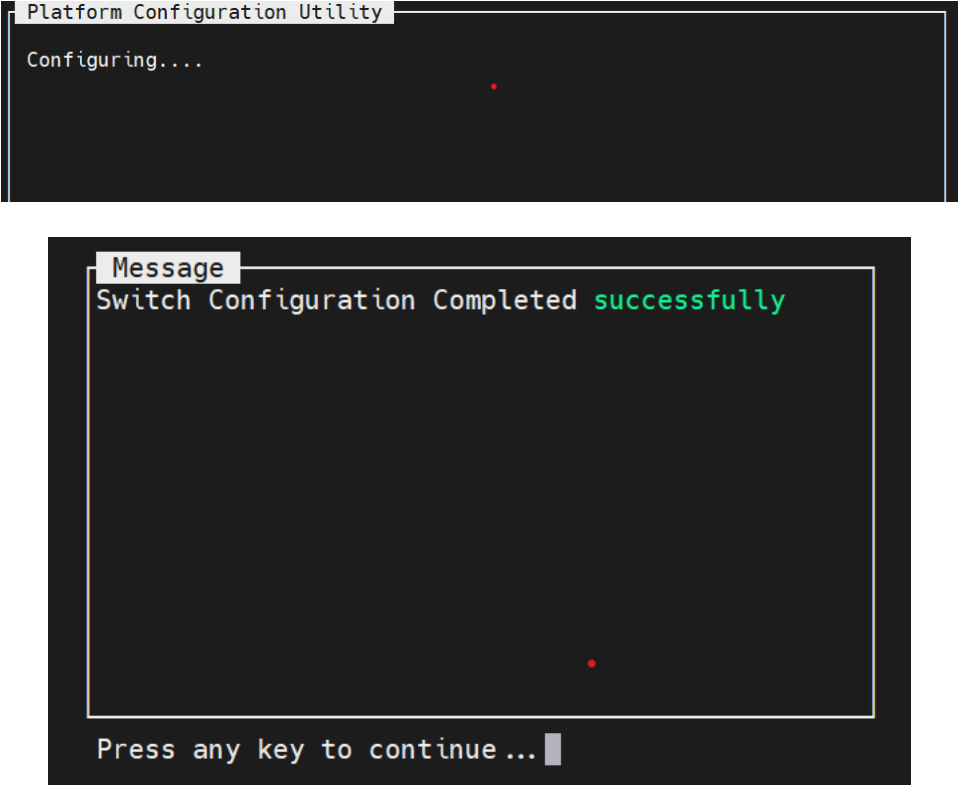
<p>34. <input type="checkbox"/></p>	<p><b>MPS B:</b> Confirm Switch 1D Configuration.</p>	<p>Select <b>Yes</b> and press <b>[ENTER]</b> to configure Switch 1D.</p> 
<p>35. <input type="checkbox"/></p>	<p><b>MPS B:</b> Switch Configuration Screen.</p>	<p>Configuring the switch takes about 10 minutes, once completed press any key to continue and then click Exit.</p> 

## Procedure 9: Switch Configuration

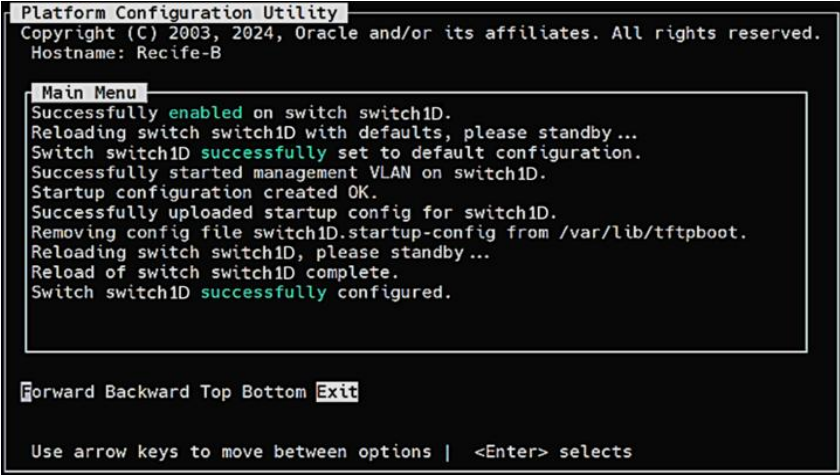
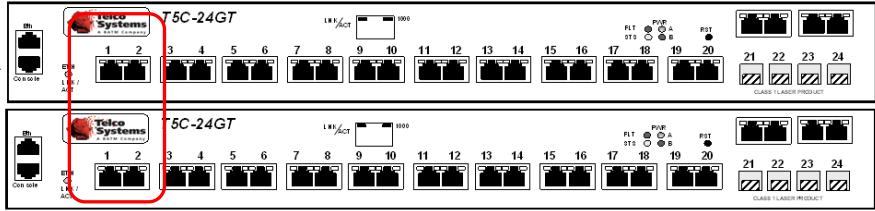
		
<p>36. <input type="checkbox"/></p>	<p><b>MPS B:</b> Exit out of platcfg.</p>	<p>Select Exit and press [ENTER] to return to the Network Configuration Menu.            Select Exit and press [ENTER] to return to the Main Menu.            Select Exit and press [ENTER] to exit out of platcfg.</p>
<p>37. <input type="checkbox"/></p>	<p>Connect the cross-over cable from <b>Port 2 of Switch1A</b> to <b>Port 2 of Switch1B</b>.</p>	
<p>38. <input type="checkbox"/></p>	<p>Procedure complete.</p>	<p>Procedure is complete.</p>
<p>39. <input type="checkbox"/></p>	<p>Note down the timestamp in log.</p>	<p>Run the following command:  <b>\$ date</b></p>

## Procedure 10 Configure Sync Network Redundancy

Note: This procedure will configure the E5-APP-B EPAP cards with the Sync Network Redundancy feature. This will use the Backup Provisioning Network ports, therefore the Backup Provisioning Network feature cannot be used.

## Procedure 10: Procedure to Configure Sync Network Redundancy

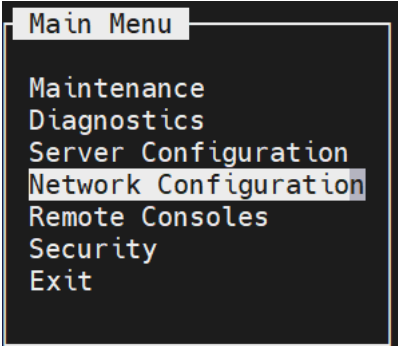
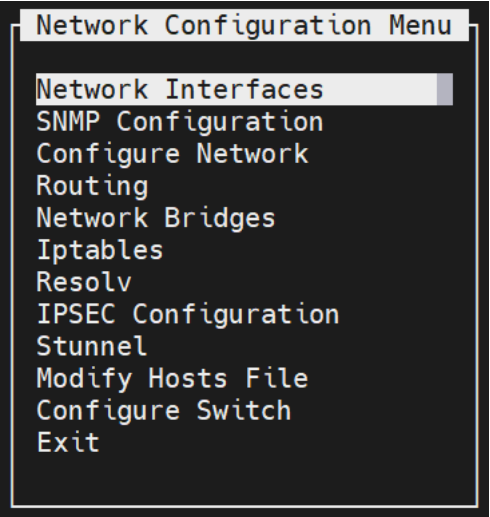
S T E P #	<p>This procedure will sync network redundancy in place of backup provisioning network.</p> <p>Note: Estimated time of completion is 90 minutes.</p>	
1. <input type="checkbox"/>	<p><b>MPS A:</b> Log in as “admusr” user to the serial console of E5-APP-B card.</p>	<pre>[hostname] consolelogin: admusr password: password</pre>
2. <input type="checkbox"/>	<p><b>MPS A:</b> Start platcfg utility.</p>	<pre>\$ sudo su - platcfg</pre>
3. <input type="checkbox"/>	<p><b>MPS A:</b> Navigate to the Network Configuration Menu.</p>	<p>On the platcfg <b>Main Menu</b>, select <b>Network Configuration</b> and press <b>[ENTER]</b>.</p>  <p>The screenshot shows a terminal window titled "Main Menu" with the following options: Maintenance, Diagnostics, Server Configuration, Network Configuration (highlighted), Remote Consoles, Security, and Exit.</p>
4. <input type="checkbox"/>	<p><b>MPS A:</b> Navigate to the Network Interfaces Menu.</p>	<p>On the Network Configuration menu, select <b>Network Interfaces</b> and press <b>[ENTER]</b>.</p>  <p>The screenshot shows a terminal window titled "Network Configuration Menu" with the following options: Network Interfaces (highlighted), SNMP Configuration, Configure Network, Routing, Network Bridges, Iptables, Resolv, IPSEC Configuration, Stunnel, Modify Hosts File, Configure Switch, and Exit.</p>

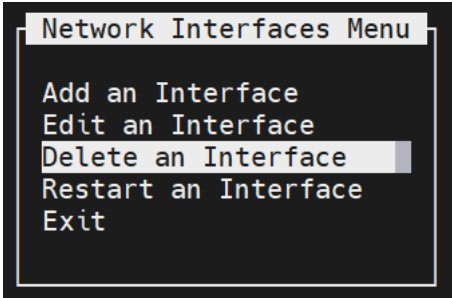
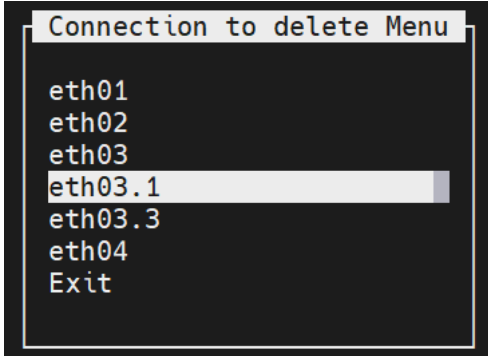
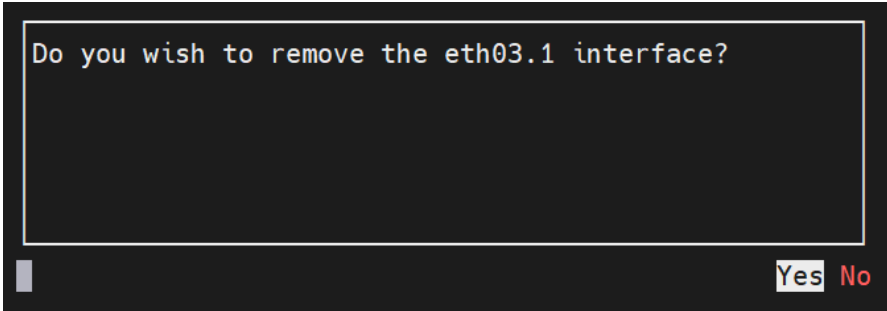
<p>5. <input type="checkbox"/></p>	<p><b>MPS A:</b> Navigate to the Delete an Interface Menu.</p>	<p>On the Network Interfaces Menu, select <b>Delete an Interface</b> and press <b>[ENTER]</b>.</p>  <p>The screenshot shows a terminal window titled "Network Interfaces Menu" with the following options: "Add an Interface", "Edit an Interface", "Delete an Interface" (highlighted with a white bar), "Restart an Interface", and "Exit".</p>
<p>6. <input type="checkbox"/></p>	<p><b>MPS A:</b> Select to delete eth03.1 and press Enter.</p>	<p>On the Connection to delete Menu, select <b>eth03.1</b> and press <b>[ENTER]</b>.</p>  <p>The screenshot shows a terminal window titled "Connection to delete Menu" with the following options: "eth01", "eth02", "eth03", "eth03.1" (highlighted with a white bar), "eth03.3", "eth04", and "Exit".</p>
<p>7. <input type="checkbox"/></p>	<p><b>MPS A:</b> Confirm eth03.1 interface deletion.</p>	<p>Select <b>Yes</b> and press <b>[ENTER]</b> to delete the eth03.1 interface.</p>  <p>The screenshot shows a terminal window with the text "Do you wish to remove the eth03.1 interface?" and two options at the bottom: "Yes" (highlighted with a white bar) and "No".</p>

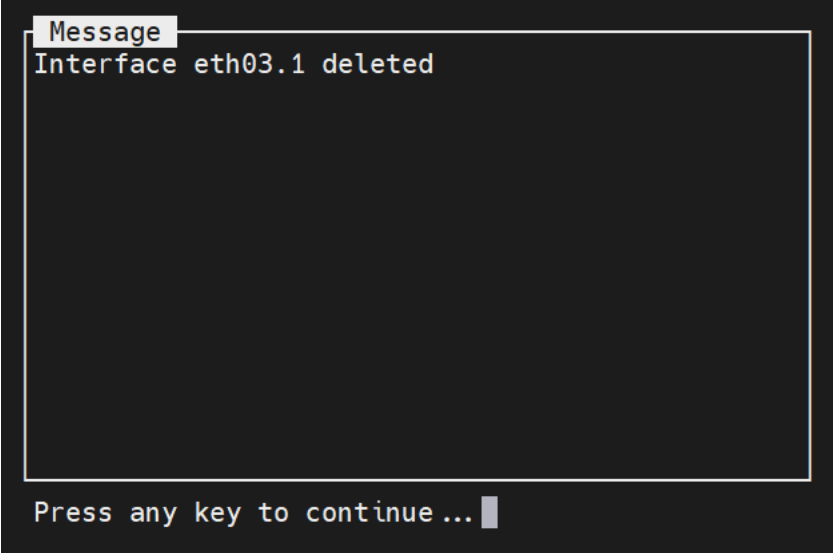
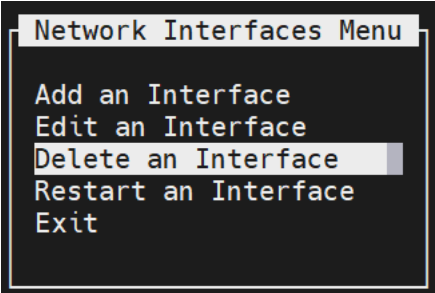
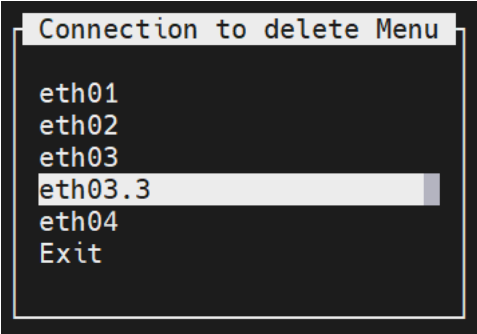
		
<p>8. <input type="checkbox"/></p>	<p><b>MPS A:</b> Press any key to continue.</p> <p>Navigate to the Delete an Interface Menu.</p>	<p>On the Network Interfaces Menu, select <b>Delete an Interface</b> and press <b>[ENTER]</b>.</p> 
<p>9. <input type="checkbox"/></p>	<p><b>MPS A:</b> Select to delete eth03.3 and press Enter.</p>	<p>On the Connection to delete Menu, select <b>eth03.3</b> and press <b>[ENTER]</b>.</p> 

<p>10. <input type="checkbox"/></p>	<p><b>MPS A:</b> Confirm eth03.3 interface deletion.</p>	<p>Select <b>Yes</b> and press <b>[ENTER]</b> to delete the eth03.3 interface.</p>  
<p>11. <input type="checkbox"/></p>	<p><b>MPS A:</b> Press any key to continue and exit out of platcfg.</p>	<p>Select Exit and press <b>[ENTER]</b> to return to the Network Configuration Menu.</p> <p>Select Exit and press <b>[ENTER]</b> to return to the Main Menu.</p> <p>Select Exit and press <b>[ENTER]</b> to exit out of platcfg.</p>
<p>12. <input type="checkbox"/></p>	<p><b>MPS A:</b> Verify that eth03.1 and eth03.3 are deleted.</p>	<pre>\$ sudo netAdm show eth01 eth02 eth03 eth04</pre> <p>The interfaces eth03.1 and eth03.3 should not be listed.</p>

13. <input type="checkbox"/>	<b>MPS A:</b> Take the backup of original net.conf.	<pre>\$ sudo cp /usr/TKLC/plat/etc/net.conf /usr/TKLC/plat/etc/net.conf_orig</pre>
14. <input type="checkbox"/>	<b>MPS A:</b> Replace the network configuration file for sync network redundancy.	<pre>\$ sudo cp /usr/TKLC/plat/etc/net.sync.conf /usr/TKLC/plat/etc/net.conf</pre> cp: overwrite `/usr/TKLC/plat/etc/net.conf'? y
15. <input type="checkbox"/>	<b>MPS A A:</b> Take the backup of original vlan.conf.	<pre>\$ sudo cp /usr/TKLC/plat/etc/vlan.conf /usr/TKLC/plat/etc/vlan.conf_orig</pre>
16. <input type="checkbox"/>	<b>MPS A:</b> Replace the vlan configuration file for sync network redundancy.	<p><u>E5-APP-B Card:</u></p> <p>Single Pair of Switch(18 SM Cards): <b>vlan.sync.single_pair_switch.e5appb.conf</b></p> <p>(Ports 7 to 24 on switch 1A and ports 5 to 24 on switch 1B can be used for SM card connectivity)</p> <p>Two Pair of switches (40 SM Cards): <b>vlan.sync.e5appb.conf</b></p> <p>(Ports 7 to 22 on switch 1A and ports 5 to 22 on switch 1B can be used for SM card connectivity, no change for switch 1C and 1D)</p> <p>For e.g., on T1200 server for Single pair of switches:</p> <pre>\$ sudo cp /usr/TKLC/plat/etc/vlan.sync.single_pair_switch.t1200.conf /usr/TKLC/plat/etc/vlan.conf</pre> <p>cp: overwrite `/usr/TKLC/plat/etc/vlan.conf'? y</p>
17. <input type="checkbox"/>	<b>MPS A:</b> Reconfigure the network interfaces.	<pre>\$ sudo netAdm init</pre> <p>Interface bond0 added</p> <p>Interface eth01 added</p> <p>Interface eth02 added</p> <p>Interface bond0.3 added</p> <p>Interface eth03 added</p> <p>Interface eth04 added</p> <p>Interface bond0.1 added</p> <p>Successfully configured network</p>
18. <input type="checkbox"/>	<b>MPS A:</b> Restart network service.	<pre>\$ sudo systemctl restart network</pre>
19. <input type="checkbox"/>	<b>MPS B</b>	Repeat all the above steps on the MPS B.

20. <input type="checkbox"/>	<b>Network Connectivity</b>	Connect eth04 on MPS A to port 5 on Switch 1A and connect eth04 on MPS B to port 6 on Switch 1A.
21. <input type="checkbox"/>	Configure Switch 1B first and then Switch 1A using 0.	Perform <b>0</b> – Switch1B and Switch1A Configuration to configure Switch1B and then Switch1A.
22. <input type="checkbox"/>	<b>MPS A:</b> Verify that ping mate is working.  Also ensure that the sync redundancy is working fine by turning off one switch and running ping mate.	<b>\$ ping -c 4 mate</b> PING mate (192.168.2.100) 56(84) bytes of data. 64 bytes from mate (192.168.2.100): icmp_seq=1 ttl=64 time=0.189 ms 64 bytes from mate (192.168.2.100): icmp_seq=2 ttl=64 time=0.188 ms 64 bytes from mate (192.168.2.100): icmp_seq=3 ttl=64 time=0.166 ms 64 bytes from mate (192.168.2.100): icmp_seq=4 ttl=64 time=0.143 ms  --- mate ping statistics --- 4 packets transmitted, 4 received, 0% packet loss, time 3001ms rtt min/avg/max/mdev = 0.143/0.171/0.189/0.022 ms
23. <input type="checkbox"/>	<b>MPS A:</b> Reconfigure EPAP using epapconfig menu if the configuration was done before configuring sync network redundancy.	<b>\$ su - epapconfig</b> Please follow the instructions written in 0.
24. <input type="checkbox"/>	Procedure complete.	Procedure is complete.
25. <input type="checkbox"/>	Note down the timestamp in log.	Run the following command: <b>\$ date</b>

## Procedure 11 Configuring the application

### Procedure 11: Configuring the Application

<b>S T E P #</b>	<p>This procedure configures the application on the server.</p> <p>Check off (✓) each step as it is completed. Boxes have been provided for this purpose under each step number.</p> <p>IF THIS PROCEDURE FAILS, CONTACT MY ORACLE SUPPORT AND ASK FOR ASSISTANCE.</p>
----------------------------------	--

## Procedure 11: Configuring the Application

**NOTE: This procedure configures the application in the IPv4 configuration. To configure the application in the IPv6 configuration, refer to [6].**

1. <input type="checkbox"/>	<b>MPS A:</b> Log on Server A.	<code>[hostname] consolelogin: admusr password: <i>password</i></code>
2. <input type="checkbox"/>	<b>MPS A:</b> Switch user to epapconfig.	<code>\$ sudo su - epapconfig</code>  warning: Smartmatch is experimental at /usr/TKLC/plat/lib/Security/User.pm line 904.
3. <input type="checkbox"/>	<b>MPS A:</b> A note of caution appears. Evaluate the conditions listed. When all the conditions are satisfied, press Return to continue.	Caution: This is the first login of the text user interface. Please review the following checklist before continuing. Failure to enter complete and accurate information at this time will have unpredictable results.  <ol style="list-style-type: none"> <li>1. The mate MPS servers (MPS A and MPS B) must be powered on.</li> <li>2. "Initial Platform Manufacture" for the mate MPS servers must be complete.</li> <li>3. The sync network between the mate MPS servers must be operational.</li> <li>4. You must have the correct password for the epapdev user on the mate MPS server.</li> <li>5. You must be prepared to designate this MPS as provisionable or non-provisionable.</li> </ol> Press return to continue...
4. <input type="checkbox"/>	<b>MPS A:</b> Upon pressing Return you can now abort or proceed with the initial configuration. To continue with the configuration, enter Y.	Are you sure you wish to continue? [N]:Y

## Procedure 11: Configuring the Application

<p>5. <input type="checkbox"/></p>	<p><b>MPS A:</b>  <b>For Mixed EPAP or Non-Provisionable EPAP:</b> You are prompted for the <b>epapdev, root and admusr</b> user password on the mate MPS server in order to confirm the secure shell keys are successfully exchanged. The example shows the output generated when the correct password is entered, the secure shell keys are successfully exchanged, and the UI database is set up on <b>MPS A and MPS B</b> at this site.  Type <b>Y</b> if this site is <b>Provisionable</b>(either mixed-EPAP or PDBonly), <b>otherwise Type N.</b></p> <p><b>For Standalone PDB:</b>  You are prompted for the <b>System Number</b> and <b>Network Configuration Type.</b></p>	<pre> Password of epapdev: ssh is working correctly. Password of root: ssh is working correctly. Password of admusr: ssh is working correctly. Password of root: ssh is working correctly. Building the initial database on side A.   Stopping local slave   Stopping remote slave EuiDB already exists. FIPS integrity verification test failed.   Starting local slave   Starting remote slave  The provisioning architecture of the EPAP software allows for exactly 2 customer provisionable sites.  Additional sites that are to receive the data provisioned to the provisionable sites should answer 'N' here.  If there are only 2 mated sites, it is safe to answer `Y' here.  Is this site provisionable? [Y]: Y  Caution: This is the first login of the text user interface.  Press return to continue... Are you sure you wish to continue? [N]: Y Building the initial database on side A.   Stopping local slave No preexisting EuiDB database was detected. Set EPAP System Number: E812345678 Enter the Network Configuration Type (1 for Single, 2 for Segmented): 2 </pre>
<p>6. <input type="checkbox"/></p>	<p><b>MPS A:</b> The EPAP Configuration Menu is displayed. Select choice 2, Configure Network Interfaces Menu.</p>	<p><b>EPAP Configuration Menu for standalone PDB:</b></p>

## Procedure 11: Configuring the Application

		<pre>/-----EPAP Configuration Menu-----\ /   1   Display Configuration    -----    2   Configure Network Interfaces Menu    -----    3   Set Time Zone    -----    4   Exchange Secure Shell Keys    -----    5   Change Password    -----    6   Platform Menu    -----    7   Configure NTP Server    -----    8   PDB Configuration Menu    -----    9   Security    -----    10   SNMP Configuration    -----    11   Configure Alarm Feed    -----    12   Configure Query Server    -----    13   Configure Query Server Alarm Feed    -----    14   Configure SNMP Agent Community    -----    15   DB Architecture Menu    -----    e   Exit   \  EPAP Configuration Menu for NON-Prov EPAP:</pre>	
--	--	--	--

## Procedure 11: Configuring the Application

		<pre> /-----EPAP Configuration Menu-----\ /-----\   1   Display Configuration  -----    2   Configure Network Interfaces Menu  -----    3   Set Time Zone  -----    4   Exchange Secure Shell Keys  -----    5   Change Password  -----    6   Platform Menu  -----    7   Configure NTP Server  -----    8   PDB Configuration Menu  -----    9   Security  -----    10   SNMP Configuration  -----    11   Configure Alarm Feed  -----    12   Configure SNMP Agent Community  -----    13   Mate Disaster Recovery  -----    14   DB Architecture Menu  -----    e   Exit \-----/ </pre> <p>Enter Choice: 2</p>
<p>7. <input type="checkbox"/></p>	<p><b>MPS A:</b> The Configure Network Interfaces Menu is displayed. Select choice 1, Configure Provisioning Network.</p>	<p><b>Configuration Menu for Mixed EPAP and Non-Provisionable EPAP:</b></p> <pre> /-----Configure Network Interfaces Menu-----\   1   Configure Provisioning Network  -----    2   Configure Sync Network  -----    3   Configure DSM Network  -----    4   Configure Backup Provisioning Network  -----    5   Configure Static NAT Addresses  -----    6   Configure Provisioning VIP Addresses  -----  </pre>

## Procedure 11: Configuring the Application

		<pre>   e   Exit \-----/  Enter Choice: 1  <b>Configuration Menu for Standalone PDB:</b>  /-----Configure Network Interfaces Menu-----\   1   Configure Provisioning Network   2   Configure Backup Provisioning Network   3   Configure Static NAT Addresses   e   Exit \-----/  Enter Choice: 1 </pre>
<p>8. <input type="checkbox"/></p>	<p><b>MPS A:</b> The submenu for configuring communications networks and other information is displayed.</p> <p>Note: Enter choice "1" for IPv4 configuration. Otherwise, enter choice "2" for IPv6 configuration.</p>	<pre> /-----Configure Provisioning Network Menu-----\   1   IPv4 Configuration   2   IPv6 Configuration   e   Exit \-----/  Enter Choice: █  Example output for Mixed EPAP and Non-Provisionable EPAP in IPv4 configuration:  Enter Choice: 1  Verifying connectivity with mate... EPAP A provisioning network IP Address: 10.75.141.47 EPAP B provisioning network IP Address: 10.75.141.48 EPAP provisioning network netmask: 255.255.255.128 EPAP provisioning network default router: 10.75.141.1  Example output Standalone PDB in IPv4 configuration:  EPAP A provisioning network IP Address:10.75.141.47 EPAP provisioning network netmask:255.255.255.128 EPAP provisioning network default router:10.75.141.1 </pre>
<p>9. <input type="checkbox"/></p>	<p><b>MPS A:</b> The Configure Network Interfaces menu is displayed. Select choice e, Exit.</p>	<pre> Configuration Menu for Mixed EPAP and Non-Provisionable EPAP:  /-----Configure Network Interfaces Menu-----\   1   Configure Provisioning Network   2   Configure Sync Network   3   Configure DSM Network   4   Configure Backup Provisioning Network </pre>

**Procedure 11: Configuring the Application**

		<pre> 5   Configure Static NAT Addresses 6   Configure Provisioning VIP Addresses e   Exit -----\ Enter Choice: e  Configuration Menu for Standalone PDB:  /-----Configure Network Interfaces Menu-----\ 1   Configure Provisioning Network 2   Configure Backup Provisioning Network 3   Configure Static NAT Addresses e   Exit -----\  Enter Choice: e </pre>
<p>10. <input type="checkbox"/></p>	<p><b>MPS A:</b> The EPAP Configuration Menu is displayed. Select choice 3, Set Time Zone.</p>	<p><b>EPAP Configuration Menu for Non-prov EPAP:</b></p>

**Procedure 11: Configuring the Application**

		<pre> /-----EPAP Configuration Menu-----\ /-----\   1   Display Configuration  -----    2   Configure Network Interfaces Menu  -----    3   Set Time Zone  -----    4   Exchange Secure Shell Keys  -----    5   Change Password  -----    6   Platform Menu  -----    7   Configure NTP Server  -----    8   PDB Configuration Menu  -----    9   Security  -----    10   SNMP Configuration  -----    11   Configure Alarm Feed  -----    12   Configure SNMP Agent Community  -----    13   Mate Disaster Recovery  -----    14   DB Architecture Menu  -----    e   Exit \-----/ </pre> <p>Enter Choice: 3</p>
<p>11. <input type="checkbox"/></p>	<p><b>MPS A:</b> An important Caution statement is displayed. After noting the caution, press Return to continue.</p>	<p>Caution: This action requires a reboot of the affected MPS servers to activate the change. Operation of the EPAP software before the MPS servers are rebooted may have unpredictable consequences.</p> <p>Press return to continue...&lt;return&gt;</p> <p>Are you sure you wish to change the timezone for MPS A and B? [N]: Y</p>

## Procedure 11: Configuring the Application

	<p>You are prompted for confirmation on setting the time zone for the MPS A and MPS B at this site for Mixed EPAP or Non-provisionable EPAP. For Standalone PDB, time zone for MPS A is prompted only. Enter y to confirm the change. (Pressing Return accepts the default of 'N' (no), cancels the action and you are returned to the EPAP Configuration Menu). Type Y to set the time zone.</p>																																																																																		
<p>12. <input type="checkbox"/></p>	<p><b>MPS A:</b> The following prompt is displayed. If the time zone is known, it can be entered at the prompt. If the exact time zone value is not known, press Return, and a list of the valid names is displayed.</p>	<p>Enter a time zone:</p>																																																																																	
<p>13. <input type="checkbox"/></p>	<p>If an incorrect time zone is entered or if only the Return key is pressed, a list of all available time zone values is displayed.</p> <p>Note: The time zone change does not take effect until the next time the MPS is rebooted.</p>	<p>Valid time zone files are:</p> <table border="0"> <tr> <td>Australia/Broken_Hill</td> <td>Australia/LHI</td> <td></td> </tr> <tr> <td>Australia/NSW</td> <td></td> <td></td> </tr> <tr> <td>Australia/North</td> <td>Australia/Queensland</td> <td></td> </tr> <tr> <td>Australia/South</td> <td></td> <td></td> </tr> <tr> <td>Australia/Tasmania</td> <td>Australia/Victoria</td> <td></td> </tr> <tr> <td>Australia/west</td> <td></td> <td></td> </tr> <tr> <td>Australia/Yancowinna</td> <td>Australia/ACT</td> <td>Brazil/Acre</td> </tr> <tr> <td>Brazil/DeNoronha</td> <td>Brazil/East</td> <td>Brazil/West</td> </tr> <tr> <td>Canada/Atlantic</td> <td>Canada/Central</td> <td>Canada/East-</td> </tr> <tr> <td>Saskatchewan</td> <td></td> <td></td> </tr> <tr> <td>Canada/Eastern</td> <td>Canada/Mountain</td> <td></td> </tr> <tr> <td>Canada/Newfoundland</td> <td></td> <td></td> </tr> <tr> <td>Canada/Pacific</td> <td>Canada/Yukon</td> <td></td> </tr> <tr> <td>Chile/Continental</td> <td></td> <td></td> </tr> <tr> <td>Chile/EasterIsland</td> <td>Etc/GMT</td> <td>Etc/GMT+1</td> </tr> <tr> <td colspan="3">-----Sample Output continues-----</td> </tr> <tr> <td colspan="3">-----End of output below-----</td> </tr> <tr> <td>MST</td> <td>MST7MDT</td> <td>NZ</td> </tr> <tr> <td>NZ-CHAT</td> <td>PRC</td> <td>PST8PDT</td> </tr> <tr> <td>Poland</td> <td>Portugal</td> <td>ROC</td> </tr> <tr> <td>ROK</td> <td>Singapore</td> <td>Turkey</td> </tr> <tr> <td>W-SU</td> <td>WET</td> <td>africa</td> </tr> <tr> <td>asia</td> <td>australasia</td> <td>backward</td> </tr> <tr> <td>etcetera</td> <td>europa</td> <td>factory</td> </tr> <tr> <td>northamerica</td> <td>pacificnew</td> <td>solar87</td> </tr> <tr> <td>solar88</td> <td>solar89</td> <td>southamerica</td> </tr> <tr> <td>GB-Eire</td> <td>GMT</td> <td>GMT+0</td> </tr> </table>	Australia/Broken_Hill	Australia/LHI		Australia/NSW			Australia/North	Australia/Queensland		Australia/South			Australia/Tasmania	Australia/Victoria		Australia/west			Australia/Yancowinna	Australia/ACT	Brazil/Acre	Brazil/DeNoronha	Brazil/East	Brazil/West	Canada/Atlantic	Canada/Central	Canada/East-	Saskatchewan			Canada/Eastern	Canada/Mountain		Canada/Newfoundland			Canada/Pacific	Canada/Yukon		Chile/Continental			Chile/EasterIsland	Etc/GMT	Etc/GMT+1	-----Sample Output continues-----			-----End of output below-----			MST	MST7MDT	NZ	NZ-CHAT	PRC	PST8PDT	Poland	Portugal	ROC	ROK	Singapore	Turkey	W-SU	WET	africa	asia	australasia	backward	etcetera	europa	factory	northamerica	pacificnew	solar87	solar88	solar89	southamerica	GB-Eire	GMT	GMT+0
Australia/Broken_Hill	Australia/LHI																																																																																		
Australia/NSW																																																																																			
Australia/North	Australia/Queensland																																																																																		
Australia/South																																																																																			
Australia/Tasmania	Australia/Victoria																																																																																		
Australia/west																																																																																			
Australia/Yancowinna	Australia/ACT	Brazil/Acre																																																																																	
Brazil/DeNoronha	Brazil/East	Brazil/West																																																																																	
Canada/Atlantic	Canada/Central	Canada/East-																																																																																	
Saskatchewan																																																																																			
Canada/Eastern	Canada/Mountain																																																																																		
Canada/Newfoundland																																																																																			
Canada/Pacific	Canada/Yukon																																																																																		
Chile/Continental																																																																																			
Chile/EasterIsland	Etc/GMT	Etc/GMT+1																																																																																	
-----Sample Output continues-----																																																																																			
-----End of output below-----																																																																																			
MST	MST7MDT	NZ																																																																																	
NZ-CHAT	PRC	PST8PDT																																																																																	
Poland	Portugal	ROC																																																																																	
ROK	Singapore	Turkey																																																																																	
W-SU	WET	africa																																																																																	
asia	australasia	backward																																																																																	
etcetera	europa	factory																																																																																	
northamerica	pacificnew	solar87																																																																																	
solar88	solar89	southamerica																																																																																	
GB-Eire	GMT	GMT+0																																																																																	

**Procedure 11: Configuring the Application**

		<pre> GMT+1          GMT+10          GMT+11 GMT+12         GMT+13          GMT+2 GMT+3          GMT+4           GMT+5 GMT+6          GMT+7           GMT+8 GMT+9          GMT-0           GMT-1 GMT-10         GMT-11          GMT-12 GMT-2          GMT-3           GMT-4 GMT-5          GMT-6           GMT-7 GMT-8          GMT-9           Greenwich Jamaica        Navajo           UCT UTC             universal      Zulu  Enter a time zone file (relative to /usr/share/lib/zoneinfo): US/Eastern </pre>
<p>14. <input type="checkbox"/></p>	<p><b>SERVER A: Enter choice 7, Configure NTP Server Menu.</b></p> <p><b>NOTE: If an NTP server does not need to be added at this time, you can skip all steps related to option 7 Configure NTP Server Menu, and proceed to the PDB Configuration Menu at step 20.</b></p>	<p><b>EPAP Configuration Menu for Non-prov EPAP:</b></p> <pre> /-----EPAP Configuration Menu-----\ /-----\    1    Display Configuration                -----     2    Configure Network Interfaces Menu    -----     3    Set Time Zone                        -----     4    Exchange Secure Shell Keys          -----     5    Change Password                      -----     6    Platform Menu                        -----     7    Configure NTP Server                  -----     8    PDB Configuration Menu              -----     9    Security                              -----    10    SNMP Configuration                    -----    11    Configure Alarm Feed                  -----    12    Configure SNMP Agent Community       -----    13    Mate Disaster Recovery                -----    14    DB Architecture Menu                 -----     e    Exit                                 \-----/  Enter Choice: 7 </pre>

## Procedure 11: Configuring the Application

<p>15. <input type="checkbox"/></p>	<p><b>MPS A:</b> The EPAP Configure NTP Server Menu is displayed. Enter choice 2, Add External NTP Server.</p> <p>Note: Enter choice "1" to configure IPv4 NTP server. Otherwise, enter choice "2" to configure IPv6 NTP server.</p>	<pre> /-----EPAP Configure NTP Server Menu-----\   1   Display External NTP Server     2   Add External NTP Server     3   Remove External NTP Server     e   Exit   \-----/  Enter Choice: 2  /-----Add External NTP Server Menu-----\   1   IPv4 Configuration     2   IPv6 Configuration     e   Exit   \-----/  Enter Choice: █ </pre>
<p>16. <input type="checkbox"/></p>	<p><b>MPS A:</b> You are prompted to confirm the action of adding a new NTP Server. (Pressing Return would accept the default of 'N' or 'no', and would cancel the action to add an external NTP server.) Type Y and press return.</p> <p><b>NOTE:</b> All NTP Server IP addresses shown are only examples.</p>	<pre> Are you sure you wish to add new NTP Server? [N]: Y Enter the EPAP NTP Server IP Address: &lt;NTP_server_IP_Addr&gt;  External NTP Server [&lt;NTP_server_IP_Addr&gt;] has been added.  Press return to continue...&lt;return&gt; </pre>
<p>17. <input type="checkbox"/></p>	<p><b>MPS A:</b> The EPAP Configure NTP Server Menu is displayed.</p>	<pre> /-----EPAP Configure NTP Server Menu-----\   1   Display External NTP Server     2   Add External NTP Server     3   Remove External NTP Server   \-----/ </pre>

## Procedure 11: Configuring the Application

	<p>Enter choice 1, Display External NTP Server.</p>	<pre> ----- e   Exit ----- Enter Choice: 1 </pre>
<p>18. <input type="checkbox"/></p>	<p><b>MPS A:</b> Verify the External NTP Server IP address is correct and press Return.</p> <p><b>NOTE:</b> All NTP Server IP addresses shown are only examples.</p>	<pre> ntpserver1      &lt;IpAddress&gt; Press return to continue...&lt;return&gt; </pre>
<p>19. <input type="checkbox"/></p>	<p><b>MPS A:</b> The EPAP Configure NTP Server Menu is displayed. Select choice e, Exit.</p>	<pre> /-----EPAP Configure NTP Server Menu-----\ 1   Display External NTP Server 2   Add External NTP Server 3   Remove External NTP Server e   Exit ----- Enter Choice: e </pre>
<p>20. <input type="checkbox"/></p>	<p><b>MPS A:</b> The EPAP Configuration Menu is displayed. Select choice 8, PDB Configuration Menu.</p> <p><b>Note:</b> Execute the step to do PDB Configuration Menu (except step 27) even if the EPAP is to be configured as Non-Provisionable.</p>	<p><b>PDB Configuration Menu for Non-prov EPAP:</b></p>

## Procedure 11: Configuring the Application

```

/-----EPAP Configuration Menu-----\
/-----\
| 1 | Display Configuration              |
|-----|
| 2 | Configure Network Interfaces Menu |
|-----|
| 3 | Set Time Zone                     |
|-----|
| 4 | Exchange Secure Shell Keys       |
|-----|
| 5 | Change Password                  |
|-----|
| 6 | Platform Menu                   |
|-----|
| 7 | Configure NTP Server             |
|-----|
| 8 | PDB Configuration Menu          |
|-----|
| 9 | Security                         |
|-----|
|10 | SNMP Configuration               |
|-----|
|11 | Configure Alarm Feed             |
|-----|
|12 | Configure SNMP Agent Community  |
|-----|
|13 | Mate Disaster Recovery           |
|-----|
|14 | DB Architecture Menu            |
|-----|
| e | Exit                             |
\-----/

Enter choice: 8

```

## Procedure 11: Configuring the Application

21.



**MPS A:** The Configure PDB Menu is displayed. Select choice 1.

### PDB Configuration Menu for Mixed EPAP:

```
/-----Configure PDB Menu-----\  
/-----\  
| 1 | Configure PDB Network |  
|-----|  
| 2 | RTDB Homing Menu |  
|-----|  
| 3 | Change MPS Provisionable State |  
|-----|  
| 4 | Create PDB |  
|-----|  
| 5 | Change Auto DB Recovery State |  
|-----|  
| 6 | Change PDBA Proxy State |  
|-----|  
| e | Exit |  
\-----\  
\-----
```

### PDB Configuration menu for Non-Provisionable EPAP:

```
/-----Configure PDB Menu-----\  
/-----\  
| 1 | Configure PDB Network |  
|-----|  
| 2 | RTDB Homing Menu |  
|-----|  
| 3 | Change Auto DB Recovery State |  
|-----|  
| e | Exit |  
\-----\  
\-----
```

Enter Choice: 1

### PDB Configuration Menu for Standalone PDB (for default DB Architecture: COMPACT):

```
/-----Configure PDB Menu-----\  
/-----\  
| 1 | Configure PDB Network |  
|-----|  
| 2 | Create PDB |  
|-----|  
| 3 | Change Auto DB Recovery State |  
|-----|  
| e | Exit |  
\-----\  
\-----
```

Enter Choice: 1

**Note:** Configure the PDB network in the same format as that of the provisioning network format.

## Procedure 11: Configuring the Application

<p>22. <input type="checkbox"/></p>	<p><b>MPS A:</b> The PDB Network Configuration Menu is displayed.</p> <p>Select choice 1.</p>	<p><b>PDB Network Configuration menu:</b></p> <pre> /-----PDB Network Configuration Menu-----\ /-----\    1    IPv4 Configuration                          ----- -----     2    IPv6 Configuration                          ----- -----     e    Exit                                       \-----\ </pre> <p>Enter Choice: 1</p>
<p>23. <input type="checkbox"/></p>	<p><b>Note: Do not provide the remote PDBA IP address in case user is performing migration.</b></p> <p><b>MPS A:</b> Provide the IP address of the MPS A on EAGLE A and the IP address for the MPS A on EAGLE B where the remote PDBA database is to reside. Enter the password for MPS A on EAGLE B. If configuration of the PDB network is successful, the output confirms the secure shell keys are successfully exchanged, as shown in the output for Provisionable(mixed-EPAP and PDBOnly) MPSs</p> <p>Note: If the default values shown are correct press return to accept them. Otherwise, enter the values and press Return.</p>	<p>Following is the output on Mixed EPAP.</p> <pre> Verifying connectivity with mate... This MPS is configured to be provisionable.  The EPAP local PDBA IPv4 address is currently set to &lt;IP&gt;. The EPAP local PDBA IPv6 address is currently not configured. The EPAP local PDBA IPv4 Address is &lt;IP&gt;. EPAP remote PDBA IP Address [0.0.0.0]: &lt;A IP Address&gt; EPAP remote PDBA B machine IP Address [0.0.0.0]: &lt;B IP Address&gt; <b>The server does not know of &lt;A IP Address&gt;</b> <b>Will just exchange host keys for the name given!</b> Password of epapdev: &lt;epapdev password&gt; </pre> <p>Following is the output on Non-Provisionable EPAP.</p> <pre> Verifying connectivity with mate... This MPS is configured to be non-provisionable.  You will be prompted for both of the remote PDBA addresses.  Order does not matter.  Enter one of the two PDBA IP addresses [0.0.0.0]: &lt;IP Address&gt; Enter the other of the two PDBA IP addresses [0.0.0.0]: &lt;IP Address&gt; </pre> <p>Following is the output on Standalone PDB.</p> <pre> This MPS is configured to be provisionable.  The EPAP local PDBA IPv4 address is currently set to &lt;IP&gt; The EPAP local PDBA IPv6 address is currently not set. The EPAP local PDBA IPv4 Address is &lt;IP&gt;. </pre>

## Procedure 11: Configuring the Application

	<p><b>In case of Non-Provisionable EPAP, provide the IP address of Active and Standby PDBA.</b></p>	<p>EPAP remote PDBA IP Address [0.0.0.0]:</p>
<p>24. <input type="checkbox"/></p>	<p><b>MPS A:</b> Press Return to return to the Configure PDB Menu. Enter choice 2, RTDB Homing Menu.</p>	<p>Skip this step if EPAP configured as Standalone PDB.</p> <pre> /-----Configure PDB Menu-----\ /-----\   1   Configure PDB Network         -----    2   RTDB Homing Menu             -----    3   Change MPS Provisionable State    -----    4   Create PDB                    -----    5   Change Auto DB Recovery State    -----    6   Change PDBA Proxy State        -----    e   Exit                         \-----/ </pre> <p>Enter Choice: 2</p>
<p>25. <input type="checkbox"/></p>	<p><b>MPS A:</b> The RTDB Homing Menu is displayed. Enter choice 3, Configure Standby RTDB Homing.</p>	<p>Skip this step for Standalone PDB.</p> <p><b>For Non-Prov Nodes:</b></p> <pre> /-----RTDB Homing Menu-----\ /-----\   1   Configure Specific RTDB Homing    -----    2   Configure Active RTDB Homing      -----    3   Configure Standby RTDB Homing     -----    e   Exit                             \-----/ </pre> <p>Enter Choice: 2</p> <p>In the event that the Active PDB is unavailable, should updates be allowed to the RTDBs from the Standby PDBA? [Y]: N</p> <p>Caution: If this option is selected, the Standby PDB will not provision the RTDBs at this site in the event that the Active PDB is not available.</p> <p>Are you sure you want to disallow updates to the RTDBs from the Standby PDB? [N]: Y</p> <p>The RTDBs will home to the Active and will not allow updates from the Standby PDB.</p> <p>Press return to continue...^<input type="checkbox"/></p>

## Procedure 11: Configuring the Application

		<p><b>For Mixed EPAP :</b></p> <p>MPS Side A: hostname: Floater05 hostid: 4b0a6e8d  Platform Version: 7.0.1-8.6.0.0.0_110.6.0  Software Version: EPAP 170.0.12-17.0.0.0.0_170.12.0  Wed Mar 29 05:59:19 EDT 2023</p> <pre> /-----RTDB Homing Menu-----\ /-----\   1   Configure Specific RTDB Homing    --- -----    2   Configure Active RTDB Homing     --- -----    3   Configure Standby RTDB Homing    --- -----    e   Exit                              \-----/ </pre> <p>Enter Choice: 1</p> <p>EPAP software and PDBA are running. Stop them? [N]: Y</p> <p>EPAP software is running on mate MPS. Stop it? [N]: Y  Since this is an unpaired EPAP, specific homing will be directed to the local PDB.</p> <p>The RTDB Homing policy is set to 'specific' and will prefer updates from 10.75.141.110</p> <p>Press return to continue...</p>
<p>26.  <input type="checkbox"/></p>	<p><b>MPS A:</b> The RTDB Homing Menu is displayed. Enter <b>e</b> to exit.</p>	<p>Skip this step for Standalone PDB.</p> <pre> /-----RTDB Homing Menu-----\   1   Configure Specific RTDB Homing    --- -----    2   Configure Active RTDB Homing     --- -----    3   Configure Standby RTDB Homing    --- -----    e   Exit                              \-----/ </pre> <p>Enter Choice: e</p>

## Procedure 11: Configuring the Application

27.



**MPS A:** Enter choice 3.  
Create PDB.

**Note:**

Stop the EPAP software by answering 'Y', if you get the message to stop it.

**Note:**

While creating PDB database using the Create PDB option of the EPAP Configuration Menu, ensure that the value for remote PDB IP is set to 0.0.0.0.

**Note: Perform this step only for the Provisionable EPAP (Mixed EPAP or Standalone PDB). Skip this step if the EPAP is configured as Non-Provisionable.**

The Menu for Mixed EPAP.

```
/-----Configure PDB Menu-----\  
/-----\  
| 1 | Configure PDB Network |  
|-----|  
| 2 | RTDB Homing Menu |  
|-----|  
| 3 | Create PDB |  
|-----|  
| 4 | Change Auto DB Recovery State |  
|-----|  
| 5 | Change PDBA Proxy State |  
|-----|  
| e | Exit |  
\-----/
```

Enter Choice:

Enter Choice: 3

**The Menu for Standalone PDB(for default DB Architecture: COMPACT):**

```
/-----Configure PDB Menu-----\  
/-----\  
| 1 | Configure PDB Network |  
|-----|  
| 2 | Create PDB |  
|-----|  
| 3 | Change Auto DB Recovery State |  
|-----|  
| e | Exit |  
\-----/
```

Enter Choice: 2

```
localIp = 10.75.141.47  
localName=Natal-47A  
remoteIp = 0.0.0.0  
There is no remote PDB  
  
remoteBip = 0.0.0.0  
There is no remote B PDB  
mysqld is alive  
Local PDB database does not exist.  
Creating the local database  
~~ /etc/init.d/Pdba stop ~~  
PDBA process is already stopped.  
Removing local pdba status file.  
Creating the remote database
```

**Procedure 11: Configuring the Application**

<p>28. <input type="checkbox"/></p>	<p>NOTE: The example output to the right has been truncated for brevity.</p>	<p><b>TRUNCATED OUTPUT</b></p> <pre>MyISAM file: /var/TKLC/epap/db/pdb/stats/pdbaStats.MYI is already checked Waiting for mysqlpdb to start done Removing local pdba status file. Removing remote pdba status file.</pre>
<p>29. <input type="checkbox"/></p>	<p><b>MPS A:</b> The Configure PDB Menu is displayed. Enter choice <b>e</b>, Exit. The Configure PDB Menu is displayed. Enter choice <b>e</b>, Exit.</p>	<p>The Configure PDB Menu for Mixed EPAP:</p> <pre>/-----Configure PDB Menu-----\   1   Configure PDB Network              2   RTDB Homing Menu                    3   Change MPS Provisionable State      4   Create PDB                          5   Change Auto DB Recovery State       6   Change PDBA Proxy State             e   Exit                              \-----\</pre> <p>Enter Choice: e</p> <p>The Configure PDB Menu for Standalone PDB:</p> <pre>/-----Configure PDB Menu-----\   1   Configure PDB Network              2   Create PDB                        3   Change Auto DB Recovery State      e   Exit                              \-----\</pre> <p>Enter Choice: e</p>
<p>30. <input type="checkbox"/></p>	<p><b>MPS A:</b> The EPAP Configuration Menu is displayed. Enter choice <b>1</b>, Display Configuration.</p>	

## Procedure 11: Configuring the Application

		<pre> /-----EPAP Configuration Menu-----\ /-----\   1   Display Configuration    -----    2   Configure Network Interfaces Menu    -----    3   Set Time Zone    -----    4   Exchange Secure Shell Keys    -----    5   Change Password    -----    6   Platform Menu    -----    7   Configure NTP Server    -----    8   PDB Configuration Menu    -----    9   Security    -----    10   SNMP Configuration    -----    11   Configure Alarm Feed    -----    12   Configure Query Server    -----    13   Configure Query Server Alarm Feed    -----    14   Configure SNMP Agent Community    -----    15   Mate Disaster Recovery    -----    e   Exit   \-----/ </pre> <p>Enter Choice: 1</p>
<p>31. <input type="checkbox"/></p>	<p><b>MPS A:</b> The configuration information is displayed. Verify that the configuration data displayed is correct.</p>	<p><b>For Mixed EPAP and Non-Provisionable EPAP configured in IPv4 configuration, the configuration data shall look like:</b></p> <pre> EPAP A Provisioning Network IP Address = 10.75.141.55 EPAP A Provisioning Network IP Address v6 = Not configured EPAP B Provisioning Network IP Address = 10.75.141.56 EPAP B Provisioning Network IP Address v6 = Not configured Provisioning Network Netmask = 255.255.255.128 Provisioning Network Prefix = Not configured Provisioning Network Default Router = 10.75.141.1 Provisioning Network Default Router v6 = Not configured EPAP A Backup Prov Network IP Address = Not configured EPAP A Backup Prov Network IP Address v6 = Not configured EPAP B Backup Prov Network IP Address = Not configured EPAP B Backup Prov Network IP Address v6 = Not configured Backup Prov Network Netmask = Not configured </pre>

## Procedure 11: Configuring the Application

	Backup Prov Network Prefix v6	= Not configured
	Backup Prov Network Default Router	= Not configured
	Backup Prov Network Default Router v6	= Not configured
	EPAP A Sync Network Address	= 192.168.2.100
	EPAP B Sync Network Address	= 192.168.2.200
	EPAP A Main DSM Network Address	= 192.168.120.100
	EPAP B Main DSM Network Address	= 192.168.120.200
	EPAP A Backup DSM Network Address	= 192.168.121.100
	EPAP B Backup DSM Network Address	= 192.168.121.200
	EPAP IP Version	= IPv4
	EPAP A HTTP Port	= 80
	EPAP B HTTP Port	= 80
	EPAP A HTTP SuExec Port	= 8001
	EPAP B HTTP SuExec Port	= 8001
	EPAP A Banner Connection Port	= 8473
	EPAP B Banner Connection Port	= 8473
	EPAP A Static NAT Address	= Not configured
	EPAP B Static NAT Address	= Not configured
	PDBI Port	= 5873
	Remote MPS A Static NAT Address	= Not configured
	Remote MPS A HTTP Port	= 80
	Local Provisioning VIP	= Not configured
	Remote Provisioning VIP	= Not configured
	Local PDBA Address	= 10.75.141.55
	Local PDBA Address v6	=
	0000:0000:0000:0000:0000:0000:0000:0000	=
	Remote PDBA Address	= 0.0.0.0
	Remote PDBA B Address	= 0.0.0.0
	Time Zone	= America/New_York
	PDB Database	= Exists
	Preferred PDB	= 10.75.141.55
	Allow updates from alternate PDB	= Yes
	Auto DB Recovery Enabled	= No
	PDBA Proxy Enabled	= No
	Press return to continue...<return>	
	<b>For Standalone PDB, the configuration data shall look like:</b>	
	EPAP A Provisioning Network IP Address	= 10.250.51.130
	EPAP B Provisioning Network IP Address	= Not configured
	Provisioning Network Netmask	= 255.255.255.128
	Provisioning Network Prefix	= Not configured
	Provisioning Network Default Router	= 10.250.51.1
	Provisioning Network Default Router v6	= Not configured
	EPAP A Backup Prov Network IP Address	= Not configured
	EPAP A Backup Prov Network IP Address v6	= Not configured
	Backup Prov Network Netmask	= Not configured
	Backup Prov Network Prefix v6	= Not configured
	Backup Prov Network Default Router	= Not configured
	Backup Prov Network Default Router v6	= Not configured
	Network Configuration Type	= SINGLE
	EPAP IP Version	= IPv4
	EPAP A HTTP Port	= 80
	EPAP A HTTP SuExec Port	= 8001
	EPAP A Banner Connection Port	= 8473
	EPAP A Static NAT Address	= Not configured
	PDBI Port	= 5873
	Remote MPS A Static NAT Address	= Not configured
	Remote MPS A HTTP Port	= Not configured
	Local PDBA Address	= 10.250.51.130
	Local PDBA Address v6	= Not configured
	Remote PDBA Address	= 0.0.0.0
	Time Zone	= US/Eastern
	PDB Database	= Exists
	Auto DB Recovery Enabled	= No

## Procedure 11: Configuring the Application

		<p>Press return to continue... &lt;return&gt;</p>
<p>32. <input type="checkbox"/></p>	<p><b>MPS A:</b> The EPAP Configuration Menu is displayed. Enter choice <b>e</b>, Exit.</p>	<pre> <b>EPAP Configuration Menu for Non-Provisional EPAP:</b> /-----EPAP Configuration Menu-----\ /-----\   1   Display Configuration                   -----    2   Configure Network Interfaces Menu       -----    3   Set Time Zone                           -----    4   Exchange Secure Shell Keys             -----    5   Change Password                         -----    6   Platform Menu                          -----    7   Configure NTP Server                    -----    8   PDB Configuration Menu                 -----    9   Security                               -----   10   SNMP Configuration                      -----   11   Configure Alarm Feed                     -----   12   Configure SNMP Agent Community          -----   13   Mate Disaster Recovery                  -----   14   DB Architecture Menu                    -----    e   Exit                                  \-----/ </pre> <p>Enter Choice: <b>e</b></p> <p>For Non-Provisionable EPAP, the following is displayed.</p> <pre> INFO: Increasing rt volume size for Non-provisionable EPAP. Please wait... INFO: db space increased on 'A'. INFO: Stopping Epap, mysqlapp and mysqlpdb services... Done. INFO: Starting Epap, mysqlapp and mysqlpdb services... Done. </pre>

### Procedure 11: Configuring the Application

		INFO: Successfully configured Non-provisionable EPAP.
33.	<p>Run the following commands on Non-Prov Nodes only:</p>	<pre>[root@Manaus-a ~]# sed -i 's/mysqld, 2, 5000000000000002, -, -, -, -, 2, 5000000000000002, -/mysqld, 5000000000000002, -, -, -, -, 1, 5000000000000002, -/g' /usr/TKLC/epap/lib/syscheck_config_non_prov</pre> <pre>[root@Manaus-a ~]#</pre> <pre>sed -i "s/mysqld, \{18\}2, 5000000000000002, -, -, -, -, 2, 5000000000000002, -/mysqld,\${printf '%*s' 18}1, 5000000000000002, -, -, -, -, 1, 5000000000000002, -/" /usr/TKLC/epap/lib/syscheck_config_non_prov</pre>
34.	<p>Move the pdba binary file on Mixed and PDBonly server</p> <p><b>Note:</b> This step is valid only when the user is performing migration.</p>	<pre>[epapdev@Quito-a~]# cd /usr/TKLC/epap/bin</pre> <pre>[epapdev@Quito-a bin]# mv pdba pdba_stopped</pre> <pre>[epapdev@Quito-a bin]#</pre>
35.	<p><input type="checkbox"/> <b>MPS A:</b> The EPAP Configuration Menu is displayed. Select choice 6, Platform Menu.</p>	<p><b>EPAP Configuration Menu for mixed EPAP:</b></p>

**Procedure 11: Configuring the Application**

		<pre> /-----EPAP Configuration Menu-----\ /-----\   1   Display Configuration  -----    2   Configure Network Interfaces Menu  -----    3   Set Time Zone  -----    4   Exchange Secure Shell Keys  -----    5   Change Password  -----    6   Platform Menu  -----    7   Configure NTP Server  -----    8   PDB Configuration Menu  -----    9   Security  -----   10   SNMP Configuration  -----   11   Configure Alarm Feed  -----   12   Configure Query Server  -----   13   Configure Query Server Alarm Feed  -----   14   Configure SNMP Agent Community  -----   15   Mate Disaster Recovery  -----    e   Exit \-----/ </pre> <p>Enter Choice: 6</p>
<p>36. <input type="checkbox"/></p>	<p><b>MPS A:</b> The Platform Menu is displayed. Enter Choice 2, Reboot MPS.</p>	<p>Menu for Mixed EPAP and Non-Provisionable EPAP:</p> <pre> /-----EPAP Platform Menu-----\ /-----\   1   Initiate Upgrade  -----    2   Reboot MPS  -----    3   MySQL Backup  -----    4   RTDB Backup  -----    5   PDB Backup  -----    e   Exit \-----/ </pre> <p>Enter Choice: 2</p>

## Procedure 11: Configuring the Application

		<p>CAUTION: Rebooting this MPS will stop all EPAP processes will prevent updating of the RTDB until the EPAP software is automatically re-started when the system comes back up. Are you sure you want to reboot the MPS? [N]:</p> <p>Menu for Standalone PDB:</p> <pre> /-----EPAP Platform Menu-\   -----     1   Initiate Upgrade     -----     2   Reboot MPS     -----     3   MySQL Backup     -----     4   PDB Backup     -----     e   Exit     -----   \  Enter Choice: 2 </pre> <p>CAUTION: Rebooting this MPS will stop all EPAP processes will prevent updating of the RTDB until the EPAP software is automatically re-started when the system comes back up.</p>
<p>37. <input type="checkbox"/></p>	<p><b>MPS A:</b> For Mixed EPAP and Non-Provisionable EPAP you are prompted whether MPS A, MPS B or BOTH sides are to be rebooted. Select the default value of <b>BOTH</b> by pressing Return.</p> <p><b>Note: In case of the Standalone PDB, no prompt is given and the server goes down for a reboot.</b></p>	<p>For Mixed EPAP and Non-Provisionable EPAP, a prompt is displayed:</p> <pre>Reboot MPS A, MPS B or [BOTH]: &lt;return&gt;</pre> <p>For Standalone PDB, the following is displayed.</p> <pre>Reboot local MPS... Broadcast message from root (pts/1) (Thu May 29 16:13:51 2014): The system is going down for reboot NOW!</pre>
<p>38.</p>	<p><b>Move the pdba_stopped binary file on Mixed and PDBonly server</b></p> <p><b>Note: This step is valid only when user is performing migration</b></p>	<pre>[epapdev@Quito-a bin]# mv pdba_stopped pdba [epapdev@Quito-a bin]#</pre>
<p>39. <input type="checkbox"/></p>	<p><b>MPS A:</b> The console logon appears at the system prompt signifying the</p>	<pre>&lt;hostname&gt; login: admusr Password:</pre> <p>Note: The console logon will be preceded by many lines of reboot output.</p>

## Procedure 11: Configuring the Application

	EPAP initial configuration is completed.	
40.	Perform the procedure to exchange keys between OL 8 based PDBonly and OL6 based Non-Prov.	Perform the steps to exchange keys between OL 8 based PDBonly and OL6 based Non-Prov listed in <a href="#">Appendix A.53</a> .
41.	Verify the MIN_DSM_MEM_SIZE and PDB_SUB_CAPACITY	<p>Run the below commands to verify the MIN_DSM_MEM_SIZE and PDB_SUB_CAPACITY:</p> <pre>uiEdit   grep PDB_SUB_CAPACITY uiEdit   grep DSM_MIN_MEM_SIZE uiEdit   grep DB_ARCHITECTURE</pre> <p>In case of Extreme DB, EPAP 17.1 supports 510M DNs. Hence, make sure to change the PDB_SUB_CAPACITY by performing the steps mentioned in Section 6.6 in EPAP Administration Guide.</p>
42.	<input type="checkbox"/> <b>Connected PDBonly:</b> Configure DSM Min Mem Size	Perform 0 only if the Non-Prov EPAP is installed and is connected to Standalone PDB server. Otherwise, skip this step if – <ul style="list-style-type: none"> <li>a. This is Mixed EPAP</li> <li>b. This is non-prov EPAP and connected to mixed EPAP.</li> </ul>
43.	<input type="checkbox"/> Reconnect console cables.	On E5-APP-B card, reconnect the console cable between the serial port labeled 'S0' on E5-APP-B B card's adapter and the serial port labeled 'S1' on the E5-APP-B A card's adapter and the console cable between the serial port labeled 'S0' on E5-APP-B A card's adapter and the serial port labeled 'S1' on the E5-APP-B B card's adapter. <b>Cable part numbers - 830-1220-xx</b>
44.	<input type="checkbox"/> Procedure complete.	Procedure is complete.
45.	<input type="checkbox"/> Note down the timestamp in log.	Run the following command: <b>\$ date</b>

## Procedure 12 Provision data from GUI

### Procedure 12: Provision data from GUI (Active Provisionable(mixed-EPAP or PDBonly) Site as designated by customer)

S T E P #	<p>This procedure provision 1 NE and 1 DN from GUI on Active Site.</p> <p>Check off (✓) each step as it is completed. Boxes have been provided for this purpose under each step number.</p> <p>IF THIS PROCEDURE FAILS, CONTACT MY ORACLE SUPPORT AND ASK FOR ASSISTANCE.</p>
-----------------------	---

**Procedure 12: Provision data from GUI (Active Provisionable(mixed-EPAP or PDBonly) Site as designated by customer)**

1.

Access the EPAP GUI by opening a web browser (Preferably IE) via HTTPS and providing the IP address of Server A.

The EPAP LOGIN screen should appear.

The GUI screen on Mixed EPAP should look like:

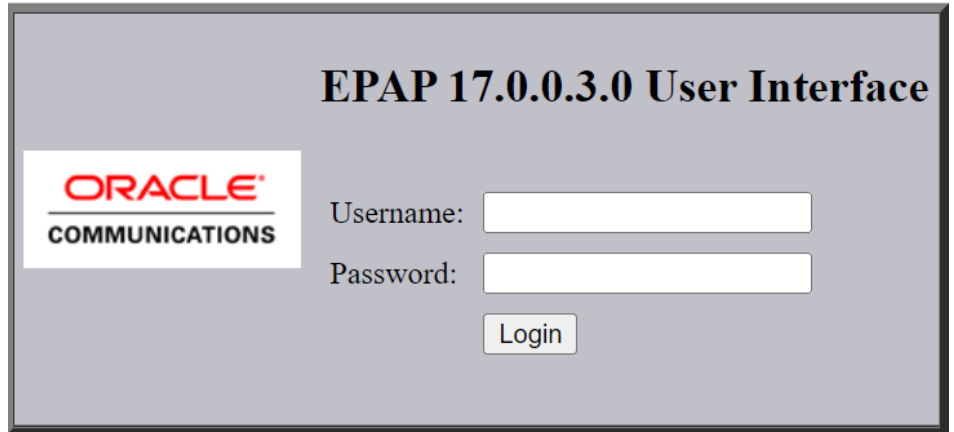

The GUI screen on Standalone PDB should look like:

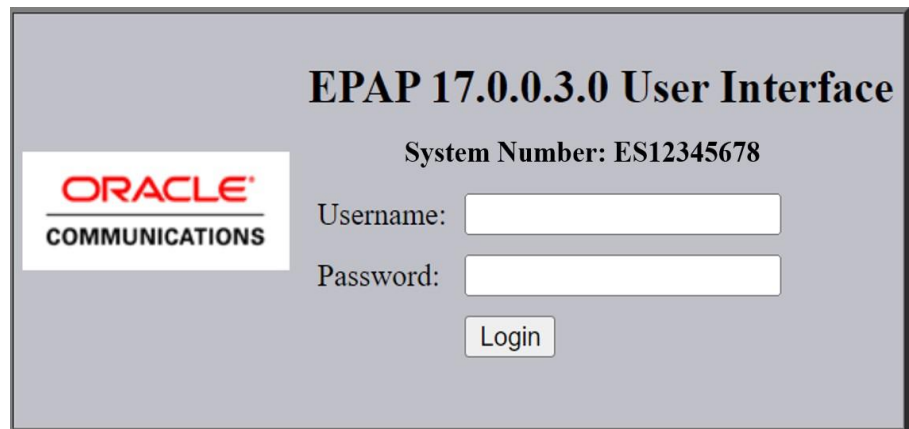

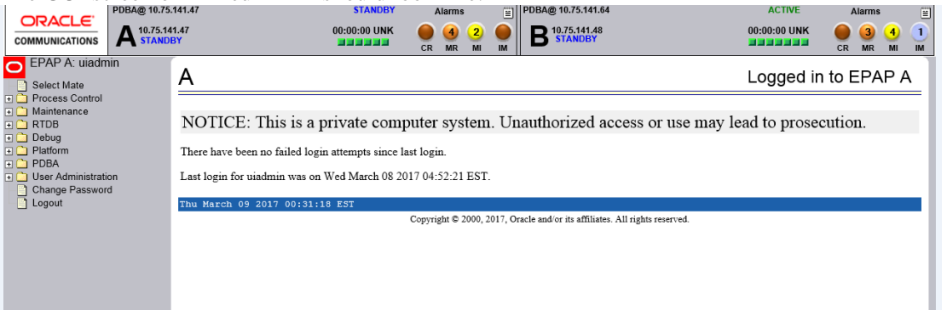
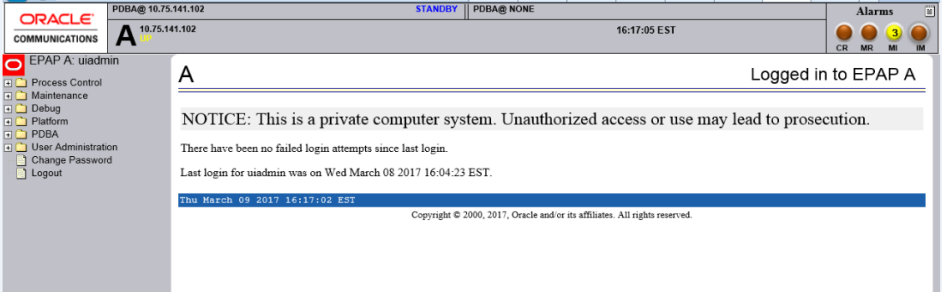
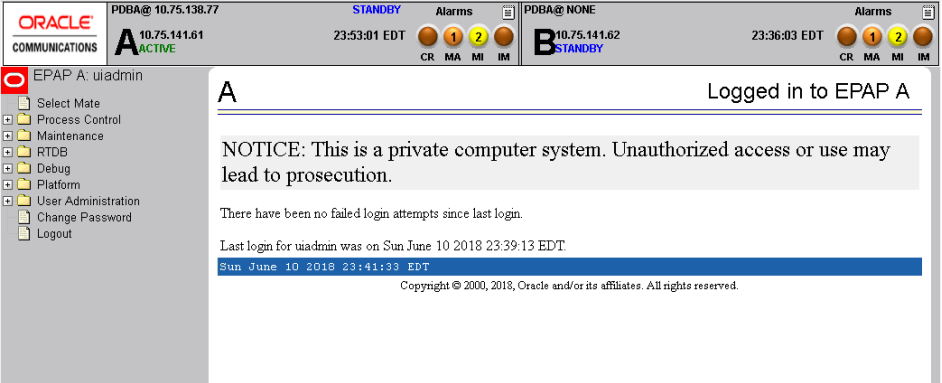

**Procedure 12: Provision data from GUI (Active Provisionable(mixed-EPAP or PDBonly) Site as designated by customer)**

<p>2. <input type="checkbox"/></p>	<p>Log in as uiadmin.</p>	<p>The GUI screen on Mixed EPAP should look like:</p>  <p>The GUI screen on Standalone PDB should look like:</p>  <p>The GUI screen on Non-Prov EPAP should look like:</p> 
<p>3. <input type="checkbox"/></p>	<p>On the Site designated by the customer Active PDB GUI select "Switchover PDBA State" to make the PDBA Active.</p>	<p>The screen should look like:</p>

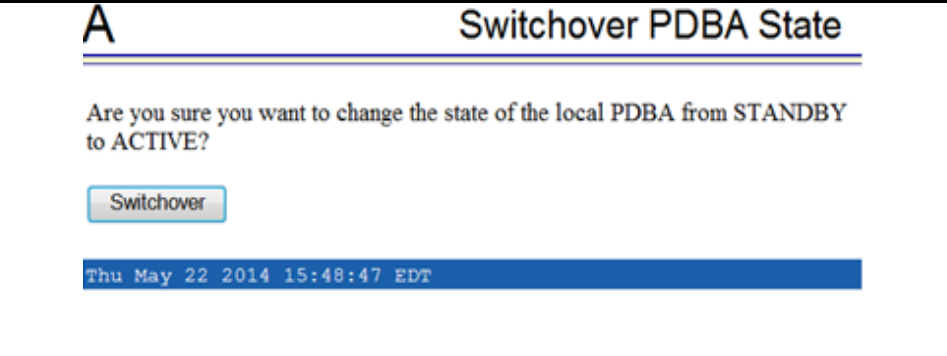
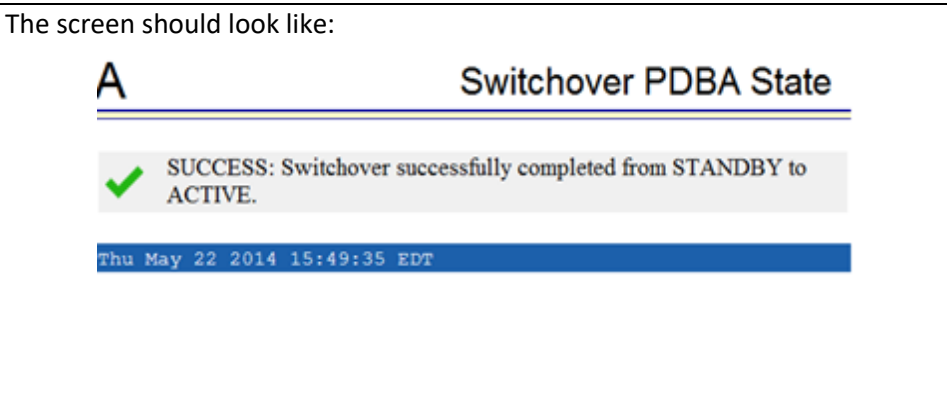
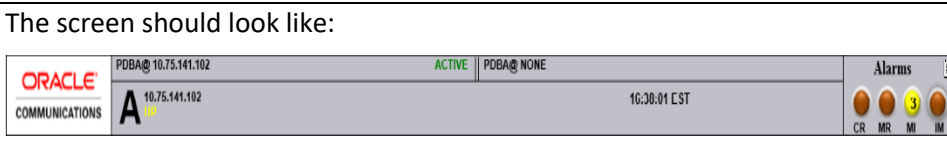
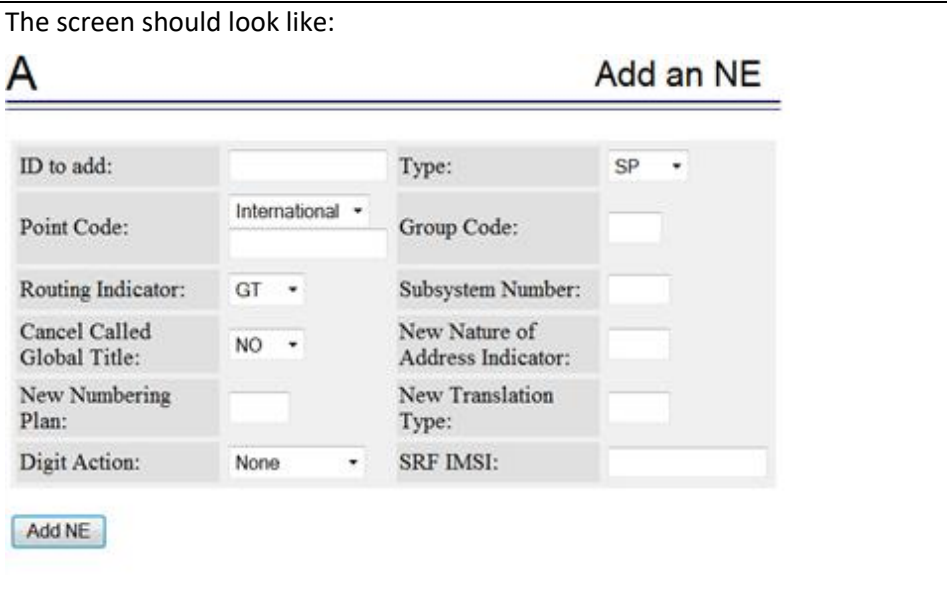
**Procedure 12: Provision data from GUI (Active Provisionable(mixed-EPAP or PDBonly) Site as designated by customer)**

	<ul style="list-style-type: none"> <li>Platform</li> <li>PDBA             <ul style="list-style-type: none"> <li>Select Other PDBA</li> <li>Switchover PDBA State</li> <li>Process Control</li> <li>View PDBA Status</li> <li>Manage Data</li> <li>Authorized IP List</li> <li>DSM Info</li> <li>Maintenance</li> <li>List PDBI Connections</li> <li>PDBI Statistics Report</li> </ul> </li> </ul>	
<p>4. <input type="checkbox"/></p>	<p>Click on the "Switchover" button.</p>	<p>The screen should look like:</p> 
<p>5. <input type="checkbox"/></p>	<p>PDBA should become ACTIVE.</p>	<p>The screen should look like:</p> 
<p>6. <input type="checkbox"/></p>	<p>On the ACTIVE PDBA site, select PDBA→Manage Data→Network Entity→Add</p> <ul style="list-style-type: none"> <li>Platform</li> <li>PDBA             <ul style="list-style-type: none"> <li>Select Other PDBA</li> <li>Switchover PDBA State</li> <li>Process Control</li> <li>View PDBA Status</li> <li>Manage Data                 <ul style="list-style-type: none"> <li>IMSI</li> <li>IMSI Range</li> <li>DN</li> <li>DN Block</li> <li>Network Entity                     <ul style="list-style-type: none"> <li>Add</li> <li>Update</li> <li>Delete</li> <li>Retrieve</li> </ul> </li> <li>IMEI</li> <li>IMEI Block</li> <li>Send PDBI Command</li> <li>PROV BL</li> </ul> </li> </ul> </li> </ul>	<p>The screen should look like:</p> 

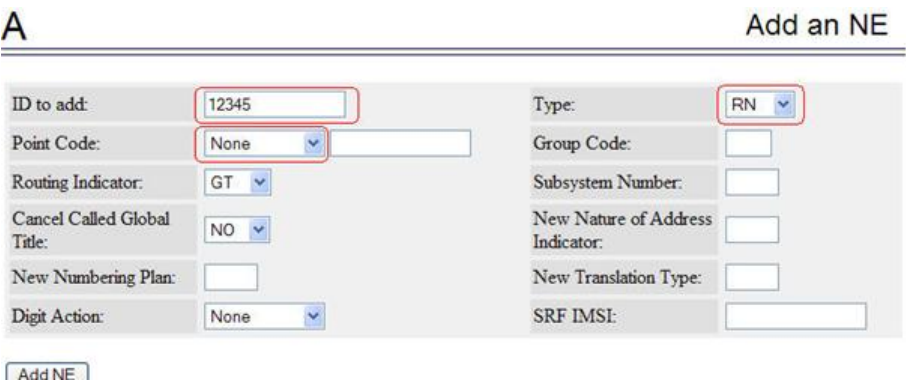
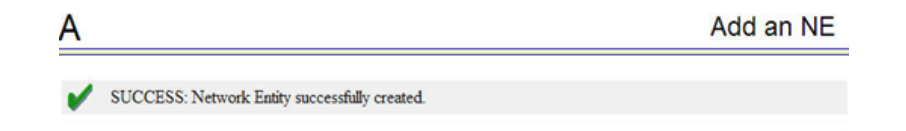
**Procedure 12: Provision data from GUI (Active Provisionable(mixed-EPAP or PDBonly) Site as designated by customer)**

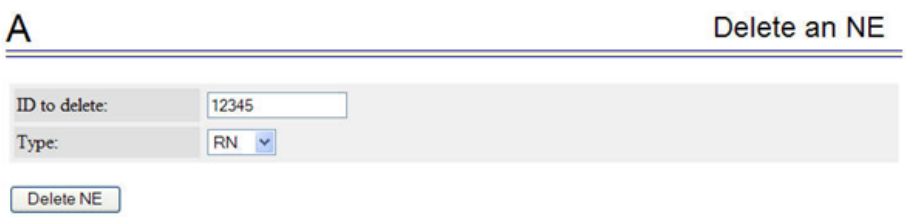
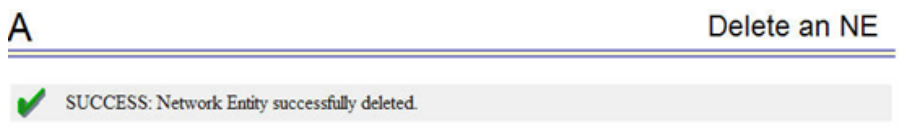
<p>7. <input type="checkbox"/></p>	<p>Enter ID as "12345", select Type "RN" and select Point Code as "None".</p>	<p>The screen should look like:</p> 
<p>8. <input type="checkbox"/></p>	<p>Click on the "Add NE" button. Network Entity should be successfully added.</p>	<p>The screen should look like:</p> 
<p>9. <input type="checkbox"/></p>	<p>Select PDBA→Manage Data→Network Entity→Delete</p>	<p>The screen should look like:</p> 
<p>10. <input type="checkbox"/></p>	<p>Enter ID as "12345" and select Type "RN".</p>	<p>The screen should look like:</p> 
<p>11. <input type="checkbox"/></p>	<p>Click on the "Delete NE" button. Network Entity should be successfully deleted.</p>	<p>The screen should look like:</p> 
<p>12. <input type="checkbox"/></p>	<p>View PDBA Status</p>	<p>The screen should look like:</p>

**Procedure 12: Provision data from GUI (Active Provisionable(mixed-EPAP or PDBonly) Site as designated by customer)**

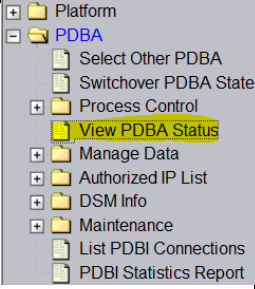
		<div style="border: 1px solid black; padding: 5px;"> <p style="text-align: right;">View PDBA Status</p> <hr/> <p style="text-align: center;"><b>PDBA@10.253.103.18 Status</b></p> <table border="0"> <tr> <td>Status:</td> <td>ACTIVE</td> <td>Version:</td> <td>1.0</td> </tr> <tr> <td>Level:</td> <td>2</td> <td>Birthday:</td> <td>07/23/2009 15:56:51 GMT</td> </tr> <tr> <td>DN Prefix:</td> <td></td> <td>IMSI Prefix:</td> <td></td> </tr> <tr> <td>Counts:</td> <td colspan="3">IMSI=0, DN=0, DN Blocks=0, NEs=0, IMEI=0, IMEI Blocks=0, ASD=0, DN_DNs=0, DNB_DNs=0</td> </tr> </table> <table border="1" style="width: 100%; border-collapse: collapse;"> <thead> <tr> <th>RTDB</th> <th>Address</th> <th>Level</th> </tr> </thead> <tbody> <tr> <td>Client:</td> <td>10.253.103.18</td> <td>2</td> </tr> <tr> <td>Client:</td> <td>192.168.2.200 (mate)</td> <td>2</td> </tr> </tbody> </table> <hr/> <p style="text-align: center;"><b>PDB@10.253.103.18 Status</b></p> <table border="0"> <tr> <td>Status:</td> <td>Database daemon is running</td> </tr> <tr> <td>Counts:</td> <td>IMSI=0, DN=0, DNBlocks=0, NEs=0, IMEI=0, IMEIBlocks=0, ASD=0, DN_DNs=0, DNB_DNs=0</td> </tr> </table> </div>	Status:	ACTIVE	Version:	1.0	Level:	2	Birthday:	07/23/2009 15:56:51 GMT	DN Prefix:		IMSI Prefix:		Counts:	IMSI=0, DN=0, DN Blocks=0, NEs=0, IMEI=0, IMEI Blocks=0, ASD=0, DN_DNs=0, DNB_DNs=0			RTDB	Address	Level	Client:	10.253.103.18	2	Client:	192.168.2.200 (mate)	2	Status:	Database daemon is running	Counts:	IMSI=0, DN=0, DNBlocks=0, NEs=0, IMEI=0, IMEIBlocks=0, ASD=0, DN_DNs=0, DNB_DNs=0
Status:	ACTIVE	Version:	1.0																												
Level:	2	Birthday:	07/23/2009 15:56:51 GMT																												
DN Prefix:		IMSI Prefix:																													
Counts:	IMSI=0, DN=0, DN Blocks=0, NEs=0, IMEI=0, IMEI Blocks=0, ASD=0, DN_DNs=0, DNB_DNs=0																														
RTDB	Address	Level																													
Client:	10.253.103.18	2																													
Client:	192.168.2.200 (mate)	2																													
Status:	Database daemon is running																														
Counts:	IMSI=0, DN=0, DNBlocks=0, NEs=0, IMEI=0, IMEIBlocks=0, ASD=0, DN_DNs=0, DNB_DNs=0																														
13.	<input type="checkbox"/> Procedure complete	Procedure is complete.																													
14.	<input type="checkbox"/> Note down the timestamp in log.	Run the following command: <b>\$ date</b>																													

**Procedure 13 Change DB Architecture**

**Procedure 13: Change the DB Architecture**

**NOTE: Skip this procedure in following three cases:**

1. EPAP 17.1 is a Mixed EPAP.
2. Extreme architecture is not required.

<b>S T E P #</b>	<p>This procedure change the DB Architecture from COMPACT to eXtreme.</p> <p>Check off (✓) each step as it is completed. Boxes have been provided for this purpose under each step number.</p> <p>IF THIS PROCEDURE FAILS, CONTACT MY ORACLE SUPPORT AND ASK FOR ASSISTANCE.</p>	
1.	<b>MPS A:</b> Log in as epapdev user.	<pre>[hostname] console login: epapdev password: password</pre>
2.	<b>MPS A:</b> Verify that DSM_MIN_MEM_SIZE is set correctly.	<p>Verify that DSM_MIN_MEM_SIZE is set correctly for the server to be converted into extreme architecture.</p> <p>To convert DB architecture of EPAP installed with release 17.1 from compact to extreme, the value of DSM_MIN_MEM_SIZE should be set to either 12370 or 24740.</p> <pre>[root@Cusco-a logs]# uiEdit   grep -i DSM_MIN_MEM_SIZE "DSM_MIN_MEM_SIZE" is set to "24740"</pre>

		<p>In a PDBonly setup, this value is obtained from the Non-Prov, and the Non-Prov obtains it from Eagle. Therefore, Eagle and the Non-Prov must be converted to the Extreme architecture first to ensure the value is set correctly. If the PDBonly is not connected to the Non-Prov, or if the Non-Prov is not connected to Eagle, the value will not be set correctly for the Extreme architecture.</p> <p>If you don't get any output from the above command, or the value in the output is set to something other than 12370/24740, set the needed value explicitly using the below command.</p> <pre>[epapdev@Cres-a ~]\$ uiEdit "DSM_MIN_MEM_SIZE" 24740 "DSM_MIN_MEM_SIZE" is set to "24740"</pre> <p><b>Note:</b> If EPAP 17.1 is connected to an eagle that doesn't support 510M feature, the DSM_MIN_MEM_SIZE value fetched from eagle would be 12046 or 24092.</p>
3.	<p><b>MPS A:</b> Log in to epapconfig.</p>	<pre>\$ sudo su - epapconfig</pre> <p>Warning: Smartmatch is experimental at /usr/TKLC/plat/lib/Security/User.pm line 904.</p>
4.	<p><b>MPS A:</b> The EPAP Configuration Menu is displayed. Select choice 14 or 15, DB Architecture Menu</p> <p><b>Note: Select choice 14 on Non-provisionable EPAP and 15 on PDBonly.</b></p>	<p><b>Note: Start Pdba software before executing this operation.</b></p> <p><b>EPAP Configuration Menu for Non-Provisionable:</b></p>

```

/-----EPAP Configuration Menu-----\
/-----\
| 1 | Display Configuration |
|-----|
| 2 | Configure Network Interfaces Menu |
|-----|
| 3 | Set Time Zone |
|-----|
| 4 | Exchange Secure Shell Keys |
|-----|
| 5 | Change Password |
|-----|
| 6 | Platform Menu |
|-----|
| 7 | Configure NTP Server |
|-----|
| 8 | PDB Configuration Menu |
|-----|
| 9 | Security |
|-----|
| 10 | SNMP Configuration |
|-----|
| 11 | Configure Alarm Feed |
|-----|
| 12 | Configure SNMP Agent Community |
|-----|
| 13 | Mate Disaster Recovery |
|-----|
| 14 | DB Architecture Menu |
|-----|
| e | Exit |
\-----/

Enter choice: 14

EPAP Configuration Menu for standalone PDB:

```

		<pre> /-----EPAP Configuration Menu-----\ /-----\   1   Display Configuration    -----    2   Configure Network Interfaces Menu    -----    3   Set Time Zone    -----    4   Exchange Secure Shell Keys    -----    5   Change Password    -----    6   Platform Menu    -----    7   Configure NTP Server    -----    8   PDB Configuration Menu    -----    9   Security    -----    10   SNMP Configuration    -----    11   Configure Alarm Feed    -----    12   Configure Query Server    -----    13   Configure Query Server Alarm Feed    -----    14   Configure SNMP Agent Community    -----    15   DB Architecture Menu    -----    e   Exit   \-----/ Enter choice: 15 </pre>
5.	<p><b>MPS A:</b> The DB Architecture Menu is displayed. Select choice 1, Display current DB Architecture</p> <p>Note: Default DB Architecture is displayed.</p>	<pre> /-----DB Architecture Menu-----\ /-----\   1   Display Current DB Architecture    -----    2   Change DB Architecture to eXtreme    -----    e   Exit   \-----/ Enter Choice: 1 </pre>

		DB Architecture: COMPACT
6.	<p><b>MPS A:</b> The DB Architecture Menu is displayed. Select choice 2, Change DB Architecture to eXtreme</p> <p><b>NOTE:</b> It may be asked to stop the EPAP software if it is running. Stop it by answering 'Y'.</p>	<p>Skip this step if DB Architecture already set to eXtreme.</p> <pre> /-----DB Architecture Menu-----\ /-----\    1    Display Current DB Architecture    -----     2    Change DB Architecture to eXtreme    -----     e    Exit                                 \-----/ </pre> <p>Enter Choice: 2</p> <p><b>Example output Non-Provisionable EPAP:</b></p> <pre> Caution: If this option is selected, the DB Architecture shall be changed           from Compact to eXtreme and this architecture cannot be reverted. WARNING: In order to complete this change in DB Architecture, you must perform RTDB conversion.  Are you sure you want to change the DB Architecture from Compact to eXtreme? [N]: y EPAP software is running. Stop it? [N]: y EPAP software is running on mate MPS. Stop it? [N]: y  INFO: DB ARCHITECTURE changed to eXtreme. </pre> <p><b>Example output Standalone PDB:</b></p>

		<p>Caution: If this option is selected, the DB Architecture shall be changed from Compact to eXtreme and this architecture cannot be reverted. Please verify that all connected Non-Provisional Sites are running on eXtreme Architecture.</p> <p>It will take 30 minutes or more to populate the PDB 9Dig tables.</p> <p>Are you sure you want to change the DB Architecture from Compact to eXtreme? [N]: Y  EPAP software is running. Stop it? [N]: Y  PDBA software is running. Stop it? [N]: Y</p> <p>INFO: Populating the DN 9 Digit tables...</p> <p>INFO: Populating the IMSI 9 Digit tables...</p> <p>INFO: Populating the IMEI 9 Digit tables...</p> <p>INFO: DB ARCHITECTURE changed to eXtreme.</p> <p>Press return to continue...</p>
7.	<p><b>MPS A:</b> The DB Architecture Menu is displayed. Select choice e, Exit</p>	<pre> /-----DB Architecture Menu-----\ /-----\    1    Display Current DB Architecture    ----- -----     2    Change DB Architecture to eXtreme    ----- -----     e    Exit                                 \-----/ </pre> <p>Enter Choice: e</p>
8.	<p><b>MPS A:</b> EPAP Configuration Menu is displayed. Select choice e, Exit</p>	

		<pre> /-----EPAP Configuration Menu-----\ /-----\   1   Display Configuration    -----    2   Configure Network Interfaces Menu    -----    3   Set Time Zone    -----    4   Exchange Secure Shell Keys    -----    5   Change Password    -----    6   Platform Menu    -----    7   Configure NTP Server    -----    8   PDB Configuration Menu    -----    9   Security    -----    10   SNMP Configuration    -----    11   Configure Alarm Feed    -----    12   Configure Query Server    -----    13   Configure Query Server Alarm Feed    -----    14   Configure SNMP Agent Community    -----    15   DB Architecture Menu    -----    e   Exit   \-----/  Enter Choice: e </pre>
9.	<p><b>MPS A:</b> Start Epap and Pdba software.</p> <p><b>Note: Move to step 11 if it is configured as PDBonly. Otherwise continue to next step.</b></p>	<p>Start Epap and Pdba software to reflect the changes. Use the following command to start Epap:</p> <pre> \$ systemctl start Pdba  ~~ /etc/init.d/Epap start ~~ "EPAP_RELEASE" is set to "0.617" EPAP application start Successful.  \$ systemctl start Pdba  ~~ /etc/init.d/Pdba start ~~ PDBA application start Successful. </pre>
10.	<p><b>MPS B:</b> Log on Server B.</p>	<pre> [hostname] consolelogin: epapdev password: <i>password</i> </pre>

11.	<b>MPS B:</b> Start Epap software.	<p>Start Epap software to reflect the changes. Use the following command to start Epap:</p> <pre><b>\$ systemctl start Epap</b></pre> <pre>~~ /etc/init.d/Epap start ~~ "EPAP_RELEASE" is set to "0.617" EPAP application start Successful.</pre>
12.	Procedure complete.	Procedure is complete.
13.	Note down the timestamp in log.	<p>Run the following command:</p> <pre><b>\$ date</b></pre>

## 7 SOFTWARE UPGRADE PROCEDURES

### Procedure 14 Assess MPS server's readiness for upgrade

#### Procedure 14: Assess the MPS Server's Readiness for Upgrade

<b>S T E P #</b>	<p>This procedure executes the steps required to assess the readiness of a system to be upgraded.</p> <p>Check off (✓) each step as it is completed. Boxes have been provided for this purpose under each step number.</p> <p>IF THIS PROCEDURE FAILS, CONTACT MY ORACLE SUPPORT AND <b>ASK FOR <u>UPGRADE ASSISTANCE</u></b>.</p>	
1. <input type="checkbox"/>	<p><b>MPS B:</b> Log in as the user "admusr".</p>	<p>If not already logged in, then log in.</p> <pre>&lt;hostname&gt; console login: admusr password: &lt;password&gt;</pre>
2. <input type="checkbox"/>	<p><b>MPS B:</b> Display the /etc/hosts configuration for the pdb entities.</p>	<p>If upgrading the first MPS B of a Provisionable mated pair, Run the following command to display the configuration of pdb entries:</p> <pre>\$ grep pdb /etc/hosts</pre> <p>Otherwise, skip to step 4.</p>
3. <input type="checkbox"/>	<p><b>MPS B:</b> Verify the correct configuration for pdb entities in the /etc/hosts file.</p>	<p>Below is an example of the output of the grep command:</p> <pre>192.168.55.176          host1-a  pdba 192.168.61.76          host2-a  prova-ip  pddb</pre> <p>If the command output contains 2 entries (pdba and pddb are both configured), continue to the next step .</p> <p>If the command output does not contain unique entries for pdba and pddb, contact My Oracle Support following the instructions on the front page or the instructions in the <b>My Oracle Support</b> section.</p>
4. <input type="checkbox"/>	<p><b>MPS B:</b> Display the contents of the /var/TKLC/upgrade directory.</p>	<p>Run the following command to display the presence of EPAP software ISO images:</p> <pre>\$ ls -la /var/TKLC/upgrade</pre> <p><b>Note:</b> The file permissions and ownership may vary due to the different methods used to transfer the file.</p> <p>Below is an example of the output of the 'ls -la' command for EPAP16.2:</p> <pre>[root@Natal-A upgrade]# ls -la total 1785996 drwxrwxr-x.  3 root admgrp   4096 Jun 23 01:19 . dr-xr-xr-x. 21 root root     4096 Jun 23 00:00 .. -r--r----- 1 root root  904644608 Jun 23 01:19 EPAP-16.2.0.0.1_162.26.0-x86_64.iso</pre>

## Procedure 14: Assess the MPS Server's Readiness for Upgrade

<p>5. <input type="checkbox"/></p>	<p><b>MPS B:</b> Delete old ISO images.</p>	<p>Remove any ISO images that are not the target software ISO image using the following command:</p> <pre># sudo rm -f /var/TKLC/upgrade/&lt;filename&gt;</pre> <p>Refer to step 6 to display the content of /var/TKLC/upgrade directory. Removed ISO should not be displayed.</p>
<p>6. <input type="checkbox"/></p>	<p><b>MPS B:</b> Determine when last reboot occurred. For any server up longer than 180 days would be a candidate for reboot during a maintenance window.</p>	<pre>\$ uptime</pre> <pre>15:19:34 up 23 days, 3:05, 2 users, load average: 0.10, 0.13, 0.09</pre>
<p>7. <input type="checkbox"/></p>	<p><b>MPS B:</b> Disk Integrity step: Executing self-test on the disk.</p>	<p>Run the following command:</p> <pre>\$ sudo smartctl -t short /dev/sda</pre> <p>The output on E5-APP-B card would be like:</p> <pre>smartctl 5.43 2012-06-30 r3573 [x86_64-linux-2.6.32-642.6.2.el6prere17.4.0.0_88.32.0.x86_64] (local build) Copyright (C)2002-12 by Bruce Allen, http://smartmontools.sourceforge.net  === START OF OFFLINE IMMEDIATE AND SELF-TEST SECTION === Sending command: "Execute SMART Short self-test routine immediately in off-line mode". Drive command "Execute SMART Short self-test routine immediately in off-line mode" successful. Testing has begun. Please wait 1 minutes for test to complete. Test will complete after Sat Feb 25 22:08:20 2017  Use smartctl -X to abort test. <b>Note: Please wait for 5 minutes for the test to complete.</b></pre>
<p>8. <input type="checkbox"/></p>	<p><b>MPS B:</b> Disk Integrity step.  Contact My Oracle Support if the output shows any error/failure.</p>	<p>Run the following command:</p> <pre>\$ sudo smartctl -l selftest /dev/sda</pre> <p>The output on E5-APP-B card would be like:</p> <pre>smartctl 5.43 2012-06-30 r3573 [x86_64-linux-2.6.32-642.6.2.el6prere17.4.0.0_88.32.0.x86_64] (local build) Copyright (C) 2002-12 by Bruce Allen, http://smartmontools.sourceforge.net  === START OF READ SMART DATA SECTION === SMART Self-test log structure revision number 1 Num Test_Description Status Remaining LifeTime(hours) LBA of first error</pre>

## Procedure 14: Assess the MPS Server's Readiness for Upgrade

		#	1	Short offline	Completed without error	00%	12435
9.	<input type="checkbox"/> <b>MPS B:</b> Disk Integrity step  Contact My Oracle Support if any output shows " <b>Completed: read failure</b> " or " <b>Error: UNC xxx sectors</b> ".	Run the following command: <b>\$ sudo smartctl -a /dev/sda   grep -i LBA</b>  The output would be like:  <pre> 241 Total_LBAs_Written      0x0032   100   100   000   Old_age   Always -      340851 242 Total_LBAs_Read        0x0032   100   100   000   Old_age   Always -      1689714 Num  Test_Description      Status              Remaining LifeTime(hours)  LBA_of_first_error SPAN  MIN_LBA  MAX_LBA  CURRENT_TEST_STATUS           </pre>					
10.	<input type="checkbox"/> <b>MPS B:</b> Disk Integrity Test.	Repeat steps 9 to 11 for the /dev/sdb disk drive on E5-APP-B card:					
11.	<input type="checkbox"/> <b>MPS B:</b> Logout from "admusr".	Logout from the "admusr" user by executing the following command:  <b>\$ exit</b>					
12.	<input type="checkbox"/> <b>MPS A:</b> Repeat checks on Server A.	Repeat steps-1 to 13 on MPS A.					
13.	<input type="checkbox"/> Procedure Complete.	This procedure is complete.					
14.	<input type="checkbox"/> Note down the timestamp in log.	Run the following command:  <b>\$ date</b>					

## Procedure 15 Preupgrade Backups

### Procedure 15: Preupgrade Backups

<b>S T E P #</b>	This procedure performs the pre and post upgrade backups.  Check off (✓) each step as it is completed. Boxes have been provided for this purpose under each step number.  <b>IF THIS PROCEDURE FAILS, CONTACT MY ORACLE SUPPORT AND ASK FOR UPGRADE ASSISTANCE.</b>	
	<input type="checkbox"/> <b>1.</b> <b>MPS A:</b> Backup system configuration on MPS A.	Follow <a href="#">Procedure A.3</a> to backup the system configuration on MPS A.
	<input type="checkbox"/> <b>2.</b> <b>MPS B:</b> Backup system configuration on MPS B.	Follow <a href="#">Procedure A.3</a> to backup the system configuration on MPS B.

### Procedure 15: Preupgrade Backups

3. <input type="checkbox"/>	<b>MPS B: Backup RTDB database.</b>  <b>Note:</b> If migrating from 17.0.0.x, skip this step.	Perform Procedure A.7 to backup the RTDB database on MPS B. Note: Perform this step only while upgrading Mixed and Non-Prov Nodes.																								
4. <input type="checkbox"/>	<b>MPS A: Backup EuiDB database.</b>  <b>Note:</b> If migrating from 17.0.0.x, skip this step.	Perform <a href="#">Procedure A.8</a> to backup the EuiDB database on MPS A.																								
5. <input type="checkbox"/>	<b>MPS A: Backup PDB database.</b> <b>Note:</b> Only perform this step if the MPS-A is configured as a Provisionable node. Check the output of <a href="#">Procedure 2</a> , step 9 to verify if MPS A is provisionable or not.	<table border="1"> <thead> <tr> <th>Case</th> <th>Source Release</th> <th>Destination Release</th> <th>Backup Procedure</th> </tr> </thead> <tbody> <tr> <td>1.</td> <td>17.0.0.0 to 17.0.0.5</td> <td>17.0.0.6 or greater</td> <td><a href="#">Procedure A.51</a></td> </tr> <tr> <td>2.</td> <td>17.0.0.0 to 17.0.0.5</td> <td>17.1.y or greater</td> <td><a href="#">Procedure A.51</a></td> </tr> <tr> <td>3.</td> <td>16.3.x /16.4.x</td> <td>17.x</td> <td><a href="#">Procedure A.27</a></td> </tr> <tr> <td>4.</td> <td>17.x (480 GB harddisk, E5APPB-02 card)</td> <td>17.y (300 GB harddisk, E5APPB-01 card)</td> <td><a href="#">Procedure A.27</a></td> </tr> <tr> <td>5.</td> <td colspan="2">           In a dual mixed server configuration, if one of the provisioning sites has already been upgraded to EPAP 17.x, take the PDB backup from the upgraded Provisioning site. The other provisioning site will subsequently be upgraded to the same 17.x release. Hence, the backup from the already upgraded site will be compatible and can be used for this upgrade as well.         </td> <td><a href="#">Procedure A.6</a></td> </tr> </tbody> </table> <p><b>Note:</b></p> <ol style="list-style-type: none"> <li>When one of the provisioning sites is already upgraded to 17.x (480 GB harddisk, E5APPB-02 card), and the site to be upgraded to is E5APPB-01 (300GB), PDB backup will be incompatible as the 480GB disk contains 50 ibdata files and the 300GB disk contains 25 ibdata files. Hence, mysqldump should be taken in this case. It will be used later for the upgraded site to restore PDB.</li> <li>Please check the disk size using “fdisk -l” command from root user before taking the pdb backup.</li> </ol>	Case	Source Release	Destination Release	Backup Procedure	1.	17.0.0.0 to 17.0.0.5	17.0.0.6 or greater	<a href="#">Procedure A.51</a>	2.	17.0.0.0 to 17.0.0.5	17.1.y or greater	<a href="#">Procedure A.51</a>	3.	16.3.x /16.4.x	17.x	<a href="#">Procedure A.27</a>	4.	17.x (480 GB harddisk, E5APPB-02 card)	17.y (300 GB harddisk, E5APPB-01 card)	<a href="#">Procedure A.27</a>	5.	In a dual mixed server configuration, if one of the provisioning sites has already been upgraded to EPAP 17.x, take the PDB backup from the upgraded Provisioning site. The other provisioning site will subsequently be upgraded to the same 17.x release. Hence, the backup from the already upgraded site will be compatible and can be used for this upgrade as well.		<a href="#">Procedure A.6</a>
Case	Source Release	Destination Release	Backup Procedure																							
1.	17.0.0.0 to 17.0.0.5	17.0.0.6 or greater	<a href="#">Procedure A.51</a>																							
2.	17.0.0.0 to 17.0.0.5	17.1.y or greater	<a href="#">Procedure A.51</a>																							
3.	16.3.x /16.4.x	17.x	<a href="#">Procedure A.27</a>																							
4.	17.x (480 GB harddisk, E5APPB-02 card)	17.y (300 GB harddisk, E5APPB-01 card)	<a href="#">Procedure A.27</a>																							
5.	In a dual mixed server configuration, if one of the provisioning sites has already been upgraded to EPAP 17.x, take the PDB backup from the upgraded Provisioning site. The other provisioning site will subsequently be upgraded to the same 17.x release. Hence, the backup from the already upgraded site will be compatible and can be used for this upgrade as well.		<a href="#">Procedure A.6</a>																							
6.	Note down the timestamp in log.	Run the following command:																								

## Procedure 15: Preupgrade Backups

□		\$ date
7.	Transfer the backup to remote server	<p>Using SFTP (secure-FTP), transfer the backups to a remote, customer-provided computer. Enter “yes” when prompted if you want to continue to connect.</p> <pre>\$ cd /var/TKLC/epap/free</pre> <pre>\$ sftp &lt;IP address of remote computer&gt; Connecting to &lt;IP address of remote computer&gt;... The authenticity of host '&lt;IP address of remote computer&gt;' can't be established. DSA key fingerprint is 58:a5:7e:1b:ca:fd:1d:fa:99:f2:01:16:79:d8:b4:24. Are you sure you want to continue connecting (yes/no)? <b>yes</b> Warning: Permanently added &lt;IP address of remote computer&gt;' (DSA) to the list of known hosts. root@&lt;IP address of remote computer&gt;'s password: sftp&gt; cd &lt;target directory&gt; sftp&gt; put backup_file</pre> <p><b>Note: put backups one by one</b></p> <p>Uploading backup_file sftp&gt; bye</p> <p>If no customer provided remote computer for backups exist, transfer the backup file to the mate using the following command:</p> <pre>\$ sudo chmod 667 /var/TKLC/epap/free/&lt;Backup file&gt; \$ su - epapdev \$ scp /var/TKLC/epap/free/&lt;backup file&gt; epapdev@mate:/var/TKLC/epap/free/</pre>
8.	Procedure Complete.	This procedure is complete.

## Procedure 16 Preupgrade system time check

### Procedure 16: Pre-upgrade System Time Check

S T E P #	<p>This procedure performs the pre-upgrade system time check.</p> <p>Check off (✓) each step as it is completed. Boxes have been provided for this purpose under each step number.</p> <p><b>IF THIS PROCEDURE FAILS, CONTACT MY ORACLE SUPPORT AND ASK FOR <u>UPGRADE ASSISTANCE</u>.</b></p>
	<p><b>The MPS servers make use of NTP to keep time synchronized between servers. Under some circumstances, either at initial installation in the customer’s network or due to power interruption and battery failure, it is possible for an MPS server to have a system date/time value too large for NTP to correct. If the system time is 20 minutes or more off from the real time, NTP cannot correct it.</b></p> <p><b>Check the date/time on <i>both</i> MPS-A and MPS-B servers, and correct the system time on any server off by more than 15 minutes from the real time.</b></p>

1. <input type="checkbox"/>	<b>MPS A:</b> Log in as the user "epapdev".	If not already logged in, then login at MPS A: <b>&lt;hostname&gt; console login: epapdev password: &lt;password&gt;</b>
2. <input type="checkbox"/>	<b>MPS A:</b> Execute the "date" command.	Execute the "date" command and examine the result. <b>\$ date Sat Feb 25 22:09:58 EDT 2018</b>
3. <input type="checkbox"/>	<b>MPS B:</b> Log in as the user "epapdev".	If not already logged in, then login at MPS B: <b>&lt;hostname&gt; console login: epapdev password: &lt;password&gt;</b>
4. <input type="checkbox"/>	<b>MPS B:</b> Execute the "date" command.	Execute the "date" command and examine the result. <b>\$ date Sat Feb 25 22:09:58 EDT 2018</b>
5. <input type="checkbox"/>	Compare result to the real time.	Compare the result from the "date" command in the previous step to the real time. If the difference is 15 minutes or less, then this procedure is complete, otherwise if the difference exceeds 15 minutes, contact My Oracle Support following the instructions on the front page or the instructions in the <b>My Oracle Support</b> section
6. <input type="checkbox"/>	Procedure Complete.	This procedure is complete.
7. <input type="checkbox"/>	Note down the timestamp in log.	Run the following command: <b>\$ date</b>

## Procedure 17 Check 9dig counts before moving to eXtreme architecture

### Procedure 17: Check 9dig counts before moving to eXtreme architecture

**Note: This step is only required before converting DB architecture from Compact to Extreme**

<b>S</b> <b>T</b> <b>E</b> <b>P</b> <b>#</b>	This procedure checks the 9dig counts for all DN/IMSI and IMEI.  Check off (✓) each step as it is completed. Boxes have been provided for this purpose under each step number.  IF THIS PROCEDURE FAILS, CONTACT MY ORACLE SUPPORT AND ASK FOR <u>UPGRADE ASSISTANCE</u> .	
<b>Verify the PDB data are within 9dig limitation</b>  Maximum 9dig limit for DN: 65K Maximum 9dig limit for IMSI: 65K Maximum 9dig limit for IMEI: 250K		
1. <input type="checkbox"/>	<b>MPS A:</b> Log in as the user "epapdev" on standalone PDB.	If not already logged in, then login at MPS A: <b>&lt;hostname&gt; console login: epapdev</b> <b>password: &lt;password&gt;</b>
2. <input type="checkbox"/>	<b>MPS A:</b> Execute the "parse9Dig" script on standalone PDB.	Execute the "parse9Dig" script and examine the result.  <b>Note: Stop the Pdba software before executing this script.</b>  \$ /usr/TKLC/epap/config/parse9Dig all c  Get reference from the following snapshot:  <pre> [epapdev@Osorna-1B-PDBOnly config]\$ /usr/TKLC/epap/config/parse9Dig all c  This utility will retrieve all digits for DB and parse them into 9Dig entries.  ***** Utility Start Time: 06/13/18-20:51:48  Parsing DN digits into 9digits... INFO: DN 9dig count 2.  Parsing IMSI digits into 9digits... INFO: IMSI 9dig count: 9.  Parsing IMEI digits into 9digits... INFO: IMEI 9dig count: 1.  Utility End Time: 06/13/18-20:51:48 [epapdev@Osorna-1B-PDBOnly config]\$                 </pre> If any of the data type from DN/IMSI and IMEI exceeds the 9Dig limit, then DB Architecture cannot be changed to eXtreme.

3. <input type="checkbox"/>	<b>MPS A:</b> Start Pdba software.	<p>Run the following command to start Pdba software on EPAP 16.3.1/16.4.1 servers:</p> <pre>\$ service Pdba start</pre> <p>~~ /etc/init.d/Pdba start ~~ PDBA application start Successful.</p> <p>Run the following command to start Pdba software on EPAP 17.1 servers:</p> <pre>\$ systemctl start Pdba</pre>
4. <input type="checkbox"/>	<b>MPS A:</b> Procedure is complete.	This procedure is complete.
5. <input type="checkbox"/>	Note down the timestamp in log.	<p>Run the following command:</p> <pre>\$ date</pre>

## Procedure 18 Upgrade Server B

### Procedure 18: Upgrade Server B

<b>S T E P #</b>	<p>This procedure upgrades MPS B server.</p> <p>Check off (✓) each step as it is completed. Boxes have been provided for this purpose under each step number.</p> <p>IF THIS PROCEDURE FAILS, CONTACT MY ORACLE SUPPORT AND <b>ASK FOR <u>UPGRADE ASSISTANCE</u></b>.</p>	
1. <input type="checkbox"/>	<p>Notify the potential users not to start the PDBA software during the duration of the upgrade.</p> <p>The Prov servers (Mixed EPAP or PDBonly) upgrade must complete before the Non-Provisionable EPAP. For more details, see <a href="#">Upgrading EPAP Non-Provisionable MPS Servers</a>.</p>	
2. <input type="checkbox"/>	Establish a connection to MPS B.	<p>If access to the MPS servers is not available through an IP network, connect to the E5-APP-B card via the serial port.</p> <p>For connecting the E5-APP-B B card, disconnect the console cable from the serial port on the E5-APP-B A card's adapter. The cable should be disconnected at the point where it connects to the serial port labeled 'S1' on the E5-APP-B A card's adapter and use it for serial access. <b>Cable part numbers - 830-1220-xx</b></p> <p>Skip to step 7, if connected through serial console.</p>
3. <input type="checkbox"/>	Create a terminal window and establish a	In a newly created terminal window labeled "MPS B – from MPS A", connect directly into MPS A.

## Procedure 18: Upgrade Server B

	<p>connection by logging into MPS A.</p> <p>Log in to MPS A.</p>	<pre># ssh admusr@&lt;MPS A&gt; Password: &lt;password&gt;</pre>
4. <input type="checkbox"/>	<p><b>MPS A:</b> Start screen session.</p> <p><b>MPS A:</b> Connect to the console of MPS B.</p>	<p>Run the following commands to start screen and establish a console session to MPS B.</p> <pre>\$ screen -L</pre> <p>Run the following command on E5-APP-B:</p> <pre>\$ sudo minicom mate</pre> <p>If above command fails, then refer to <a href="#">Procedure A.24</a>.</p>
5. <input type="checkbox"/>	<p><b>MPS B:</b> Login prompt is displayed.</p>	<pre>&lt;hostname&gt; console login:</pre> <p>Note: Hit enter if no login prompt is displayed.</p>
6. <input type="checkbox"/>	<p><b>MPS B:</b> Log in to the server as the user "epapdev".</p>	<pre>&lt;hostname&gt; console login: epapdev password: &lt;password&gt;</pre>
7. <input type="checkbox"/>	<p><b>MPS B:</b> Determine media available for upgrade.</p>	<p>Perform 0 or use an EPAP ISO image to perform upgrade.</p>
8. <input type="checkbox"/>	<p><b>MPS B:</b> Verify that it is an Incremental Upgrade or a Major upgrade</p>	<p>Check 0, Step 7 and 8. If the upgrade type is a split mirror upgrade, proceed with the following step. If it's Incremental, proceed to step 11</p>
9. <input type="checkbox"/>	<p><b>MPS B:</b> Disable syscheck fs module.</p>	<p>Run the following command to disable the syscheck fs module.</p> <pre>\$ su - root Password:  # syscheckAdm --disable disk fs</pre>
10. <input type="checkbox"/>	<p><b>MPS B:</b> Create upgrade.conf for splitting mirrors.</p>	<p>Create a file (if not already created) and add the line "BACKOUT_TYPE=SPLIT_MIRROR" (to trigger the split mirror upgrade) by executing the following steps:</p> <pre>1. # vi /usr/TKLC/plat/etc/upgrade/upgrade.conf 2.If file already contains some allow listed alarms then append bellow line at the end of the file, otherwise add it to first line: BACKOUT_TYPE=SPLIT_MIRROR</pre> <p>NOTE: Not performing this step will prevent any successful backout.</p>

## Procedure 18: Upgrade Server B

		<p>Run the following command to verify that the above command has been executed successfully:</p> <pre># cat /usr/TKLC/plat/etc/upgrade/upgrade.conf</pre> <p>The output should be:</p> <pre>[root@MPS-B ~]# cat /usr/TKLC/plat/etc/upgrade/upgrade.conf</pre> <pre>BACKOUT_TYPE=SPLIT_MIRROR</pre> <pre># su - admusr</pre>
11. <input type="checkbox"/>	<b>MPS A:</b> Log in to the server as the user "admusr".	<p>Log in to MPS A:</p> <pre>&lt;hostname&gt; console login: admusr password: &lt;password&gt;</pre>
12. <input type="checkbox"/>	<b>MPS A:</b> Check if eagle_alarm_feed variable is present in EuiDB.	<p>Run the following command to check if uiEdit variable is present or not.</p> <pre>\$ uiEdit   grep "EAGLE_ALARM_FEED"</pre> <p>"EAGLE_ALARM_FEED" is set to "ON"</p> <p><b>Note:</b> If no output is displayed after above command is run, then run next step else skip next step.</p>
13. <input type="checkbox"/>	<b>MPS A:</b> Insert EAGLE_ALARM_FEED variable in EuiDB	<p>NOTE: Skipping this step if EAGLE_ALARM_FEED variable is not present in EuiDB will cause upgrade to fail</p> <p>Run the following command to insert the missing variable in EuiDB.</p> <pre>\$ /usr/bin/mysql -uroot -p&lt;password&gt; -B EuiDB -e "insert into econfig values ('EAGLE_ALARM_FEED','ON')"</pre> <p>Check if above command was successful. Output should be as displayed below:</p> <pre>\$ echo \$?</pre> <pre>0</pre> <p>Repeat Step 12 to check if value is inserted successfully in DB.</p> <p>Contact My Oracle Support following the instructions on the front page or the instructions in the <b>My Oracle Support</b> section if this step fails.</p>
14. <input type="checkbox"/>	<b>MPS A:</b> Verify that the state of PDBA Proxy Feature is No.	<pre># sudo su - epapconfig</pre> <p>Warning: Smartmatch is experimental at /usr/TKLC/plat/lib/Security/User.pm line 904.</p>

## Procedure 18: Upgrade Server B

<p><b>Note:</b> Skip this step for Non-Prov and PDBonly EPAP.</p>	<pre> /-----EPAP Configuration Menu-----\ /-----\    1   Display Configuration  -----     2   Configure Network Interfaces Menu  -----     3   Set Time Zone  -----     4   Exchange Secure Shell Keys  -----     5   Change Password  -----     6   Platform Menu  -----     7   Configure NTP Server  -----     8   PDB Configuration Menu  -----     9   Security  -----    10   SNMP Configuration  -----    11   Configure Alarm Feed  -----    12   Configure Query Server  -----    13   Configure Query Server Alarm Feed  -----    14   Configure SNMP Agent Community  -----    15   Mate Disaster Recovery  -----     e   Exit \-----\  Enter Choice: 1 EPAP A Provisioning Network IP Address = 192.168.61.115 EPAP B Provisioning Network IP Address = 192.168.61.116 Provisioning Network Netmask           = 255.255.255.0 Provisioning Network Default Router     = 192.168.61.1 EPAP A Backup Prov Network IP Address   = Not configured EPAP B Backup Prov Network IP Address   = Not configured Backup Prov Network Netmask             = Not configured Backup Prov Network Default Router       = Not configured EPAP A Sync Network Address             = 192.168.2.100 EPAP B Sync Network Address             = 192.168.2.200 EPAP A Main DSM Network Address         = 192.168.120.100 EPAP B Main DSM Network Address         = 192.168.120.200 EPAP A Backup DSM Network Address       = 192.168.121.100 EPAP B Backup DSM Network Address       = 192.168.121.200 </pre>
---	--

**Procedure 18: Upgrade Server B**

		<pre> EPAP A HTTP Port           = 80 EPAP B HTTP Port           = 80 EPAP A HTTP SuExec Port    = 8001 EPAP B HTTP SuExec Port    = 8001 EPAP A Banner Connection Port = 8473 EPAP B Banner Connection Port = 8473 EPAP A Static NAT Address   = Not configured EPAP B Static NAT Address   = Not configured PDBI Port                   = 5873 Remote MPS A Static NAT Address = Not configured Remote MPS A HTTP Port     = 80 Local Provisioning VIP      = 192.168.15.152 Remote Provisioning VIP     = 192.168.15.172 Local PDBA Address          = 192.168.15.115 Remote PDBA Address         = 192.168.16.115 Remote PDBA B Address       = 192.168.16.116 Time Zone                   = America/New_York PDB Database                = Exists Preferred PDB                = Standby Allow updates from alternate PDB = Yes Auto DB Recovery Enabled    = Yes PDBA Proxy Enabled          = <b>Yes</b> </pre> <p>If PDBA Proxy Enabled = Yes then follow <a href="#">Procedure A.19</a> on both PDBA Active and Standby for dual PDBA setup to disable EPAP VIP and PDBA proxy features.</p> <p>Otherwise, if PDBA Proxy Enabled = No, then skip this step.</p>
<p>15. <input type="checkbox"/></p>	<p><b>MPS A:</b> Clear PDB replication logs</p>	<p>If PDBA Proxy Enabled = Yes then Execute Procedure A.26 to clear replication logs</p> <p>Otherwise, if PDBA Proxy Enabled = No, then skip this step.</p>
<p>16. <input type="checkbox"/></p>	<p><b>MPS A:</b> Choose "e" to exit.</p>	<p>MPS Side A:</p>

**Procedure 18: Upgrade Server B**

		<pre> /-----EPAP Configuration Menu-----\ /-----\   1   Display Configuration  -----    2   Configure Network Interfaces Menu  -----    3   Set Time Zone  -----    4   Exchange Secure Shell Keys  -----    5   Change Password  -----    6   Platform Menu  -----    7   Configure NTP Server  -----    8   PDB Configuration Menu  -----    9   Security  -----    10   SNMP Configuration  -----    11   Configure Alarm Feed  -----    12   Configure Query Server  -----    13   Configure Query Server Alarm Feed  -----    14   Configure SNMP Agent Community  -----    15   Mate Disaster Recovery  -----    e   Exit \-----/  Enter choice: e </pre>
<p>17. <input type="checkbox"/></p>	<p><b>MPS B:</b> Log in to the server as the user "admusr".</p>	<p>Log in to MPS B if not already logged in:</p> <pre> &lt;hostname&gt; console login: admusr password: &lt;password&gt; </pre>
<p>18. <input type="checkbox"/></p>	<p><b>MPS B:</b> Execute the platcfg menu.</p>	<pre> \$ sudo su - platcfg </pre>

## Procedure 18: Upgrade Server B

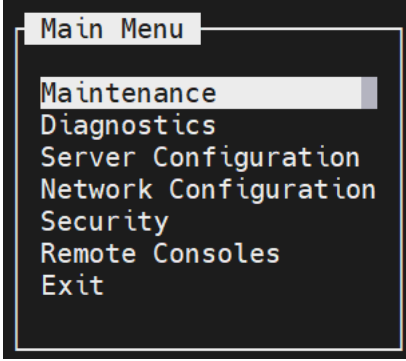
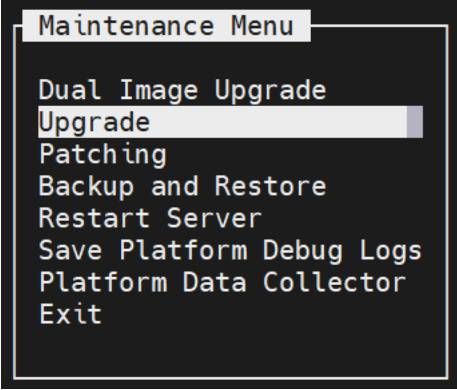
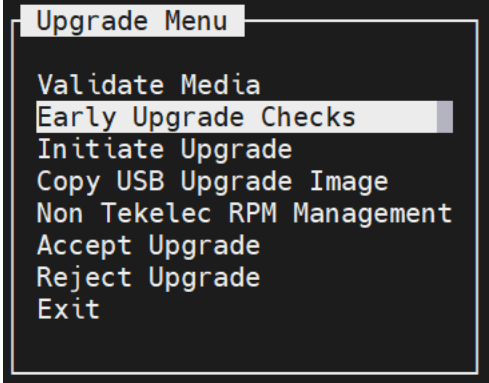
<p>19. <input type="checkbox"/></p>	<p><b>MPS B:</b> Select the Maintenance submenu.</p>	<p>The platcfg <b>Main Menu</b> appears. On the <b>Main Menu</b>, select <b>Maintenance</b> and press [ENTER].</p>  <p>The screenshot shows a terminal window titled 'Main Menu' with the following options: Maintenance (highlighted), Diagnostics, Server Configuration, Network Configuration, Security, Remote Consoles, and Exit.</p>
<p>20. <input type="checkbox"/></p>	<p><b>MPS B:</b> Select the Upgrade submenu.</p>	<p>Select the <b>Upgrade</b> menu and press [ENTER].</p>  <p>The screenshot shows a terminal window titled 'Maintenance Menu' with the following options: Dual Image Upgrade (highlighted), Upgrade, Patching, Backup and Restore, Restart Server, Save Platform Debug Logs, Platform Data Collector, and Exit.</p>
<p>21. <input type="checkbox"/></p>	<p><b>MPS B:</b> Select Early Upgrade Checks</p>	<p>Select the “Early Upgrade Checks” menu to verify that the system is ready for upgrade.</p>  <p>The screenshot shows a terminal window titled 'Upgrade Menu' with the following options: Validate Media (highlighted), Early Upgrade Checks, Initiate Upgrade, Copy USB Upgrade Image, Non Tekelec RPM Management, Accept Upgrade, Reject Upgrade, and Exit.</p> <p>If the Early Upgrade Checks fail due to the NTP related alarms, then execute step 22. Otherwise, skip to step 23.</p>

## Procedure 18: Upgrade Server B

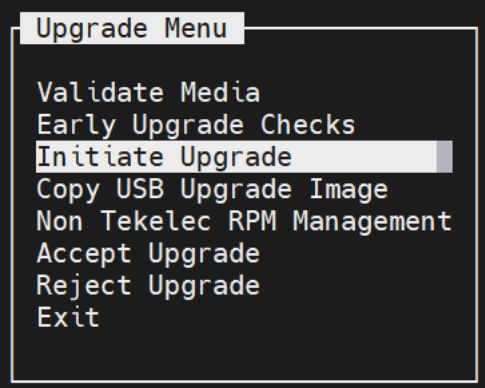
		<p>Contact My Oracle Support following the instructions on the front page or the instructions in the <b>My Oracle Support</b> section, if the early upgrade checks fail due to any other reason.</p>
<p>22. <input type="checkbox"/></p>	<p><b>MPS B:</b> Allow List NTP Alarms</p>	<p>1) If the Early Upgrade Checks fail due to the NTP related alarms, then ignore the NTP alarms using the following commands:</p> <ol style="list-style-type: none"> <li>a. Exit the platcfg menu</li> <li>b. Change to root user using the “su –” command.</li> <li>c. <code>vim /usr/TKLC/plat/etc/upgrade/upgrade.conf</code></li> <li>d. Edit the following line to include the NTP related alarms. EARLY_CHECK_ALARM_WHITELIST=TKSPLATMI2</li> </ol> <p>For example – To allowlist the NTP alarm “tpdNTPDaemonNotSynchronizedWarning” which has the alarm code TKLCPLATMI10, the above mentioned line should be edited as EARLY_CHECK_ALARM_WHITELIST=TKSPLATMI2,TKSPLATMI10</p> <p>Note: There should not be any space between two alarms i.e. between TKSPLATMI2 and TKSPLATMI10</p> <p>2) If the Early Upgrade Checks fail due to “Server Default Route Network Error”, then this alarm shall be allowlisted in upgrade.conf file. To allowlist this alarm which has the alarm code TKSPLATMA14, the above mentioned line should be edited as EARLY_CHECK_ALARM_WHITELIST=TKSPLATMI2,TKSPLATMI10,TKSPLATMA14</p>
<p>23. <input type="checkbox"/></p>	<p><b>MPS B:</b> Select Initiate Upgrade.</p>	<p>Select the <b>Initiate Upgrade</b> menu and press [ENTER].</p>  <p>The screenshot shows a terminal window titled 'Upgrade Menu' with the following options listed: 'Validate Media', 'Early Upgrade Checks', 'Initiate Upgrade' (highlighted with a white bar), 'Copy USB Upgrade Image', 'Non Tekelec RPM Management', 'Accept Upgrade', 'Reject Upgrade', and 'Exit'.</p>
<p>24. <input type="checkbox"/></p>	<p><b>MPS B:</b> Select the Upgrade Media.</p>	<p>The screen will display a message that it is searching for upgrade media. Once the upgrade media is found, an Upgrade Media selection menu will be displayed similar to the example shown below.</p>

## Procedure 18: Upgrade Server B

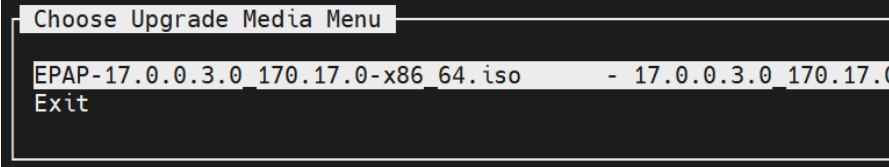
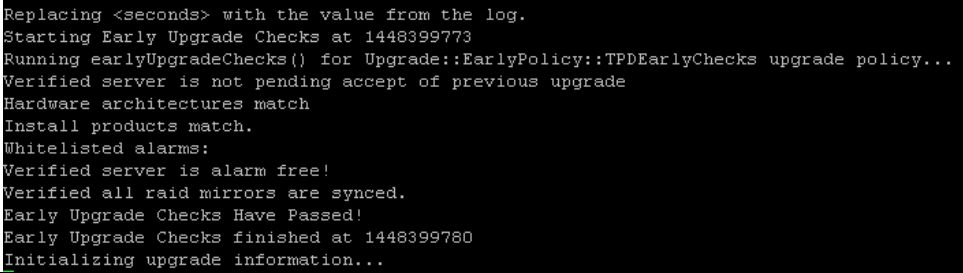
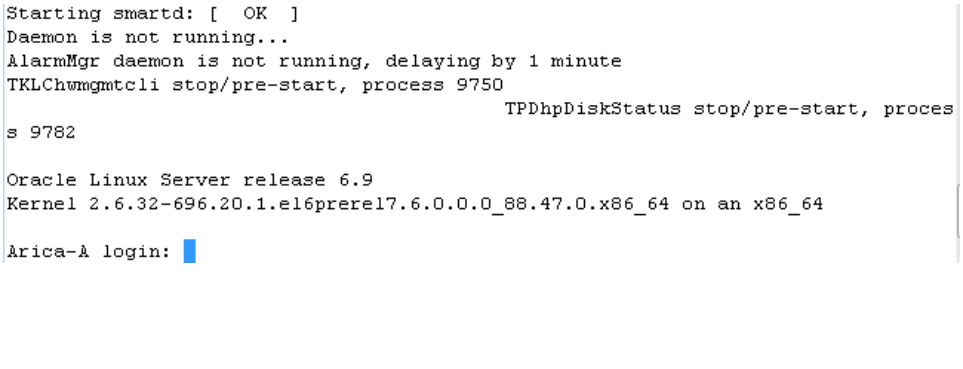
		<p>Select the upgrade media on ISO image. There should only be one selection available, as shown in the example below. If there is more than one selection available, contact My Oracle Support following the instructions on the front page or the instructions in the <b>My Oracle Support</b> section</p> 
<p>25. <input type="checkbox"/></p>	<p><b>MPS B:</b> Upgrade proceeds.</p>	<p>The screen displays the following, indicating that the upgrade software is first running the early upgrade checks, and then proceeding with the upgrade.</p> 
<p>26. <input type="checkbox"/></p>	<p><b>MPS B:</b> Upgrade proceeds.</p>	<p>Many informational messages will come across the terminal screen as the upgrade proceeds.</p> <p>Finally, after upgrade is complete, the server will reboot.</p>
<p>27. <input type="checkbox"/></p>	<p><b>MPS B:</b> Upgrade completed.</p>	<p>After the final reboot, Press Enter the screen will display the login prompt, as shown in the example below.</p> 
<p>28. <input type="checkbox"/></p>	<p><b>MPS B:</b> Log in to the server as the user "epapdev".</p>	<p><b>After upgrade, exit from the console and open new console using EPAP IP and login by epapdev user.</b>  <b>&lt;hostname&gt; console login: epapdev</b>  <b>password: &lt;password&gt;</b></p>

**Procedure 18: Upgrade Server B**

		<p>Note: The SSH login for root shall get enabled after the upgrade.</p>
<p>29. <input type="checkbox"/></p>	<p><b>MPS B:</b> Verify the Upgrade.</p>	<p>Examine the upgrade logs in the directory <code>/var/TKLC/log/upgrade</code> and verify that no errors and warnings were reported. Check 0, Steps 7 and 8 to determine whether it is incremental or major upgrade.</p> <p>If it is major upgrade, then consider following error and warning. <b>\$ grep -i error /var/TKLC/log/upgrade/upgrade.log</b></p> <p>Following errors shall be observed:  <pre> 1530712922::ERROR: Config file is currently checked out! 1530712922::ERROR: LOCKED BY: platcfg 1530712922::ERROR: CONFIG: /usr/TKLC/plat/etc/vlan.conf 1530712922::ERROR: ELEMENT: /var/TKLC/rcs/usr/TKLC/plat/etc/vlan.conf,v . . 1530669414::myisamchk: error: 140 when opening MyISAM-table '/var/TKLC/epap/db/pdb/mysql/columns_priv.MYI' 1530669414::myisamchk: error: 140 when opening MyISAM-table '/var/TKLC/epap/db/pdb/mysql/columns_priv.MYI' 1530669414:: 1530669414::----- 1530669414:: 1530669414::myisamchk: error: 140 when opening MyISAM-table '/var/TKLC/epap/db/pdb/mysql/db.MYI' 1530669414::myisamchk: error: 140 when opening MyISAM-table '/var/TKLC/epap/db/pdb/mysql/db.MYI' 1530669414:: 1530669414::----- 1530669414:: 1530669414::myisamchk: error: 140 when opening MyISAM-table '/var/TKLC/epap/db/pdb/mysql/event.MYI' 1530669414::myisamchk: error: 140 when opening MyISAM-table '/var/TKLC/epap/db/pdb/mysql/event.MYI' . . . 1528826597::myisamchk: error: 140 when opening MyISAM-table '/var/TKLC/epap/db/appconfig/EuiDB/alarmInfo.MYI' 1528826597::myisamchk: error: 140 when opening MyISAM-table '/var/TKLC/epap/db/appconfig/EuiDB/alarmInfo.MYI' 1528826597::myisamchk: error: 140 when opening MyISAM-table '/var/TKLC/epap/db/appconfig/EuiDB/bannerinfo.MYI' 1528826597::myisamchk: error: 140 when opening MyISAM-table '/var/TKLC/epap/db/appconfig/EuiDB/bannerinfo.MYI' . . . 1533053832::Sorry, user root is not allowed to execute '/bin/chown epapdev:epap /var/TKLC/epap/logs/queryServer.log' as root on epap136. 1533053832::Sorry, user root is not allowed to execute '/bin/chown epapdev:epap /var/TKLC/epap/logs/queryServer.log' as root on epap136. . . . 530094474::libsemanage.semanage_reload_policy: load_policy returned error code 2 </pre> </p>

## Procedure 18: Upgrade Server B

	<pre>1530094474::libsemanage.semanage_reload_policy: load_policy returned error code 2. . 1494304768::ERROR: Config file is currently checked out! 1494304781::ERROR: LOCKED BY: platcfg 1494304781::ERROR: CONFIG: /usr/TKLC/plat/etc/vlan.conf 1494304781::ERROR: ELEMENT: /var/TKLC/rcs/usr/TKLC/plat/etc/vlan.conf,v 1496215832::Error : Table 'mysql.innodb_index_stats' doesn't exist 1496215832::Error : Table 'mysql.innodb_table_stats' doesn't exist 1496215832::Error : Table 'mysql.slave_master_info' doesn't exist 1496215832::Error : Table 'mysql.slave_relay_log_info' doesn't exist 1496215832::Error : Table 'mysql.slave_worker_info' doesn't exist 1496215832::Error : Table 'mysql.innodb_index_stats' doesn't exist 1496215832::Error : Table 'mysql.innodb_table_stats' doesn't exist 1496215832::Error : Table 'mysql.slave_master_info' doesn't exist 1496215832::Error : Table 'mysql.slave_relay_log_info' doesn't exist 1496215832::Error : Table 'mysql.slave_worker_info' doesn't exist 1496215832::Error : Table 'mysql.innodb_index_stats' doesn't exist 1496215832::Error : Table 'mysql.innodb_table_stats' doesn't exist 1496215832::Error : Table 'mysql.slave_master_info' doesn't exist 1496215832::Error : Table 'mysql.slave_relay_log_info' doesn't exist 1496215832::Error : Table 'mysql.slave_worker_info' doesn't exist</pre> <p><b>Following statement for missing binary file shall be observed in upgrade.log:</b> 1530885808::/bin/df: `/mnt/ugchroot/sys': No such file or directory 1542631084::/upgrade_mysql: line 46: /usr/TKLC/epap/bin/pass_fetch: No such file or directory</p> <p>[NOTE: It is observed only when MySQL upgraded from earlier version than 5.6.18 to version 5.7]</p> <p>Contact My Oracle Support following the instructions on the front page or the instructions in the <b>My Oracle Support</b> section, if the output contains any error other than the above mentioned errors.</p> <p>Also note that sometime a carriage return is inserted in the log file causing some of the error messages to appear truncated. This is acceptable and should be ignored.</p> <p><b>\$ grep -i warning /var/TKLC/log/upgrade/upgrade.log</b></p> <p>Examine the output of the above command to determine if any warnings were reported.</p> <p>Contact My Oracle Support following the instructions on the front page or the instructions in the <b>My Oracle Support</b> section, if the output contains any warnings beside the following:</p> <pre>1488951825::warning: CAPABILITY: service_hp-asrd_disabled 1488951825::WARNING: /usr/TKLC/plat/etc/alarms/alarms.xml has been updated...reparsing xml... 1530712185::WARNING: This capability is not defined in the default capabilities. 1530712186::WARNING: Nor is it defined in the current hardware ID's capabilities. 1530712186::WARNING: CAPABILITY: service__disabled 1530712186::WARNING: HARDWARE ID: E5APPB 1488951890::warning: erase unlink of /lib/modules/2.6.32-573.18.1.el6prere17.0.3.0.0_86.44.0.x86_64/weak-updates failed: No such file or directory 1488951902::warning: erase unlink of /lib/modules/2.6.32-573.18.1.el6prere17.0.3.0.0_86.44.0.x86_64/modules.softdep failed: No such file or directory</pre>
--	--

## Procedure 18: Upgrade Server B

		<pre> 1488951902::warning:      erase unlink of /lib/modules/2.6.32- 573.18.1.el6prere17. 0.3.0.0_86.44.0.x86_64/modules.order failed: No such file or directory 1488951902::warning:      erase unlink of /lib/modules/2.6.32- 573.18.1.el6prere17. 0.3.0.0_86.44.0.x86_64/modules.networking failed: No such file or directory 1488951902::warning:      erase unlink of /lib/modules/2.6.32- 573.18.1.el6prere17. 0.3.0.0_86.44.0.x86_64/modules.modetesting failed: No such file or directory 1488951902::warning:      erase unlink of /lib/modules/2.6.32- 573.18.1.el6prere17. 0.3.0.0_86.44.0.x86_64/modules.drm failed: No such file or directory 1488951902::warning:      erase unlink of /lib/modules/2.6.32- 573.18.1.el6prere17. 0.3.0.0_86.44.0.x86_64/modules.block failed: No such file or directory 1488951903::kexec-tools          #warning: /etc/kdump.conf created as /etc/ c/kdump.conf.rpmnew 1488952115::ca-certificates      #####warning: /etc/pki/tls/ce rts/ca-bundle.crt created as /etc/pki/tls/certs/ca-bundle.crt.rpmnew 1488952136::samhain              warning: /etc/samhainrc created as /etc/ samhainrc.rpmnew 1488952138::php-common          #warning: /etc/php.ini created as /etc/p hp.ini.rpmnew 1488952209::initscripts        ##warning: /etc/sysctl.conf created as / etc/sysctl.conf.rpmnew 1488952260::mysql-commercial-server warning: /etc/my.cnf created as /etc/my. cnf.rpmnew 1488952291::ntp                warning: /etc/ntp.conf created as /etc/n tp.conf.rpmnew 1488952302::TKLCPlat          #####warning: /usr/TKLC/plat/ etc/pid_conf created as /usr/TKLC/plat/etc/pid_conf.rpmnew 1488952302::#warning: /usr/TKLC/plat/etc/service_conf created as /usr/TKLC/plat/ etc/service_conf.rpmnew 1488952320::TKLCAlarms        ###warning: /usr/TKLC/plat/etc/alarms/al arms.xml saved as /usr/TKLC/plat/etc/alarms/alarms.xml.rpmsave 1488952328::alarmMgr          ###warning: /usr/TKLC/plat/etc/alarmMgr/ alarmMgr.conf created as /usr/TKLC/plat/etc/alarmMgr/alarmMgr.conf.rpmnew 1488952471::WARNING: This capability is not defined in the default capabilities. 1488952471::WARNING: Nor is it defined in the current hardware ID's capabilities  1488952471::WARNING: CAPABILITY: service__disabled 1488952471::WARNING: HARDWARE ID: E5APPB 1488952602::sudo              warning: /etc/sudoers created as /etc/su doers.rpmnew 1488952709::WARNING: /usr/TKLC/plat/etc/alarms/alarms_mps.xml has been updated.. .reparing xml... 1488952718::TKLCEpap-HA #####warnin g: group root} does not exist - using root 1488952942::warning:      erase unlink of /usr/TKLC/epap/bin/dbMigration failed: N such file or directory 1488952949::WARNING: Module variable EXPECTED_CPUS is deprecated! 1488952951::WARNING: CONFIG: /usr/TKLC/plat/lib/Syscheck/modules/system/cpu/conf tg 1488952951::WARNING: Module variable EXPECTED_CPU_ALM is deprecated! 1488952951::WARNING: CONFIG: /usr/TKLC/plat/lib/Syscheck/modules/system/cpu/conf tg </pre>
--	--	--

## Procedure 18: Upgrade Server B

		<p>If it is an incremental upgrade, then consider following error and warning</p> <pre>\$ grep -i error /var/TKLC/log/upgrade/upgrade.log</pre> <p>Following errors shall be observed:</p> <pre>1530712922::ERROR: Config file is currently checked out! 1530712922::ERROR: LOCKED BY: platcfg 1530712922::ERROR: CONFIG: /usr/TKLC/plat/etc/vlan.conf 1530712922::ERROR: ELEMENT: /var/TKLC/rcs/usr/TKLC/plat/etc/vlan.conf,v . . 1530669414::myisamchk: error: 140 when opening MyISAM-table '/var/TKLC/epap/db/pdb/mysql/columns_priv.MYI' 1530669414::myisamchk: error: 140 when opening MyISAM-table '/var/TKLC/epap/db/pdb/mysql/columns_priv.MYI' 1530669414:: 1530669414::----- 1530669414:: 1530669414::myisamchk: error: 140 when opening MyISAM-table '/var/TKLC/epap/db/pdb/mysql/db.MYI' 1530669414::myisamchk: error: 140 when opening MyISAM-table '/var/TKLC/epap/db/pdb/mysql/db.MYI' 1530669414:: 1530669414::----- 1530669414:: 1530669414::myisamchk: error: 140 when opening MyISAM-table '/var/TKLC/epap/db/pdb/mysql/event.MYI' 1530669414::myisamchk: error: 140 when opening MyISAM-table '/var/TKLC/epap/db/pdb/mysql/event.MYI' . . . 1528826597::myisamchk: error: 140 when opening MyISAM-table '/var/TKLC/epap/db/appconfig/EuiDB/alarmInfo.MYI' 1528826597::myisamchk: error: 140 when opening MyISAM-table '/var/TKLC/epap/db/appconfig/EuiDB/alarmInfo.MYI' 1528826597::myisamchk: error: 140 when opening MyISAM-table '/var/TKLC/epap/db/appconfig/EuiDB/bannerinfo.MYI' 1528826597::myisamchk: error: 140 when opening MyISAM-table '/var/TKLC/epap/db/appconfig/EuiDB/bannerinfo.MYI'.. . . . 1533053832::Sorry, user root is not allowed to execute '/bin/chown epapdev:epap /var/TKLC/epap/logs/queryServer.log' as root on epap136. 1533053832::Sorry, user root is not allowed to execute '/bin/chown epapdev:epap /var/TKLC/epap/logs/queryServer.log' as root on epap136. . . . 530094474::libsemanage.semanage_reload_policy: load_policy returned error code 2 1530094474::libsemanage.semanage_reload_policy: load_policy returned error code 2. . .1494304768::ERROR: Config file is currently checked out! 1494304781::ERROR: LOCKED BY: platcfg 1494304781::ERROR: CONFIG: /usr/TKLC/plat/etc/vlan.conf 1494304781::ERROR: ELEMENT: /var/TKLC/rcs/usr/TKLC/plat/etc/vlan.conf,v 1496215832::Error : Table 'mysql.innodb_index_stats' doesn't exist 1496215832::Error : Table 'mysql.innodb_table_stats' doesn't exist 1496215832::Error : Table 'mysql.slave_master_info' doesn't exist 1496215832::Error : Table 'mysql.slave_relay_log_info' doesn't exist</pre>
--	--	---

## Procedure 18: Upgrade Server B

```
1496215832::Error : Table 'mysql.slave_worker_info' doesn't exist
1496215832::Error : Table 'mysql.innodb_index_stats' doesn't exist
1496215832::Error : Table 'mysql.innodb_table_stats' doesn't exist
1496215832::Error : Table 'mysql.slave_master_info' doesn't exist
1496215832::Error : Table 'mysql.slave_relay_log_info' doesn't exist
1496215832::Error : Table 'mysql.slave_worker_info' doesn't exist
1496215832::Error : Table 'mysql.innodb_index_stats' doesn't exist
1496215832::Error : Table 'mysql.innodb_table_stats' doesn't exist
1496215832::Error : Table 'mysql.slave_master_info' doesn't exist
1496215832::Error : Table 'mysql.slave_relay_log_info' doesn't exist
1496215832::Error : Table 'mysql.slave_worker_info' doesn't exist
```

### Following statement for missing binary file shall be observed in upgrade.log:

```
1530885808::/bin/df: '/mnt/ugchroot/sys': No such file or directory
1542631084::./upgrade_mysql: line 46: /usr/TKLC/epap/bin/pass_fetch: No such
file or directory
```

[NOTE: It is observed only when MySQL upgraded from earlier version than 5.6.18 to version 5.7]

Contact My Oracle Support following the instructions on the front page or the instructions in the **My Oracle Support** section, if the output contains any error other than the above mentioned errors.

Also note that sometime a carriage return is inserted in the log file causing some of the error messages to appear truncated. This is acceptable and should be ignored.

```
$ grep -i warning /var/TKLC/log/upgrade/upgrade.log
```

Examine the output of the above command to determine if any warnings were reported.

Contact My Oracle Support following the instructions on the front page or the instructions in the **My Oracle Support** section, if the output contains any warnings beside the following:

```
1489042076::WARNING: /usr/TKLC/plat/etc/alarms/alarms.xml has been
updated...rep
arsing xml...
1489042124::warning:      erase unlink of /lib/modules/2.6.32-
642.6.2.e16prere17.4
.0.0.0_88.32.0.x86_64/weak-updates failed: No such file or directory
1489042136::warning:      erase unlink of /lib/modules/2.6.32-
642.6.2.e16prere17.4
.0.0.0_88.32.0.x86_64/modules.order failed: No such file or directory
1489042136::warning:      erase unlink of /lib/modules/2.6.32-
642.6.2.e16prere17.4
.0.0.0_88.32.0.x86_64/modules.networking failed: No such file or directory
1489042136::warning:      erase unlink of /lib/modules/2.6.32-
642.6.2.e16prere17.4
.0.0.0_88.32.0.x86_64/modules.modetesting failed: No such file or directory
1489042136::warning:      erase unlink of /lib/modules/2.6.32-
642.6.2.e16prere17.4
.0.0.0_88.32.0.x86_64/modules.drm failed: No such file or directory
1489042136::warning:      erase unlink of /lib/modules/2.6.32-
642.6.2.e16prere17.4
.0.0.0_88.32.0.x86_64/modules.block failed: No such file or directory
1489042197::WARNING: /usr/TKLC/plat/etc/alarms/alarms_mps.xml has been
updated..
.reparsing xml...
```

Refer to [section 3.7](#) to know more about logging.

## Procedure 18: Upgrade Server B

		<p><b>NOTE:</b> provRMTP core might be observed on EPAP after upgrade, if the EPAP is connected to EAGLE. The core should be ignored, it has no impact on traffic running from EPAP to EAGLE.</p>
30. <input type="checkbox"/>	<p><b>MPS B:</b> Verify the Upgrade.</p>	<p><b>\$ grep "Upgrade returned success" /var/TKLC/log/upgrade/upgrade.log</b></p> <p>Verify that the message "Upgrade returned success!" is displayed. If it is not, contact My Oracle Support following the instructions on the front page or the instructions in the <b>My Oracle Support</b> section.</p> <p>1400786220:: Upgrade returned success!</p>
31. <input type="checkbox"/>	<p><b>MPS B:</b> Verify that it is an Incremental Upgrade or Major upgrade</p>	<p>Check Procedure 2, Steps 7 and 8. If the upgrade type is a Major upgrade, proceed with the following step. If it's Incremental, proceed to step 33.</p>
32. <input type="checkbox"/>	<p><b>MPS B:</b> Enable syscheck fs module.</p>	<p>Run the following command to enable the syscheck fs module.</p> <p><b>\$ sudo syscheckAdm --enable disk fs</b></p>
33. <input type="checkbox"/>	<p><b>MPS B:</b> Upgrade is complete. Verify Health of MPS B</p>	<p>Follow <a href="#">Procedure A.1</a> on MPS B to verify the health of MPS B.</p> <p>If this is a Major Upgrade, the syscheck utility will report the "3000000000000002 – Server Internal Disk Error" alarm as the disk mirroring is in progress. The alarm will be cleared after the completion of disk mirroring.</p> <p>Also, the syscheck utility will report the "5000000000000002 - Server Application Process Error" alarm as the Epap processes are not running after the upgrade.</p> <p>Verify that no unexpected alarms are noted.</p> <p>Note: Disk mirroring does not start until the upgrade is accepted.</p> <p>If it is major upgrade Proceed with 0 to upgrade SSL certificate.</p>
34. <input type="checkbox"/>	<p><b>MPS B:</b> Verify that if alarm to accept upgrade is present.</p>	<p>To verify alarm to accept upgrade execute following command:</p> <p><b>\$ alarmMgr --alarmStatus   grep tpdServerUpgradePendingAccept</b></p> <p>Following output shall be observed:</p>

## Procedure 18: Upgrade Server B

		<p>SEQ: 5 UPTIME: 112 BIRTH: 1498203542 TYPE: SET ALARM: TKSPLATMI33 tpdServerUpgradePendingAccept 1.3.6.1.4.1.323.5.3.18.3.1.3.33 32532  Processing Error Configuration Error</p> <p>Note: Disk mirroring does not start until the upgrade is accepted.</p>
<p>35.</p> <p><input type="checkbox"/></p>	<p><b>MPS B:</b> Update ssh_config to disable MD5 and MAC algorithm for security</p>	<p>Perform the following steps to disable unsecure algorithm for ssh:</p> <ol style="list-style-type: none"> <li>1. <code>\$ grep "MACs hmac-md5,hmac-md5-96," /etc/ssh/ssh_config</code> If output contains "MACs hmac-md5,hmac-md5-96", execute the below steps 2 and 3. Else go to step 4.</li> <li>2. <code>\$ sudo rcstool co /etc/ssh/ssh_config</code></li> <li>3. <code>\$ sudo sed -i -e '/MACs hmac-md5,hmac-md5-96,hmac-sha1-96/d' /etc/ssh/ssh_config</code></li> <li>4. <code>\$ sudo rcstool ci /etc/ssh/ssh_config</code></li> <li>4. <code>\$ grep "MACs hmac-sha2-256,hmac-sha2-512" /etc/ssh/sshd_config</code> If no output is displayed for above command continue to next command in step 5 and 6 else skip these steps</li> <li>5. <code>\$ sudo rcstool co /etc/ssh/sshd_config</code></li> <li>6. <code>\$ sudo sed -i '\$ a \\tMACs hmac-sha2-256,hmac-sha2-512' /etc/ssh/sshd_config</code></li> <li>7. <code>\$ sudo rcstool ci /etc/ssh/sshd_config</code></li> <li>8. <code>\$ sudo systemctl restart sshd</code></li> </ol>
<p>36.</p> <p><input type="checkbox"/></p>	<p>Update the httpd.conf file to disable the Cache control no-store policy.</p>	<p>Perform the following steps to disable Cache control no-store policy:</p> <ol style="list-style-type: none"> <li>1. <code>\$ grep "Header set Cache-Control no-store" /etc/httpd/conf/httpd.conf</code> If the output contains "Header set Cache-Control no-store", Execute the below steps. If no output is displayed for the above command, skip the steps mentioned below.</li> <li>2. <code>\$ sudo sed -i '/Cache-Control no-store/c\#Header set Cache-Control no-store' /etc/httpd/conf/httpd.conf</code></li> <li>3. <code>\$ grep "Header set Cache-Control no-store" /etc/httpd/conf/httpd.conf</code></li> </ol>

### Procedure 18: Upgrade Server B

		The output should be "#Header set Cache-Control no-store" showing that the line has been commented.  <b>4. \$ sudo systemctl restart httpd</b>
37. <input type="checkbox"/>	Reconnect console cable.	On E5-APP-B card, reconnect the console cable between the serial port labeled 'S0' on E5-APP-B B card's adapter and the serial port labeled 'S1' on the E5-APP-B A card's adapter. <b>Cable part numbers - 830-1220-xx</b>
38. <input type="checkbox"/>	Procedure complete.	Procedure is complete.
39. <input type="checkbox"/>	Note down the timestamp in log.	Run the following command: <b>\$ date</b>

### Procedure 19 Upgrade server A

#### Procedure 19: Upgrade Server A

<b>S T E P #</b>	This procedure upgrades the MPS-A server in the EPAP System.  Check off (✓) each step as it is completed. Boxes have been provided for this purpose under each step number.  IF THIS PROCEDURE FAILS, CONTACT MY ORACLE SUPPORT AND ASK FOR <u>UPGRADE ASSISTANCE</u> .	
	1. <input type="checkbox"/>	<b>MPS A:</b> Determine media available for upgrade.  Perform 0 or use an EPAP ISO image to perform upgrade.
	2. <input type="checkbox"/>	Establish a connection to MPS A.  If access to the MPS servers is not available through an IP network, connect to the E5-APP-B card via the serial port.  For connecting the E5-APP-B A card, disconnect the console cable from the serial port on the E5-APP-B B card's adapter. The cable should be disconnected at the point where it connects to the serial port labeled 'S1' on the E5-APP-B B card's adapter and use it for serial access. <b>Cable part numbers - 830-1220-xx</b>  Skip to step 6, if connected through serial console.
	3. <input type="checkbox"/>	Create a terminal window and establish a connection by logging into MPS B.  Log in to MPS B.  In a newly created terminal window labeled "MPS B", connect directly into MPS B.  <b># ssh epapdev@&lt;MPS B&gt;</b> <b>Password: &lt;password&gt;</b>
	4. <input type="checkbox"/>	<b>MPS B:</b> Start screen session.  Run the following commands to start screen and establish a console session to MPS A.

## Procedure 19: Upgrade Server A

	<p><b>MPS B:</b> Connect to the console of MPS A.</p>	<pre>#su - root Password:  \$ screen -L</pre> <p>Run the following command on E5-APP-B:</p> <pre>\$ sudo minicom mate</pre> <p>If above command fails then refer to Procedure A.24.</p>
5. <input type="checkbox"/>	<p><b>MPS A:</b> Login prompt is displayed.</p>	<pre>&lt;hostname&gt; console login:</pre> <p>Note: Hit enter if no login prompt is displayed.</p>
6. <input type="checkbox"/>	<p><b>MPS A:</b> Log in to the server as the user "epapdev".</p>	<pre>&lt;hostname&gt; console login: epapdev password: &lt;password&gt;</pre>
7. <input type="checkbox"/>	<p><b>MPS A:</b> Verify that it is an Incremental Upgrade. or a Major Upgrade</p>	<p>Check 0, Steps 7 and 8. If the upgrade type is Major upgrade, proceed with the following step. If it's Incremental, proceed to step 10.</p>
8. <input type="checkbox"/>	<p><b>MPS A:</b> Disable syscheck fs module.</p>	<pre>\$ su - root Password:</pre> <p>Run the following command to disable the syscheck fs module.</p> <pre># syscheckAdm --disable disk fs</pre>
9. <input type="checkbox"/>	<p><b>MPS A:</b> Create upgrade.conf for splitting mirrors if this is a Major upgrade.</p>	<p>Create a file (if not already created) and add the line "BACKOUT_TYPE=SPLIT_MIRROR" (to trigger the split mirror upgrade) by executing the following steps:</p> <ol style="list-style-type: none"> <li>1. # vi /usr/TKLC/plat/etc/upgrade/upgrade.conf</li> <li>2.If file already contains some allow listed alarms then append bellow line at the end of the file, otherwise add it to first line:</li> </ol> <pre>BACKOUT_TYPE=SPLIT_MIRROR</pre> <p>NOTE: Not performing this step will prevent any successful backout.</p>

## Procedure 19: Upgrade Server A

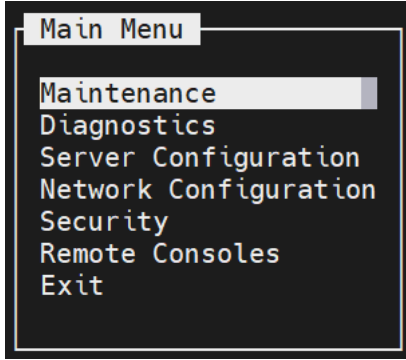
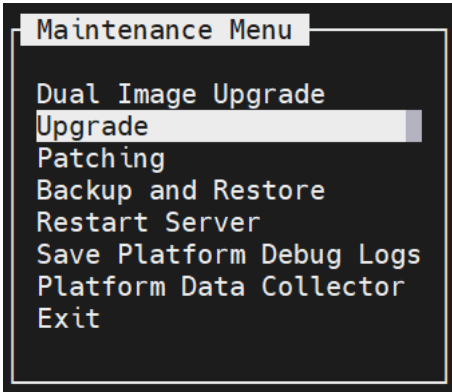
		<p>Run the following command to verify that the above command has been executed successfully:</p> <pre># cat /usr/TKLC/plat/etc/upgrade/upgrade.conf</pre> <p>The output should be:</p> <pre>[root@MPS-B ~]# cat /usr/TKLC/plat/etc/upgrade/upgrade.conf</pre> <pre>BACKOUT_TYPE=SPLIT_MIRROR</pre>
10. <input type="checkbox"/>	<b>MPS A:</b> Execute the platcfg menu.	<pre>\$ su - platcfg</pre>
11. <input type="checkbox"/>	<b>MPS A:</b> Select the Maintenance submenu.	<p>The platcfg <b>Main Menu</b> appears. On the <b>Main Menu</b>, select <b>Maintenance</b> and press <b>[ENTER]</b>.</p>  <p>The screenshot shows a terminal window titled "Main Menu" with a list of options: Maintenance, Diagnostics, Server Configuration, Network Configuration, Security, Remote Consoles, and Exit. The "Maintenance" option is highlighted with a white bar.</p>
12. <input type="checkbox"/>	<b>MPS A:</b> Select the Upgrade submenu.	<p>Select the <b>Upgrade</b> menu and press <b>[ENTER]</b>.</p>  <p>The screenshot shows a terminal window titled "Maintenance Menu" with a list of options: Dual Image Upgrade, Upgrade, Patching, Backup and Restore, Restart Server, Save Platform Debug Logs, Platform Data Collector, and Exit. The "Upgrade" option is highlighted with a white bar.</p>
13. <input type="checkbox"/>	<b>MPS A:</b> Select the Early Upgrade Checks submenu.	Select the "Early Upgrade Checks" menu to verify that the system is ready for upgrade.

**Procedure 19: Upgrade Server A**

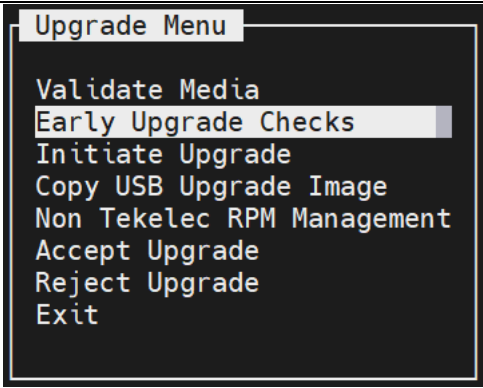
		 <p>If the Early Upgrade Checks fail due to the NTP related alarms, then execute step 15. Otherwise, skip to step 16.</p> <p>Contact My Oracle Support following the instructions on the front page or the instructions in the <b>My Oracle Support</b> section, if the early upgrade checks fail, due to any other reason.</p>
<p>14. <input type="checkbox"/></p>	<p><b>MPS A:</b> Allow List NTP Alarms</p>	<p>1) If the Early Upgrade Checks fail due to the NTP related alarms, then ignore the NTP alarms using the following commands:</p> <ul style="list-style-type: none"> <li>e. Exit the platcfg menu</li> <li>f. Change to root user using the “su –” command.</li> <li>g. <code>vim /usr/TKLC/plat/etc/upgrade/upgrade.conf</code></li> <li>h. Edit the following line to include the NTP related alarms.  <code>EARLY_CHECK_ALARM_WHITELIST=TKSPLATMI2</code></li> </ul> <p>For example – To allowlist the NTP alarm “tpdNTPDaemonNotSynchronizedWarning” which has the alarm code TKLCPLATMI10, the above mentioned line should be edited as  <code>EARLY_CHECK_ALARM_WHITELIST=TKSPLATMI2,TKSPLATMI10</code></p> <p>Note: There should not be any space between two alarms i.e. between TKSPLATMI2 and TKSPLATMI10</p> <p>2) If the Early Upgrade Checks fail due to “Server Default Route Network Error”, then this alarm shall be allowlisted in upgrade.conf file. To allowlist this alarm which has the alarm code TKSPLATMA14, the above mentioned line should be edited as  <code>EARLY_CHECK_ALARM_WHITELIST=TKSPLATMI2,TKSPLATMI10,TKSPLATMA14</code></p>
<p>15. <input type="checkbox"/></p>	<p><b>MPS A:</b> Select Initiate Upgrade.</p>	<p>Select the <b>Initiate Upgrade</b> menu and press [ENTER].</p>

## Procedure 19: Upgrade Server A

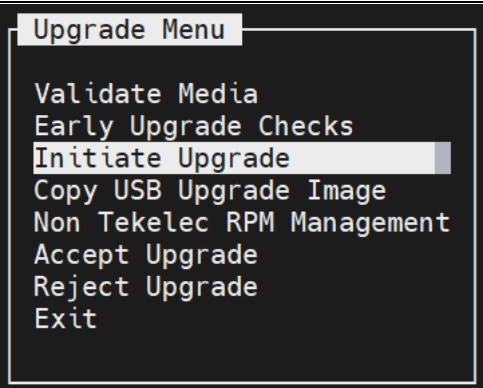
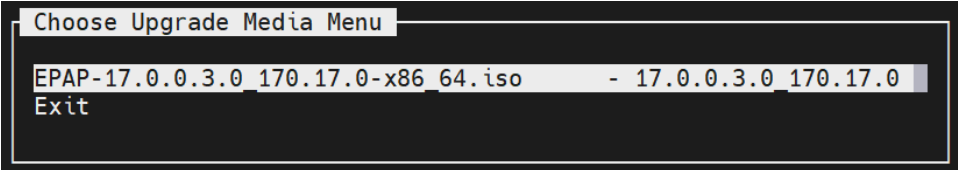
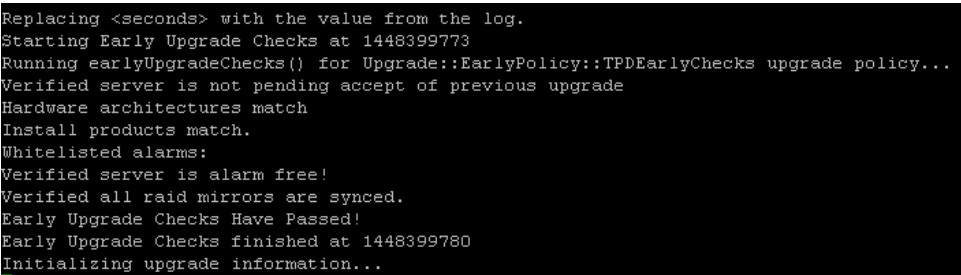
		
<p>16. <input type="checkbox"/></p>	<p><b>MPS A:</b> Select the Upgrade Media.</p>	<p>The screen will display a message that it is searching for upgrade media. Once the upgrade media is found, an Upgrade Media selection menu will be displayed similar to the example shown below.</p> <p>Select the upgrade media on ISO image. There should only be one selection available, as shown in the example below. If there is more than one selection available, contact My Oracle Support following the instructions on the front page or the instructions in the <b>My Oracle Support</b> section.</p> 
<p>17. <input type="checkbox"/></p>	<p><b>MPS A:</b> Upgrade proceeds.</p>	<p>The screen displays the following, indicating that the upgrade software is first running the early upgrade checks, and then proceeding with the upgrade.</p> 
<p>18. <input type="checkbox"/></p>	<p><b>MPS A:</b> Upgrade proceeds.</p>	<p>Many informational messages will come across the terminal screen as the upgrade proceeds.</p> <p>Finally, after upgrade is complete, the server will reboot.</p>

## Procedure 19: Upgrade Server A

<p>19. <input type="checkbox"/></p>	<p><b>MPS A:</b> Upgrade completed.</p>	<p>After the final reboot, Press Enter , the screen will display the login prompt, as shown in the example below.</p> <pre>Starting smartd: [ OK ] Daemon is not running... AlarmMgr daemon is not running, delaying by 1 minute TKLChwmgmtcli stop/pre-start, process 9750                                      TPDhpDiskStatus stop/pre-start, proces s 9782  Oracle Linux Server release 6.9 Kernel 2.6.32-696.20.1.el6prere17.6.0.0.0_88.47.0.x86_64 on an x86_64  Arica-A login: █</pre>
<p>20. <input type="checkbox"/></p>	<p><b>MPS A:</b> Log in to the server as the user "epapdev".</p>	<p><b>&lt;hostname&gt; console login: epapdev</b>  <b>password: &lt;password&gt;</b></p> <p>Note: The SSH login for root shall get enabled after the upgrade.</p>
<p>21. <input type="checkbox"/></p>	<p><b>MPS A:</b> Verify the Upgrade.</p>	<p>Examine the upgrade logs in the directory /var/TKLC/log/upgrade and verify that no errors and warnings were reported. Check 0, Steps 7 and 8 to determine whether it is incremental or major upgrade.</p> <p>If it is major upgrade then consider following</p> <pre>\$ grep -i error /var/TKLC/log/upgrade/upgrade.log</pre> <p><b>Following errors shall be observed:</b></p> <pre>1530712922::ERROR: Config file is currently checked out! 1530712922::ERROR: LOCKED BY: platcfg 1530712922::ERROR: CONFIG: /usr/TKLC/plat/etc/vlan.conf 1530712922::ERROR: ELEMENT: /var/TKLC/rcs/usr/TKLC/plat/etc/vlan.conf,v . . 1530669414::myisamchk: error: 140 when opening MyISAM-table '/var/TKLC/epap/db/pdb/mysql/columns_priv.MYI' 1530669414::myisamchk: error: 140 when opening MyISAM-table '/var/TKLC/epap/db/pdb/mysql/columns_priv.MYI' 1530669414:: 1530669414::----- 1530669414:: 1530669414::myisamchk: error: 140 when opening MyISAM-table '/var/TKLC/epap/db/pdb/mysql/db.MYI' 1530669414::myisamchk: error: 140 when opening MyISAM-table '/var/TKLC/epap/db/pdb/mysql/db.MYI' 1530669414:: 1530669414::----- 1530669414:: 1530669414::myisamchk: error: 140 when opening MyISAM-table '/var/TKLC/epap/db/pdb/mysql/event.MYI' 1530669414::myisamchk: error: 140 when opening MyISAM-table '/var/TKLC/epap/db/pdb/mysql/event.MYI' . . 1528826597::myisamchk: error: 140 when opening MyISAM-table '/var/TKLC/epap/db/appconfig/EuiDB/alarmInfo.MYI'</pre>

## Procedure 19: Upgrade Server A

	<pre> 1528826597::myisamchk: error: 140 when opening MyISAM-table '/var/TKLC/epap/db/appconfig/EuiDB/alarmInfo.MYI' 1528826597::myisamchk: error: 140 when opening MyISAM-table '/var/TKLC/epap/db/appconfig/EuiDB/bannerinfo.MYI' 1528826597::myisamchk: error: 140 when opening MyISAM-table '/var/TKLC/epap/db/appconfig/EuiDB/bannerinfo.MYI' . . 1533053832::Sorry, user root is not allowed to execute '/bin/chown epapdev:epap /var/TKLC/epap/logs/queryServer.log' as root on epap136. 1533053832::Sorry, user root is not allowed to execute '/bin/chown epapdev:epap /var/TKLC/epap/logs/queryServer.log' as root on epap136. . . 530094474::libsemanage.semanage_reload_policy: load_policy returned error code 2 1530094474::libsemanage.semanage_reload_policy: load_policy returned error code 2. . . 1496215832::Error      : Table 'mysql.innodb_index_stats' doesn't exist 1496215832::Error      : Table 'mysql.innodb_table_stats' doesn't exist 1496215832::Error      : Table 'mysql.slave_master_info' doesn't exist 1496215832::Error      : Table 'mysql.slave_relay_log_info' doesn't exist 1496215832::Error      : Table 'mysql.slave_worker_info' doesn't exist 1496215832::Error      : Table 'mysql.innodb_index_stats' doesn't exist 1496215832::Error      : Table 'mysql.innodb_table_stats' doesn't exist 1496215832::Error      : Table 'mysql.slave_master_info' doesn't exist 1496215832::Error      : Table 'mysql.slave_relay_log_info' doesn't exist 1496215832::Error      : Table 'mysql.slave_worker_info' doesn't exist 1496215832::Error      : Table 'mysql.innodb_index_stats' doesn't exist 1496215832::Error      : Table 'mysql.innodb_table_stats' doesn't exist 1496215832::Error      : Table 'mysql.slave_master_info' doesn't exist 1496215832::Error      : Table 'mysql.slave_relay_log_info' doesn't exist 1496215832::Error      : Table 'mysql.slave_worker_info' doesn't exist </pre> <p><b>Following errors shall be observed if upgrade is performed on a setup which was converted from Prov to Non Prov:</b></p> <pre> 1529314607::Error      : Table 'pdb.LicenseInfo' doesn't exist 1529314607::status      : Operation failed 1529314607::pdb.asd 1529314607::Error      : Table 'pdb.asd' doesn't exist 1529314607::status      : Operation failed 1529314607::pdb.bucketContent 1529314607::Error      : Table 'pdb.bucketContent' doesn't exist 1529314607::status      : Operation failed 1529314607::pdb.bucketMap 1529314607::Error      : Table 'pdb.bucketMap' doesn't exist 1529314607::status      : Operation failed 1529314607::pdb.commands 1529314607::Error      : Table 'pdb.commands' doesn't exist 1529314607::status      : Operation failed 1529314607::pdb.dn 1529314607::Error      : Table 'pdb.dn' doesn't exist 1529314607::status      : Operation failed 1529314607::pdb.dn9dig 1529314607::Error      : Table 'pdb.dn9dig' doesn't exist 1529314607::status      : Operation failed 1529314607::pdb.dnB_asd </pre> <p><b>Following statement for missing binary file shall be observed in upgrade.log:</b></p>
--	--

## Procedure 19: Upgrade Server A

	<pre>1530885808::/bin/df: ` /mnt/ugchroot/sys': No such file or directory 1542631084::/upgrade_mysql: line 46: /usr/TKLC/epap/bin/pass_fetch: No such file or directory [NOTE: It is observed only when MySQL upgraded from earlier version than 5.6.18 to version 5.7]  Contact My Oracle Support following the instructions on the front page or the instructions in the <b>My Oracle Support</b> section, if the output contains any error other than the above mentioned errors.  Also note that sometime a carriage return is inserted in the log file causing some of the error messages to appear truncated. This is acceptable and should be ignored.  <b>\$ grep -i warning /var/TKLC/log/upgrade/upgrade.log</b>  Examine the output of the above command to determine if any warnings were reported.  Contact My Oracle Support following the instructions on the front page or the instructions in the <b>My Oracle Support</b> section, if the output contains any warnings beside the following:  1488951825::WARNING: /usr/TKLC/plat/etc/alarms/alarms.xml has been updated...reparsing xml... 1530712185::WARNING: This capability is not defined in the default capabilities. 1530712186::WARNING: Nor is it defined in the current hardware ID's capabilities. 1530712186::WARNING: CAPABILITY: service__disabled 1530712186::WARNING: HARDWARE ID: E5APPB 1530856895::mysql: [warning] Using a password on the command line interface can be insecure. 1530857005::mysql: [warning] Using a password on the command line interface can be insecure. 1488951890::warning:      erase unlink of /lib/modules/2.6.32- 573.18.1.el6prere17. 0.3.0.0_86.44.0.x86_64/weak-updates failed: No such file or directory 1488951902::warning:      erase unlink of /lib/modules/2.6.32- 573.18.1.el6prere17. 0.3.0.0_86.44.0.x86_64/modules.softdep failed: No such file or directory 1488951902::warning:      erase unlink of /lib/modules/2.6.32- 573.18.1.el6prere17. 0.3.0.0_86.44.0.x86_64/modules.order failed: No such file or directory 1488951902::warning:      erase unlink of /lib/modules/2.6.32- 573.18.1.el6prere17. 0.3.0.0_86.44.0.x86_64/modules.networking failed: No such file or directory 1488951902::warning:      erase unlink of /lib/modules/2.6.32- 573.18.1.el6prere17. 0.3.0.0_86.44.0.x86_64/modules.modessetting failed: No such file or directory 1488951902::warning:      erase unlink of /lib/modules/2.6.32- 573.18.1.el6prere17. 0.3.0.0_86.44.0.x86_64/modules.drm failed: No such file or directory 1488951902::warning:      erase unlink of /lib/modules/2.6.32- 573.18.1.el6prere17. 0.3.0.0_86.44.0.x86_64/modules.block failed: No such file or directory 1488951903::kexec-tools          #warning: /etc/kdump.conf created as /etc c/kdump.conf.rpmnew 1488952115::ca-certificates      #####warning: /etc/pki/tls/ce rts/ca-bundle.crt created as /etc/pki/tls/certs/ca-bundle.crt.rpmnew 1488952136::samhain             warning: /etc/samhainrc created as /etc/ samhainrc.rpmnew 1488952138::php-common          #warning: /etc/php.ini created as /etc/p hp.ini.rpmnew</pre>
--	--

## Procedure 19: Upgrade Server A

		<pre> 1488952209::initscripts                ##warning: /etc/sysctl.conf created as /etc/sysctl.conf.rpmnew 1488952260::mysql-commercial-server    warning: /etc/my.cnf created as /etc/my.cnf.rpmnew 1488952291::ntp                          warning: /etc/ntp.conf created as /etc/ntp.conf.rpmnew 1488952302::TKLCPplat                   #####warning: /usr/TKLC/plat/etc/pid_conf created as /usr/TKLC/plat/etc/pid_conf.rpmnew 1488952302::#warning: /usr/TKLC/plat/etc/service_conf created as /usr/TKLC/plat/etc/service_conf.rpmnew 1488952320::TKLCalarms                   ###warning: /usr/TKLC/plat/etc/alarms/alarms.xml saved as /usr/TKLC/plat/etc/alarms/alarms.xml.rpmsave 1488952328::alarmMgr                     ###warning: /usr/TKLC/plat/etc/alarmMgr/alarmMgr.conf created as /usr/TKLC/plat/etc/alarmMgr/alarmMgr.conf.rpmnew 1488952471::WARNING: This capability is not defined in the default capabilities. 1488952471::WARNING: Nor is it defined in the current hardware ID's capabilities . 1488952471::WARNING: CAPABILITY: service__disabled 1488952471::WARNING: HARDWARE ID: E5APPB 1488952602::sudo                          warning: /etc/sudoers created as /etc/sudoers.rpmnew 1488952709::WARNING: /usr/TKLC/plat/etc/alarms/alarms_mps.xml has been updated.. .reparing xml... 1488952718::TKLCepap-HA #####warnin g: group root} does not exist - using root 1488952942::warning: erase unlink of /usr/TKLC/epap/bin/dbMigration failed No such file or directory 1488952949::WARNING: Module variable EXPECTED_CPUS is deprecated! 1488952951::WARNING: CONFIG: /usr/TKLC/plat/lib/Syscheck/modules/system/cpu/conf tg 1488952951::WARNING: Module variable EXPECTED_CPU_ALM is deprecated! 1488952951::WARNING: CONFIG: /usr/TKLC/plat/lib/Syscheck/modules/system/cpu/conf tg  If it is an incremental upgrade then consider following \$ grep -i error /var/TKLC/log/upgrade/upgrade.log  Following errors shall be observed:  1530712922::ERROR: Config file is currently checked out! 1530712922::ERROR: LOCKED BY: platcfg 1530712922::ERROR: CONFIG: /usr/TKLC/plat/etc/vlan.conf 1530712922::ERROR: ELEMENT: /var/TKLC/rcs/usr/TKLC/plat/etc/vlan.conf,v . . 1530669414::myisamchk: error: 140 when opening MyISAM-table '/var/TKLC/epap/db/pdb/mysql/columns_priv.MYI' 1530669414::myisamchk: error: 140 when opening MyISAM-table '/var/TKLC/epap/db/pdb/mysql/columns_priv.MYI' 1530669414::----- 1530669414:: 1530669414::myisamchk: error: 140 when opening MyISAM-table '/var/TKLC/epap/db/pdb/mysql/db.MYI' 1530669414::myisamchk: error: 140 when opening MyISAM-table '/var/TKLC/epap/db/pdb/mysql/db.MYI' 1530669414::----- 1530669414:: 1530669414::myisamchk: error: 140 when opening MyISAM-table '/var/TKLC/epap/db/pdb/mysql/event.MYI' </pre>
--	--	--

## Procedure 19: Upgrade Server A

	<pre> 1530669414::myisamchk: error: 140 when opening MyISAM-table '/var/TKLC/epap/db/pdb/mysql/event.MYI' . . 1528826597::myisamchk: error: 140 when opening MyISAM-table '/var/TKLC/epap/db/appconfig/EuiDB/alarmInfo.MYI' 1528826597::myisamchk: error: 140 when opening MyISAM-table '/var/TKLC/epap/db/appconfig/EuiDB/alarmInfo.MYI' 1528826597::myisamchk: error: 140 when opening MyISAM-table '/var/TKLC/epap/db/appconfig/EuiDB/bannerInfo.MYI' 1528826597::myisamchk: error: 140 when opening MyISAM-table '/var/TKLC/epap/db/appconfig/EuiDB/bannerInfo.MYI' . . 1533053832::Sorry, user root is not allowed to execute '/bin/chown epapdev:epap /var/TKLC/epap/logs/queryServer.log' as root on epap136. 1533053832::Sorry, user root is not allowed to execute '/bin/chown epapdev:epap /var/TKLC/epap/logs/queryServer.log' as root on epap136. . . 530094474::libsemanage.semanage_reload_policy: load_policy returned error code 2 1530094474::libsemanage.semanage_reload_policy: load_policy returned error code 2. . . 1494304768::ERROR: Config file is currently checked out! 1494304781::ERROR: LOCKED BY: platcfg 1494304781::ERROR: CONFIG: /usr/TKLC/plat/etc/vlan.conf 1494304781::ERROR: ELEMENT: /var/TKLC/rcs/usr/TKLC/plat/etc/vlan.conf,v 1496215832::Error : Table 'mysql.innodb_index_stats' doesn't exist 1496215832::Error : Table 'mysql.innodb_table_stats' doesn't exist 1496215832::Error : Table 'mysql.slave_master_info' doesn't exist 1496215832::Error : Table 'mysql.slave_relay_log_info' doesn't exist 1496215832::Error : Table 'mysql.slave_worker_info' doesn't exist 1496215832::Error : Table 'mysql.innodb_index_stats' doesn't exist 1496215832::Error : Table 'mysql.innodb_table_stats' doesn't exist 1496215832::Error : Table 'mysql.slave_master_info' doesn't exist 1496215832::Error : Table 'mysql.slave_relay_log_info' doesn't exist 1496215832::Error : Table 'mysql.slave_worker_info' doesn't exist 1496215832::Error : Table 'mysql.innodb_index_stats' doesn't exist 1496215832::Error : Table 'mysql.innodb_table_stats' doesn't exist 1496215832::Error : Table 'mysql.slave_master_info' doesn't exist 1496215832::Error : Table 'mysql.slave_relay_log_info' doesn't exist 1496215832::Error : Table 'mysql.slave_worker_info' doesn't exist  <b>Following errors shall be observed if upgrade is performed on a setup which was converted from Prov to Non Prov:</b>  1529314607::Error : Table 'pdb.LicenseInfo' doesn't exist 1529314607::status : Operation failed 1529314607::pdb.asd 1529314607::Error : Table 'pdb.asd' doesn't exist 1529314607::status : Operation failed 1529314607::pdb.bucketContent 1529314607::Error : Table 'pdb.bucketContent' doesn't exist 1529314607::status : Operation failed 1529314607::pdb.bucketMap 1529314607::Error : Table 'pdb.bucketMap' doesn't exist 1529314607::status : Operation failed 1529314607::pdb.commands 1529314607::Error : Table 'pdb.commands' doesn't exist </pre>
--	--

## Procedure 19: Upgrade Server A

```
1529314607::status : Operation failed
1529314607::pdb.dn
1529314607::Error : Table 'pdb.dn' doesn't exist
1529314607::status : Operation failed
1529314607::pdb.dn9dig
1529314607::Error : Table 'pdb.dn9dig' doesn't exist
1529314607::status : Operation failed
1529314607::pdb.dnB_asd
```

### Following statement for missing binary file shall be observed in upgrade.log:

```
1530885808::/bin/df: '/mnt/ugchroot/sys': No such file or directory
1542631084::./upgrade_mysql: line 46: /usr/TKLC/epap/bin/pass_fetch: No such
file or directory
```

[NOTE: It is observed only when MySQL upgraded from earlier version than 5.6.18 to version 5.7]

Contact My Oracle Support following the instructions on the front page or the instructions in the **My Oracle Support** section, if the output contains any error other than the above-mentioned errors.

Also note that sometime a carriage return is inserted in the log file causing some of the error messages to appear truncated. This is acceptable and should be ignored.

```
$ grep -i warning /var/TKLC/log/upgrade/upgrade.log
```

Examine the output of the above command to determine if any warnings were reported.

Contact My Oracle Support following the instructions on the front page or the instructions in the **My Oracle Support** section, if the output contains any warnings beside the following:

```
1489042076::WARNING: /usr/TKLC/plat/etc/alarms/alarms.xml has been
updated...rep
arsing xml...
1489042124::warning:      erase unlink of /lib/modules/2.6.32-
642.6.2.e16prere17.4
.0.0.0_88.32.0.x86_64/weak-updates failed: No such file or directory
1489042136::warning:      erase unlink of /lib/modules/2.6.32-
642.6.2.e16prere17.4
.0.0.0_88.32.0.x86_64/modules.order failed: No such file or directory
1489042136::warning:      erase unlink of /lib/modules/2.6.32-
642.6.2.e16prere17.4
.0.0.0_88.32.0.x86_64/modules.networking failed: No such file or directory
1489042136::warning:      erase unlink of /lib/modules/2.6.32-
642.6.2.e16prere17.4
.0.0.0_88.32.0.x86_64/modules.modetesting failed: No such file or directory
1489042136::warning:      erase unlink of /lib/modules/2.6.32-
642.6.2.e16prere17.4
.0.0.0_88.32.0.x86_64/modules.drm failed: No such file or directory
1489042136::warning:      erase unlink of /lib/modules/2.6.32-
642.6.2.e16prere17.4
.0.0.0_88.32.0.x86_64/modules.block failed: No such file or directory
1489042197::WARNING: /usr/TKLC/plat/etc/alarms/alarms_mps.xml has been
updated..
.reparsing xml...
```

Refer to [section 3.7](#) to know more about logging.

## Procedure 19: Upgrade Server A

		<p><b>NOTE:</b> provRMTP core might be observed on EPAP after upgrade, if the EPAP is connected to EAGLE. The core should be ignored, it has no impact on traffic running from EPAP to EAGLE.</p>
22. <input type="checkbox"/>	<p><b>MPS A:</b> Verify the Upgrade.</p>	<p><b>\$ grep "Upgrade returned success" /var/TKLC/log/upgrade/upgrade.log</b></p> <p>Verify that the message "Upgrade returned success!" is displayed. If it is not, contact My Oracle Support following the instructions on the front page or the instructions in the <b>My Oracle Support</b> section.</p> <p>1400793814:: Upgrade returned success!</p>
23. <input type="checkbox"/>	<p><b>MPS A:</b> Verify that it is an Incremental Upgrade. or Major Upgrade</p>	<p>Check 0, Steps 7 and 8. If the upgrade type is Major upgrade, proceed with the following step. If it's Incremental, proceed to step 26.</p>
24. <input type="checkbox"/>	<p><b>MPS A:</b> Enable syscheck fs module.</p>	<p><b>\$ su - root</b> <b>Password:</b></p> <p>Run the following command to enable the syscheck fs module.</p> <p><b># syscheckAdm --enable disk fs</b></p>
25. <input type="checkbox"/>	<p><b>MPS A:</b> Upgrade is complete. Verify Health of MPS A</p>	<p>Follow <a href="#">Procedure A.1</a> on MPS A to verify the health of MPS A.</p> <p>On a Provisionable(mixed-EPAP or PDBonly) MPS, expect that the syscheck utility will alarm the fact that the PDBA software is not running. This will appear as a "5000000000000002 – Server Application Process Error" alarm.</p> <p>If this is a Major Upgrade, the syscheck utility will report the "3000000000000002 – Server Internal Disk Error" alarm as the disk mirroring is in progress.</p> <p>The alarm will be cleared after the completion of disk mirroring.</p> <p>Verify that no unexpected alarms are noted.</p> <p>If it is major upgrade, Proceed with 0 to upgrade SSL certificate.</p>
26. <input type="checkbox"/>	<p><b>MPS A:</b> Verify that if alarm to accept upgrade is present.</p>	<p>To verify alarm to accept upgrade execute following command:</p> <p><b>\$ alarmMgr --alarmStatus   grep tpdServerUpgradePendingAccept</b></p> <p>Following output shall be observed:</p> <p>SEQ: 5 UPTIME: 112 BIRTH: 1498203542 TYPE: SET ALARM: TKSPLATMI33 tpdServerUpgradePendingAccept 1.3.6.1.4.1.323.5.3.18.3.1.3.33 32532  Processing Error Configuration Error</p>

## Procedure 19: Upgrade Server A

		Note: Disk mirroring does not start until the upgrade is accepted.
27. <input type="checkbox"/>	<b>MPS B:</b> Log in as epapdev user.	<hostname> console login: epapdev password: <password>
28. <input type="checkbox"/>	<b>MPS B:</b> Reboot MPS B server.	Reboot MPS-B to disable the root login.  Switch to root user. <b>\$ su – root</b> <b>Password:</b>  Reboot the server: <b>\$ reboot</b>  Wait til the reboot gets completed.
29. <input type="checkbox"/>	<b>MPS A:</b> Enable PDDBA proxy and VIP features.	If PDDBA Proxy Enabled = Yes, in the step 14 of 0, then follow <a href="#">Procedure A.20</a> to enable Epap PDDBA Proxy and VIP Features. Otherwise, skip this step.
30. <input type="checkbox"/>	<b>MPS A:</b> Check services for query server.	<b>\$ epapdb -c queryservers</b>  If query server is not configured i.e. INFO: No Query Server Configured, then skip this step otherwise Execute 6 to restart MYSQL service for PDB on query server.
31. <input type="checkbox"/>	<b>MPS A:</b> Update ssh_config to disable MD5 and MAC algorithm for security	Perform following steps to disable unsecure algorithm for ssh:  <b>1. \$ grep "MACs hmac-md5,hmac-md5-96," /etc/ssh/ssh_config</b> If output contains "MACs hmac-md5,hmac-md5-96", execute the below steps 2 and 3. Else go to step 4. <b>2. \$ sudo rcstool co /etc/ssh/ssh_config</b>  <b>3. \$ sudo sed -i -e '/MACs hmac-md5,hmac-md5-96,hmac-sha1-96/d' /etc/ssh/ssh_config</b>  <b>4.\$ sudo rcstool ci /etc/ssh/ssh_config</b>  <b>4. \$ grep "MACs hmac-sha2-256,hmac-sha2-512" /etc/ssh/sshd_config</b> If no output is displayed for above command continue to next command in step 5 and 6 else skip these steps  <b>5. \$ sudo rcstool co /etc/ssh/sshd_config</b>

## Procedure 19: Upgrade Server A

		<p>6. <code>\$ sudo sed -i '\$ a \\tMACs hmac-sha2-256,hmac-sha2-512' /etc/ssh/sshd_config</code></p> <p>7. <code>\$ sudo rcstool ci /etc/ssh/sshd_config</code></p> <p>8. <code>\$ sudo systemctl restart sshd</code></p>
32.	<p>Update the httpd.conf file to disable the Cache control no-store policy.</p>	<p>Perform the following steps to disable Cache control no-store policy:</p> <p>1. <code>\$ grep "Header set Cache-Control no-store" /etc/httpd/conf/httpd.conf</code></p> <p>If the output contains "Header set Cache-Control no-store", Execute the below steps. If no output is displayed for the above command, skip the steps mentioned below.</p> <p>2. <code>\$ sudo sed -i '/Cache-Control no-store/c\#Header set Cache-Control no-store' /etc/httpd/conf/httpd.conf</code></p> <p>3. <code>\$ grep "Header set Cache-Control no-store" /etc/httpd/conf/httpd.conf</code></p> <p>The output should be "#Header set Cache-Control no-store" showing that the line has been commented.</p> <p>4. <code>\$ sudo systemctl restart httpd</code></p>
33.	<p><input type="checkbox"/> <b>MPS A:</b> If HTTP was enabled for EPAP GUI before upgrade, follow this step otherwise skip it.</p>	<p>If HTTP was enabled before upgrade, follow below mentioned steps.</p> <ul style="list-style-type: none"> <li>• Open EPAP GUI in HTTPS mode.</li> <li>• Navigate to User Administration tab on GUI -&gt; HTTP(S) support -&gt; Change Configuration.</li> <li>• Disable HTTP mode, if it shows HTTP mode as enabled.</li> <li>• Enable the HTTP mode again as shown in image below. The HTTP mode should get enabled successfully. Now you can open the EPAP GUI in HTTP mode.</li> </ul>

**Procedure 19: Upgrade Server A**

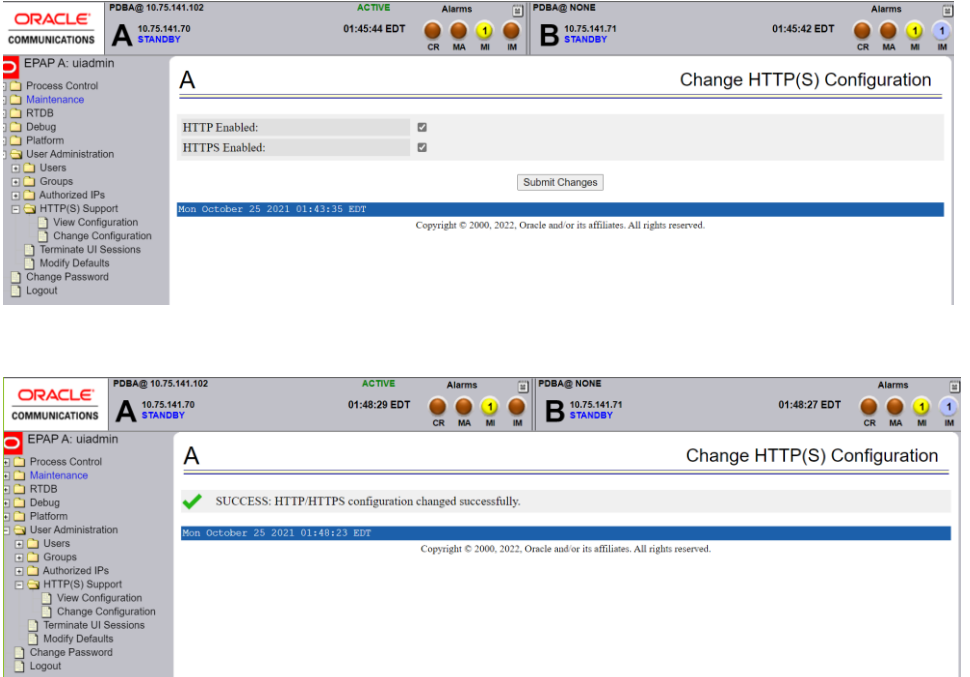
		
<p>34. <input type="checkbox"/></p>	<p>Reconnect console cable.</p>	<p>On E5-APP-B card, reconnect the console cable between the serial port labeled 'S0' on E5-APP-B A card's adapter and the serial port labeled 'S1' on the E5-APP-B B card's adapter. <b>Cable part numbers - 830-1220-xx</b></p>
<p>35. <input type="checkbox"/></p>	<p>Procedure is complete.</p>	<p>Procedure is complete.</p> <p><b>Note: If upgrading an EPAP Provisionable mated pair and you have just completed this procedure for the Local MPS A and MPS B. Repeat the same procedures to upgrade the Remote Pair. See <a href="#">Section 2.1</a> for more information.</b></p>
<p>36. <input type="checkbox"/></p>	<p>Note down the timestamp in log.</p>	<p>Run the following command:</p> <p><b>\$ date</b></p>

## Procedure 20 Run RTDB Converter

### Procedure 20: Run RTDB Converter

<b>S T E P #</b>	<p>This procedure runs RTDB converter to update rtdb database as per new schema. This procedure should not be run on PDBonly setup.</p> <p>Check off (✓) each step as it is completed. Boxes have been provided for this purpose under each step number.</p> <p>IF THIS PROCEDURE FAILS, CONTACT MY ORACLE SUPPORT AND ASK FOR <b>UPGRADE ASSISTANCE</b>.</p> <p><b>**Note: This step can be run simultaneously on MPS A and MPS B</b></p>	
1. <input type="checkbox"/>	<b>MPS A and B:</b> Log in to the server as the user "epapdev".	<pre>&lt;hostname&gt; console login: epapdev password: &lt;password&gt;</pre>
2.	<b>MPS A and B:</b> Switch to root user.	<pre>[epapdev@Ithaca-a ~]\$ su - Password: &lt;password&gt;</pre>
3. <input type="checkbox"/>	<b>MPS A and B:</b> Start EPAP Services	<pre>\$ systemctl start Epap ~~ /etc/init.d/Epap start ~~</pre> <p>"EPAP_RELEASE" is set to "0.617" EPAP application start Successful.</p>
4. <input type="checkbox"/>	<b>MPS A and B:</b> Run RTDB converter script  <b>Note:</b> RTDB softwares need to be running on MPS A & B in order to run the converter.	<pre>\$ cd /usr/TKLC/epap/bin</pre> <p>If system is in compact architecture as noted in step 10 of 0 run below command:  <pre>\$ ./ rtdbEpap164CompactToCompactConvertTool</pre></p> <p>If system is in extreme as noted in step 10 of 0 architecture run below command:  <pre>\$ ./ rtdbEpap164ExtremeToExtremeConvertTool</pre></p> <p><b>Many informational Messages will be displayed on screen. If this script fails contact My Oracle Support.</b></p>
5. <input type="checkbox"/>	Reboot Eagle cards.	Perform the steps in <a href="#">Procedure 21</a> on the Eagle STP connected to the EPAP servers to reload SM cards.
6. <input type="checkbox"/>	Procedure is complete	Procedure is complete.
7. <input type="checkbox"/>	Note down the timestamp in log.	Run the following command: <pre>\$ date</pre>

## Procedure 21 Reboot EAGLE Cards

### Procedure 21: Reboot EAGLE Cards

<b>S T E P #</b>	<p>This procedure reboots EAGLE cards to reload new RTDB.</p> <p>Check off (✓) each step as it is completed. Boxes have been provided for this purpose under each step number.</p> <p><b>IF THIS PROCEDURE FAILS, CONTACT MY ORACLE SUPPORT AND ASK FOR <u>UPGRADE ASSISTANCE</u>.</b></p>	
1. <input type="checkbox"/>	<p><b>EAGLE:</b> reboot all SM cards to reload new RTDB.</p>	<p><b>Note:</b> Before rebooting EAGLE cards, check whether the EPAP software is running or not. If EPAP software is not running then start it manually using the following commands. Execute the below steps on EPAP:</p> <p><b>\$ systemctl status Epap</b></p> <p>Start the EPAP software, if the above command shows that software is not running. If service EPAP shows that software is running, there is no need to run the next command.</p> <p><b>\$ systemctl start Epap</b>          ~~ /etc/init.d/Epap start ~~          EPAP application started.</p> <p>Login onto the connected EAGLE.</p> <p>Reboot 1 SM card on the EAGLE and verify that it comes back to an IS state.</p> <p>Then boot the rest of the EAGLE SM cards over 4 batches (booting 1/4 cards at a single time).</p>
2. <input type="checkbox"/>	<p>Procedure is complete</p>	<p>Procedure is complete.</p>
3. <input type="checkbox"/>	<p>Note down the timestamp in log.</p>	<p>Run the following command:</p> <p><b>\$ date</b></p>

## Procedure 22 Accept Upgrade

**Note: If the upgrade is accepted, Backout cannot be performed.**

### Procedure 22 : Accept upgrade

<b>S T E P #</b>	<p>This procedure accept the upgrade to perform the upgrade process.</p> <p>Check off (✓) each step as it is completed. Boxes have been provided for this purpose under each step number.</p> <p>IF THIS PROCEDURE FAILS, CONTACT MY ORACLE SUPPORT AND ASK FOR <u>UPGRADE ASSISTANCE</u>.</p>	
11. <input type="checkbox"/>	<p><b>MPS:</b> Log in as admusr.</p>	<p>Log in as admusr if not already logged in.</p> <p><b>&lt;hostname&gt; login: admusr</b> <b>Password:</b></p> <p>Note: The console logon may preced by many lines of reboot output.</p>
22. <input type="checkbox"/>	<p><b>MPS:</b> Verify if alarmMgr process running.</p>	<p><b>\$ sudo ls /var/run/alarmMgr</b></p> <p>If the file exists, proceed to the next step. If the file does not exist, contact Oracle Customer Service.</p>
33. <input type="checkbox"/>	<p><b>MPS:</b> Execute the platcfg menu.</p>	<p><b>\$ sudo su – platcfg</b></p>
44. <input type="checkbox"/>	<p><b>MPS:</b> Select the Maintenance submenu.</p>	<p>The platcfg <b>Main Menu</b> appears. On the <b>Main Menu</b>, select <b>Maintenance</b> and press [ENTER].</p> <div style="border: 1px solid black; padding: 10px; margin: 10px auto; width: fit-content;"> <pre> Main Menu ----- Maintenance Diagnostics Server Configuration Network Configuration Security Remote Consoles Exit           </pre> </div>
55. <input type="checkbox"/>	<p><b>MPS:</b> Select the Upgrade submenu.</p>	<p>Select the <b>Upgrade</b> menu and press [ENTER].</p>

**Note: If the upgrade is accepted, Backout cannot be performed.**

**Procedure 22 : Accept upgrade**

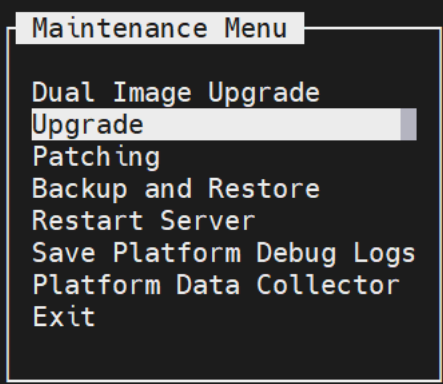
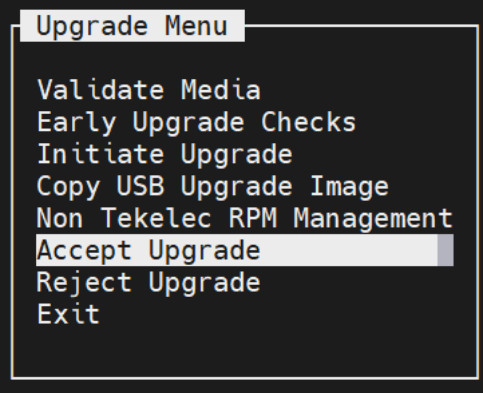
			 <pre>Maintenance Menu Dual Image Upgrade Upgrade Patching Backup and Restore Restart Server Save Platform Debug Logs Platform Data Collector Exit</pre>	
<p>.6. <input type="checkbox"/></p>	<p><b>MPS:</b> Select the Upgrade submenu.</p>	<p>If you have not already accepted the upgrade, do so now, otherwise skip this step.</p>	 <pre>Upgrade Menu Validate Media Early Upgrade Checks Initiate Upgrade Copy USB Upgrade Image Non Tekelec RPM Management Accept Upgrade Reject Upgrade Exit</pre>	

**Note: If the upgrade is accepted, Backout cannot be performed.**

**Procedure 22 : Accept upgrade**

		<pre> Setting POST_UPGRADE_ACTION to ACCEPT in upgrade info. Cleaning backout directory. Cleaning Upgrade Accept/Reject alarm. Cleaning message from MOTD. No patch pending alarm on server so no MOTD update. Cleaning up RPM config backup files ... Checking / Checking /usr Checking /tmp Checking /var Checking /var/TKLC Checking /var/TKLC/epap/rt Checking /var/TKLC/epap/logs Checking /var/TKLC/epap/db Checking /var/TKLC/epap/free Starting cleanup of RCS repository. INFO: Removing '/etc/my.cnf.d/client.cnf' from RCS repository INFO: Removing '/etc/pam.d/system-auth' from RCS repository INFO: Removing '/etc/pam.d/password-auth' from RCS repository  PRESS ANY KEY TO RETURN TO THE PLATCFG MENU. </pre> <p><b>Note:</b> If you still observe the accept upgrade message even after the disks get mirrored properly after accepting the upgrade for the first time, follow the steps mentioned in APPENDIX A.30 to remove the false accept upgrade alarm from the system.</p>
77.	<input type="checkbox"/> Procedure is complete	Procedure is complete.
88.	<input type="checkbox"/> Note down the timestamp in log.	Run the following command: <b>\$ date</b>

## Procedure 23 Keys exchange between active and standby PDB

### Procedure 23: Keys exchange between active PDB and standby PDB

<b>S T E P #</b>	This procedure Exchange the keys between active and remote PDB.		
	Check off (✓) each step as it is completed. Boxes have been provided for this purpose under each step number.		
	IF THIS PROCEDURE FAILS, CONTACT MY ORACLE SUPPORT AND ASK FOR <b>UPGRADE ASSISTANCE</b> .		
	1.	<p><b>MPS A:</b> Log in to Active PDB EPAP as the user "epapdev".</p>	<p>If not already logged in, then log in at MPS A of active PDB EPAP:</p> <pre>&lt;hostname&gt; console login: epapdev password: &lt;password&gt;</pre>
	2. <input type="checkbox"/>	<p><b>MPS A:</b> Verify that PDB entry are present in known_hosts file.</p>	<p>Execute following command to verify that pdb entry present in known_hosts file:</p> <pre>\$ cat .ssh/known_hosts</pre> <p>If entry is present, skip next step.</p>
	3. <input type="checkbox"/>	<p><b>MPS A:</b> Exchange the keys from <b>Active PDB</b></p>	<p>Run the following command on Active PDB:</p> <pre>\$ ssh epapdev@&lt;remote PDB IP&gt; Are you sure you want to continue connecting (yes/no)? &lt;yes&gt; Password:</pre> <p>Snapshot for reference:  <pre>[epapdev@Recife-A ~]\$ ssh epapdev@10.75.141.104 FIPS integrity verification test failed. The authenticity of host '10.75.141.104 (10.75.141.104)' can't be established. RSA key fingerprint is d4:d5:94:c6:57:1a:30:25:bc:b0:67:f9:f7:07:c6:68. Are you sure you want to continue connecting (yes/no)? yes Warning: Permanently added '10.75.141.104' (RSA) to the list of known hosts. epapdev@10.75.141.104's password:</pre></p>
4.	<p><b>MPS A:</b> Log in to Standby PDB EPAP as the user "epapdev".</p>	<p>If not already logged in, then log in at MPS A of standby PDB EPAP:</p> <pre>&lt;hostname&gt; console login: epapdev password: &lt;password&gt;</pre>	
5. <input type="checkbox"/>	<p><b>MPS:</b> Exchange the keys from <b>Standby PDB</b></p>	<p>Repeat the step 2 and step3 to exchange the keys from standby PDB as well.</p>	
6. <input type="checkbox"/>	<p>Procedure is complete</p>	<p>Procedure is complete.</p>	

**Procedure 23: Keys exchange between active PDB and standby PDB**

7. <input type="checkbox"/>	Note down the timestamp in log.	Run the following command: <b>\$ date</b>
--------------------------------	---------------------------------	--

**THIS COMPLETES THE UPGRADE**

## 8 SOFTWARE RECOVERY PROCEDURES

Refer to this section only if there is a problem and it is desired to revert back to the pre-upgrade version of the software.

### 8.1 Backout Setup

The reason to perform a backout has a direct impact on any backout preparation that must be done. Since the reason cannot be known ahead of time, no definitive procedure can be written.

My Oracle Support personnel will have to have login access to the affected MPS server, probe the server for the root cause of the problem, and execute whatever setup or cleanup is necessary in order to prepare the MPS server for backout.

### 8.2 Perform Backout

No matter the initial cause of the upgrade problem, once all necessary corrective steps have been taken to prepare for the backout, then the following procedure can be executed to perform a backout. Refer to [section 2.2](#) and [section 2.4](#) for the Backout process overview.

## Procedure 24 Server B Backout

### Procedure 24: Server B Backout

<b>S T E P #</b>	<p>This procedure provides instructions to perform backout on MPS B server.</p> <p>Check off (✓) each step as it is completed. Boxes have been provided for this purpose under each step number.</p> <p><b>Note: Perform this procedure if only MPS B has been upgraded successfully and MPS A is still at the pre-upgrade release.</b></p> <p><b>Note: If the upgrade has been accepted, this procedure cannot be executed.</b></p>	
<b>1.</b> <input type="checkbox"/>	Terminate all previous connections (ssh).	<p>If not already connected, connect to the E5-APP-B card via the serial port.</p> <p>For connecting the E5-APP-B B card, disconnect the console cable from the serial port on the E5-APP-B A card's adapter. The cable should be disconnected at the point where it connects to the serial port labeled 'S1' on the E5-APP-B A cards adapter and use it for serial access. <b>Cable part numbers - 830-1220-xx</b></p> <p>Skip to step 5, if connected through serial console.</p>
<b>2.</b> <input type="checkbox"/>	Create a terminal window and establish a connection by logging into MPS A.  Log in to MPS A.	<p>In a newly created terminal window labeled "MPS B – from MPS A", connect directly into MPS A.</p> <p><b># ssh admusr@&lt;MPS A&gt;</b>  <b>Password: &lt;password&gt;</b></p>
<b>3.</b> <input type="checkbox"/>	<p><b>MPS A:</b> Verify that the state of PDBA Proxy Feature is No.</p> <p><b>Note:</b> Skip this step for Non-Prov and PDBonly EPAP.</p>	<p><b># sudo su - epapconfig</b></p> <p>warning: Smartmatch is experimental at /usr/TKLC/plat/lib/Security/User.pm line 904.</p>

```

/-----EPAP Configuration Menu-----\
/-----\
| 1 | Display Configuration |
|-----|
| 2 | Configure Network Interfaces Menu |
|-----|
| 3 | Set Time Zone |
|-----|
| 4 | Exchange Secure Shell Keys |
|-----|
| 5 | Change Password |
|-----|
| 6 | Platform Menu |
|-----|
| 7 | Configure NTP Server |
|-----|
| 8 | PDB Configuration Menu |
|-----|
| 9 | Security |
|-----|
| 10 | SNMP Configuration |
|-----|
| 11 | Configure Alarm Feed |
|-----|
| 12 | Configure Query Server |
|-----|
| 13 | Configure Query Server Alarm Feed |
|-----|
| 14 | Configure SNMP Agent Community |
|-----|
| 15 | Mate Disaster Recovery |
|-----|
| e | Exit |
\-----/

```

```

Enter Choice: 1
EPAP A Provisioning Network IP Address = 192.168.61.115
EPAP B Provisioning Network IP Address = 192.168.61.116
Provisioning Network Netmask           = 255.255.255.0
Provisioning Network Default Router    = 192.168.61.1
EPAP A Backup Prov Network IP Address  = Not configured
EPAP B Backup Prov Network IP Address  = Not configured
Backup Prov Network Netmask            = Not configured
Backup Prov Network Default Router     = Not configured
EPAP A Sync Network Address            = 192.168.2.100
EPAP B Sync Network Address            = 192.168.2.200
EPAP A Main DSM Network Address        = 192.168.120.100
EPAP B Main DSM Network Address        = 192.168.120.200
EPAP A Backup DSM Network Address      = 192.168.121.100
EPAP B Backup DSM Network Address      = 192.168.121.200
EPAP A HTTP Port                       = 80
EPAP B HTTP Port                       = 80
EPAP A HTTP SuExec Port                 = 8001
EPAP B HTTP SuExec Port                 = 8001
EPAP A Banner Connection Port           = 8473
EPAP B Banner Connection Port           = 8473

```

**Procedure 24: Server B Backout**

		<p>EPAP A Static NAT Address = Not configured          EPAP B Static NAT Address = Not configured          PDBI Port = 5873          Remote MPS A Static NAT Address = Not configured          Remote MPS A HTTP Port = 80          Local Provisioning VIP = 192.168.15.152          Remote Provisioning VIP = 192.168.15.172          Local PDBA Address = 192.168.15.115          Remote PDBA Address = 192.168.16.115          Remote PDBA B Address = 192.168.16.116          Time Zone = America/New_York          PDB Database = Exists          Preferred PDB = Standby          Allow updates from alternate PDB = Yes          Auto DB Recovery Enabled = Yes          PDBA Proxy Enabled = <b>Yes</b></p> <p>If PDBA Proxy Enabled = Yes then <b>Follow Procedure A.19 on both PDBA Active and Standby for dual PDBA setup to disable EPAP VIP and PDBA proxy features.</b></p> <p>Otherwise, if PDBA Proxy Enabled = No, then proceed with the next step.</p>
<p>4. <input type="checkbox"/></p>	<p><b>MPS A:</b> Clear PDB replication logs</p>	<p>If PDBA Proxy Enabled = Yes then Execute Procedure A.26 to clear replication logs</p> <p>Otherwise, if PDBA Proxy Enabled = No, then skip this step.</p>
<p>5. <input type="checkbox"/></p>	<p><b>MPS A:</b> Start screen session</p> <p><b>MPS A:</b> Connect to the console of MPS B.</p>	<p>Run the following commands to start screen and establish a console session to MPS B.</p> <p><b>\$ screen -L</b></p> <p>Run the following command on E5-APP-B:</p> <p><b>\$ sudo minicom mate</b>          If above command fails then refer to <a href="#">Procedure A.24</a></p>
<p>6. <input type="checkbox"/></p>	<p><b>MPS B:</b> Login prompt is displayed.</p>	<p>&lt;hostname&gt; console login:</p> <p>Note: Hit enter if no login prompt is displayed.</p>
<p>7. <input type="checkbox"/></p>	<p><b>MPS B:</b> Log in to the server as user "admusr".</p>	<p>If not already logged in, then log in.</p> <p>&lt;hostname&gt; console login: admusr          Password: &lt;password&gt;</p>

**Procedure 24: Server B Backout**

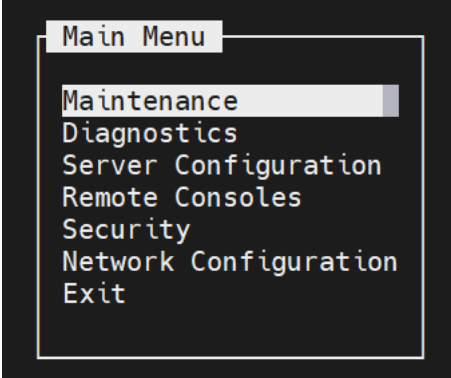
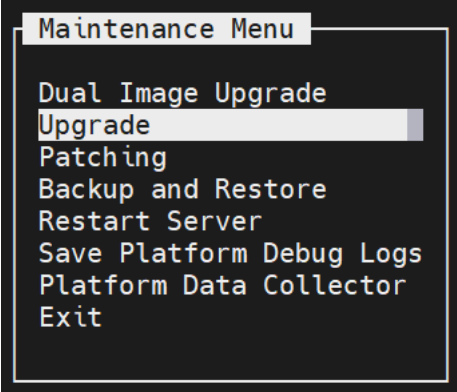
<p>8. <input type="checkbox"/></p>	<p><b>MPS B:</b> Execute the platcfg menu</p>	<p><b>\$ sudo su - platcfg</b></p>
<p>9. <input type="checkbox"/></p>	<p><b>MPS B:</b> Select the Maintenance / Upgrade submenu</p>	<p>The platcfg <b>Main Menu</b> appears. On the <b>Main Menu</b>, select <b>Maintenance</b> and press [ENTER]. Then select <b>Upgrade</b> menu and press [ENTER].</p> <div style="text-align: center;">   </div>
<p>10. <input type="checkbox"/></p>	<p><b>MPS B:</b> Reject Upgrade</p>	<p>Select the "Reject Upgrade" menu and press [ENTER].</p>

**Procedure 24: Server B Backout**

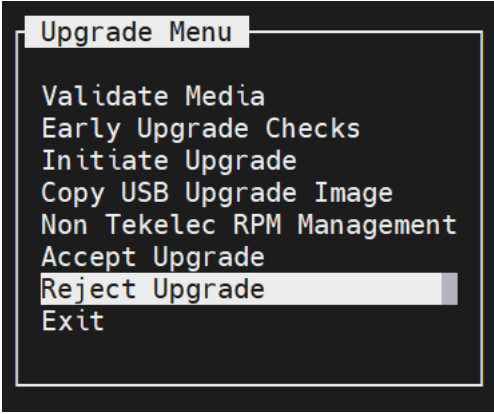
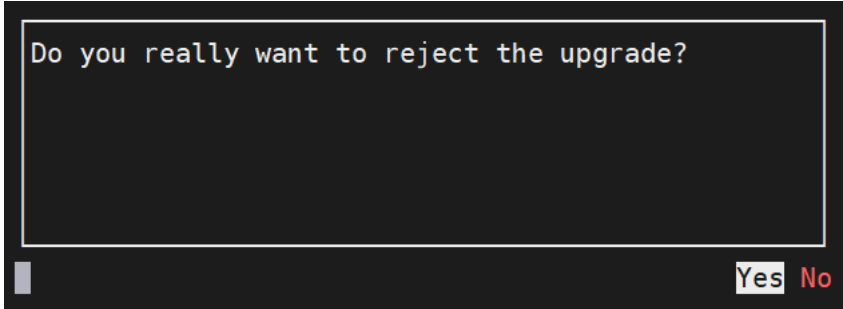
		  <p><b>Note:</b> USB should be removed before initiating the backout on the server otherwise the system will not recover properly and will indicate a drive failure during backout.</p>
<p>11. <input type="checkbox"/></p>	<p><b>MPS B:</b> Backout proceeds.</p>	<p>Many informational messages will come across the terminal screen as the backout proceeds.</p> <p>Finally, after backout is complete, a message will be displayed stating that a reboot is required.</p> <p>The server will be at runlevel 3 and no applications are running. Proceed to the next step to verify the backout and manually reboot the server.</p>
<p>12. <input type="checkbox"/></p>	<p><b>MPS B:</b> Verify the Backout.</p>	<p>Examine the upgrade logs in the directory <code>/var/TKLC/log/upgrade</code> and verify that no errors were reported.</p> <pre># grep -i error /var/TKLC/log/upgrade/upgrade.log</pre> <p>Examine the output of the above commands to determine if any errors were reported.</p> <p>Refer to <a href="#">Section 3.1.16</a> to know more about logging.</p>

## Procedure 24: Server B Backout

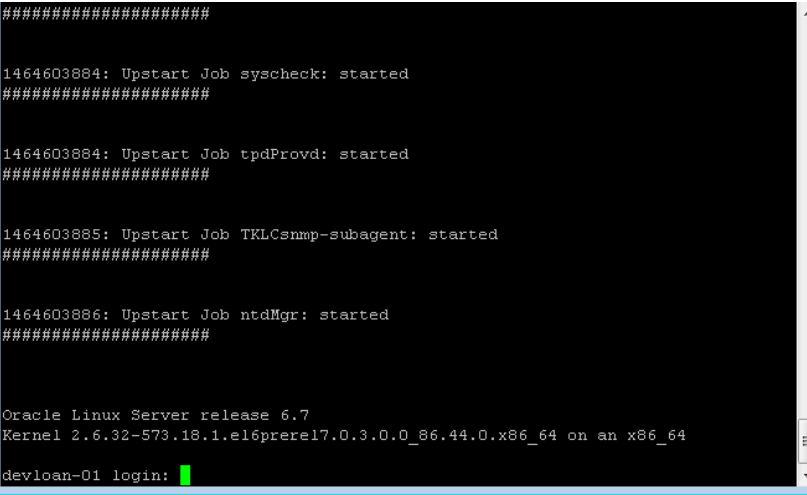
<p>13. <input type="checkbox"/></p>	<p><b>MPS B:</b> Verify the Backout.</p>	<p>If the backout was <i>not</i> successful and errors were recorded in the logs, then contact My Oracle Support following the instructions on the front page or the instructions in the <b>My Oracle Support</b> section for further instructions.</p> <p>If the backout <i>was</i> successful, then continue with the following step.</p>
<p>14. <input type="checkbox"/></p>	<p><b>MPS B:</b> Reboot the MPS.</p>	<p>Perform the following commands to reboot the MPS:</p> <pre># sudo init 6</pre>
<p>15. <input type="checkbox"/></p>	<p><b>MPS B:</b> Reboot completed.</p>	<p>After the reboot, the screen will display the login prompt, as shown in the example below.</p>  <p>The screenshot shows a terminal window with the following text:</p> <pre>##### 1464603884: Upstart Job syscheck: started ##### 1464603884: Upstart Job tpdProvcd: started ##### 1464603885: Upstart Job TKLCsmmp-subagent: started ##### 1464603886: Upstart Job ntdMgr: started ##### Oracle Linux Server release 6.7 Kernel 2.6.32-573.18.1.el6prere17.0.3.0.0_86.44.0.x86_64 on an x86_64 devloan-01 login: █</pre>
<p>16. <input type="checkbox"/></p>	<p><b>MPS B:</b> Verify Health of MPS B.</p>	<p>Follow <a href="#">Procedure A.1</a> on MPS B to verify the health of MPS B.</p>
<p>17. <input type="checkbox"/></p>	<p><b>MPS B:</b> Sync the time on both MPS A and MPS B.</p>	<p>Sync the time on both MPS A and B if it is different.</p> <p>Log in to MPS A:  <b>&lt;hostname&gt; console login: epapdev</b>  <b>Password: &lt;password&gt;</b></p> <p>Check date and time on MPS A using following command:  <pre>\$ date</pre> <pre>Sat Jul 7 01:35:18 EDT 2018</pre></p> <p>Log in to MPS B:  <b>&lt;hostname&gt; console login: epapdev</b>  <b>Password: &lt;password&gt;</b></p> <p>Check date and time on MPS B using following command:</p>

## Procedure 24: Server B Backout

		<pre> \$ date Sat Jul 7 01:35:18 EDT 2018  If both are not the same, then set the date time value on MPS B same as of MPS A. Use following command:  First switch user to root: \$ su - root Password:  Run the command to set date on MPS B as bellow:  # date -s &lt;data-time of MPS A&gt;  [root@Natal-B ~]# date -s "Sat Jul 7 02:05:41 EDT 2018" Sat Jul 7 02:05:41 EDT 2018 [root@Natal-B ~]#  Done. </pre>
<p>18. <input type="checkbox"/></p>	<p><b>MPS B:</b> Clear MySQL replication error banner message, if any</p>	<pre> Run the following command to check for MySQL replication error: \$ manageBannerInfo -l  Examine the output of the above command to determine if any errors were reported related to MySQL replication such as:  MySQL data replication error detected; Attempting to restart. Attempt to restart MySQL replication failed.  Run the following command to copy the EuiDB database from B server to A server to clear any of the above observed MySQL replication error.  <b>Note:</b> This utility should be executed only with epapdev user.  \$ /usr/TKLC/epap/config/resetReplication Resetting MySql Replication This script will fix EuiDB replication by copying the database from one side of the pair to the other side and then resetting the MySql replication pointers. Are you sure you want to reset replication? (y/n) y Which side do you want to copy FROM? (A/B) [B]: B Copy the EuiDB from B to A? (y/n) y Removing the index and info files from EPAP A Replication files successfully removed from the mate server. </pre>

## Procedure 24: Server B Backout

		<p>Connecting to local DB          Connecting to mate DB          Copying EuiDB to mate          Stopping local slave          Stopping mate slave          Resetting local master          Resetting mate master          Resetting local slave          Resetting mate slave          Starting local slave          Starting mate slave          Resetting MySQL Replication Completed</p> <p>If there is a failure in resetReplication, run the following commands:</p> <pre>\$ mysql -uroot -p&lt;MySQL_root_password&gt; -e "GRANT ALL ON EuiDB.* to elapdev@localhost"</pre> <pre>\$ mysql -uroot -p&lt;MySQL_root_password&gt; -e "GRANT ALL ON EuiDB.* to elapdev@mate"</pre> <p>Run the following command to verify that the banner messages related to the replication error are cleared after some time.</p> <pre># manageBannerInfo -l</pre>
<p>19.  <input type="checkbox"/></p>	<p><b>MPS B:</b> Verify Health of MPS B</p>	<p>Follow <a href="#">Procedure A.1</a> on MPS B to verify the health of MPS B. If backout of major upgrade was performed, the syscheck utility will report the "3000000000000002 – Server Internal Disk Error" alarm as the disk mirroring is in progress.</p> <p>The alarm will be cleared after the completion of disk mirroring. May also report the following:</p> <pre>* defaultroute: FAILURE:: MINOR::5000000000040000 -- Platform Health Check Failure * defaultroute: FAILURE:: ping6 return non-zero code. * defaultroute: FAILURE:: MAJOR::3000000000002000 -- Server Default Route Network Error * defaultroute: FAILURE:: The IPv6 default route at fe80::f64e:5ff:fe49:9b7f cannot be pinged!</pre>
<p>20.  <input type="checkbox"/></p>	<p>Reconnect console cable.</p>	<p>On E5-APP-B card, reconnect the console cable between the serial port labeled 'S0' on E5-APP-B B card's adapter and the serial port labeled 'S1' on the E5-APP-B A card's adapter. <b>Cable part numbers - 830-1220-xx</b></p>
<p>21.</p>	<p>Procedure complete.</p>	<p>This procedure is complete.</p>

### Procedure 24: Server B Backout

<input type="checkbox"/>		
22.	Note down the timestamp in log.	Run the following command: <b>\$ date</b>

The application should now be running at the original software release level

### Procedure 25 Backout both Server A and B

#### Procedure 25: Backout both MPS A and B

<b>S T E P #</b>	<p>This procedure provides instructions to perform backout on both MPS A and MPS B servers.</p> <p>Check off (✓) each step as it is completed. Boxes have been provided for this purpose under each step number.</p> <p><b>Note:</b> Perform this procedure only if both MPS A and MPS B have been upgraded or partially upgraded and you wish to backout both servers to the previous version.</p> <p><b>Note:</b> If the upgrade has been accepted, this procedure cannot be performed.</p> <p><b>Note:</b> Database changes post upgrade and before backout might be lost after performing backout procedure</p>	
1. <input type="checkbox"/>	Terminate all previous connections (ssh).	If not already connected, connect to the E5-APP-B card via the serial port.  For connecting the E5-APP-B A card, disconnect the console cable from the serial port on the E5-APP-B B card’s adapter. The cable should be disconnected at the point where it connects to the serial port labeled ‘S1’ on the E5-APP-B B card’s adapter and use it for serial access. <b>Cable part numbers - 830-1220-xx</b>  Skip to step 6, if connected through serial console.
2. <input type="checkbox"/>	Create a terminal window and establish a connection by logging into MPS B.  Log in to MPS B.	In a newly created terminal window labeled “MPS A – from MPS B”, connect directly into MPS B.  <b># ssh admusr@&lt;MPS B&gt;</b> <b>Password: &lt;password&gt;</b>
3. <input type="checkbox"/>	<b>MPS B:</b> Start screen session.	Run the following commands to start screen and establish a console session to MPS A.  <b>\$ screen -L</b>

**Procedure 25: Backout both MPS A and B**

	<p><b>MPS B:</b> Connect to the console of MPS A.</p>	<p>Run the following command on E5-APP-B:</p> <pre><b>\$ sudo minicom mate</b></pre> <p>If above command fails then refer to Procedure A.24.</p>
4. <input type="checkbox"/>	<p><b>MPS A:</b> Log in prompt is displayed.</p>	<pre>&lt;hostname&gt; console login:</pre> <p><b>Note:</b> Hit enter if no login prompt is displayed.</p>
5. <input type="checkbox"/>	<p><b>MPS A:</b> Log in to the server as user "admusr".</p>	<p>Log in as 'admusr'.</p> <pre>&lt;hostname&gt; console login: admusr Password: &lt;password&gt;</pre>
6. <input type="checkbox"/>	<p><b>MPS A:</b> Verify that the state of PDBA Proxy Feature is No.</p> <p><b>Note:</b> Skip this step for Non-Prov and PDBonly EPAP.</p>	<pre># sudo su - epapconfig</pre> <p>warning: Smartmatch is experimental at /usr/TKLC/plat/lib/Security/User.pm line 904.</p>

```

/-----EPAP Configuration Menu-----\
/-----\
| 1 | Display Configuration |
|-----|
| 2 | Configure Network Interfaces Menu |
|-----|
| 3 | Set Time Zone |
|-----|
| 4 | Exchange Secure Shell Keys |
|-----|
| 5 | Change Password |
|-----|
| 6 | Platform Menu |
|-----|
| 7 | Configure NTP Server |
|-----|
| 8 | PDB Configuration Menu |
|-----|
| 9 | Security |
|-----|
| 10 | SNMP Configuration |
|-----|
| 11 | Configure Alarm Feed |
|-----|
| 12 | Configure Query Server |
|-----|
| 13 | Configure Query Server Alarm Feed |
|-----|
| 14 | Configure SNMP Agent Community |
|-----|
| 15 | Mate Disaster Recovery |
|-----|
| e | Exit |
\-----/

```

```

Enter Choice: 1
EPAP A Provisioning Network IP Address = 192.168.61.115
EPAP B Provisioning Network IP Address = 192.168.61.116
Provisioning Network Netmask           = 255.255.255.0
Provisioning Network Default Router    = 192.168.61.1
EPAP A Backup Prov Network IP Address  = Not configured
EPAP B Backup Prov Network IP Address  = Not configured
Backup Prov Network Netmask            = Not configured
Backup Prov Network Default Router     = Not configured
EPAP A Sync Network Address            = 192.168.2.100
EPAP B Sync Network Address            = 192.168.2.200
EPAP A Main DSM Network Address        = 192.168.120.100
EPAP B Main DSM Network Address        = 192.168.120.200
EPAP A Backup DSM Network Address      = 192.168.121.100
EPAP B Backup DSM Network Address      = 192.168.121.200
EPAP A HTTP Port                       = 80
EPAP B HTTP Port                       = 80
EPAP A HTTP SuExec Port                = 8001
EPAP B HTTP SuExec Port                = 8001
EPAP A Banner Connection Port          = 8473
EPAP B Banner Connection Port          = 8473

```

**Procedure 25: Backout both MPS A and B**

		<p>EPAP A Static NAT Address = Not configured          EPAP B Static NAT Address = Not configured          PDBI Port = 5873          Remote MPS A Static NAT Address = Not configured          Remote MPS A HTTP Port = 80          Local Provisioning VIP = 192.168.15.152          Remote Provisioning VIP = 192.168.15.172          Local PDBA Address = 192.168.15.115          Remote PDBA Address = 192.168.16.115          Remote PDBA B Address = 192.168.16.116          Time Zone = America/New_York          PDB Database = Exists          Preferred PDB = Standby          Allow updates from alternate PDB = Yes          Auto DB Recovery Enabled = Yes          PDBA Proxy Enabled = <b>Yes</b></p> <p>If PDBA Proxy Enabled = Yes then <b>Follow <a href="#">Procedure A.19</a> on both PDBA Active and Standby for dual PDBA setup to disable EPAP VIP and PDBA proxy features.</b></p> <p>Otherwise, if PDBA Proxy Enabled = No, then proceed with the next step.</p>
7.	<input type="checkbox"/> <b>MPS A:</b> Clear PDB replication logs	<p>If PDBA Proxy Enabled = Yes, then Execute Procedure A.26 to clear replication the logs.</p> <p>Otherwise, if PDBA Proxy Enabled = No, then skip this step.</p>
8.	<input type="checkbox"/> <b>MPS A:</b> Execute the platcfg menu.	<p><b>\$ sudo su - p]atcfg</b></p>
9.	<input type="checkbox"/> <b>MPS A:</b> Select the Maintenance / Upgrade submenu	<p>The platcfg <b>Main Menu</b> appears.          On the <b>Main Menu</b>, select <b>Maintenance</b> and press [ENTER]. Then select <b>Upgrade</b> menu and press [ENTER].</p> <div data-bbox="794 1464 1246 1839" style="border: 1px solid black; padding: 10px; margin: 10px auto; width: fit-content;"> <pre> Main Menu ----- Maintenance Diagnostics Server Configuration Remote Consoles Security Network Configuration Exit           </pre> </div>

**Procedure 25: Backout both MPS A and B**

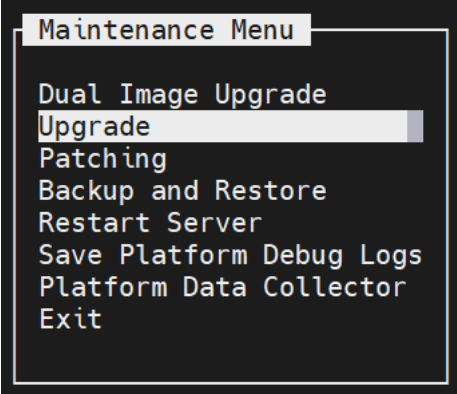
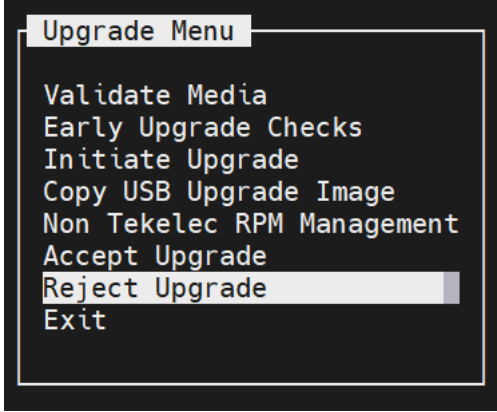
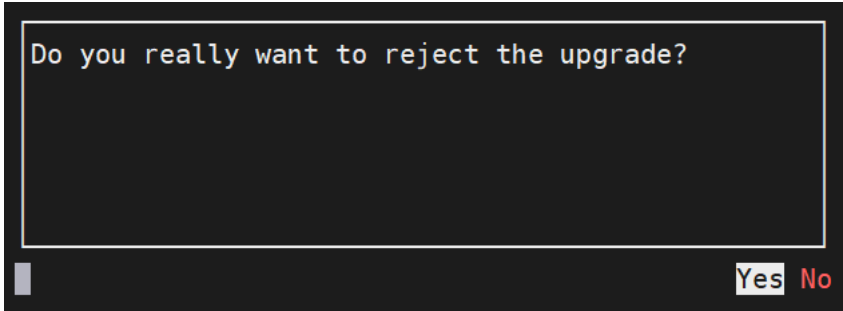
		
<p>10. <input type="checkbox"/></p>	<p><b>MPS A:</b> Reject Upgrade</p>	<p>Select the “Reject Upgrade” menu and press [ENTER].</p>   <p><b>Note:</b> USB should be removed before initiating the backout on the server otherwise the system will not recover properly and will indicate a drive failure during backout.</p>
<p>11. <input type="checkbox"/></p>	<p><b>MPS A:</b> Backout proceeds.</p>	<p>Many informational messages will come across the terminal screen as the backout proceeds.</p>

**Procedure 25: Backout both MPS A and B**

		<p>Finally, after backout is complete, a message will be displayed stating that a reboot is required.</p> <p>The server will be at runlevel 3 and no applications are running. Proceed to the next step to verify the backout and manually reboot the server.</p>
12. <input type="checkbox"/>	<b>MPS A:</b> Verify the Backout.	<p>Examine the upgrade logs in the directory <code>/var/TKLC/log/upgrade</code> and verify that no errors were reported.</p> <pre># grep -i error /var/TKLC/log/upgrade/upgrade.log # grep -i error /var/TKLC/log/upgrade/ugwrap.log</pre> <p>Examine the output of the above commands to determine if any errors were reported.</p> <p>Refer to <a href="#">section 3.7</a> to know more about logging.</p>
13. <input type="checkbox"/>	<b>MPS A:</b> Verify the Backout.	<p>If the backout was <b>not</b> successful and errors were recorded in the logs, then contact My Oracle Support following the instructions on the front page or the instructions in the <b>My Oracle Support</b> section for further instructions.</p> <p>If the backout <b>was</b> successful, then enter continue with the following steps:</p>
14. <input type="checkbox"/>	<b>MPS A:</b> Reboot the MPS.	<p><b>Perform this step only on a backout of an incremental upgrade.</b></p> <p>Perform the following commands to reboot the MPS:</p> <pre># init 6</pre>
15. <input type="checkbox"/>	<b>MPS A:</b> Backout completed.	<p>After the reboot, the screen will display the login prompt, as shown in the example below.</p>

**Procedure 25: Backout both MPS A and B**

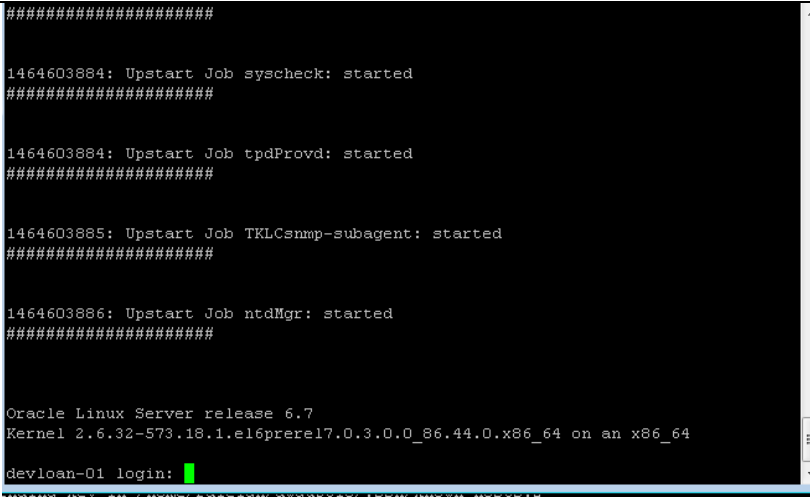
		
<p>16. <input type="checkbox"/></p>	<p><b>MPS A:</b> Verify Health of MPS A.</p>	<p>Follow <a href="#">Procedure A.1</a> on MPS A to verify the health of MPS A</p> <p>The syscheck utility may report the “500000000000002 - Server Application Process Error” for PDBA, if the pdba software is not running.          May also report following error:          * defaultroute: FAILURE:: MINOR::500000000040000 -- Platform Health Check Failure          * defaultroute: FAILURE:: ping6 return non-zero code.          * defaultroute: FAILURE:: MAJOR::300000000002000 -- Server Default Route Network Error          * defaultroute: FAILURE:: The IPv6 default route at fe80::f64e:5ff:fe49:9b7f cannot be pinged!</p>
<p>17. <input type="checkbox"/></p>	<p>Terminate all previous connections (ssh).</p>	<p>If not already connected, connect to the E5-APP-B card via the serial port.</p> <p>For connecting the E5-APP-B B card, disconnect the console cable from the serial port on the E5-APP-B A card’s adapter. The cable should be disconnected at the point where it connects to the serial port labeled ‘S1’ on the E5-APP-B A cards adapter and use it for serial access.</p> <p>Skip to step 21, if connected through serial console.</p>
<p>18. <input type="checkbox"/></p>	<p>Create a terminal window and establish a connection by logging in to MPS A.</p>	<p>In a newly created terminal window labeled “<b>MPS B – from MPS A</b>”, connect directly into MPS A.</p> <pre># ssh epapdev@&lt;MPS A&gt; Password: &lt;password&gt;</pre>

**Procedure 25: Backout both MPS A and B**

	Log in to MPS A.	
19. <input type="checkbox"/>	<p><b>MPS A:</b> Start screen session.</p> <p><b>MPS A:</b> Connect to the console of MPS B.</p>	<p>Run the following commands to start screen and establish a console session to MPS B.</p> <p><b>\$ screen -L</b></p> <p>Run the following command on E5-APP-B:</p> <p><b>\$ sudo minicom mate</b></p> <p>If above command fails then refer to Procedure A.24.</p>
20. <input type="checkbox"/>	<p><b>MPS B:</b> Login prompt is displayed.</p>	<p>&lt;hostname&gt; console login:</p> <p>Note: Hit enter if no login prompt is displayed.</p>
21. <input type="checkbox"/>	<p><b>MPS B:</b> Log in to the server as user "epapdev".</p>	<p>&lt;hostname&gt; console login: <b>admusr</b></p> <p>Password: &lt;password&gt;</p>
22. <input type="checkbox"/>	<p><b>MPS B:</b> Execute the platcfg menu</p>	<p><b>\$ sudo su - platcfg</b></p>
23. <input type="checkbox"/>	<p><b>MPS B:</b> Select the Maintenance/Upgrade submenu</p>	<p>The platcfg <b>Main Menu</b> appears.</p> <p>On the <b>Main Menu</b>, select <b>Maintenance</b> and press [ENTER]. Then select <b>Upgrade</b> menu and press [ENTER].</p> <div data-bbox="790 1243 1241 1624" data-label="Image"> <pre> Main Menu ----- Maintenance Diagnostics Server Configuration Remote Consoles Security Network Configuration Exit </pre> </div>

**Procedure 25: Backout both MPS A and B**

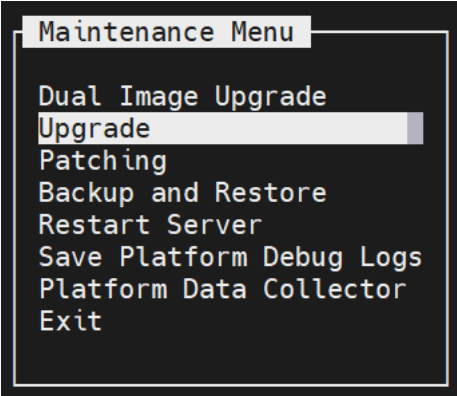
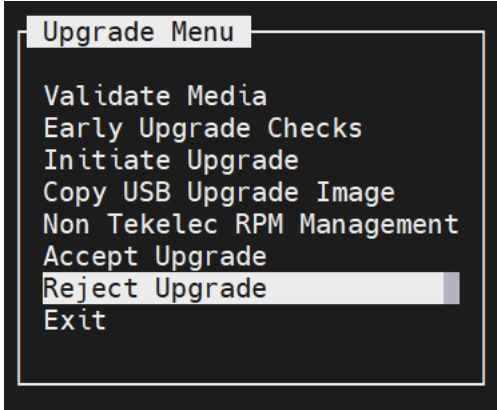
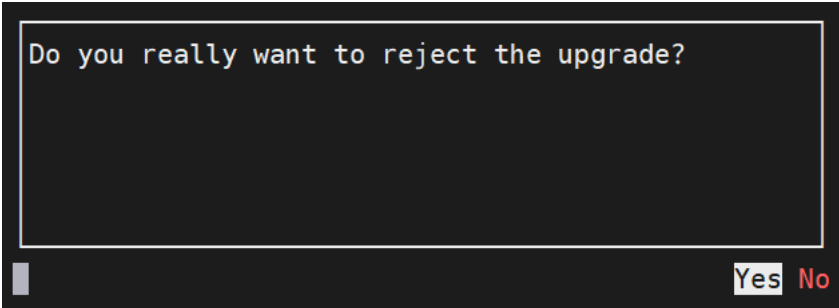
		
<p>24. <input type="checkbox"/></p>	<p><b>MPS B: Reject Upgrade</b></p>	<p>Select the "Reject Upgrade" menu and press [ENTER].</p>   <p><b>Note:</b> USB should be removed before initiating the backout on the server otherwise the system will not recover properly and will indicate a drive failure during backout.</p>
<p>25. <input type="checkbox"/></p>	<p><b>MPS B: Backout proceeds.</b></p>	<p>Many informational messages will come across the terminal screen as the backout proceeds.</p>

**Procedure 25: Backout both MPS A and B**

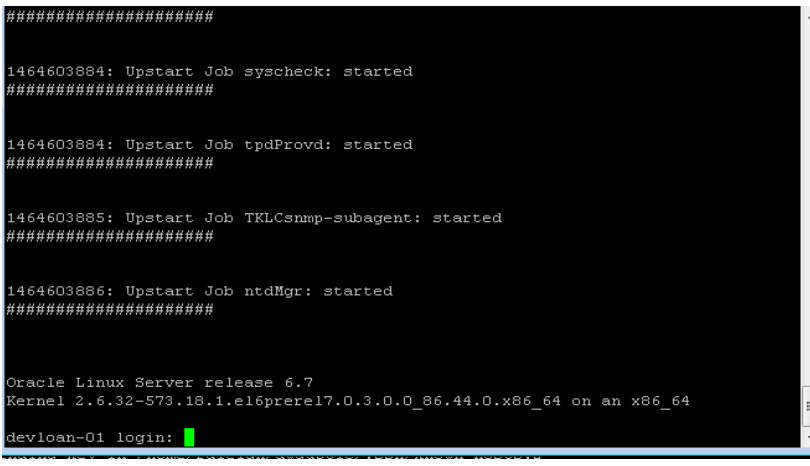
		<p>Finally, after backout is complete, a message will be displayed stating that a reboot is required.</p> <p>The server will be at runlevel 3 and no applications are running. Proceed to the next step to verify the backout and manually reboot the server.</p>
<p>26. <input type="checkbox"/></p>	<p><b>MPS B:</b> Verify the Backout.</p>	<p>Examine the upgrade logs in the directory <code>/var/TKLC/log/upgrade</code> and verify that no errors were reported.</p> <pre># grep -i error /var/TKLC/log/upgrade/upgrade.log # grep -i error /var/TKLC/log/upgrade/ugwrap.log</pre> <p>Examine the output of the above commands to determine if any errors were reported.</p> <p>Refer to <a href="#">section 3.7</a> to know more about logging.</p>
<p>27. <input type="checkbox"/></p>	<p><b>MPS B:</b> Verify the Backout.</p>	<p>If the backout was <b>not</b> successful and errors were recorded in the logs, then contact My Oracle Support following the instructions on the front page or the instructions in the <b>My Oracle Support</b> section for further instructions.</p> <p>If the backout <b>was</b> successful, then enter continue with the following steps:</p>
<p>28. <input type="checkbox"/></p>	<p><b>MPS B:</b> Reboot the MPS.</p>	<p>Perform the following commands to reboot the MPS:</p> <pre>\$ init 6</pre>
<p>29. <input type="checkbox"/></p>	<p><b>MPS B:</b> Log in to MPS B.</p>	<p>After the reboot, the screen will display the login prompt, as shown in the example below.</p>  <pre>##### 1464603884: Upstart Job syscheck: started ##### 1464603884: Upstart Job tpdProvcd: started ##### 1464603885: Upstart Job TKLCsmop-subagent: started ##### 1464603886: Upstart Job ntdMgr: started ##### Oracle Linux Server release 6.7 Kernel 2.6.32-573.18.1.el6prere17.0.3.0.0_86.44.0.x86_64 on an x86_64 devloan-01 login: █</pre>

**Procedure 25: Backout both MPS A and B**

<p>30. <input type="checkbox"/></p>	<p>Create a terminal window and establish a connection by logging into MPS A.</p> <p>Log in to MPS A</p>	<p>In a newly created terminal window labeled "MPS B – from MPS A", connect directly into MPS A.</p> <pre># ssh epapdev@&lt;MPS A&gt; Password: &lt;password&gt;</pre>
<p>31. <input type="checkbox"/></p>	<p><b>MPS A:</b> Rejoin previous screen session on MPS B</p>	<p>Run the following command to disconnect and then rejoin previous screen session:</p> <pre>\$ screen -dr</pre>
<p>32. <input type="checkbox"/></p>	<p><b>MPS B:</b> Sync the time on both MPS A and MPS B.</p>	<p>Sync the time on both MPS A and B if it is different.</p> <p>Log in to MPS A:</p> <pre>&lt;hostname&gt; console login: epapdev Password: &lt;password&gt;</pre> <p>Check date time on MPS A using following command:</p> <pre>\$ date Sat Jul 7 01:35:18 EDT 2018</pre> <p>Log in to MPS B:</p> <pre>&lt;hostname&gt; console login: epapdev Password: &lt;password&gt;</pre> <p>Check date time on MPS B using following command:</p> <pre>\$ date Sat Jul 7 01:35:18 EDT 2018</pre> <p>If both are not same then set the date time value on MPS B same as of MPS A. Use following command:</p> <p>First switch user to root:</p> <pre>\$ su - root Password:</pre> <p>Execute command to set date on MPS B as bellow:</p> <pre># date -s &lt;data-time of MPS A&gt;</pre> <pre>[root@Natal-B ~]# date -s "Sat Jul 7 02:05:41 EDT 2018" Sat Jul 7 02:05:41 EDT 2018 [root@Natal-B ~]#</pre>

**Procedure 25: Backout both MPS A and B**

		Done.
33. <input type="checkbox"/>	<b>MPS B:</b> Log in to the server as user "epapdev".	<code>&lt;hostname&gt; console login: epapdev</code> <code>Password: &lt;password&gt;</code>
34. <input type="checkbox"/>	<b>MPS B:</b> Clear MySQL replication error banner message, if any	<p>Run the following command to check for MySQL replication error:</p> <pre>\$ manageBannerInfo -l</pre> <p>Examine the output of the above command to determine if any errors were reported related to MySQL replication such as:</p> <pre>MySQL data replication error detected; Attempting to restart Attempt to restart MySQL replication failed</pre> <p>Run the following command to copy the EuiDB database from B server to A server to clear any of the above observed MySQL replication error.</p> <p>Note: This utility should be executed only with epapdev user</p> <pre>\$ /usr/TKLC/epap/config/resetReplication Resetting MySql Replication This script will fix EuiDB replication by copying the database from one side of the pair to the other side and then resetting the MySql replication pointers. Are you sure you want to reset replication? (y/n) y Which side do you want to copy FROM? (A/B) [B]: B Copy the EuiDB from B to A? (y/n) y Removing the index and info files from EPAP A Replication files successfully removed from the mate server. Connecting to local DB Connecting to mate DB Copying EuiDB to mate Stopping local slave Stopping mate slave Resetting local master Resetting mate master Resetting local slave Resetting mate slave Starting local slave Starting mate slave Resetting MySql Replication Completed</pre> <p>If there is a failure in resetReplication, execute following commands:</p> <pre>\$ mysql -uroot -p&lt;MySQL_root_password&gt; -e "GRANT ALL ON EuiDB.* to e1apdev@localhost IDENTIFIED by '&lt;password&gt;'"  \$ mysql -uroot -p&lt;MySQL_root_password&gt; -e "GRANT ALL ON EuiDB.* to e1apdev@mate IDENTIFIED by '&lt;password&gt;'"</pre> <p>Run the following command to verify that the banner messages related to the replication error are cleared after some time.</p>

**Procedure 25: Backout both MPS A and B**

		<b>\$ manageBannerInfo -1</b>
35. <input type="checkbox"/>	<b>MPS B:</b> Verify Health of MPS B	Follow <a href="#">Procedure A.1</a> on MPS B to verify the health of MPS B.
36. <input type="checkbox"/>	<p><b>MPS A:</b> Check if RTDB and PDBA databases are synchronized. - update this</p> <p><b>Note: Skip this step for PDBonly setup.</b></p>	<p>Run the following command to check the RTDB and PDB database levels: <b>\$ sudo dbstattool</b></p> <p>The outlook may look like:</p> <pre> DBSTATTOOL Platform=EPAP ----- pdb_birthdate           = 1399621904 (Fri May  9 03:51:44 2014) pdb_level               = 1 rtdb_pdb_birthdate     = 1399621904 (Fri May  9 03:51:44 2014) rtdb_begin_dsm_level   = 1 rtdb_end_dsm_level     = 1 rtdb_dsm_birthdate     = 1400784912 (Thu May 22 14:55:12 2014) rtdb_dsm_status        = 1 rtdb_load_state        = 0 EAGLE_fmt_pdb_birthdate = 2152386348 (EAGLE format - be careful!) EAGLE_fmt_rtdb_pdb_birthdate = 1981720860 (EAGLE format - be careful!) EAGLE_fmt_rtdb_dsm_birthdate = 4003650604 (EAGLE format - be careful!) pdba_last_upd_ipaddr   = 0 pdba_last_upd_timestamp = 0 (Wed Dec 31 19:00:00 1969) dbstattool_pad1       = 0 dbstattool_pad2       = 0 dbstattool_pad3       = 0 dbstattool_pad4       = 0 dbstattool_timestamp  = 0 (Wed Dec 31 19:00:00 1969) rtdb_version          = 4                     </pre> <p>Note down the RTDB and PDBA database levels. If they are not the same prior to backout, an RTDB reload from PDBA must be performed after backout!</p>
37. <input type="checkbox"/>	Reboot EAGLE Cards.	<p>If the DB levels on EPAP and EAGLE matches and there is no alarm on EAGLE related to “RTDB reload is required”, go to step 37.</p> <p>Reboot 1 SM card on the EAGLE and verify that it comes back to an IS-NR/Active state.</p> <p>If this is a Non-Provisionable EPAP, boot the rest of the EAGLE SM cards over 4 batches (booting 1/4 of the cards at a single time).</p> <p>If this is a Provisionable(mixed EPAP or PDBonly) EPAP, and the second MPS A on which backout has been executed, reboot the rest of the cards on both local and remote sides over 4 batches (booting 1/4 of the cards at a single time).</p>
38. <input type="checkbox"/>	Procedure is complete.	This procedure is complete.
39. <input type="checkbox"/>	Note down the timestamp in log.	<p>Run the following command: <b>\$ date</b></p>

The application should now be running at the original software release level

## Procedure 26 Stop the Pdba software

### Procedure 26: Stop the PDBA Software

<b>S T E P #</b>	<p>This procedure stop the PDBA software before major upgrade. Check off (✓) each step as it is completed. Boxes have been provided for this purpose under each step number.</p> <p><b>IF THIS PROCEDURE FAILS, CONTACT MY ORACLE SUPPORT AND ASK FOR <u>UPGRADE ASSISTANCE</u>.</b></p>	
<p><b>If backout has been performed, then Perform this procedure ONLY after backout on all MPS servers in the entire set of EPAP systems. Otherwise, skip this procedure until all MPS servers have been backed out.</b></p>		
1. <input type="checkbox"/>	<p><b>MPS A:</b> Log in to the server as user "epapdev".</p>	<p><b>&lt;hostname&gt; console login: epapdev</b> <b>Password: &lt;password&gt;</b></p>
2. <input type="checkbox"/>	<p><b>MPS A:</b> Verify Health of MPS A.</p>	<p>If not done already, follow <a href="#">Procedure A.1</a> on MPS A to verify the health of MPS A.</p> <p>Expect that the syscheck utility will report the 'Server Application Process Error' alarm for the fact that the PDBA software is not running. Besides the PDBA not running alarm, verify that no other abnormalities are noted.</p> <p>May also report following error:            * defaultroute: FAILURE:: MINOR::5000000000040000 -- Platform Health Check Failure            * defaultroute: FAILURE:: ping6 return non-zero code.            * defaultroute: FAILURE:: MAJOR::300000000002000 -- Server Default Route Network Error            * defaultroute: FAILURE:: The IPv6 default route at fe80::f64e:5ff:fe49:9b7f cannot be pinged!</p>
3. <input type="checkbox"/>	<p><b>MPS A:</b> Verify that Pdba software running or not.</p>	<p>Run the command below to find if the pdba is running or not:</p> <p><b>\$ ps -aef   grep pdba   grep -v "grep"</b></p> <p>If the output contains an entry for the pdba, as shown below, then move to the next step.</p> <p>[epapdev@MPS A ~]\$ ps -aef   grep "pdba"   grep -v "grep"</p>

## Procedure 26: Stop the PDBA Software

		<pre>epapdev 14165 11068 0 02:59 ? 00:00:07 /opt/TKLCAppl/bin/pdba</pre> <p>Otherwise, skip the next step as Pdba software already stopped.</p>
4. <input type="checkbox"/>	<p><b>MPS A:</b> Turn off the <b>PDBA_REMOTE_PDBI_ALLOWED</b> flag to stop provisioning during upgrade.</p> <p><b>Note: This step must be performed in case of upgrade and PDBA software needs to be restarted, for this change to take effect.</b></p>	<p>Run the command below to find the current status of PDBA_REMOTE_PDBI_ALLOWED flag.</p> <pre>[epapdev@Natal-A ~]\$ uiEdit   grep -i PDBA_REMOTE_PDBI_ALLOWED</pre> <p>Skip this step if output of the above command is "PDBA_REMOTE_PDBI_ALLOWED" is set to "OFF".</p> <p>Turn off the PDBA_REMOTE_PDBI_ALLOWED flag by running below command if output of previous command is blank or not set to "OFF"</p> <pre>[epapdev@Natal-A ~]\$ uiEdit PDBA_REMOTE_PDBI_ALLOWED OFF</pre> <p>"PDBA_REMOTE_PDBI_ALLOWED" is set to "OFF"</p>
5. <input type="checkbox"/>	<p><b>MPS A:</b> Stop the Pdba software.</p>	<p>Run the following command:</p> <pre>[epapdev@Natal-A ~]\$ service Pdba stop</pre> <pre>~~ /etc/init.d/Pdba stop ~~</pre> <p>PDBA application stopped.</p>
6. <input type="checkbox"/>	<p><b>MPS A:</b> Verify that Pdba software running or not</p>	<p>Repeat step 3.</p>
7. <input type="checkbox"/>	<p>Procedure complete.</p>	<p>This procedure is complete.</p>
8. <input type="checkbox"/>	<p>Note down the timestamp in log.</p>	<p>Run the following command:</p> <pre>\$ date</pre>

## Procedure 27 Restart PDBA Software (Post-Backout and Post-Upgrade)

When upgrade is initiated on the first MPS-B, the PDBA software process is stopped on the MPS-A servers configured as **Provisionable**(mixed-EPAP or PDBonly). The PDBA software is intentionally left stopped, and so the operator performing the upgrade must restart the PDBA software after all MPS servers in a set of EPAP systems have been upgraded.

**WARNING:** If a backout of the MPS A and B units is conducted sometime after an upgrade has successfully completed and after Provisioning has been re-enabled, then the only

method of PDB restoration is from backup file. In this case, any new data provisioned since the successful completion of the upgrade will be lost and will need to be re-provisioned.

**Procedure 27: Restart the PDBA Software Post-Backout and Post-Upgrade**

<b>S T E P #</b>	<p>This procedure restarts the PDBA software after upgrade of all associated MPS systems has been completed.</p> <p>Check off (✓) each step as it is completed. Boxes have been provided for this purpose under each step number.</p> <p><b>IF THIS PROCEDURE FAILS, CONTACT MY ORACLE SUPPORT AND ASK FOR <u>UPGRADE ASSISTANCE</u>.</b></p>	
<p><b>If backout has been performed, then Perform this procedure ONLY after backout on all MPS servers in the entire set of EPAP systems. Otherwise, skip this procedure until all MPS servers have been backed out.</b></p>		
1. <input type="checkbox"/>	<p><b>Local MPS A:</b> Log in to the server as user "epapdev".</p>	<p><code>&lt;hostname&gt; console login: epapdev</code>  <b>Password:</b> <code>&lt;password&gt;</code></p>
2. <input type="checkbox"/>	<p><b>Local MPS A:</b> Verify Health of MPS A.</p>	<p>If not done already, follow <a href="#">Procedure A.1</a> on MPS A to verify the health of MPS A.</p> <p>Expect that the syscheck utility will report the 'Server Application Process Error' alarm for the fact that the PDBA software is not running. Besides the PDBA not running alarm, verify that no other abnormalities are noted.</p> <p>May also report following error:          * defaultroute: FAILURE:: MINOR::5000000000040000 -- Platform Health Check Failure          * defaultroute: FAILURE:: ping6 return non-zero code.          * defaultroute: FAILURE:: MAJOR::3000000000002000 -- Server Default Route Network Error          * defaultroute: FAILURE:: The IPv6 default route at fe80::f64e:5ff:fe49:9b7f cannot be pinged!</p>
3. <input type="checkbox"/>	<p><b>MPS A:</b> Turn on the <b>PDBA_REMOTE_PDBI_ALLOWED</b> flag to enable PDB to accept updates from remote PDBI.</p> <p><b>Note: This step must be performed in case of upgrade and PDBA software</b></p>	<p>Run the command below to find the current status of PDBA_REMOTE_PDBI_ALLOWED flag.</p> <pre>[epapdev@Natal-A ~]\$ uiEdit   grep -i PDBA_REMOTE_PDBI_ALLOWED</pre> <p>Turn on the PDBA_REMOTE_PDBI_ALLOWED flag. Skip this step if output of the above command is "PDBA_REMOTE_PDBI_ALLOWED" is set to "ON" or no output is displayed</p> <pre>[epapdev@Natal-A ~]\$ uiEdit PDBA_REMOTE_PDBI_ALLOWED ON</pre> <p>"PDBA_REMOTE_PDBI_ALLOWED" is set to "ON"</p>

## Procedure 27: Restart the PDBA Software Post-Backout and Post-Upgrade

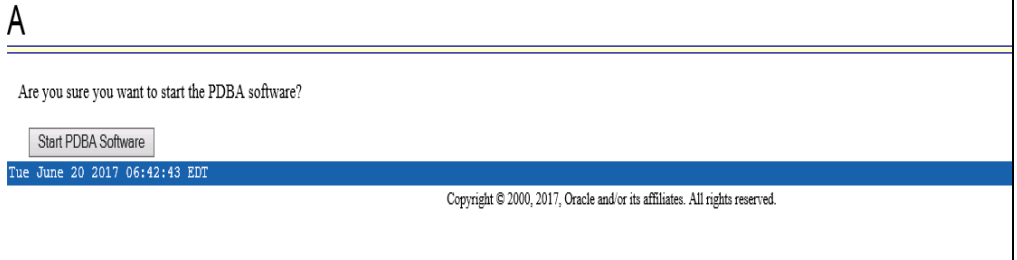
	needs to be restarted, for this change to take effect.	
4.	<b>Move back the pdba binary from pdba_stopped to pdba</b>	[root@Quito-a bin]# mv pdba_stopped pdba [root@Quito-a bin]#
5. <input type="checkbox"/>	<b>Local MPS A:</b> Restart the PDBA software.  On the menu, click PDBA->Process Control->Start PDBA software	Run the command below to find if the pdba is running or not:  <b>\$ ps -aef   grep pdba   grep -v "grep"</b>  If the output contains an entry for the pdba, as shown below, then skip to the next step.  [epapdev@MPS A ~]\$ ps -aef   grep pdba  grep -v "grep" epapdev 23890 10248 0 Apr07 ? 00:01:18 /opt/TKLCAppl/bin/pdba  Otherwise, Log in to EPAP GUI by uiadmin user and start PDBA software.  
6. <input type="checkbox"/>	<b>Local MPS A:</b> Verify PDBA is running.	Follow <a href="#">Procedure A.1</a> on MPS A to verify the health of MPS A Verify that syscheck does <b>not</b> show that the PDBA is <b>not</b> running. May also report following error: * defaultroute: FAILURE:: MINOR::5000000000040000 -- Platform Health Check Failure * defaultroute: FAILURE:: ping6 return non-zero code.
7. <input type="checkbox"/>	<b>Remote MPS A:</b> Log in to the server as user "epapdev".	<b>&lt;hostname&gt; console login: epapdev</b> <b>Password: &lt;password&gt;</b>
8. <input type="checkbox"/>	<b>Remote MPS A:</b> Verify Health of MPS A.	Follow <a href="#">Procedure A.1</a> on MPS A to verify the health of MPS A.  Expect that the syscheck utility will alarm the fact that the PDBA software is not running. This will appear as a "5000000000000002 -- Server Application

**Procedure 27: Restart the PDBA Software Post-Backout and Post-Upgrade**

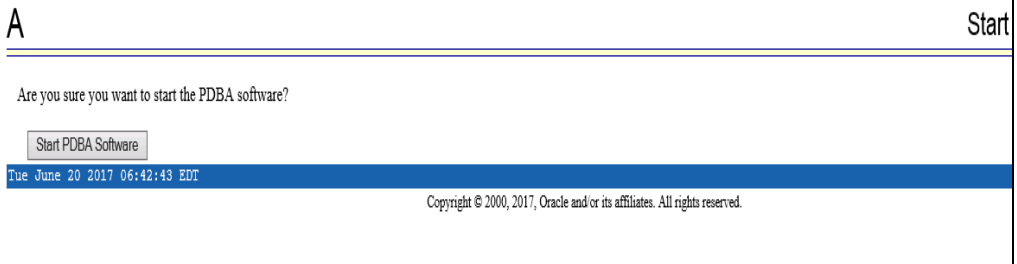
		<p>Process Error” alarm. Besides the PDBA not running alarm, verify that no other abnormalities are noted.          May also report following error:          * defaultroute: FAILURE:: MINOR::5000000000040000 -- Platform Health Check Failure          * defaultroute: FAILURE:: ping6 return non-zero code.          * defaultroute: FAILURE:: MAJOR::3000000000002000 -- Server Default Route Network Error          * defaultroute: FAILURE:: The IPv6 default route at fe80::f64e:5ff:fe49:9b7f cannot be pinged!</p>
9.	<p><input type="checkbox"/> <b>Remote MPS A:</b>          Restart the PDBA software.</p> <p>On the menu, click PDBA-&gt;Process Control-&gt;Start PDBA software</p>	<p>Run the command below to find if the pdba is running or not:  <b>\$ ps -aef   grep pdba   grep -v "grep"</b></p> <p>If the output contains an entry for the pdba, as shown below, then skip to the next step.</p> <pre>epapdev 23890 10248 0 Apr07 ? 00:01:18 /opt/TKLCAppl/bin/pdba</pre> <p>Otherwise, Log in to EPAP GUI by uiadmin user and start PDBA software.</p> 
10.	<p><input type="checkbox"/> <b>Remote MPS A:</b>          Verify PDBA is running.</p>	<p>Follow <a href="#">Procedure A.1</a> on MPS A to verify the health of MPS A. Verify that syscheck does <i>not</i> show that the PDBA is <i>not</i> running.          May also report following error:          * defaultroute: FAILURE:: MINOR::5000000000040000 -- Platform Health Check Failure          * defaultroute: FAILURE:: ping6 return non-zero code          * defaultroute: FAILURE:: MAJOR::3000000000002000 -- Server Default Route Network Error          * defaultroute: FAILURE:: The IPv6 default route at fe80::f64e:5ff:fe49:9b7f cannot be pinged</p>
11.	<p><input type="checkbox"/> Procedure complete.</p>	<p>This procedure is complete.</p>
12.	<p><input type="checkbox"/> Note down the timestamp in log.</p>	<p>Run the following command:</p>

**Procedure 27: Restart the PDBA Software Post-Backout and Post-Upgrade**

		\$ date
--	--	---------

**THIS COMPLETES THE BACKOUT**

## APPENDIX A GENERIC PROCEDURES

### Procedure A.1 Perform System Health Check

#### Appendix A.1 Perform System Health Check

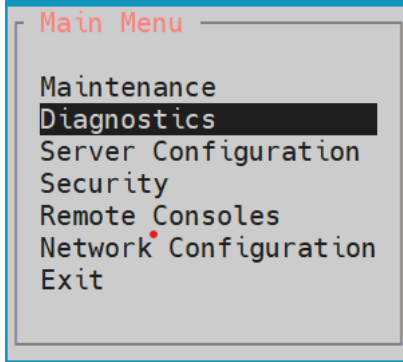
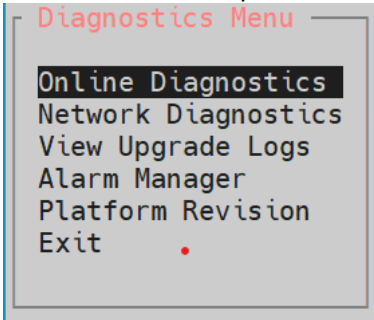
<b>S T E P #</b>	<p>This procedure performs a system health check on any MPS server.</p> <p>Check off (✓) each step as it is completed. Boxes have been provided for this purpose under each step number.</p> <p>IF THIS PROCEDURE FAILS, CONTACT MY ORACLE SUPPORT AND ASK FOR <b>UPGRADE ASSISTANCE</b>.</p>	
1. <input type="checkbox"/>	Log in as the admusr user.	<pre>&lt;hostname&gt; console login: admusr Password: &lt;password&gt;</pre>
2. <input type="checkbox"/>	Execute the platcfg menu.	<pre>\$ sudo su - platcfg</pre>
3. <input type="checkbox"/>	Select the Diagnostics submenu.	<p>The platcfg <b>Main Menu</b> appears. On the <b>Main Menu</b>, select <b>Diagnostics</b> and press [ENTER].</p>  <pre> Main Menu ----- Maintenance Diagnostics Server Configuration Security Remote Consoles Network Configuration Exit     </pre>
4. <input type="checkbox"/>	Select the Online Diagnostics submenu.	<p>Select the <b>Online Diagnostics</b> submenu and press [ENTER].</p>  <pre> Diagnostics Menu ----- Online Diagnostics Network Diagnostics View Upgrade Logs Alarm Manager Platform Revision Exit     </pre>
5. <input type="checkbox"/>	Select the Non-Verbose option.	Select the <b>Non-Verbose</b> option and press [ENTER].



## Appendix A.1 Perform System Health Check

		<p>* defaultroute: FAILURE:: MAJOR::300000000002000 -- Server Default Route Network Error</p> <p>* defaultroute: FAILURE:: The IPv6 default route at fe80::f64e:5ff:fe49:9b7f cannot be pinged</p> <p>If any other failures were detected by System Check, contact My Oracle Support following the instructions on the front page or the instructions in the <b>My Oracle Support</b> section .</p>
8. <input type="checkbox"/>	Server clean-up to create space.	<p>Run the following command:</p> <pre>\$ df -h /var/TKLC</pre> <p>The output may look like:</p> <pre>[root@Quito-a core]# df -h /var/TKLC Filesystem                Size  Used Avail Use% Mounted on /dev/mapper/vgroot-plat_var_tklc 7.8G  2.3G  5.1G 31% /var/TKLC</pre> <p>Verify that there is at least 600M in the Avail column. If not, clean up files until there is space available.</p> <p><b>CAUTION: Make sure you know what files you can remove safely before cleaning up. It is recommended that you only clean up files in the /var/TKLC/upgrade directory as this is a platform owned directory that should only contain ISO images. This directory should not be expected to contain images for any length of time as they can get purged.</b></p> <p>Also, Run the following command to check space in '/lib/module' directory.</p> <pre>\$ df -h /lib/modules</pre> <pre>[root@Quito-a core]# df -h /lib/modules Filesystem                Size  Used Avail Use% Mounted on /dev/mapper/vgroot-plat_usr 7.8G  4.7G  2.8G  64% /usr [root@Quito-a core]#</pre> <p>Verify that the Use% column does not exceed the value 80%.</p>
9. <input type="checkbox"/>	Disk Space Check	<p>Run the command on both Active and Standby PDB:</p> <pre>[root@Arica-A epapa11]# fdisk -l</pre> <pre>Disk /dev/sda: 480.1 GB, 480103981056 bytes 255 heads, 63 sectors/track, 58369 cylinders Units = cylinders of 16065 * 512 = 8225280 bytes</pre>

## Appendix A.1 Perform System Health Check

		<p>Sector size (logical/physical): 512 bytes / 4096 bytes          I/O size (minimum/optimal): 4096 bytes / 4096 bytes          Disk identifier: 0x000df768</p> <p>Compare the Disk Size on both the Standby and Active PDBA. It should be the same on both the sites. <i>Example:</i> It should be the same on both sites, either 480G or 300G. In case both sites have different disk spaces, such as one has 480G and the other has 300G, then contact My Oracle Support by following the instructions on the front page or the instructions in the My Oracle Support section.</p>
10.	<input type="checkbox"/> Procedure complete.	Return to the procedure that you came here from.
11.	<input type="checkbox"/> Note down the timestamp in log.	Run the following command: <b>\$ date</b>

## Procedure A.2 Validate Upgrade Media

This procedure is used to execute a validation of the Upgrade Media (typically an ISO image) separately from executing an upgrade. The upgrade process automatically validates the upgrade media. However, sometime the user may wish to perform just a validation before proceeding with upgrade, thus the reason for this separate process.

Validation could be performed on MPS A or B, however, this procedure specifies MPS X for simplicity.

## Appendix A.2 Validate the Upgrade Media

<b>S T E P #</b>	<p>This procedure provides instructions to perform a validation of the upgrade media on the MPS X server. This procedure assumes that the E5-APP-B card IPM procedure has been executed and the user has an EPAP Upgrade ISO image available.</p> <p>Check off (✓) each step as it is completed. Boxes have been provided for this purpose under each step number.</p> <p><b>IF THIS PROCEDURE FAILS, CONTACT MY ORACLE SUPPORT AND ASK FOR <u>UPGRADE ASSISTANCE</u>.</b></p>	
1.	<input type="checkbox"/> <b>MPS X:</b> If necessary, log in to the server as the user "admusr".	If not already logged in to the MPS server, then log in as user "admusr".  <b>&lt;hostname&gt; console login: admusr            password: &lt;password&gt;</b>
2.	<input type="checkbox"/> <b>MPS X:</b> Execute the platcfg menu.	<b>\$ sudo su - platcfg</b>

## Appendix A.2 Validate the Upgrade Media

<p>3. <input type="checkbox"/></p>	<p><b>MPS X:</b> Select the Maintenance submenu.</p>	<p>The platcfg <b>Main Menu</b> appears. On the <b>Main Menu</b>, select <b>Maintenance</b> and press [ENTER].</p> <div data-bbox="810 369 1217 723" data-label="Image"> <p>A screenshot of a terminal window titled 'Main Menu'. The menu items are: Maintenance (highlighted with a black bar), Diagnostics, Server Configuration, Security, Remote Consoles, Network Configuration, and Exit.</p> </div> <p>In case of Dual Image Upgrade, Select the Dual Image upgrade menu and press [ENTER]</p> <div data-bbox="683 831 1222 1344" data-label="Image"> <p>A screenshot of a terminal window titled 'Maintenance Menu'. The menu items are: Dual Image Upgrade (highlighted with a grey bar), Upgrade, Patching, Backup and Restore, Restart Server, Save Platform Debug Logs, Platform Data Collector, and Exit.</p> </div>
<p>4. <input type="checkbox"/></p>	<p><b>MPS X:</b> Select the Upgrade/Dual Image Upgrade submenu based on the type of Installation.</p>	<p>In case of fresh install, select the <b>Upgrade</b> menu and press [ENTER].</p> <div data-bbox="786 1453 1241 1836" data-label="Image"> <p>A screenshot of a terminal window titled 'Maintenance Menu'. The menu items are: Dual Image Upgrade, Upgrade (highlighted with a black bar), Patching, Backup and Restore, Restart Server, Save Platform Debug Logs, Platform Data Collector, and Exit.</p> </div>

## Appendix A.2 Validate the Upgrade Media

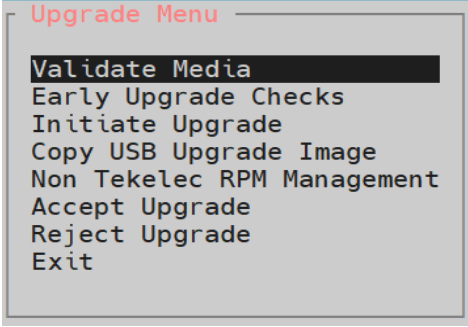
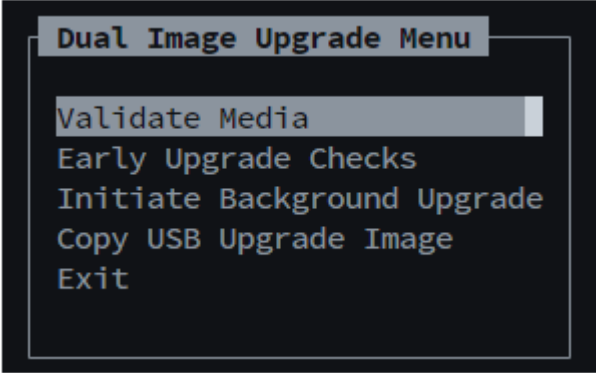
<p>5. <input type="checkbox"/></p>	<p><b>MPS X:</b> Select the Validate Media selection.</p>	<p>Select the <b>Validate Media</b> menu and press [ENTER].</p> <p>In case of Fresh install, you will see the below menu:</p>  <p>In case of Dual Image Upgrade you will see the below menu:</p> 
<p>6. <input type="checkbox"/></p>	<p><b>MPS X:</b> Output from the Validate Media selection.</p>	<p>The screen will display a message that it is searching for upgrade media. Once the upgrade media is found, an Upgrade Media selection menu will be displayed similar to the example shown below.</p> <p>If the upgrade media is not found, follow <a href="#">Procedure A.12</a> to copy the upgrade ISO.</p> <p>Select the upgrade media or ISO image. There should only be one selection available, as shown in the example below. If there is more than one selection available, contact My Oracle Support following the instructions on the front page or the instructions in the <b>My Oracle Support</b> section.</p>

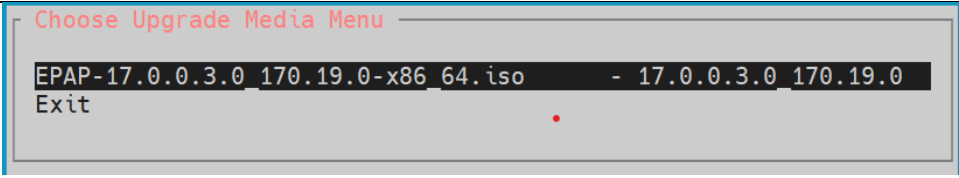

## Appendix A.2 Validate the Upgrade Media

		 <p>The screenshot shows a terminal window titled "Choose Upgrade Media Menu". The menu options are:</p> <pre>EPAP-17.0.0.3.0_170.19.0-x86_64.iso - 17.0.0.3.0_170.19.0 Exit</pre> <p>A red dot is visible below the menu options.</p>
9. <input type="checkbox"/>	<b>MPS X:</b> Procedure complete.	Media Validation is complete. Return to the procedure that you came here from.
10. <input type="checkbox"/>	Note down the timestamp in log.	Run the following command: <b>\$ date</b>

## Procedure A.3 System Configuration Backup

### Appendix A.3 System Configuration Backup

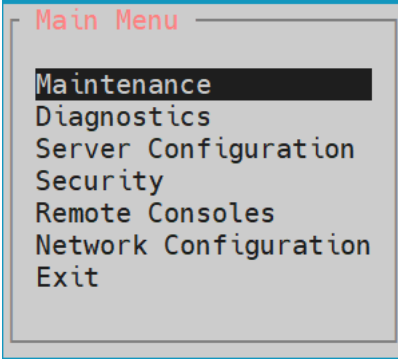
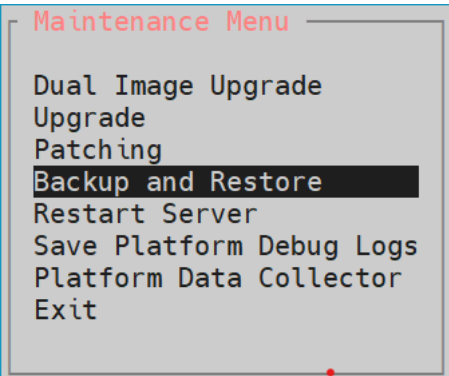
<b>S T E P #</b>	<p>This procedure performs configuration backup on an MPS Server.</p> <p>Check off (✓) each step as it is completed. Boxes have been provided for this purpose under each step number.</p> <p>IF THIS PROCEDURE FAILS, CONTACT MY ORACLE SUPPORT AND ASK FOR <b>UPGRADE ASSISTANCE</b>.</p>	
<b>1.</b> <input type="checkbox"/>	<b>MPS X:</b> If necessary, log in to the server as the user "epapdev".	<p>If not already logged in to the MPS server, then log in as user "admusr".</p> <pre>&lt;hostname&gt; console login: admusr password: &lt;password&gt;</pre>
<b>2.</b> <input type="checkbox"/>	<b>MPS X:</b> Execute the platcfg menu.	<pre>\$ sudo su - platcfg</pre>
<b>3.</b> <input type="checkbox"/>	<b>MPS X:</b> Select the Maintenance submenu.	<p>The platcfg <b>Main Menu</b> appears.</p> <p>On the <b>Main Menu</b>, select <b>Maintenance</b> and press [ENTER].</p>  <p>The screenshot shows a terminal window titled "Main Menu" with the following options: Maintenance (highlighted), Diagnostics, Server Configuration, Security, Remote Consoles, Network Configuration, and Exit.</p>
<b>4.</b> <input type="checkbox"/>	<b>MPS X:</b> Select the Backup Platform submenu.	<p>Select the <b>Backup and Restore</b> menu and press [ENTER].</p>  <p>The screenshot shows a terminal window titled "Maintenance Menu" with the following options: Dual Image Upgrade, Upgrade, Patching, Backup and Restore (highlighted), Restart Server, Save Platform Debug Logs, Platform Data Collector, and Exit.</p>

### Appendix A.3 System Configuration Backup

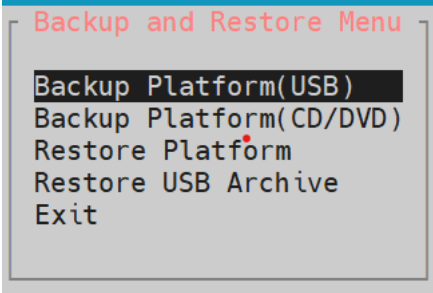
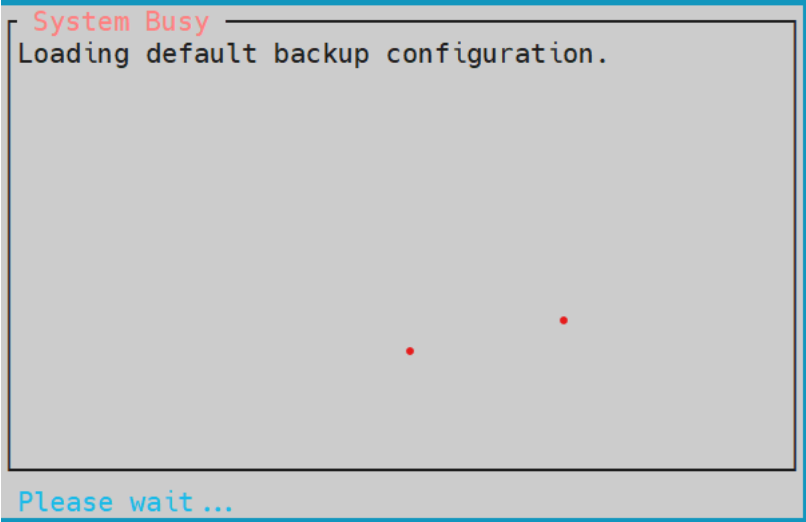
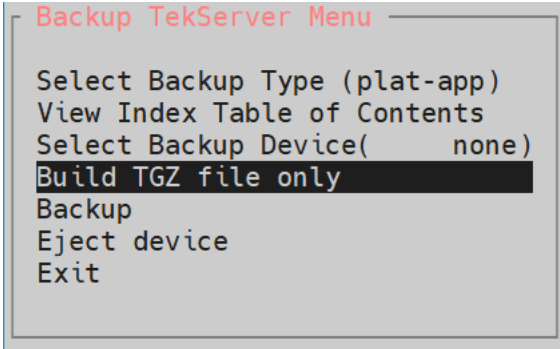
<p>5. <input type="checkbox"/></p>	<p><b>MPS X:</b> Select the Backup Platform submenu.</p>	<p>Select the <b>Backup Platform (USB)</b> submenu and press [ENTER].</p> 
<p>6. <input type="checkbox"/></p>	<p><b>MPS X:</b> Backup continues.</p>	<p>The backup continues. The following busy screen may appear.</p> 
<p>7. <input type="checkbox"/></p>	<p><b>MPS X:</b> Select the Build TGZ file only selection.</p>	<p>Select the <b>Build TGZ file only</b> selection and press [ENTER].</p> 
<p>8. <input type="checkbox"/></p>	<p><b>MPS X:</b> Backup complete – select exit.</p>	<p>Once the TGZ has been created, the “<b>Backup TekServer Menu</b>” will be displayed again.</p>

## Appendix A.3 System Configuration Backup

		Select the Exit option, and keep selecting the Exit option, until you reach the command line prompt.
9. <input type="checkbox"/>	<b>MPS X:</b> Transfer the backup file.	<p>The backup file is in the <code>/var/TKLC/bkp</code> directory and will have a name like <code>&lt;hostname&gt;-plat-app-[date][time].tgz</code></p> <p>Run the following command to view the backup file:  <b>\$ ls -l /var/TKLC/bkp</b></p> <pre>[admusr@Recife-a bkp]\$ ls -l /var/TKLC/bkp/ total 5836 -rw-rw---- 1 root sys 5972128 Sep 11 09:04 Recife-a-plat-app-201809110904.tgz</pre>
10. <input type="checkbox"/>	<b>MPS X:</b> Transfer file to remote machine.	<p>Using SFTP (secure-FTP), transfer the ISO to a remote, customer-provided computer. Enter “yes” when prompted if you want to continue to connect.</p> <p><b>\$ cd /var/TKLC/bkp</b></p> <p><b>\$ sftp &lt;IP address of remote computer&gt;</b>  Connecting to &lt;IP address of remote computer&gt;...  The authenticity of host '&lt;IP address of remote computer&gt;' can't be established.  DSA key fingerprint is  58:a5:7e:1b:ca:fd:1d:fa:99:f2:01:16:79:d8:b4:24.  Are you sure you want to continue connecting (yes/no)? <b>yes</b>  Warning: Permanently added '&lt;IP address of remote computer&gt;' (DSA) to the list of known hosts.  root@&lt;IP address of remote computer&gt;'s password:  sftp&gt; cd &lt;target directory&gt;  sftp&gt; put &lt;hostname&gt;-plat-app-[date][time].tgz  Uploading &lt;hostname&gt;-plat-app-[date][time].tgz to &lt;hostname&gt;-plat-app-[date][time].tgz  sftp&gt; bye</p> <p>If no customer provided remote computer for backups exist, transfer the backup file to the mate using the following command:</p> <p><b>\$ sudo chmod 667 /var/TKLC/bkp/&lt;TGZ file&gt;</b>  <b>\$ su - epapdev</b>  <b>\$ scp /var/TKLC/bkp/&lt;TGZ file&gt; epapdev@remoteIP:&lt;Remote IP Path&gt;</b></p>
11. <input type="checkbox"/>	Procedure complete.	Return to the procedure that you came here from.
12. <input type="checkbox"/>	Note down the timestamp in log.	<p>Run the following command:  <b>\$ date</b></p>

## Procedure A.4 Execute parse9Dig script

### Appendix A.4 Execute parse9Dig script

S	This procedure performs the Execution of parse9Dig script.
---	--

T E P #	<p>Check off (✓) each step as it is completed. Boxes have been provided for this purpose under each step number.</p> <p>IF THIS PROCEDURE FAILS, CONTACT MY ORACLE SUPPORT AND ASK FOR <u>UPGRADE ASSISTANCE</u>.</p>	
1. <input type="checkbox"/>	<p><b>MPS A:</b> Log in as the user "epapdev" on standalone PDB.</p>	<p>If not already logged in, then login at MPS A:</p> <pre>&lt;hostname&gt; console login: epapdev password: &lt;password&gt;</pre>
2.	<p><b>MPS A:</b> Check if "parse9Dig" script is present on setup.</p>	<p>Check whether "parse9Dig" script is present on setup or not.</p> <p>Execute following command:</p> <pre>\$ ls -lrt /usr/TKLC/epap/config/parse9Dig</pre> <pre>[epapdev@Natal-a-PDBonly ~]\$ ls -lrt /usr/TKLC/epap/config/parse9Dig -rwxr-xr-x 1 epapdev epap 12162 Oct 10 16:23 /usr/TKLC/epap/config/parse9Dig</pre> <p>If output is same as above then proceed to step 4 otherwise proceed with following step.</p>
3. <input type="checkbox"/>	<p><b>MPS A:</b> Execute the "parse9Dig" script on standalone PDB.</p>	<p><b>Note:</b> Stop the Pdba software before executing this script.</p> <p>Run the "parse9Dig" script and examine the result.</p> <pre>\$/usr/TKLC/epap/config/parse9Dig all u</pre> <pre>[epapdev@Osorna-1B-PDBonly config]\$ /usr/TKLC/epap/config/parse9Dig all u</pre> <p>This utility will retrieve all digits for DB and parse them into 9Dig entries.</p> <pre>***** Utility Start Time: 06/13/18-21:24:31  Parsing DN digits into 9digits...  INFO: DN 9dig count  2.  REPLACE INTO dn9dig VALUES (UNHEX("05000000000"),1), (UNHEX("06000000000"),1);  Parsing IMSI digits into 9digits...  INFO: IMSI 9dig count:  9.  REPLACE INTO imsi9dig VALUES (UNHEX("0D001234567"),3), (UNHEX("06000000000"),1), (UNHEX("0700000009"),1), (UNHEX("08000000044"),1), (UNHEX("08000000023"),2), (UNHEX("05000000000"),1), (UNHEX("0800000077"),1), (UNHEX("08000000099"),1), (UNHEX("08000000088"),1);  Parsing IMEI digits into 9digits...  INFO: IMEI 9dig count:  1.  REPLACE INTO imei9dig VALUES (UNHEX("0E012345678"),2);  Utility End Time: 06/13/18-21:24:31</pre>

4. <input type="checkbox"/>	<b>MPS A:</b> Procedure is complete.	This procedure is complete.
5. <input type="checkbox"/>	Note down the timestamp in log.	Run the following command:  \$ date

## Procedure A.5 Increase rtVolume size for Non-prov

### Appendix A.5 Increase rtVolume size for Non-prov

<b>S T E P #</b>	This procedure increase rtVolume size for Non-prov.	
	Check off (✓) each step as it is completed. Boxes have been provided for this purpose under each step number.  IF THIS PROCEDURE FAILS, CONTACT MY ORACLE SUPPORT AND ASK FOR <b>UPGRADE ASSISTANCE</b> .	
<b>Note:</b> Skip this procedure for mixed EPAP and standalone EPAP.		
1. <input type="checkbox"/>	<b>MPS A:</b> Log in to the server.	If not already logged in, then login at MPS A: <b>&lt;hostname&gt; console login: epapdev</b> <b>Password: &lt;password&gt;</b>
2. <input type="checkbox"/>	<b>MPS A:</b> Execute "rtmdir_300gb" script for E5-APP-B cards with 300GB drive modules.	If EPAP is running on an E5-APP-B card with 300GB drive modules, perform this step. If instead, EPAP is running on an E5-APP-B card with 480GB drive modules, skip this step and go to step 3.  Download the rtmdir_300gb script zip file from My Oracle Support(MOS) ( <a href="https://support.oracle.com">https://support.oracle.com</a> ). The zip file is available on MOS under Oracle Communications EAGLE Application Processor 16.3.0.0.0.  Place the zip file in the /tmp directory. Unzip the file: <b>\$ unzip &lt;zip file name from MOS&gt;</b> <b>\$ cat Readme.txt</b>  Follow the directions in the Readme.txt file.  Execute the following script: <b>\$ sudo /usr/TKLC/epap/bin/rtmdir_300gb</b>  Warning: This utility would increase rtVolume for non-prov setup and this action is irreversible. Are you sure you want to continue?[Yes/No]: Yes  INFO: Increasing rt volume size for Non-provisionable EPAP. Please wait... INFO: db space increased on 'A'. INFO: Stopping Epap, mysqlapp and mysqlpdb services... Done. INFO: Starting Epap, mysqlapp and mysqlpdb services...

## Appendix A.5 Increase rtVolume size for Non-prov

		<pre> Done. INFO: Successfully configured Non-provisionable EPAP.  <b>Following error related to MyISAM table shall be observed on CLI while executing rtdir script:</b>  mysamchk: error: 140 when opening MyISAM-table '/var/TKLC/epap/db/pdb/mysql/columns_priv.MYI' mysamchk: error: 140 when opening MyISAM-table '/var/TKLC/epap/db/pdb/mysql/columns_priv.MYI' mysamchk: error: 140 when opening MyISAM-table '/var/TKLC/epap/db/pdb/mysql/db.MYI' e2fsck 1.43-WIP (20-Jun-2013) File descriptor 7 (socket:[102707]) leaked on lvreduce invocation. Parent PID 25006: sh resize2fs 1.43-WIP (20-Jun-2013) File descriptor 7 (socket:[102707]) leaked on vgdisplay invocation. Parent PID 25350: sh File descriptor 7 (socket:[102707]) leaked on lvextend invocation. Parent PID 25359: sh resize2fs 1.43-WIP (20-Jun-2013) File descriptor 7 (socket:[102707]) leaked on vgdisplay invocation. Parent PID 25410: sh File descriptor 7 (socket:[102707]) leaked on lvextend invocation. Parent PID 25416: sh mysamchk: error: 140 when opening MyISAM-table '/var/TKLC/epap/db/appconfig/EuiDB/alarmInfo.MYI' mysamchk: error: 140 when opening MyISAM-table '/var/TKLC/epap/db/appconfig/EuiDB/alarmInfo.MYI' mysamchk: error: 140 when opening MyISAM-table '/var/TKLC/epap/db/appconfig/EuiDB/bannerinfo.MYI' . . FIPS integrity verification test failed. FIPS integrity verification test failed. . .WARNING: Reducing active logical volume to 8.00 GiB. THIS MAY DESTROY YOUR DATA (filesystem etc.).  Skip step 3 and continue with step 4. </pre>
<p>3. <input type="checkbox"/></p>	<p><b>MPS A:</b> Execute “rtdir” script for E5-APP-B cards with 480GB drive modules.</p>	<p>If EPAP is running on an E5-APP-B card with 300GB drive modules, do notperform this step. Instead, execute step 2. If EPAP is running on an E5-APP-B card with 480GB drive modules,perform this step.</p> <p>Execute the following script:  <b>\$ sudo /usr/TKLC/epap/bin/rtdir</b></p> <p>Warning: This utility would increase rtVolume for non-prov setup and this action is irreversible.  Are you sure you want to continue?[Yes/No]: Yes</p> <pre> INFO: Increasing rt volume size for Non-provisionable EPAP. Please wait... INFO: db space increased on 'A'. INFO: Stopping Epap, mysqlapp and mysqlpdb services... Done. INFO: Starting Epap, mysqlapp and mysqlpdb services... Done. </pre>

## Appendix A.5 Increase rtVolume size for Non-prov

		<p>INFO: Successfully configured Non-provisionable EPAP.</p> <p><b>Following error related to MyISAM table shall be observed on CLI while executing rtdir script:</b></p> <pre> myisamchk: error: 140 when opening MyISAM-table '/var/TKLC/epap/db/pdb/mysql/columns_priv.MYI' myisamchk: error: 140 when opening MyISAM-table '/var/TKLC/epap/db/pdb/mysql/columns_priv.MYI' myisamchk: error: 140 when opening MyISAM-table '/var/TKLC/epap/db/pdb/mysql/db.MYI' e2fsck 1.43-WIP (20-Jun-2013) File descriptor 7 (socket:[102707]) leaked on lvreduce invocation. Parent PID 25006: sh resize2fs 1.43-WIP (20-Jun-2013) File descriptor 7 (socket:[102707]) leaked on vgdisplay invocation. Parent PID 25350: sh File descriptor 7 (socket:[102707]) leaked on lvextend invocation. Parent PID 25359: sh resize2fs 1.43-WIP (20-Jun-2013) File descriptor 7 (socket:[102707]) leaked on vgdisplay invocation. Parent PID 25410: sh File descriptor 7 (socket:[102707]) leaked on lvextend invocation. Parent PID 25416: sh myisamchk: error: 140 when opening MyISAM-table '/var/TKLC/epap/db/appconfig/EuiDB/alarInfo.MYI' myisamchk: error: 140 when opening MyISAM-table '/var/TKLC/epap/db/appconfig/EuiDB/alarInfo.MYI' myisamchk: error: 140 when opening MyISAM-table '/var/TKLC/epap/db/appconfig/EuiDB/bannerInfo.MYI' . . FIPS integrity verification test failed. FIPS integrity verification test failed. . .WARNING: Reducing active logical volume to 8.00 GiB. THIS MAY DESTROY YOUR DATA (filesystem etc.). </pre>
<p>4. <input type="checkbox"/></p>	<p><b>MPS A:</b> Verify rtVolume size using command “df -h”.</p>	<pre> [epapdev@Arica-1A ~]\$ df -h Filesystem      Size  Used Avail Use% Mounted on /dev/mapper/vgroot-plat_root                 976M  288M  637M  32% / tmpfs           3.9G   0  3.9G   0% /dev/shm /dev/md1        244M   40M  192M  18% /boot /dev/mapper/vgroot-plat_tmp                 976M  2.0M  923M   1% /tmp /dev/mapper/vgroot-plat_usr                 3.9G  2.5G  1.2G  68% /usr /dev/mapper/vgroot-plat_var                 976M  206M  720M  23% /var /dev/mapper/vgroot-plat_var_tklc                 3.9G  1.8G  1.9G  49% /var/TKLC /dev/mapper/vgroot-db                 5.8G  4.3G  1.2G  79% /var/TKLC/epap/db /dev/mapper/vgroot-free                 320G  5.3G  298G   2% /var/TKLC/epap/free /dev/mapper/vgroot-logs                 20G   89M   19G   1% /var/TKLC/epap/logs /dev/mapper/vgroot-rt                 82G  3.3G  75G   5% /var/TKLC/epap/rt [epapdev@Arica-1A ~]\$ </pre>

## Appendix A.5 Increase rtVolume size for Non-prov

		<b>Vgroot-rt size should be greater than 80G.</b>
5. <input type="checkbox"/>	MPS B: Execute "rtmdir" or "rtmdir_300gb" script.	After successfully converted rtVolume size on MPS A, repeat steps 2, 3, and 4 on MPS B.
6. <input type="checkbox"/>	MPS B: Procedure completed.	This procedure is completed.
7. <input type="checkbox"/>	Note down the timestamp in log.	Run the following command:  \$ date

## Procedure A.6 PDB Backup

### Appendix A.6 PDB Backup

S T E P #	<p>This procedure performs a PDB backup on the EPAP server configured as a Provisionable (mixed-EPAP or PDBonly) node. This procedure should only be performed on the active PDBA. <b>Note: Only one PDB Backup is allowed, to be stored. In case another backup is required, workaround is to setup the remote transfer of the existing pdb backup and then delete it.</b></p> <p>Check off (✓) each step as it is completed. Boxes have been provided for this purpose under each step number.</p> <p><b>IF THIS PROCEDURE FAILS, CONTACT MY ORACLE SUPPORT AND ASK FOR UPGRADE ASSISTANCE.</b></p>	
1. <input type="checkbox"/>	<b>MPS A:</b> Log in to the server.	If not already logged in, then log in to MPS A: <b>&lt;hostname&gt; console login: epapdev</b> <b>Password: &lt;password&gt;</b>
2. <input type="checkbox"/>	Run syscheck.	Run the following command: <b>\$ syscheck</b>  Note: syscheck may report following error which can be ignored: * defaultroute: FAILURE:: MINOR::5000000000040000 -- Platform Health Check Failure * defaultroute: FAILURE:: ping6 return non-zero code * defaultroute: FAILURE:: MAJOR::3000000000002000 -- Server Default Route Network Error * defaultroute: FAILURE:: The IPv6 default route at fe80::f64e:5ff:fe49:9b7f cannot be pinged
3. <input type="checkbox"/>	Verify the System Check executed successfully.	Running modules in class disk...  OK

## Appendix A.6 PDB Backup

	<p>In particular, verify that the PDBA process is running by noting that syscheck does not generate an alarm against the PDBA process.</p>	<pre>Running modules in class net...      OK Running modules in class proc...    OK Running modules in class system...  OK Running modules in class hardware... OK  The log is available at: --&gt;/var/TKLC/log/syscheck/fail_log  If the syscheck utility reports the "500000000000002 – Server Application Process Error" alarm, restart the PDBA and execute syscheck again. The above alarm should be removed. If the above alarm is not removed, contact My Oracle Support following the instructions on the front page or the instructions in the <b>My Oracle Support</b> section</pre>
<p>4. <input type="checkbox"/></p>	<p>System Check Verifies that PDBA is running.</p>	<p>If the syscheck does not report any errors, proceed to the next step. Otherwise, if any other failures were detected by System Check, contact My Oracle Support following the instructions on the front page or the instructions in the <b>My Oracle Support</b> section.</p> <p>Note: syscheck may report following error which can be ignored:</p> <ul style="list-style-type: none"> <li>* defaultroute: FAILURE:: MINOR::5000000000040000 -- Platform Health Check Failure</li> <li>* defaultroute: FAILURE:: ping6 return non-zero code</li> <li>* defaultroute: FAILURE:: MAJOR::3000000000002000 -- Server Default Route Network Error</li> <li>* defaultroute: FAILURE:: The IPv6 default route at fe80::f64e:5ff:fe49:9b7f cannot be pinged</li> </ul>
<p>5. <input type="checkbox"/></p>	<p>Log in to epapconfig.</p>	<pre>\$ su - admusr \$ sudo su - epapconfig  Warning: Smartmatch is experimental at /usr/TKLC/plat/lib/Security/User.pm line 904.</pre>
<p>6. <input type="checkbox"/></p>	<p>Main menu is displayed. Select Platform Menu.</p>	<pre>Menu for mixed-EPAP:  /-----EPAP Configuration Menu-----\ /-----\ 1   Display Configuration 2   Configure Network Interfaces Menu 3   Set Time Zone 4   Exchange Secure Shell keys 5   Change Password 6   Platform Menu 7   Configure NTP Server 8   PDB Configuration Menu -----</pre>

## Appendix A.6 PDB Backup

		<pre> 9   Security --- ----- 10   SNMP Configuration --- ----- 11   Configure Alarm Feed --- ----- 12   Configure Query Server --- ----- 13   Configure Query Server Alarm Feed --- ----- 14   Configure SNMP Agent Community --- ----- 15   Mate Disaster Recovery --- ----- e    Exit \-----/ </pre> <p>Enter Choice: 6</p>
<p>7. <input type="checkbox"/></p>	<p>Platform menu is displayed. Select PDB Backup.</p>	<pre> Menu for standard EPAP designation: /-----EPAP Platform Menu-\ \-----/  1   Initiate Upgrade --- -----  2   Reboot MPS --- -----  3   MySQL Backup --- -----  4   RTDB Backup --- -----  5   PDB Backup --- ----- e    Exit \-----/ </pre> <p>Enter Choice: 5</p> <pre> Menu for PDB-only designation: /-----EPAP Platform Menu-\ \-----/  1   Initiate Upgrade --- -----  2   Reboot MPS --- -----  3   MySQL Backup --- -----  4   PDB Backup --- ----- e    Exit \-----/ </pre> <p>Enter Choice: 4</p>
<p>8. <input type="checkbox"/></p>	<p>Menu will prompt for a “yes” to continue. Enter a Y.</p>	<pre> Are you sure you want to backup the PDB to /var/TKLC/epap/free/pdbBackup_DBExpPdbOnly_20180613055813_DDBirthd ate_20180613072847GMT_DBLevel_6507_v7.50.bkp.tar.gz? [N]: </pre>

## Appendix A.6 PDB Backup

<p>9. <input type="checkbox"/></p>	<p>While the backup is begin performed, the following output will be displayed to the screen. Note: Only one PDB Backup is allowed, to be stored.</p>	<p>Successfully started backup of PDB. Status will be displayed on the GUI banner.</p> <p>Press return to continue...</p> <p><b>Note: If following error is displayed instead of success, then you need to delete all pdbBackup from free directory in order to schedule new pdbBackup.</b></p> <p>E1058: An internal error in the EPAP occurred: pdbBackup already exists in free directory. Press return to continue...</p>
<p>10. <input type="checkbox"/></p>	<p>Exit this menu and return to the login prompt.</p>	<p>Enter Choice: e</p> <p>Note: If this menu is not exited properly, then the SSH login with root shall remain enabled.</p>
<p>11. <input type="checkbox"/></p>	<p>Monitor GUI banner.</p>	<p>Monitor the GUI banner. When the backup has completed successfully, continue to the next step.</p>
<p>12. <input type="checkbox"/></p>	<p>Use SFTP to transfer the backup file to a remote customer provided computer.</p>	<p>Using SFTP (secure-FTP), transfer the PDB backup file to a remote, customer-provided computer. Enter "yes" when prompted if you want to continue to connect.</p> <pre>\$ cd /var/TKLC/epap/free</pre> <pre>\$ sftp &lt;IP address of remote computer&gt;</pre> <p>Connecting to &lt;IP address of remote computer&gt;... The authenticity of host '&lt;IP address of remote computer&gt;' can't be established. DSA key fingerprint is 58:a5:7e:1b:ca:fd:1d:fa:99:f2:01:16:79:d8:b4:24. Are you sure you want to continue connecting (yes/no)? <b>yes</b> Warning: Permanently added &lt;IP address of remote computer&gt;' (DSA) to the list of known hosts. root@&lt;IP address of remote computer&gt;'s password: sftp&gt; cd &lt;target directory&gt; sftp&gt; put pdbBackup_&lt;hostname&gt;_20140530151806_DDBirthdate_20140530144717GMT_DDBLevel_&lt;DBLevel&gt;.bkp.tar.gz Uploading pdbBackup_&lt;hostname&gt;_20140530151806_DDBirthdate_20140530144717GMT_DDBLevel_&lt;DBLevel&gt;.bkp.tar.gz to pdbBackup_&lt;hostname&gt;_20140530151806_DDBirthdate_20140530144717GMT_DDBLevel_&lt;DBLevel&gt;.bkp.tar.gz sftp&gt; bye <p>If no customer provided remote computer for backups exist, transfer the backup file to the mate using the following command</p> </p>

## Appendix A.6 PDB Backup

		<pre>\$ su - epapdev  \$ scp /var/TKLC/epap/free/&lt;pdb backup file&gt; epapdev@mate:/var/TKLC/epap/free/</pre>
13.	Procedure complete.	Return to the procedure that you came here from.
14.	Note down the timestamp in log.	Run the following command: <pre>\$ date</pre>

## Procedure A.7 RTDB Backup

**Note:** Skip this procedure for PDBonly setup.

### Appendix A.7 RTDB Backup

<b>S T E P #</b>	<p>This procedure performs an RTDB backup on the EPAP server.</p> <p>Check off (✓) each step as it is completed. Boxes have been provided for this purpose under each step number.</p> <p>IF THIS PROCEDURE FAILS, CONTACT MY ORACLE SUPPORT AND <b>ASK FOR UPGRADE ASSISTANCE.</b></p>	
	1.	<p><b>MPS</b>: Log in to the server.</p> <p>If not already logged in, then Log in to the MPS server.  <pre>&lt;hostname&gt; console login: admusr Password: &lt;password&gt;</pre> </p>
	2.	<p>Enter the epapconfig menu.</p> <p>Run the following command:  <pre>\$ sudo su - epapconfig</pre> </p> <p>Warning: Smartmatch is experimental at /usr/TKLC/plat/lib/Security/User.pm line 904.</p>
	3.	<p>Main menu is displayed. Select Platform Menu.</p> <pre> /-----EPAP Configuration Menu-----\ /-----\   1   Display Configuration    -----    2   Configure Network Interfaces Menu    -----    3   Set Time Zone    -----    4   Exchange Secure Shell Keys    -----    5   Change Password    -----    6   Platform Menu   </pre>

**Appendix A.7 RTDB Backup**

		<pre>  -----    7   Configure NTP Server    -----    8   Security    -----    9   SNMP Configuration    -----    10   Configure Alarm Feed    -----    11   Configure SNMP Agent Community    -----    12   Mate Disaster Recovery    -----    e   Exit   \-----/ </pre> <p>Enter Choice: 6</p>
4.	<input type="checkbox"/> Platform menu is displayed. Select RTDB Backup.	<pre> /-----EPAP Platform Menu-\ /-----\   1   Initiate Upgrade    -----    2   Reboot MPS    -----    3   MySQL Backup    -----    4   RTDB Backup    -----    5   PDB Backup    -----    e   Exit   \-----/ </pre> <p>Enter Choice: 4</p>
5.	<input type="checkbox"/> The Application software must be stopped.	<p>If the EPAP application software is running, you will be prompted to stop the software for the RTDB backup. Select with a “Y”.</p> <pre> EPAP software is running. Stop it? [N]: Y </pre>
6.	<input type="checkbox"/> Menu will prompt for a “yes” to continue. Enter a Y.	<pre> Are you sure you want to backup the PDB to /var/TKLC/epap/free/ rtddbBackup_Recife-A_20140530151806.tar.gz? [N]: </pre>
7.	<input type="checkbox"/> While the backup is begin performed, the following output will be displayed to the screen.	<pre> Successfully started backup of RTDB. Status will be displayed on the GUI banner.  Press return to continue... </pre>
8.	<input type="checkbox"/> Exit this menu and return to the login prompt. Continue exiting until you get	<pre> Enter Choice: e Enter Choice: e </pre> <p>Note: If this menu is not exited properly, then the SSH login with root shall remain enabled.</p>

## Appendix A.7 RTDB Backup

	to the login prompt.	
9. <input type="checkbox"/>	Monitor GUI banner.	<p>Monitor the GUI banner. When the backup has completed successfully, continue to the next step.</p> <p><b>Note:</b> On performing RTDB backup following two error were observed in cgi.dbg file although rtdb backup is getting completed</p> <p>ERROR: Invalid numbr of argument. Number of argument must be 3 to update RTDB backup DB level properly in pdb.</p> <p>Error: Couldn't able to run the script on Remote Prov with IP (0.0.0.0) having procRc = 255, signal = 0, core = 0.</p>
10. <input type="checkbox"/>	Restart the EPAP Software.	<p>Restart the EPAP application software.</p> <p><b>\$ sudo /etc/init.d/Epap start</b></p>
11. <input type="checkbox"/>	Use SFTP to transfer the backup file to a remote customer provided computer.	<p>Using SFTP (secure-FTP), transfer the RTDB backup file to a remote, customer-provided computer. Enter “yes” when prompted if you want to continue to connect.</p> <p><b>\$ cd /var/TKLC/epap/free</b></p> <p><b>\$ sftp &lt;IP address of remote computer&gt;</b>  Connecting to &lt;IP address of remote computer&gt;...  The authenticity of host '&lt;IP address of remote computer&gt;' can't be established.  DSA key fingerprint is  58:a5:7e:1b:ca:fd:1d:fa:99:f2:01:16:79:d8:b4:24.  Are you sure you want to continue connecting (yes/no)? yes  Warning: Permanently added '&lt;IP address of remote computer&gt;' (DSA) to the list of known hosts.  root@&lt;IP address of remote computer&gt;'s password:  sftp&gt; cd &lt;target directory&gt;  sftp&gt; put rtdbBackup_&lt;hostname&gt;_20140530151806.tar.gz  Uploading rtdbBackup_&lt;hostname&gt;_20140530151806.tar.gz to  rtdbBackup_&lt;hostname&gt;_20140530151806.tar.gz  sftp&gt; bye</p> <p>If no customer provided remote computer for backups exist, transfer the backup file to the mate using the following command</p> <p><b>\$ su - epapdev</b></p> <p><b>\$ scp /var/TKLC/epap/free/&lt;rtdb backup file&gt; epapdev@mate:/var/TKLC/epap/free</b></p>

## Appendix A.7 RTDB Backup

12. <input type="checkbox"/>	Procedure complete.	Return to the procedure that you came here from.
13. <input type="checkbox"/>	Note down the timestamp in log.	Run the following command: <b>\$ date</b>

## Procedure A.8 EuiDB Backup

### Appendix A.8 EuiDB Backup

<b>S T E P #</b>	<p>This procedure performs a backup of the User database on the MPS server.</p> <p>Check off (✓) each step as it is completed. Boxes have been provided for this purpose under each step number.</p> <p>IF THIS PROCEDURE FAILS, CONTACT MY ORACLE SUPPORT AND <b>ASK FOR <u>UPGRADE ASSISTANCE</u></b>.</p>	
	1. <input type="checkbox"/>	<p><b>MPS A:</b> Log in to the server as user "admusr".</p> <p><b>&lt;hostname&gt; console login: admusr</b> <b>Password: &lt;password&gt;</b></p>
	2. <input type="checkbox"/>	<p>Enter the epapconfig menu.</p> <p>Run the following command:</p> <p><b>\$ sudo su - epapconfig</b></p> <p>warning: smartmatch is experimental at /usr/TKLC/plat/lib/Security/User.pm line 904.</p>
	3. <input type="checkbox"/>	<p>Master menu is displayed. Select Platform Menu.</p> <pre> /-----EPAP Configuration Menu-----\ /-----\   1   Display Configuration                   ----- -----    2   Configure Network Interfaces Menu       ----- -----    3   Set Time Zone                           ----- -----    4   Exchange Secure Shell Keys              ----- -----    5   Change Password                         ----- -----    6   Platform Menu                           ----- -----    7   Configure NTP Server                     ----- -----    8   PDB Configuration Menu                  ----- -----    9   Security                                 ----- -----   10   SNMP Configuration                      ----- -----   11   Configure Alarm Feed                    </pre>

**Appendix A.8 EuiDB Backup**

		<pre>  ----- ----- -----    12   Configure Query Server    ----- ----- -----    13   Configure Query Server Alarm Feed    ----- ----- -----    14   Configure SNMP Agent Community    ----- ----- -----    15   Mate Disaster Recovery    ----- ----- -----    e   Exit   \-----/ </pre> <p>Enter Choice: 6</p>
4. <input type="checkbox"/>	Platform menu is displayed. Select MySQL Backup.	<pre> /-----EPAP Platform Menu-\ /-----\   1   Initiate Upgrade    ----- -----    2   Reboot MPS    ----- -----    3   MySQL Backup    ----- -----    4   RTDB Backup    ----- -----    5   PDB Backup    ----- -----    e   Exit   \-----/ </pre> <p>Enter Choice: 3</p>
5. <input type="checkbox"/>	You will then be prompted to verify that you want to backup the MySQL Database.	Are you sure you want to backup the MySQL database on MPS A? [N]:
6. <input type="checkbox"/>	Type "Y" and press enter.	Press Y
7. <input type="checkbox"/>	While the backup is begin performed, the following output will be displayed to the screen.	NPDB Backed up Successfully to /var/TKLC/appl/free/<file name>
8. <input type="checkbox"/>	Exit this menu and return to the Unix login prompt. Continue exiting until you get to the Unix login prompt.	<p>Enter Choice: e</p> <p>Note: If this menu is not exited properly, then the SSH login with root shall remain enabled.</p>

**Appendix A.8 EuiDB Backup**

<p>9. <input type="checkbox"/></p>	<p>Use SFTP to transfer the backup file to a remote customer provided computer.</p>	<p>Using SFTP (secure-FTP), transfer the NPDB backup file to a remote, customer-provided computer. Enter “yes” when prompted if you want to continue to connect.</p> <pre>\$ cd /var/TKLC/epap/free</pre> <pre>\$ sftp &lt;IP address of remote computer&gt;</pre> <p>Connecting to &lt;IP address of remote computer&gt;... The authenticity of host '&lt;IP address of remote computer&gt;' can't be established. DSA key fingerprint is 58:a5:7e:1b:ca:fd:1d:fa:99:f2:01:16:79:d8:b4:24. Are you sure you want to continue connecting (yes/no)? yes Warning: Permanently added '&lt;IP address of remote computer&gt;' (DSA) to the list of known hosts. root@&lt;IP address of remote computer&gt;'s password: sftp&gt; cd &lt;target directory&gt; sftp&gt; put npdbBackup_&lt;hostname&gt;_20140530151806.sql.gz Uploading npdbBackup_&lt;hostname&gt;_20140530151806.sql.gz to npdbBackup_&lt;hostname&gt;_20140530151806.sql.gz sftp&gt; bye <p>If no customer provided remote computer for backups exist, transfer the backup file to the mate using the following command</p> <pre>\$ su - epapdev</pre> <pre>\$ scp /var/TKLC/epap/free/&lt;npdb backup file&gt; epapdev@mate:/var/TKLC/epap/free</pre> </p>
<p>10. <input type="checkbox"/></p>	<p>Procedure complete.</p>	<p>Return to the procedure that you came here from.</p>
<p>11. <input type="checkbox"/></p>	<p>Note down the timestamp in log.</p>	<p>Run the following command:</p> <pre>\$ date</pre>

**Procedure A.9 RTDB Reload from PDBA**



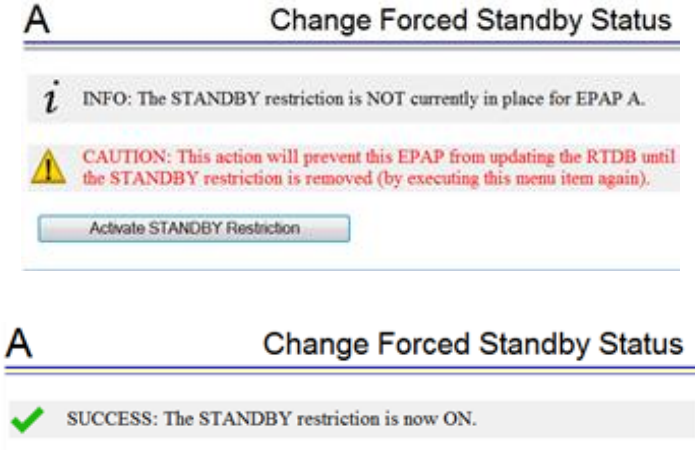
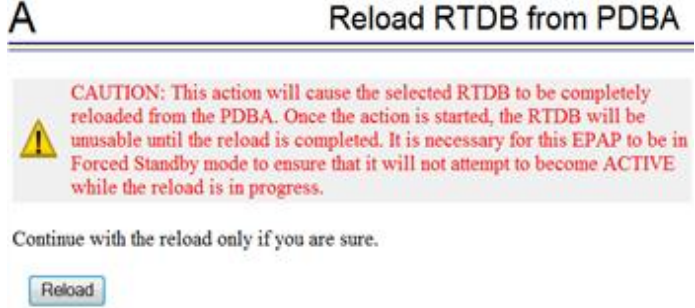

**Appendix A.9 RTDB Reload from PDBA**

<p><b>S T E P #</b></p>	<p>This procedure provides instructions to reload RTDB from PDBA.</p> <p>Check off (✓) each step as it is completed. Boxes have been provided for this purpose under each step number.</p> <p>IF THIS PROCEDURE FAILS, CONTACT MY ORACLE SUPPORT AND ASK FOR ASSISTANCE.</p>	
<p>1. <input type="checkbox"/></p>	<p><b>EPAP A:</b> Log in to the web GUI as user “uiadmin”.</p>	

## Appendix A.9 RTDB Reload from PDBA

		
<p>2. <input type="checkbox"/></p>	<p><b>EPAP A:</b> Put EPAP in Force Standby Mode.</p> <p>Expand the “Maintenance” Folder.</p> <p>Expand the “Force Standby” Folder.</p> <p>Select the “Change Status” link.</p> <p>Click on “Activate STANDBY Restriction” Button.</p>	
<p>3. <input type="checkbox"/></p>	<p><b>EPAP A:</b> Reload RTDB from PDBA.</p> <p>Expand the “RTDB” Folder.</p> <p>Expand the “Maintenance” Folder.</p> <p>Select the “Reload from PDBA” link.</p> <p>Click on the “Reload” Button.</p>	

## Appendix A.9 RTDB Reload from PDBA

	<p>Observe the "SUCCESS" Status.</p>	<div data-bbox="624 264 1385 432"> <h3>A <u>Reload RTDB from PDBA</u></h3> <p> SUCCESS: The reload has been initiated. You can check its progress by viewing the RTDB status. Also, an informational message has been added to the Banner. The message will be cleared when the reload is complete.</p> </div>
<p>4. <input type="checkbox"/></p>	<p><b>EPAP A:</b> Wait for completion.</p> <p>Observe the GUI informational message and wait for the RTDB Reload completion message before proceeding.</p>	<div data-bbox="588 600 1422 958">  </div>
<p>5. <input type="checkbox"/></p>	<p><b>EPAP A:</b> Remove EPAP from Force Standby Mode.</p> <p>Expand the "Maintenance" Folder.</p> <p>Expand the "Force Standby" Folder.</p> <p>Select the "Change Status" link.</p> <p>Click on "Remove STANDBY Restriction" Button.</p>	<div data-bbox="624 1021 1385 1507"> <h3>A <u>Change Forced Standby Status</u></h3> <p> INFO: The STANDBY restriction is currently in place for EPAP A.</p> <p> CAUTION: This action will allow this EPAP to resume updating the RTDB.</p> <p><input type="button" value="Remove STANDBY Restriction"/></p> <hr/> <h3>A <u>Change Forced Standby Status</u></h3> <p> SUCCESS: The STANDBY restriction is now OFF.</p> </div>

## Appendix A.9 RTDB Reload from PDBA

<p>6. <input type="checkbox"/></p>	<p><b>EPAP A:</b> Verify RTDB status.</p> <p>Expand the “RTDB” Folder.</p> <p>Select the “View RTDB Status” link.</p>	<div style="text-align: right;">View RTDB Status</div> <hr/> <div style="border: 1px solid gray; padding: 5px;"> <p style="text-align: center;"><b>Local RTDB Status</b></p> <table style="width: 100%; border-collapse: collapse;"> <tr> <td style="width: 50%;">DB Status: <span style="color: green;">Coherent</span></td> <td style="width: 50%;">Audit Enabled: Yes</td> </tr> <tr> <td>RTDB Level: 1</td> <td>RTDB Birthday: 05/22/2014 14:57:49 GMT</td> </tr> <tr> <td>PDB Level: 1</td> <td>PDB Birthday: 05/09/2014 07:51:44 GMT</td> </tr> <tr> <td colspan="2">Counts: IMSIs=0, DNs=0, DN Blocks=0, NEs=1, ASDs=0</td> </tr> <tr> <td colspan="2">Tables: IMSI=0, DN=0, IMEI=0, ASD=0</td> </tr> <tr> <td>DB Size: 3 M</td> <td>MinDsmSz: 0 MB (0)</td> </tr> <tr> <td>Reload: None</td> <td></td> </tr> </table> </div> <p>The RTDB Status must be Coherent.</p> <p>Note: RTDB Reload from PDBA completed banner message will not be observed and same is not pegged in cgi.dbg. Completion of RTDB Reload from PDBA is completed when PRD-RTDB parameter sync is observed</p>	DB Status: <span style="color: green;">Coherent</span>	Audit Enabled: Yes	RTDB Level: 1	RTDB Birthday: 05/22/2014 14:57:49 GMT	PDB Level: 1	PDB Birthday: 05/09/2014 07:51:44 GMT	Counts: IMSIs=0, DNs=0, DN Blocks=0, NEs=1, ASDs=0		Tables: IMSI=0, DN=0, IMEI=0, ASD=0		DB Size: 3 M	MinDsmSz: 0 MB (0)	Reload: None	
DB Status: <span style="color: green;">Coherent</span>	Audit Enabled: Yes															
RTDB Level: 1	RTDB Birthday: 05/22/2014 14:57:49 GMT															
PDB Level: 1	PDB Birthday: 05/09/2014 07:51:44 GMT															
Counts: IMSIs=0, DNs=0, DN Blocks=0, NEs=1, ASDs=0																
Tables: IMSI=0, DN=0, IMEI=0, ASD=0																
DB Size: 3 M	MinDsmSz: 0 MB (0)															
Reload: None																
<p>7. <input type="checkbox"/></p>	<p>Procedure complete.</p>	<p>Return to the procedure that you came here from.</p>														
<p>8. <input type="checkbox"/></p>	<p>Note down the timestamp in log.</p>	<p>Run the following command:</p> <p><b>\$ date</b></p>														

## Procedure A.10 RTDB Restore

### Appendix A.10 RTDB Restore

<p><b>S T E P #</b></p>	<p>This procedure provides instructions to restore RTDB from a backup file.</p> <p>Check off (✓) each step as it is completed. Boxes have been provided for this purpose under each step number.</p> <p>IF THIS PROCEDURE FAILS, CONTACT MY ORACLE SUPPORT AND ASK FOR ASSISTANCE.</p>	
<p>1. <input type="checkbox"/></p>	<p><b>EPAP A:</b> Log in to the web GUI as user “uiadmin”.</p>	

## Appendix A.10 RTDB Restore

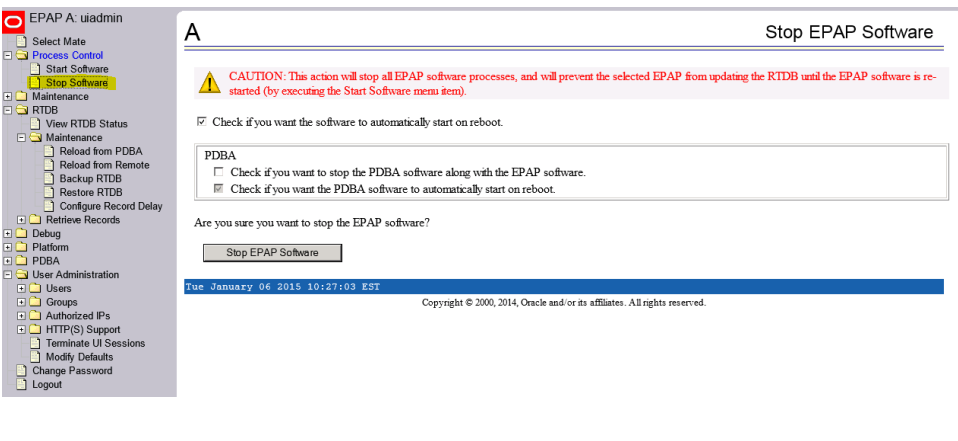
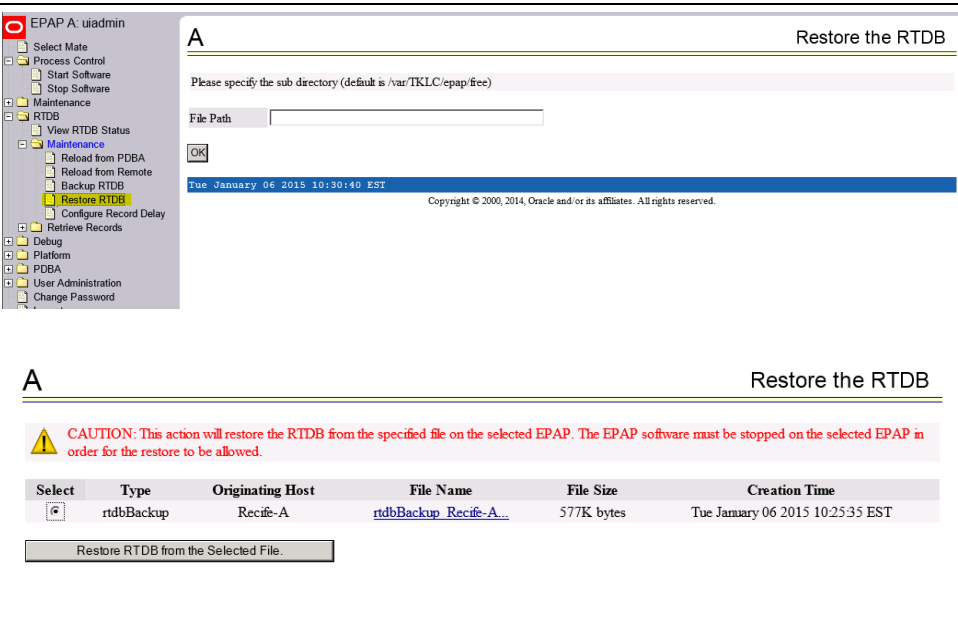
<p>2. <input type="checkbox"/></p> <p><b>EPAP A: Stop Software.</b></p> <p>On the menu, click Process Control-&gt;Stop Software.</p> <p>Click “Stop EPAP Software” Button</p>		 <p><b>A</b> <span style="float: right;">Stop EPAP Software</span></p> <p><b>CAUTION:</b> This action will stop all EPAP software processes, and will prevent the selected EPAP from updating the RTDB until the EPAP software is restarted (by executing the Start Software menu item).</p> <p><input checked="" type="checkbox"/> Check if you want the software to automatically start on reboot.</p> <p>PDBA</p> <p><input type="checkbox"/> Check if you want to stop the PDBA software along with the EPAP software.</p> <p><input checked="" type="checkbox"/> Check if you want the PDBA software to automatically start on reboot.</p> <p>Are you sure you want to stop the EPAP software?</p> <p><input type="button" value="Stop EPAP Software"/></p> <p>Tue January 06 2015 10:27:03 EST</p> <p>Copyright © 2000, 2014, Oracle and/or its affiliates. All rights reserved.</p> <hr/> <p><b>A</b> <span style="float: right;">Stop EPAP Software</span></p> <p><input checked="" type="checkbox"/> <b>SUCCESS:</b> The EPAP Software has been stopped.</p> <p>Tue January 06 2015 10:29:53 EST</p> <p>Copyright © 2000, 2014, Oracle and/or its affiliates. All rights reserved.</p>												
<p>3. <input type="checkbox"/></p> <p><b>EPAP A: Restore RTDB.</b></p> <p>On the menu, click RTDB-&gt;Maintenance-&gt;Restore RTDB</p> <p>Select the backup file, then click “Restore RTDB from the Selected File” Button</p>		 <p><b>A</b> <span style="float: right;">Restore the RTDB</span></p> <p>Please specify the sub directory (default is /var/TKLC/epap/free)</p> <p>File Path: <input type="text"/></p> <p><input type="button" value="OK"/></p> <p>Tue January 06 2015 10:30:40 EST</p> <p>Copyright © 2000, 2014, Oracle and/or its affiliates. All rights reserved.</p> <hr/> <p><b>A</b> <span style="float: right;">Restore the RTDB</span></p> <p><b>CAUTION:</b> This action will restore the RTDB from the specified file on the selected EPAP. The EPAP software must be stopped on the selected EPAP in order for the restore to be allowed.</p> <table border="1"> <thead> <tr> <th>Select</th> <th>Type</th> <th>Originating Host</th> <th>File Name</th> <th>File Size</th> <th>Creation Time</th> </tr> </thead> <tbody> <tr> <td><input checked="" type="checkbox"/></td> <td>rtdbBackup</td> <td>Recife-A</td> <td>rtdbBackup_Recife-A...</td> <td>577K bytes</td> <td>Tue January 06 2015 10:25:35 EST</td> </tr> </tbody> </table> <p><input type="button" value="Restore RTDB from the Selected File."/></p> <hr/> <p><b>A</b> <span style="float: right;">Restore the RTDB</span></p> <p><b>CAUTION:</b> This backup file may be incompatible with your system.</p> <p>Are you sure that you want to restore the RTDB from the file <b>rtdbBackup_Cusco-A_20181128103003_DDBirthdate_20141015030619GMT_DBLlevel_78687002_v4.72.bkp.tar.gz</b> ?</p> <p><input type="button" value="Confirm RTDB Restore"/></p>	Select	Type	Originating Host	File Name	File Size	Creation Time	<input checked="" type="checkbox"/>	rtdbBackup	Recife-A	rtdbBackup_Recife-A...	577K bytes	Tue January 06 2015 10:25:35 EST
Select	Type	Originating Host	File Name	File Size	Creation Time									
<input checked="" type="checkbox"/>	rtdbBackup	Recife-A	rtdbBackup_Recife-A...	577K bytes	Tue January 06 2015 10:25:35 EST									

## Appendix A.10 RTDB Restore

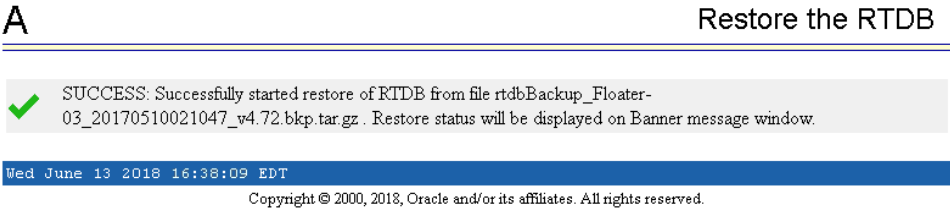
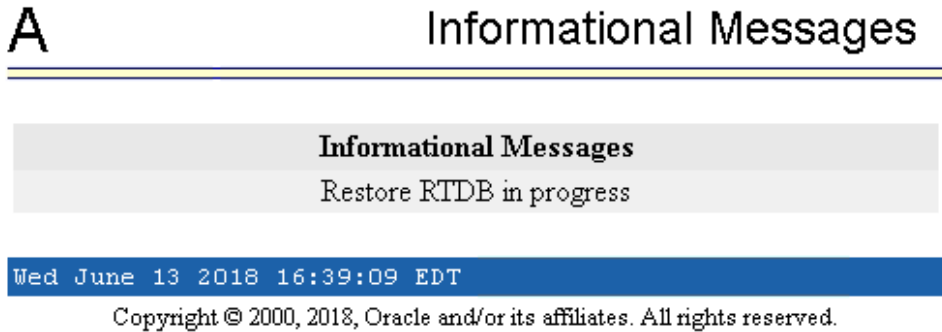
	<p>Click “Confirm RTDB Restore” Button</p>	<p><b>NOTE:</b> Caution message regarding “incompatible file” is displayed in above snapshot as the backup file is taken on RTDB version 4 and is being restored on RTDB version 5.</p> <p><b>Restore successfully started:</b></p> 
<p>4. <input type="checkbox"/></p>	<p><b>EPAP A:</b> Make EPAP down.</p> <p>An IM alarm should be observed with informational message on EPAP GUI confirming that restore RTDB is in progress.</p> <p>An IM alarm should be observed with informational message on EPAP GUI confirming that restore RTDB completed successfully.</p>	<p>Confirming that Restore RTDB in progress:</p> 

**Appendix A.10 RTDB Restore**

	<p>Click “Confirm RTDB Restore” Button</p>	<p>Confirming that Restore RTDB is completed successfully:</p> <hr/> <p><b>A</b> <span style="float: right;"><b>Informational Messages</b></span></p> <hr/> <div style="text-align: center; background-color: #f0f0f0; padding: 5px;"> <p><b>Informational Messages</b> Restore RTDB completed successfully</p> </div> <div style="background-color: #0056b3; color: white; padding: 2px;"> <p>Fri June 15 2018 00:30:27 EDT</p> </div> <p style="text-align: center; font-size: small;">Copyright © 2000, 2018, Oracle and/or its affiliates. All rights reserved.</p>
<p>5. <input type="checkbox"/></p>	<p><b>EPAP A:</b> RTDB converter is started.</p> <p>An IM alarm should be observed with informational message on EPAP GUI confirming that RTDB Conversion in progress.</p> <p>An IM alarm should be observed with informational message on EPAP GUI confirming</p>	<p>This step is performed only to support EAGLE release 46.7.0.0.0 (On the setup where DB Architecture is eXtreme):</p> <hr/> <p><b>A</b> <span style="float: right;"><b>Informational Messages</b></span></p> <hr/> <div style="text-align: center; background-color: #f0f0f0; padding: 5px;"> <p><b>Informational Messages</b> RTDB Conversion in progress</p> </div> <div style="background-color: #0056b3; color: white; padding: 2px;"> <p>Wed June 13 2018 16:55:42 EDT</p> </div> <p style="text-align: center; font-size: small;">Copyright © 2000, 2018, Oracle and/or its affiliates. All rights reserved.</p>

## Appendix A.10 RTDB Restore



	that RTDB Conversion completed successfully.	<p><b>A</b> <span style="float: right;"><b>Informational Messages</b></span></p> <hr/> <div style="text-align: center; background-color: #f0f0f0; padding: 5px;"> <b>Informational Messages</b>  RTDB conversion completed successfully </div> <div style="background-color: #0056b3; color: white; padding: 2px; text-align: center; font-family: monospace;"> Fri June 15 2018 00:37:57 EDT </div> <p style="text-align: center;">Copyright © 2000, 2018, Oracle and/or its affiliates. All rights reserved.</p> <p><b>Note:</b> On performing RTDB Restore following two error were observed in cgi.dbg file although rtdb restore is getting completed</p> <p>ERROR: Invalid numbr of argument. Number of argument must be 3 to update RTDB backup DB level properly in pdb.</p> <p>Error: Couldn't able to run the script on Remote Prov with IP (0.0.0.0) having procRc = 255, signal = 0, core = 0.</p>
6.	<input type="checkbox"/> Procedure complete.	Return to the procedure that you came here from.
7.	<input type="checkbox"/> Note down the timestamp in log.	Run the following command: <b>\$ date</b>

## Procedure A.11 RTDB Reload from Remote

### Appendix A.11 RTDB Reload from Remote

<b>S T E P #</b>	This procedure provides instructions to restore RTDB from a backup file.  Check off (✓) each step as it is completed. Boxes have been provided for this purpose under each step number.  <b>IF THIS PROCEDURE FAILS, CONTACT MY ORACLE SUPPORT AND ASK FOR ASSISTANCE.</b>	
1.	<input type="checkbox"/> <b>EPAP B:</b> Log in to the web GUI as user "uiadmin".	

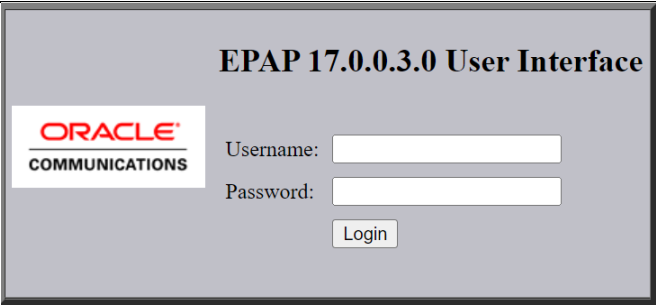
## Appendix A.11 RTDB Reload from Remote

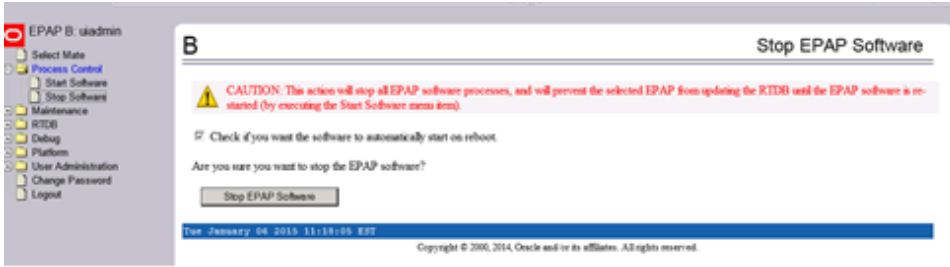
		 <p style="text-align: center;"><b>EPAP 17.0.0.3.0 User Interface</b></p> <p style="text-align: center;">          Username: <input type="text"/>          Password: <input type="password"/>  <input type="button" value="Login"/> </p>
<p>2. <input type="checkbox"/></p>	<p><b>EPAP B: Stop Software.</b></p> <p>On the menu, click Process Control-&gt;Stop Software.</p> <p>Click “Stop EPAP Software” Button</p>	 <p><b>B</b> <span style="float: right;">Stop EPAP Software</span></p> <p><b>CAUTION:</b> This action will stop all EPAP software processes, and will prevent the selected EPAP from updating the RTDB until the EPAP software is restarted (by executing the Start Software menu item).</p> <p><input type="checkbox"/> Check if you want the software to automatically start on reboot.</p> <p>Are you sure you want to stop the EPAP software?</p> <p style="text-align: center;"><input type="button" value="Stop EPAP Software"/></p> <p>Tue January 06 2015 11:18:05 EST Copyright © 2000, 2014, Oracle and/or its affiliates. All rights reserved.</p> <hr/> <p><b>B</b> <span style="float: right;">Stop EPAP Software</span></p> <p><input checked="" type="checkbox"/> SUCCESS: The EPAP Software has been stopped.</p> <p>Tue January 06 2015 11:22:17 EST</p>
<p>3. <input type="checkbox"/></p>	<p><b>EPAP B: Reload RTDB from Remote.</b></p> <p>On the menu, click RTDB-&gt;Maintenance-&gt;Reload from Remote</p> <p>Select Mate.</p> <p>Click “Begin RTDB Reload from Remote” Button</p> <p>Click “Confirm RTDB Reload from Remote” Button</p>	<p><b>NOTE: If reload is attempted from a remote Non-Prov site, kindly exchange the keys between this Non-Prov and the Non-Prov from where reload is being attempted. If reload is from mate, no need to do anything.</b></p> <p><b>B</b> <span style="float: right;">Reload RTDB from Remote</span></p> <p>This action will copy the RTDB from the specified source machine to the local machine. The EPAP software must be stopped on both the source and destination machine in order for the copy to be allowed.</p> <p>Source EPAP: <input checked="" type="radio"/> Mate <input type="radio"/> Remote IP <input type="text" value="IPv4"/> <input type="button" value="Begin RTDB Reload from Remote"/></p> <p>Tue March 01 2016 09:18:31 EST Copyright © 2000, 2015, Oracle and/or its affiliates. All rights reserved.</p> <hr/> <p><b>B</b> <span style="float: right;">Reload RTDB from Remote</span></p> <p>Are you sure that you want to reload the RTDB from the mate?</p> <p style="text-align: center;"><input type="button" value="Confirm RTDB Reload from Remote"/></p>
<p>4. <input type="checkbox"/></p>	<p><b>EPAP B: Reload RTDB from Mate</b></p>	

## Appendix A.11 RTDB Reload from Remote

	<p>An IM alarm should be observed with informational message on EPAP GUI confirming the start of the reload process</p> <p>An informational alarm should be displayed with informational message when the reload is complete.</p>	<div style="border: 1px solid black; padding: 10px;"> <h3 style="text-align: center;">B Informational Messages</h3> <hr/> <div style="background-color: #f0f0f0; padding: 5px; text-align: center;"> <b>Informational Messages</b>              Reload RTDB from mate in progress         </div> <div style="background-color: #0056b3; color: white; padding: 2px 5px; text-align: center; font-family: monospace;">Tue June 12 2018 18:57:47 EDT</div> <p style="text-align: center; font-size: small;">Copyright © 2000, 2018, Oracle and/or its affiliates. All rights reserved.</p> </div> <div style="border: 1px solid black; padding: 10px;"> <h3 style="text-align: center;">B Informational Messages</h3> <hr/> <div style="background-color: #f0f0f0; padding: 5px; text-align: center;"> <b>Informational Messages</b>              Reload RTDB from mate completed successfully         </div> <div style="background-color: #0056b3; color: white; padding: 2px 5px; text-align: center; font-family: monospace;">Tue June 12 2018 19:01:21 EDT</div> <p style="text-align: center; font-size: small;">Copyright © 2000, 2018, Oracle and/or its affiliates. All rights reserved.</p> </div>
<p>5. <input type="checkbox"/></p>	<p><b>MPS A and B:</b> Restart the GUI Server process.</p>	<p><b>Log in to EPAP cli as root user:</b></p> <p><b>Login:</b> root</p> <p><b>Password:</b> &lt;root_password&gt;</p> <p><b>Run following commands to restart GUI server process</b></p> <p><b>\$ pkill gs</b></p>
<p>6. <input type="checkbox"/></p>	<p><b>MPS A and B:</b> Start the Epap software on EPAP A and B.</p>	<p><b>Run the following command on EPAP 16.3.1/16.4.1 Servers:</b></p> <pre>\$ [epapdev@Manaus-a ~]\$ service Epap start ~~ /etc/init.d/Epap start ~~</pre>

## Appendix A.11 RTDB Reload from Remote

		<pre> EPAP application started.  \$ \$ [epapdev@Manaus-a ~]\$ ssh mate \$ \$ [epapdev@Manaus-b ~]\$ Service Epap start ~~ /etc/init.d/Epap start ~~ EPAP application started.  \$ [epapdev@Manaus-b ~]\$ exit logout Run the following command on EPAP 17.1 to start EPAP Services:  [epapdev@Manaus-a logs]# systemctl start Epap [epapdev@Manaus-a ~]\$ ssh mate  =====    This system has been upgraded but the upgrade has not yet     been accepted or rejected. Please accept or reject the     upgrade soon.    =====  Last login: Fri Jan 20 03:50:19 2023 [epapdev@Manaus-b ~]\$ systemctl start Epap [epapdev@Manaus-b ~]\$ exit logout Connection to mate closed. ==== AUTHENTICATING FOR org.freedesktop.systemd1.manage-units ==== Authentication is required to start 'Epap.service'. Authenticating as: epapdev user (epapdev) Password: ==== AUTHENTICATION COMPLETE ==== [epapdev@Manaus-a ~]\$ </pre>
7.	<input type="checkbox"/> MPS A: Checking the RTDB Status	

## Appendix A.11 RTDB Reload from Remote

	<p>Log onto the GUI of the A server and select RTDB, View RTDB Status.</p> <p>Verify that the DB status for the local and the mate is Coherent.</p>	<p><b>B</b> <span style="float: right;">View RTDB Status</span></p> <hr/> <div style="border: 1px solid #ccc; padding: 5px;"> <p style="text-align: center; margin: 0;"><b>Local RTDB Status</b></p> <p>DB Status: <span style="color: green;">Coherent</span>      Audit Enabled: Yes  RTDB Level: 8      RTDB Birthday: 12/31/2014 15:01:20 GMT  PDB Level: 8      PDB Birthday: 12/31/2014 15:02:16 GMT  Counts:    IMSIs=0, DN=7, DN Blocks=0, NEs=1, ASDs=0  Tables:    IMSI=0, DN=1, IMEI=0, ASD=0  DB Size:    403 M      MinDsmSz: 14336 MB (1105 on epap240m)  Reload:    Unknown</p> </div> <div style="border: 1px solid #ccc; padding: 5px; margin-top: 5px;"> <p style="text-align: center; margin: 0;"><b>Mate RTDB Status</b></p> <p>DB Status: <span style="color: green;">Coherent</span>      Audit Enabled: Yes  RTDB Level: 8      RTDB Birthday: 12/31/2014 15:01:20 GMT  PDB Level: 8      PDB Birthday: 12/31/2014 15:02:16 GMT  Counts:    IMSIs=0, DN=7, DN Blocks=0, NEs=1, ASDs=0  Tables:    IMSI=0, DN=1, IMEI=0, ASD=0  DB Size:    403 M      MinDsmSz: 14336 MB (1105 on epap240m)  Reload:    Unknown</p> </div>
8. <input type="checkbox"/>	Procedure complete.	Procedure Complete.
9. <input type="checkbox"/>	Note down the timestamp in log.	Run the following command:  <b>\$ date</b>

## Procedure A.12 ISO Image download from Oracle Software Delivery Cloud

This procedure defines the step to download the ISO from OSDC and copy to the test server at specific path.

### Appendix A.12 ISO Image download from OSDC

<b>S T E P #</b>	<p>This procedure provides instructions to download an ISO image from OSDC and copy to the required server.</p> <p>Check off (✓) each step as it is completed. Boxes have been provided for this purpose under each step number.</p> <p><b>IF THIS PROCEDURE FAILS, CONTACT MY ORACLE SUPPORT AND ASK FOR UPGRADE ASSISTANCE.</b></p>	
1.	<b>MPS X:</b> Log in to the server as the "admusr" user.	<pre>[hostname] consolelogin: admusr password: &lt;admusr_password&gt;</pre>
2.	<b>MPS X:</b> Run syscheck to make sure there is no error.	<pre>Run the following command: \$ sudo syscheck  The output should look like: [admusr@hostname ~]\$ syscheck Running modules in class disk... OK Running modules in class hardware... OK</pre>

## Appendix A.12 ISO Image download from OSDC

		<pre>Running modules in class net...                                 OK Running modules in class proc...                                 OK Running modules in class system...                                 OK Running modules in class upgrade...                                 OK LOG LOCATION: /var/TKLC/log/syscheck/fail_log  Note: syscheck may report following error which can be ignored: * defaultroute: FAILURE:: MINOR::5000000000040000 -- Platform Health Check Failure * defaultroute: FAILURE:: ping6 return non-zero code * defaultroute: FAILURE:: MAJOR::3000000000020000 -- Server Default Route Network Error * defaultroute: FAILURE:: The IPv6 default route at fe80::f64e:5ff:fe49:9b7f cannot be pinged</pre>						
3.	<p><b>MPS X:</b> Verify ISO image doesn't already exist.</p>	<p>Run the following command to perform directory listing:  <b>\$ ls -alrt /var/TKLC/upgrade</b></p> <p>The output should look like as follows (There is no ISO is present in following example):</p> <pre>[admusr@Osorna-B-PDBonly ~]\$ ls -alrt /var/TKLC/upgrade/ total 12 drwxrwxr-x.  3 root admgrp 4096 Feb 19 21:43 . dr-xr-xr-x. 22 root root  4096 Jun 15  2018 ..</pre> <p>If an ISO image exists, remove it by executing the following command:  <b>\$ rm -f /var/TKLC/upgrade/&lt;ISO image&gt;</b></p>						
4.	<p><input type="checkbox"/> Download the ISO image from OSDC.</p>	<p>Download the ISO image from OSDC(Oracle Software Delivery Cloud).</p> <p>In case of DIU upgrade, please make sure to download the diuPreUpgrade.sh script along with the respective ISO.</p> <table border="1" data-bbox="536 1617 1497 1756"> <thead> <tr> <th>SI No</th> <th>Destination Plat type</th> <th>DIU ISO name</th> </tr> </thead> <tbody> <tr> <td>1</td> <td>Mixed</td> <td>EPAP-17.0.0.x.0_x.x.0-x86_64- <b>Mixed-NonProv</b> -DIU.iso</td> </tr> </tbody> </table>	SI No	Destination Plat type	DIU ISO name	1	Mixed	EPAP-17.0.0.x.0_x.x.0-x86_64- <b>Mixed-NonProv</b> -DIU.iso
SI No	Destination Plat type	DIU ISO name						
1	Mixed	EPAP-17.0.0.x.0_x.x.0-x86_64- <b>Mixed-NonProv</b> -DIU.iso						

## Appendix A.12 ISO Image download from OSDC

		2	Non-Prov	EPAP-17.0.0.x.0_x.x.0-x86_64- <b>Mixed-NonProv</b> -DIU.iso
		3	PDBonly	EPAP-17.0.0.x.0_x.x.0-x86_64-PDBonly-DIU.iso
		4	Segmented	EPAP-17.0.0.x.0_x.x.0-x86_64-PDBonly-DIU.iso
5.	<input type="checkbox"/> Copy the ISO from source path to destination path.	<p><b>NOTE: Skip this step if same ISO is already present on destination folder.</b></p> <p>Copy the ISO image from source path to destination path using scp/ftp command.</p> <p>Run the following command on destination server:</p> <pre>\$ sudo scp &lt;source_username&gt;@&lt;source_server_IP&gt;:/&lt;source_path&gt;/xyz.iso /var/TKLC/upgrade</pre> <p>Password: &lt;enter source userpassword&gt;</p> <p>OR,</p> <p>Run the following command on source server:</p> <pre>\$ scp /&lt;source_path&gt;/&lt;xyz.iso&gt; admusr@&lt;destination_server_IP&gt;:/var/TKLC/upgrade</pre> <p>Password: &lt;Enter admusr password&gt;</p>		
6.	<input type="checkbox"/> In case of DIU Upgrade, copy the diuPreUpgrade.sh, else skip this step.	<p><b>NOTE: Skip this step if same script is already present on destination folder.</b></p> <p>Copy the diuPreUpgrade.sh from source path to destination path using scp/ftp command.</p> <p>Run the following command on destination server:</p> <pre>\$ sudo scp &lt;source_username&gt;@&lt;source_server_IP&gt;:/&lt;source_path&gt;/diuPreUpgrade.sh /tmp</pre> <p>Password: &lt;enter source userpassword&gt;</p> <p>OR,</p>		

## Appendix A.12 ISO Image download from OSDC

		Run the following command on source server: <pre>\$ scp /&lt;source_path&gt;/&lt;diuPreUpgrade.sh&gt; admusr@&lt;destination_server_IP&gt;:/tmp Password: &lt;Enter admusr password&gt;</pre>
7. <input type="checkbox"/>	<b>MPS X:</b> Verify ISO image copied on destination path.	Run the following command to perform directory listing: <pre>\$ ls -alrt /var/TKLC/upgrade</pre> <p>The output should look like:  <pre>[admusr@hostname ~]\$ ls -alrt /var/TKLC/upgrade total 1599016 -r--r----- 1 root root 925388800 Aug 23 02:15 EPAP- 16.3.0.0.0_163.12.0-x86_64.iso dr-xr-xr-x. 22 root root 4096 Aug 23 02:31 .. drwxrwxr-x. 3 root admgrp 4096 Sep 11 04:38 .</pre> <p>Repeat this procedure from step 1 if EPAP ISO file is not as expected.</p> </p>
8.	<b>MPS X:</b> Validate ISO file.	Validate ISO file using 0.
9.	<b>Procedure complete.</b>	This procedure is complete.
10.	Note down the timestamp in log.	Run the following command: <pre>\$ date</pre>

## IPM MPS Server with TPD 8.6.0

**Note:** Both the MPS-A and MPS-B servers can be IPM'ed at the same time.

### Appendix A.13 IPM with TPD 8.6.0

<b>S T E P #</b>	This procedure will IPM the E5-APP-B Server.	
	Check off (✓) each step as it is completed. Boxes have been provided for this purpose under each step number.	
IF THIS PROCEDURE FAILS, CONTACT MY ORACLE SUPPORT AND <b>ASK FOR <u>UPGRADE ASSISTANCE</u></b> .		
1. <input type="checkbox"/>	<b>MPS X:</b> Insert TPD 8.6.0 USB media into the USB port (E5-APP-B)	Reboot server <pre># reboot</pre>

## Appendix A.13 IPM with TPD 8.6.0

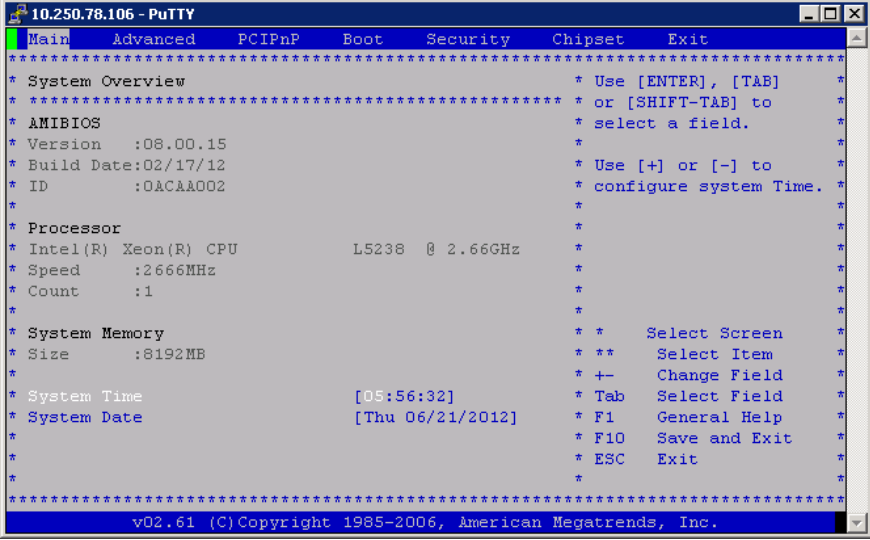
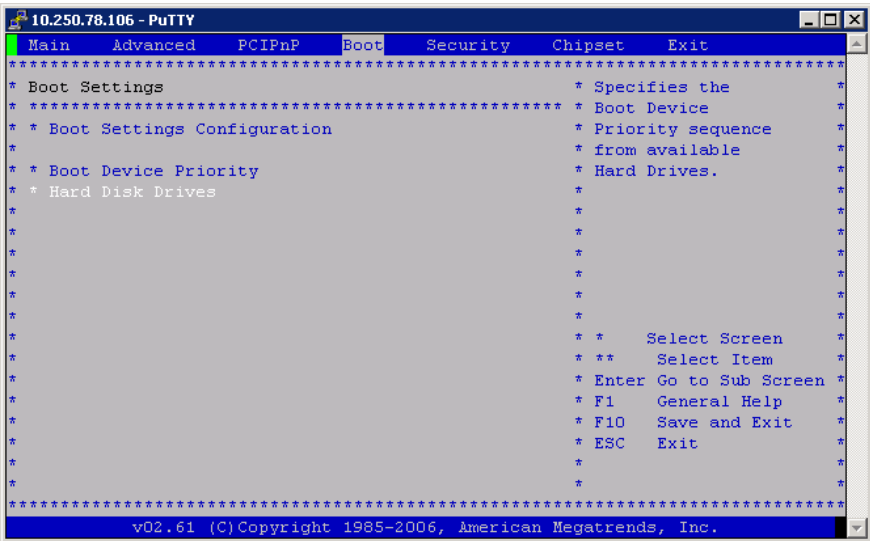
<p>2. <input type="checkbox"/></p>	<p><b>MPS X:</b> Press 'del' key to enter the BIOS, set System Time to GMT time, and System Date.</p>	 <p>The screenshot shows the BIOS 'System Overview' screen. The 'Main' menu is selected. The screen displays system information including AMIBIOS version (08.00.15), processor (Intel(R) Xeon(R) CPU L5238 @ 2.66GHz), system memory (8192MB), system time ([05:56:32]), and system date ([Thu 06/21/2012]). Navigation instructions are provided on the right side of the screen.</p>
<p>3. <input type="checkbox"/></p>	<p><b>MPS X:</b> Select <i>Boot</i> → <i>Hard Disk Drives</i> option</p>	 <p>The screenshot shows the BIOS 'Boot Settings' screen. The 'Boot' menu is selected. The screen displays boot settings including boot device priority and hard disk drives. Navigation instructions are provided on the right side of the screen.</p>
<p>4. <input type="checkbox"/></p>	<p><b>MPS X:</b> Press 'Enter' key and select USB as the 1<sup>st</sup> Drive</p>	

Appendix A.13 IPM with TPD 8.6.0

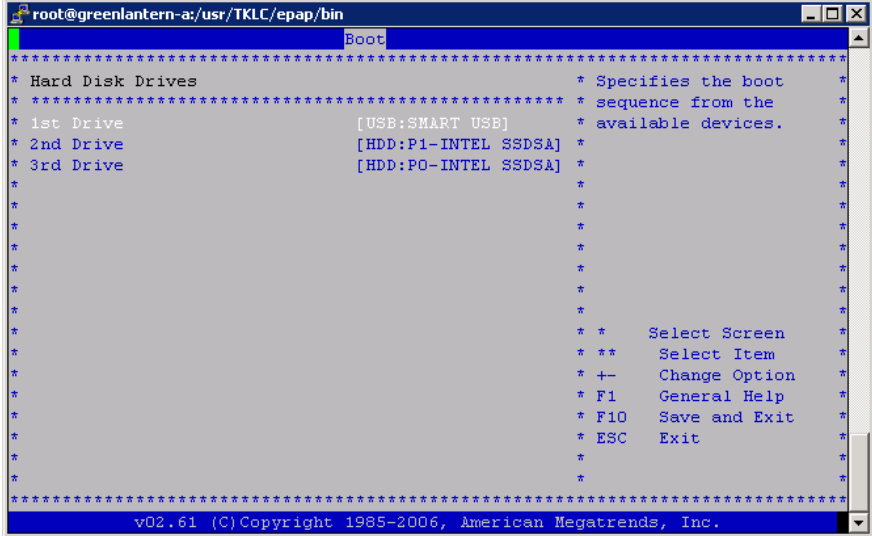
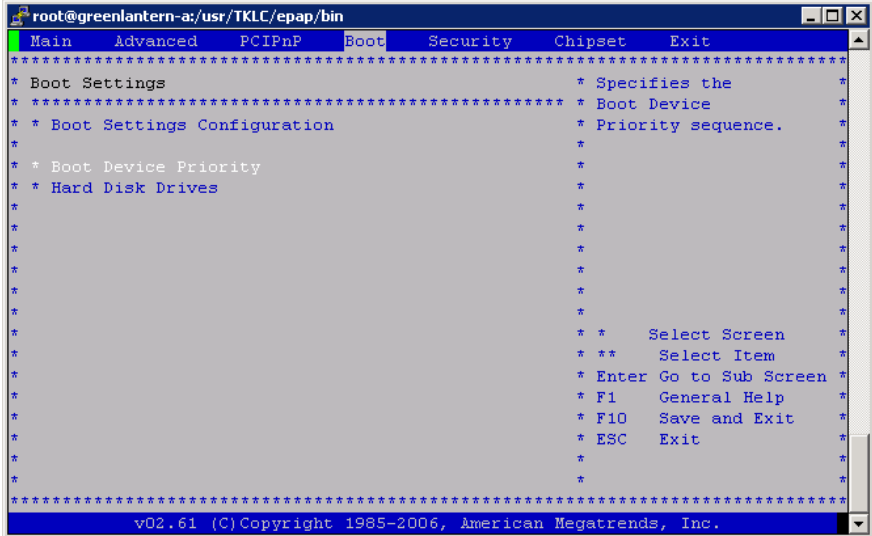
		
<p>5. <input type="checkbox"/></p>	<p><b>MPS X:</b> Press 'Esc' key and select Boot Device Priority</p>	
<p>6. <input type="checkbox"/></p>	<p><b>MPS X:</b> Verify that the 1<sup>st</sup> Boot Device is set to USB.</p>	

## Appendix A.13 IPM with TPD 8.6.0

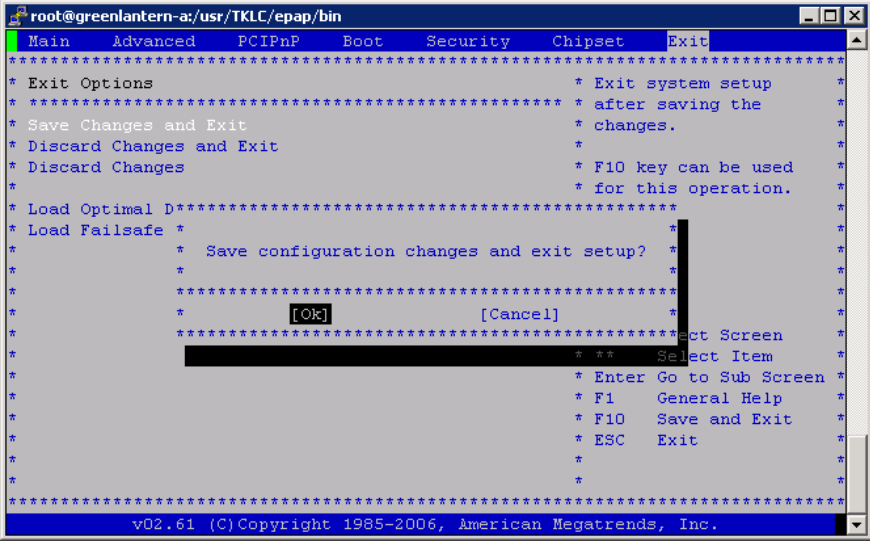
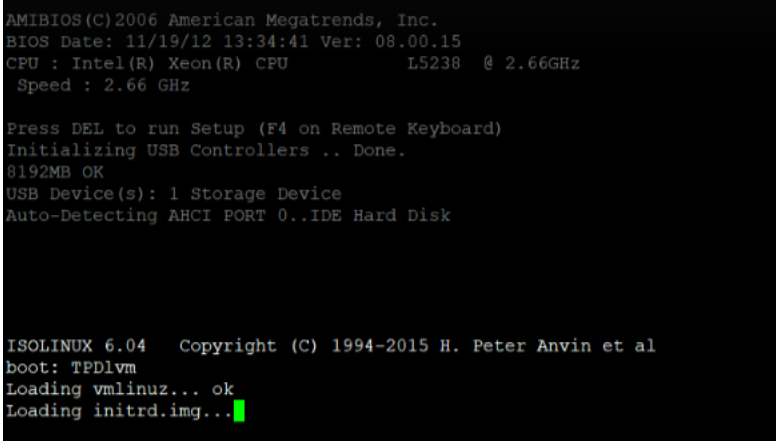

<p>7. <input type="checkbox"/></p>	<p><b>MPS X:</b> Press 'Esc' key and select <i>Exit</i> → <i>Save Changes and Exit</i> option</p>	
<p>8. <input type="checkbox"/></p>	<p><b>MPS X:</b> Select [OK] to save the configuration changes.  The server will reboot and TPD boot prompt will appear.</p>	

## Appendix A.13 IPM with TPD 8.6.0

		
<p>9. <input type="checkbox"/> <b>MPS X:</b> Start the IPM process by entering the TPDlvm command at the boot prompt.</p>		<p>Start the IPM process by entering the TPDlvm command at the boot prompt.</p> 

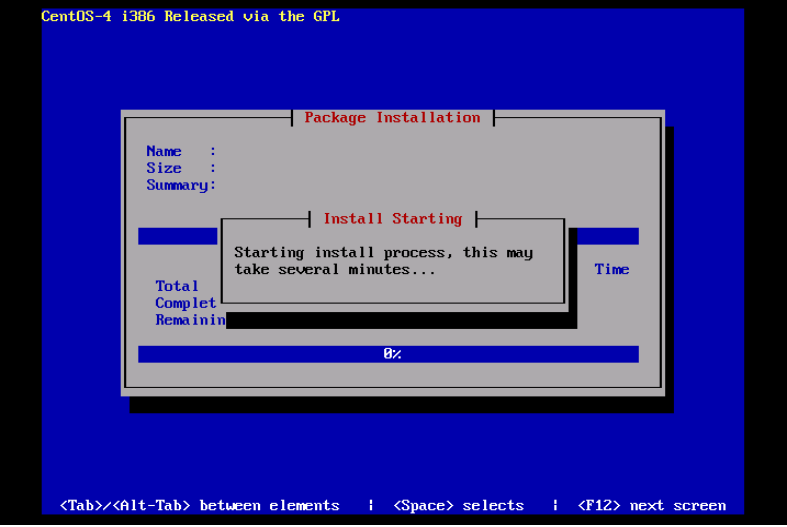

## Appendix A.13 IPM with TPD 8.6.0

	<p>Once the drive formatting and file system creation steps are complete, the screen at right will appear indicating that the package installation step is about to begin.</p> 
<p>12. <input type="checkbox"/> <b>MPS X:</b></p> <p>After a few minutes, you will see a screen similar to that at right, showing the status of the package installation step. For each package, there will be a status bar at the top indicating how much of the package has been installed, with a cumulative status bar at the bottom indicating how many packages remain. In the middle, you will see text statistics indicating the total number of packages, the number of packages installed, the number remaining, and current and projected time estimates.</p>	

## Appendix A.13 IPM with TPD 8.6.0

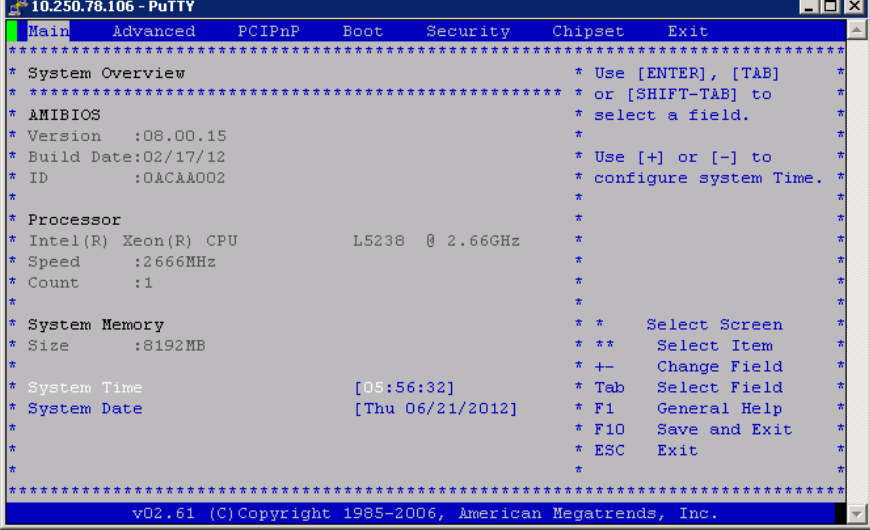
<p>13. <input type="checkbox"/></p>	<p><b>MPS X:</b> Once all the packages have been successfully installed, the screen at right will appear letting you know the installation process is complete.</p> <p><b>On E5-APP-B server remove the installation media (USB) and press &lt;ENTER&gt; to reboot the system and continue with the next step.</b></p>	<pre> MPOINT: Media already mounted.   DEV: /dev/sdc MPOINT: Media already mounted.   DEV: /dev/sdc MPOINT: Media already mounted.   DEV: /dev/sdc MPOINT: Pulling ISO Metadata file from: /run/install/repo/.isometadata Copying ISO metadata file to system DIR: /mnt/sysimage/var/TKLC/log/ipm Copying ISO metadata file to prodinfo DIR: /mnt/sysimage/usr/TKLC/plat/etc/prodinfo Changing default target to application.target Revoke root ssh access Installation complete  Use of this product is subject to the license agreement found at: /usr/share/oraclelinux-release/EULA  Installation complete. Press ENTER to quit: █ . </pre>
<p>14. <input type="checkbox"/></p>	<p><b>MPS X:</b> Press 'del' key to enter the BIOS, set correct System Time in GMT and System Date.</p>	
<p>15. <input type="checkbox"/></p>	<p><b>MPS X:</b> Select <i>Boot</i> → <i>Hard Disk Drives</i> option</p>	

## Appendix A.13 IPM with TPD 8.6.0

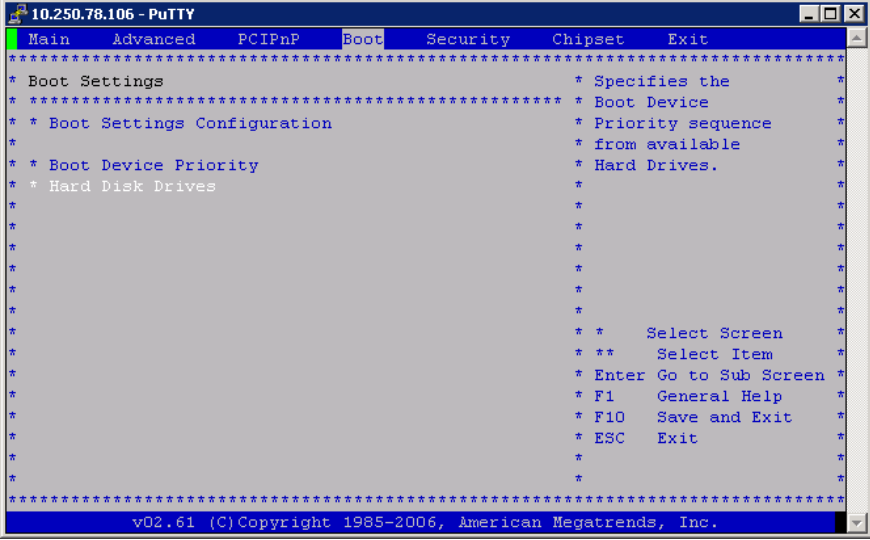
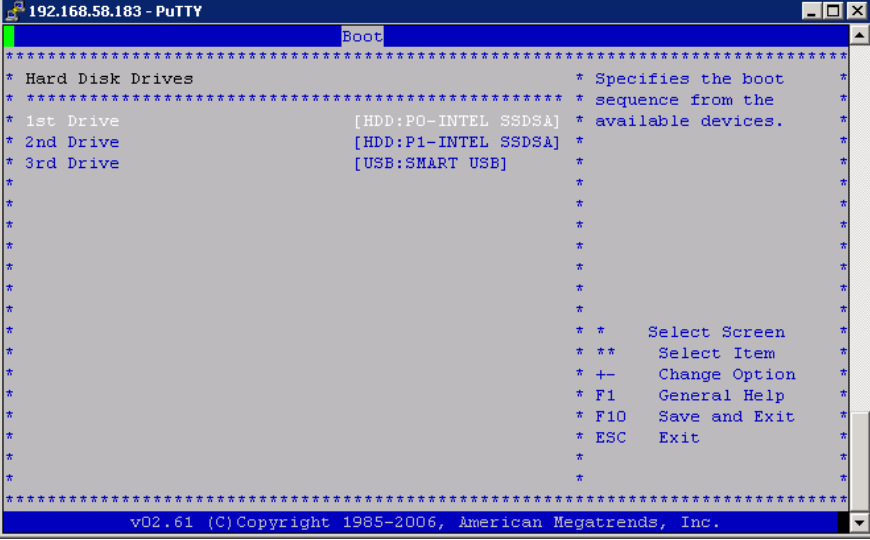
		
<p>16. <input type="checkbox"/></p>	<p><b>MPS X:</b> Press 'Enter' key and select HDD:P0 as the 1<sup>st</sup> Drive</p>	
<p>17. <input type="checkbox"/></p>	<p><b>MPS X:</b> Press 'Esc' key and select Boot Device Priority</p>	

## Appendix A.13 IPM with TPD 8.6.0

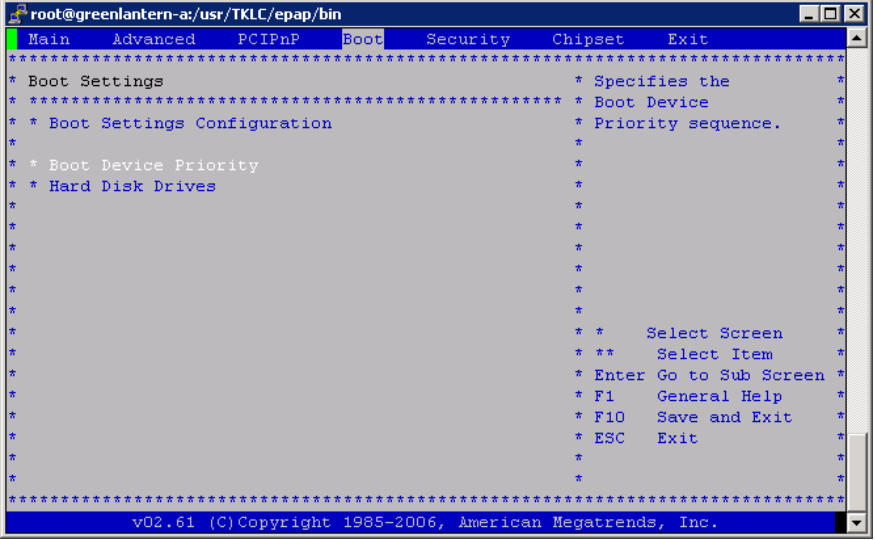
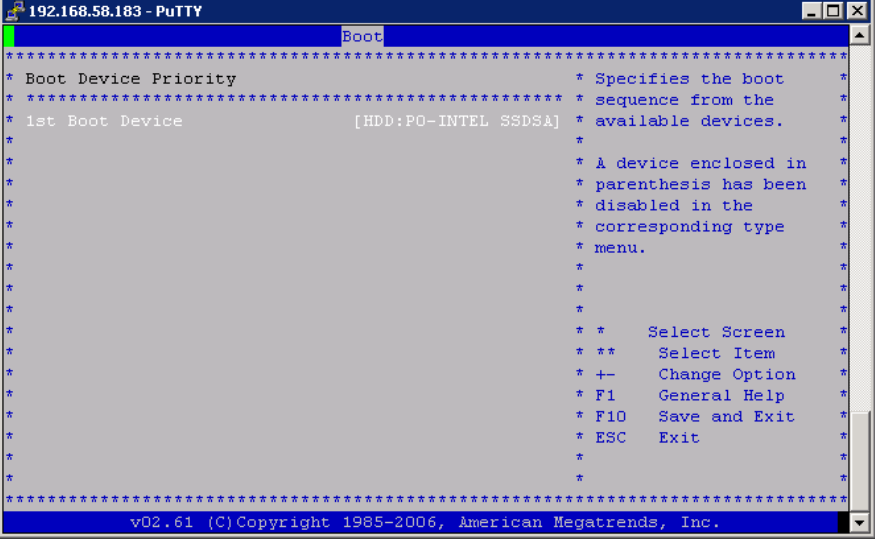
		
<p>18. <input type="checkbox"/></p>	<p><b>MPS X:</b> Verify that the 1<sup>st</sup> Boot Device is set to HDD:P0.</p>	
<p>19. <input type="checkbox"/></p>	<p><b>MPS X:</b> Press 'Esc' key and select <i>Exit</i> → <i>Save Changes and Exit</i> option</p>	

## Appendix A.13 IPM with TPD 8.6.0

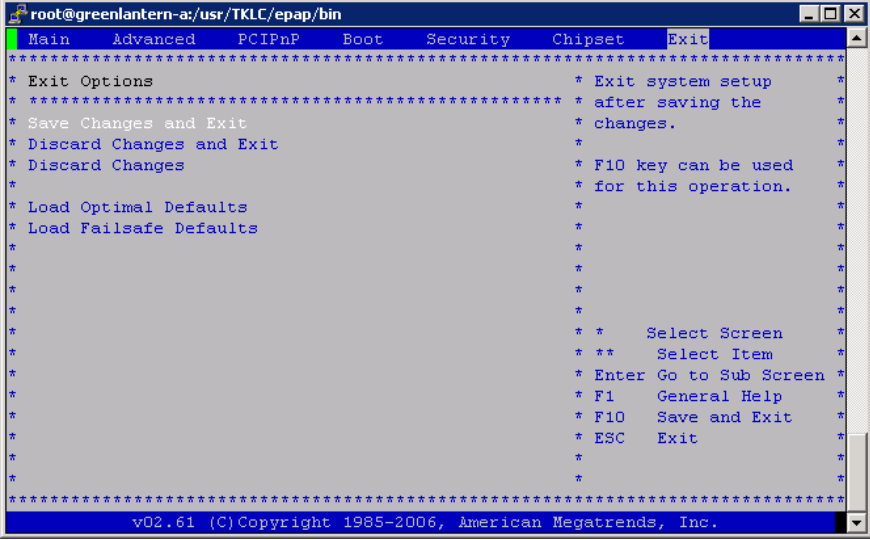
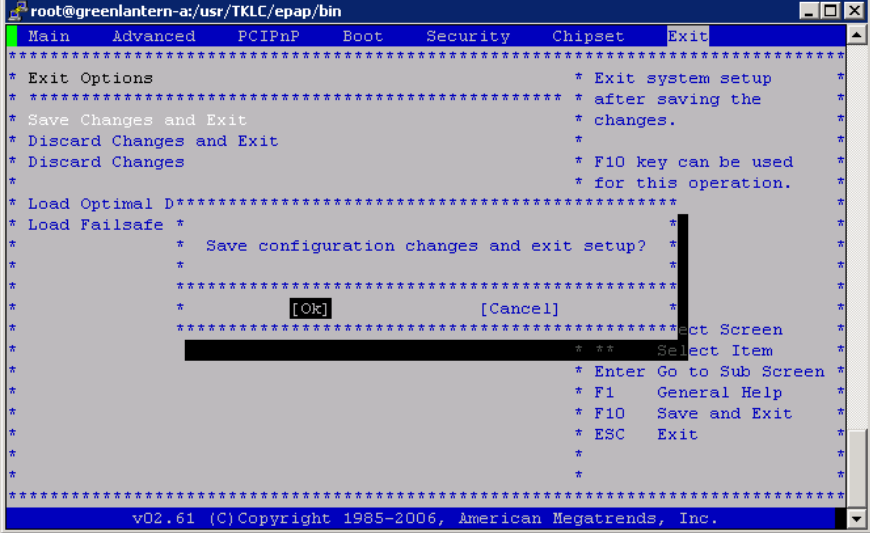
		
<p>20. <input type="checkbox"/></p>	<p><b>MPS X:</b> Select [OK] to save the configuration changes. The server will reboot.</p> <p>Remove USB media from USB drive.</p>	 <p>When the message "Upstart Job ntdMgr: started", is displayed, press the Enter Key to get the Login prompt.</p>
<p>21. <input type="checkbox"/></p>	<p><b>MPS X:</b> Log in to the server as the user "admusr"</p>	<p><b>console login:</b> admusr <b>password:</b> &lt;admusr_password&gt;</p>
<p>22. <input type="checkbox"/></p>	<p><b>MPS X:</b> Verify that the platform revision is same as the TPD DVD or ISO used.</p>	<p><b>\$ getPlatRev</b>  8.6.0.0.0_110.x.0</p>

### Appendix A.13 IPM with TPD 8.6.0

23. <input type="checkbox"/>	<b>MPS X:</b>  Verify the system date.	<pre>\$ date -u</pre> <p>Wed Mar 21 11:04:54 UTC 2018</p> <p>Verify that the output time matches the time set in step 14. If mismatch is found, then Refer to <b>My Oracle Support</b> section for instructions on accessing My Oracle Support.</p>
24. <input type="checkbox"/>	<b>Procedure complete.</b>	Return to the procedure that you came here from.
25. <input type="checkbox"/>	Note down the timestamp in log.	Run the following command:  <pre>\$ date</pre>

### Procedure A.14 Standalone PDB Segmented Configuration

**Note: All the networks (Prov, GUI and OAM) should be in different subnets. The networks can be a mix of IPv4 and IPv6 IPs.**

#### Appendix A.14 Standalone PDB Segmented Configuration

S T E P #	This procedure will configure the standalone PDB in segmented configuration.  Check off (✓) each step as it is completed. Boxes have been provided for this purpose under each step number.  <b>IF THIS PROCEDURE FAILS, CONTACT MY ORACLE SUPPORT AND ASK FOR <u>UPGRADE ASSISTANCE</u>.</b>	
1. <input type="checkbox"/>	<b>MPS A:</b> Log in to Server A.	<pre>[hostname] consolelogin: admusr password: password</pre>
2. <input type="checkbox"/>	<b>MPS A:</b> Switch user to epapconfig.	<pre>\$ sudo su - epapconfig</pre> <p>Warning: Smartmatch is experimental at /usr/TKLC/plat/lib/Security/User.pm line 904.</p>
3. <input type="checkbox"/>	<b>MPS A:</b> A note of caution appears. Press Return to continue.	<p>Caution: This is the first login of the text user interface.</p> <pre>Press return to continue...</pre>
4. <input type="checkbox"/>	<b>MPS A:</b> Upon pressing Return you can now abort or proceed with the initial configuration.	<pre>Are you sure you wish to continue? [N]:Y</pre>

## Appendix A.14 Standalone PDB Segmented Configuration

	To continue with the configuration, enter Y.	
5. <input type="checkbox"/>	<b>MPS A:</b> Enter the System Number and Network Configuration Type as "Segmented".	Building the initial database on side A. Stopping local slave No preexisting EuiDB database was detected. Set EPAP System Number: <b>&lt;Enter the System Number here&gt;</b> Enter the Network Configuration Type (1 for Single, 2 for Segmented): <b>2</b>
6. <input type="checkbox"/>	<b>MPS A:</b> The EPAP Configuration Menu is displayed. Select choice 2, Configure Network Interfaces Menu.	<pre> /-----EPAP Configuration Menu-----\ /-----\   1   Display Configuration  -----    2   Configure Network Interfaces Menu  -----    3   Set Time Zone  -----    4   Exchange Secure Shell Keys  -----    5   Change Password  -----    6   Platform Menu  -----    7   Configure NTP Server  -----    8   PDB Configuration Menu  -----    9   Security  -----   10   SNMP Configuration  -----   11   Configure Alarm Feed  -----   12   Configure Query Server  -----   13   Configure Query Server Alarm Feed  -----   14   Configure SNMP Agent Community  -----   15   DB Architecture Menu  -----    e   Exit \-----/ </pre> <p>Enter choice: 2</p>

## Appendix A.14 Standalone PDB Segmented Configuration

<p>7. <input type="checkbox"/></p>	<p><b>MPS A:</b> The Configure Network Interfaces Menu is displayed. Select choice 1, Configure Provisioning Network.</p>	<pre> /-----Configure Network Interfaces Menu-----\ /-----\   1   Configure Provisioning Network  -----    2   Configure GUI Network  -----    3   Configure Operations and Maintenance Network  -----    4   Configure Backup Provisioning Network  -----    5   Configure Static NAT Addresses  -----    e   Exit \-----\  Enter Choice: 1 </pre>
	<p>Note: Enter choice "1" for IPv4 configuration. Otherwise, enter choice "2" for IPv6 configuration.</p>	<pre> /-----Configure Provisioning Network Menu-----\ /-----\   1   IPv4 Configuration  -----    2   IPv6 Configuration  -----    e   Exit \-----\  Enter Choice: █ </pre> <p>Example output Standalone PDB in IPv4 configuration:</p> <pre> EPAP A provisioning network IP Address: 192.168.61.35 EPAP provisioning network netmask: 255.255.255.0 EPAP provisioning network default router: 192.168.61.250 </pre> <p>Select choice e to exit to the "Configure Network Interfaces" menu.</p>
<p>8. <input type="checkbox"/></p>	<p><b>MPS A:</b> The Configure Network Interfaces Menu is displayed. Select choice 2, Configure GUI Network.</p>	<pre> /-----Configure Network Interfaces Menu-----\ /-----\   1   Configure Provisioning Network  -----    2   Configure GUI Network  -----    3   Configure Operations and Maintenance Network  -----    4   Configure Backup Provisioning Network  -----    5   Configure Static NAT Addresses  -----    e   Exit \-----\  Enter Choice: 2 </pre>

## Appendix A.14 Standalone PDB Segmented Configuration

	<p><b>Note:</b> Enter choice “1” for IPv4 configuration. Otherwise, enter choice “2” for IPv6 configuration.</p>	<pre> /-----Configure GUI Network-\ /-----\   1   IPv4 Configuration    -----    2   IPv6 Configuration    -----    e   Exit   \-----\  Enter Choice: 1  Example output Standalone PDB in IPv4 configuration:  EPAP A GUI network IP Address: 192.168.59.27 EPAP GUI network netmask: 255.255.255.0 EPAP GUI network route: 192.168.59.250  Select choice e to exit to the “Configure Network Interfaces” menu. </pre>
<p>9. <input type="checkbox"/></p>	<p><b>MPS A:</b> The Configure Network Interfaces Menu is displayed. Select choice 3, Configure Operations and Maintenance Network.</p> <p><b>Note:</b> Enter choice “1” for IPv4 configuration. Otherwise, enter choice “2” for IPv6 configuration.</p>	<pre> /-----Configure Network Interfaces Menu-----\ /-----\   1   Configure Provisioning Network    -----    2   Configure GUI Network    -----    3   Configure Operations and Maintenance Network    -----    4   Configure Backup Provisioning Network    -----    5   Configure Static NAT Addresses    -----    e   Exit   \-----\  Enter Choice: 3  /-----Configure Operations and Maintenance Network-\ /-----\   1   IPv4 Configuration    -----    2   IPv6 Configuration    -----    e   Exit   \-----\  Enter Choice: 1  EPAP A Operations and Maintenance network IP Address: 192.168.60.26 EPAP Operations and Maintenance network netmask: 255.255.255.0 EPAP Operations and Maintenance network route: 192.168.60.250  Select choice e to exit to the “Configure Network Interfaces” menu. </pre>

## Appendix A.14 Standalone PDB Segmented Configuration

<p>10. <input type="checkbox"/></p>	<p><b>MPS A:</b> Select choice e to exit from the epapconfig menu.</p>	<pre> /-----Configure Network Interfaces Menu-----\ /-----\ 1   Configure Provisioning Network 2   Configure GUI Network 3   Configure Operations and Maintenance Network 4   Configure Backup Provisioning Network 5   Configure Static NAT Addresses e   Exit \-----/  Enter Choice: e  /-----EPAP Configuration Menu-----\ /-----\ 1   Display Configuration 2   Configure Network Interfaces Menu 3   Set Time Zone 4   Exchange Secure Shell Keys 5   Change Password 6   Platform Menu 7   Configure NTP Server 8   PDB Configuration Menu 9   Security 10   SNMP Configuration 11   Configure Alarm Feed 12   Configure Query Server 13   Configure Query Server Alarm Feed 14   Configure SNMP Agent Community 15   DB Architecture Menu e   Exit \-----/  Enter Choice: 2 </pre>
-------------------------------------	--	---

## Appendix A.14 Standalone PDB Segmented Configuration

		Enter Choice: <b>e</b>  Note: If this menu is not exited properly, then the SSH login with root shall remain enabled.
11. <input type="checkbox"/>	<b>MPS A:</b> Procedure is complete.	Procedure is complete.
12. <input type="checkbox"/>	Note down the timestamp in log.	Run the following command:  <b>\$ date</b>

## Procedure A.15 Password change for EPAP System Users

### Appendix A.15 Password change for EPAP System Users

<b>S T E P #</b>	This procedure will change the password for the EPAP System User(s).	
	Check off (✓) each step as it is completed. Boxes have been provided for this purpose under each step number.	
	IF THIS PROCEDURE FAILS, CONTACT MY ORACLE SUPPORT AND ASK FOR <b>UPGRADE ASSISTANCE</b> .	
	1. <input type="checkbox"/>	<b>MPS A:</b> Log in to Server A with the EPAP System User for which the password is to be changed.
		<b>[hostname]: &lt;EPAP System User&gt;</b> <b>password: &lt;epapdev password&gt;</b>
2. <input type="checkbox"/>	<b>MPS A:</b> Change Password for an EPAP system user	Run the command to change to password of an existing EPAP user.  <b>\$ passwd</b> Changing password for user <EPAP System User>. Changing password for <EPAP System User>. (current) UNIX password: <b>&lt;Enter the current password here&gt;</b> New password: <b>&lt;Enter the new password here&gt;</b> Retype new password: <b>&lt;Retype the new password here&gt;</b> passwd: all authentication tokens updated successfully.  Note: The Linux “passwd” command used to change the password of Linux users, follows the Linux PAM rules. Refer to the Linux manual for the PAM rules.  <b># man pam_cracklib</b>
3. <input type="checkbox"/>	<b>MPS B:</b> Change Password	Repeat steps 1 and 2 on MPS B also.  <b>Note:</b> The new password on MPS A and B should be same.

## Appendix A.15 Password change for EPAP System Users

4. <input type="checkbox"/>	<b>MPS A: Procedure Complete</b>	This procedure is complete.
5. <input type="checkbox"/>	Note down the timestamp in log.	Run the following command: \$ date

## E5-APP-B Halt/Shutdown

### Appendix A.16 E5-APP-B Halt/Shutdown

<b>S T E P #</b>	<p>This procedure will halt the E5-APP-B hardware.</p> <p>Check off (✓) each step as it is completed. Boxes have been provided for this purpose under each step number.</p> <p>IF THIS PROCEDURE FAILS, CONTACT MY ORACLE SUPPORT AND <b>ASK FOR <u>UPGRADE ASSISTANCE</u></b>.</p>	
1. <input type="checkbox"/>	<p><b>E5APPB Card:</b> Slide the ejector switch.</p>	<p>On the APP-B card, slide the Ejector switch (4) up to the UNLOCKED position. Refer to Figure 6.</p> <p>Caution: If the Ejector switch goes from locked to unlocked and the E5-APP-B card is in service, the card will halt.</p>
2. <input type="checkbox"/>	<p><b>E5APPB Card:</b> Monitor the Eject Status LED</p>	<p>WAIT for the E5-APP-B Eject Status LED to go from blinking red to a steady red.</p>
3. <input type="checkbox"/>	<p><b>E5APPB Card:</b> Lever Release</p>	<p>Grasp the upper and lower card Inject/Eject (I/E) lever release (3) just underneath the I/E lever, and press it to meet the I/E lever. This is the mechanical interlock for the card. Refer to Figure 7.</p>
4. <input type="checkbox"/>	<p><b>E5APPB Card:</b> Pull out the levers</p>	<p>While holding the I/E interlock and lever, pull the levers (2) away from the shelf until they are parallel to the floor. Refer to Figure 7.</p>
5. <input type="checkbox"/>	<p><b>E5APPB Card:</b> Slide the ejector switch</p>	<p>Remove the E5-APP-B card from the EAGLE shelf.</p>
6. <input type="checkbox"/>	<p><b>MPS A: Procedure Complete</b></p>	<p>This procedure is complete.</p>
7. <input type="checkbox"/>	<p>Note down the timestamp in log.</p>	<p>Run the following command:</p> <pre>\$ date</pre>

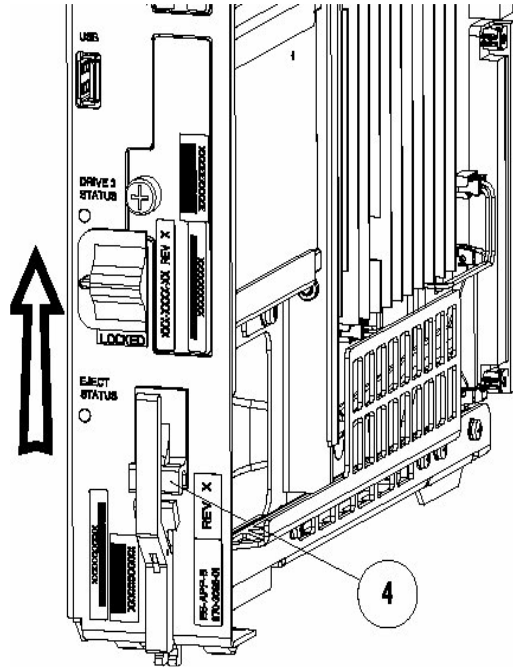

**Figure 6: Slide the Ejector Switch**

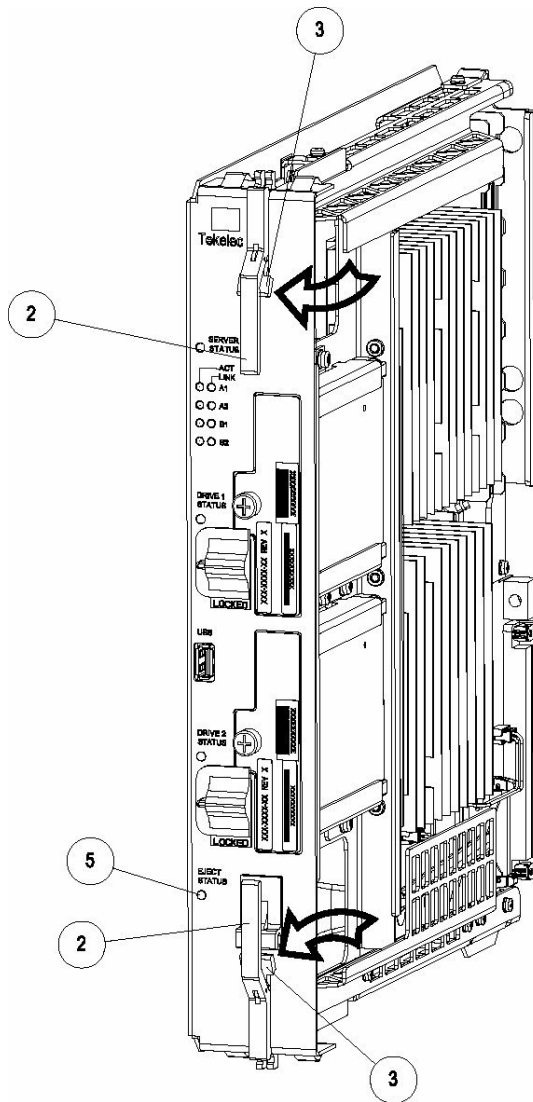

Figure 7: Release Lever

**Procedure to Configure EPAP switch ports and EAGLE SM cards to support 1G EPAP-to-Eagle RTDB download speed**

**Note:** This needs to be done in coordination with the EAGLE team.

**Appendix A.17 Procedure to Configure EPAP switch ports and EAGLE SM cards to support 1G EPAP-to-Eagle RTDB download speed**

<b>S T E P #</b>	<p>This procedure will configure EPAP Switch ports and Eagle SM cards to support 1G EPAP-to-EAGLE download speed.</p> <p>Note: Estimated time of completion is 20 minutes.</p>	
1. <input type="checkbox"/>	<p><b>E5-APP-B A/B:</b> Configure the SM ports on EPAP switch to 1000 Mbps.</p>	<p>Follow 0 to Configure the SM ports on EPAP switch to 1000 Mbps</p>
2. <input type="checkbox"/>	<p><b>EAGLE:</b> Configure Ethernet port on EAGLE SM cards that connects to EPAP to Auto-negotiate.</p>	<p>Eagle Command to configure an Ethernet port on EAGLE SM cards that connects to EPAP: CHG-IP-LNK:LOC=&lt;SM card location&gt;:PORT=&lt;Port&gt;:IPADDR=&lt;IP Address&gt;:SUBMASK=&lt;Subnet Mask&gt;:MCAST=YES:AUTO=YES</p>
3. <input type="checkbox"/>	<p><b>EAGLE:</b> Verify the auto negotiation status of the Ethernet ports on EAGLE SM cards that connects to EPAP. Make sure the ports are getting auto-negotiated to 1000Mbps/Full Duplex.</p>	<p>Eagle Command to verify auto negotiation status of an Ethernet port on EAGLE SM cards that connects to EPAP: PASS: LOC=&lt;SM card location&gt;:CMD="NETSTAT -I" Please go through the "Identifying the Ethernet port status on SM cards using "NETSTAT -I" display" section below.</p> <p>If ports on SM cards are getting auto-negotiated to 1000Mbps/Full Duplex correctly, then stop here. Otherwise continue with next step.</p>
4. <input type="checkbox"/>	<p><b>E5-APP-B A/B:</b> Configure the SM ports on EPAP switch to auto-negotiate.</p>	<p>Follow 0 to Configure the SM ports on EPAP switch to 'auto'.</p>
5. <input type="checkbox"/>	<p><b>EAGLE:</b> Verify the auto negotiation status of a Ethernet port on EAGLE SM cards that connects to EPAP. Make sure the ports are getting auto-negotiated to 1000Mbps/Full Duplex.</p>	<p>Eagle Command to verify auto negotiation status of an Ethernet port on EAGLE SM cards that connects to EPAP: PASS: LOC=&lt;SM card location&gt;:CMD="NETSTAT -I" Please go through the "Identifying the Ethernet port status on SM cards using "NETSTAT -I" display" section below</p>
6. <input type="checkbox"/>	<p>Note down the timestamp in log.</p>	<p>Run the following command:  <b>\$ date</b></p>

## Identifying the Ethernet port status on SM cards using "NETSTAT -I" display:

SM8G-B card running SCCPHC:

gei (unit number 2) = ExAP Port A  
gei (unit number 3) = ExAP Port B

SM8G-B card running SCCPHC:

gei (unit number 2) = ExAP Port A  
gei (unit number 3) = ExAP Port B

> rept-stat-card:mode=full:loc=1307

```
eagle1 17-05-04 16:43:49 MST EAGLE 46.5.0.0.0-70.29.0
CARD  VERSION      TYPE      GPL      PST      SST      AST
1307  140-029-000  DSM      SCCPHC   IS-ANR   MPS Unavl  -----
  ALARM STATUS      = No Alarms.
  BLMCAP  GPL version = 140-029-000
  IMT BUS A          = Conn
  IMT BUS B          = Disc
  CLOCK A           = Fault
  CLOCK B           = Active
  CLOCK I           = Idle
  MBD BIP STATUS    = Valid
  MOTHER BOARD ID   = SMXG B
  DBD STATUS        = Valid
  DBD TYPE          = None
  DBD MEMORY SIZE   = 8192M
  HW VERIFICATION CODE= ----
  FPGA VERSION      = 9
  BIOS VERSION      = 0ABSV01
  PSOC VERSION      = 0.1
  CURRENT TEMPERATURE = 34C ( 94F)
  PEAK TEMPERATURE: = 34C ( 94F) [17-05-04 15:49]
  SCCP % OCCUP      = 0%
  SCCP SM DATA TYPE = DN
  APPLICATION SERVICING
                                     MFC      MFC
  SNM    REQ STATUS = 24 hr: ---, 5 min: ---
  INM    REQ STATUS = 24 hr: ---, 5 min: ---
  MTP3   REQ STATUS = 24 hr: ---, 5 min: ---
  SFLOG  REQ STATUS = 24 hr: ---, 5 min: ---
  IPLNK STATUS
  IPLNK  IPADDR      STATUS    PST
  A      192.168.120.21  DOWN     OOS-MT
  B      192.168.121.21  DOWN     OOS-MT
  DSM IP CONNECTION
  PORT   PST         SST
  A      OOS-MT     Unavail
  B      OOS-MT     Unavail
```

Command Completed.

;

> pass:loc=1307:cmd="netstat -i"

```
eagle1 17-05-04 16:44:26 MST EAGLE 46.5.0.0.0-70.29.0
```

## SDS Shell Output

```
-> tklc_ifShow
lo (unit number 0):
  Flags: (0x48049) UP LOOPBACK MULTICAST TRAILERS ARP RUNNING INET_UP
  Type: SOFTWARE_LOOPBACK
  inet: 127.0.0.1
  Netmask 0xff000000 Subnetmask 0xff000000
  Metric is 0
  Maximum Transfer Unit size is 1536
  0 packets received; 1 packets sent
  0 multicast packets received
  0 multicast packets sent
  0 input errors; 0 output errors
  0 collisions; 0 dropped
  0 output queue drops
DPLend (unit number 0):
  Flags: (0x20043) UP BROADCAST ARP RUNNING
  Type: ETHERNET_CSMACD
  Ethernet address is 00:00:00:00:00:00
  Metric is 0
  Maximum Transfer Unit size is 485
  0 octets received
  0 octets sent
  0 unicast packets received
  0 unicast packets sent
  0 non-unicast packets received
  0 non-unicast packets sent
  0 incoming packets discarded
  0 outgoing packets discarded
  0 incoming errors
  0 outgoing errors
  0 unknown protos
  0 collisions; 0 dropped
  0 output queue drops
gei (unit number 2):
  Flags: (0x78043) UP BROADCAST MULTICAST ARP RUNNING INET_UP
  PHY Flags: (0x12114) AUTONEG 1000MB FDX DIX
  Type: ETHERNET_CSMACD
  inet: 192.168.120.21
  Broadcast address: 192.168.120.255
  Netmask 0xffffffff Subnetmask 0xffffffff
  Ethernet address is 00:00:17:0e:b7:d2
  Metric is 0
  Maximum Transfer Unit size is 1500
  250214 octets received
  122200 octets sent
  0 unicast packets received
  0 unicast packets sent
  0 multicast packets received
  0 multicast packets sent
  2075 broadcast packets received
  940 broadcast packets sent
  0 incoming packets discarded
  0 outgoing packets discarded
  0 incoming errors
  0 outgoing errors
  0 unknown protos
  0 collisions; 0 dropped
  0 output queue drops
gei (unit number 3):
```

```

Flags: (0x78043) UP BROADCAST MULTICAST ARP RUNNING INET_UP
PHY Flags: (0x12114) AUTONEG 1000MB FDX DIX
Type: ETHERNET_CSMACD
inet: 192.168.121.21
Broadcast address: 192.168.121.255
Netmask 0xffffffff Subnetmask 0xffffffff
Ethernet address is 00:00:17:0e:b7:d3
Metric is 0
Maximum Transfer Unit size is 1500
248920 octets received
121290 octets sent
0 unicast packets received
0 unicast packets sent
0 multicast packets received
0 multicast packets sent
2062 broadcast packets received
933 broadcast packets sent
0 incoming packets discarded
0 outgoing packets discarded
0 incoming errors
0 outgoing errors
0 unknown protos
0 collisions; 0 dropped
0 output queue drops
value = 26 = 0x1a

```

;

```
eagle1 17-05-04 16:44:36 MST EAGLE 46.5.0.0.0-70.29.0
```

```
NETSTAT command complete
```

;

SM8G-B card running SCCP64:

```
gei (unit number 4) = ExAP Port A
gei (unit number 5) = ExAP Port B
```

```
> rept-stat-card:mode=full:loc=1307
```

```

eagle1 17-05-04 17:00:01 MST EAGLE 46.5.0.0.0-70.29.0
CARD   VERSION      TYPE      GPL      PST      SST      AST
1307   140-029-000   DSM      SCCP64   IS-ANR   MPS Unavl  -----
ALARM STATUS           = No Alarms.
BLDC64  GPL version = 140-029-000
IMT BUS A              = Conn
IMT BUS B              = Disc
CLOCK A                = Fault
CLOCK B                = Active
CLOCK I                = Idle
MBD BIP STATUS         = Valid
MOTHER BOARD ID       = SMXG B
DBD STATUS             = Valid
DBD TYPE               = None
DBD MEMORY SIZE        = 8192M
HW VERIFICATION CODE= -----
FPGA VERSION          = 9

```

```
BIOS VERSION          = 0ABSV01
PSOC VERSION          = 0.1
CURRENT TEMPERATURE  = 34C ( 94F)
PEAK TEMPERATURE:    = 34C ( 94F)    [17-05-04 15:49]
SCCP % OCCUP          = 0%
SCCP SM DATA TYPE   = DN
APPLICATION SERVICING
```

```

MFC          MFC
SNM   REQ STATUS = 24 hr: ---, 5 min: ---
INM   REQ STATUS = 24 hr: ---, 5 min: ---
MTP3  REQ STATUS = 24 hr: ---, 5 min: ---
SFLOG REQ STATUS = 24 hr: ---, 5 min: ---
IPLNK STATUS
IPLNK IPADDR          STATUS      PST
A     192.168.120.21  DOWN        OOS-MT
B     192.168.121.21  DOWN        OOS-MT
DSM IP CONNECTION
PORT  PST            SST
A     OOS-MT         Unavail
B     OOS-MT         Unavail
```

Command Completed.

;

```
> pass:loc=1307:cmd="netstat -i"
```

```
eagle1 17-05-04 17:00:14 MST EAGLE 46.5.0.0.0-70.29.0
SDS Shell Output
```

```
shellLib: unknown LED mode vi.
-> tklc_ifShow
lo0 Link type:Local loopback Queue:none
inet 127.0.0.1 mask 255.255.255.255
inet6 unicast fe80::1%lo0 prefixlen 64 automatic
inet6 unicast ::1 prefixlen 128
UP RUNNING LOOPBACK MULTICAST NOARP ALLMULTI
MTU:1500 metric:1 VR:0 ifindex:1
RX packets:761 mcast:3 errors:0 dropped:0
TX packets:761 mcast:3 errors:0
collisions:0 unsupported proto:0
RX bytes:85k TX bytes:85k

gei4 Link type:Ethernet HWaddr 00:00:17:0e:b7:d2 Queue:none
capabilities: TXCSUM TX6CSUM
inet 192.168.120.21 mask 255.255.255.0 broadcast 192.168.120.255
inet6 unicast fe80::200:17ff:fe0e:b7d2%gei4 prefixlen 64 automatic
UP RUNNING SIMPLEX BROADCAST MULTICAST
MTU:1500 metric:1 VR:0 ifindex:2
RX packets:791 mcast:0 errors:0 dropped:0
TX packets:386 mcast:6 errors:0
collisions:0 unsupported proto:0
RX bytes:92k TX bytes:48k

gei5 Link type:Ethernet HWaddr 00:00:17:0e:b7:d3 Queue:none
capabilities: TXCSUM TX6CSUM
inet 192.168.121.21 mask 255.255.255.0 broadcast 192.168.121.255
inet6 unicast fe80::200:17ff:fe0e:b7d3%gei5 prefixlen 64 automatic
UP RUNNING SIMPLEX BROADCAST MULTICAST
MTU:1500 metric:1 VR:0 ifindex:3
```

```

RX packets:783 mcast:0 errors:0 dropped:0
TX packets:386 mcast:6 errors:0
collisions:0 unsupported proto:0
RX bytes:91k TX bytes:48k

gei (unit number 4):
  PHY Flags: (0x12114) AUTONEG 1000MB FDX DIX
gei (unit number 5):
  PHY Flags: (0x12114) AUTONEG 1000MB FDX DIX
value = 1 = 0x1

;

SM8G-B card running ENUMHC/DEIRHC/SIPHC:

gei (unit number 2) = ExAP Port
gei (unit number 3) = Signaling Port

> rept-stat-card:mode=full:loc=1317

eagle1 17-05-04 15:46:06 MST EAGLE 46.5.0.0.0-70.29.0
CARD VERSION TYPE GPL PST SST AST
1317 140-029-000 DSM ENUMHC IS-ANR MPS Unavl -----
ALARM STATUS = No Alarms.
BLMCAP GPL version = 140-029-000
IMT BUS A = Conn
IMT BUS B = Disc
CLOCK A = Fault
CLOCK B = Active
CLOCK I = Idle
MBD BIP STATUS = Valid
MOTHER BOARD ID = SMXG B
DBD STATUS = Valid
DBD TYPE = None
DBD MEMORY SIZE = 8192M
HW VERIFICATION CODE= ----
FPGA VERSION = 9
BIOS VERSION = 0ABSV01
PSOC VERSION = 0.1
CURRENT TEMPERATURE = 34C ( 94F)
PEAK TEMPERATURE: = 34C ( 94F) [17-05-02 09:31]
ENUM SM DATA TYPE = DN
IPLNK STATUS
IPLNK IPADDR STATUS PST
A 192.168.120.13 UP IS-NR
B 10.75.49.21 UP IS-NR
C ----- ---- ----
D ----- ---- ----
DSM IP CONNECTION
PORT PST SST
A OOS-MT Unavail
D OOS-MA Ueq
ENUM CONNECTION STATUS
CNAME PROT STATUS

Command Completed.

;

> pass:loc=1317:cmd="netstat -i"

Command Accepted - Processing

```

```

eagle1 17-05-04 15:46:46 MST EAGLE 46.5.0.0.0-70.29.0
pass:loc=1317:cmd="netstat -i"
Command entered at terminal #13.
;

eagle1 17-05-04 15:46:46 MST EAGLE 46.5.0.0.0-70.29.0
PASS: Command sent to card
;

eagle1 17-05-04 15:46:46 MST EAGLE 46.5.0.0.0-70.29.0
SDS Shell Output

-> tklc_ifShow
lo (unit number 0):
  Flags: (0x48049) UP LOOPBACK MULTICAST TRAILERS ARP RUNNING INET_UP
  Type: SOFTWARE_LOOPBACK
  inet: 127.0.0.1
  Netmask 0xff000000 Subnetmask 0xff000000
  Metric is 0
  Maximum Transfer Unit size is 1536
  0 packets received; 1 packets sent
  0 multicast packets received
  0 multicast packets sent
  0 input errors; 0 output errors
  0 collisions; 0 dropped
  0 output queue drops
DPLend (unit number 0):
  Flags: (0x20043) UP BROADCAST ARP RUNNING
  Type: ETHERNET_CSMACD
  Ethernet address is 00:00:00:00:00:00
  Metric is 0
  Maximum Transfer Unit size is 485
  0 octets received
  0 octets sent
  0 unicast packets received
  0 unicast packets sent
  0 non-unicast packets received
  0 non-unicast packets sent
  0 incoming packets discarded
  0 outgoing packets discarded
  0 incoming errors
  0 outgoing errors
  0 unknown protos
  0 collisions; 0 dropped
  0 output queue drops
gei (unit number 2):
  Flags: (0x78043) UP BROADCAST MULTICAST ARP RUNNING INET_UP
  PHY Flags: (0x12114) AUTONEG 1000MB FDX DIX
  Type: ETHERNET_CSMACD
  inet: 192.168.120.13
  Broadcast address: 192.168.120.255
  Netmask 0xfffff00 Subnetmask 0xfffff00
  Ethernet address is 00:00:17:0e:b7:d2
  Metric is 0
  Maximum Transfer Unit size is 1500
  16128 octets received
  102048 octets sent
  0 unicast packets received
  0 unicast packets sent
  0 multicast packets received

```

```

0 multicast packets sent
252 broadcast packets received
786 broadcast packets sent
0 incoming packets discarded
0 outgoing packets discarded
0 incoming errors
0 outgoing errors
0 unknown protos
0 collisions; 0 dropped
0 output queue drops
gei (unit number 3):
Flags: (0x70043) UP BROADCAST ARP RUNNING INET_UP
PHY Flags: (0x12012) AUTONEG 1000MB FDX DIX
Type: ETHERNET_CSMACD
inet: 10.75.49.21
Broadcast address: 10.75.49.255
Netmask 0xff000000 Subnetmask 0xffffffff00
Ethernet address is 00:00:17:0e:b7:d3
Metric is 0
Maximum Transfer Unit size is 1500
0 octets received
128 octets sent
0 unicast packets received
0 unicast packets sent
0 multicast packets received
0 multicast packets sent
0 broadcast packets received
2 broadcast packets sent
0 incoming packets discarded
0 outgoing packets discarded
0 incoming errors
0 outgoing errors
0 unknown protos
0 collisions; 0 dropped
0 output queue drops
value = 26 = 0x1a
;
eagle1 17-05-04 15:46:56 MST EAGLE 46.5.0.0.0-70.29.0
;
eagle1 17-05-04 15:46:56 MST EAGLE 46.5.0.0.0-70.29.0
NETSTAT command complete
;
SM8G-B card running ENUM64/DEIR64/SIP64:
gei (unit number 4) = ExAP Port
gei (unit number 5) = Signaling Port
> rept-stat-card:mode=full:loc=1317
eagle1 17-05-04 15:23:31 MST EAGLE 46.5.0.0.0-70.29.0
CARD VERSION TYPE GPL PST SST AST
1317 140-029-000 DSM ENUM64 IS-ANR MPS Unavl -----

```

```

ALARM STATUS          = ** 0080 Shelf FAN bit is OFF
BLDC64 GPL version   = 140-029-000
IMT BUS A            = Conn
IMT BUS B            = Disc
CLOCK A              = Fault
CLOCK B              = Active
CLOCK I              = Idle
MBD BIP STATUS       = Valid
MOTHER BOARD ID      = SMXG B
DBD STATUS           = Valid
DBD TYPE              = None
DBD MEMORY SIZE      = 8192M
HW VERIFICATION CODE= ----
FPGA VERSION         = 9
BIOS VERSION         = 0ABSV01
PSOC VERSION         = 0.1
CURRENT TEMPERATURE  = 34C ( 94F)
PEAK TEMPERATURE:    = 34C ( 94F)      [17-05-02 09:31]
ENUM SM DATA TYPE   = DN
IPLNK STATUS
  IPLNK  IPADDR          STATUS      PST
  A      192.168.120.13  UP        IS-NR
  B      10.75.49.21     UP        IS-NR
  C      -----        ----
  D      -----        ----
DSM IP CONNECTION
  PORT  PST             SST
  A     OOS-MT          Unavail
  D     OOS-MA          Ueq
ENUM CONNECTION STATUS
  CNAME          PROT      STATUS

```

Command Completed.

;

```
> pass:loc=1317:cmd="netstat -i"
```

```
eagle1 17-05-04 15:23:59 MST EAGLE 46.5.0.0.0-70.29.0
SDS Shell Output
```

```
shellLib: unknown LED mode vi.
```

```
-> tklc_ifShow
```

```
lo0 Link type:Local loopback Queue:none
  inet 127.0.0.1 mask 255.255.255.255
  inet6 unicast fe80::1%lo0 prefixlen 64 automatic
  inet6 unicast ::1 prefixlen 128
  UP RUNNING LOOPBACK MULTICAST NOARP ALLMULTI
  MTU:1500 metric:1 VR:0 ifindex:1
  RX packets:885990 mcast:3 errors:0 dropped:0
  TX packets:885990 mcast:3 errors:0
  collisions:0 unsupported proto:0
  RX bytes:99M TX bytes:99M
```

```
gei4 Link type:Ethernet HWaddr 00:00:17:0e:b7:d2 Queue:none
capabilities: TXCSUM TX6CSUM
  inet 192.168.120.13 mask 255.255.255.0 broadcast 192.168.120.255
  inet6 unicast fe80::200:17ff:fe0e:b7d2%gei4 prefixlen 64 automatic
  UP RUNNING SIMPLEX BROADCAST MULTICAST
  MTU:1500 metric:1 VR:0 ifindex:2
  RX packets:35807 mcast:0 errors:0 dropped:0
```

```
TX packets:877952 mcast:12 errors:0
collisions:0 unsupported proto:0
RX bytes:2148k TX bytes:110M
```

```
gei5      Link type:Ethernet HWaddr 00:00:17:0e:b7:d3 Queue:none
capabilities: TXCSUM TX6CSUM
inet 10.75.49.21 mask 255.255.255.0 broadcast 10.75.49.255
inet6 unicast fe80::200:17ff:fe0e:b7d3%gei5 prefixlen 64 automatic
UP RUNNING SIMPLEX BROADCAST MULTICAST
MTU:1500 metric:1 VR:0 ifindex:3
RX packets:526 mcast:0 errors:0 dropped:0
TX packets:7 mcast:6 errors:0
collisions:0 unsupported proto:0
RX bytes:57k TX bytes:510
```

```
gei (unit number 4):
PHY Flags: (0x12114) AUTONEG 1000MB FDX DIX
gei (unit number 5):
PHY Flags: (0x12012) AUTONEG 1000MB FDX DIX
value = 1 = 0x1
```

;

```
eagle1 17-05-04 15:24:09 MST EAGLE 46.5.0.0.0-70.29.0
```

;

```
eagle1 17-05-04 15:24:09 MST EAGLE 46.5.0.0.0-70.29.0
```

```
NETSTAT command complete
```

;

SLIC card running SCCPHC:

```
gei (unit number 2) is ExAP Port A
gei (unit number 0) is ExAP Port B
```

```
> REPT-STAT-CARD:MODE=FULL:LOC=1307
```

```
eagle1 17-05-04 15:10:21 MST EAGLE 46.5.0.0.0-70.29.0
CARD VERSION TYPE GPL PST SST AST
1307 140-029-000 SLIC SCCPHC IS-ANR Standby 98%
ALARM STATUS = ** 0080 Shelf FAN bit is OFF
BLSLC32 GPL version = 140-029-000
IMT BUS A = Conn
IMT BUS B = Disc
CLOCK A = Fault
CLOCK B = Active
CLOCK I = Idle
MBD BIP STATUS = Valid
MOTHER BOARD ID = SLIC
DBD STATUS = Valid
DBD TYPE = None
DBD MEMORY SIZE = 16384M
HW VERIFICATION CODE= ----
FPGA VERSION = 9400036
BIOS VERSION = 0ACFP00
PSOC VERSION = 1.0
CURRENT TEMPERATURE = 40C (104F)
```

```

PEAK TEMPERATURE:   = 40C (104F)      [17-05-04 15:05]
SCCP % OCCUP        = 0%
SCCP SM DATA TYPE  = DN
APPLICATION SERVICING
                    MFC                MFC
SNM    REQ STATUS = 24 hr: ---, 5 min: ---
INM    REQ STATUS = 24 hr: ---, 5 min: ---
MTP3   REQ STATUS = 24 hr: ---, 5 min: ---
SFLOG  REQ STATUS = 24 hr: ---, 5 min: ---
IPLNK STATUS
IPLNK  IPADDR      STATUS      PST
A      192.168.120.21  DOWN      OOS-MT
B      192.168.121.21  DOWN      OOS-MT
DSM IP CONNECTION
PORT   PST          SST
A      OOS-MT       Unavail
B      OOS-MT       Unavail

```

Command Completed.

;

> PASS:LOC=1307:CMD="NETSTAT -I"

eagle1 17-05-04 15:10:27 MST EAGLE 46.5.0.0.0-70.29.0

SDS Shell Output

-> tklc\_ifShow

lo (unit number 0):

```

Flags: (0x48049) UP LOOPBACK MULTICAST TRAILERS ARP RUNNING INET_UP
Type: SOFTWARE_LOOPBACK
inet: 127.0.0.1
Netmask 0xff000000 Subnetmask 0xff000000
Metric is 0
Maximum Transfer Unit size is 1536
0 packets received; 1 packets sent
0 multicast packets received
0 multicast packets sent
0 input errors; 0 output errors
0 collisions; 0 dropped
0 output queue drops

```

DPLend (unit number 0):

```

Flags: (0x20043) UP BROADCAST ARP RUNNING
Type: ETHERNET_CSMACD
Ethernet address is 00:00:00:00:00:00
Metric is 0
Maximum Transfer Unit size is 485
0 octets received
0 octets sent
0 unicast packets received
0 unicast packets sent
0 non-unicast packets received
0 non-unicast packets sent
0 incoming packets discarded
0 outgoing packets discarded
0 incoming errors
0 outgoing errors
0 unknown protos
0 collisions; 0 dropped
0 output queue drops

```

gei (unit number 2):

```

Flags: (0x78043) UP BROADCAST MULTICAST ARP RUNNING INET_UP
PHY Flags: (0x12114) AUTONEG 1000MB FDX DIX
Type: ETHERNET_CSMACD
inet: 192.168.120.21
Broadcast address: 192.168.120.255
Netmask 0xffffffff Subnetmask 0xffffffff
Ethernet address is 00:10:e0:bb:26:d2
Metric is 0
Maximum Transfer Unit size is 1500
0 octets received
2014 octets sent
0 unicast packets received
0 unicast packets sent
0 multicast packets received
0 multicast packets sent
0 broadcast packets received
16 broadcast packets sent
0 incoming packets discarded
0 outgoing packets discarded
0 incoming errors
0 outgoing errors
0 unknown protos
0 collisions; 0 dropped
0 output queue drops
gei (unit number 0):
Flags: (0x78043) UP BROADCAST MULTICAST ARP RUNNING INET_UP
PHY Flags: (0x12114) AUTONEG 1000MB FDX DIX
Type: ETHERNET_CSMACD
inet: 192.168.121.21
Broadcast address: 192.168.121.255
Netmask 0xffffffff Subnetmask 0xffffffff
Ethernet address is 00:10:e0:bb:26:d0
Metric is 0
Maximum Transfer Unit size is 1500
0 octets received
1884 octets sent
0 unicast packets received
0 unicast packets sent
0 multicast packets received
0 multicast packets sent
0 broadcast packets received
15 broadcast packets sent
0 incoming packets discarded
0 outgoing packets discarded
0 incoming errors
0 outgoing errors
0 unknown protos
0 collisions; 0 dropped
0 output queue drops
value = 26 = 0x1a
;

eagle1 17-05-04 15:10:37 MST EAGLE 46.5.0.0.0-70.29.0

NETSTAT command complete

;

SLIC card running SCCP64:

```

gei (unit number 0) = ExAP Port A  
gei (unit number 2) = ExAP Port B

> REPT-STAT-CARD:MODE=FULL:LOC=1307

```
eagle1 17-05-04 14:55:03 MST EAGLE 46.5.0.0.0-70.29.0
CARD  VERSION      TYPE      GPL      PST      SST      AST
1307  140-029-000  SLIC      SCCP64   IS-ANR   MPS Unavl -----
ALARM STATUS      = ** 0080 Shelf FAN bit is OFF
BLSLC64 GPL version = 140-029-000
IMT BUS A         = Conn
IMT BUS B         = Disc
CLOCK A          = Fault
CLOCK B          = Active
CLOCK I          = Idle
MBD BIP STATUS   = Valid
MOTHER BOARD ID  = SLIC
DBD STATUS       = Valid
DBD TYPE         = None
DBD MEMORY SIZE  = 16384M
HW VERIFICATION CODE= ----
FPGA VERSION     = 9400036
BIOS VERSION     = 0ACFP00
PSOC VERSION     = 1.0
CURRENT TEMPERATURE = 36C ( 97F)
PEAK TEMPERATURE: = 38C (101F) [17-05-04 14:47]
SCCP % OCCUP     = 0%
SCCP SM DATA TYPE = DN
APPLICATION SERVICING

          SNM      REQ STATUS = 24 hr: ---, 5 min: ---
          INM      REQ STATUS = 24 hr: ---, 5 min: ---
          MTP3     REQ STATUS = 24 hr: ---, 5 min: ---
          SFLOG    REQ STATUS = 24 hr: ---, 5 min: ---
IPLNK STATUS
IPLNK  IPADDR      STATUS      PST
A      192.168.120.21  DOWN      OOS-MT
B      192.168.121.21  DOWN      OOS-MT
DSM IP CONNECTION
PORT  PST          SST
A     OOS-MT      Unavail
B     OOS-MT      Unavail
```

Command Completed.

;

> PASS:LOC=1307:CMD="NETSTAT -I"

Command Accepted - Processing

```
eagle1 17-05-04 14:56:03 MST EAGLE 46.5.0.0.0-70.29.0
PASS:LOC=1307:CMD="NETSTAT -I"
Command entered at terminal #11.
```

;

```
eagle1 17-05-04 14:56:03 MST EAGLE 46.5.0.0.0-70.29.0
PASS: Command sent to card
```

;

```
eagle1 17-05-04 14:56:03 MST EAGLE 46.5.0.0.0-70.29.0
```

SDS Shell Output

```
shellLib: unknown LED mode vi.
-> tklc_ifShow
lo0 Link type:Local loopback Queue:none
  inet 127.0.0.1 mask 255.255.255.255
  inet6 unicast fe80::1%lo0 prefixlen 64 automatic
  inet6 unicast ::1 prefixlen 128
  UP RUNNING LOOPBACK MULTICAST NOARP ALLMULTI
  MTU:1500 metric:1 VR:0 ifindex:1
  RX packets:2213 mcast:3 errors:0 dropped:0
  TX packets:2213 mcast:3 errors:0
  collisions:0 unsupported proto:0
  RX bytes:247k TX bytes:247k

gei0      Link type:Ethernet HWaddr 00:10:e0:bb:26:d0 Queue:none
capabilities: TXCSUM TX6CSUM VLAN_MTU VLAN_TXHWTAG VLAN_RXHWTAG
  inet 192.168.120.21 mask 255.255.255.0 broadcast 192.168.120.255
  inet6 unicast fe80::210:e0ff:febb:26d0%gei0 prefixlen 64 automatic
  UP RUNNING SIMPLEX BROADCAST MULTICAST
  MTU:1500 metric:1 VR:0 ifindex:2
  RX packets:695 mcast:0 errors:0 dropped:0
  TX packets:634 mcast:12 errors:0
  collisions:0 unsupported proto:0
  RX bytes:74k TX bytes:79k

gei2      Link type:Ethernet HWaddr 00:10:e0:bb:26:d2 Queue:none
capabilities: TXCSUM TX6CSUM VLAN_MTU VLAN_TXHWTAG VLAN_RXHWTAG
  inet 192.168.121.21 mask 255.255.255.0 broadcast 192.168.121.255
  inet6 unicast fe80::210:e0ff:febb:26d2%gei2 prefixlen 64 automatic
  UP RUNNING SIMPLEX BROADCAST MULTICAST
  MTU:1500 metric:1 VR:0 ifindex:3
  RX packets:702 mcast:0 errors:0 dropped:0
  TX packets:639 mcast:6 errors:0
  collisions:0 unsupported proto:0
  RX bytes:75k TX bytes:80k

gei (unit number 0):
  PHY Flags: (0x12114) AUTONEG 1000MB FDX DIX
gei (unit number 2):
  PHY Flags: (0x12114) AUTONEG 1000MB FDX DIX
value = 1 = 0x1

;
eagle1 17-05-04 14:56:13 MST EAGLE 46.5.0.0.0-70.29.0

NETSTAT command complete

;

SLIC card running ENUMHC/DEIRHC/SIPHC:
gei (unit number 2) = ExAP Port A
gei (unit number 0) = Signaling Port #1
gei (unit number 3) = Signaling Port #2
gei (unit number 1) = ExAP Port B

> rept-stat-card:mode=full:loc=1317
```

```

eagle1 17-05-04 17:34:35 MST EAGLE 46.5.0.0.0-70.29.0
CARD VERSION TYPE GPL PST SST AST
1317 140-029-000 SLIC ENUMHC IS-ANR MPS Unavl -----
ALARM STATUS = No Alarms.
BLSLC32 GPL version = 140-029-000
IMT BUS A = Conn
IMT BUS B = Disc
CLOCK A = Fault
CLOCK B = Active
CLOCK I = Idle
MBD BIP STATUS = Valid
MOTHER BOARD ID = SLIC
DBD STATUS = Valid
DBD TYPE = None
DBD MEMORY SIZE = 16384M
HW VERIFICATION CODE= ----
FPGA VERSION = 9400036
BIOS VERSION = 0ACFP00
PSOC VERSION = 1.0
CURRENT TEMPERATURE = 43C (110F)
PEAK TEMPERATURE: = 43C (110F) [17-05-04 17:27]
ENUM SM DATA TYPE = DN
IPLNK STATUS
IPLNK IPADDR STATUS PST
A 192.168.120.13 UP IS-NR
B 10.75.49.21 DOWN OOS-MT
C 10.75.50.21 UP IS-NR
D 192.168.121.13 UP IS-NR
DSM IP CONNECTION
PORT PST SST
A OOS-MT Unavail
D OOS-MT Unavail

```

Command Completed.

;

```
> pass:loc=1317:cmd="netstat -i"
```

Command Accepted - Processing

```

eagle1 17-05-04 17:34:52 MST EAGLE 46.5.0.0.0-70.29.0
pass:loc=1317:cmd="netstat -i"
Command entered at terminal #13.

```

;

```

eagle1 17-05-04 17:34:52 MST EAGLE 46.5.0.0.0-70.29.0
PASS: Command sent to card

```

;

```

eagle1 17-05-04 17:34:52 MST EAGLE 46.5.0.0.0-70.29.0
SDS Shell Output

```

```

-> tklc_ifShow
lo (unit number 0):
  Flags: (0x48049) UP LOOPBACK MULTICAST TRAILERS ARP RUNNING INET_UP
  Type: SOFTWARE_LOOPBACK
  inet: 127.0.0.1
  Netmask 0xff000000 Subnetmask 0xff000000
  Metric is 0
  Maximum Transfer Unit size is 1536

```

```

0 packets received; 1 packets sent
0 multicast packets received
0 multicast packets sent
0 input errors; 0 output errors
0 collisions; 0 dropped
0 output queue drops
DPLend (unit number 0):
Flags: (0x20043) UP BROADCAST ARP RUNNING
Type: ETHERNET_CSMACD
Ethernet address is 00:00:00:00:00:00
Metric is 0
Maximum Transfer Unit size is 485
0 octets received
0 octets sent
0 unicast packets received
0 unicast packets sent
0 non-unicast packets received
0 non-unicast packets sent
0 incoming packets discarded
0 outgoing packets discarded
0 incoming errors
0 outgoing errors
0 unknown protos
0 collisions; 0 dropped
0 output queue drops
gei (unit number 2):
Flags: (0x78043) UP BROADCAST MULTICAST ARP RUNNING INET_UP
PHY Flags: (0x12114) AUTONEG 1000MB FDX DIX
Type: ETHERNET_CSMACD
inet: 192.168.120.13
Broadcast address: 192.168.120.255
Netmask 0xffffffff Subnetmask 0xffffffff
Ethernet address is 00:10:e0:bb:26:d2
Metric is 0
Maximum Transfer Unit size is 1500
13736 octets received
16118 octets sent
0 unicast packets received
0 unicast packets sent
0 multicast packets received
0 multicast packets sent
128 broadcast packets received
125 broadcast packets sent
0 incoming packets discarded
0 outgoing packets discarded
0 incoming errors
0 outgoing errors
0 unknown protos
0 collisions; 0 dropped
0 output queue drops
gei (unit number 0):
Flags: (0x70043) UP BROADCAST ARP RUNNING INET_UP
PHY Flags: (0x2012) DIX
Type: ETHERNET_CSMACD
inet: 10.75.49.21
Broadcast address: 10.75.49.255
Netmask 0xff000000 Subnetmask 0xffffffff
Ethernet address is 00:10:e0:bb:26:d0
Metric is 0
Maximum Transfer Unit size is 1500
0 octets received

```

```

0 octets sent
0 unicast packets received
0 unicast packets sent
0 multicast packets received
0 multicast packets sent
0 broadcast packets received
0 broadcast packets sent
0 incoming packets discarded
0 outgoing packets discarded
0 incoming errors
0 outgoing errors
0 unknown protos
0 collisions; 0 dropped
0 output queue drops
gei (unit number 3):
Flags: (0x70043) UP BROADCAST ARP RUNNING INET_UP
PHY Flags: (0x12012) 100MB FDX DIX
Type: ETHERNET_CSMACD
inet: 10.75.50.21
Broadcast address: 10.75.50.255
Netmask 0xff000000 Subnetmask 0xfffff00
Ethernet address is 00:10:e0:bb:26:d3
Metric is 0
Maximum Transfer Unit size is 1500
25708 octets received
128 octets sent
0 unicast packets received
0 unicast packets sent
0 multicast packets received
0 multicast packets sent
214 broadcast packets received
2 broadcast packets sent
0 incoming packets discarded
0 outgoing packets discarded
0 incoming errors
0 outgoing errors
0 unknown protos
0 collisions; 0 dropped
0 output queue drops
gei (unit number 1):
Flags: (0x78043) UP BROADCAST MULTICAST ARP RUNNING INET_UP
PHY Flags: (0x12114) AUTONEG 1000MB FDX DIX
Type: ETHERNET_CSMACD
inet: 192.168.121.13
Broadcast address: 192.168.121.255
Netmask 0xffffffff00 Subnetmask 0xffffffff00
Ethernet address is 00:10:e0:bb:26:d1
Metric is 0
Maximum Transfer Unit size is 1500
13544 octets received
16118 octets sent
0 unicast packets received
0 unicast packets sent
0 multicast packets received
0 multicast packets sent
125 broadcast packets received
125 broadcast packets sent
0 incoming packets discarded
0 outgoing packets discarded
0 incoming errors
0 outgoing errors

```

```

    0 unknown protos
    0 collisions; 0 dropped
    0 output queue drops
value = 26 = 0x1a

;

eagle1 17-05-04 17:35:02 MST EAGLE 46.5.0.0.0-70.29.0

;

eagle1 17-05-04 17:35:02 MST EAGLE 46.5.0.0.0-70.29.0

NETSTAT command complete

;

SLIC card running DEIR64/ENUM64/SIP64:

gei (unit number 0) = ExAP Port A
gei (unit number 2) = Signaling Port #1
gei (unit number 1) = Signaling Port #2
gei (unit number 3) = ExAP Port B

> rept-stat-card:mode=full:loc=1317

Command Accepted - Processing

eagle1 17-05-04 16:20:40 MST EAGLE 46.5.0.0.0-70.29.0
rept-stat-card:mode=full:loc=1317
Command entered at terminal #13.

;

eagle1 17-05-04 16:20:40 MST EAGLE 46.5.0.0.0-70.29.0
CARD   VERSION   TYPE      GPL      PST      SST      AST
1317   140-029-000  SLIC     ENUM64   IS-ANR   MPS Unavl  -----
ALARM STATUS           = No Alarms.
BLSLC64 GPL version = 140-029-000
IMT BUS A              = Conn
IMT BUS B              = Disc
CLOCK A               = Fault
CLOCK B               = Active
CLOCK I               = Idle
MBD BIP STATUS        = Valid
MOTHER BOARD ID       = SLIC
DBD STATUS            = Valid
DBD TYPE              = None
DBD MEMORY SIZE       = 16384M
HW VERIFICATION CODE = ----
FPGA VERSION          = 9400036
BIOS VERSION          = 0ACFP00
PSOC VERSION          = 1.0
CURRENT TEMPERATURE = 40C (104F)
PEAK TEMPERATURE:   = 42C (108F) [17-05-04 15:51]
ENUM SM DATA TYPE    = DN
IPLNK STATUS
IPLNK  IPADDR           STATUS      PST
A      192.168.120.13  UP          IS-NR
B      10.75.49.21   DOWN       OOS-MT
C      10.75.50.21   DOWN       OOS-MT

```

```

      D      192.168.121.13      UP      IS-NR
DSM IP CONNECTION
      PORT  PST      SST
      A      OOS-MT      Unavail
      D      OOS-MT      Unavail

```

Command Completed.

;

```
> pass:loc=1317:cmd="netstat -i"
```

Command Accepted - Processing

```

eagle1 17-05-04 16:25:06 MST  EAGLE 46.5.0.0.0-70.29.0
pass:loc=1317:cmd="netstat -i"
Command entered at terminal #13.

```

;

```

eagle1 17-05-04 16:25:06 MST  EAGLE 46.5.0.0.0-70.29.0
PASS: Command sent to card

```

;

```

eagle1 17-05-04 16:25:06 MST  EAGLE 46.5.0.0.0-70.29.0
SDS Shell Output

```

shellLib: unknown LED mode vi.

-> tklc\_ifShow

```

lo0 Link type:Local loopback Queue:none
  inet 127.0.0.1 mask 255.255.255.255
  inet6 unicast fe80::1%lo0 prefixlen 64 automatic
  inet6 unicast ::1 prefixlen 128
  UP RUNNING LOOPBACK MULTICAST NOARP ALLMULTI
  MTU:1500 metric:1 VR:0 ifindex:1
  RX packets:1487 mcast:3 errors:0 dropped:0
  TX packets:1487 mcast:3 errors:0
  collisions:0 unsupported proto:0
  RX bytes:165k TX bytes:165k

```

```

gei0      Link type:Ethernet HWaddr 00:10:e0:bb:26:d0 Queue:none
capabilities: TXCSUM TX6CSUM VLAN_MTU VLAN_TXHWTAG VLAN_RXHWTAG
  inet 192.168.120.13 mask 255.255.255.0 broadcast 192.168.120.255
  inet6 unicast fe80::210:e0ff:febb:26d0%gei0 prefixlen 64 automatic
  UP RUNNING SIMPLEX BROADCAST MULTICAST
  MTU:1500 metric:1 VR:0 ifindex:2
  RX packets:929 mcast:0 errors:0 dropped:0
  TX packets:745 mcast:6 errors:0
  collisions:0 unsupported proto:0
  RX bytes:101k TX bytes:93k

```

```

gei2      Link type:Ethernet HWaddr 00:10:e0:bb:26:d2 Queue:none
capabilities: TXCSUM TX6CSUM VLAN_MTU VLAN_TXHWTAG VLAN_RXHWTAG
  inet 10.75.49.21 mask 255.255.255.0 broadcast 10.75.49.255
  inet6 unicast fe80::210:e0ff:febb:26d2%gei2 prefixlen 64 automatic
  UP RUNNING SIMPLEX BROADCAST MULTICAST
  MTU:1500 metric:1 VR:0 ifindex:3
  RX packets:37 mcast:0 errors:0 dropped:0
  TX packets:7 mcast:6 errors:0
  collisions:0 unsupported proto:0
  RX bytes:4596 TX bytes:510

```

```

gei1      Link type:Ethernet HWaddr 00:10:e0:bb:26:d1 Queue:none

```

```
capabilities: TXCSUM TX6CSUM VLAN_MTU VLAN_TXHWTAG VLAN_RXHWTAG
inet 10.75.50.21 mask 255.255.255.0 broadcast 10.75.50.255
inet6 unicast fe80::210:e0ff:febb:26d1%gei1 prefixlen 64 tentative automatic
UP SIMPLEX BROADCAST MULTICAST
MTU:1500 metric:1 VR:0 ifindex:4
RX packets:0 mcast:0 errors:0 dropped:0
TX packets:0 mcast:0 errors:0
collisions:0 unsupported proto:0
RX bytes:0 TX bytes:0
```

```
gei3          Link type:Ethernet HWaddr 00:10:e0:bb:26:d3 Queue:none
capabilities: TXCSUM TX6CSUM VLAN_MTU VLAN_TXHWTAG VLAN_RXHWTAG
inet 192.168.121.13 mask 255.255.255.0 broadcast 192.168.121.255
inet6 unicast fe80::210:e0ff:febb:26d3%gei3 prefixlen 64 automatic
UP RUNNING SIMPLEX BROADCAST MULTICAST
MTU:1500 metric:1 VR:0 ifindex:5
RX packets:921 mcast:0 errors:0 dropped:0
TX packets:745 mcast:6 errors:0
collisions:0 unsupported proto:0
RX bytes:101k TX bytes:93k
```

```
gei (unit number 0):
  PHY Flags: (0x12114) AUTONEG 1000MB FDX DIX
gei (unit number 2):
  PHY Flags: (0x12012) 100MB FDX DIX
gei (unit number 1):
  PHY Flags: (0x2012) DIX
gei (unit number 3):
  PHY Flags: (0x12114) AUTONEG 1000MB FDX DIX
value = 1 = 0x1
```

;

```
eagle1 17-05-04 16:25:16 MST EAGLE 46.5.0.0.0-70.29.0
```

```
NETSTAT command complete
```

;

## Upgrade SSL certificate from SHA-1 to SHA-512

### Appendix A.18 Upgrade SSL certificate from SHA-1 to SHA-512

<b>S T E P #</b>	<p>This procedure upgrade SSL certificate from SHA-1 to SHA-512.</p> <p>Check off (✓) each step as it is completed. Boxes have been provided for this purpose under each step number.</p> <p>IF THIS PROCEDURE FAILS, CONTACT MY ORACLE SUPPORT AND ASK FOR <u>UPGRADE ASSISTANCE</u>.</p>	
1. <input type="checkbox"/>	<p><b>MPS</b> : Log in to the server.</p>	<p>If not already logged in, then login at MPS :</p> <pre>&lt;hostname&gt; console login: epapdev Password: &lt;password&gt;</pre> <p>Change to root user.</p> <pre>\$ su - root</pre>
2. <input type="checkbox"/>	<p>Verify SSL certificate</p>	<p>To verify SSL certificate Run the following command:</p> <pre># /usr/bin/openssl x509 -in /usr/TKLC/plat/etc/ssl/server.crt -text -noout   grep "Signature Algorithm" Signature Algorithm: sha512WithRSAEncryption Signature Algorithm: sha512WithRSAEncryption</pre> <p>If signature algorithm is SHA 512 skip this procedure,otherwise proceed with the following step.</p>
3. <input type="checkbox"/>	<p>Find the IP for which the certificate has been generated in server.crt</p>	<pre># openssl verify /usr/TKLC/plat/etc/ssl/server.crt /usr/TKLC/plat/etc/ssl/server.crt: CN = 10.248.11.14 error 18 at 0 depth lookup:self signed certificate OK</pre>
4. <input type="checkbox"/>	<p>Upgrade to SHA-512 in server.crt</p>	<p><b>Note:</b> The IP Address to be used in the below command is the IP displayed in the output of step 3.</p> <p>To upgrade SHA-1 to SHA-512 run the following command:</p> <pre># /usr/bin/openssl req -x509 -sha512 -nodes -days 4015 -subj "/CN=&lt;IP Addr&gt;" -newkey rsa:2048 -keyout /usr/TKLC/plat/etc/ssl/server.key -out /usr/TKLC/plat/etc/ssl/server.crt</pre> <pre>Generating a 2048 bit RSA private key .....+++ .....+++ writing new private key to '/usr/TKLC/plat/etc/ssl/server.key'</pre>
5. <input type="checkbox"/>	<p>Find the IP for which the certificate has been generated in server_dual.crt</p>	<pre># openssl verify /usr/TKLC/plat/etc/ssl/server_dual.crt /usr/TKLC/plat/etc/ssl/server_dual.crt: CN = 10.248.11.14 error 18 at 0 depth lookup:self signed certificate OK</pre>

6. <input type="checkbox"/>	Upgrade to SHA-512 in server_dual.crt	<p><b>Note:</b> The IP Address to be used in the below command is the IP displayed in the output of step 5.</p> <p>To upgrade SHA-1 to SHA-512 Run the following command:</p> <pre># /usr/bin/openssl req -x509 -sha512 -nodes -days 4015 -subj "/CN=&lt;IP Addr&gt;" -newkey rsa:2048 -keyout /usr/TKLC/plat/etc/ssl/server_dual.key -out /usr/TKLC/plat/etc/ssl/server_dual.crt</pre> <p>Generating a 2048 bit RSA private key  .....+++  .....+++  writing new private key to  '/usr/TKLC/plat/etc/ssl/server_dual.key'</p>
7. <input type="checkbox"/>	Restart httpd service	<p>Restart httpd service to reflect IP correctly. Use following command to restart httpd service:</p> <p><b>\$ systemctl restart httpd</b></p> <pre>[root@Natal-A ~]# service httpd restart Stopping httpd: [ OK ] Starting httpd: [Fri Jul 06 23:26:09 2018] [warn] _default_VirtualHost overlap on port 8002, the first has precedence [Fri Jul 06 23:26:09 2018] [warn] _default_VirtualHost overlap on port 443, the first has precedence [ OK ]</pre>
8. <input type="checkbox"/>	Exit from root user	<p>Exit from root user by running the following command:</p> <p><b>\$ exit</b></p>
9. <input type="checkbox"/>	Procedure Complete.	Return to the procedure that you came here from.
10. <input type="checkbox"/>	Note down the timestamp in log.	<p>Run the following command:</p> <p><b>\$ date</b></p>

## Disable Epap VIP And Deactivate PDBA Proxy Feature

If PDBA Proxy feature is NOT enabled and VIP is NOT configured, this procedure can be skipped.

**Ensure the provisioning activity has been halted before proceeding!!!**

### Appendix A.19 Disable Epap VIP And Deactivate PDBA Proxy Feature

S T E	This procedure outlines the steps to disable the PDBA proxy feature.
-------------	--

P #	Estimated time: 5 minutes	
1. <input type="checkbox"/>	<p><b>MPS A:</b> Choose option "8" to display "PDB Configuration Menu."</p>	<p>MPS Side A:</p> <pre> /-----EPAP Configuration Menu-----\   1   Display Configuration   2   Configure Network Interfaces Menu   3   Set Time Zone   4   Exchange Secure Shell Keys   5   Change Password   6   Platform Menu   7   Configure NTP Server   8   PDB Configuration Menu   9   Security  10   SNMP Configuration  11   Configure Alarm Feed  12   Configure Query Server  13   Configure Query Server Alarm Feed  14   Configure SNMP Agent Community  15   Mate Disaster Recovery   e   Exit \-----\ </pre> <p>Enter Choice: 8</p>
2. <input type="checkbox"/>	<p><b>MPS A:</b> Choose option "6" to "Change PDBA Proxy State".</p>	<p>MPS Side A:</p> <pre> /-----Configure PDB Menu-----\   1   Configure PDB Network   2   RTDB Homing Menu   3   Change MPS Provisionable State   4   Create PDB   5   Change Auto DB Recovery State   6   Change PDBA Proxy State   e   Exit \-----\ </pre> <p>Enter Choice: 6</p>
3. <input type="checkbox"/>	<p><b>MPS A:</b> Enter "Y" to stop PDBA / EPAP software and disable PDBA Proxy.</p>	<p>PDBA PROXY is currently ENABLED. Do you want to DISABLE PDBA Proxy? [N]: Y</p>

<p>4.</p> <p><input type="checkbox"/></p>	<p><b>MPS A:</b> Enter "1" to "Display Configuration"</p>	<p>MPS Side A:</p> <pre> /-----EPAP Configuration Menu-----\   1   Display Configuration                    2   Configure Network Interfaces Menu       3   Set Time Zone                           4   Exchange Secure Shell Keys             5   Change Password                        6   Platform Menu                          7   Configure NTP Server                    8   PDB Configuration Menu                 9   Security                               10   SNMP Configuration                     11   Configure Alarm Feed                    12   Configure Query Server                 13   Configure Query Server Alarm Feed      14   Configure SNMP Agent Community         15   Mate Disaster Recovery                  e   Exit                                  \-----\ </pre> <p>Enter Choice: 1</p>
<p>5.</p> <p><input type="checkbox"/></p>	<p><b>MPS A:</b> Verify that the state of PDBA Proxy Feature is No.</p>	<p>MPS Side A:</p> <pre> EPAP A Provisioning Network IP Address = 192.168.61.115 EPAP B Provisioning Network IP Address = 192.168.61.116 Provisioning Network Netmask           = 255.255.255.0 Provisioning Network Default Router    = 192.168.61.1 EPAP A Backup Prov Network IP Address = Not configured EPAP B Backup Prov Network IP Address = Not configured Backup Prov Network Netmask            = Not configured Backup Prov Network Default Router     = Not configured EPAP A Sync Network Address            = 192.168.2.100 EPAP B Sync Network Address            = 192.168.2.200 EPAP A Main DSM Network Address        = 192.168.120.100 EPAP B Main DSM Network Address        = 192.168.120.200 EPAP A Backup DSM Network Address      = 192.168.121.100 EPAP B Backup DSM Network Address      = 192.168.121.200 EPAP A HTTP Port                       = 80 EPAP B HTTP Port                       = 80 EPAP A HTTP SuExec Port                 = 8001 </pre>

		EPAP B HTTP SuExec Port	= 8001
		EPAP A Banner Connection Port	= 8473
		EPAP B Banner Connection Port	= 8473
		EPAP A Static NAT Address	= Not
		configured	
		EPAP B Static NAT Address	= Not
		configured	
		PDBI Port	= 5873
		Remote MPS A Static NAT Address	= Not
		configured	
		Remote MPS A HTTP Port	= 80
		Local Provisioning VIP	=
		192.168.15.152	
		Remote Provisioning VIP	=
		192.168.15.172	
		Local PDBA Address	=
		192.168.15.115	
		Remote PDBA Address	=
		192.168.16.115	
		Remote PDBA B Address	=
		192.168.16.116	
		Time Zone	=
		America/New_York	
		PDB Database	= Exists
		Preferred PDB	= Standby
		Allow updates from alternate PDB	= Yes
		Auto DB Recovery Enabled	= Yes
		<del>PDBA Proxy Enabled</del>	= <b>No</b>
		Press return to continue...	

<p>6.</p> <p><input type="checkbox"/></p>	<p><b>MPS A:</b></p> <p>Choose option "2" to enter the "Configure Network Interfaces Menu".</p>	<p>MPS Side A:</p> <pre> /-----EPAP Configuration Menu-----\ /-----\   1   Display Configuration    -----    2   Configure Network Interfaces Menu    -----    3   Set Time Zone    -----    4   Exchange Secure Shell Keys    -----    5   Change Password    -----    6   Platform Menu    -----    7   Configure NTP Server    -----    8   PDB Configuration Menu    -----    9   Security    -----   10   SNMP Configuration    -----   11   Configure Alarm Feed    -----   12   Configure Query Server    -----   13   Configure Query Server Alarm Feed    -----   14   Configure SNMP Agent Community    -----   15   Mate Disaster Recovery    -----    e   Exit   \-----/ </pre> <p>Enter Choice: 2</p>
---	---	--

<p>7.</p> <input type="checkbox"/>	<p><b>MPS A:</b> Choose option "7" to enter the "Configure Provisioning VIP Addresses Menu".</p>	<p>MPS Side A:</p> <pre> /-----Configure Network Interfaces Menu-----\   1   Configure Provisioning Network   2   Configure Sync Network   3   Configure DSM Network   4   Configure Backup Provisioning Network   5   Configure Forwarded Ports   6   Configure Static NAT Addresses   7   Configure Provisioning VIP Addresses   e   Exit \-----\ </pre> <p>Enter Choice: 7</p>
<p>8.</p> <input type="checkbox"/>	<p><b>MPS A:</b> Remove the local provisioning VIP and remote provisioning VIP, by entering 0.0.0.0.</p>	<pre> Verifying root connectivity with mate... EPAP local provisioning virtual IP Address [192.168.15.152]: 0.0.0.0 EPAP remote provisioning virtual IP Address [192.168.15.172]: 0.0.0.0 </pre>
<p>9.</p> <input type="checkbox"/>	<p><b>MPS A:</b> Choose option "e" to exit.</p>	<p>MPS Side A:</p> <pre> /-----Configure Network Interfaces Menu-----\   1   Configure Provisioning Network   2   Configure Sync Network   3   Configure DSM Network   4   Configure Backup Provisioning Network   5   Configure Forwarded Ports   6   Configure Static NAT Addresses   7   Configure Provisioning VIP Addresses   e   Exit \-----\ </pre> <p>Enter Choice: e</p>

<p>10.</p> <p><input type="checkbox"/></p>	<p><b>MPS A:</b></p> <p>Choose option "1" to "Display Configuration."</p>	<p>MPS Side A:</p> <pre> -----EPAP Configuration Menu-----  1   Display Configuration  2   Configure Network Interfaces Menu  3   Set Time Zone  4   Exchange Secure Shell Keys  5   Change Password  6   Platform Menu  7   Configure NTP Server  8   PDB Configuration Menu  9   Security 10   SNMP Configuration 11   Configure Alarm Feed 12   Configure Query Server 13   Configure Query Server Alarm Feed 14   Configure SNMP Agent Community 15   Mate Disaster Recovery  e   Exit ----- </pre> <p>Enter Choice: 1</p>
<p>11.</p> <p><input type="checkbox"/></p>	<p><b>MPS A:</b></p> <p>Verify VIP addresses are set to <b>0.0.0.0</b>.</p>	<p>MPS Side A:</p> <pre> EPAP A Provisioning Network IP Address = 192.168.61.115 EPAP B Provisioning Network IP Address = 192.168.61.116 Provisioning Network Netmask           = 255.255.255.0 Provisioning Network Default Router     = 192.168.61.1 EPAP A Backup Prov Network IP Address = Not configured EPAP B Backup Prov Network IP Address = Not configured Backup Prov Network Netmask             = Not configured Backup Prov Network Default Router      = Not configured EPAP A Sync Network Address             = 192.168.2.100 EPAP B Sync Network Address             = 192.168.2.200 EPAP A Main DSM Network Address         = 192.168.120.100 EPAP B Main DSM Network Address         = 192.168.120.200 EPAP A Backup DSM Network Address       = 192.168.121.100 EPAP B Backup DSM Network Address       = 192.168.121.200 EPAP A HTTP Port                        = 80 EPAP B HTTP Port                        = 80 EPAP A HTTP SuExec Port                 = 8001 EPAP B HTTP SuExec Port                 = 8001 EPAP A Banner Connection Port           = 8473 EPAP B Banner Connection Port           = 8473 EPAP A Static NAT Address                = Not configured </pre>

	EPAP B Static NAT Address configured = Not PDBI Port = 5873 Remote MPS A Static NAT Address configured = Not Remote MPS A HTTP Port = 80 Local Provisioning VIP = 0.0.0.0 Remote Provisioning VIP = 0.0.0.0 Local PDBA Address = 192.168.15.115 Remote PDBA Address = 192.168.16.115 Remote PDBA B Address = 192.168.16.116 Time Zone = America/New_York PDB Database = Exists Preferred PDB = Standby Allow updates from alternate PDB = Yes Auto DB Recovery Enabled = Yes PDBA Proxy Enabled = No  Press return to continue...
--	---

<p>12.</p> <input type="checkbox"/>	<p><b>MPS A:</b> Choose "e" to exit.</p>	<p>MPS Side A:</p> <pre> /-----EPAP Configuration Menu-----\ /-----\   1   Display Configuration                   -----    2   Configure Network Interfaces Menu       -----    3   Set Time Zone                           -----    4   Exchange Secure Shell Keys             -----    5   Change Password                         -----    6   Platform Menu                          -----    7   Configure NTP Server                    -----    8   PDB Configuration Menu                 -----    9   Security                                -----   10   SNMP Configuration                      -----   11   Configure Alarm Feed                     -----   12   Configure Query Server                   -----   13   Configure Query Server Alarm Feed       -----   14   Configure SNMP Agent Community           -----   15   Mate Disaster Recovery                   -----     e   Exit                                  \-----/ </pre> <p>Enter choice: e</p>
<p>13.</p> <input type="checkbox"/>	<p>Return to the procedure that you came here from.</p>	
<p>14.</p> <input type="checkbox"/>	<p>Note down the timestamp in log.</p>	<p>Run the following command: <b>\$ date</b></p>

## Enable EPAP PDBA Proxy and EPAP VIP Optional Features

Ensure the provisioning activity has been halted before proceeding!!!

### Appendix A.20 Enable EPAP PDBA Proxy and EPAP VIP Optional Feature

<b>S T E P #</b>	This procedure outlines the steps for provisioning the PDBA proxy VIP. Estimated time: 10 minutes	
1.	<b>MPS A:</b> Log in as epapdev to 1A server.	Login: <b>epapdev</b> Password: <b>&lt;epapdev_password&gt;</b>
2.	<b>MPS A:</b> Perform "syscheck" on the 1A server.	<pre> \$ syscheck Running modules in class hardware...      OK Running modules in class proc...          OK Running modules in class net...           OK Running modules in class disk...          OK Running modules in class services...      OK Running modules in class system...        OK  LOG LOCATION: /var/TKLC/log/syscheck/fail_log  Note: syscheck may report following error which can be ignored: * defaultroute: FAILURE:: MINOR::5000000000040000 -- Platform Health Check Failure * defaultroute: FAILURE:: ping6 return non-zero code * defaultroute: FAILURE:: MAJOR::3000000000002000 -- Server Default Route Network Error * defaultroute: FAILURE:: The IPv6 default route at fe80::f64e:5ff:fe49:9b7f cannot be pinged </pre>
3.	<b>MPS A:</b> SSH to EPAP 1B.	<b>\$ssh mate</b>
4.	<b>MPS B:</b> Perform "syscheck" on the 1B.	<pre> \$ syscheck Running modules in class hardware...      OK Running modules in class proc...          OK Running modules in class net...           OK Running modules in class disk...          OK Running modules in class services...      OK Running modules in class system...        OK  LOG LOCATION: /var/TKLC/log/syscheck/fail_log  Note: syscheck may report following error which can be ignored: </pre>

		<pre>* defaultroute: FAILURE:: MINOR::500000000040000 -- Platform Health Check Failure * defaultroute: FAILURE:: ping6 return non-zero code * defaultroute: FAILURE:: MAJOR::300000000002000 -- Server Default Route Network Error * defaultroute: FAILURE:: The IPv6 default route at fe80::f64e:5ff:fe49:9b7f cannot be pinged  #</pre>
5.	<b>MPS B:</b> Exit back to the 1A server	<pre>\$ exit</pre>
6.	<b>MPS A:</b> Log in to epapconfig	<pre>\$su - epapconfig Password: warning: smartmatch is experimental at /usr/TKLC/plat/lib/Security/User.pm line 904.</pre>
7.	<b>MPS A:</b> Choose option "1" to display Configuration.	<pre>MPS Side A:  /-----EPAP Configuration Menu-----\   1   Display Configuration                    2   Configure Network Interfaces Menu        3   Set Time Zone                            4   Exchange Secure Shell keys              5   Change Password                          6   Platform Menu                           7   Configure NTP Server                     8   PDB Configuration Menu                  9   Security                                10   SNMP Configuration                     11   Configure Alarm Feed                    12   Configure Query Server                  13   Configure Query Server Alarm Feed       14   Configure SNMP Agent Community          15   Mate Disaster Recovery                   e   Exit                                  \-----/  Enter Choice: 1</pre>
8.	<b>MPS A:</b>	<pre>MPS Side A:  EPAP A Provisioning Network IP Address = 192.168.61.115 EPAP B Provisioning Network IP Address = 192.168.61.116 Provisioning Network Netmask           = 255.255.255.0</pre>

	Verify that the VIP is not configured.	<pre> Provisioning Network Default Router = 192.168.61.1 EPAP A Backup Prov Network IP Address = Not configured EPAP B Backup Prov Network IP Address = Not configured Backup Prov Network Netmask = Not configured Backup Prov Network Default Router = Not configured EPAP A Sync Network Address = 192.168.2.100 EPAP B Sync Network Address = 192.168.2.200 EPAP A Main DSM Network Address = 192.168.120.100 EPAP B Main DSM Network Address = 192.168.120.200 EPAP A Backup DSM Network Address = 192.168.121.100 EPAP B Backup DSM Network Address = 192.168.121.200 EPAP A HTTP Port = 80 EPAP B HTTP Port = 80 EPAP A HTTP SuExec Port = 8001 EPAP B HTTP SuExec Port = 8001 EPAP A Banner Connection Port = 8473 EPAP B Banner Connection Port = 8473 EPAP A Static NAT Address = Not configured EPAP B Static NAT Address = Not configured PDBI Port = 5873 Remote MPS A Static NAT Address = Not configured Remote MPS A HTTP Port = 80 Local Provisioning VIP = Not configured Remote Provisioning VIP = Not configured Local PDBA Address = 192.168.61.115 Remote PDBA Address = 192.168.61.181 Remote PDBA B Address = 192.168.61.182 Time Zone = America/New_York PDB Database = Exists Preferred PDB = Standby Allow updates from alternate PDB = Yes Auto DB Recovery Enabled = Yes PDBA Proxy Enabled = No Press return to continue... </pre>
9.	<b>MPS A:</b> Choose option "2" to enter the "Configure Network Interfaces Menu".	MPS Side A:

		<pre> /-----EPAP Configuration Menu-----\ 1   Display Configuration 2   Configure Network Interfaces Menu 3   Set Time Zone 4   Exchange Secure Shell Keys 5   Change Password 6   Platform Menu 7   Configure NTP Server 8   PDB Configuration Menu 9   Security 10   SNMP Configuration 11   Configure Alarm Feed 12   Configure Query Server 13   Configure Query Server Alarm Feed 14   Configure SNMP Agent Community 15   Mate Disaster Recovery e   Exit \-----/  Enter Choice: 2 </pre>
10.	<p><b>MPS A:</b> Choose option "6" to enter the "Configure Provisioning VIP Addresses Menu".</p>	<pre> MPS Side A:  /-----Configure Network Interfaces Menu-----\ 1   Configure Provisioning Network 2   Configure Sync Network 3   Configure DSM Network 4   Configure Backup Provisioning Network 5   Configure Static NAT Addresses 6   Configure Provisioning VIP Addresses e   Exit \-----/  Enter Choice: 6 </pre>
11.	<p><b>MPS A:</b></p>	<pre> Verifying root connectivity with mate... EPAP software and PDBA are running. Stop them? [N]: Y EPAP software is running on mate MPS. Stop it? [N]: Y EPAP local provisioning Virtual IP Address [0.0.0.0]: <b>192.168.15.152</b> EPAP remote provisioning Virtual IP Address [0.0.0.0]: <b>192.168.15.172</b> </pre>

	<p>Enter "Y" to stop PDBA / EPAP software then enter VIP address for the local and remote PDBA sites.</p>	
<p>12.</p>	<p><b>MPS A:</b> Choose option "e" to exit.</p>	<p>MPS Side A: /-----Configure Network Interfaces Menu-----\ /-----\ 1   Configure Provisioning Network 2   Configure Sync Network 3   Configure DSM Network 4   Configure Backup Provisioning Network 5   Configure Static NAT Addresses 6   Configure Provisioning VIP Addresses e   Exit -----\ Enter Choice: e</p>
<p>13.</p>	<p><b>MPS A:</b> Choose option "1" to "Display Configuration.</p>	<p>MPS Side A:</p>

		<pre> /-----EPAP Configuration Menu-----\  1   Display Configuration  2   Configure Network Interfaces Menu  3   Set Time Zone  4   Exchange Secure Shell Keys  5   Change Password  6   Platform Menu  7   Configure NTP Server  8   PDB Configuration Menu  9   Security 10   SNMP Configuration 11   Configure Alarm Feed 12   Configure Query Server 13   Configure Query Server Alarm Feed 14   Configure SNMP Agent Community 15   Mate Disaster Recovery      e   Exit \-----\  Enter Choice: 1 </pre>
14.	<b>MPS A:</b> Verify VIP addresses	<pre> MPS Side A: EPAP A Provisioning Network IP Address = 192.168.61.115 EPAP B Provisioning Network IP Address = 192.168.61.116 Provisioning Network Netmask          = 255.255.255.0 Provisioning Network Default Router    = 192.168.61.1 EPAP A Backup Prov Network IP Address = Not configured EPAP B Backup Prov Network IP Address = Not configured Backup Prov Network Netmask           = Not configured Backup Prov Network Default Router     = Not configured EPAP A Sync Network Address           = 192.168.2.100 EPAP B Sync Network Address           = 192.168.2.200 EPAP A Main DSM Network Address        = 192.168.120.100 EPAP B Main DSM Network Address        = 192.168.120.200 EPAP A Backup DSM Network Address      = 192.168.121.100 EPAP B Backup DSM Network Address      = 192.168.121.200 EPAP A HTTP Port                       = 80 EPAP B HTTP Port                       = 80 EPAP A HTTP SuExec Port                = 8001 EPAP B HTTP SuExec Port                = 8001 EPAP A Banner Connection Port          = 8473 EPAP B Banner Connection Port          = 8473 EPAP A Static NAT Address               = Not configured EPAP B Static NAT Address               = Not configured PDBI Port                               = 5873 Remote MPS A Static NAT Address         = Not configured Remote MPS A HTTP Port                  = 80 Local Provisioning VIP                  = 192.168.15.152 Remote Provisioning VIP                 = 192.168.15.172 Local PDBA Address                      = 192.168.15.115 Remote PDBA Address                     = 192.168.16.115 Remote PDBA B Address                   = 192.168.16.116 </pre>

		Time Zone = America/New_York PDB Database = Exists Preferred PDB = Standby Allow updates from alternate PDB = Yes Auto DB Recovery Enabled = Yes PDBA Proxy Enabled = No  Press return to continue...
15.	<b>MPS A:</b> Choose "e" to exit	<pre> /-----EPAP Configuration Menu-----\ /-----\  1   Display Configuration  2   Configure Network Interfaces Menu  3   Set Time Zone  4   Exchange Secure Shell Keys  5   Change Password  6   Platform Menu  7   Configure NTP Server  8   PDB Configuration Menu  9   Security 10   SNMP Configuration 11   Configure Alarm Feed 12   Configure Query Server 13   Configure Query Server Alarm Feed 14   Configure SNMP Agent Community 15   Mate Disaster Recovery   e   Exit \-----/ </pre> Enter Choice: e
16.	<b>MPS A:</b> Verify that you can ping both VIP addresses.	<pre> \$ ping &lt;local VIP&gt; \$ ping &lt;remote VIP&gt; </pre>
17.	<b>MPS A:</b> Log in to epapconfig	<pre> \$ su - epapconfig warning: smartmatch is experimental at /usr/TKLC/plat/lib/Security/User.pm line 904. </pre>
18.	<b>MPS A:</b> Enter "1" to "Display Configuration"	

		<pre> /-----EPAP Configuration Menu-----\  1   Display Configuration  2   Configure Network Interfaces Menu  3   Set Time Zone  4   Exchange Secure Shell Keys  5   Change Password  6   Platform Menu  7   Configure NTP Server  8   PDB Configuration Menu  9   Security 10   SNMP Configuration 11   Configure Alarm Feed 12   Configure Query Server 13   Configure Query Server Alarm Feed 14   Configure SNMP Agent Community 15   Mate Disaster Recovery  e   Exit -----\  Enter Choice: 1 </pre>
19.	<p><b>MPS A:</b> Verify that the state of PDBA Proxy Feature is No.</p>	<pre> MPS Side A: EPAP A Provisioning Network IP Address = 192.168.61.115 EPAP B Provisioning Network IP Address = 192.168.61.116 Provisioning Network Netmask           = 255.255.255.0 Provisioning Network Default Router     = 192.168.61.1 EPAP A Backup Prov Network IP Address  = Not configured EPAP B Backup Prov Network IP Address  = Not configured Backup Prov Network Netmask            = Not configured Backup Prov Network Default Router     = Not configured EPAP A Sync Network Address            = 192.168.2.100 EPAP B Sync Network Address            = 192.168.2.200 EPAP A Main DSM Network Address        = 192.168.120.100 EPAP B Main DSM Network Address        = 192.168.120.200 EPAP A Backup DSM Network Address      = 192.168.121.100 EPAP B Backup DSM Network Address      = 192.168.121.200 EPAP A HTTP Port                       = 80 EPAP B HTTP Port                       = 80 EPAP A HTTP SuExec Port                 = 8001 EPAP B HTTP SuExec Port                 = 8001 EPAP A Banner Connection Port          = 8473 EPAP B Banner Connection Port          = 8473 EPAP A Static NAT Address               = Not configured EPAP B Static NAT Address               = Not configured PDBI Port                               = 5873 Remote MPS A Static NAT Address         = Not configured Remote MPS A HTTP Port                  = 80 Local Provisioning VIP                   = Not configured Remote Provisioning VIP                  = Not configured Local PDBA Address                      = 192.168.61.115 Remote PDBA Address                     = 192.168.61.181 Remote PDBA B Address                   = 192.168.61.182 Time Zone                               = America/New_York </pre>

		<pre> PDB Database = Exists Preferred PDB = Standby Allow updates from alternate PDB = Yes Auto DB Recovery Enabled = Yes PDBA Proxy Enabled = NO Press return to continue... </pre>
20.	<p><b>MPS A:</b></p> <p>Choose option "8" to display "PDB Configuration Menu"</p>	<pre> MPS Side A:  /-----EPAP Configuration Menu-----\ /-----\ 1   Display Configuration 2   Configure Network Interfaces Menu 3   Set Time Zone 4   Exchange Secure Shell Keys 5   Change Password 6   Platform Menu 7   Configure NTP Server 8   PDB Configuration Menu 9   Security 10   SNMP Configuration 11   Configure Alarm Feed 12   Configure Query Server 13   Configure Query Server Alarm Feed 14   Configure SNMP Agent Community 15   Mate Disaster Recovery e   Exit \-----/  Enter Choice: 8 </pre>
21.	<p><b>MPS A:</b></p> <p>Choose option "6" to "Change PDBA Proxy State".</p>	<pre> MPS Side A:  /-----Configure PDB Menu-----\ /-----\ 1   Configure PDB Network 2   RTDB Homing Menu 3   Change MPS Provisionable State 4   Create PDB 5   Change Auto DB Recovery State 6   Change PDBA Proxy State e   Exit \-----/  Enter Choice: 6 </pre>

22.	<b>MPS A:</b> Enter "Y" to stop PDBA / EPAP software and enable PDBA Proxy.	EPAP software and PDBA are running. Stop them? [N]: Y EPAP software is running on mate MPS. Stop it? [N]: Y PDBA PROXY is currently DISABLED. Do you want to ENABLE PDBA Proxy? [N]: Y
23.	<b>MPS A:</b> Enter "e" to exit	MPS Side A: <pre> /-----Configure PDB Menu-----\ /-----\   1   Configure PDB Network              2   RTDB Homing Menu                  3   Change MPS Provisionable State     4   Create PDB                        5   Change Auto DB Recovery State     6   Change PDBA Proxy State           e   Exit                            \-----/ </pre> Enter Choice: e
24.	<b>MPS A:</b> Enter "1" to "Display Configuration"	
25.	<b>MPS A:</b> Verify that the state of PDBA Proxy Feature is Yes.	MPS Side A EPAP A Provisioning Network IP Address = 192.168.61.115 EPAP B Provisioning Network IP Address = 192.168.61.116 Provisioning Network Netmask = 255.255.255.0 Provisioning Network Default Router = 192.168.61.1 EPAP A Backup Prov Network IP Address = Not configured EPAP B Backup Prov Network IP Address = Not configured Backup Prov Network Netmask = Not configured Backup Prov Network Default Router = Not configured EPAP A Sync Network Address = 192.168.2.100 EPAP B Sync Network Address = 192.168.2.200 EPAP A Main DSM Network Address = 192.168.120.100 EPAP B Main DSM Network Address = 192.168.120.200 EPAP A Backup DSM Network Address = 192.168.121.100 EPAP B Backup DSM Network Address = 192.168.121.200 EPAP A HTTP Port = 80 EPAP B HTTP Port = 80 EPAP A HTTP SuExec Port = 8001 EPAP B HTTP SuExec Port = 8001 EPAP A Banner Connection Port = 8473 EPAP B Banner Connection Port = 8473 EPAP A Static NAT Address = Not configured EPAP B Static NAT Address = Not configured PDBI Port = 5873 Remote MPS A Static NAT Address = Not configured Remote MPS A HTTP Port = 80 Local Provisioning VIP = 192.168.15.152 Remote Provisioning VIP = 192.168.15.172 Local PDBA Address = 192.168.15.115 Remote PDBA Address = 192.168.16.115

		Remote PDBA B Address = 192.168.16.116 Time Zone = America/New_York PDB Database = Exists Preferred PDB = Standby Allow updates from alternate PDB = Yes Auto DB Recovery Enabled = Yes <b>PDBA Proxy Enabled = Yes</b>
26.	<b>MPS A:</b> Enter "e" to exit	MPS Side A: <pre> /-----EPAP Configuration Menu-----\ /-----\ 1   Display Configuration 2   Configure Network Interfaces Menu 3   Set Time Zone 4   Exchange Secure Shell Keys 5   Change Password 6   Platform Menu 7   Configure NTP Server 8   PDB Configuration Menu 9   Security 10   SNMP Configuration 11   Configure Alarm Feed 12   Configure Query Server 13   Configure Query Server Alarm Feed 14   Configure SNMP Agent Community 15   Mate Disaster Recovery e   Exit \-----/ </pre> Enter Choice: e
27.	<b>MPS A:</b> <b>EPAP A:</b> Log in to the web GUI as user "uiadmin".	<b>User name: uiadmin</b> <b>Password:</b>

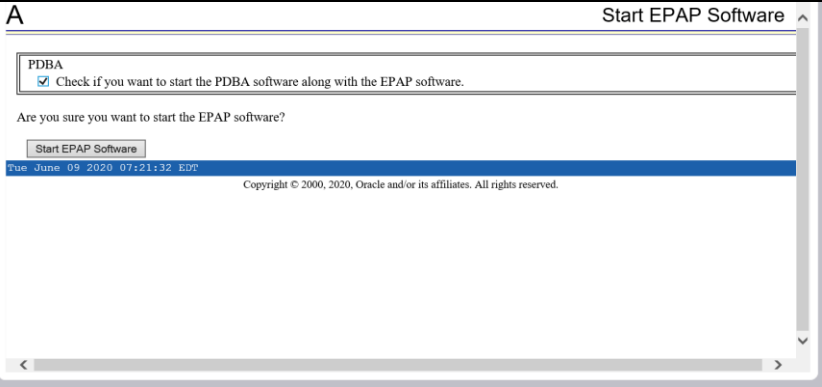
28.	<p><b>MPS A:</b> Start EPAP and PDBA Software.</p> <p>On the menu, click Process Control-&gt;Stap Software.</p> <p>Click "Stap EPAP Software" Button</p>	
29.	<p><b>MPS A:</b> Perform "syscheck" on MPS-A.</p>	<pre>\$ syscheck Running modules in class hardware... OK Running modules in class proc... OK Running modules in class net... OK Running modules in class disk... OK Running modules in class services... OK Running modules in class system... OK  LOG LOCATION: /var/TKLC/log/syscheck/fail_log Note: syscheck may report following error which can be ignored: * defaultroute: FAILURE:: MINOR::500000000040000 -- Platform Health Check Failure * defaultroute: FAILURE:: ping6 return non-zero code * defaultroute: FAILURE:: MAJOR::300000000002000 -- Server Default Route Network Error * defaultroute: FAILURE:: The IPv6 default route at fe80::f64e:5ff:fe49:9b7f cannot be pinged</pre>
30.	<p><b>MPS A:</b> SSH to MPS 1B.</p>	<pre>\$ ssh mate</pre>
31.	<p><b>MPS B:</b> Start Epap software on MPS 1B.</p>	<pre>\$ systemctl start Epap ~~ /etc/init.d/Epap start ~~ "EPAP_RELEASE" is set to "0.613" EPAP application start Successful</pre>
32.	<p><b>MPS B:</b> Perform "syscheck" on MPS 1B.</p>	<pre>\$ syscheck Running modules in class hardware... OK Running modules in class proc... OK Running modules in class net... OK Running modules in class disk... OK</pre>

		<pre>Running modules in class services...                                 OK Running modules in class system...                                 OK  LOG LOCATION: /var/TKLC/log/syscheck/fail_log  Note: syscheck may report following error which can be ignored: * defaultroute: FAILURE:: MINOR::500000000040000 -- Platform Health Check Failure * defaultroute: FAILURE:: ping6 return non-zero code * defaultroute: FAILURE:: MAJOR::300000000002000 -- Server Default Route Network Error * defaultroute: FAILURE:: The IPv6 default route at fe80::f64e:5ff:fe49:9b7f cannot be pinged</pre>
33.	Return to the procedure that you came here from.	
34.	Note down the timestamp in log.	Run the following command: <b>\$ date</b>

### Configure DSM Min Mem Size

<b>S T E P #</b>	This procedure configures DSM Min Mem Size on standalone PDB server.	
	Check off (✓)each step as it is completed. Boxes have been provided for this purpose under each step number.	
	IF THIS PROCEDURE FAILS, CONTACT MY ORACLE SUPPORT AND <b>ASK FOR <u>INSTALL ASSISTANCE</u></b> .	
1.	<input type="checkbox"/> Standalone PDB : Log in as epapdev to standalone PDB server.	Login: <b>epapdev</b> Password: <epapdev_password>
2.	<input type="checkbox"/> Run getDsmMinMemSize.pl	Go to the bin directory to run the getDsmMinMemSize.pl perl script <b>\$ cd /usr/TKLC/epap/bin</b> Run the getDsmMinMemSize.pl script <b>\$ ./ getDsmMinMemSize.pl</b>
3.	<input type="checkbox"/> Restart the pdb Software.	<b>\$ systemctl stop Pdba</b> ~~ /etc/init.d/Pdba stop ~~ PDBA application stopped.  <b>\$ systemctl start Pdba</b>

		<pre> ~~ /etc/init.d/Pdba start ~~ PDBA application started.  \$ systemctl Pdba status ~~ /etc/init.d/Pdba status ~~ PDBA application is running. </pre>
4. <input type="checkbox"/>	Verify that the uiEdit "DSM_MIN_MEM_SIZE" variable is added and updated correctly.	<pre> \$ uiEdit   grep DSM_MIN_MEM_SIZE "DSM_MIN_MEM_SIZE" is set to "12046" </pre>
5. <input type="checkbox"/>	Procedure Complete	Procedure is complete.
6. <input type="checkbox"/>	Note down the timestamp in log.	Run the following command: <pre>\$ date</pre>

## Appendix A.22 Restart Mysql service for PDB on Query Server

### Appendix A. 22 Restart MySQL service for PDB on Query Server

**NOTE: The MySQL services should be started as non-root admin user only.**

<b>S</b> <b>T</b> <b>E</b> <b>P</b> <b>#</b>	This procedure restarts the MySQL service for PDB on Query Server.		
	Check off (✓) each step as it is completed. Boxes have been provided for this purpose under each step number.		
	IF THIS PROCEDURE FAILS, CONTACT MY ORACLE SUPPORT AND ASK FOR <u>INSTALL ASSISTANCE</u> .		
	1. <input type="checkbox"/>	Log in to EAGLE QS as QS admin.	login: <admin_user> Password: <admin_password>
	2. <input type="checkbox"/>	Start the mysqlpdb service.	<pre> \$ sudo systemctl stop mysqld . . . Waiting for mysqlpdb to stop </pre>
3. <input type="checkbox"/>	Verify that mysqlpdb service is running.	<pre> \$ sudo systemctl start mysqld Waiting for mysqlpdb to start done </pre>	
4.	Start the mysqlpdb service.	<pre> \$ sudo systemctl start mysqld PID:8841 mysqlpdb is running. </pre>	

**Appendix A. 22 Restart MySQL service for PDB on Query Server**

**NOTE: The MySQL services should be started as non-root admin user only.**

<input type="checkbox"/>		
5. <input type="checkbox"/>	Procedure Complete	Procedure is complete.
6. <input type="checkbox"/>	Note down the timestamp in log.	Run the following command:  <b>\$ date</b>

**Procedure A.23 Get parse9Dig file from EPAP 16.3 ISO**

**Appendix A. 23 Get parse9Dig file from EPAP 16.3 ISO**

<b>S T E P #</b>	This procedure extract parse9Dig script file from EPAP 16.3 ISO.	
	Check off (✓) each step as it is completed. Boxes have been provided for this purpose under each step number.	
	IF THIS PROCEDURE FAILS, CONTACT MY ORACLE SUPPORT AND ASK FOR <u>INSTALL ASSISTANCE</u> .	
	1. <input type="checkbox"/>	<b>MPS A:</b> Log in as admusr.  login: <admin_user> Password: <admin_password>
	2. <input type="checkbox"/>	<b>MPS A:</b> Copy ISO on MPS A.  Perform 0 or copy EPAP 17.1 ISO to /var/TKLC/upgrade directory.
	3. <input type="checkbox"/>	<b>MPS A:</b> Switch to root user.  Switch to root user.  <b>\$ su - root</b> <b>Password:</b>
4. <input type="checkbox"/>	<b>MPS A:</b> Create directory using mkdir.  Create /mnt/iso directory using following command:  <b># mkdir /mnt/iso</b>	
5. <input type="checkbox"/>	<b>MPS A:</b> Mount ISO on above path  Mount ISO on above created path.  <b># mount -o loop &lt;16.3.a.0.0-b.b.b ISO with full path which is copied in step 2&gt; &lt;full path of directory created in step 4&gt;</b>  As follows:	

## Appendix A. 23 Get parse9Dig file from EPAP 16.3 ISO

		<b># mount -o loop /var/TKLC/upgrade/EPAP-16.3.0.0.0_163.8.0-x86_64.iso /mnt/iso/</b>
6. <input type="checkbox"/>	<b>MPS A:</b> Extract TKLCepap rpm from the ISO.	Copy TKLCepap rpm at /tmp directory.  # cp <directory created in step 4>/Packages/<TKLCepap rpm, the same version which is copied in step 2> /tmp  As follows: <b># cp /mnt/iso/Packages/TKLCepap-163.0.8-16.3.0.0.0_163.8.0.x86_64.rpm /tmp/</b>
7. <input type="checkbox"/>	<b>MPS A:</b> Change directory to /tmp.	Change directory to /tmp using following command:  <b># cd /tmp</b>
8. <input type="checkbox"/>	<b>MPS A:</b> Extract parse9Dig script file from rpm.	Extract desired file parse9Dig from rpm:  # rpm2cpio <TKLCepap rpm extracted in step 6>   cpio -idmv <parse9Dig>  As follows: <b># rpm2cpio TKLCepap-163.0.8-16.3.0.0.0_163.8.0.x86_64.rpm   cpio -idmv ./usr/TKLC/epap/config/parse9Dig</b>  <small>[root@Natal-A tmp]# rpm2cpio TKLCepap-163.0.8-16.3.0.0.0_163.8.0.x86_64.rpm   cpio -idmv ./usr/TKLC/epap/config/parse9Dig ./usr/TKLC/epap/config/parse9Dig 318312 blocks</small>
9. <input type="checkbox"/>	<b>MPS A:</b> Copy extracted parse9Dig at desired path.	Copy extracted parse9Dig file at path: <b>/usr/TKLC/epap/config</b> Use following path:  <b># cp /tmp/usr/TKLC/epap/config/parse9Dig /usr/TKLC/epap/config</b>
10. <input type="checkbox"/>	<b>MPS A:</b> Change the permission of parse9Dig file as required.	Change mode of file parse9Dig to 755 and ownership to epapdev:epap. Use following command:  <b># cd /usr/TKLC/epap/config # chmod 755 parse9Dig # chown epapdev:epap parse9Dig</b>  List the file and check the permissions. It should be same as follows: <b># ll parse9Dig</b>

## Appendix A. 23 Get parse9Dig file from EPAP 16.3 ISO

		<pre>[root@Natal-A config]# ll parse9Dig -rwxr-xr-x 1 epapdev epap 12162 Jul  9 21:39 parse9Dig</pre>
11.	<input type="checkbox"/> <b>MPS A:</b> Snapshot of all above executed commands to extract parse9Dig file.	<p>Verify that all steps executed successfully as follows:</p> <pre>[root@Natal-A ~]# [root@Natal-A ~]# mkdir /mnt/iso [root@Natal-A ~]# [root@Natal-A ~]# mount -o loop /var/TKLC/EPAP-16.3.0.0.0_163.8.0-x86_64.iso /mnt/iso/ /var/TKLC/EPAP-16.3.0.0.0_163.8.0-x86_64.iso: No such file or directory [root@Natal-A ~]# rmdir /mnt/iso [root@Natal-A ~]# [root@Natal-A ~]# mkdir /mnt/iso [root@Natal-A ~]# [root@Natal-A ~]# mount -o loop /var/TKLC/upgrade/EPAP-16.3.0.0.0_163.8.0-x86_64.iso /mnt/iso/ [root@Natal-A ~]# cp /mnt/iso/Packages/TKLCepap-163.0.8-16.3.0.0.0_163.8.0-x86_64.rpm /tmp/ [root@Natal-A ~]# cd /tmp [root@Natal-A tmp]# [root@Natal-A tmp]# rpm2cpio TKLCepap-163.0.8-16.3.0.0.0_163.8.0-x86_64.rpm   cpio -idmv ./usr/TKLC/epap/config/parse9Dig ./usr/TKLC/epap/config/parse9Dig 318312 blocks [root@Natal-A tmp]# [root@Natal-A tmp]# cp /tmp/usr/TKLC/epap/config/parse9Dig /usr/TKLC/epap/config [root@Natal-A tmp]# [root@Natal-A tmp]# cd /usr/TKLC/epap/config [root@Natal-A config]# chmod 755 parse9Dig [root@Natal-A config]# [root@Natal-A config]# chown epapdev:epap parse9Dig [root@Natal-A config]# [root@Natal-A config]# ll parse9Dig -rwxr-xr-x 1 epapdev epap 12162 Jul  9 21:39 parse9Dig [root@Natal-A config]# [root@Natal-A config]#</pre>
12.	<b>MPS A:</b> Remove all temporary files from /tmp directory.	<p>Remove parse9Dig file and TKLCepap rpm from /tmp directory. Execute following command on CLI:</p> <pre># rm -f /tmp/usr/TKLC/epap/config/parse9Dig # rm -f /tmp/TKLCepap-163.0.12-16.3.0.0.0_163.12.0.x86_64.rpm</pre>
13.	<b>MPS A:</b> Umount the mounted ISO.	<p>Umount the ISO which was mounted in step 5. Execute below command:</p> <pre># umount /mnt/iso/</pre>
14.	<b>MPS A:</b> Remove ISO directory.	<p>Remove directory /mnt/iso. Execute below command:</p> <pre># rmdir /mnt/iso/</pre>
15.	<input type="checkbox"/> Procedure Complete	<p>Procedure is complete.</p>
16.	<input type="checkbox"/> Note down the timestamp in log.	<p>Run the following command:</p> <pre>\$ date</pre>

## Procedure A.24 Procedure to add/edit the /etc/minirc.mate file

NOTE: This procedure is needed in following cases:

1. If “minicom mate” fails due to data corruption or somebody deleted the file /etc/minirc.mate.  
Or,
2. If ttyS1 is not working, then edit the file /etc/minirc.mate to use ttyS3 or ttyS4.

### Appendix A. 24 Procedure to add/edit the /etc/minirc.mate file

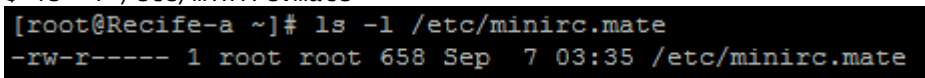
S T E P #	This procedure will add/edit the file /etc/minirc.mate.	
	Check off (✓) each step as it is completed. Boxes have been provided for this purpose under each step number.	
	IF THIS PROCEDURE FAILS, CONTACT MY ORACLE SUPPORT AND ASK FOR <b>UPGRADE ASSISTANCE</b> .	
1. <input type="checkbox"/>	<b>MPS:</b> Log in to the Server.	<code>[hostname] consolelogin: admusr password: <i>password</i></code>
2. <input type="checkbox"/>	<b>MPS:</b> Switch user to root.	<code>\$ su - root Password:</code>
3.	<b>MPS:</b> Verify that the file present on server.	<p>Verify that the file /etc/minirc.mate is present on server: Run the following command:</p> <pre>\$ ls -l /etc/minirc.mate</pre>  <p>Move to step 5 if output is same as above otherwise continue to next step.</p>
4. <input type="checkbox"/>	<b>MPS:</b> Create the file using vi editor.	<p>Create the file /etc/minirc.mate using vi editor as follows: <code>\$ vi /etc/minirc.mate</code></p> <p>Add following lines in file /etc/minirc.mate and save the file:</p> <pre># # minirc file generated by remoteConsole Mon Sep 10 09:53:54 2018 pr port /dev/ttyS1 pu baudrate 115200 pu bits 8 pu parity N pu stopbits 1 pu rtcts No pu xonxoff No pu minit pu mreset pu mhangup pu pname1 YUNYY pu pname2 YUNYY pu pname3 YUNYN pu pname4 NDNYY pu pname5 NDNYY pu pname6 YDNYN pu pname7 YUYNN pu pname8 NDYNN</pre>

**Appendix A. 24 Procedure to add/edit the /etc/minirc.mate file**

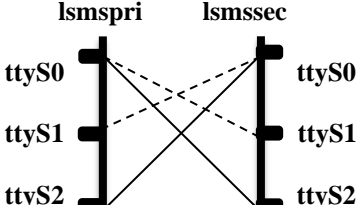
		<pre> pu pname9          YUNYN pu zauto pu fselw           No pu askdndir       No         </pre>
<p>5. <input type="checkbox"/></p>	<p><b>MPS:</b> Edit the file /etc/minirc.mate</p>	<p><b>If ttS1 is not working then edit the file /etc/minirc.mate and update ttyS1 to ttyS2 or ttyS1 to ttyS3 and change the serial cable connectivity accordingly.</b></p> <p>In following example, we have updated the file /etc/minirc.mate and changed the port value from ttyS1 to ttyS2.</p> <p><b>\$ vi /etc/minirc.mate</b></p> <pre> # # minirc file generated by remoteConsole Mon Sep 10 09:53:54 2018 pr port            /dev/ttyS2 pu baudrate       115200 pu bits           8 pu parity         N pu stopbits       1 pu rtcts          No pu xonxoff        No pu minit pu mreset pu mhangup pu pname1         YUNYY pu pname2         YUNYY pu pname3         YUNYN pu pname4         NDNYY pu pname5         NDNYY pu pname6         YDNYN pu pname7         YUYNN pu pname8         NDYNN pu pname9         YUNYN pu zauto pu fselw          No pu askdndir       No         </pre> <p><b>NOTE: In order to make this changes working we must need to change the serial cable connectivity with lsmspri and lsmssec.</b></p> <p>In following figure we have changed the serial connectivity from          ttyS0(lsmspri) &lt;-&gt; ttyS1(lsmssec) to ttyS0(lsmspri) &lt;-&gt; ttyS2(lsmssec)          and          ttyS0(lsmssec) &lt;-&gt; ttyS1(lsmspri) to ttyS0(lsmssec) &lt;-&gt; ttyS2(lsmspri)</p> 

**Appendix A. 24 Procedure to add/edit the /etc/minirc.mate file**

		<pre> ttyS3 ■■■■■■■■■■ ■■■■■■■■■■ ttyS3 </pre> <p>Here, broken line showing the old connectivity and bold line for the new connectivity.</p>
6.	<b>MPS:</b> Run “minicom mate” on the server.	<p>Run the following command:</p> <pre>\$<b>minicom mate</b></pre> <p>It should be successfully switched to mate server.</p>
7. <input type="checkbox"/>	<b>MPS:</b> Procedure completed	This procedure is complete.
8. <input type="checkbox"/>	Note down the timestamp in log.	<p>Run the following command:</p> <pre>\$ <b>date</b></pre>

**Procedure A.25 Configure the Auto Backup**

This procedure configures auto backup for PDB and RTDB on all the Non-PROVs that are homed to the PDBA.

EPAP software on all Non-PROVs homed to the PDBA should be running for successful auto RTDB backup on the Non-PROVs.

**Appendix A.25 Configure the Auto Backup**

S T E P #	1A	<p>This procedure enables the auto backup feature for the Provisioning Database.</p> <p>Estimated time: 5 minutes</p>
-----------------------	----	---

1.	<input type="checkbox"/>	<p><b>MPS 1A:</b> Navigate to the main Maintenance menu selection and select “Automatic PDB/RTDB Backup”.</p> <p>Specify the required fields and press the Submit Schedule button.</p>	<div style="border: 1px solid black; padding: 5px;"> <p style="text-align: right;">Automatic PDB/RTDB Backup</p> <hr/> <p><b>A</b></p> <div style="background-color: #f0f0f0; padding: 5px;"> <p>Backup Type (Select None to Cancel Backups) <input type="text" value="-select-"/></p> <p>Time of the day to start the Backup <input type="text"/></p> <p>Frequency <input type="text" value="-select-"/></p> <p>File Path (Directory only) <input type="text"/></p> <p>Select required IP version: <input checked="" type="radio"/> IPv4 <input type="radio"/> IPv6</p> <p>Remote Machine IP Address (IPv4=xxx.yyy.zzz.yyy) <input type="text"/></p> <p>(IPv6=xxxx:xxxx:xxxx:xxxx:xxxx:xxxx:xxxx:xxxx) <input type="text"/></p> <p>Login Name <input type="text"/></p> <p>Password <input type="text"/></p> <p>Save the local copies in the default path <input type="radio"/> Yes <input type="radio"/> No</p> <p>Do you want to delete the old backups (Local and Mate only) <input type="radio"/> Yes <input type="radio"/> No</p> <p><small>Note: If you select Yes, only the last three backup files will be retained</small></p> <p style="text-align: center;"><input type="button" value="Submit Schedule"/></p> </div> <hr/> <p style="font-size: small;">Tue March 01 2016 09:34:59 EST</p> <p style="font-size: x-small; text-align: center;">Copyright © 2000, 2015, Oracle and/or its affiliates. All rights reserved.</p> </div> <p><b>Note:</b> Kindly note that the passwords having certain special characters like \$, @, # are not allowed while configuring passwords for automatic backup transfer to remote server.</p>
2.	<input type="checkbox"/>	Note down the timestamp in log.	<p>Run the following command:</p> <p><b>\$ date</b></p>

**This procedure is complete!**

## Procedure A.26 STOP ACTIVE PDBA AND VERIFY REPL LOGS

This procedure shall be performed on Active PDBA (2A). If REPL log in not empty, part of the procedure will be performed in Standby PDBA (1A) as well.

### Appendix A.26 Procedure to add/edit the /etc/minirc.mate file

P #		
1.	<p><b>MPS 2A:</b> Stop the Customer provisioning in to the active PDB.</p> <p><input type="checkbox"/></p>	<p><b>NOTE:</b> Contact customer provisioning and verify provisioning has been deactivated.</p>
2.	<p><b>MPS 2A:</b> Log on Server.</p> <p><input type="checkbox"/></p>	<pre>[hostname] consolelogin: admusr password: password</pre>
3.	<p><b>MPS 2A:</b> Switch user to root.</p> <p><input type="checkbox"/></p>	<pre>\$ su - root Password:</pre>

4. <input type="checkbox"/>	<b>MPS 2A:</b> Stop the PDBA process	<b># service Pdba stop</b> ~~ /etc/init.d/Pdba stop ~~ PDBA application stopped.
5. <input type="checkbox"/>	<b>MPS 2A:</b> Stop the EPAP process	<b># service Epap stop</b> ~~ /etc/init.d/Epap stop ~~~ EPAP application stopped.
6. <input type="checkbox"/>	<b>MPS 2A:</b> Clear the REPL logs	<b>\$ mysql -u root -p -S/var/TKLC/epap/db/pdb/mysql.sock &lt;/usr/TKLC/epap/config/pdb_repl.sql</b> Enter password: <MySQL_root_password>
7. <input type="checkbox"/>	<b>MPS 2A:</b> Log in to the mysql database and verify that there are no updates to be sent to the standby PDB.  If any REPL log exists, follow steps 8 to 12. Otherwise jump to step 13	<b>\$ mysql -u root -p -S/var/TKLC/epap/db/pdb/mysql.sock pdb</b> Enter password: <MySQL_root_password> On the MySQL prompt, Run the following commands: <b>mysql&gt; select * from replLog;</b> Empty set (0.00 sec) <b>mysql&gt; select * from requests;</b> Empty set (0.00 sec) <b>mysql&gt; quit</b> Bye
8. <input type="checkbox"/>	<b>MPS 1A:</b> Start the PDBA and EPAP at the Standby site (1A)	<b># service Pdba start</b> ~~~ /etc/init.d/Pdba start ~~ PDBA application started.

		<b># service Epap start</b> ~~~ /etc/init.d/Epap start ~~ EPAP application started. Note : Skip the following step on Standalone PDB <b># ssh mate "service Epap start"</b> ~~ /etc/init.d/Epap start ~~~ EPAP application started.
9. <input type="checkbox"/>	<b>MPS 2A:</b> Start the PDBA at the Active site (2A)	<b># service Pdba start</b> ~~~ /etc/init.d/Pdba start ~~ PDBA application started. <b># service Epap start</b> ~~~ /etc/init.d/Epap start ~~ EPAP application started. Note : Skip the following step on Standalone PDB <b># ssh mate "service Epap start"</b>

		<pre> ~~ /etc/init.d/Epap start ~~ EPAP application started. </pre>
10.	<p><b>MPS 2A:</b></p> <input type="checkbox"/> Wait a minute for the updates to sync between Active and Standby PDBA. Check in intervals of 1 minute till all updates are sent from Active PDBA to Standby PDBA. Move to next step ONLY after checking that output of replLog and requests tables shows "Empty set".	<pre> \$ mysql -u root -p -S/var/TKLC/epap/db/pdb/mysql.sock pdb Enter password: &lt;MySQL_root_password&gt; On the MySQL prompt, Run the following commands: mysql&gt; select * from replLog; Empty set (0.00 sec) mysql&gt; select * from requests; Empty set (0.00 sec) mysql&gt; quit Bye </pre>
11.	<p><b>MPS 2A:</b></p> <input type="checkbox"/> Stop the PDBA and EPAP processes.	<pre> # service Pdba stop ~~ /etc/init.d/Pdba stop ~~ PDBA application stopped.  # service Epap stop </pre>
		<pre> ~~ /etc/init.d/Epap stop ~~ EPAP application stopped. </pre>
12.	<p><b>MPS 1A:</b></p> <input type="checkbox"/> Stop the PDBA and EPAP processes.	<pre> # service Pdba stop ~~ /etc/init.d/Pdba stop ~~ PDBA application stopped.  # service Epap stop ~~ /etc/init.d/Epap stop ~~ EPAP application stopped. </pre>

13.	<b>MPS 2A:</b> Exit as root user	\$ exit
14.	Note down the timestamp in log.	Run the following command: \$ date

### Procedure A.27 PDB Backup before upgrade

S T E P #	This procedure will perform pdb Backup	
	<p><b>Estimated time of completion: 5 minutes.</b></p> <p>Check off (☐) each step as it is completed. Boxes have been provided for this purpose under each step number.</p> <p>SHOULD THIS PROCEDURE FAIL, CONTACT TEKELEC TECHNICAL SERVICES AND <b>ASK FOR <u>MIGRATION ASSISTANCE</u></b>.</p> <p><b>PROCEDURE APPLICABLE TO: Standalone PDB, Mixed EPAP</b></p>	
1	<input type="checkbox"/> Log in to MPS A via root user	login: <root_user> Password: <admin_password>
2	<input type="checkbox"/> Stop PDB software	<pre>[root@Salta-a logs]# service Pdba stop ~~ /etc/init.d/Pdba stop ~~ PDBA application stopped.</pre> <p>Change the directory to free, to generate the mysqldump in free directory.  <b># cd /var/TKLC/epap/free</b></p>
3	<input type="checkbox"/> Generate mysqldump of PDB database: Run the following command to create mysql dump od PDB to restore later after the upgrade.  Note: mysqldump_filename can be anything	<pre>[root@Manaus-A free]# mysqldump -uroot -p&lt;MySQL_root_password&gt; pdb -S /var/TKLC/epap/db/pdb/mysql.sock &gt; mysqldump_filename.sql &amp;</pre> <p><b>Example:</b></p> <pre>[root@Devloan01 ~]# mysqldump -uroot -p&lt;MySQL_root_password&gt; pdb -S /var/TKLC/epap/db/pdb/mysql.sock &gt; mysqldump_Devloan01_01133307182024.sql&amp; [1] 29910 [root@Devloan01 ~]# mysqldump: [Warning] Using a password on the command line interface can be insecure.</pre>

<p>4</p> <p><input type="checkbox"/></p>	<p><b>MPS X:</b> Transfer file to remote machine</p>	<p>Using SFTP (secure-FTP), transfer the file to a remote, customer-provided computer. Enter “yes” when prompted if you want to continue to connect.</p> <pre>\$ cd /var/TKLC/epap/free \$ sftp admusr@10.75.141.58 Connecting to 10.75.141.58... FIPS integrity verification test failed. The authenticity of host '10.75.141.58 (10.75.141.58)' can't be established. RSA key fingerprint is 16:cf:0f:bb:cd:c3:45:8c:bf:5f:02:2b:96:4f:d1:61. Are you sure you want to continue connecting (yes/no)? yes  Warning: Permanently added '10.75.141.58' (RSA) to the list of known hosts. admusr@10.75.141.58's password: sftp&gt; put mysqldump_Recife_01133307182024.sql Uploading mysqldump_Recife_01133307182024.sql to /var/TKLC/elap/free/epap_spare_card_backup/mysqldump_Recife_01133307182024.sql mysqldump_Recife_01133307182024.sql 100% 30GB 76.0MB/s 06:45 sftp&gt; bye</pre> <p>If there is no customer provided remote computer for backups, transfer the backup file to the mate using the following command:</p> <pre>\$ sudo chmod 667 /var/TKLC/epap/free/bkp.tar.gz  \$ su – epapdev  \$ scp /var/TKLC/epap/free/ mysqldump_Devloan01_01133307182024.sql  epapdev@remoteIP:&lt;Remote server Path&gt;</pre>
<p>5</p> <p><input type="checkbox"/></p>	<p><b>This procedure is complete.</b></p>	<p><b>This procedure is complete.</b></p>

**Procedure A.28 Clear replication logs**

<p>S T E</p>	<p>This procedure will clear the replication logs for the Standalone PDDBA and Mixed EPAP</p> <hr/> <p><b>Ensure the provisioning activity has been halted before proceeding!!!</b></p>
----------------------	---

<p>P #</p>	<p><b>Estimated time of completion: 5 minutes.</b></p> <p>Check off (☐) each step as it is completed. Boxes have been provided for this purpose under each step number.</p> <p>SHOULD THIS PROCEDURE FAIL, CONTACT TEKELEC TECHNICAL SERVICES AND <b>ASK FOR <u>MIGRATION ASSISTANCE</u></b>.</p> <p><b>PROCEDURE APPLICABLE TO: Dual PDB and Dual Mixed EPAP</b></p>	
<p>1 ☐</p>	<p><b>Active PDB :</b> Switch from root to the epapdev user.</p> <p><b>Note:</b>Ensure the provisioning activity has been halted before proceeding.</p>	<pre># su - epapdev</pre>
<p>2 ☐</p>	<p><b>Active PDB:</b> Log in to the mysql database and determine the size of replLogs.</p> <p>Enter password once requested.</p>	<pre>\$ mysql -u root -p -S/var/TKLC/epap/db/pdb/mysql.sock pdb Enter password: &lt;password&gt;  Reading table information for completion of table column names You can turn off this feature to get a quicker startup with -A  Welcome to the MySQL monitor.  Commands end with ; or \g. Your MySQL connection id is 108 Server version: 5.0.37-community-log MySQL Community Edition (GPL) Type 'help;' or '\h' for help. Type '\c' to clear the buffer.  mysql&gt; select count(*) from replLog; +-----+   count(*)   +-----+   100000   +-----+ 1 row in set (0.11 sec)  mysql&gt; select count(*) from requests; +-----+   count(*)   +-----+   100000   +-----+ 1 row in set (0.06 sec)  mysql&gt; quit Bye \$</pre>

3 <input type="checkbox"/>	<b>Active PDB :</b> Clear the REPL logs.  Enter password once requested.	<pre>\$ mysql -u root -p -S/var/TKLC/epap/db/pdb/mysql.sock &lt; /usr/TKLC/epap/config/pdb_repl.sql</pre> Enter password: <password>
4 <input type="checkbox"/>	<b>Active PDB :</b> Log in to the mysql database and verify that there are no updates to be sent to the standby PDB.  Enter password once requested.  If any REPL logs exist, restart the PDBA application and allow them to replicate to the Standby PDB, then repeat this procedure.	<pre>\$ mysql -u root -p -S/var/TKLC/epap/db/pdb/mysql.sock pdb</pre> Enter password: <password>  Reading table information for completion of table column names You can turn off this feature to get a quicker startup with -A  Welcome to the MySQL monitor. Commands end with ; or \g. Your MySQL connection id is 108 Server version: 5.0.37-community-log MySQL Community Edition (GPL) Type 'help;' or '\h' for help. Type '\c' to clear the buffer.  mysql> select count(*) from replLog; Empty set (0.00 sec)  mysql> select count(*) from requests; Empty set (0.00 sec)  mysql> quit Bye
5 <input type="checkbox"/>	<b>Active PDB EPAP A:</b> Switch from epapdev to root user.	<pre>\$ exit</pre>
6 <input type="checkbox"/>	<b>Standby PDB</b>	Repeat all above steps on standby PDB as well.
7 <input type="checkbox"/>	<b>This procedure is complete.</b>	This procedure is complete.

### Procedure A.29 Remove remote PDBA IP

S T E	This procedure will delete the remote PDBA IP Address  <b>Ensure the provisioning activity has been halted before proceeding!</b>
-------------	---

**P**  
**#**  
**Estimated time of completion: 5 minutes.**

Check off (☐) each step as it is completed. Boxes have been provided for this purpose under each step number.

SHOULD THIS PROCEDURE FAIL, CONTACT TEKELEC TECHNICAL SERVICES AND **ASK FOR MIGRATION ASSISTANCE**.

PROCEDURE APPLICABLE TO: Standalone PDBA and Mixed EPAP

**1**  
☐ **Log in to root user first and then switch to epapconfig and select option 8**

**Note: Ensure the provisioning activity has been halted before proceeding**

```

/-----EPAP Configuration Menu-----\
| 1 | Display Configuration                |
| 2 | Configure Network Interfaces Menu    |
| 3 | Set Time Zone                        |
| 4 | Exchange Secure Shell Keys           |
| 5 | Change Password                      |
| 6 | Platform Menu                        |
| 7 | Configure NTP Server                 |
| 8 | PDB Configuration Menu              |
| 9 | Security                             |
|10 | SNMP Configuration                  |
|11 | Configure Alarm Feed                 |
|12 | Configure Query Server               |
|13 | Configure Query Server Alarm Feed    |
|14 | Configure SNMP Agent Community       |
|15 | DB Architecture Menu                 |
| e | Exit                                |
\-----\

Enter Choice: 8

```

**2**  
☐ **Select option 1**

```

/-----Configure PDB Menu-----\
| 1 | Configure PDB Network                |
| 2 | Configure PDB Capacity               |
| 3 | Create PDB                           |
| 4 | Change Auto DB Recovery State        |
| e | Exit                                |
\-----\

Enter Choice: 1

```

<p>3</p> <p><input type="checkbox"/></p>	<p><b>Remove the remote PDBA IP by entering 0.0.0.0.</b></p>	<pre> /-----PDB Network Configuration Menu-----\ /-----\   1   IPv4 Configuration    -----    2   IPv6 Configuration    -----    e   Exit   \-----/  Enter Choice: 1  This MPS is configured to be provisionable. The EPAP local PDBA IPv4 address is currentl The EPAP local PDBA IPv6 address is currently set to 0000:0000:0000:0000:0000:0000: The EPAP local PDBA IPv4 Address is 10.75.141.74. EPAP remote PDBA IP Address [0.0.0.0]: 0.0.0.0 </pre>
	<p>The EPAP Configuration Menu is displayed. Enter choice e, Exit.</p>	<pre> /-----EPAP Configuration Menu-----\ /-----\   1   Display Configuration    -----    2   Configure Network Interfaces Menu    -----    3   Set Time Zone    -----    4   Exchange Secure Shell Keys    -----    5   Change Password    -----    6   Platform Menu    -----    7   Configure NTP Server    -----    8   PDB Configuration Menu    -----    9   Security    -----    10   SNMP Configuration    -----    11   Configure Alarm Feed    -----    12   Configure Query Server    -----    13   Configure Query Server Alarm Feed    -----    14   Configure SNMP Agent Community    -----    15   DB Architecture Menu    -----    e   Exit   \-----/  Enter Choice: e </pre>

4	<input type="checkbox"/> This procedure is complete.	This procedure is complete.
---	--	-----------------------------

### Procedure A.30 Reset RTDB Homing Policy to remote PDBA

In case of Prov upgrade (Mixed EPAP/PDBOnly) with Live provisioning, the homing of all Non-Prov sites needs to be taken care of as below:

- a. Non-Prov sites: Change the RDTB homing to “Configure Active RTDB Homing” and select the active PDBA site, if RTDB homing is anything other than active PDBA. Refer to [Procedure A.30](#).
- b. Prov Sites: On Both PDBA sites, RTDB homing policy should be set to its local PDBA. Refer to [Procedure A.44](#).

**Note: Change the RTDB homing on all Non-Provs. Stop the EPAP Softwares on both EPAP A and B servers.**

- c. There is no need to stop provisioning.
- d. After the RTDB Homing changes, EPAP software will be started and within a few minutes, RTDBs will catch up with the PDBA level.
- e. The only side effect of this activity is that Eagle will not get live updates for around 10 minutes. As soon as EPAP software is started after the procedure, the provisioning data will be transmitted to the Eagle immediately.

S T E P #	This procedure will reset the RDTB homing policy for the Non-Prov Nodes	
	<b>Estimated time of completion: 5 minutes.</b>	
	Check off (☐) each step as it is completed. Boxes have been provided for this purpose under each step number.	
	SHOULD THIS PROCEDURE FAIL, CONTACT TEKELEC TECHNICAL SERVICES AND ASK FOR <u>MIGRATION ASSISTANCE</u> .	
	<b>PROCEDURE APPLICABLE TO: Non-Provisionable EPAPs</b>	
1	<input type="checkbox"/> MPS Switch	<b>A:</b> # su - epapconfig  Warning: Smartmatch is experimental at /usr/TKLC/plat/lib/Security/User.pm line 904.

	epapconfig menu	
2 <input type="checkbox"/>	Select option 8 from epapconfig menu	<pre> /-----EPAP Configuration Menu-----\ /-----\    1   Display Configuration             -----     2   Configure Network Interfaces Menu    -----     3   Set Time Zone                       -----     4   Exchange Secure Shell Keys          -----     5   Change Password                     -----     6   Platform Menu                       -----     7   Configure NTP Server                 -----     8   PDB Configuration Menu              -----     9   Security                             -----    10   SNMP Configuration                  -----    11   Configure Alarm Feed                 -----    12   Configure SNMP Agent Community       -----    13   Mate Disaster Recovery               -----    14   DB Architecture Menu                 -----     e   Exit                                \-----/  Enter Choice: 8 </pre>

<p>3</p> <p><input type="checkbox"/></p>	<p>Select option 2 to enter RTDB homing menu</p>	<pre> /-----Configure PDB Menu-----\ /-----\   1   Configure PDB Network    ----- -----    2   RTDB Homing Menu    ----- -----    3   Change Auto DB Recovery State    ----- -----    e   Exit   \-----/  Enter Choice: 2 </pre>
<p>4</p> <p><input type="checkbox"/></p>	<p>Read the Note in the beginning of the section and decide your homing policy.</p>	<pre> For Non-Prov Nodes:  /-----RTDB Homing Menu-----\ /-----\   1   Configure Specific RTDB Homing    ----- -----    2   Configure Active RTDB Homing    ----- -----    3   Configure Standby RTDB Homing    ----- -----    e   Exit   \-----/  Enter Choice: 2  In the event that the Active PDB is unavailable, should updates be allowed to the RTDBs from the Standby PDBA? [Y]: N  Caution: If this option is selected, the Standby PDB will not provision the RTDBs at this site in the event that the Active PDB is not available.  Are you sure you want to disallow updates to the RTDBs from the Standby PDB? [N]: Y  The RTDBs will home to the Active and will not allow updates from the Standby PDB.  Press return to continue...^ [ ] </pre>
<p>5</p> <p><input type="checkbox"/></p>	<p>MPS A and MPS B:</p>	<p>Start Epap and Pdba software to reflect the changes.  Use the following command to start Epap:  For EPAP 16.3.1/16.4.1, Run the following command to start PDBA and EPAP Softwares:</p>

	Start Epap software.	<pre>\$ service Epap Start ~~ /etc/init.d/Epap start ~~ "EPAP_RELEASE" is set to "0.617" EPAP application start Successful.  \$ service Pdba start ~~ /etc/init.d/Pdba start ~~ PDBA application start Successful.</pre> <p>For EPAP 17.1, run the following command to start PDBA and EPAP Software:</p> <pre>\$ systemctl start Epap  \$ systemctl start Pdba</pre>
6	<input type="checkbox"/> This procedure is complete.	This procedure is complete.

### Procedure A.31 Change MySql engine schema

**Note:** This procedure is need not to be implemented if migrating from 17.0.0.x.

S T E P #	<p>This procedure will Change MySql engine schema.</p> <hr/> <p><b>Estimated time of completion: 5 minutes.</b></p> <p>Check off ( <input type="checkbox"/> ) each step as it is completed. Boxes have been provided for this purpose under each step number.</p> <p>SHOULD THIS PROCEDURE FAIL, CONTACT TEKELEC TECHNICAL SERVICES AND <b>ASK FOR <u>MIGRATION ASSISTANCE</u></b>.</p> <p>PROCEDURE APPLICABLE TO: Standalone PDB, Mixed and Non-Provisionable EPAP</p>	
1	<input type="checkbox"/> Log in to epap via epapdev user on server being upgraded <p>Note: In case of Mixed or Non-Prov EPAPPerform this procedure needs to be</p>	# su – epapdev

	performed on MPS A & B.	
2	<input type="checkbox"/> Navigate to path <input type="checkbox"/> /var/TKLC/epap/free	<pre>[root@Manaus-a /]# cd /var/TKLC/epap/free/ [root@Manaus-a free]#</pre>
3	<input type="checkbox"/> Change the EuiDB engine using alter_Table.pl script  <b>Note:</b> Download the alter_table.pl script from OSDC to free directory on EPAP and change its permission to 755. Also change its ownership to epapdev:epap.	<pre>[epapdev@Manaus-A free]\$ chown epapdev:epap alter_table.pl [epapdev@Manaus-A free]\$ chmod 755 alter_table.pl [epapdev@Manaus-A free]\$ ./alter_Table.pl Success.</pre>
4	<input type="checkbox"/> Check the update by logging in to EuiDB:	<pre>[epapdev@Manaus-A free]\$ mysql -uroot -p&lt;MySQL_root_password&gt;  mysql&gt; use EuiDB; Reading table information for completion of table and column names You can turn off this feature to get a quicker startup with -A  mysql&gt; show table status\G; ***** 1. row *****       Name: alarmInfo       Engine: InnoDB       Version: 10</pre>
5	This procedure is complete.	This procedure is complete.

## Procedure A.32 Post upgrade EuiDB database restore

<b>S T E P #</b>	<p>This procedure verifies that EuiDB is restored successfully.</p> <p>Check off (✓) each step as it is completed. Boxes have been provided for this purpose under each step number.</p> <p><b>IF THIS PROCEDURE FAILS, CONTACT MY ORACLE SUPPORT AND ASK FOR <u>Migration ASSISTANCE</u>.</b></p>	
1. <input type="checkbox"/>	Verify the MIN_DSM_MEM_SIZE and PDB_SUB_CAPACITY	<p>If upgrading on EPAP 17.1, ensure to verify the following parameters and compare once the restore is complete:</p> <p>Perform the below commands to verify the MIN_DSM_MEM_SIZE and PDB_SUB_CAPACITY:</p> <pre>uiEdit   grep PDB_SUB_CAPACITY uiEdit  grep DSM_MIN_MEM_SIZE uiEdit   grep DB_ARCHITECTURE</pre>
2. <input type="checkbox"/>	Log in to EPAP server via epapdev user.	<pre>console login: epapdev password: &lt;password&gt;</pre>
3. <input type="checkbox"/>	Change the Euidb backup file permission to 644.	<pre>[epapdev@Manaus-A ~]\$ chmod 644 npdbBackup_Manus-A_20220718183527.sql.gz</pre>
4. <input type="checkbox"/>	Restore EuiDB Database	<pre>[epapdev@Manaus-A ~]\$ /usr/TKLC/epap/bin/restore_npdb.pl /var/TKLC/epap/free/npdbBackup_Manus-A_20220718183527.sql.gz Restoring up the NPDB... NPDB Restored up Successfully. [epapdev@Manaus-A ~]\$</pre>
5. <input type="checkbox"/>	Update HTTP/HTTPS variable in EuiDB	<p>Set HTTPS_ENABLED to Yes and HTTP_ENABLED to No as HTTPS is enabled after full upgrade by default. If the user wants to change the configuration, they can do it through GUI after completing the full upgrade:</p> <p>Run the following command:</p> <pre>\$ uiEdit HTTPS_ENABLED Yes \$ uiEdit HTTP_ENABLED No</pre>
6. <input type="checkbox"/>	Verify the MIN_DSM_MEM_SIZE and PDB_SUB_CAPACITY	<p>If upgrading on EPAP 17.1, ensure to verify the following parameters and compare once the restore is complete:</p> <p>Perform the below commands to verify the MIN_DSM_MEM_SIZE and PDB_SUB_CAPACITY:</p> <pre>uiEdit   grep PDB_SUB_CAPACITY uiEdit  grep DSM_MIN_MEM_SIZE uiEdit   grep DB_ARCHITECTURE</pre>

<p>7. <input type="checkbox"/></p>	<p>Disable Watchers if enabled</p>	<p>If watchers are enabled, disable them.</p> <p>Use the below command to find the user for which watchers are enabled.</p> <pre>\$ mysql -uroot -p -e "select loginid from uiuser where debugAllowed=1" EuiDB</pre> <p><b>example:</b></p> <pre>\$ mysql -uroot -p -e "select loginid from uiuser where debugAllowed=1" EuiDB Enter password: +-----+   loginid   +-----+   epapall     uiadmin   +-----+</pre> <p>If the above output is blank, then the watcher is already disabled. The rest of the commands in this step can be skipped. Move on to the next step.</p> <p>If you get user/users as the output for the above command, it means that the watcher is enabled for those users. Disable the watcher for each user by using the below commands one by one.</p> <pre>\$ setDebug &lt;user&gt; 0</pre> <p><b>example:</b></p> <pre>\$ setDebug epapall 0 changing debug from "1" to "0". \$ setDebug uiadmin 0 changing debug from "1" to "0".</pre> <p>Verify if watchers are disabled.</p> <pre>[epapdev@Cusco-a bin]\$ mysql -uroot -p -e "select loginid from uiuser where debugAllowed=1" EuiDB Enter password:</pre> <p>There will be no users in the output now.</p>
<p>8. <input type="checkbox"/></p>	<p>Procedure complete.</p>	<p>This procedure is complete.</p>

## Procedure A.33 Post upgrade PDB database restore

<b>S T E P #</b>	<p>This procedure verifies that PDB is restored successfully</p> <p>Check off (✓) each step as it is completed. Boxes have been provided for this purpose under each step number.</p> <p><b>IF THIS PROCEDURE FAILS, CONTACT MY ORACLE SUPPORT AND ASK FOR <u>Migration ASSISTANCE</u>.</b></p>	
1. <input type="checkbox"/>	Log in to EPAP server via root user	<pre>console login:root password: &lt;password&gt;</pre>
2. <input type="checkbox"/>	If upgrading from EPAP 17.0.0.x to EPAP 17.1, perform this step. Else, continue from step 3.	<p>Perform <a href="#">Procedure A.52</a> to restore the PDB database.</p> <p>If Procedure A.52 is performed, this procedure (A.33) ends here.</p>
3. <input type="checkbox"/>	Change the permission of mysqldump file to 666. Run the command.	<pre># chmod 666 mysqldump_Recife_01133307182024.sql</pre>
4. <input type="checkbox"/>	Run the following command to restore mysqldump.	<p>To monitor time as well as progress while restoring the db please use the following command only. This is supported only for EPAP version 17.0.0.5.0 and beyond:</p> <pre># pv mysqldump_backupfile.sql   mysql -uroot - p&lt;MySQL_root_password&gt; pdb -S /var/TKLC/epap/db/pdb/mysql.sock &amp;&amp; echo "Restore complete"</pre> <p>In case you don't want to monitor the progress use the following:</p> <pre># mysql -uroot -p&lt;MySQL_root_password&gt; pdb -S /var/TKLC/epap/db/pdb/mysql.sock &lt; mysqldump_backupfile.sql &amp;</pre> <p>Example:</p> <pre>[root@Recife-A free]# mysql -uroot - p&lt;MySQL_root_password&gt; pdb -S /var/TKLC/epap/db/pdb/mysql.sock &lt; mysqldump_Recife_01133307182024.sql &amp; [1] 853397</pre> <p>To run PDB Restore_Monitor.h script, follow the below steps. This is supported till EPAP version 17.0.0.4.0.</p>

		<ol style="list-style-type: none"> <li>1. Download the Restore_Monitor.zip provided with the build.</li> <li>2. Copy the zip in free, unzip the folder and set the permissions.  <pre>\$ cd /var/TKLC/epap/free</pre> <pre>\$ unzip Restore_Monitor.zip</pre> <pre>\$ chmod 777 Restore_Monitor.sh</pre> </li> <li>3. Run the script in background mode.  <pre>\$ ./Restore_Monitor.sh &amp;</pre> </li> <li>4. This script will log the progress in the file  <pre>/var/TKLC/epap/free/Restore_Monitor.log .</pre> </li> </ol>
5. <input type="checkbox"/>	<p>Run the following commands to add the Isblset parameter in dn_bl and dnB_bl tables in pdb.</p> <p><b>Note:</b> This step is applicable only in case. <b>user is migrating from 16.3 release regardless of DB architecture</b></p>	<p>The below commands will add Isblset column in dn_bl and dnB_bl table of PDB database.</p> <pre># mysql -u root -p pdb -S /var/TKLC/epap/db/pdb/mysql.sock -e 'ALTER TABLE dn_bl ADD Isblset int'</pre> <pre># mysql -u root -p pdb -S /var/TKLC/epap/db/pdb/mysql.sock -e 'ALTER TABLE dnB_bl ADD Isblset int'</pre> <p><b>Example:</b></p> <pre>[root@Devloan01 ~]# mysql -u root -p pdb -S /var/TKLC/epap/db/pdb/mysql.sock -e 'ALTER TABLE dn_bl ADD Isblset int'</pre> <p>Enter password:</p> <pre>[root@Devloan01 ~]# mysql -u root -p pdb -S /var/TKLC/epap/db/pdb/mysql.sock -e 'ALTER TABLE dnB_bl ADD Isblset int'</pre> <p>Enter password:</p> <pre>[root@Devloan01 ~]#</pre>

**Note:** If one site is already upgraded to EPAP 17.1, then follow the steps in Appendix A.43 to restore the PDB.

### Procedure A.34 Add Remote PDBA IP Address

S T E	<p>This procedure will add remote PDBA IP address</p> <hr/> <p style="text-align: center;"><b>Ensure the provisioning activity has been halted before proceeding!!!</b></p>
-------------	---

**P**  
**#**  
**Estimated time of completion: 5 minutes.**

Check off (☐) each step as it is completed. Boxes have been provided for this purpose under each step number.

SHOULD THIS PROCEDURE FAIL, CONTACT TEKELEC TECHNICAL SERVICES AND **ASK FOR MIGRATION ASSISTANCE**.

**PROCEDURE APPLICABLE TO: Standalone PDB and Mixed EPAP**

**1**

Log in to epapconfig on PDB server being upgraded and select option 8.

```

warning: Smartmatch is experimental at
/usr/TKLC/plat/lib/Security/User.pm line 904.

/-----EPAP Configuration Menu-----\
| 1 | Display Configuration                |
| 2 | Configure Network Interfaces Menu    |
| 3 | Set Time Zone                        |
| 4 | Exchange Secure Shell Keys           |
| 5 | Change Password                      |
| 6 | Platform Menu                        |
| 7 | Configure NTP Server                 |
| 8 | PDB Configuration Menu               |
| 9 | Security                             |
|10 | SNMP Configuration                  |
|11 | Configure Alarm Feed                 |
|12 | Configure Query Server               |
|13 | Configure Query Server Alarm Feed    |
|14 | Configure SNMP Agent Community       |
|15 | DB Architecture Menu                 |
| e | Exit                                 |
\-----\

Enter Choice: 8

```

**2**

Select option 1.

```

/-----Configure PDB Menu-----\
| 1 | Configure PDB Network                |
| 2 | Configure PDB Capacity               |
| 3 | Create PDB                           |
| 4 | Change Auto DB Recovery State        |
| e | Exit                                 |
\-----\

Enter Choice: 1

```

<p>3</p> <p><input type="checkbox"/></p>	<p>Add the remote PDBA IP by entering &lt;Remote PDBA IP&gt;.</p>	<pre> MPS Side A: hostname: Salta-a  hostid: 4b0a4a8d Platform Version: 6.1.4-7.8.1.0.0_89.13.0 Software Version: EPAP 170.0.1-17.0.0.0.0_170.1.0 Fri Jul 22 08:06:26 EDT 2022  /-----PDB Network Configuration Menu-\ /-----\   1   IPv4 Configuration         --- -----    2   IPv6 Configuration         --- -----    e   Exit                      \-----/  Enter Choice: 1 This MPS is configured to be provisionable. The EPAP local PDBA IPv4 address is currently set to 10.75.141.74 The EPAP local PDBA IPv6 address is currently set to 0000:0000:0000:0000:0000:0000:0000:0000 EPAP software and PDBA are running. Stop them? [N]: Y The EPAP local PDBA IPv4 Address is 10.75.141.74. EPAP remote PDBA IP Address [0.0.0.0]: 10.75.141.75 </pre>
<p>4</p> <p><input type="checkbox"/></p>	<p>Remote PDB</p>	<p>Repeat all the above steps on the remote PDB.</p>
<p>5</p> <p><input type="checkbox"/></p>	<p>This procedure is complete.</p>	<p>This procedure is complete.</p>

### Procedure A.35 Keys exchange between active PDB and standby PDB

<p>S T E P #</p>	<p>This procedure Exchange the keys between active and remote PDB.</p> <hr/> <p><b>Estimated time of completion: 5 minutes.</b></p> <p>Check off (☐) each step as it is completed. Boxes have been provided for this purpose under each step number.</p> <p>SHOULD THIS PROCEDURE FAIL, CONTACT TEKELEC TECHNICAL SERVICES AND <b>ASK FOR <u>MIGRATION ASSISTANCE</u></b>.</p>
----------------------------------	--

PROCEDURE APPLICABLE TO: Dual Mixed or Dual PDBonly server

<p>1 <input type="checkbox"/></p>	<p>For key exchange on Standby PDB on 17.1 release and Active PDB on 16.3.1/16.4.1 release</p>	<p>Follow step 3 to step 16.</p>
<p>2 <input type="checkbox"/></p>	<p>For key exchange between Active PDB on 17.1 release and Standby also on release 17.1</p>	<p>Follow step 17 to end.</p>
<p>3 <input type="checkbox"/></p>	<p>MPS A: Log in to PDB EPAP server on release 17.1 as the user "epapdev".</p>	<p>If not already logged in, then log in at PDB EPAP: Console.</p> <p>login: epapdev password:</p>
<p>4 <input type="checkbox"/></p>	<p>Perform the following procedure on EPAP 17.1:</p> <p><b>Note:</b> Generating RSA keys first with servers installed on older release 16.3.1/16.4.1.</p> <p><b>Also, Generate RSA key with both sides in case of mixed epap.</b></p>	<p>In case of PDBonly server, run the below command: Here, remotepdb_IP is EPAP 16.3.1/16.4.1 machine Ip.</p> <pre># ssh epapdev@remotepdb_IP "/usr/bin/ssh-keygen -t rsa -f .ssh/id_rsa -N '' "</pre> <p>In case of mixed server, run the following command:</p> <p>Here, remotepdb_EPAPA_IP and remotepdb_EPAPB_IP are EPAP 16.3.1/16.4.1, A and B machine Ips.</p> <pre># ssh epapdev@remotepdb_EPAPA_IP "/usr/bin/ssh-keygen -t rsa -f .ssh/id_rsa -N '' " # ssh epapdev@remotepdb_EPAPB_IP "/usr/bin/ssh-keygen -t rsa -f .ssh/id_rsa -N '' "</pre> <p>Example: Recife is EPAP 17 server and 10.75.141.55 and 10.75.141.56 are EPAP A and B machines of the other mixed server which is on EPAP 16.3.1.</p> <pre>[epapdev@Recife-A free]\$ ssh epapdev@10.75.141.55 "/usr/bin/ssh-keygen -t rsa -f .ssh/id_rsa -N '' " epapdev@10.75.141.55's password: Generating public/private rsa key pair. Your identification has been saved in .ssh/id_rsa. Your public key has been saved in .ssh/id_rsa.pub. The key fingerprint is: 47:54:4c:74:96:f2:e9:31:1f:b1:a8:5f:81:64:36:f0 epapdev@Devloan01 The key's randomart image is: +--[ RSA 2048 ]-----+            .*= o.             . +B..            . +E+.o             .  O=+  </pre>

	<pre> S . . . +0 . . . . . . . .  +-----+ [epapdev@Recife-A free]\$ ssh epapdev@10.75.141.56 "/usr/bin/ssh-keygen -t rsa -f .ssh/id_rsa -N '' " epapdev@10.75.141.56's password: Generating public/private rsa key pair. Your identification has been saved in .ssh/id_rsa. Your public key has been saved in .ssh/id_rsa.pub. The key fingerprint is: af:08:75:05:38:00:b9:0c:1e:61:e7:9b:6a:d3:82:47 epapdev@Devloan02 The key's randomart image is: +--[ RSA 2048]-----+   oo+.. ..              o.+  o  .            .o.o  .  .             .o o   .               Eo  . S            ..o  . . .            . =... .             ..o ...                            . .    +-----+ [epapdev@Recife-A free]\$ </pre>
<p>5 <input type="checkbox"/> MPS A: The EPAP Configuration Menu is displayed. Select choice 8, PDB Configure Menu.</p>	<pre> Switch to root user., \$su - &lt;root Password&gt; \$su - epapconfig  /-----EPAP Configuration Menu-----\ /-----\   1   Display Configuration              2   Configure Network Interfaces Menu     3   Set Time Zone                       4   Exchange Secure Shell keys          5   Change Password                     6   Platform Menu                       7   Configure NTP Server               8   PDB Configuration Menu             9   Security                            10   SNMP Configuration               \-----/ </pre>

		<pre> 11   Configure Alarm Feed 12   Configure Query Server 13   Configure Query Server Alarm Feed 14   Configure SNMP Agent Community 15   DB Architecture Menu e    Exit </pre> <p>Enter Choice: 8</p>
<p>6</p> <input type="checkbox"/>	<p>MPS A: The Configure PDB Menu is displayed. Select choice 1.</p>	<pre> /-----Configure PDB Menu-----\   1   Configure PDB Network   2   Create PDB   3   Change Auto DB Recovery State   e   Exit </pre> <p>Enter Choice: 1</p>
<p>7</p> <input type="checkbox"/>	<p>MPS A: The PDB Network Configuration Menu is displayed. Select choice 1.</p> <p>Provide remote PDBA IP address.</p>	<p><b>PDB Network Configuration Menu for standalone PDB:</b></p> <p>MPS Side A: hostname: Tacna-B-PDBonly hostid: 4b0a218d  Platform Version: 7.0.1-8.5.0.0.0_100.8.1  Software Version: EPAP 170.0.6-<b>17.0.0.0.0_170.6.0</b>  Mon Nov 14 18:11:45 EST 2022</p> <pre> /-----PDB Network Configuration Menu-\   1   IPv4 Configuration   2   IPv6 Configuration   e   Exit </pre> <p>Enter Choice: 1</p> <p>This MPS is configured to be provisionable. The EPAP local PDBA IPv4 address is currently set to 10.75.141.33  The EPAP local PDBA IPv6 address is currently set to 0000:0000:0000:0000:0000:0000:0000:0000  The EPAP local PDBA IPv4 Address is 10.75.141.33.  EPAP remote PDBA IP Address [0.0.0.0]: 10.75.141.32</p>

The server does not know of 10.75.141.32.  
Will just exchange host keys for the name given!  
Password of epapdev:  
The server does not know of 10.75.141.32.  
Will just exchange host keys for the name given!  
ssh is working correctly.  
Attempting to give PDB privileges to: 10.75.141.32  
PDB privileges have been set for 10.75.141.32

**PDB Network Configuration Menu for Mixed EPAP:**

MPS Side A: hostname: Recife-A hostid: 4b0a3d8d  
Platform Version: 7.0.1-8.9.0.1.0\_130.6.0  
Software Version: EPAP 170.0.26-17.0.0.4.0\_170.25.0  
Sun Jun 24 10:44:43 EDT 2018

```
/-----PDB Network Configuration Menu-----\  
| 1 | IPv4 Configuration |  
| 2 | IPv6 Configuration |  
| e | Exit |  
\-----/
```

Enter Choice: 1

Verifying connectivity with mate...  
This MPS is configured to be provisionable. The EPAP local PDBA IPv4 address is currently set to 10.75.141.61  
The EPAP local PDBA IPv6 address is currently set to 0000:0000:0000:0000:0000:0000:0000:0000  
EPAP software and PDBA are running. Stop them? [N]: Y  
The EPAP local PDBA IPv4 Address is 10.75.141.61.  
EPAP remote PDBA IP Address [0.0.0.0]: 10.75.141.55  
EPAP remote PDBA B machine IP Address [0.0.0.0]: 10.75.141.56  
The server does not know of 10.75.141.55.  
Will just exchange host keys for the name given!  
Password of epapdev:  
The server does not know of 10.75.141.55.  
Will just exchange host keys for the name given!  
ssh is working correctly.  
Attempting to give PDB privileges to: 10.75.141.55  
PDB privileges have been set for 10.75.141.55  
Attempting to give PDB privileges to: 10.75.141.55  
PDB privileges have been set for 10.75.141.55  
Attempting to give PDB privileges to: 10.75.141.61  
PDB privileges have been set for 10.75.141.61

<p>8</p> <input type="checkbox"/>	<p>Exit from epapconfig menu</p>	<pre>MPS Side A: hostname: Tacna-B-PDBOnly hostid: 4b0a218d Platform Version: 7.0.1-8.5.0.0.0_100.8.1 Software Version: EPAP 170.0.6-17.0.0.0.0_170.6.0 Mon Nov 14 18:12:34 EST 2022  /-----PDB Network Configuration Menu-----\ /-----\   1   IPv4 Configuration  -----    2   IPV6 Configuration  -----    e   Exit \-----\  Enter Choice: e</pre>
<p>9</p> <input type="checkbox"/>	<p>MPS A: Log in to PDB EPAP server on release 16.4.1/16.3.1 as the user "epapdev".</p>	<p>If not already logged in, then log in at PDB EPAP: Console.</p> <pre>login: epapdev password:</pre>
<p>10</p> <input type="checkbox"/>	<p>Run the following command on PDB on 16.3.1/16.4.1 server to update the epapui.pl:</p> <pre>sed -i 's/my \$command=\$SSH_SCRIPT . "\$remotePdba";/my \$command=\$SSH_SCRIPT . " --key=id_rsa.pub \$remotePdba";/g' /usr/TKLC/epap/bin/epapui.pl</pre>	<pre>[epapdev@EPAP ~]\$ sed -i 's/my \$command=\$SSH_SCRIPT . "\$remotePdba";/my \$command=\$SSH_SCRIPT . " --key=id_rsa.pub \$remotePdba";/g' /usr/TKLC/epap/bin/epapui.pl</pre>
<p>11</p> <input type="checkbox"/>	<p>Run the following command to verify the mentioned in above command:</p> <pre>grep "\\$command=\\$SSH_SCRIPT" /usr/TKLC/epap/bin/epapui.pl</pre>	<pre># grep "\\$command=\\$SSH_SCRIPT" /usr/TKLC/epap/bin/epapui.pl  \$command=\$SSH_SCRIPT. ' mate'; my \$command=\$SSH_SCRIPT . " --key=id_rsa.pub \$remotePdba";</pre>
<p>12</p> <input type="checkbox"/>	<p>MPS A: The EPAP Configuration Menu is displayed. Select choice 8 on the PDB Configure Menu.</p>	<pre>Switch to root user., \$su - &lt;root Password&gt; \$su - epapconfig  /-----EPAP Configuration Menu-----\ /-----\   1   Display Configuration  ----- </pre>

		<pre>   2   Configure Network Interfaces Menu    --- -----    3   Set Time Zone    --- -----    4   Exchange Secure Shell Keys    --- -----    5   Change Password    --- -----    6   Platform Menu    --- -----    7   Configure NTP Server    --- -----    8   PDB Configuration Menu    --- -----    9   Security    --- -----   10   SNMP Configuration    --- -----   11   Configure Alarm Feed    --- -----   12   Configure Query Server    --- -----   13   Configure Query Server Alarm Feed    --- -----   14   Configure SNMP Agent Community    --- -----   15   DB Architecture Menu    --- -----    e   Exit   \-----/  Enter Choice: 8 </pre>
13 <input type="checkbox"/>	MPS A: The Configure PDB Menu is displayed. Select choice 1.	<pre> /-----Configure PDB Menu-----\ /-----\   1   Configure PDB Network    --- -----    2   Create PDB    --- -----    3   Change Auto DB Recovery State    --- -----    e   Exit   \-----/  Enter Choice: 1 </pre>
14 <input type="checkbox"/>	MPS A: The PDB Network Configuration Menu is displayed. Select choice 1.	<b>PDB Network Configuration Menu for Standalone PDB:</b>  MPS Side A: hostname: Tacna-A-PDBonly hostid: 4b0a208d



		<p>The EPAP local PDBA IPv4 Address is 10.75.141.55.  EPAP remote PDBA IP Address [0.0.0.0]: 10.75.141.61  EPAP remote PDBA B machine IP Address [0.0.0.0]: 10.75.141.62  Password of epapdev:  ssh is working correctly.  Attempting to give PDB privileges to: 10.75.141.61  PDB privileges have been set for 10.75.141.61  Attempting to give PDB privileges to: 10.75.141.61  PDB privileges have been set for 10.75.141.61  Attempting to give PDB privileges to: 10.75.141.55  PDB privileges have been set for 10.75.141.55</p>
15 <input type="checkbox"/>	Exit from epapconfig menu.	MPS Side A: hostname: Tacna-A-PDBonly hostid: 4b0a208d Platform Version: 6.1.4-7.8.1.0.0_89.13.0 Software Version: EPAP 164.0.15-16.4.1.0.0_164.16.0 Mon Nov 14 18:48:19 EST 2022  /-----PDB Network Configuration Menu-----\   1   IPv4 Configuration  \   2   IPv6 Configuration  \   e   Exit  \ Enter Choice: e
16	MPS A: Start Epap and Pdba software on Active and Standby PDBA Site.	Start Epap and Pdba software to reflect the changes.  Use the following command to start EPAP:  For EPAP 16.3.1/16.4.1, run the following command to start PDBA and EPAP Software:  <b>\$ service Epap Start</b> ~~ /etc/init.d/Epap start ~~ "EPAP_RELEASE" is set to "0.617" EPAP application start Successful.  <b>\$ service Pdba start</b> ~~ /etc/init.d/Pdba start ~~ PDBA application start Successful.  For EPAP 17.1, run the following command to start PDBA and EPAP Software:  <b>\$ systemctl start Epap</b>  <b>\$ systemctl start Pdba</b>

17 <input type="checkbox"/>	MPS A: Log in to PDB EPAP server which is newly made on release 17.1 as the user "epapdev".	If not already logged in, then log in at PDB EPAP: console  login: epapdev password:
18 <input type="checkbox"/>	MPS A: The EPAP Configuration Menu is displayed. Select choice 8,PDB Configure Menu.	Switch to root user., \$su - <root Password> \$su - epapconfig  /-----EPAP Configuration Menu-----\ /-----\ 1   Display Configuration ----- 2   Configure Network Interfaces Menu ----- 3   Set Time Zone ----- 4   Exchange Secure Shell keys ----- 5   Change Password ----- 6   Platform Menu ----- 7   Configure NTP Server ----- 8   PDB Configuration Menu ----- 9   Security ----- 10   SNMP Configuration ----- 11   Configure Alarm Feed ----- 12   Configure Query Server ----- 13   Configure Query Server Alarm Feed ----- 14   Configure SNMP Agent Community ----- 15   DB Architecture Menu ----- e   Exit ----- \ Enter Choice: 8

<p>19</p> <p><input type="checkbox"/></p>	<p>MPS A: The Configure PDB Menu is displayed. Select choice 1.</p>	<pre> /-----Configure PDB Menu-----\ /-----\ 1   Configure PDB Network 2   Create PDB 3   Change Auto DB Recovery State e   Exit \-----/  Enter Choice: 1 </pre>
<p>20</p> <p><input type="checkbox"/></p>	<p>MPS A: The PDB Network Configuration Menu is displayed. Select choice 1.</p> <p>Provide remote PDBA IP address.</p>	<pre> MPS Side A: hostname: Tacna-B-PDBOnly hostid: 4b0a218d Platform Version: 7.0.1-8.5.0.0.0_100.8.1 Software Version: EPAP 170.0.6-17.0.0.0.0_170.6.0 Mon Nov 14 18:11:45 EST 2022  /-----PDB Network Configuration Menu-\ /-----\ 1   IPv4 Configuration 2   IPv6 Configuration e   Exit \-----/  Enter Choice: 1  This MPS is configured to be provisionable. The EPAP local PDBA IPv4 address is currently set to 10.75.141.33 The EPAP local PDBA IPv6 address is currently set to 0000:0000:0000:0000:0000:0000:0000:0000 The EPAP local PDBA IPv4 Address is 10.75.141.33. EPAP remote PDBA IP Address [10.75.141.32.]: &lt;press enter&gt; The server does not know of 10.75.141.32 Will just exchange host keys for the name given! Password of epapdev: The server does not know of 10.75.141.32. Will just exchange host keys for the name given! ssh is working correctly. Attempting to give PDB privileges to: 10.75.141.32 PDB privileges have been set for 10.75.141.32 </pre>
<p>21</p> <p><input type="checkbox"/></p>	<p>Exit from epapconfig menu</p>	<pre> MPS Side A: hostname: Tacna-A-PDBOnly hostid: 4b0a218d Platform Version: 7.0.1-8.5.0.0.0_100.8.1 Software Version: EPAP 170.0.6-17.0.0.0.0_170.6.0 Mon Nov 14 18:12:34 EST 2022 </pre>

		<pre> /-----PDB Network Configuration Menu-\ /-----\   1   IPv4 Configuration    -----    2   IPv6 Configuration    -----    e   Exit   \-----/  Enter Choice: e </pre>
22	MPS A: Log in to Active PDB EPAP server which is already on release 17.1 as the user "epapdev".	If not already logged in, then log in to PDB EPAP: console login: epapdev password:
23	MPS A: The EPAP Configuration Menu is displayed. Select choice 8,PDB Configure Menu.	Switch to root user., \$su - <root Password> \$su - epapconfig <pre> /-----EPAP Configuration Menu-----\ /-----\   1   Display Configuration    -----    2   Configure Network Interfaces Menu    -----    3   Set Time Zone    -----    4   Exchange Secure Shell keys    -----    5   Change Password    -----    6   Platform Menu    -----    7   Configure NTP Server    -----    8   PDB Configuration Menu    -----    9   Security    -----   10   SNMP Configuration    -----   11   Configure Alarm Feed    -----   12   Configure Query Server    -----   13   Configure Query Server Alarm Feed    -----   14   Configure SNMP Agent Community    -----  </pre>

		<pre> 15   DB Architecture Menu ----- e   Exit \-----/  Enter Choice: 8 </pre>
24	<p>MPS A: The Configure PDB Menu is displayed. Select choice 1.</p>	<pre> /-----Configure PDB Menu-----\ /-----\ 1   Configure PDB Network ----- 2   Create PDB ----- 3   Change Auto DB Recovery State ----- e   Exit \-----/  Enter Choice: 1 </pre>
25	<p>MPS A: The PDB Network Configuration Menu is displayed. Select choice 1.</p> <p>Provide remote PDBA IP address.</p>	<pre> MPS Side A: hostname: Tacna-A-PDBonly hostid: 4b0a218d Platform Version: 7.0.1-8.5.0.0.0_100.8.1 Software Version: EPAP 170.0.6-17.0.0.0.0_170.6.0 Mon Nov 14 18:11:45 EST 2022  /-----PDB Network Configuration Menu-\ /-----\ 1   IPv4 Configuration ----- 2   IPv6 Configuration ----- e   Exit \-----/  Enter Choice: 1  This MPS is configured to be provisionable. The EPAP local PDBA IPv4 address is currently set to 10.75.141.32 The EPAP local PDBA IPv6 address is currently set to 0000:0000:0000:0000:0000:0000:0000:0000 The EPAP local PDBA IPv4 Address is 10.75.141.32. EPAP remote PDBA IP Address [0.0.0.0]: 10.75.141.33 The server does not know of 10.75.141.33 Will just exchange host keys for the name given! Password of epapdev: The server does not know of 10.75.141.33. Will just exchange host keys for the name given! ssh is working correctly. Attempting to give PDB privileges to: 10.75.141.33 PDB privileges have been set for 10.75.141.33 </pre>

26	Exit the epapconfig menu.	<pre> MPS Side A: hostname: Tacna-B-PDBOnly hostid: 4b0a218d Platform Version: 7.0.1-8.5.0.0.0_100.8.1 Software Version: EPAP 170.0.6-17.0.0.0.0_170.6.0 Mon Nov 14 18:12:34 EST 2022  /-----PDB Network Configuration Menu-----\ /-----\   1   IPv4 Configuration    -----    2   IPv6 Configuration    -----    e   Exit   \-----\  Enter Choice: e </pre>
27	MPS A: Start EPAP and PDBA software on Active and Standby PDBA Site.	<pre> Start EPAP and PDBA software to reflect the changes. Use the following command to start Epap:  For EPAP 16.3.1/16.4.1, run the following command to start PDBA and EPAP Softwares:  \$ service Epap start ~~ /etc/init.d/Epap start ~~ "EPAP_RELEASE" is set to "0.617" EPAP application start Successful.  \$ service Pdba start ~~ /etc/init.d/Pdba start ~~ PDBA application start Successful.  For EPAP 17.1, run the following command to start PDBA and EPAP Software:  \$ systemctl start Epap  \$ systemctl start Pdba </pre>
28	Procedure complete <input type="checkbox"/>	This procedure is complete.

## Procedure A.36: RTDB restore after Upgrade

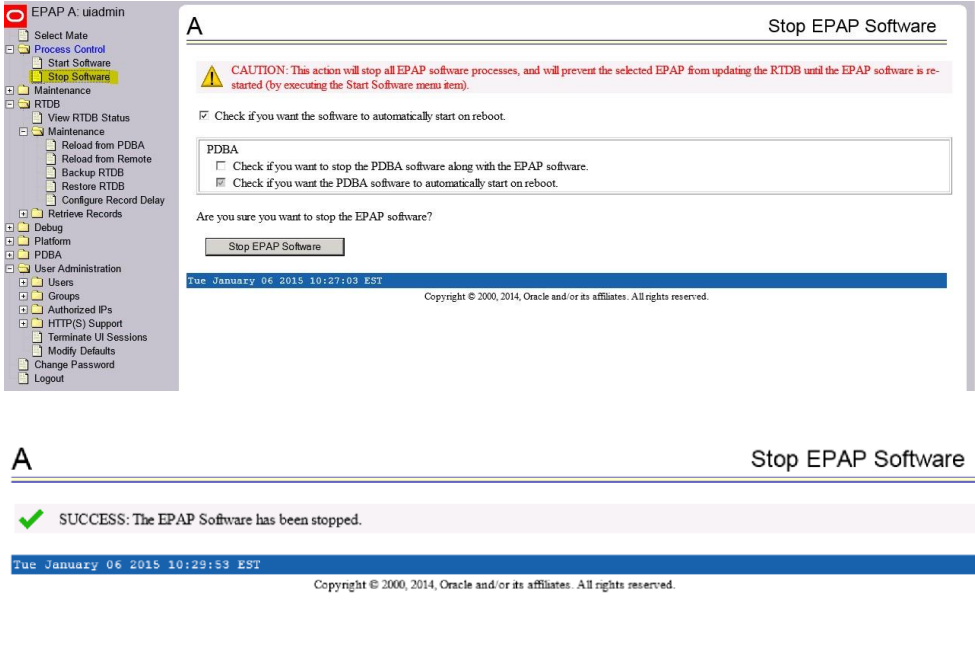
<p><b>S</b> <b>T</b> <b>E</b> <b>P</b> <b>#</b></p>	<p>This procedure provides instructions to restore RTDB from a backup file.</p> <p>Check off (✓) each step as it is completed. Boxes have been provided for this purpose under each step number.</p> <p>IF THIS PROCEDURE FAILS, CONTACT MY ORACLE SUPPORT AND ASK FOR ASSISTANCE.</p>
<p>1. <input type="checkbox"/> <b>EPAP A:</b> Log in to the web GUI as user "uiadmin".</p>	
<p>2. <input type="checkbox"/> <b>EPAP A:</b> Stop Software.</p> <p>On the menu, click Process Control-&gt;Stop Software.</p> <p>Click "Stop EPAP Software" Button</p>	 <p>The screenshot shows the 'Stop EPAP Software' dialog box in the EPAP A web GUI. The dialog has a title bar 'A Stop EPAP Software'. It contains a yellow warning icon and the text: 'CAUTION: This action will stop all EPAP software processes, and will prevent the selected EPAP from updating the RTDB until the EPAP software is restarted (by executing the Start Software menu item)'. Below this, there is a checked checkbox for 'Check if you want the software to automatically start on reboot.' and a section for 'PDBA' with two unchecked checkboxes: 'Check if you want to stop the PDBA software along with the EPAP software.' and 'Check if you want the PDBA software to automatically start on reboot.'. A question 'Are you sure you want to stop the EPAP software?' is followed by a 'Stop EPAP Software' button. The dialog footer shows the date 'Tue January 06 2015 10:27:03 EST' and copyright information. Below the dialog, a green checkmark icon and the text 'SUCCESS: The EPAP Software has been stopped.' are visible, along with the date 'Tue January 06 2015 10:29:53 EST' and copyright information.</p>

3. EPAP A: Restore RTDB.



On the menu, click RTDB->Maintenance>Restore RTDB

Select the backup file, then click "Restore RTDB from the Selected File" Button

Click "Confirm RTDB Restore" Button

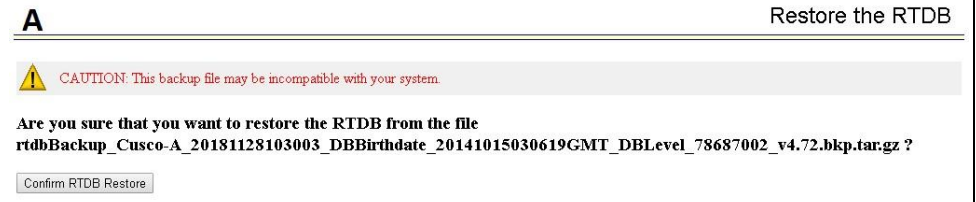
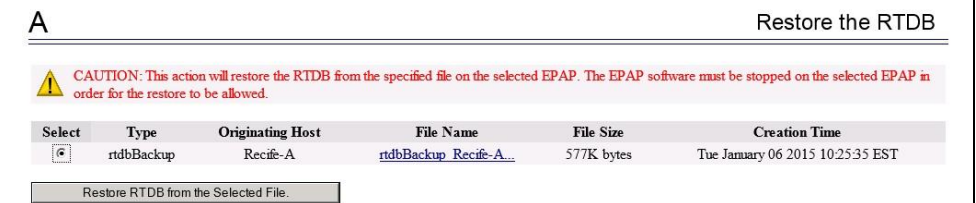
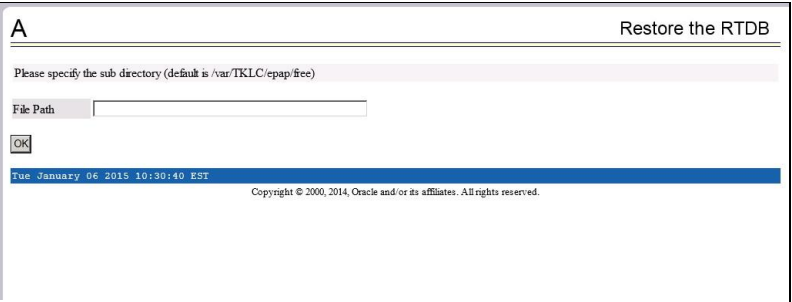
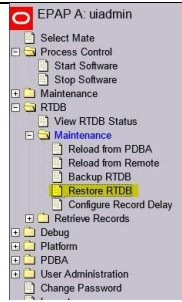

**NOTE:** Caution message regarding "incompatible file" is displayed in above snapshot as the backup file is taken on RTDB version 4 and is being restored on RTDB version 5.

**Restore successfully started:**

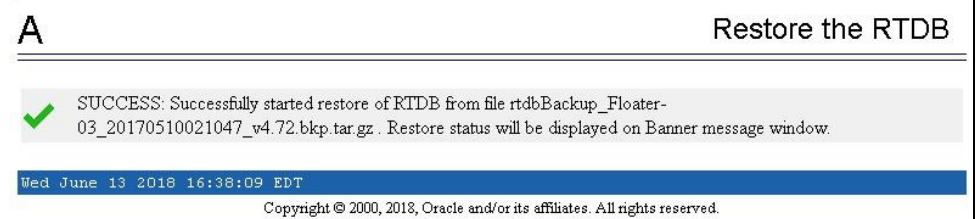

<p>4. <input type="checkbox"/></p>	<p><b>EPAP A:</b> Make EPAP down.</p> <p>An IM alarm should be observed with informational message on EPAP GUI confirming that restore RTDB is in progress.</p> <p>An IM alarm should be observed with informational message on EPAP GUI confirming that restore RTDB completed successfully.</p>	<p style="text-align: right;">Confirming that Restore RTDB in progress:</p> <div style="border: 1px solid black; padding: 10px;"> <p style="font-size: 2em; font-weight: bold; margin: 0;">A</p> <h2 style="text-align: right; margin: 0;">Informational Messages</h2> <hr/> <div style="background-color: #e0e0e0; padding: 5px; text-align: center;"> <p><b>Informational Messages</b></p> <p>Restore RTDB in progress</p> </div> <div style="background-color: #0056b3; color: white; padding: 2px 5px; font-weight: bold; margin-top: 5px;">             Wed June 13 2018 16:39:09 EDT           </div> <p style="text-align: center; font-size: 0.8em; margin-top: 5px;">Copyright © 2000, 2018, Oracle and/or its affiliates. All rights reserved.</p> </div>
------------------------------------	---	---

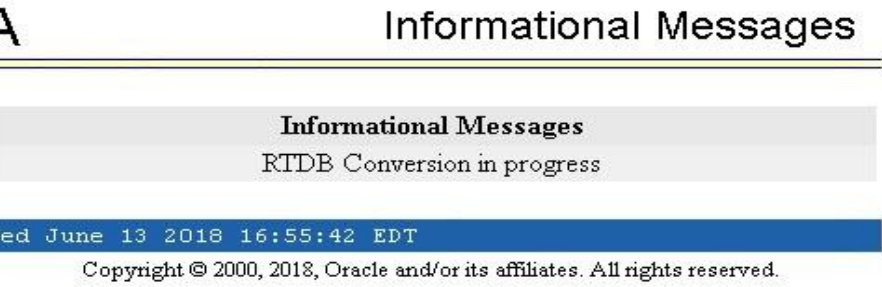
	<p>Click “Confirm RTDB Restore” Button</p>	<p>Confirming that Restore RTDB is completed successfully:</p>  <p>The screenshot shows a window titled 'Informational Messages'. At the top, there is a large 'A' icon. Below it, the text 'Restore RTDB completed successfully' is displayed in a grey box. A blue bar indicates the time 'Fri June 15 2018 00:30:27 EDT'. At the bottom, the copyright notice 'Copyright © 2000, 2018, Oracle and/or its affiliates. All rights reserved.' is visible.</p>
<p>5.</p>	<p>on EPAP GUI confirming that RTDB Conversion completed successfully.</p> <p><input type="checkbox"/></p>	<p>This step is performed only to support EAGLE release 46.7.0.0.0 (On the setup where DB Architecture is eXtreme):</p>  <p>The screenshot shows a window titled 'Informational Messages'. At the top, there is a large 'A' icon. Below it, the text 'RTDB Conversion in progress' is displayed in a grey box. A blue bar indicates the time 'Wed June 13 2018 16:55:42 EDT'. At the bottom, the copyright notice 'Copyright © 2000, 2018, Oracle and/or its affiliates. All rights reserved.' is visible.</p>

		<p><b>A</b> <span style="float: right;"><b>Informational Messages</b></span></p> <hr/> <div style="text-align: center; background-color: #f0f0f0; padding: 5px;"> <b>Informational Messages</b>  RTDB conversion completed successfully </div> <div style="background-color: #0056b3; color: white; padding: 2px;"> Fri June 15 2018 00:37:57 EDT </div> <div style="text-align: center; padding: 5px;"> Copyright © 2000, 2018, Oracle and/or its affiliates. All rights reserved. </div>
6	Procedure complete.	Return to the procedure that you came here from.

**Procedure A.37: Resolve the false accept upgrade alarm situation**

<b>S T E P #</b>	<p>This procedure is used to resolve the false accept upgrade alarm situation from the system.</p> <p>Check off (✓) each step as it is completed. Boxes have been provided for this purpose under each step number.</p> <p><b>IF THIS PROCEDURE FAILS, CONTACT MY ORACLE SUPPORT AND ASK FOR ASSISTANCE.</b></p>	
1. <input type="checkbox"/>	Blankout the /etc/motd file	> /etc/motd

2. <input type="checkbox"/>	Add an entry "export POST_UPGRADE_ACTION=ACCEPT" in the upgrade info file.	<pre>echo "export POST_UPGRADE_ACTION=ACCEPT" &gt;&gt; /var/TKLC/log/upgrade/upgrade.info</pre>
--------------------------------	--	---

<p>3.   ?</p>	<p>Clear the false alarm "TKSPLATMI33"</p>	<p>You will see the following alarm in alarmStatus.</p> <p>a. alarmMgr --alarmStatus [One output example below:] SEQ: 7 UPTIME: 356 BIRTH: 1524100682 TYPE: SET</p> <p>ALARM: TKSPLATMI33 tpdServerUpgradePendingAccept 1.3 .6.1.4.1.323.5.3.18.3.1.3.33 3253 2 Processing Error Configuration Error</p> <p>b. To clear the alarm, run the following command: alarmMgr --clear TKSPLATMI33</p>
-------------------	--	--

### Procedure A.38 Conversion from mixed EPAP to StandalonePDB+Non-Prov EPAP

**Note:** A new card would be needed for this conversion. The conversion can be done through various way where one of them is described below.

Assuming, there is a mixed EPAP on 16.3.1/16.4.1 release.

Execute the below mentioned steps to perform this conversion

On Mixed EPAP:

- a. Perform Full Upgrade from existing release EPAP 16.3.1 or 16.4.1 to target release of EPAP 17.1

Refer to [section 3.4.1](#) and perform procedures 1, 2, 3, 4, 14, A.31, 15, and 16.

- b. Convert Prov (mixed EPAP) to Non-Prov EPAP by fresh installing the setup as Non-Prov Node

**Note:** Option to convert Mixed setup to Non-Prov setup via epapconfig menu is obsolete.

Refer to [section 3.4.1](#), Execute procedure A.13, 5, 6, 7, 8, 9, 4, 20, 13, A.32, A.36, A.11, 25, 22.

On PDBOnly (fresh installation on new card):

- c. Install EPAP 17.1 ISO on new card.

Refer to [section 3.3.2](#) to perform installation.

- d. Restore PDB backup

Refer to [section 3.4.4](#), Execute procedures A.33, 27.

Attach this PDBOnly with Non-Prov EPAP (converted in step b) and any Non-Prov EPAP connected with Mixed setup

### Procedure A.39 Take snapshot of uiEdit parameters

<b>S T E P #</b>	<p>This procedure provides instructions to restore RTDB from a backup file.</p> <p>Check off (✓) each step as it is completed. Boxes have been provided for this purpose under each step number.</p> <p>IF THIS PROCEDURE FAILS, CONTACT MY ORACLE SUPPORT AND ASK FOR ASSISTANCE.</p>	
1. <input type="checkbox"/>	<p><b>EPAP A:</b> Log in to the EPAP A server as user "root" and take a snapshot of EuiDB variables.</p>	<pre>[root@Quito-a ~]# uiEdit "DB_ARCHITECTURE" is set to "COMPACT" "LNP_ENABLED" is set to "FALSE" "NETWORK_CONFIGURATION_TYPE" is set to "SINGLE" "EPAP_A_GS_BANNER_PORT" is set to "8473" "PDBA_STATS_ENABLED" is set to "OFF" "EPAP_DATA_SPLIT" is set to "OFF" "max_passwd_age" is set to "180" "new_user_default_groups" is set to "readonly" "max_concurrent_user_logins" is set to "1" "max_concurrent_logins" is set to "20" "PROVISIONABLE_MPS" is set to "YES" "PDBA_LOCAL_NAME_V6" is set to "0000:0000:0000:0000:0000:0000:0000" "passwd_expiry_warn_days" is set to "7" "HTTP_ENABLED" is set to "No" "SNMP_ALARM_FEED" is set to "ON" "session_idle_timeout" is set to "10" "EPAP_A_STANDBY" is set to "FALSE" "EPAP_BINLOGS_THRESHOLD" is set to "80" "SLOG_CAPACITY_ALARMS_ENABLED" is set to "TRUE" "EPAP_A_NAME" is set to "Quito-a" "MAX_RECORD_DELAY" is set to "15"</pre>

		<p>"PDBA_IMSI_PREFIX" is set to ""</p> <p>"EPAP_A_MAINT_DEBUG_LEVEL" is set to "0"</p> <p>"SELF_HEAL_DN_FEATURE" is set to "OFF"</p> <p>"logon_msg" is set to "NOTICE: This is a private computer system. Unauthorized access or use may lead to prosecution."</p> <p>"EPAP_QS_ALARMS_ENABLED" is set to "ON"</p> <p>"PDB_RTDB_SYNC" is set to "NO"</p> <p>"PROVISIONING_NETWORK_NETMASK" is set to "255.255.255.0"</p> <p>"EPAP_A_SLOG" is set to "YES"</p> <p>"PDBA_ERROR_LOG_DEBUG_LEVEL" is set to "20"</p> <p>"EPAP_A_SIMPLEX_MODE" is set to "FALSE"</p> <p>"EPAP_A_PROV_NETWORK_IP_ADDRESS" is set to "10.75.141.73"</p> <p>"EPAP_IP_VERSION" is set to "IPv4"</p> <p>"SYSTEM_NUMBER" is set to "ES06032023"</p> <p>"EPAP_STATUS_A" is set to "NONE"</p> <p>"euidb_version" is set to "3"</p> <p>"PDB_CAP_LIMIT_ENABLED" is set to "OFF"</p> <p>"EPAP_A_HTTP_PORT" is set to "80"</p> <p>"UI_IP_AUTHORIZATION_ENABLED" is set to "FALSE"</p> <p>"PDBA_MAX_COMMAND_RECORDS" is set to "1000000"</p> <p>"EPAP_A_SUEXEC_HTTP_PORT" is set to "8001"</p> <p>"apache_403_error_message" is set to "NOTICE: This workstation is not authorized to access the GUI."</p> <p>"min_passwd_len" is set to "8"</p> <p>"max_account_inactivity" is set to "0"</p> <p>"EAGLE_ALARM_FEED" is set to "OFF"</p> <p>"PDBA_GPORT_INSTALLED" is set to "FALSE"</p> <p>"EPAP_RELEASE" is set to "0.0.0"</p> <p>"PDBA_REMOTE_NAME" is set to "0.0.0.0"</p> <p>"PDBA_DEBUG_LOG_DEBUG_LEVEL" is set to "20"</p> <p>"EPAP_A_SUEXEC_HTTPS_PORT" is set to "8002"</p> <p>"EPAP_QS_THRESHOLD" is set to "200"</p> <p>"EPAP_A_HSAUDIT" is set to "ON"</p> <p>"EPAP_A_HTTPS_PORT" is set to "443"</p> <p>"PDBA_DN_PREFIX" is set to ""</p> <p>"EPAP_A_PROV_NETWORK_IP_ADDRESS_V6" is set to ""</p> <p>"PDBA_GFLEX_INSTALLED" is set to "FALSE"</p> <p>"PROVISIONING_NETWORK_PREFIX_V6" is set to ""</p> <p>"passwd_reuse_limit" is set to "5"</p> <p>"PDBI_PORT" is set to "5873"</p> <p>"apache_403_error_message_default" is set to "NOTICE: This workstation is not authorized to access the GUI."</p> <p>"PDBA_INP_INSTALLED" is set to "FALSE"</p> <p>"HTTPS_ENABLED" is set to "Yes"</p> <p>"PROVISIONING_NETWORK_DEFAULT_ROUTER" is set to "10.75.141.1"</p> <p>"RTDB_HOMING_POLICY" is set to "PDBA_LOCAL_NAME"</p>
--	--	--

		<p>"PDBA_MAX_COMMAND_DELAY" is set to "-1"</p> <p>"PDBA_LOCAL_NAME" is set to "10.75.141.73"</p> <p>"PDBA_COMMAND_LOG_DEBUG_LEVEL" is set to "20"</p> <p>"max_failed_logins" is set to "3"</p> <p>"PDB_SUB_CAPACITY" is set to "528000000"</p> <p>[root@Quito-a ~]#</p>
2.	<input type="checkbox"/> Copy the uiEdit command output in notepad and save on your machine or backup server for future reference	uiEdit command output is saved for fututr reference.
3.	<input type="checkbox"/> This procedure is complete.	This procedure is complete.

### Procedure A.40 Save the EPAP 16.3/16.4 additional configurations

<b>S T E P #</b>	This procedure provides instructions to restore RTDB from a backup file.	
	Check off (✓) each step as it is completed. Boxes have been provided for this purpose under each step number.	
	IF THIS PROCEDURE FAILS, CONTACT MY ORACLE SUPPORT AND ASK FOR ASSISTANCE.	
1.	<input type="checkbox"/> Log in to epapconfig menu and Enter choice 7, Configure NTP Server Menu	EPAP configuration menu for PDBonly server:

```

/-----EPAP Configuration Menu-----\
/-----\
| 1 | Display Configuration |
|-----|
| 2 | Configure Network Interfaces Menu |
|-----|
| 3 | Set Time Zone |
|-----|
| 4 | Exchange Secure Shell Keys |
|-----|
| 5 | Change Password |
|-----|
| 6 | Platform Menu |
|-----|
| 7 | Configure NTP Server |
|-----|
| 8 | PDB Configuration Menu |
|-----|
| 9 | Security |
|-----|
| 10 | SNMP Configuration |
|-----|
| 11 | Configure Alarm Feed |
|-----|
| 12 | Configure Query Server |
|-----|
| 13 | Configure Query Server Alarm Feed |
|-----|
| 14 | Configure SNMP Agent Community |
|-----|
| 15 | DB Architecture Menu |
|-----|
| e | Exit |
\-----/

```

Enter Choice:

EPAP configuration menu for Mixed EPAP:

		<pre> /-----EPAP Configuration Menu-----\ /-----\   1   Display Configuration    -----    2   Configure Network Interfaces Menu    -----    3   Set Time Zone    -----    4   Exchange Secure Shell Keys    -----    5   Change Password    -----    6   Platform Menu    -----    7   Configure NTP Server    -----    8   PDB Configuration Menu    -----    9   Security    -----    10   SNMP Configuration    -----    11   Configure Alarm Feed    -----    12   Configure SNMP Agent Community    -----    13   Mate Disaster Recovery    -----    14   DB Architecture Menu    -----    e   Exit   \-----/ </pre>
--	--	---

<p>2. <input type="checkbox"/></p>	<p>MPS A: The EPAP Configure NTP Server Menu is displayed. Enter choice 1, Display External NTP Server and save the details for later use.</p>	<pre> /-----EPAP Configure NTP Server Menu-----\ /-----\   1   Display External NTP Server    -----    2   Add External NTP Server    -----    3   Remove External NTP Server    -----    e   Exit   \-----/  Enter Choice: 1  ntpserver1      10.75.124.247  Press return to continue... </pre>
------------------------------------	--	--

3. Log in to EPAP GUI via uiadmin user MPS 1A: Navigate to the main Maintenance menu selection and select “Automatic PDB/RTDB Backup” and note down the configuration details.

Automatic PDB/RTDB Backup

---

Backup Type (Select None to Cancel Backups)

Time of the day to start the Backup

Frequency

File Path (Directory only)

Select required IP version:  IPv4  IPv6

Remote Machine IP Address (IPv4=xxx.yyy.zzz.zzz) (IPv6=xxxx:xxxx:xxxx:xxxx:xxxx:xxxx:xxxx:xxxx)

Login Name

Password

Save the local copies in the default path  Yes  No

Do you want to delete the old RTDB backups (Non-Provisionable only)  Yes  No

Note: 1. If you select Yes, only the last three RTDB backup files will be retained.  
2. Automatic PDB Backup will be failed.

4.  Navigate to the main Maintenance menu selection and select “Configure File Transfer” and note down the configuration details.

Configure File Transfer

---

Select required IP version:  IPv4  IPv6

Remote system IP address:

Remote system user name:

Remote system password:

Remote system sftp location:

File export to remote system:

Tue March 07 2023 04:12:29 EST

Copyright © 2000, 2019, Oracle and/or its affiliates. All rights reserved.

5. Navigate to the main Maintenance menu selection and select “EPAP Schedule task” and note down the configuration details.

Schedule

---

Existing Tasks					
Type	ID	Schedule	Action	Params	Co
EXAPCORE	PIC	minutely,5	/usr/TKLC/epap/bin/pdbimportCheck		
EXAPCORE	EFTP	minutely,5	/usr/TKLC/epap/bin/eirSftp.pl		
EXAPCORE	PBL	minutely,10	/usr/TKLC/appl/bin/pruneBinaryLogs		
EXAPCORE	PDSH	minutely,5	/usr/TKLC/appl/bin/pdbiSsh.pl		
EXAPCORE	MONBAN	hourly,1,15	/usr/TKLC/appl/bin/monitorBanner.pl		
EXAPCORE	RTDBCS	minutely,15	/usr/TKLC/appl/bin/getRTDBClientStatus.pl		

**Scheduling Options**

Type:  ID:

Action:

Params:

Repeat period:  Minutely  Hourly  Daily  Weekly  Monthly  Yearly

Every  day(s) at  :

Comment:

6.	Navigate to the user administration menu and select “HTTP(s) Support”, click view configuration and note down the configuration details.	<div style="text-align: right;">View HTTP(S) C</div> <hr/> <div style="border: 1px solid gray; padding: 5px;"> <p><b>A</b></p> <p>HTTP Enabled: No</p> <p>HTTPS Enabled: Yes</p> <p>Tue March 07 2023 04:15:58 EST</p> <p style="text-align: center; font-size: small;">Copyright © 2000, 2019, Oracle and/or its affiliates. All rights reserved.</p> </div>
7. <input type="checkbox"/>	This procedure is complete.	This procedure is complete.

### Procedure A.41 Reconfigure Additional EPAP configurations

<b>S T E P #</b>	<p>This procedure provides instructions to restore RTDB from a backup file.</p> <p>Check off (✓) each step as it is completed. Boxes have been provided for this purpose under each step number.</p> <p>IF THIS PROCEDURE FAILS, CONTACT MY ORACLE SUPPORT AND ASK FOR ASSISTANCE.</p>	
1. <input type="checkbox"/>	Log in to epapconfig menu and Enter choice 7, Configure NTP Server Menu	EPAP configuration menu for PDBonly server:

```

/-----EPAP Configuration Menu-----\
/-----\
| 1 | Display Configuration |
|-----|
| 2 | Configure Network Interfaces Menu |
|-----|
| 3 | Set Time Zone |
|-----|
| 4 | Exchange Secure Shell Keys |
|-----|
| 5 | Change Password |
|-----|
| 6 | Platform Menu |
|-----|
| 7 | Configure NTP Server |
|-----|
| 8 | PDB Configuration Menu |
|-----|
| 9 | Security |
|-----|
| 10 | SNMP Configuration |
|-----|
| 11 | Configure Alarm Feed |
|-----|
| 12 | Configure Query Server |
|-----|
| 13 | Configure Query Server Alarm Feed |
|-----|
| 14 | Configure SNMP Agent Community |
|-----|
| 15 | DB Architecture Menu |
|-----|
| e | Exit |
\-----/

Enter Choice: 

EPAP configuration menu for Mixed EPAP:

```

		<pre> /-----EPAP Configuration Menu-----\ /-----\   1   Display Configuration    -----    2   Configure Network Interfaces Menu    -----    3   Set Time Zone    -----    4   Exchange Secure Shell Keys    -----    5   Change Password    -----    6   Platform Menu    -----    7   Configure NTP Server    -----    8   PDB Configuration Menu    -----    9   Security    -----    10   SNMP Configuration    -----    11   Configure Alarm Feed    -----    12   Configure SNMP Agent Community    -----    13   Mate Disaster Recovery    -----    14   DB Architecture Menu    -----    e   Exit   \-----/ </pre>
<p>2. <input type="checkbox"/></p>	<p>MPS A: The EPAP Configure NTP Server Menu is displayed. Enter choice 2, Add External NTP Server.</p> <p>Refer to <a href="#">Procedure A.40</a> step 2 for NTP configuration before Migration</p>	<pre> /-----Add External NTP Server Menu-\ /-----\   1   IPv4 Configuration    -----    2   IPv6 Configuration    -----    e   Exit   \-----/  Enter Choice: 1  Are you sure you wish to add new NTP Server? [N]: Y NTP Server IP Address: 10.75.124.247 </pre>

<p>3.</p>	<p>Log in to EPAP GUI via uiadmin user MPS 1A: Navigate to the main Maintenance menu selection and select “Automatic PDB/RTDB Backup” and configure the Automatic PDB-RTDB backup</p> <p>Refer to <a href="#">Procedure A.40</a> step 3 for backup configuration before Migration</p>	<div style="text-align: right;">Automatic PDB/RTDB Backup</div> <hr/> <div style="border: 1px solid #ccc; padding: 5px;"> <p>Backup Type (Select None to Cancel Backups) <span style="float: right;">Local ▾</span></p> <p>Time of the day to start the Backup <span style="float: right;">04:00</span></p> <p>Frequency <span style="float: right;">1 Day ▾</span></p> <p>File Path (Directory only) <span style="float: right;">[Text Box]</span></p> <p>Select required IP version: <input checked="" type="radio"/> IPv4 <input type="radio"/> IPv6</p> <p>Remote Machine IP Address (IPv4=xxx.yyy.zzz.zzz) (IPv6=xxxx:xxxx:xxxx:xxxx:xxxx:xxxx) <span style="float: right;">[Text Box]</span></p> <p>Login Name <span style="float: right;">[Text Box]</span></p> <p>Password <span style="float: right;">[Text Box]</span></p> <p>Save the local copies in the default path <span style="float: right;"><input type="radio"/> Yes <input type="radio"/> No</span></p> <p>Do you want to delete the old RTDB backups (Non-Provisionable only) <span style="float: right;"><input checked="" type="radio"/> Yes <input type="radio"/> No</span></p> <p><small>Note: 1. If you select Yes, only the last three RTDB backup files will be retained. 2. Automatic PDB Backup will be failed, ...</small></p> </div>
<p>4.</p>	<p>Navigate to the main Maintenance menu selection and configure “Configure File Transfer”</p> <p>Refer to <a href="#">Procedure A.40</a> step 4 for CFT before Migration.</p>	<div style="text-align: right;">Configure File Transfer</div> <hr/> <div style="border: 1px solid #ccc; padding: 5px;"> <p>Select required IP version: <input checked="" type="radio"/> IPv4 <input type="radio"/> IPv6</p> <p>Remote system IP address: <span style="float: right;">10.75.141.80</span></p> <p>Remote system user name: <span style="float: right;">epapdev</span></p> <p>Remote system password: <span style="float: right;">[Text Box]</span></p> <p>Remote system sftp location: <span style="float: right;">/var/TKLC/epap/free</span></p> <p>File export to remote system: <span style="float: right;">Enabled ▾</span></p> <p style="text-align: center;"><input type="button" value="Submit data"/></p> <p style="background-color: #005596; color: white; padding: 2px;">Tue March 07 2023 04:12:29 EST</p> <p style="font-size: small; text-align: center;">Copyright © 2000, 2019, Oracle and/or its affiliates. All rights reserved.</p> </div>

5. Navigate to the main Maintenance menu selection and select “EPAP Schedule task” and note down the configuration details.

Refer to [Procedure A.40](#) step 5 for Shchedule EPAP task before Migration.

**A** Schedule EPAP Ta

---

Existing Tasks					
Type	ID	Schedule	Action	Params	Comment
EXAPCORE	PIC	minutely,5	/usr/TKLC/epap/bin/pdbilmpportCheck		
EXAPCORE	EFTP	minutely,5	/usr/TKLC/epap/bin/eirSftp.pl		
EXAPCORE	PBL	minutely,10	/usr/TKLC/app/bin/pruneBinaryLogs		
EXAPCORE	PDSH	minutely,5	/usr/TKLC/app/bin/pdbiSsh.pl		
EXAPCORE	MONBAN	hourly,1,15	/usr/TKLC/app/bin/monitorBanner.pl		
EXAPCORE	RTDBCS	minutely,15	/usr/TKLC/app/bin/getRTDBClientStatus.pl		

**Scheduling Options**

Type:  ID:

Action:

Params:

Repeat period:  Minutely  Hourly  Daily  Weekly  Monthly  Yearly

Every  day(s) at  :

Comment:

6. Refer to [Procedure A.40](#) step 6 for HTTP/HTTPS configuration, If http was enabled before the Migration thenPerform this step else skip this step.

Navigate to the user administration menu and select “HTTP(s) Support”, click Change configuration, disable, and enable the configuration.

**A** Change HTTP(S) Configuration

---

HTTP Enabled:

HTTPS Enabled:

Tue March 07 2023 05:57:50 EST

Copyright © 2000, 2019, Oracle and/or its affiliates. All rights reserved.

---

**A** Change HTTP(S) Configuration

---

SUCCESS: HTTP/HTTPS configuration changed successfully.

Tue March 07 2023 05:59:09 EST

Copyright © 2000, 2019, Oracle and/or its affiliates. All rights reserved.

---

**A** Change HTTP(S) Configuration

---

HTTP Enabled:

HTTPS Enabled:

Tue March 07 2023 06:00:51 EST

Copyright © 2000, 2019, Oracle and/or its affiliates. All rights reserved.

		A	Change HTTP(S) Configuration
		 SUCCESS: HTTP/HTTPS configuration changed successfully.	
		<small>Tue March 07 2023 05:59:09 EST</small> <small>Copyright © 2000, 2019, Oracle and/or its affiliates. All rights reserved.</small>	
7.	<input type="checkbox"/> This procedure is complete.	This procedure is complete.	

### Procedure A.42 Compare EuiDB parameters

S T E P #	This procedure provides instructions to restore RTDB from a backup file.	
	Check off (✓) each step as it is completed. Boxes have been provided for this purpose under each step number.	
	IF THIS PROCEDURE FAILS, CONTACT MY ORACLE SUPPORT AND ASK FOR ASSISTANCE.	
1.	<input type="checkbox"/> Compare the EuiDB parameters before and after Migration	Update the parameters missing after migration using the following command: <pre>[root@Quito-a ~]# uiEdit &lt;uiEdit Paramter&gt; &lt;Paramter Value&gt;</pre> WHERE, Paramter valus can be as follows or as per the value set before Migration: “ON/OFF” “YES/NO” “True/False” “IP”
2.	<input type="checkbox"/> This procedure is complete.	This procedure is complete.

### Procedure A.43 PDB Restore

#### Appendix A.43 PDB Restore

S T E P #	This procedure provides instructions to restore PDB from a backup file.	
	Check off (✓) each step as it is completed. Boxes have been provided for this purpose under each step number.	
	IF THIS PROCEDURE FAILS, CONTACT MY ORACLE SUPPORT AND ASK FOR ASSISTANCE.	
1.	<b>MPS X:</b> Log in to the CLI as user “admusr”.	If not already logged in, then log in as ‘admusr’: <pre>[hostname] consolelogin: admusr</pre> <pre>password: password</pre>
2.	<b>MPS X:</b> Switch to epapdev user.	\$ sudo su - epapdev

### Appendix A.43 PDB Restore

<p>3.</p>	<p><b>MPS X:</b> Backup file should be readable for epapdev user</p>	<p>Check mode and ownership of PDB backup tar file. It should be as follows:</p> <pre>[epapdev@DBExp-VM77 free]\$ ll pdbBackup_Natal- a_20180713022216_DBBirthdate_20180713055242GMT_DBLevel_18_v7.50.bkp.tar.gz -rw-rw-rw- 1 epapdev epap 1182165 Jul 16 03:32 pdbBackup_Natal- a_20180713022216_DBBirthdate_20180713055242GMT_DBLevel_18_v7.50.bkp.tar.gz</pre> <p>If permission and ownership of tar file is not same as above then use following command: Change mode of tar file: \$ chmod 666 &lt;PDB backup tar file&gt;</p>
<p>4.</p>	<p>Check following uiEdit variable:</p> <pre>[root@Salta-A ~]# uiEdit   grep PDBA_REMOTE_NAME "PDBA_REMOTE_NAME" is set to "10.75.141.75"</pre> <p>If Remote IP is assigned, then change it to 0.0.0.0 using the following command:</p> <pre>[root@Salta-A ~]# uiEdit PDBA_REMOTE_NAME 0.0.0.0 "PDBA_REMOTE_NAME" is set to "0.0.0.0"</pre> <p>Again check the uiEdit variable value:</p> <pre>[root@Salta-A ~]# uiEdit   grep PDBA_REMOTE_NAME</pre>	<pre>[root@Salta-A ~]# uiEdit   grep PDBA_REMOTE_NAME "PDBA_REMOTE_NAME" is set to "10.75.141.75"</pre> <pre>[root@Salta-A ~]# uiEdit PDBA_REMOTE_NAME 0.0.0.0 "PDBA_REMOTE_NAME" is set to "0.0.0.0"</pre> <pre>[root@Salta-A ~]# uiEdit   grep PDBA_REMOTE_NAME "PDBA_REMOTE_NAME" is set to "0.0.0.0"</pre>

**Appendix A.43 PDB Restore**

	<p>"PDBA_REMOTE_NAME" is set to "0.0.0.0"</p> <p>Note: This procedure is valid in case of restoring PDBA on second PDAB node being migrated</p>	
<p>5. <input type="checkbox"/></p>	<p><b>MPS X:</b> Log in to the web GUI as user "uiadmin".</p>	<p><b>User name:</b> <i>uiadmin</i>  <b>Password:</b></p>
<p>6. <input type="checkbox"/></p>	<p><b>MPS X:</b> Stop Software.</p> <p>On the menu, click Process Control-&gt;Stop Software.</p> <p>Click "Stop EPAP Software" Button</p>	<p><b>A</b> Stop EPAP Software</p> <p>CAUTION: This action will stop all EPAP software processes, and will prevent the selected EPAP from updating the RTDB until the EPAP software is restarted (by executing the Start Software menu item).</p> <p><input checked="" type="checkbox"/> Check if you want the software to automatically start on reboot.</p> <p>PDBA</p> <p><input type="checkbox"/> Check if you want to stop the PDBA software along with the EPAP software.</p> <p><input checked="" type="checkbox"/> Check if you want the PDBA software to automatically start on reboot.</p> <p>Are you sure you want to stop the EPAP software?</p> <p>Stop EPAP Software</p> <p>Tue January 06 2015 10:27:03 EST</p> <p>Copyright © 2000, 2014, Oracle and/or its affiliates. All rights reserved.</p> <p><b>A</b> Stop EPAP Software</p> <p>✓ SUCCESS: The EPAP Software has been stopped.</p> <p>Tue January 06 2015 10:29:53 EST</p> <p>Copyright © 2000, 2014, Oracle and/or its affiliates. All rights reserved.</p>

**Appendix A.43 PDB Restore**

7.  **MPS X:Restore PDB.**

On the menu, click PDBA->Maintenance->Backup->Restore the PDB

Select the backup file, then click “Restore PDB from the Selected File” Button

Click “Confirm PDB Restore” Button

EPAP A: uiadmin
A **Restore the PDB**

- Process Control
- Maintenance
- Debug
- Platform
- PDBA
  - Select Other PDBA
  - Switchover PDBA State
  - Process Control
    - View PDBA Status
  - Manage Data
  - Authorized IP List
  - DSM Info
  - Maintenance
    - Backup
      - List Backups
      - Backup the PDB
      - Restore the PDB
    - Import File to PDB
    - Export PDB to File
  - Transaction Log Params
  - Number Prefixes
  - Logs
    - Schedule Export
    - Configure PDBA Record
    - View License Capacity
  - List PDBI Connections
  - PDBI Statistics Report
- User Administration
  - Change Password
  - Logout

Please specify the sub directory (default is /var/TKLC/epap/free)

File Path

OK

Mon July 16 2018 03:26:01 EDT

Copyright © 2000, 2018, Oracle and/or its affiliates. All rights reserved.

---

A
**Restore the PDB**

**CAUTION:** Restoring the PDB will prevent the PDBA from receiving update and query requests until the restore is complete.

Select	Type	Originating Host	File Name	File Size	Creation Time
<input type="radio"/>	pdbBackup	Natal-a	<a href="#">pdbBackup_Natal-a...</a>	1.2M bytes	Fri July 13 2018 02:22:16 EDT

Restore PDB from the Selected File.

---

A
**Restore the PDB**

Are you sure that you want to restore the PDB from the file **pdbBackup\_Natal-a\_20180713022216\_DDBirthdate\_20180713055242GMT\_DBLLevel\_18\_v7.50.bkp.tar.gz ?**

Confirm PDB Restore

Restore successfully started:

---

A
**Restore the PDB**

**SUCCESS:** Successfully started restore of PDB from /var/TKLC/app/Free/pdbBackup\_Natal-a\_20180713022216\_DDBirthdate\_20180713055242GMT\_DBLLevel\_18\_v7.50.bkp.tar.gz. Restore status will be displayed on Banner message window.

**Appendix A.43 PDB Restore**

<p>8. <input type="checkbox"/></p>	<p>MPS X: An IM alarm should be observed with informational message on EPAP GUI confirming that restore PDB is in progress.</p> <p>An IM alarm should be observed with informational message on EPAP GUI confirming that restore PDB completed successfully.</p>	<p>Confirming that Restore PDB in progress:</p> <div style="text-align: center;"> <hr/> <hr/> <h3>Informational Messages</h3> <hr/> <hr/> <div style="background-color: #f0f0f0; padding: 5px; margin: 5px auto; width: 80%;"> <p style="text-align: center;"><b>Informational Messages</b></p> <p style="text-align: center;">Restore PDB in progress</p> </div> <div style="background-color: #005596; color: white; padding: 2px; margin: 5px auto; width: 80%;"> <p style="text-align: center;">Tue July 17 2018 02:31:52 EDT</p> </div> <p style="text-align: center; font-size: small;">Copyright © 2000, 2018, Oracle and/or its affiliates. All rights reserved.</p> </div> <p>Confirming that Restore PDB is completed successfully:</p> <div style="text-align: center;"> <hr/> <hr/> <h3>Informational Messages</h3> <hr/> <hr/> <div style="background-color: #f0f0f0; padding: 5px; margin: 5px auto; width: 80%;"> <p style="text-align: center;"><b>Informational Messages</b></p> <p style="text-align: center;">Restore PDB completed successfully</p> </div> <div style="background-color: #005596; color: white; padding: 2px; margin: 5px auto; width: 80%;"> <p style="text-align: center;">Tue July 17 2018 02:38:51 EDT</p> </div> <p style="text-align: center; font-size: small;">Copyright © 2000, 2018, Oracle and/or its affiliates. All rights reserved.</p> </div>
<p>9. <input type="checkbox"/></p>	<p>Procedure complete.</p>	<p>Return to the procedure that you came here from.</p>
<p>10.</p>	<p>Re-Assign the remote PDBA name using the following command:</p> <pre>[root@Salta-A ~]# uiEdit   grep PDBA_REMOTE_NAME</pre>	<pre>[root@Salta-A ~]# uiEdit PDBA_REMOTE_NAME 10.75.141.75 "PDBA_REMOTE_NAME" is set to "10.75.141.75"  [root@Salta-A ~]# uiEdit   grep PDBA_REMOTE_NAME "PDBA_REMOTE_NAME" is set to "10.75.141.75"  [root@Salta-A ~]#</pre>

## Appendix A.43 PDB Restore

	<p>"PDBA_REMOTE_NAME" is set to "10.75.141.75"</p> <p>Again grep the uiEdit variable name using the following command:</p> <pre>[root@Salta-A ~]# uiEdit   grep PDBA_REMOTE_NAME</pre>	
11.	<p>Move the pdba binary file on Mixed and PDBonly server.</p> <p><b>Note: This step is valid in case only when user is performing migration.</b></p>	<pre>[root@Quito-a bin]# mv pdba pdba_stopped [root@Quito-a bin]#</pre>
12.	<p>MPS X: Verify that PDB_RTDB_SYNC is set to "YES".</p>	<p>Run the below command to verify that PDB_RTDB_SYNC is set to YES.</p> <pre>\$ uiEdit   grep -i PDB_RTDB_SYNC "PDB_RTDB_SYNC" is set to "YES"</pre> <p>If "PDB_RTDB_SYNC" is set to "NO" in the above output, set the uiEdit variable to "YES" using the below command.</p> <pre>\$ uiEdit "PDB_RTDB_SYNC" "YES" "PDB_RTDB_SYNC" is set to "YES"</pre>
13.	<p><input type="checkbox"/> Note down the timestamp in log.</p>	<p>Run the following command:</p> <pre>\$ date</pre>

## Procedure A.44 RTDB Homing Policy to self PDBA

S T	This procedure will reset the RDTB homing policy for the Non-Prov Nodes
--------	---

E P #	<p><b>Estimated time of completion: 5 minutes.</b></p> <p>Check off (☐) each step as it is completed. Boxes have been provided for this purpose under each step number.</p> <p>SHOULD THIS PROCEDURE FAIL, CONTACT TEKELEC TECHNICAL SERVICES AND <b>ASK FOR <u>MIGRATION ASSISTANCE</u></b>.</p> <p><b>PROCEDURE APPLICABLE TO: Non-Provisionable EPAPs</b></p>	
1.	<p><u>MPS</u> A: Login prompt is displayed</p>	<p>&lt;hostname&gt; console login:</p> <p>Note : Press enter if no login prompt is displayed.</p>
2.	<p><u>MPS A: Log</u> <u>in</u> <u>as "root"</u> <u>user.</u></p>	<p>[hostname] console login: root password: password</p>
3 <input type="checkbox"/>	<p><b>MPS A:</b> Switch to epapconfig menu</p>	<p><b># su - epapconfig</b></p> <p>Warning: Smartmatch is experimental at /usr/TKLC/plat/lib/Security/User.pm line 904.</p>

<p>4</p> <p><input type="checkbox"/></p>	<p>Select option 8 from epapconfig menu</p>	<pre> /-----EPAP Configuration Menu-----\ /-----\   1   Display Configuration    -----    2   Configure Network Interfaces Menu    -----    3   Set Time Zone    -----    4   Exchange Secure Shell Keys    -----    5   Change Password    -----    6   Platform Menu    -----    7   Configure NTP Server    -----    8   PDB Configuration Menu    -----    9   Security    -----    10   SNMP Configuration    -----    11   Configure Alarm Feed    -----    12   Configure SNMP Agent Community    -----    13   Mate Disaster Recovery    -----    14   DB Architecture Menu    -----    e   Exit   \-----/ </pre> <p>Enter Choice: 8</p>
<p>5</p> <p><input type="checkbox"/></p>	<p>Select option 2 to enter RTDB homing menu</p>	<pre> /-----Configure PDB Menu-----\ /-----\   1   Configure PDB Network    -----    2   RTDB Homing Menu    -----    3   Change Auto DB Recovery State    -----    e   Exit   \-----/ </pre> <p>Enter Choice: 2</p>
<p>6</p> <p><input type="checkbox"/></p>	<p>Read the Note in the beginning of the</p>	<p>For Mixed EPAP :</p> <pre> /-----RTDB Homing Menu-----\ /-----\ </pre>

	<p>section and decide your homing policy.</p>	<pre>   1   Configure Specific RTDB Homing    -----    2   Configure Active RTDB Homing    -----    3   Configure Standby RTDB Homing    -----    e   Exit    -----  Enter Choice: 1 EPAP software and PDBA are running. Stop them? [N]: Y EPAP software is running on mate MPS. Stop it? [N]: Y There are two configured PDBs for this MPS: 1. 10.75.141.101 (local) 2. 10.75.141.32  Select the preferred PDB from which to receive updates [1]: 1  The RTDB Homing policy is set to 'specific' and will prefer updates from 10.75.141.101  Press return to continue... </pre>
<p>7</p> <input type="checkbox"/>	<p>MPS A and MPS B: Start Epap software.</p>	<p>Start Epap and Pdba software to reflect the changes. Use the following command to start Epap:</p> <p>For EPAP 16.3.1/16.4.1, Run the following command to start PDBA and EPAP Softwares:</p> <pre> \$ service Epap start ~~ /etc/init.d/Epap start ~~ "EPAP_RELEASE" is set to "0.617" EPAP application start Successful.  \$ service Pdba start ~~ /etc/init.d/Pdba start ~~ PDBA application start Successful.  For EPAP 17.1, run the following command to start PDBA and EPAP Softwares:  \$ systemctl start Epap  \$ systemctl start Pdba </pre>
<p>8</p> <input type="checkbox"/>	<p>Procedure complete</p>	<p><b>This procedure is complete.</b></p>

## Procedure A.45 Backout of MPS A and MPS B in Mixed and Non-Prov

S T E P #	This procedure will backout the MPS A and MPS B in Mixed and Non-Prov Site	
	<p><b>Estimated time of completion: 900 minutes.</b></p> <p>Check off (☐) each step as it is completed. Boxes have been provided for this purpose under each step number.</p> <p>SHOULD THIS PROCEDURE FAIL, CONTACT TEKELEC TECHNICAL SERVICES AND <b>ASK FOR <u>MIGRATION ASSISTANCE</u></b>.</p> <p><b>PROCEDURE APPLICABLE TO: Non-Provisionable EPAPs</b></p>	
1 <input type="checkbox"/>	Re-Install the Mixed or Non-Port Node on EPAP 16.3.1/16.4.1	Refer to EPAP 16.3.1/16.4.1 Install/Upgrade document
2 <input type="checkbox"/>	Restore the EuiDB, RTDB on Non-Prov EPAPs from the backup taken before performing migration on Non-Prov Nodes	Refer to <a href="#">Section 3.4.2</a> , step 6
3 <input type="checkbox"/>	Restore the EuiDB and PDB on Mixed EPAPs	<p>For EPAP 16.3.1/16.4.1 Backup files:</p> <p>Refer to <a href="#">section 3.4.1</a>, step 6 in case of Single Mixed or <a href="#">section 3.4.3</a>, step 6 in case of Dual Mixed</p> <p>To Restore EPAP 16.3.1/16.4.1 Backup files:</p> <p>Refer to <a href="#">Procedure A.32</a> for EuiDB Restore and <a href="#">Procedure A. 10</a> for RTDB Restore.</p>
4 <input type="checkbox"/>	<b>This procedure is complete.</b>	<b>This procedure is complete.</b>

## Procedure A.46 Backout of PDBonly site

S T E P #	This procedure will backout the PDBonly site	
	<b>Estimated time of completion: 5 minutes.</b>	
	Check off (☐) each step as it is completed. Boxes have been provided for this purpose under each step number.	
	SHOULD THIS PROCEDURE FAIL, CONTACT TEKELEC TECHNICAL SERVICES AND <b>ASK FOR <u>MIGRATION ASSISTANCE</u></b> .	
<b>PROCEDURE APPLICABLE TO: Non-Provisionable EPAPs</b>		
1 <input type="checkbox"/>	Re-Install the PDBonly site on 16.3.1/16.4.1	Refer to EPAP 16.3.1/16.4.1 Install/Upgrade document
2 <input type="checkbox"/>	Restore the EuiDB, PDB on PDBonly site from the backup taken before performing migration on Non-Prov Nodes	Refer to <a href="#">Section 3.4.4</a> step 6 in case of standalone PDB site or <a href="#">section 3.4.5</a> step 6 in case of dual PDBonly sites.
3 <input type="checkbox"/>	Restore the EuiDB and PDB on PDBonly site	For EPAP 16.3.1/16.4.1 Backup files : Refer to <a href="#">Section 3.4.4</a> step 6 in case of Single Mixed or <a href="#">section 3.4.3</a> step 6 in case of Dual Mixed To Restore EPAP 16.3.1/16.4.1 Backup files : Refer <a href="#">Procedure A.32</a> for EuiDB Restore and <a href="#">Procedure A.43</a> for PDB Restore.
4 <input type="checkbox"/>	<b>This procedure is complete.</b>	<b>This procedure is complete.</b>

## Procedure A.47 Dual Image Upgrade Procedure

**Note:** Ensure that the Legacy Upgrade before DIU is accepted, otherwise it might give an error while initiating background upgrade in DIU.

S. No	Steps	<p>This procedure performs Dual Image Upgrade on the server.  <b>Check off (✓) each step as it is completed. Boxes have been provided for this purpose beside each step number.</b>  <b>If this procedure fails, contact My Oracle Support and ask for ASSISTANCE.</b></p>
1	MPS X: Login prompt is displayed.	<p>&lt;hostname&gt; console login:</p> <p><b>Note:</b> Press enter if no login prompt is displayed.</p>
2	MPS X: Log in as "root" user.	<p>[hostname] consolelogin: root password: password</p>
3	<b>MPS X:</b> Copy DIU ISO	<p>Perform the procedure in <a href="#">Procedure A.12</a> or copy EPAP DIU ISO to /var/TKLC/upgrade directory.</p> <p>Make sure that only the DIU iso and patch is present in the directory.</p>
4	Create a terminal window log in MPS X.	<p>If not already connected, connect to the E5-APP-B card via the serial port.</p> <p>For connecting the E5-APP-B B card, disconnect the console cable from the serial port on the E5-APP-B A card's adapter. The cable should be disconnected at the point where it connects to the serial port labeled 'S1' on the E5-APP-B A card's adapter and use it for serial access. <b>Cable part numbers - 830-1220-xx</b></p>
5	<b>MPS X:</b> Unallocate some memory for the backout LVs.	<p><b>Note: NTP must be configured before starting DIU.</b>  <b>NOTE: All custom files, scripts, folders need to be migrated to remote server before the DIU process is started. These need to be restored back to their place after the DIU process is completed.</b></p> <p>&lt;hostname&gt; console login: root password:</p> <p>Run allowRoot ON both the pairs before running script on mated pairs</p> <p>[root@MPS-A upgrade]# allowRoot ON</p> <p>/etc/securetty file successfully updated.</p> <p>/etc/ssh/sshd_config file successfully updated.</p>

Service sshd has been restarted but existing root ssh sessions will not be terminated.

/etc/pam.d/su file successfully updated.

Change permission and group of the script

```
[root@MPS-A tmp]# chmod +x diuPreUpgrade.sh
[root@MPS-A tmp]# chown root:root diuPreUpgrade.sh
```

Run the pre-upgrade script

```
[root@MPS-A tmp]# ./diuPreUpgrade.sh
[INFO] Setting SPLIT_MIRROR=1 in /usr/TKLC/plat/etc/upgrade/upgrade.conf
[INFO] + printf '%s\n' 'SPLIT_MIRROR=1' > '/usr/TKLC/plat/etc/upgrade/upgrade.conf'
[INFO] + cat '/usr/TKLC/plat/etc/upgrade/upgrade.conf'
SPLIT_MIRROR=1
[INFO] Comcol folder /var/TKLC/epap/free/comcol does not exist or is empty.
[INFO] Parsed: function_output='PDBonly' df_output="" for /vgroot-db
[INFO] PDBonly detected in /etc/profile.d/TKLCplat_conf.sh; skipping conditional DB stop
block.
Created symlink /etc/systemd/system/Pdba.service -> /dev/null.
Created symlink /etc/systemd/system/mysqld@pdb.service -> /dev/null.
[INFO] Moving comcol to /var/TKLC/epap/logs
[INFO] + mv '/var/TKLC/epap/free/comcol' '/var/TKLC/epap/logs/'
Proceeding, VG free is only 0G...
[INFO] Unmounting /var/TKLC/epap/free if mounted
[INFO] + umount '/var/TKLC/epap/free' 2>/dev/null || true
[INFO] Removing existing LV vgroot/free if present
[INFO] + lvremove -y '/dev/mapper/vgroot-free' 2>/dev/null || lvremove -y
'/dev/vgroot/free' 2>/dev/null || true
Logical volume "free" successfully removed.
[INFO] Querying VG free space for vgroot
[INFO] VG free before create: 205.63G (int=205G)
[INFO] Allocating LV size xvalue=175G (leaving ~30G VG free)
[INFO] + lvcreate --yes -L '175G' --name 'free' 'vgroot'
Wiping ext4 signature on /dev/vgroot/free.
Logical volume "free" created.
[INFO] + mkfs.ext4 -F '/dev/mapper/vgroot-free'
mke2fs 1.46.2 (28-Feb-2021)
Discarding device blocks: done
Creating filesystem with 45875200 4k blocks and 11468800 inodes
Filesystem UUID: f672176c-bc7d-45de-b196-443e11979691
Superblock backups stored on blocks:
32768, 98304, 163840, 229376, 294912, 819200, 884736, 1605632, 2654208,
```

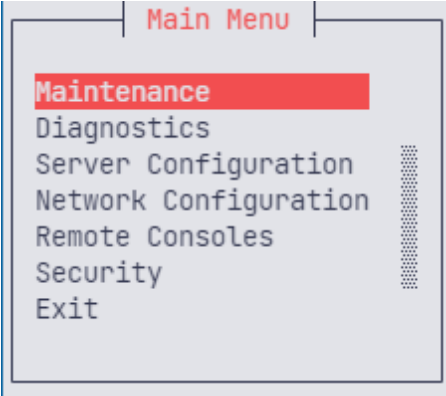
		<p>4096000, 7962624, 11239424, 20480000, 23887872</p> <p>Allocating group tables: done  Writing inode tables: done  Creating journal (262144 blocks): done  Writing superblocks and filesystem accounting information: done</p> <p>[INFO] + mount '/dev/mapper/vgroot-free' '/var/TKLC/epap/free'  [INFO] + chown epapdev:epap '/var/TKLC/epap/free'  [INFO] Restoring comcol back to /var/TKLC/epap/free  [INFO] + mv '/var/TKLC/epap/logs/comcol' '/var/TKLC/epap/free/'  [INFO] VG free after create: 30.63G (int=30G). Expected ~30G remaining.  [INFO] Completed successfully.  [root@Salta-B tmp]#</p> <p>Run vgs to make sure Free space is 30G</p> <p>[root@MPS-A tmp]# vgs  VG #PV #LV #SN Attr VSize VFree  vgroot 1 9 0 wz--n- &lt;442.41g 30.63g</p>
6	<b>MPS X:</b> Start platcfg utility.	<b>\$ su – platcfg</b>
7	<p><b>MPS X:</b>  Navigate to the Upgrade menu.</p> <p><b>**NOTE**:</b>  <b>Make sure to select Dual Image Upgrade only.</b></p>	<p>The platcfg <b>Main Menu</b> appears.</p> <ol style="list-style-type: none"> <li>1. On the <b>Main Menu</b>, select <b>Maintenance</b> and press <b>[ENTER]</b>.</li> </ol>  <p>Select the <b>Dual Image Upgrade</b> menu and press <b>[ENTER]</b>.</p>

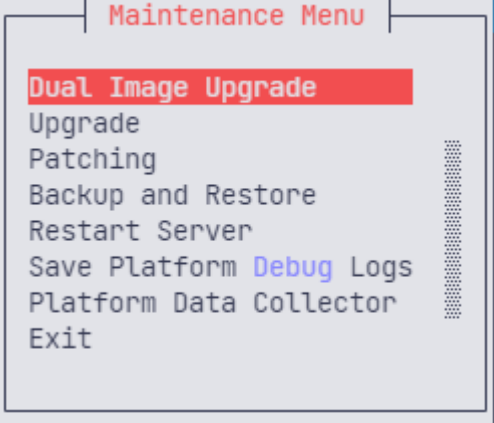
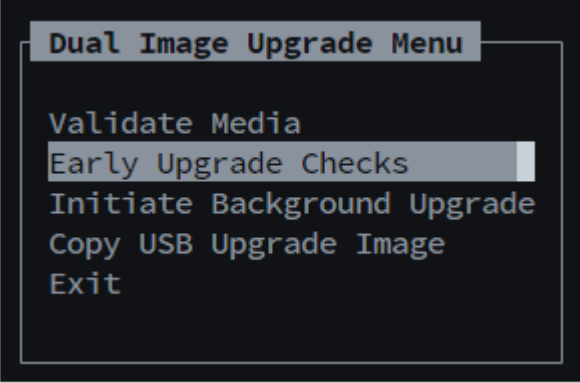
		
8.	<b>MPS X:</b> Validate ISO file.	Validate ISO file using <b>0</b> .
9.	<b>MPS X:</b> Select Early Upgrade Checks	<p>Select the “Early Upgrade Checks” menu to verify that the system is ready for upgrade.</p>  <p>If the Early Upgrade Checks fail due to the NTP related alarms, then ignore the NTP alarms using the following commands:</p> <ul style="list-style-type: none"> <li>• Exit the platcfg menu.</li> <li>• Change to root user using the “su –” command.</li> <li>• vim /usr/TKLC/plat/etc/upgrade/upgrade.conf</li> <li>• Edit the following line to include the NTP related alarms. <ul style="list-style-type: none"> <li>○ EARLY_CHECK_ALARM_WHITELIST=TKSPLATMI2</li> <li>○ Add the following alarm code to ignore Storage Capacity Problem: TKSPLATMA5</li> <li>○ Add the following line for the RAID related alarms:</li> </ul> </li> <li>○ EARLY_CHECK_ALARM_WHITELIST=TKSPLATMA2</li> </ul>

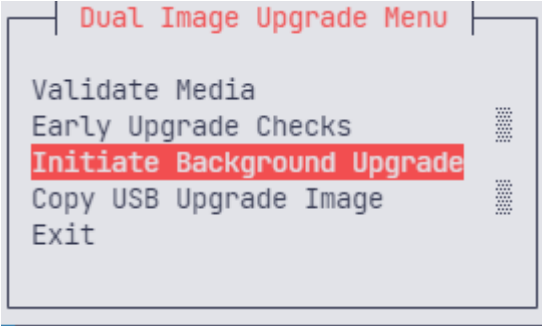
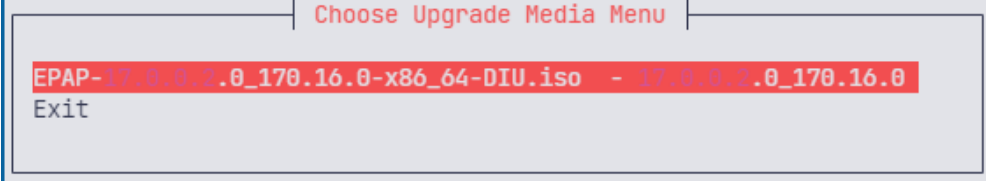
		<p>For example – To allowlist the NTP alarm “tpdNTPDaemonNotSynchronizedWarning” which has the alarm code TKLCPLATMI10, the above mentioned line should be edited as EARLY_CHECK_ALARM_WHITELIST=TKSPLATMI2,TKSPLATMI10</p> <p><b>Note:</b> There should not be any space between two alarms i.e. between TKSPLATMI2 and TKSPLATMI10</p> <p>If the Early Upgrade Checks fail due to “Server Default Route Network Error”, then this alarm shall be allowlisted in upgrade.conf file. To allowlist this alarm which has the alarm code TKSPLATMA14, the above mentioned line should be edited as</p> <p>EARLY_CHECK_ALARM_WHITELIST=TKSPLATMA2,TKSPLATMI2,TKSPLATMA5,TKSPLATMI10 , TKSPLATMA14,TKSPLATMA28</p> <p><b>Note: Please note that TKSPLATMA5, TKSPLATMA2, TKSPLATMI2 should always be whitelisted.</b></p>
10	<p><b>MPS X:</b> Navigate to the Initiate Upgrade menu</p>	<p>Select the <b>Initiate Background Upgrade</b> menu and press <b>[ENTER]</b>.</p> 
11	<p><b>MPS X:</b> Select the Upgrade Media.</p>	<p>The screen displays a message that it is searching for upgrade media. When the upgrade media is found, an <b>Upgrade Media selection menu</b> appears similar as shown in the example below.</p> <p>Select the desired upgrade media and press <b>[ENTER]</b>.</p>  <p>In case there is a failure in the installation process, then run the following command to verify whether the raid is synced or not:</p> <ul style="list-style-type: none"> <li>• lsblk</li> </ul>

	<pre> Raid in sync example  [root@Recife-A upgrade]# lsblk NAME                MAJ:MIN RM  SIZE RO TYPE MOUNTPOINT sda                  8:0  0 447.1G 0 disk  -sda1               8:1  0 512M 0 part `-sda2               8:2  0 446.5G 0 part  `--md1              9:1  0 446.4G 0 raid1      -vgroot-plat_root 253:0 0 4G 0 lvm /      -vgroot-plat_swap 253:1 0 2G 0 lvm     [SWAP]      -vgroot-plat_usr  253:2 0 10G 0 lvm     /usr      -vgroot-plat_var_tklc 253:3 0 8G 0 lvm     /var/TKLC      -vgroot-plat_tmp   253:4 0 1G 0 lvm     /tmp      -vgroot-plat_var   253:5 0 2G 0 lvm     /var      -vgroot-logs      253:6 0 20G 0 lvm     /var/TKLC/epap/logs      -vgroot-db        253:7 0 191.8G 0 lvm     /var/TKLC/epap/db     `--vgroot-free     253:8 0 207.7G 0 lvm     /var/TKLC/epap/free sdb                  8:16 1 28.9G 0 disk  -sdb1               8:17 1 2.8G 0 part `-sdb2               8:18 1 9.8M 0 part sdc                  8:32 0 447.1G 0 disk  -sdc1               8:33 0 512M 0 part `-sdc2               8:34 0 446.5G 0 part  `--md1              9:1  0 446.4G 0 raid1      -vgroot-plat_root 253:0 0 4G 0 lvm /      -vgroot-plat_swap 253:1 0 2G 0 lvm     [SWAP]      -vgroot-plat_usr  253:2 0 10G 0 lvm     /usr      -vgroot-plat_var_tklc 253:3 0 8G 0 lvm     /var/TKLC      -vgroot-plat_tmp   253:4 0 1G 0 lvm     /tmp      -vgroot-plat_var   253:5 0 2G 0 lvm     /var </pre>	<pre> Raid not in sync example  [root@Natal-A upgrade]# lsblk NAME                MAJ:MIN RM  SIZE RO TYPE MOUNTPOINT sda                  8:0  1 28.9G 0 disk `-sda1               8:1  1 28.9G 0 part sdb                  8:16 0 894.3G 0 disk  -sdb1               8:17 0 512M 0 part `-sdb2               8:18 0 893.7G 0 part  `--md1              9:1  0 893.5G 0 raid1      -vgroot-plat_root 253:0 0 2G 0 lvm /      -vgroot-plat_swap 253:1 0 2G 0 lvm     [SWAP]      -vgroot-plat_usr  253:2 0 8G 0 lvm /usr      -vgroot-plat_var_tklc 253:3 0 8G 0 lvm     /var/TKLC      -vgroot-plat_tmp   253:4 0 1G 0 lvm     /tmp      -vgroot-plat_var   253:5 0 2G 0 lvm /var      -vgroot-rt        253:6 0 68G 0 lvm     /var/TKLC/epap/rt      -vgroot-logs      253:7 0 20G 0 lvm     /var/TKLC/epap/logs      -vgroot-db        253:8 0 289.2G 0 lvm     /var/TKLC/epap/db     `--vgroot-free     253:9 0 204G 0 lvm     /var/TKLC/epap/free sdc                  8:32 0 894.3G 0 disk  -sdc1               8:33 0 512M 0 part `-sdc2               8:34 0 893.7G 0 part </pre>
--	---	---

		<pre> -vgroot-logs      253:6  0  20G  0 lvm /var/TKLC/epap/logs  -vgroot-db        253:7  0 191.8G  0 lvm /var/TKLC/epap/db `-vgroot-free      253:8  0 207.7G  0 lvm /var/TKLC/epap/free</pre> <p>Key Points: Under a healthy, in-sync RAID, both member partitions will appear under the same md device. If the RAID is not in sync or missing a member, only one partition will appear under the md device.</p> <p>If the raid is not in sync, then run the following command:</p> <ul style="list-style-type: none"> <li>• <code>mdadm --add /dev/md1 /dev/sdX2</code> where sdX can be any of sda, sdb, or sdc according to LV configurations. This can be verified using <code>lsblk</code>. In the above example, sdc is being used as it is a harddisk partition whereas sda is a USB drive.</li> </ul> <p>The following command can be used to check the status of the sync after running the above command.</p> <pre>[root@Arica-A upgrade]# cat /proc/mdstat Personalities : [raid1] md1 : active raid1 sdb[3] sda2[2]       468091904 blocks super 1.2 [2/1] [U_]       [===&gt;.....] recovery = 19.1% (89824128/468091904) finish=81.5min speed=77331K/sec       bitmap: 4/4 pages [16KB], 65536KB chunk unused devices: &lt;none&gt;</pre> <p>Wait till the time recovery is not completed 100%</p>
12	<p><b>MPS X:</b> Upgrade proceeds. Apply Upgrade.</p>	<p>Many informational messages appear on the terminal screen as the upgrade proceeds. After the background upgrade is done, the system will return to this screen.</p>

```
Copyright (C) 2003, 2023, Oracle and/or its affiliates. All rights reserved.  
Hostname: Floater01
```

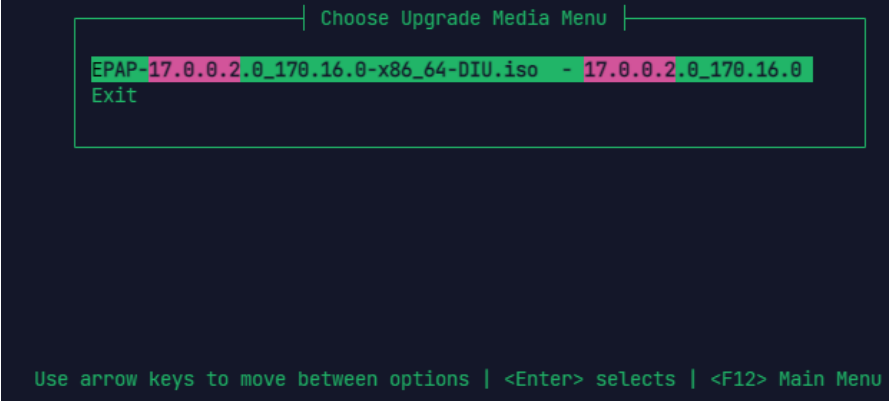

After this, select [EXIT] and press [ENTER].  
From the Dual image Upgrade Menu, select [EXIT] and press [ENTER].

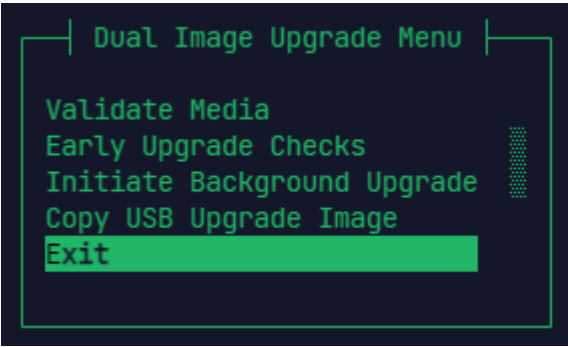

From the maintenance menu, select **Dual Image Upgrade** and then Press **Enter**.

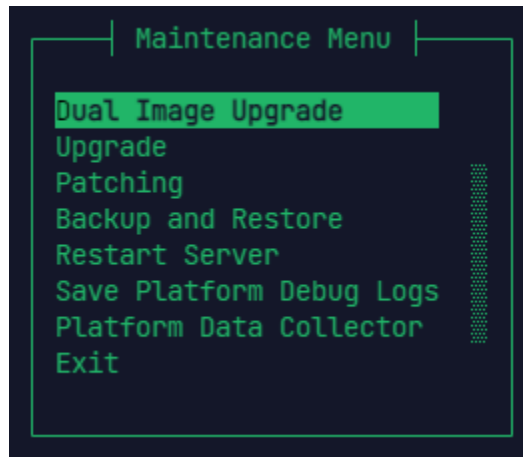

From the Dual Image Upgrade Menu, select **Apply Upgrade** and press [ENTER].

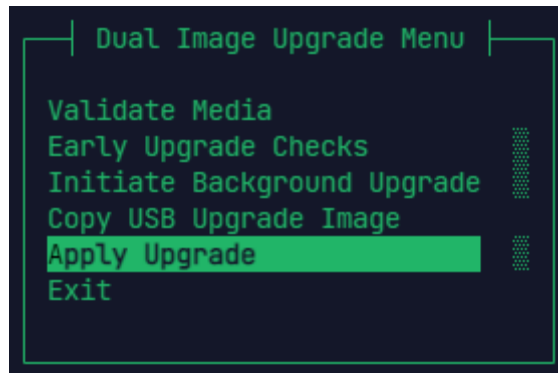

Select **YES** and press **ENTER**.

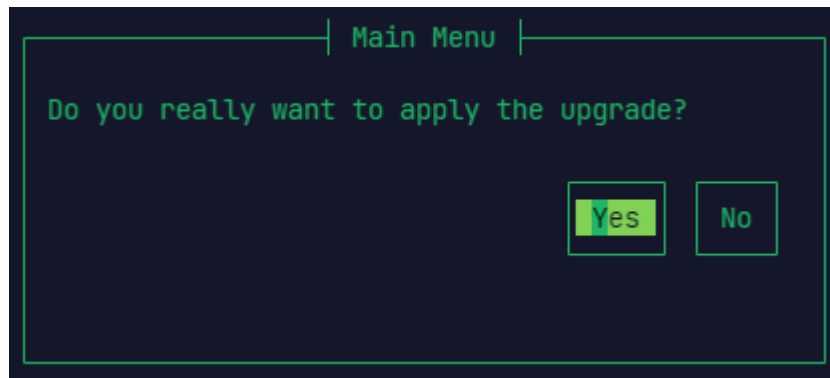

When the upgrade process is complete, the server reboots.

13	<b>MPS X:</b> Upgrade completed.	After the final reboot, the screen displays the login prompt as displayed in the example below.
----	-------------------------------------	---

		<pre> [ 543.047224] diUpgrade[11034]: Creating alarm script: /tmp/OUTopYcjjI [ 550.076488] diUpgrade[11034]: Image Apply Complete [ 550.076687] diUpgrade[11034]: ##### [ 550.076769] diUpgrade[11034]: #          APPLY COMPLETE          # [ 550.076846] diUpgrade[11034]: ##### [ 550.076923] diUpgrade[11034]: Transitioning from 'Applying Upgrade' to 'Upgrade [ 550.219075] systemctl[21188]: Removed /etc/systemd/system/TPD.target.wants/upgrad [ 569.958098] completeTasks[21254]: completeTasks started: Fri Oct 27 07:52:31 20 [ 570.018205] completeTasks[21254]:      ID: 1697182349.0 [ 570.018407] completeTasks[21254]: STATE: COMPLETED [ 570.018490] completeTasks[21254]: RESULT: SUCCESS [ 570.018566] completeTasks[21254]: CHECKPOINTS [ 570.018643] completeTasks[21254]: ----- [ 570.018725] completeTasks[21254]: main STATE: COMPLETED RESULT: SUCCESS [ 570.018801] completeTasks[21254]: STARTED: 1697182349 ENDED: 1697182350 [ 570.018881] completeTasks[21254]: STATUS LOG [ 570.018957] completeTasks[21254]: ----- [ 570.019039] completeTasks[21254]: 0 1697182349 INFO main Checkpoint started at 16 [ 570.019126] completeTasks[21254]: 1 1697182349 INFO main Checkpoint started at 16 [ 570.019206] completeTasks[21254]: 2 1697182350 INFO main Checkpoint finished at 16 [ 570.019283] completeTasks[21254]: LOG FILE: /var/TKLC/log/TaskMgr/completeTasks.7  Oracle Linux Server 8.8 Kernel 4.18.0-477.21.1.el8_8.x86_64 on an x86_64  Floater01 login: █ </pre> <p>Make sure to verify that the state is transitioned from “Applying upgrade” to “Upgrade Applied” and we get Completed Result: SUCCESS.</p>
14	<b>MPS X:</b> Log in as “root” user.	<pre> [hostname] consolelogin: root password: password </pre>
15	<b>MPS X:</b> Check the Upgrade log.	<p>Examine the upgrade logs in the directory /var/TKLC/log/upgrade and verify that no errors and warnings were reported.</p> <pre> \$ grep -i error /var/TKLC/log/upgrade/upgrade.log </pre> <p>Check the output of the upgrade log. Contact My Oracle Support following the instructions on the front page or the instructions on the Appendix E, if the output contains any error except the following:</p> <pre> [root@Salta-B core]# grep -i error /var/TKLC/log/upgrade/upgrade.log 1673985608::ERROR: run-r1841b65093e14801be5696ea62d92ac2 is not recognized as a systemd419system service! 1673985608::ERROR: Could not stop run-r1841b65093e14801be5696ea62d92ac2! 1673985608::ERROR: service_conf reconfig failed! </pre>

		<pre> 1726140936::ERROR: SEQ: 83 UPTIME: 12737 BIRTH: 1726139350 TYPE: SET ALARM: TKSPLATMI2 tpdApplicationProcessError 1.3.6.1.4.1.323.5.3.18.3.1.3.2 32501 Processing Error Software Program Error HOST-RESOURCES- MIB::hrSWRunName:1.3.6.1.2.1.25.4.2.1.2:OCTET_STRING:eaglelog  \$ grep -i warning /var/TKLC/log/upgrade/upgrade.log  Examine the output of the above command to determine if any warnings were reported. Contact My Oracle Support following the instructions on the front page or the instructions on the Appendix E, if the output contains any warnings beside the following:  [root@Salta-B core]# grep -i error /var/TKLC/log/upgrade/upgrade.log 1673985608::ERROR: run-r1841b65093e14801be5696ea62d92ac2 is not recognized as a systemd420system service! 1673985608::ERROR: Could not stop run-r1841b65093e14801be5696ea62d92ac2! 1673985608::ERROR: service_conf reconfig failed! [root@Salta-B core]# grep -i warning /var/TKLC/log/upgrade/upgrade.log 1673985030::* write: WARNING:: Could not find configured path "/var/TKLC/epap/db". 1673985031::* write: WARNING:: Could not find configured path "/var/TKLC/epap/logs". 1673985031::* write: WARNING:: Could not find configured path "/var/TKLC/epap/free". 1673985031::* write: WARNING:: Could not find configured path "/var/TKLC/epap/db". 1673985031::* write: WARNING:: Could not find configured path "/var/TKLC/epap/logs". 1673985031::* write: WARNING:: Could not find configured path "/var/TKLC/epap/free". 1673985033::useradd: warning: the home directory already exists. 1673985476::2023-01-17T19:57:57.683121Z 0 [Warning] [MY-013746] [Server] A deprecated TLS version TLSv1 is enabled for channel mysql_main 1673985478::2023-01-17T19:57:57.683144Z 0 [Warning] [MY-013746] [Server] A deprecated TLS version TLSv1.1 is enabled for channel mysql_main 1673985478::2023-01-17T19:57:57.808924Z 6 [Warning] [MY-010453] [Server] root@localhost is created with an empty password ! Please consider switching off the --- initialize-insecure option. 1673985551::WARNING: A new file was added to xml alarm files.....reparsing xml... 1673985551::WARNING: FILE: /usr/TKLC/plat/etc/alarms/alarms_mps.xml 1673985571::TKLCepap-HA #####warning: group root} does not existexi-t - using root 1726141389::WARNING: Hostname not changed because it is the same. </pre>
16	<b>MPS X:</b> Check that the upgrade	Run the command from the admusr user: <pre> [root@Floater04 ~]\$ /var/TKLC/backout/diUpgrade ---status </pre>



	completed successfully.			
17	<b>MPS X:</b> Check that the upgrade completed successfully.	<p>Verify that the following output is displayed. If it is not, contact My Oracle Support following the instructions on the front page or the instructions on the Appendix E.</p> <pre>[root@Floater04 ~]# /var/TKLC/backout/diUpgrade --status State: Upgrade Applied Status Messages: - Performing early checks - Downloading upgrade data - Verifying image - Performing image pre-install - Configuring images - Identifying resources - Reserving image storage - Installing image - Verifying configuration sanity - Performing image post-install - Image install complete - Validating image pre-apply - Performing image pre-apply - Applying image - Performing configuration export - Performing image post-apply - Image Apply Complete</pre>		
18	<b>MPS X :</b> Syscheck reconfiguration	<p>Run the following commands for unmasking and starting the Epap and Pdba status:</p> <table border="1" data-bbox="459 1317 1549 1603"> <tr> <td data-bbox="459 1317 1002 1603"> <p>In case of Mixed/PDBonly setup run the following commands:</p> <pre>[root@Osorna-A ~]# systemctl unmask Epap Pdba mysql@app mysql@pdb  [root@Osorna-A ~]# systemctl restart mysql@pdb mysql@app Epap Pdba</pre> </td> <td data-bbox="1002 1317 1549 1603"> <p>In case of NonProvisionable Setup, run the following commands:</p> <pre>[root@Osorna-A ~]# systemctl unmask Epap mysql@app mysql@pdb [root@Osorna-A ~]# systemctl restart mysql@pdb mysql@app Epap</pre> </td> </tr> </table> <p>If you have the comcol folder, then run the following commands:</p> <pre>systemctl restart TKLCha TKLCharsync systemctl restart runGsConn</pre>	<p>In case of Mixed/PDBonly setup run the following commands:</p> <pre>[root@Osorna-A ~]# systemctl unmask Epap Pdba mysql@app mysql@pdb  [root@Osorna-A ~]# systemctl restart mysql@pdb mysql@app Epap Pdba</pre>	<p>In case of NonProvisionable Setup, run the following commands:</p> <pre>[root@Osorna-A ~]# systemctl unmask Epap mysql@app mysql@pdb [root@Osorna-A ~]# systemctl restart mysql@pdb mysql@app Epap</pre>
<p>In case of Mixed/PDBonly setup run the following commands:</p> <pre>[root@Osorna-A ~]# systemctl unmask Epap Pdba mysql@app mysql@pdb  [root@Osorna-A ~]# systemctl restart mysql@pdb mysql@app Epap Pdba</pre>	<p>In case of NonProvisionable Setup, run the following commands:</p> <pre>[root@Osorna-A ~]# systemctl unmask Epap mysql@app mysql@pdb [root@Osorna-A ~]# systemctl restart mysql@pdb mysql@app Epap</pre>			

		Run the following command for reconfiguration of syscheck: <b>\$ syscheck --reconfig</b>
19	<b>MPS X</b> : Reboot after installation	Reboot the system after the “Apply Complete Process” to finally finish the installation. <b>\$ reboot</b>
20	<b>MPS X</b> : Install Complete.	Install Procedure is complete. The installation procedure is complete. If there are any issues in the upgrade, check <b>Procedure A.49 Dual Image Upgrade Known Issues Fix</b> .
21	Note down the timestamp in log.	Run the following command: <b>\$ date</b>

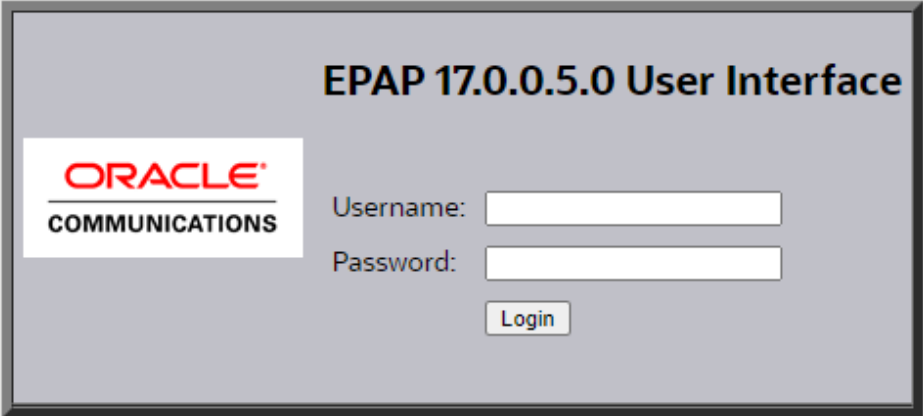
### Procedure A.48 Switchover PDBA state

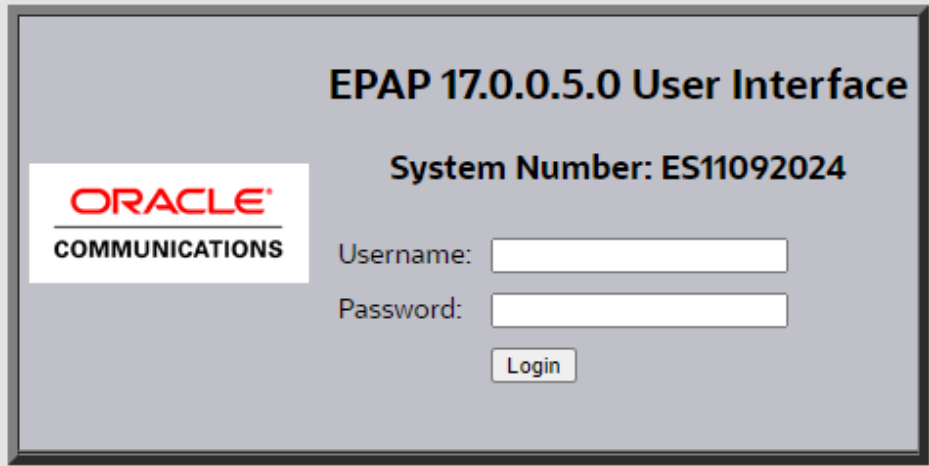
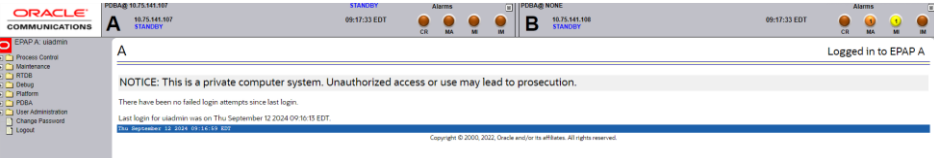
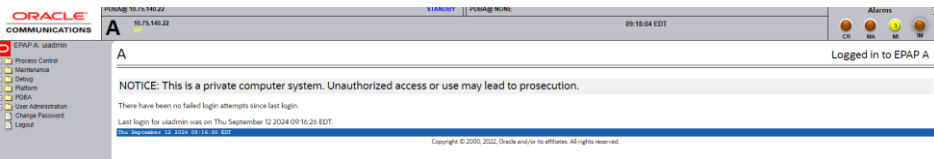
<b>S T E P #</b>	This procedure provisions 1 NE and 1 DN from GUI on Active Site.	
	Check off (√) each step as it is completed. Boxes have been provided for this purpose under each step number.	
	IF THIS PROCEDURE FAILS, CONTACT MY ORACLE SUPPORT AND ASK FOR ASSISTANCE.	
<b>1.</b> <input type="checkbox"/>	<p>Access the EPAP GUI by opening a web browser (Preferably IE) via HTTPS and providing the IP address of Server A.</p> <p>The EPAP LOGIN screen should appear.</p>	<p>The GUI screen on Mixed EPAP appears.</p> 

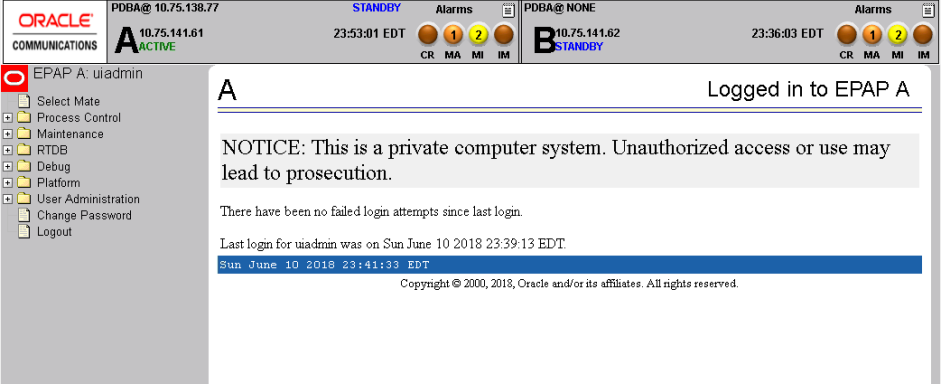
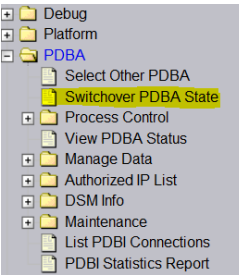
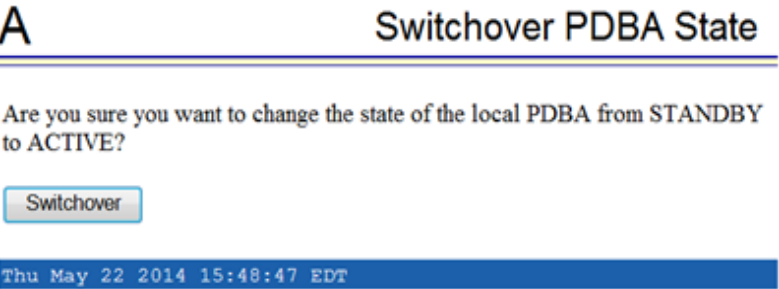
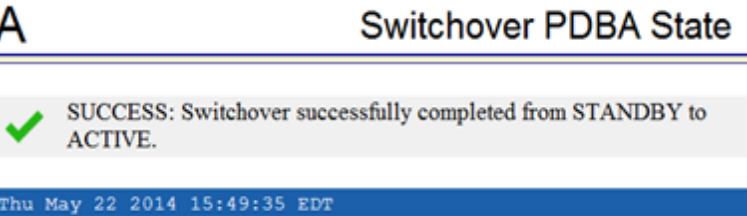
		<p>The GUI screen on standalone PDB appears.</p> 
<p>2. □</p>	<p>Login: Log in as uiadmin.</p>	<p>The GUI screen on Mixed EPAP appears.</p>  <p>The GUI screen on Standalone PDB appears.</p>  <p>The GUI screen on Non-Prov EPAP appears.</p>

		
<p>3. <input type="checkbox"/></p>	<p>On the Site designated by the customer Active PDB GUI, select “<b>Switchover PDBA State</b>” to make the PDBA Active.</p> 	<p>The following screen appears.</p> 
<p>4. <input type="checkbox"/></p>	<p>Click on the “<b>Switchover</b>” button.</p>	<p>The following screen appears.</p> 
<p>5. <input type="checkbox"/></p>	<p>PDBA should become ACTIVE.</p>	<p>The following screen appears.</p> 

## Procedure A.49 Dual Image Upgrade Known Issues Fix

### 1. Title: Stuck in the boot menu with multiple boot options.

Fix: If you are stuck in the boot menu while rebooting during Apply Upgrade, select the default option. An example of the default option to be selected is given below:

```
Oracle Linux Server 8 (5.15.0-209.161.7.el8uek.x86_64)
Oracle Linux Server (4.18.0-553.16.1.el8_10.x86_64) 8.10
Oracle Linux Server 8 (0-rescue-c651157eee214c9dbded006a90a81656)

Use the ^ and v keys to change the selection.
Press 'e' to edit the selected item, or 'c' for a command prompt.
```

If you are stuck in the boot menu while rejecting the upgrade, please select the “**split-mirror-backout**” option. An Example is given below:

```
Oracle Linux Server (4.18.0-477.21.1.el8_8.x86_64) 8.8
split-mirror-backout
```

### 2. Core Files Alarm on the upgraded setup

Fix: It is a known alarm that originates in case of Dual Image Upgrade. To get rid of this alarm, run these commands on the setup that is having those alarms:

```
[root@Osorna-A ~]# rm -rf /var/TKLC/core/*
```

## Procedure A.50 Accept/Reject the Dual Image Upgrade

1	Accept/Reject the DIU upgrade	Follow the below steps to Accept/Reject the DIU upgrade. Log in to the setup with the root user.  1. Run the following command: a. [root@Floater04 ~]# su - platcfg  2. Select the Maintenance option and press [ENTER].
---	-------------------------------	---

a.

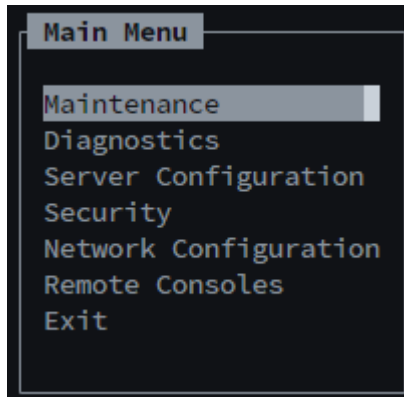

3. From the maintenance menu, select the **Dual Image Upgrade** option and press **[ENTER]**.

a.

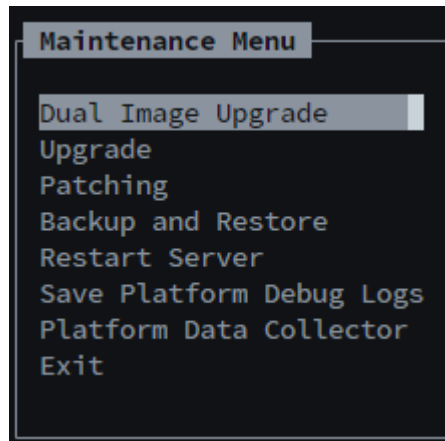

4. From the dual image upgrade menu, select the **Accept** or **Reject** option and press **Enter**.

a.

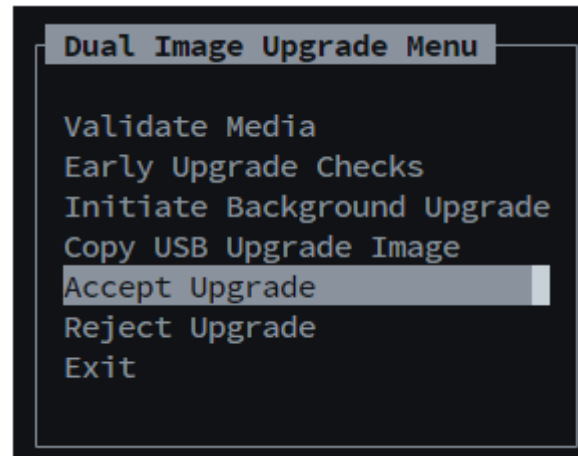

5. a. The following logs will appear on the screen (in case of Accept).

```
/var/TKLC/backout/biosboot.gz
/mnt/upgrade/images/plat_usr.tar.gz
/mnt/upgrade/images/plat_var.tar.gz
/mnt/upgrade/images/plat_var_tklc.tar.gz
Performing image post-accept
Running postAccept() for DIUpgrade:Policy:P20TPD upgrade policy...
Running postAccept() for DIUpgrade:Policy:P31EPAPssl upgrade policy...
Running postAccept() for DIUpgrade:Policy:P32EPAPSyscheck upgrade policy...
Running postAccept() for DIUpgrade:Policy:P33EPAPMycnf upgrade policy...
Creating alarm script: /tmp/xtVsQSxvFJ
Re-adding secondary drive to the raid mirror.
Re-added secondary drive to the raid mirror.
#####
#          ACCEPT COMPLETE          #
#####
Check is rebootcheck is enabled ...
Disabling service rebootcheck...
Transitioning from 'Accepting Upgrade' to 'No Upgrade Available'
Cleaning backout directory.

PRESS ANY KEY TO RETURN TO THE PLATCFG MENU.
```

```
Message
The accept has completed.

Press any key to continue...
```

b. The following logs will appear on the screen (in case of Reject)

		<pre> 06:50:15 Running pre-installation scripts 1770619815: ***** 1770619815: Creating temporary mount points! 1770619815: ***** 1770619815: ***** 1770619815: Activating volume groups! 1770619815: ***** 1770619815: ***** 1770619815: Mounting vgroot-plat_var_tklc 1770619815: ***** 1770619815: ***** 1770619815: Securing old logs! 1770619815: ***** 1770619815: ***** 1770619815: upgrade_info.yml found on primary mount, proceeding. 1770619815: ***** 1770619815: ***** 1770619815: De-Activating vo lume groups! 1770619815: ***** 1770619815: ***** 1770619815: Stopping raid devices 1770619815: ***** 1770619815: ***** 1770619815: stopping /dev/md1 mdadm: stopped /dev/md  [ 82.222044] bash[7059]: [Mon Feb 09 02:22:29.960650 2026] [so:warn] [pid 7059] AH01574: module ssl_module is already loaded, skipping [ 82.224086] bash[7059]: [Mon Feb 09 02:22:29.963696 2026] [so:warn] [pid 7059] AH01574: module security2_module is already loaded, skipping [ 82.233082] bash[7059]: [Mon Feb 09 02:22:29.966645 2026] [so:warn] [pid 7059] AH01574: module headers_module is already loaded, skipping [ 82.233235] bash[7059]: [Mon Feb 09 02:22:29.966687 2026] [so:warn] [pid 7059] AH01574: module rewrite_module is already loaded, skipping [ 82.233323] bash[7059]: [Mon Feb 09 02:22:29.972311 2026] [core:warn] [pid 7059] AH00117: Ignoring deprecated use of DefaultType in line 459 of /etc/httpd/conf/httpd.conf. [ 82.233463] bash[7059]: [Mon Feb 09 02:22:29.972338 2026] [alias:warn] [pid 7059] AH00671: The Alias directive in /etc/httpd/conf/httpd.conf at line 557 will probably never match because it overlaps an earlier Alias. [ 82.436372] bash[7078]: [Mon Feb 09 02:22:30.176286 2026] [so:warn] [pid 7078] AH01574: module cgi_module is already loaded, skipping [ 82.436986] bash[7078]: [Mon Feb 09 02:22:30.177039 2026] [so:warn] [pid 7078] AH01574: module ssl_module is already loaded, skipping [ 82.439967] bash[7078]: [Mon Feb 09 02:22:30.180307 2026] [so:warn] [pid 7078] AH01574: module security2_module is already loaded, skipping [ 82.443045] bash[7078]: [Mon Feb 09 02:22:30.183807 2026] [so:warn] [pid 7078] AH01574: module headers_module is already loaded, skipping [ 82.443130] bash[7078]: [Mon Feb 09 02:22:30.183848 2026] [so:warn] [pid 7078] AH01574: module rewrite_module is already loaded, skipping [ 82.448443] bash[7078]: [Mon Feb 09 02:22:30.188771 2026] [core:warn] [pid 7078] AH00117: Ignoring deprecated use of DefaultType in line 459 of /etc/httpd/conf/httpd.conf. [ 82.448566] bash[7078]: [Mon Feb 09 02:22:30.188801 2026] [alias:warn] [pid 7078] AH00671: The Alias directive in /etc/httpd/conf/httpd.conf at line 557 will probably never match because it overlaps an earlier Alias. [ 82.857679] TKLWatchdog[6977]: Starting TKLWatchdog: [ 82.858288] TKLWatchdog[7041]: Daemon is not running... [ 82.955950] TKLWatchdog[7038]: AlarmMgr daemon is not running, delaying by 1 minute [ 83.307634] TKLWatchdog[7198]: Filesystem monitoring is not enabled. [ 83.373614] TKLWatchdog[6977]: [ OK ] [ 84.207196] TKLdiskcheck[7278]: Verifying disk configuration for S.M.A.R.T.: [ OK ] [ 85.131149] bash[7578]: RequestReadTimeout [ 85.352982] bash[7615]: LimitRequestLine [ 85.459245] bash[7635]: LimitRequestFields [ 85.586425] bash[7659]: LimitRequestFieldSize [ 85.694159] bash[7679]: LimitRequestBody [ 86.080288] TKLCe5appx[7476]: Starting TKLCe5appx: [ OK ] [ 89.521781] TKLCethcfg[7738]: Checking network config files: [ 90.265449] TPD-PDC[7972]: Daemon is not running... [ 90.348356] TPD-PDC[7966]: AlarmMgr daemon is not running, delaying by 1 minute [ 100.174530] completeTasks[8037]: completeTasks started: Mon Feb 9 02:22:47 2026 [ 100.174766] completeTasks[8037]: LOG FILE: /var/TKLC/log/TaskMgr/completeTasks.log </pre>
*Note	Revert the space taken during DIU	<p>This is the process to revert the unmounted space that was taken while doing the DIU procedure.</p> <p><b>Note:</b> This should only be done after accepting the DIU upgrade.</p> <p>Procedure:</p> <ul style="list-style-type: none"> <li>Run the following command: <pre>lvextend -L +30G /dev/vgroot/free; resize2fs /dev/vgroot/free</pre> </li> </ul>

## Procedure A.51 MySQL RPM Upgrade Procedure

**Note:**

- 1) This procedure is only applicable if upgrading from EPAP 17.0.0.x to 17.0.0.y (where 0<= x <=5 and y >= 6) or from 17.0.0.x (where 0<= x <=5 ) to 17.1.y via migration. The EPAP GUI will not be accessible after this procedure.
- 2) Download Mysql\_Upgrade\_Rpms.zip from the Oracle Software Download Centre (OSDC).

S. No.	Steps	This procedure performs MySQL RPM Upgrade on the server. Check off (✓) each step as it is completed. Boxes have been provided for this purpose beside each step number. If this procedure fails, contact My Oracle Support and ask for ASSISTANCE.
1	MPS X: Login prompt is displayed.	<hostname> console login:  Note: Press enter if no login prompt is displayed.
2	MPS X: Log in as epapdev user and switch to root user.	[hostname] consolelogin: epapdev password: password  epapdev@lthaca-a ~]\$ su - Password:password
3	MPS X: Copy Mysql 8.4.0 RPMS from mysql_rpms directory of Mysql_Upgrade_Rpms.zip into free directory via epapdev user	After copying mysql rpms run below command to check if they are present in free directory.  [root@Salta-a ~]# ll /var/TKLC/epap/free  -rwxr-x--- 1 epapdev epap 4098340 Jan 27 09:05 mysql-commercial-backup-8.4.0-1.1.el8.x86_64.rpm -rwxr-x--- 1 epapdev epap 13434336 Jan 27 09:05 mysql-commercial-client-8.4.0-1.1.el8.x86_64.rpm -rwxr-x--- 1 epapdev epap 3991796 Jan 27 09:05 mysql-commercial-client-plugins-8.4.0-1.1.el8.x86_64.rpm -rwxr-x--- 1 epapdev epap 709260 Jan 27 09:05 mysql-commercial-common-8.4.0-1.1.el8.x86_64.rpm -rwxr-x--- 1 epapdev epap 23103448 Jan 27 09:05 mysql-commercial-devel-8.4.0-1.1.el8.x86_64.rpm -rwxr-x--- 1 epapdev epap 2350976 Jan 27 09:05 mysql-commercial-icu-data-files-8.4.0-1.1.el8.x86_64.rpm -rwxr-x--- 1 epapdev epap 1542176 Jan 27 09:05 mysql-commercial-libs-8.4.0-1.1.el8.x86_64.rpm -rwxr-x--- 1 epapdev epap 62328968 Jan 27 09:05 mysql-commercial-server-8.4.0-1.1.el8.x86_64.rpm

4	<p>MPS X: Copy install_mysql.sh from scripts directory of Mysql_Upgrade_Rpms.zip into free directory via epapdev user</p>	<p>After copying install_mysql.sh to free directory, move to free directory.  <b>[root@Salta-a ~]# cd /var/TKLC/epap/free</b></p> <p>Change permissions of the script:  <b>[root@Salta-a free]# chown epapdev:epap install_mysql.sh</b></p> <p><b>[root@Salta-a free]# chmod 755 install_mysql.sh</b></p>
5	<p>MPS X: Run install_mysql.sh</p>	<p><b>[root@Salta-a free]# ./install_mysql.sh</b></p> <p>Performing installation of mysql commercial version 8.4.0  Verifying... #####  [100%]  Preparing... #####  [100%]  Updating / installing...  1:mysql-commercial-icu-data-files-  8##### [ 50%]  Cleaning up / removing...  2:mysql-commercial-icu-data-files-  8##### [100%]  Verifying... #####  [100%]  Preparing... #####  [100%]  Updating / installing...  1:mysql-commercial-client-8.4.0-  1.1##### [ 50%]  Cleaning up / removing...  2:mysql-commercial-client-8.0.35-  1.1##### [100%]  Verifying... #####  [100%]  Preparing... #####  [100%]  Updating / installing...  1:mysql-commercial-devel-8.4.0-  1.1##### [ 50%]  Cleaning up / removing...  2:mysql-commercial-devel-8.0.35-  1.1##### [100%]  Verifying... #####  [100%]  Preparing... #####  [100%]</p>

		<pre> Updating / installing...  1:mysql-commercial-common-8.4.0- 1.1##### [ 50%] Cleaning up / removing...  2:mysql-commercial-common-8.0.35- 1.##### [100%] Verifying... ##### [100%] Preparing... ##### [100%] Updating / installing...  1:mysql-commercial-libs-8.4.0- 1.1.e##### [ 50%] Cleaning up / removing...  2:mysql-commercial-libs-8.0.35- 1.1.##### [100%] Verifying... ##### [100%] Preparing... ##### [100%] Updating / installing...  1:mysql-commercial-backup-8.4.0- 1.1##### [ 50%] Cleaning up / removing...  2:mysql-commercial-backup-8.0.35- 1.##### [100%] Verifying... ##### [100%] Preparing... ##### [100%] Updating / installing...  1:mysql-commercial-client-plugins- 8##### [ 50%] Cleaning up / removing...  2:mysql-commercial-client-plugins- 8##### [100%] Verifying... ##### [100%] Preparing... ##### [100%] Updating / installing...  1:mysql-commercial-server-8.4.0- 1.1##### [ 50%] Cleaning up / removing...  2:mysql-commercial-server-8.0.35- 1.##### [100%] </pre>
--	--	---

6	<p>MPS X: Check if Mysql RPM's upgraded or not.</p> <p><b>Note: Versions of mysql-common and perl-DBD packages may vary depending upon EPAP version you are migrating from.</b></p>	<pre>[root@Salta-a free]# rpm -qa  grep -i mysql</pre> <p>mysql-common-8.0.36-1.module+el8.9.0+90153+70413b10.x86_64 mysql-commercial-devel-8.4.0-1.1.el8.x86_64 mysql-commercial-common-8.4.0-1.1.el8.x86_64 perl-DBD-mysql-5.002P-17.0.0.3.0_170.17.0.x86_64 mysql-commercial-client-plugins-8.4.0-1.1.el8.x86_64 mysql-commercial-backup-8.4.0-1.1.el8.x86_64 mysql-commercial-icu-data-files-8.4.0-1.1.el8.x86_64 mysql-commercial-server-8.4.0-1.1.el8.x86_64 mysql-commercial-client-8.4.0-1.1.el8.x86_64 mysql-commercial-libs-8.4.0-1.1.el8.x86_64</p>
7	<p>MPS X: Copy update_plugin.sh from scripts directory of Mysql_Upgrade_Rpms.zip into free directory via epapdev user</p>	<p>After copying update_plugin.sh to free directory,</p> <p>Change permissions of the script:</p> <pre>[root@Salta-a free]# chown epapdev:epap update_plugin.sh</pre> <pre>[root@Salta-a free]# chmod 755 update_plugin.sh</pre>
8	<p>MPS X: Run update_plugin.sh</p>	<pre>[root@Salta-a free]# ./update_plugin.sh</pre> <p>Log in to mysql and check plugin of mysql users</p> <pre>[root@Salta-a free]# mysql -uroot -p&lt;MySQL_root_password&gt; -S /var/TKLC/epap/db/pdb/mysql.sock</pre> <p>mysql: [Warning] Using a password on the command line interface can be insecure.</p> <p>Welcome to the MySQL monitor. Commands end with ; or \g. Your MySQL connection id is 9 Server version: 8.4.0-commercial MySQL Enterprise Server - Commercial Copyright (c) 2000, 2024, Oracle and/or its affiliates. Oracle is a registered trademark of Oracle Corporation and/or its affiliates. Other names may be trademarks of their respective owners. Type 'help;' or '\h' for help. Type '\c' to clear the current input statement.</p> <pre>mysql&gt; select user,plugin,host from mysql.user;</pre> <pre>+-----+-----+-----+   user        plugin        host        +-----+-----+-----+   multi_admin   caching_sha2_password   localhost     mysql.infoschema   caching_sha2_password   localhost     mysql.session   caching_sha2_password   localhost     mysql.sys     caching_sha2_password   localhost     pdbSelect    caching_sha2_password   localhost  </pre>

		<pre>  pdba        caching_sha2_password   localhost     root        caching_sha2_password   localhost     statuser    caching_sha2_password   localhost     pdba        caching_sha2_password   mate         root        caching_sha2_password   mate         pdbSelect   caching_sha2_password   salta-a    +-----+-----+-----+ 11 rows in set (0.00 sec) mysql&gt; exit</pre>
9	MPS X: Copy pdbBackup.sh from scripts directory of Mysql_Upgrade_Rpms.zip into free directory via epapdev user (edited)	<p>After copying pdbBackup.sh to free directory,</p> <p>Change permissions of the script:</p> <pre><b>[root@Salta-a free]# chown epapdev:epap pdbBackup.sh</b></pre> <pre><b>[root@Salta-a free]# chmod 755 pdbBackup.sh</b></pre>
10	MPS X: Run pdbBackup.sh script	<pre>[root@Salta-a free]# ./pdbBackup.sh</pre> <p>The script ends with below logs at the end.</p> <pre>..... .....&lt;backup logs&gt;..... ..... ibbackup completed OK! <b>pdbBackup_Donut-A_1738050432.tar.gz has been created</b></pre>
11	MPS X: Transfer the backup created in above step to remote machine.	<p>Using SFTP (secure-FTP), transfer the PDB backup file to a remote, customerprovided computer. Enter "yes" when prompted if you want to continue to connect.</p> <pre><b>\$ cd /var/TKLC/epap/free</b> <b>\$ sftp &lt;IP address of remote machine&gt;</b></pre> <p>Connecting to ... The authenticity of host " " can't be established. DSA key fingerprint is 58:a5:7e:1b:ca:fd:1d:fa:99:f2:01:16:79:d8:b4:24. Are you sure you want to continue connecting (yes/no)? <b>yes</b> Warning: Permanently added ' (DSA) to the list of known hosts.</p> <pre><b>root@&lt;IP address of remote machine&gt;'s password:</b> sftp&gt; cd &lt;target directory&gt; sftp&gt; put <b>pdbBackup_Donut-A_1738050432.tar.gz</b> Uploading <b>pdbBackup_Donut-A_1738050432.tar.gz</b> to <b>pdbBackup_Donut-A_1738050432.tar.gz</b> sftp&gt; bye</pre>

		<p>If no customer provided remote computer for backups exist, transfer the backup file to the mate using the following command</p> <pre>\$ su – epapdev \$ scp /var/TKLC/epap/free/&lt;PDB backup file&gt; epapdev@mate:/var/TKLC/epap/free/</pre>
--	--	--

### Procedure A.52 Post MySQL RPM upgrade PDB Restore Procedure

**Note:** This procedure is only applicable if upgrading from EPAP 17.0.0.x to 17.0.0.6/17.1 via migration.

S.No	Steps	<p><b>This procedure performs Restoration of PDB created by MySQL RPM Upgrade Procedure on the server.</b></p> <p><b>Check off (✓) each step as it is completed. Boxes have been provided for this purpose beside each step number.</b></p> <p><b>If this procedure fails, contact My Oracle Support and ask for ASSISTANCE.</b></p>
1	MPS X: Login prompt is displayed.	<p>&lt;hostname&gt; console login:</p> <p><b>Note:</b> Press enter if no login prompt is displayed.</p>

2	MPS X: Log in as epapdev user and switch to root user.	[hostname] consolelogin: epapdev password: password [epapdev@lthaca-a ~]\$ su - Password:password
3	MPS X: Copy the PDB Backup file to free directory.	After copying PDB backup to free directory, Change Permissions of PDB Backup: <b>[root@Salta-a ~]# cd /var/TKLC/epap/free</b>  <b>[root@Salta-a free]# chown epapdev:epap pdbBackup_Salta-a_1737987790.tar.gz</b>  <b>root@Salta-a free]# chmod 755 pdbBackup_Salta-a_1737987790.tar.gz</b>
4	MPS X: Restoring the PDB	<pre>[root@Donut-A free]# /usr/TKLC/epap/config/restore_pdb --force Tue Jan 28 08:58:03 EST 2025 This script will replace the existing PDB with one provided from a backup and copy the restored backup to the remote. <b>Are you sure you want to do continue? (y/n) y</b>  <b>Enter the name of the backup tar.gz file.</b> /var/TKLC/epap/free/pdbBackup_Donut-A_1738050432.tar.gz localIp = 10.75.141.119 localName=Donut-A remoteIp = 0.0.0.0 No remote site WARNING : If this backup is from EPAP 16.1 or earlier release please use option --force7 <b>Are you sure this backup is taken on EPAP 16.2 release? (y/n)y</b> <b>Do you want to restore Stats database? (y/n) y</b> Running with force option! Skip disk space check.. remoteBIp = 0.0.0.0 There is no remote B PDB Unzipping backup file. This may take a while.. Running with force option! Skip compatibility check.. Stopping local PDBA Stopping local PDB mysql daemon No need to create backup directory.. Running ibbackup tool to restore DBWe trust you have received the usual lecture from the local System  Administrator. It usually boils down to these three things: #1) Respect the privacy of others. #2) Think before you type. #3) With great power comes great responsibility.[sudo] password for mysql: mysql:</pre>

		<p>.....</p> <p>.....&lt;Restore Logs&gt;.....</p> <p>.....</p> <p><b>Restore completed successfully.</b>  <b>Wed Jan 29 02:37:23 EST 2025</b>  <b>[root@Donut-A free]#</b></p>
--	--	---

**Procedure A.53 Keys exchange between OL 8 based PDBonly and OL6 based Non-prov**

**Procedure A.53: Pre-Install Verification on VM**

<b>S T E P #</b>	This procedure lists the steps to exchange the keys between OL 6 based PDBonly and OL8 based Non-Prov.	
	Estimated time of completion: 5 minutes. Check off (✓) each step as it is completed. Boxes have been provided for this purpose under each step number. SHOULD THIS PROCEDURE FAIL, CONTACT TEKELEC TECHNICAL SERVICES AND ASK FOR MIGRATION ASSISTANCE.	
1. <input type="checkbox"/>	PDBonly server: Verify that the key exchange is working appropriately now.	If not already logged in, then log in with epapdev user at PDBonly at EPAP 17.0/17.1:  console login: epapdev password:

**Procedure A.53: Pre-Install Verification on VM**

		<p>Verify that you are able to do a ssh from PDBonly (release 17.0/17.1) server to Non-Prov (release 16.3/16.4) node A or B without any password.</p> <p>Run the below command from PDBonly server.</p> <p>Verify between PDBonly and Non prov node A . Replace Non_prov_epap_A with ip non prov node A IP.  ssh epapdev@Non_prov_epap_A  Verify between PDBonly and Non prov node A. Replace Non_prov_epap_B with ip non prov node B IP  ssh epapdev@Non_prov_epap_B</p> <p><b>Note:</b> If keyexchange is already working between PDBonly and Non-Prov, there is no need to perform this procedure further.</p>
<p>2. <input type="checkbox"/></p>	<p>MPS A: Log in to Non-Prov EPAP server on release 16.3/16.4 as the user "epapdev"</p>	<p>If not already logged in, then log in to Non-Prov EPAP A site:</p> <p><b>console login: epapdev</b>  <b>password:</b></p>
<p>3. <input type="checkbox"/></p>	<p>MPS A: Perform the following procedure on Non-Prov EPAP 16.3/16.4.</p> <p><b>Note:</b> Generating RSA keys first with servers installed on older release 16.3.1/16.4.1</p> <p>Also generate RSA key with both sides of the non-Prov server.</p>	<p>Run the following command from Non-Prov EPAP A node and generate keys for both A and B nodes of the non-prov server:</p> <p>Generate RSA key on Non-Prov EPAP A:  # /usr/bin/ssh-keygen -t rsa -f .ssh/id_rsa -N ""  Generate RSA key on non-Prov EPAP B:  # ssh mate "/usr/bin/ssh-keygen -t rsa -f .ssh/id_rsa -N "" "</p> <p>Example:  Recife-A is non-Prov EPAP A on release 16.3/16.4.</p> <pre>[epapdev@Recife-A free]\$ /usr/bin/ssh-keygen -t rsa -f .ssh/id_rsa -N "" Generating public/private rsa key pair. Your identification has been saved in .ssh/id_rsa. Your public key has been saved in .ssh/id_rsa.pub. The key fingerprint is: 47:54:4c:74:96:f2:e9:31:1f:b1:a8:5f:81:64:36:f0 epapdev@Devloan01 The key's randomart image is: +--[ RSA 2048]-----+   .*= o.     . +B..     . +E+.o     . o=+  </pre>

**Procedure A.53: Pre-Install Verification on VM**

		<pre>   S ... +o  Upgrade/Installation Guide 361 of 448 April 2025 Confidential - Oracle Restricted Confidential - Oracle Restricted   . . . .    . .     .       +-----+ [epapdev@Recife-A free]\$ ssh epapdev@10.75.141.56 "/usr/bin/ssh-keygen -t rsa -f .ssh/id_rsa -N " " epapdev@10.75.141.56's password: Generating public/private rsa key pair. Your identification has been saved in .ssh/id_rsa. Your public key has been saved in .ssh/id_rsa.pub. The key fingerprint is: af:08:75:05:38:00:b9:0c:1e:61:e7:9b:6a:d3:82:47 epapdev@Devloan02 The key's randomart image is: +--[ RSA 2048]-----+   oo+.. ..    o.+ o .    .o.o . .    .o o .     Eo . S    ..o . . .    .=... .    ..o . . .     . .   +-----+ [epapdev@Recife-A free]\$ </pre>
<p>4. <input type="checkbox"/></p>	<p>MPS A: Exchange keys between non-Prov and pdbonly.</p>	<p>Run below command from non-Prov EPAP node A, which is on release 16.3/16.4. The commands will be run from epapdev user. Replace \$pdblpAddr from the PDBonly IP in the commands.</p> <p>Key exchange between PDBonly and Non Prov node A:  <b>/usr/TKLC/plat/bin/keyexchange --key=id_rsa.pub \$pdblpAddr</b></p> <p>Key exchange between PDBonly and Non Prov node B:  <b>/usr/bin/ssh -t -l epapdev mate /usr/TKLC/plat/bin/keyexchange --key=id_rsa.pub \$pdblpAddr</b></p>
<p>5. <input type="checkbox"/></p>	<p>PDBonly server: Verify that the key exchange is working</p>	<p>After the above steps for keyexchange have been performed, verify that you are now able to do a ssh from PDBonly server to non-Prov node A or B without any password.</p>

**Procedure A.53: Pre-Install Verification on VM**

	appropriately now.	<p>Run the below command from PDBonly server.</p> <p>Verify between PDBonly and Non prov node A. Replace Non_prov_epap_A with ip non prov node A IP.</p> <pre>ssh epapdev@Non_prov_epap_A</pre> <p>Verify between PDBonly and Non prov node B. Replace Non_prov_epap_B with ip non prov node B IP</p> <pre>ssh epapdev@Non_prov_epap_B</pre>
6. <input type="checkbox"/>	Procedure complete.	Procedure is complete.

**Procedure A.54 Configure PDB capacity**

**Procedure A.54 Configure PDB capacity**

**Note:** Customers may follow this procedure if they need to configure or update capacity.

S T E P #	This procedure configures the PDB capacity for a PDBonly server in an Extreme Architecture environment with EPAP 17.1 installed.	
	Check off (✓) each step as it is completed. Boxes have been provided for this purpose under each step number.	
If this procedure fails, Contact My Oracle Support AND <b>ASK FOR UPGRADE ASSISTANCE.</b>		
1. <input type="checkbox"/>	<b>Supported DB Capacity in EPAP 17.1</b>	<p>510M DNs are supported for extreme Architecture Only. These capacities will be configured on PDBonly server.</p> <p>With EPAP 17.1, the supported DB combinations for extreme architecture are given below:</p>

		<ol style="list-style-type: none"> <li>1. 510M DN/IMSI/IMEI for SLIC with Data Split OFF</li> <li>2. 900M (420M DN + 480M IMSI/IMEI) for SLIC with Data Split ON</li> <li>3. 1110M (510M DN + 600M IMSI/IMEI) for SLIC with Data Split ON</li> </ol>
2.	<b>MPS A:</b> Configure PDB capacity <input type="checkbox"/>	<p>Please configure the PDB capacity following the EPAP 17.1 Administration Guide.</p> <p>See <a href="#">Oracle Communications EAGLE Application Processor Administration Guide, Release 17.1</a>, Section 6.6 Standalone PDB Capacity Configuration. (Page 6-35)</p>
3.	<b>Procedure is complete.</b> <input type="checkbox"/>	Procedure is complete.

## APPENDIX B INTERCONNECTION DIAGRAM

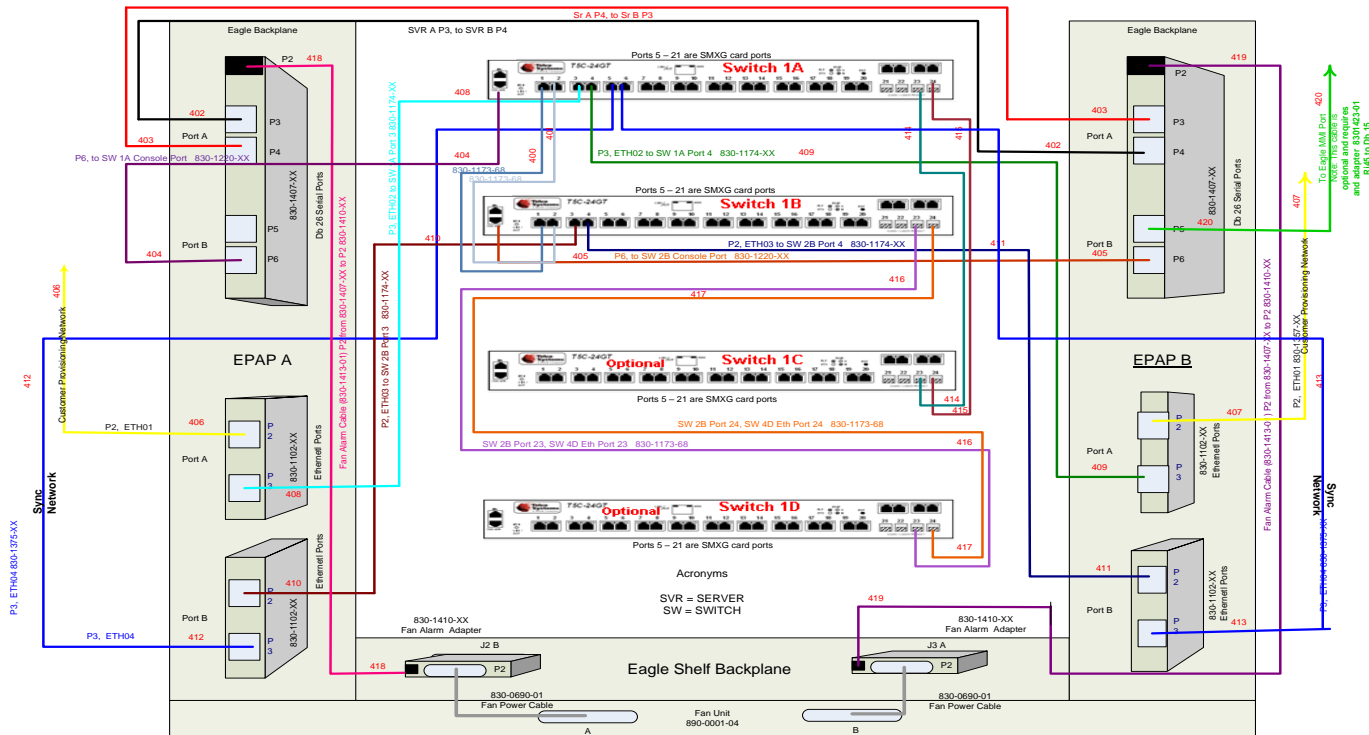

Figure 8: Interconnectivity Diagram for Sync Network Redundancy (Eth04 used for Sync Network)

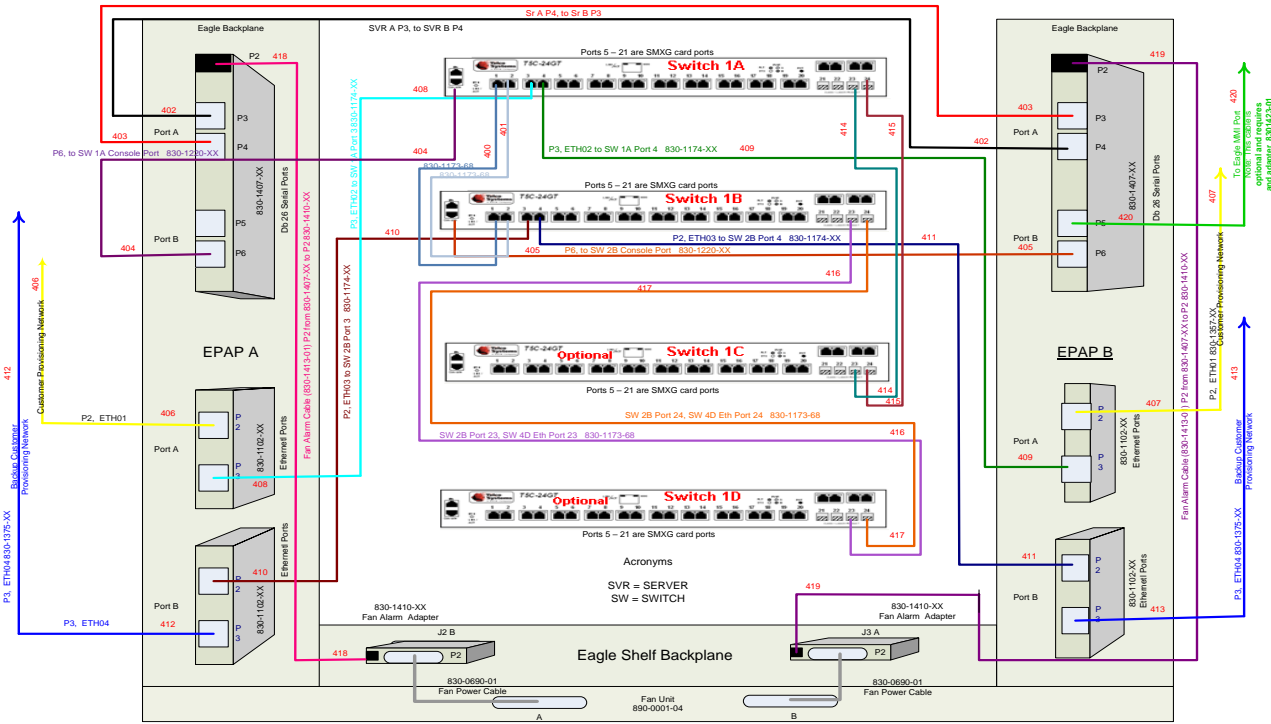
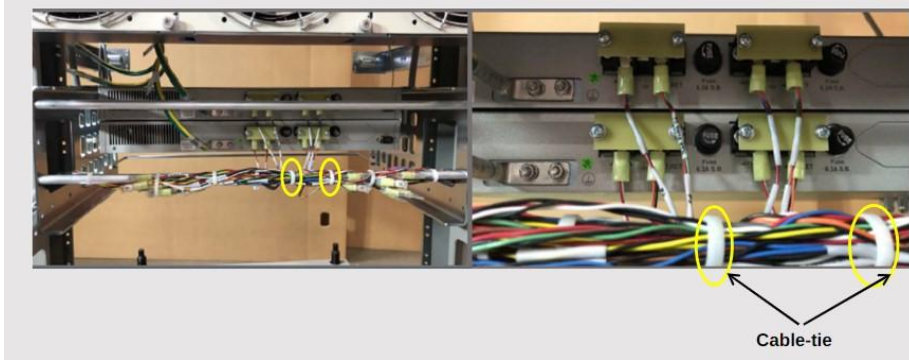
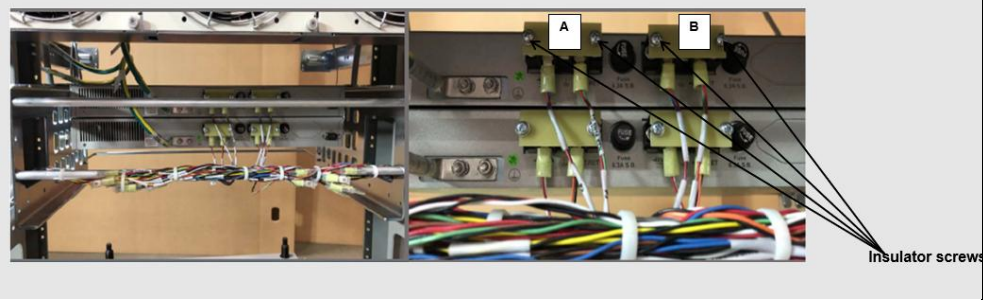
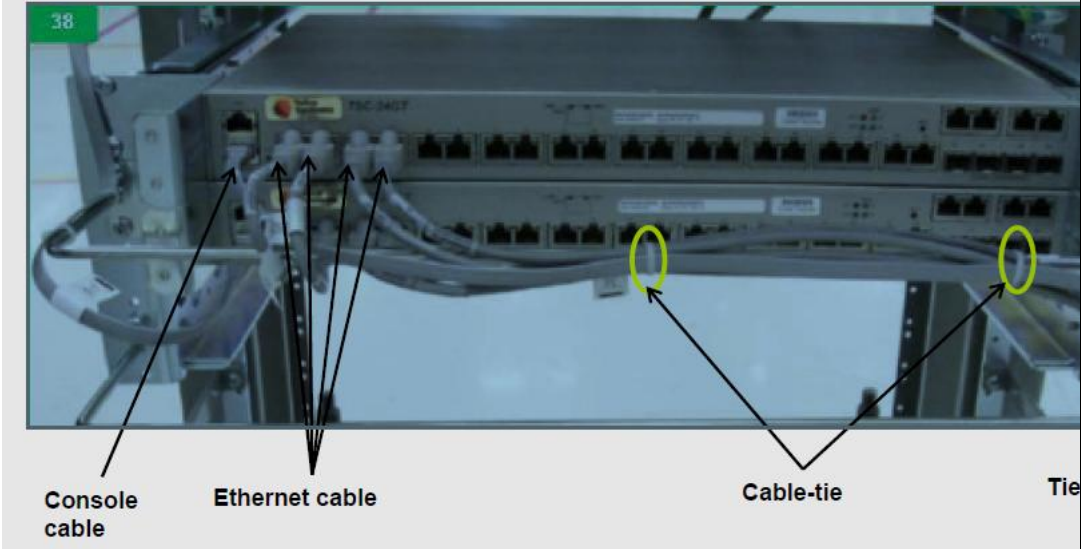

Figure 9: Default Interconnectivity Diagram (Eth04 used for Backup Provisioning Network)

## APPENDIX C TELCO TO CISCO SWITCH REPLACEMENT

### SWITCH REPLACEMENT

<p>This procedure is for replacing the Telco switch with the Cisco switch.</p> <p>Check off (✓) each step as it is completed. Boxes have been provided for this purpose under each step number.</p> <p>IF THIS PROCEDURE FAILS, CONTACT MY ORACLE SUPPORT AND ASK FOR ASSISTANCE.</p>	
<p><b>The following tools are required to perform this procedure:</b></p> <ul style="list-style-type: none"> <li>• Grounding Strap (Wrist or Heel)</li> <li>• #2 Phillips Screwdriver</li> <li>• #3 Phillips Screwdriver</li> <li>• 1/4" Nut Driver or Socket</li> <li>• 5/16" Nut Driver or Socket</li> <li>• Wire Cutter (to cut Tie-wraps)</li> <li>• Diagonal Cutter (to cut Tie-wraps)</li> <li>• Multi Meter</li> <li>• Tie Wraps</li> <li>• Electrical Tape</li> <li>• Cable Tags / Marker (to label all cables)</li> </ul>	
<p><b>1.</b> ☐</p>	<p>Disable and disconnect switch power</p> <ol style="list-style-type: none"> <li>a. At the fuse panel, locate the fuse positions for the switch being removed. To power down the Switch, remove the fuses for both A and B feeds.</li> <li>b. Once the switch is off, unscrew and remove the terminal-block insulator covers from both terminals blocks A and B.</li> <li>c. With covers removed, using a Multi Meter, ensure that there is no power.</li> <li>d. Ensure that the power leads are marked -48V &amp; RTN.</li> <li>e. With the cables marked, one at a time, remove the power cable and tape the terminal ring. Repeat these steps until all power connections are removed.</li> </ol> <div style="text-align: center;">  </div> <p>Note: This procedure will reference replacing the Switch #1 location (top). Same procedure for other switch locations.</p>
<p><b>2.</b></p>	<p>Disconnect ground</p> <ol style="list-style-type: none"> <li>a. Remove the Switch Ground Wire from the grounding point, by loosening and removing Hex nut, Flat washer, and External tooth washer.</li> </ol>

<input type="checkbox"/>	cable from switch	<p>b. Leave Ground Wire dangling. Do not disconnect ground wire attached to cabinet/frame.</p> <p>Note: Hardware removed, nut and washers are NOT required on replacement switch.</p> 
<b>3.</b> <input type="checkbox"/>	Disconnect Front ENET and Console Cables	<p>a. Make sure that all the cables are labeled and are in the correct position that they are terminated at. If not, ensure to mark or label before starting any removal.</p> <p>b. Disconnect the Console and Ethernet cables from Telco switch being replaced. Leave the cables dangling.</p> <p>c. (Optional) If cable management tie-rod is mounted to the switch being replaced, it may be necessary to cut or remove the cable-ties, holding the cables from the Tie-rod.</p> 
<b>4.</b> <input type="checkbox"/>	Remove the Switch being replaced	<p>a. Remove the four (4) PAN head screws (Two (2) on either side of the switch). If there is no support under the switch, take care to support the switch while removing the screws.</p> <p>b. Remove the Switch from the Eagle rack.</p> <p>c. Keep the screws safely set aside. Required for mounting the new switch.</p> <p>Note: If Tie-rod is attached via the screws being removed, then the Tie-rod needs to be set aside for reattachment when the replacement Switch is installed.</p>

<p>5. <input type="checkbox"/> Assemble the replacement Cisco Switch</p>	<p>Attach the mounting brackets with Cisco switch assembly.</p>	<ol style="list-style-type: none"> <li>a. Locate the supplied mounting brackets and screws from the Switch package.</li> <li>b. Align the mounting bracket to the switch using four mounting holes.</li> </ol> <p>Note: Bracket with labels to be mounted on the right side of the switch.</p> <ol style="list-style-type: none"> <li>c. Insert four screws, supplied with each switch, and tighten.</li> </ol> <ol style="list-style-type: none"> <li>d. Repeat the steps b and c for the other side of the switch.</li> <li>e. Attach optional Cable Manager. <ol style="list-style-type: none"> <li>I. Locate Cable Manager and Screw from replacement Switch packaging.</li> <li>II. Attach the Cable Manager to the rack mounting bracket using the supplied screw.</li> </ol> </li> </ol>

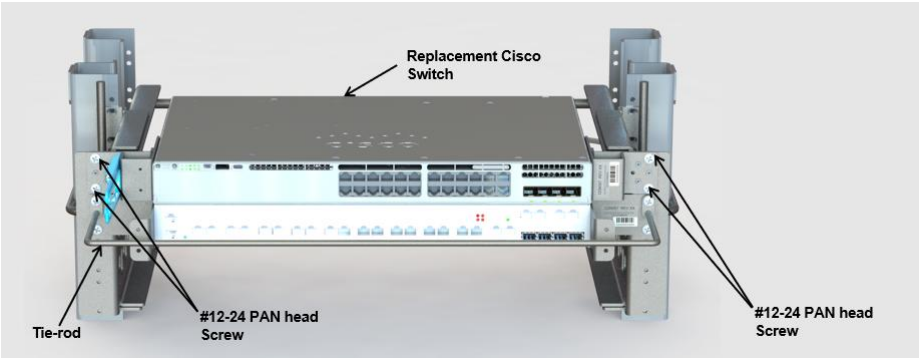
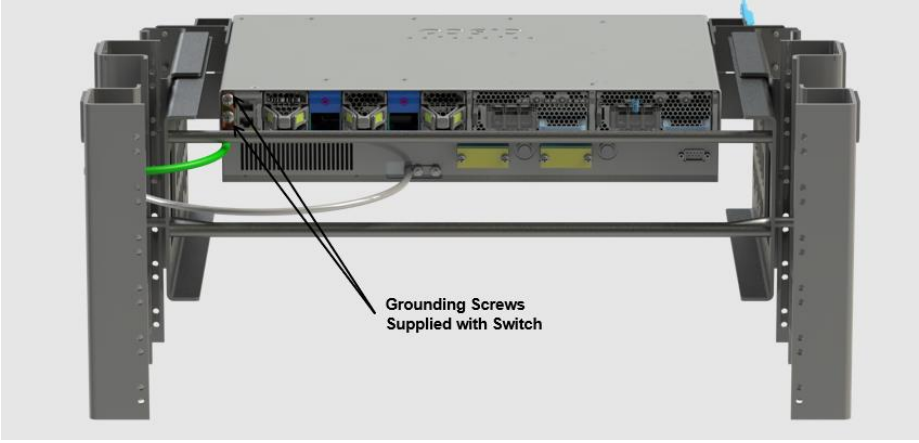
		 <p>Cable manager Cable manager Mounting screw</p>
<p>6. <input type="checkbox"/></p>	<p>Install replacement Cisco Switch</p>	<p>a. Align replacement Cisco Switch in the slot where the original switch was removed.</p>  <p>Replacement Cisco Switch Tie-rod #12-24 PAN head Screw #12-24 PAN head Screw</p> <p>b. Using screws removed from step 4, insert the four (4) PAN head screws (Two (2) on either side of the switch) and tighten.</p> <p>Note: If tie-rod was removed in step 4, reattach at this time.</p>
<p>7. <input type="checkbox"/></p>	<p>Reattach the ground cable</p>	<p>Reattach the chassis ground wire (from Step 3) to switch where shown. Use Screws provided with replacement Cisco Switch.</p>  <p>Grounding Screws Supplied with Switch</p> <p>In Replacement Switch Container, locate grounding screw packet with PN 48-2381-01.</p>



8.  Connect power to the replacement Cisco Switch

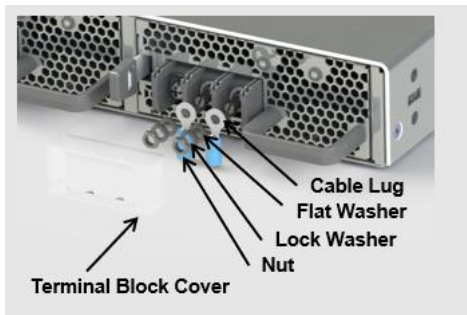

a. Remove terminal block cover.

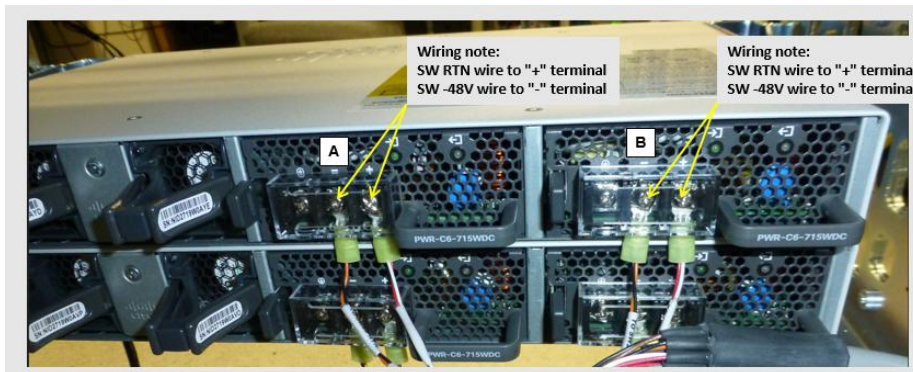

- b. Remove Nuts and Washers from studs on A feed terminal block.
- c. Install the lugs from the power cable (A) to switch terminal block A.
- d. Secure the nuts after inserting flat washer and lock washer on top of the cable lug.
- e. Ensure connections to terminal block are as follows: SW RTN wire to "+" terminal, SW -48V wire to "-" terminal

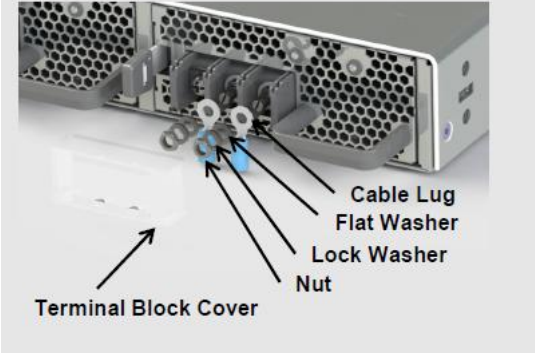
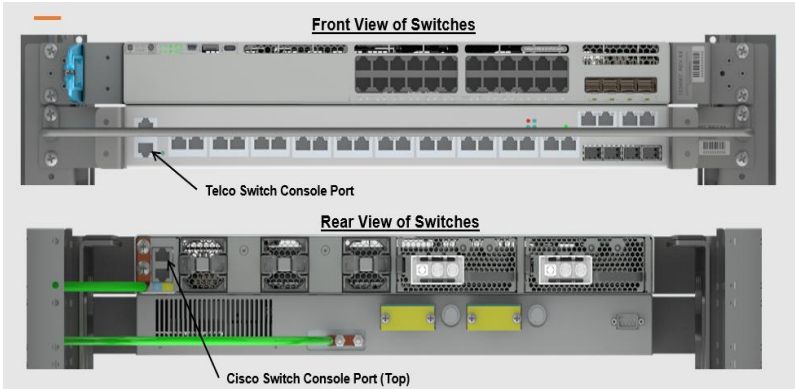

f. Reattach protective cover.

		 <p>g. Repeat the above steps for the B feed connection.</p>
<p>9. <input type="checkbox"/></p>	<p>Reattach Console Cable and Ethernet Cables</p>	<p>a. Plug-in the console port cable to the Replacement Switch.</p>  <p>Note: The Console port on the New Cisco Switch is on the rear side where the power is applied.</p> <p>b. Plug-in the Ethernet cables to Replacement Cisco Switch.</p> <p>Note: The Switch locations are marked on cable from Step 3.</p>
<p>10. <input type="checkbox"/></p>	<p>Reapply power</p>	<p>a. Double check all the connections are in their proper place and are secure.  b. Reinstall the A and B feed power fuses (removed in Step 1) one at a time.  c. Check the switch power supply LED to ensure power is up. Then, install the other fuse and again check power supply LED.</p> <p>The following image shows the switch is now ready to be set up and configured.</p>  <p>The replacement switch is now ready to be setup and configured.</p>
<p>11.</p>	<p>Configure the new</p>	<p>Refer to the following procedure “Switch Configuration” to configure the new Cisco Switch.</p>

<input type="checkbox"/>	Cisco Switch	
--------------------------	--------------	--

### Switch Configuration

<b>S T E P #</b>	This procedure Configures the Cisco Switches on a Installed E5-APP-B EPAP Server Pair. Check off (✓) each step as it is completed. Boxes have been provided for this purpose under each step number. <b>IF THIS PROCEDURE FAILS, CONTACT MY ORACLE SUPPORT AND ASK FOR ASSISTANCE.</b>	
	<b>1.</b> <input type="checkbox"/> Make the cross-over cable connections.	<p style="text-align: center;"><b>NOTE: THIS IS IMPORTANT</b></p> <p>CONNECT the cross-over cable from <b>Port 1 of Switch1A</b> to <b>Port 1 of Switch1B</b>.</p> <p>DISCONNECT the cross-over cable from <b>Port 2 of Switch1A</b> to <b>Port 2 of Switch1B</b>.</p> <p><b>Similarly while Configuring Switch1C and Switch1D Disconnect the cable from port 24 and connect back post configuration done.</b></p> <p>Please make a note that the switch configuration should only be attempted by a skilled technician and not all.</p> <p>All uplinks should be removed while switch configuration.</p> <p>There should not be any loop in the switches during their configuration.</p> <p>Switch1B must be configured first.</p>
	<b>2.</b> <input type="checkbox"/> Do minicom to enter the cisco switch console. Command – “minicom switch1A” for the console cable connected to MPS-A and for console cable connected to MPS-B use “minicom switch1B”.	<pre>[root@Donut-B epapall]# [root@Donut-B epapall]# minicom switch1B</pre>
<b>3.</b> <input type="checkbox"/> <b>MPS X:</b> Do not enter in the initial config dialog in the freshly connected cisco switch.	<p style="text-align: center;"><b>Autoinstall will terminate if any input is detected on console</b></p> <p style="text-align: center;">--- System Configuration Dialog ---</p> <p style="text-align: center;">Would you like to enter the initial configuration dialog? [yes/no]:no</p>	

## Switch Configuration

<p>4. <input type="checkbox"/></p>	<p><b>MPS X:</b> Enter an Enable secret key :- "OracleSwitchC1"</p>	<p>The enable secret is a password used to protect access to privileged EXEC and configuration modes. This password, after entered, becomes encrypted in the configuration.</p> <p>-----</p> <p>secret should be of minimum 10 characters and maximum 32 characters with at least 1 upper case, 1 lower case, 1 digit and should not contain [cisco]</p> <p>-----</p> <p>Enter enable secret:OracleSwitchC1 Confirm enable secret: OracleSwitchC1</p>
<p>5. <input type="checkbox"/></p>	<p><b>MPS X:</b> Press 2 and enter</p>	<p>The following configuration command script was created:</p> <pre>enable secret 9 \$9\$TsBinkhqCyICKE\$.kvHrY3IJTaqJEb.T9yJjjmzCRsu426mSirX4U3a1k ! end</pre> <p>[0] Go to the IOS command prompt without saving this config. [1] Return back to the setup without saving this config. [2] Save this configuration to nvram and exit. Enter your selection [2]: 2</p>
<p>6. <input type="checkbox"/></p>	<p><b>MPS X:</b> Initial configuration building done.</p>	<p>Building configuration... [OK]</p> <p>Use the enabled mode 'configure' command to modify this configuration.</p> <p>Press RETURN to get started!</p>
<p>7. <input type="checkbox"/></p>	<p><b>MPS X:</b> Write "enable" and password set in step 3 which is "OracleSwitchC1"</p>	<p>Switch&gt;enable Password:</p>
<p>8. <input type="checkbox"/></p>	<p><b>MPS X:</b> Once the switch is enabled to take configuration &gt; sign changes to the # sign</p>	<p>Switch&gt;enable Password: Password: Switch#</p>

## Switch Configuration

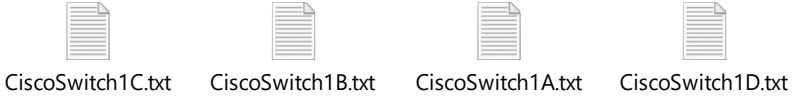
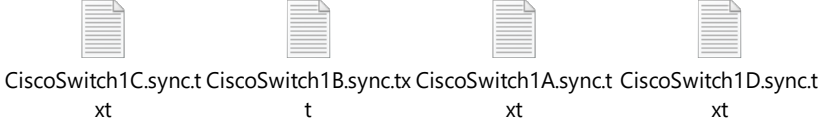
9. <input type="checkbox"/>	<b>MPS X: Write command – “Configure terminal”</b>	switch# configure terminal Enter configuration commands, one per line. End with CNTL/Z. switch(config)#
10. <input type="checkbox"/>	<b>MPS X: Here are the attached configs to be used for Eth04 used for Backup Provisioning Network</b>	 <p>CiscoSwitch1C.txt   CiscoSwitch1B.txt   CiscoSwitch1A.txt   CiscoSwitch1D.txt</p>
11. <input type="checkbox"/>	<b>MPS X: Here are the attached configs to be used for EPAP Sync Network Redundancy (Eth04 used for Sync Network).</b>	 <p>CiscoSwitch1C.sync.txt   CiscoSwitch1B.sync.txt   CiscoSwitch1A.sync.txt   CiscoSwitch1D.sync.txt</p>
12. <input type="checkbox"/>	<b>MPS X: Open the attached config in notepad for the switch we want to configure.</b>	Open in notepad and press Ctrl+A and then Ctrl+C
13. <input type="checkbox"/>	<b>MPS X: Paste all the copied config to the switch. Shown example for Switch1A.</b>	<pre>Switch# configure terminal Enter configuration commands, one per line. End with CNTL/Z. Switch(config)#hostname switch1A switch1A(config)#enable secret EnAbLe switch1A(config)# switch1A(config)#\$estamps log datetime msec localtime show-timezone switch1A(config)#no service pad switch1A(config)#service timestamps debug uptime switch1A(config)#service timestamps log uptime switch1A(config)#service password-encryption switch1A(config)#no logging console switch1A(config)#logging on switch1A(config)#logging trap errors switch1A(config)#logging facility local6 switch1A(config)#line console 0</pre>

## Switch Configuration

```
switch1A(config-line)#length 0
switch1A(config-line)#exit
switch1A(config)#
switch1A(config)#clock timezone gmt-5 -5 00
switch1A(config)#
switch1A(config)#
switch1A(config)#vlan 1
switch1A(config-vlan)# name default
switch1A(config-vlan)# exit
switch1A(config)#
switch1A(config)#vlan 2
switch1A(config-vlan)# name dsm-a
switch1A(config-vlan)# exit
switch1A(config)#interface vlan 1
switch1A(config-if)#ip address 192.168.2.1 255.255.255.0
switch1A(config-if)#no shutdown
switch1A(config-if)#exit
switch1A(config)#
switch1A(config)#interface gigabitEthernet1/0/1
switch1A(config-if)# switchport mode trunk
switch1A(config-if)#switchport trunk allowed vlan add 1
switch1A(config-if)#switchport trunk allowed vlan add 2
switch1A(config-if)# channel-group 1 mode on
Creating a port-channel interface Port-channel 1

switch1A(config-if)# description Link_to_Switch B
switch1A(config-if)#shutdown
switch1A(config-if)#no shutdown
switch1A(config-if)#
switch1A(config-if)#interface gigabitEthernet1/0/2
switch1A(config-if)# switchport mode trunk
switch1A(config-if)#switchport trunk allowed vlan add 1
switch1A(config-if)#switchport trunk allowed vlan add 2
switch1A(config-if)# channel-group 1 mode on
switch1A(config-if)# description Link_to_Switch B
switch1A(config-if)#shutdown
switch1A(config-if)#no shutdown
switch1A(config-if)#
switch1A(config-if)#interface gigabitEthernet1/0/3
switch1A(config-if)# switchport mode access
```

## Switch Configuration

```
switch1A(config-if)# switchport access vlan 2
switch1A(config-if)# description EPAP_A DSM A
switch1A(config-if)# flowcontrol receive on
switch1A(config-if)#shutdown
switch1A(config-if)#no shutdown
switch1A(config-if)#
switch1A(config-if)#interface gigabitEthernet1/0/4
switch1A(config-if)# switchport mode access
switch1A(config-if)# switchport access vlan 2
switch1A(config-if)# description EPAP_B DSM A
switch1A(config-if)# flowcontrol receive on
switch1A(config-if)#shutdown
switch1A(config-if)#no shutdown
switch1A(config-if)#
switch1A(config-if)#interface gigabitEthernet1/0/5
switch1A(config-if)# switchport mode access
switch1A(config-if)# switchport access vlan 2
switch1A(config-if)# description EAGLE_A_port
switch1A(config-if)# duplex full
switch1A(config-if)#speed 1000
switch1A(config-if)#shutdown
switch1A(config-if)#no shutdown
switch1A(config-if)#
switch1A(config-if)#interface gigabitEthernet1/0/6
switch1A(config-if)# switchport mode access
switch1A(config-if)# switchport access vlan 2
switch1A(config-if)# description EAGLE_A_port
switch1A(config-if)# duplex full
switch1A(config-if)#speed 1000
switch1A(config-if)#shutdown
switch1A(config-if)#no shutdown
switch1A(config-if)#
switch1A(config-if)#interface gigabitEthernet1/0/7
switch1A(config-if)# switchport mode access
switch1A(config-if)# switchport access vlan 2
switch1A(config-if)# description EAGLE_A_port
switch1A(config-if)# duplex full
switch1A(config-if)#speed 1000
switch1A(config-if)#shutdown
switch1A(config-if)#no shutdown
```

## Switch Configuration

```
switch1A(config-if)#
switch1A(config-if)#interface gigabitEthernet1/0/8
switch1A(config-if)# switchport mode access
switch1A(config-if)# switchport access vlan 2
switch1A(config-if)# description EAGLE_A_port
switch1A(config-if)# duplex full
switch1A(config-if)#speed 1000
switch1A(config-if)#shutdown
switch1A(config-if)#no shutdown
switch1A(config-if)#
switch1A(config-if)#interface gigabitEthernet1/0/9
switch1A(config-if)# switchport mode access
switch1A(config-if)# switchport access vlan 2
switch1A(config-if)# description EAGLE_A_port
switch1A(config-if)# duplex full
switch1A(config-if)#speed 1000
switch1A(config-if)#shutdown
switch1A(config-if)#no shutdown
switch1A(config-if)#
switch1A(config-if)#interface gigabitEthernet1/0/10
switch1A(config-if)# switchport mode access
switch1A(config-if)# switchport access vlan 2
switch1A(config-if)# description EAGLE_A_port
switch1A(config-if)# duplex full
switch1A(config-if)#speed 1000
switch1A(config-if)#shutdown
switch1A(config-if)#no shutdown
switch1A(config-if)#
switch1A(config-if)#interface gigabitEthernet1/0/11
switch1A(config-if)# switchport mode access
switch1A(config-if)# switchport access vlan 2
switch1A(config-if)# description EAGLE_A_port
switch1A(config-if)# duplex full
switch1A(config-if)#speed 1000
switch1A(config-if)#shutdown
switch1A(config-if)#no shutdown
switch1A(config-if)#
switch1A(config-if)#interface gigabitEthernet1/0/12
switch1A(config-if)# switchport mode access
switch1A(config-if)# switchport access vlan 2
```

## Switch Configuration

	<pre>switch1A(config-if)# description EAGLE_A_port switch1A(config-if)# duplex full switch1A(config-if)#speed 1000 switch1A(config-if)#shutdown switch1A(config-if)#no shutdown switch1A(config-if)# switch1A(config-if)#interface gigabitEthernet1/0/13 switch1A(config-if)# switchport mode access switch1A(config-if)# switchport access vlan 2 switch1A(config-if)# description EAGLE_A_port switch1A(config-if)# duplex full switch1A(config-if)#speed 1000 switch1A(config-if)#shutdown switch1A(config-if)#no shutdown switch1A(config-if)# switch1A(config-if)#interface gigabitEthernet1/0/14 switch1A(config-if)# switchport mode access switch1A(config-if)# switchport access vlan 2 switch1A(config-if)# description EAGLE_A_port switch1A(config-if)# duplex full switch1A(config-if)#speed 1000 switch1A(config-if)#shutdown switch1A(config-if)#no shutdown switch1A(config-if)# switch1A(config-if)#interface gigabitEthernet1/0/15 switch1A(config-if)# switchport mode access switch1A(config-if)# switchport access vlan 2 switch1A(config-if)# description EAGLE_A_port switch1A(config-if)# duplex full switch1A(config-if)#speed 1000 switch1A(config-if)#shutdown switch1A(config-if)#no shutdown switch1A(config-if)# switch1A(config-if)#interface gigabitEthernet1/0/16 switch1A(config-if)# switchport mode access switch1A(config-if)# switchport access vlan 2 switch1A(config-if)# description EAGLE_A_port switch1A(config-if)# duplex full switch1A(config-if)#speed 1000 switch1A(config-if)#shutdown</pre>
--	---

## Switch Configuration

```
switch1A(config-if)#no shutdown
switch1A(config-if)#
switch1A(config-if)#interface gigabitEthernet1/0/17
switch1A(config-if)# switchport mode access
switch1A(config-if)# switchport access vlan 2
switch1A(config-if)# description EAGLE_A_port
switch1A(config-if)# duplex full
switch1A(config-if)#speed 1000
switch1A(config-if)#shutdown
switch1A(config-if)#no shutdown
switch1A(config-if)#
switch1A(config-if)#interface gigabitEthernet1/0/18
switch1A(config-if)# switchport mode access
switch1A(config-if)# switchport access vlan 2
switch1A(config-if)# description EAGLE_A_port
switch1A(config-if)# duplex full
switch1A(config-if)#speed 1000
switch1A(config-if)#shutdown
switch1A(config-if)#no shutdown
switch1A(config-if)#
switch1A(config-if)#interface gigabitEthernet1/0/19
switch1A(config-if)# switchport mode access
switch1A(config-if)# switchport access vlan 2
switch1A(config-if)# description EAGLE_A_port
switch1A(config-if)# duplex full
switch1A(config-if)#speed 1000
switch1A(config-if)#shutdown
switch1A(config-if)#no shutdown
switch1A(config-if)#
switch1A(config-if)#interface gigabitEthernet1/0/20
switch1A(config-if)# switchport mode access
switch1A(config-if)# switchport access vlan 2
switch1A(config-if)# description EAGLE_A_port
switch1A(config-if)# duplex full
switch1A(config-if)#speed 1000
switch1A(config-if)#shutdown
switch1A(config-if)#no shutdown
switch1A(config-if)#
switch1A(config-if)#interface gigabitEthernet1/0/21
switch1A(config-if)# switchport mode access
```

## Switch Configuration

```
switch1A(config-if)# switchport access vlan 2
switch1A(config-if)# description EAGLE_A_port
switch1A(config-if)# duplex full
switch1A(config-if)#speed 1000
switch1A(config-if)#shutdown
switch1A(config-if)#no shutdown
switch1A(config-if)#
switch1A(config-if)#interface gigabitEthernet1/0/22
switch1A(config-if)# switchport mode access
switch1A(config-if)# switchport access vlan 2
switch1A(config-if)# description EAGLE_A_port
switch1A(config-if)# duplex full
switch1A(config-if)#speed 1000
switch1A(config-if)#shutdown
switch1A(config-if)#no shutdown
switch1A(config-if)#
switch1A(config-if)#interface gigabitEthernet1/0/23
switch1A(config-if)# switchport mode trunk
switch1A(config-if)#switchport trunk allowed vlan add 1
switch1A(config-if)#switchport trunk allowed vlan add 2
switch1A(config-if)# channel-group 2 mode on
Creating a port-channel interface Port-channel 2

switch1A(config-if)# description Link_to_Switch C
switch1A(config-if)#shutdown
switch1A(config-if)#no shutdown
switch1A(config-if)#
switch1A(config-if)#interface gigabitEthernet1/0/24
switch1A(config-if)# switchport mode trunk
switch1A(config-if)#switchport trunk allowed vlan add 1
switch1A(config-if)#switchport trunk allowed vlan add 2
switch1A(config-if)# channel-group 2 mode on
switch1A(config-if)# description Link_to_Switch C
switch1A(config-if)#shutdown
switch1A(config-if)#no shutdown
switch1A(config-if)#
switch1A(config-if)#
switch1A(config-if)#no ip http server
switch1A(config)#
switch1A(config)#no cdp run
```

## Switch Configuration

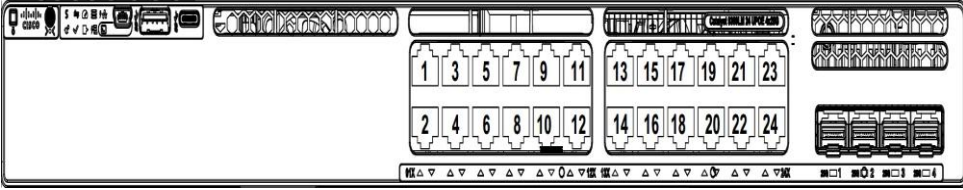
		<pre> switch1A(config)# switch1A(config)#line con 0 switch1A(config-line)# password CONSOLE switch1A(config-line)# login switch1A(config-line)#line vty 0 4 switch1A(config-line)#transport input telnet ssh switch1A(config-line)#password CONSOLE switch1A(config-line)# login switch1A(config-line)#line vty 5 15 switch1A(config-line)#transport input telnet ssh switch1A(config-line)#password CONSOLE switch1A(config-line)# login switch1A(config-line)# switch1A(config-line)# switch1A(config-line)#ntp server 192.168.2.100 switch1A(config)# switch1A(config)#logging host 192.168.2.100 switch1A(config)# switch1A(config)#end switch1A# </pre>
<p>14. <input type="checkbox"/></p>	<p><b>MPS X:</b> Similarly need to configure all other connected cisco switches.</p>	<p>Used the config attached in step 10. And repeat steps 2-12, Make sure to select the exact same config from the 10<sup>th</sup> step , as per the switch location.</p>
<p>15. <input type="checkbox"/></p>	<p>Connect the cross-over cable from <b>Port 2 of Switch1A</b> to <b>Port 2 of Switch1B</b>.</p>	
<p>16. <input type="checkbox"/></p>	<p>Ping to Confirm connectivity.</p> <p>Note: Ip address 192.168.2.1 associated with Switch1A , ip address 192.168.2.2 associated with Switch1B , ip address 192.168.2.3 with Switch1C and ip address 192.168.2.4 with Switch1D.</p>	<p>Ping from all the newly connected switches to the mentioned IP address (192.168.2.1, 192.168.2.2, 192.168.2.3, 192.168.2.4, 192.168.2.100, 192.168.2.200), till you see an 100% success rate.</p> <pre> switch1D#ping 192.168.2.1 Sending 5, 100-byte ICMP Echoes to 192.168.2.1, timeout 2 sec, delay 0 sec: Press Esc for break !!!! Success rate is 100 percent (5/5), round-trip min/avg/max = 0/0/0 ms switch1D#ping 192.168.2.2 Sending 5, 100-byte ICMP Echoes to 192.168.2.2, timeout 2 sec, delay 0 sec: </pre>

## Switch Configuration

		<pre> Press Esc for break !!!! Success rate is 100 percent (5/5), round-trip min/avg/max = 0/0/0 ms switch1D#ping 192.168.2.3 Sending 5, 100-byte ICMP Echoes to 192.168.2.3, timeout 2 sec, delay 0 sec: Press Esc for break !!!! Success rate is 100 percent (5/5), round-trip min/avg/max = 0/0/0 ms switch1D#ping 192.168.2.4 Sending 5, 100-byte ICMP Echoes to 192.168.2.4, timeout 2 sec, delay 0 sec: Press Esc for break !!!! Success rate is 100 percent (5/5), round-trip min/avg/max = 0/0/0 ms switch1D#ping 192.168.2.100 Sending 5, 100-byte ICMP Echoes to 192.168.2.100, timeout 2 sec, delay 0 sec: Press Esc for break !!!! Success rate is 100 percent (5/5), round-trip min/avg/max = 0/1/5 ms switch1D#ping 192.168.2.200 Sending 5, 100-byte ICMP Echoes to 192.168.2.200, timeout 2 sec, delay 0 sec: Press Esc for break !!!! Success rate is 100 percent (5/5), round-trip min/avg/max = 0/0/0 ms switch1D# </pre>
17. <input type="checkbox"/>	Procedure complete.	Procedure is complete.



## APPENDIX E CUSTOMER SIGN OFF

### Sign-Off Record

**\*\*\* Please review this entire document. \*\*\***

This is to certify that all steps required for the upgrade successfully completed without failure.

Sign your name, showing approval of this procedure, and email this page and the above completed Table to Oracle, email: [upgrades@tekelec.com](mailto:upgrades@tekelec.com).

**Customer: Company Name:** \_\_\_\_\_ **Date:** \_\_\_\_\_

**Site: Location:** \_\_\_\_\_

**Customer :(Print)** \_\_\_\_\_ **Phone:** \_\_\_\_\_

**Fax:** \_\_\_\_\_

**Start Date:** \_\_\_\_\_

**Completion Date:** \_\_\_\_\_

This procedure has been approved by the undersigned. Any deviations from this procedure must be approved by both Oracle and the customer representative. A copy of this page should be given to the customer for their records. The SWOPS supervisor will also maintain a signed copy of this completion for future reference.

**Oracle Signature:** \_\_\_\_\_ **Date:** \_\_\_\_\_

**Customer Signature:** \_\_\_\_\_ **Date:** \_\_\_\_\_

## APPENDIX F MAJOR CHANGES IN EPAP 17.0

In EPAP Release 17.0, live provisioning is supported for upgrade of DUAL PDB site that is where Active and Standby PDB are present in the form of PDBOnly EPAP or Mixed-EPAP.

**Note: In case of Dual PDBOnly when Standby PDBA is successfully upgraded, connected and in sync with all the other nodes, perform switchover between Active Pdba and Standby Pdba.**

Following steps will be taken to support live provisioning:

1. Bring both PDBOnly/Mixed-EPAP to same label, Check all counts (DN/IMSI/NE ...) are same. Stop provisioning briefly for 5 minutes to achieve the same.
2. Truncate the replLog and requests table. For more information, see step 6 of section A.26.
3. On the Active side keep the remote PDBA as it is i.e. Active PDBA has a remote PDBA. This will make sure replLog and request tables keeps updated when live provisioning will happen in the Active site during Standby side upgrade.
4. On the Standby side, make the remote PDBA as 0.0.0.0 i.e. Standby site does not have an Active PDBA. This is the site that will be upgraded.
5. Home the Non-PROVs to the Active PDBA.
6. Home the RTDB on Mixed EPAP towards its local PDBA  
**Note:** This step is not valid for Non-Prov and PDBOnly sites.
7. Upgrade the Standby PDBA from 16.3/16.4 to 17.1.
8. After the upgrade of Standby PDB is complete, change the remote PDBA address of Standby from 0.0.0.0 to the IP of Active PDBA. Start PDBA.
9. See that Standby PDBA syncs all the data from Active PDBA that was provisioned during upgrade.

**Note:** This Appendix is for reference only. Details mentioned in this Appendix are applied in [section 3.4.3](#) and [section 3.4.5](#).

