

General Ledger User Guide

**Oracle Banking Current and Savings
Account Cloud Service**

Release 14.8.2.0.0

Part No. G55336-01

April 2026

General ledger User Guide
Oracle Banking Current and Savings Account Cloud Services

Release 14.8.2.0.0

Copyright © 2021, 2026, Oracle and/or its affiliates.

This software and related documentation are provided under a license agreement containing restrictions on use and disclosure and are protected by intellectual property laws. Except as expressly permitted in your license agreement or allowed by law, you may not use, copy, reproduce, translate, broadcast, modify, license, transmit, distribute, exhibit, perform, publish, or display any part, in any form, or by any means. Reverse engineering, disassembly, or decompilation of this software, unless required by law for interoperability, is prohibited.

The information contained herein is subject to change without notice and is not warranted to be error-free. If you find any errors, please report them to us in writing.

If this is software, software documentation, data (as defined in the Federal Acquisition Regulation), or related documentation that is delivered to the U.S. Government or anyone licensing it on behalf of the U.S. Government, then the following notice is applicable:

U.S. GOVERNMENT END USERS: Oracle programs (including any operating system, integrated software, any programs embedded, installed, or activated on delivered hardware, and modifications of such programs) and Oracle computer documentation or other Oracle data delivered to or accessed by U.S. Government end users are "commercial computer software," "commercial computer software documentation," or "limited rights data" pursuant to the applicable Federal Acquisition Regulation and agency-specific supplemental regulations. As such, the use, reproduction, duplication, release, display, disclosure, modification, preparation of derivative works, and/or adaptation of i) Oracle programs (including any operating system, integrated software, any programs embedded, installed, or activated on delivered hardware, and modifications of such programs), ii) Oracle computer documentation and/or iii) other Oracle data, is subject to the rights and limitations specified in the license contained in the applicable contract. The terms governing the U.S. Government's use of Oracle cloud services are defined by the applicable contract for such services. No other rights are granted to the U.S. Government.

This software or hardware is developed for general use in a variety of information management applications. It is not developed or intended for use in any inherently dangerous applications, including applications that may create a risk of personal injury. If you use this software or hardware in dangerous applications, then you shall be responsible to take all appropriate fail-safe, backup, redundancy, and other measures to ensure its safe use. Oracle Corporation and its affiliates disclaim any liability for any damages caused by use of this software or hardware in dangerous applications.

Oracle®, Java, MySQL, and NetSuite are registered trademarks of Oracle and/or its affiliates. Other names may be trademarks of their respective owners. Intel and Intel Inside are trademarks or registered trademarks of Intel Corporation. All SPARC trademarks are used under license and are trademarks or registered trademarks of SPARC International, Inc. AMD, Epyc, and the AMD logo are trademarks or registered trademarks of Advanced Micro Devices. UNIX is a registered trademark of The Open Group.

This software or hardware and documentation may provide access to or information about content, products, and services from third parties. Oracle Corporation and its affiliates are not responsible for and expressly disclaim all warranties of any kind with respect to third-party content, products, and services unless otherwise set forth in an applicable agreement between you and Oracle. Oracle Corporation and its affiliates will not be responsible for any loss, costs, or damages incurred due to your access to or use of third-party content, products, or services, except as set forth in an applicable agreement between you and Oracle.

Contents

1. Preface	1-1
1.1 Introduction.....	1-1
1.2 Audience.....	1-1
1.3 Documentation Accessibility.....	1-1
1.4 Critical Patches.....	1-1
1.5 Organization	1-1
1.6 Related Documents	1-2
1.7 Glossary of Icons.....	1-2
2. General Ledger - An Overview	2-1
2.1 Introduction.....	2-1
2.2 Features of GL Sub-system.....	2-1
2.3 Need to Invoke GL Sub-system.....	2-2
3. Setting up Chart of Accounts	3-1
3.1 Chart of Account Maintenance	3-1
3.1.1 <i>Maintaining Chart of Account</i>	3-2
3.1.2 <i>GL Details Tab</i>	3-3
3.1.3 <i>GL Linkages Tab</i>	3-11
3.1.4 <i>GL Lines Tab</i>	3-12
3.1.5 <i>Other GL Linked to this Parent Button</i>	3-14
3.1.6 <i>Statement Button</i>	3-17
3.1.7 <i>IBAN Account Number Button</i>	3-20
3.1.8 <i>Position GL Maintenance Button</i>	3-20
3.1.9 <i>BIC Button</i>	3-21
3.1.10 <i>Viewing Chart of Accounts Maintenance Details</i>	3-22
3.2 Reposting of FCY Entries for Realized P&L GLs in LCY.....	3-23
4. Maintaining Reporting Line Structure	4-1
4.1 Reporting Line	4-1
4.1.1 <i>Maintaining Reporting Line</i>	4-1
5. Defining Alternate Reporting Lines	5-1
5.1 Alternate Reporting Line.....	5-1
5.1.1 <i>Maintaining Alternate Reporting Line</i>	5-1
5.2 GL Central Bank Line Linkage Maintenance	5-2
5.2.1 <i>Linking GL to CB Line</i>	5-2
5.2.2 <i>Operations on GL Code to CB Line Linkage Record</i>	5-3
5.3 GL MIS Linkages.....	5-3
5.3.1 <i>Linking GL to MIS Class</i>	5-3
5.3.2 <i>Operations on GL MIS Linkages Record</i>	5-4
6. GL Report Classification on MIS Class	6-1
6.1 MIS Class Maintenance.....	6-2
6.1.1 <i>Maintaining MIS Class</i>	6-2
6.1.2 <i>Saving the record</i>	6-3
6.2 General Ledger Branch Parameters.....	6-3
6.2.1 <i>Maintaining GL Branch Parameters</i>	6-3

6.3	General Ledger Class Maintenance	6-5
6.3.1	<i>Maintaining GL Class</i>	6-5
7.	Maintaining GL Balance Transfer	7-1
7.1	GL Balance Transfer Maintenance.....	7-1
7.1.1	<i>Maintaining GL Balance Transfer Details</i>	7-1
7.2	Balance Transfer Batch GL	7-2
7.2.1	<i>Querying GL Balances</i>	7-2
8.	Error Codes and Messages	8-1
9.	Glossary	9-1
9.1	General Ledger Terms	9-1
10.	Function ID Glossary	10-1

1. Preface

1.1 Introduction

This Manual is designed to help you quickly get acquainted with the General Ledger (GL) sub-system of Oracle Banking Current and Savings Account Cloud Service.

It provides an overview to the module and takes you through the various steps involved in setting up a GL structure and reporting details of the GLs maintained at your bank.

This user manual is a supplement to the Common Core - Core Entities and Services User Manual and contains only specific functionalities and information related to Oracle FCUBS General Ledger. Hence, this document should be read in conjunction with the Common Core - Core Entities and Services User Manual from the perspective of completeness in flow and understanding.

You can further obtain information specific to a particular field by placing the cursor on the relevant field and striking <F1> on the keyboard.

1.2 Audience

This manual is intended for the following User/User Roles:

Role	Function
Operations	To define the GL structure
Operations Managers/Officers	Authorization functions
Financial Control	To generate reports on GLs
MIS Operators	Generation of reports

1.3 Documentation Accessibility

For information about Oracle's commitment to accessibility, visit the Oracle Accessibility Program website at <http://www.oracle.com/pls/topic/lookup?ctx=acc&id=docacc>.

1.4 Critical Patches

Oracle advises customers to get all their security and vulnerability information from the Oracle Critical Patch Update Advisory, which is available at [Critical Patches, Security Alerts and Bulletins](#). All critical patches should be applied in a timely manner to ensure effective security, as strongly recommended by [Oracle Software Security Assurance](#).

1.5 Organization

This Manual is organized into the following chapters:

Chapter	Description
Chapter 1	<i>About this Manual</i> gives information on the intended audience. It also lists the various chapters covered in this User Manual.





Chapter 2	<i>General Ledger - An Overview</i> is a snapshot of the features and functionality that the module provides.
Chapter 3	<i>Setting up Chart of Accounts</i> details the procedure to set up a GL structure for your bank.
Chapter 4	<i>Maintaining Reporting Line Structure</i> describes the procedure for defining an alternate reporting structure for your Head Office and Central bank.
Chapter 5	<i>Defining Alternate Reporting Lines</i> deals with the setting up of alternate reporting lines for GLs when a branch is located abroad.
Chapter 6	<i>GL Report Classification on MIS Class</i> gives details on reports that be generated based on MIS classes.
Chapter 7	<i>Enterprise GL Integration</i> deals with extraction of accounting data from Oracle Banking Current and Savings Account Cloud Service core GL system and mapping of the same to an enterprise GL external to the system.
Chapter 8	<i>Maintaining GL Balance Transfer</i> explains about the process of maintaining sweep instructions for transferring balance from branch "Stamp duty payable GL" to the head office GL.
Chapter 9	<i>Error Codes and Messages for General Ledger</i> deals with the various error codes and messages that can be generated for the GL module.
Chapter 10	<i>Glossary</i> defines the terms used in this manual.
Chapter 11	<i>Function ID Glossary</i> has alphabetical listing of Function/Screen ID's used in the module with page references for quick navigation.

1.6 Related Documents

- Procedures User Manual
- Operations User Manual
- Core Services User Manual
- Core Entities User Manual
- Common Core - Core Entities and Services User Manual

1.7 Glossary of Icons

This User Manual may refer to all or some of the following icons.

Icons	Function
	Exit
	Add row
	Delete row
	Option List

2. General Ledger - An Overview

2.1 Introduction

The General Ledger (GL) sub-system is the pillar on which the various functional components of Oracle Banking Current and Savings Account Cloud Service rest. Through this single entity, you can consolidate and maintain balances and turnovers of all types of accounts your bank holds. In addition, the module enables you to retrieve on-line information on the GLs maintained for your bank.

In Oracle Banking Current and Savings Account Cloud Service, GLs have been structurally fashioned as a tree, bearing a multi-level structure (like a tree's main branch and sub-branches). On the head stands the Head GL that does not report to any other GL. The subsequent levels consist of Nodes and Leaves. A Node GL is one that reports to another GL and has other GLs reporting to it. A Leaf GL is one that reports to another GL but does not have any GL reporting to it.

The number of levels in the tree structure, and the various constituents of the head, nodes, and leaves have been left open to your choice, the only restriction being that a report will be restricted to the number of levels that a 132-column paper can hold.

The GL structure for your bank has to be created at the bank level and maintained by different branches. Using this structure, you can consolidate the GL balances and turnovers across modules and products and retrieve on-line information on the same.

This chapter contains the following sections:

- [Section 2.2, "Features of GL Sub-system"](#)
- [Section 2.3, "Need to Invoke GL Sub-system"](#)

2.2 Features of GL Sub-system

Flexible GL structure

Keeping in mind the different type of accounts maintained in your bank, GL has been broadly classified into the following categories:

- Asset
- Liability
- Expense
- Income
- Contingent Asset
- Contingent Liability
- Memo
- Position
- Position Equivalent

A Head GL can be assigned any of the above categories. Two Head GLs can have the same category. All GLs that fall under a Head GL will essentially belong to the category defined for the Head. Each category can have any number of GLs under it, but the category allocated to a GL should be assigned at the **head** of any GL stream. All **nodes and leaves** by default take the category of the Head GL to which they report. At no other level can you assign a category.

Leaf GLs are merely points of contact through which all entries are passed to the nodes. It is at the nodes that consolidation of all accounting takes place. Therefore, any specification like the Currency type or GL type though specified at the leaf GL will be applicable only for the respective node of that leaf. Peripheral activities like linking a customer account to a GL or posting to a GL can be done only at the leaf.

All your profit and loss entries can be passed in LCY only; however, for reporting purposes you can also maintain a record of these in any FCY or even in all currencies. This makes it possible to have multi-currency GLs. Along with this, revaluation of currencies has also been provided for.

Categorization into MIS Classes

The sub-system enables you to categorize information into MIS Classes, which are exclusively for reporting purposes. This feature serves not only your need for classified information, but also helps simplify the GL structure of the bank.

For instance, you can categorize information by the defined Customer/Transaction MIS Class. Under each type — Customer or Transaction you can create several MIS Classes and Sub-classes. This is done at the Bank level and used by the different branches.

Information Retrieval

You have been provided with various report definition options, so that you can tailor your report to suit your needs. In addition, the report generator helps you prepare reports in the format of the Head Office and Central Bank debit/credit lines, which may be at variance with the existing GL structure at the branch level.

Consolidation of GLs can take place at different branch levels. That is, at the Regional Office or Head Office levels depending upon the branch structure that you have defined in the Core Entities Module. The final consolidation of all GLs is done at the Head Office where the total consolidated GL is provided in a report. Even during consolidation, the break-up based on MIS Classes will be provided.

2.3 Need to Invoke GL Sub-system

You will need to invoke the General Ledger (GL) sub-system to:

- Maintain a General Ledger structure for your bank
- Avail of services provided by GL to different modules like EOD update of GL etc.
- Interface with the MIS System
- Set up Reporting lines and associate GLs to these debit and credit lines
- Specify break up of GLs by either customer or transaction MIS Class
- Run Year-end P/L account on book closure
- Extract reports on GL data history
- Obtain reports of General Ledgers for specific periods

3. Setting up Chart of Accounts

Oracle Banking Current and Savings Account Cloud Service supports a multilevel structure for your bank's Chart of Accounts. You can create broad groups of accounts in the categories of assets, liabilities, income, expenses, etc., and further divide these groups into several levels. The groups at each of these levels are referred to as GLs. For instance, you can create a three level GL structure as follows:

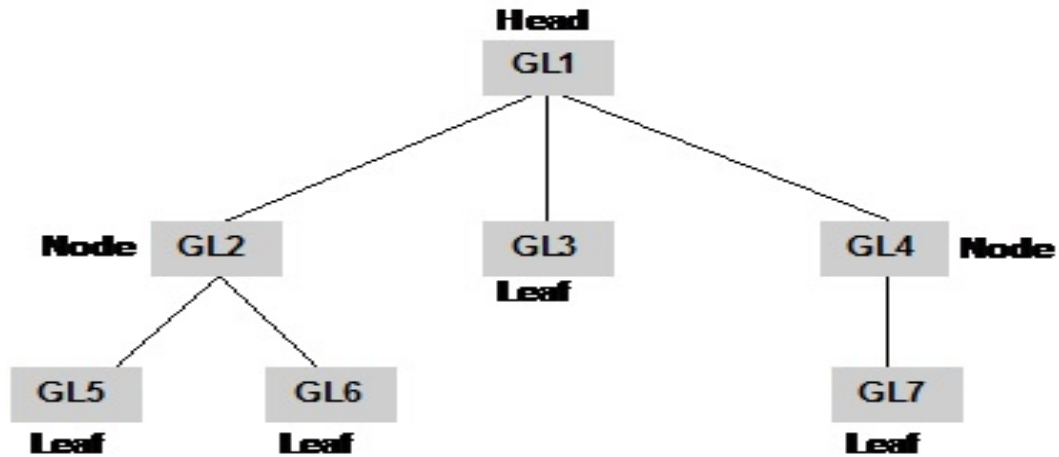

The GLs at the lowermost level are referred to as Leaf GLs. The balances and turnovers of leaf GLs are consolidated at higher level GLs called Node GLs. The GL at the top of the structure is referred to as the Head GL.

In the GL reporting hierarchy, a GL is a parent GL for GLs reporting to it. For instance, GL2 is the parent of GL 5 and 6, and GL1 is the parent GL for GLs 2, 3, and 4. The reporting GLs, GLs 5 and 6 in the first instance, are referred to as child GLs of GL 2. Similarly, GLs 2, 3, and 4 are child GLs with respect to GL1.

This multilevel GL structure can be maintained in the Chart of Accounts screen by the branch marked as the Head Office of your bank.

In Oracle Banking Current and Savings Account Cloud Service, the GL balances are stored as currency wise balances as well as overall balance in LCY on GL level. This enables currency-wise break up of each GL account. However overall balance in local currency is also available.

This chapter contains the following sections:

- [Section 3.1, "Chart of Account Maintenance"](#)
- [Section 3.2, "Reposting of FCY Entries for Realized P&L GLs in LCY"](#)

3.1 Chart of Account Maintenance

This section contains the following topics:

- [Section 3.1.1, "Maintaining Chart of Account"](#)
- [Section 3.1.2, "GL Details Tab"](#)
- [Section 3.1.3, "GL Linkages Tab"](#)
- [Section 3.1.4, "GL Lines Tab"](#)
- [Section 3.1.5, "Other GL Linked to this Parent Button"](#)
- [Section 3.1.6, "Statement Button"](#)

- [Section 3.1.7, "IBAN Account Number Button"](#)
- [Section 3.1.8, "Position GL Maintenance Button"](#)
- [Section 3.1.9, "BIC Button"](#)
- [Section 3.1.10, "Viewing Chart of Accounts Maintenance Details"](#)

3.1.1 Maintaining Chart of Account

You can invoke the 'Chart of Accounts Maintenance' screen by typing 'GLDCHACC' in the field at the top right corner of the Application tool bar and clicking the adjoining arrow button.

To define the details of a new GL, click new icon.

GL Code

In Oracle Banking Current and Savings Account Cloud Service, a GL is identified by a Code. The length and composition of the code depends upon the GL Mask defined in the 'Bank-wide Parameters' Screen. The code that you enter can have a maximum of nine alphanumeric characters.

External Code

Using External Code, you can upload the existing record into Oracle Banking Current and Savings Account Cloud Service, when the record is loaded for the first time. The old GL code will be defaulted as external code and you can enter new code and save it as well. External Code has to do nothing while entering new GL entries after installation of Oracle Banking Current and Savings Account Cloud Service.

Description

You can enter a brief description to help identify the GL in this field. You can use this description for the internal reference of your bank.

Alternate GL Code

Specify the Alternate GL code along with the GL code.

The system will check the GL nodes for its uniqueness and will not allow you to have more than one node GL with the same alternate GL code. Special characters are not allowed in alternate GL code. You can specify the alternate GL code only if ALTGLNO feature is enabled.

Leaf GL

In Oracle Banking Current and Savings Account Cloud Service, a GL that you create can be one of the following:

- Node GL
- Leaf GL

A Node GL is one that reports to another GL and has other GLs reporting to it. In the reporting relationship, if a GL reports to another GL, but no GLs report to it, then it is a Leaf GL. A *Head* GL is a Node that does not report to another GL.

The Chart of Accounts detailed screen is designed with *four tabs*. By invoking the screens that correspond with these tabs you can create GLs and maintain a GL structure of your bank.

- **GL Details** — In this screen, you can set up a GL, indicate its type, assign a category to the Head GL.
- **GL Linkages** — Click this tab to define the GLs that constitute your Chart of Accounts.
- **Reporting Lines** — In this screen, you can define the debit and credit reporting lines for leaf GLs. This helps to organize reports on the lines of your Head Office and Central Bank.

3.1.2 GL Details Tab

To define details for a GL, click on the tab titled GL Details. The details that you can specify for a GL depend on the type of GL that you create. If a particular field is disabled, it means that the field is not relevant to the type of GL that you are creating.

Chart of Accounts Maintenance

New Enter Query

GL Code *

General Ledger *
Description

Alternate GL Code
External Code

Leaf Leaf GL
 Node GL

GL Details GL Linkages GL Lines

Revaluation
Report As Accrual
Average Bal Required

Customer/Internal GL Customer GL
 Internal GL

GL Type
Category

Blocked
Transfer Balance on MIS
Reclassification
Revaluation Split Required

DNI Revaluation Details Position Accounting Details Currency Restrictions

Statement Position GL Maintenance MIS Group Linkage IBAN Account Number Other GL Linked to This Parent Child General Ledgers Fields Audit Exit

You can capture the GL Details in the following fields:

GL Type

For both customer and internal GLs that you create, you should indicate the type. The GL type is indicative of the type of accounting entries that are posted into the GL. For a customer GL, the GL type could be Normal, Misc. Debit, Misc. Credit, and Nostro. For an Internal GL, the GL type could be Normal, Misc. Debit, misc. Credit, cash, and inter-branch.

Those GLs in which a debit entry is to be offset with multiple credit entries or a credit entry to be offset with multiple debit entries should be assigned the Misc. Debit and Misc. Credit type respectively.

Miscellaneous debit and credit entries should be associated with an instrument number. This will ensure proper reconciliation of the debit and credit entries made to the GL. Choose this option to indicate that the GL should cater only to entries related to your bank's account with another bank. All cash transactions, like in the Data Entry module, are posted directly into a GL by linking the GL with the Till ID. Choose this option to indicate that only interbranch related accounting entries can be posted to the GL.

The debit or credit entries of accounts that do not fall into any of the other types can be assigned to the Normal Type GL. The leaf GLs that you create will be taken as Normal Type by default.

GL Category

GL category can be specified only for a GL head. A Head GL can be assigned any of the following categories:

- Asset
- Liability
- Expense
- Income
- Contingent Asset
- Contingent Liability
- Memo
- Position
- Position Equivalent

Two Head GLs can have the same category. All GLs that fall under a Head GL will essentially belong to the category defined for the Head. Each category can have any number of GLs under it. But, the category allocated to a GL should be assigned at the **head** of any GL stream; all **nodes and leaves** by default take the category of the Head GL to which they report.

Customer/Internal GL

A GL that you create in Oracle Banking Current and Savings Account Cloud Service can be defined as a *Customer* or an *Internal* GL. Internal GLs are accounts that are internal to the bank, such as cash accounts, interest income and expense accounts, and so on. These also comprise of customer account balances from the front-end modules - Loans, Deposits, Money Market, etc. The customer savings, current, and nostro accounts of your bank are opened under GLs designated as customer GLs.

The GL combinations that you can have include:

GL type	Direct posting of entries
Internal Node	No
Customer Node	No
Internal Leaf	Yes
Customer Leaf	No

As indicated above, you can post direct entries (i.e., link it to your bank's internal accounts) only to internal leaf GLs. For internal and customer node GLs and customer leaf GLs, you would associate accounts with them.

Avg Bal Required

Oracle Banking Current and Savings Account Cloud Service will compute and store average balances for customer GLs on a daily basis. However, the average balance computation is performed on the basis of transaction dated balance and any value dated adjustment will not be considered for this computation.

If a working day is followed by any holiday(s), the average balance computation will be done as per the specifications defined in the GL Branch Parameter Maintenance screen. That is, the balance will either include the accumulated balance for the number of days inclusive of the following holidays or the system will compute the balance on the next working day.

Note

The system will compute and store average balances for customer GLs only if you select the Avg Bal Required option. You will not be allowed to modify this option at a later date. The balances will be computed on a daily basis and will be based only on booking dated transactions.

The system will store debit, credit and net average balances in FCY as well as in LCY.

Note

In the case of back dated transactions, the system will not update the average balances of previous periods.

You can query the average balances of customer GLs in the GL Average Balances screen. The query can be done using the following, either individually or in combination:

- GL Code
- Currency Code
- Branch
- Financial Year
- Period Code

Note

- The computation can be enabled only for internal leaf GLs. If you enable this option the system will compute average balance for GLs as part of EOD processing. The average balance will be computed on the Book-Dated balance. The Debit, Credit and Net average balances in FCY as well as LCY will be stored.
- Back-period entries do not affect average balance retrospectively.
- Computation includes the effect of revaluation entries and fin-closure entries.
- Data is stored and displayed as Period-to-Date and Year-to-Date figures.
- Computation can be based on the Next Working Day-1 or System Date as specified in the GL Branch Parameters screen. If the average balance calculation basis is 'NWD-1', the balances of holidays will be included in the previous working day. If the calculation basis is System Date, the balances of holidays will be included on the next working day provided the next working day is in the same period. If the ba-

sis is System Date but the next working day is in the next period, the holidays will be considered during the current run.

Report As Accrual

Check against this field if you want the system to calculate the accrual entries posted to this GL independently for displaying during the online query of FX positions. Depending on your selection in this field, system will arrive at the cash and accrual positions.

Revaluation

Specify whether currency revaluation is applicable to the GL. Check against the Revaluation option to indicate that the GL should be revalued. Leave it unchecked to indicate otherwise.

You can revalue the balances of asset, liability, contingent asset, and contingent liability GLs. You can also revalue the balances in Income / Expense GLs. If you indicate that revaluation is applicable, Oracle Banking Current and Savings Account Cloud Service will revalue the GL when the End of Day (EOD) process is run.

Note

If transaction entry happens on STANDARD rate then the system does not post any revaluation, even though you have enabled revaluation for the GL002C

Transfer Balance on MIS Reclassification

Indicate whether the MIS balances in the GL must be transferred, upon MIS reclassification, into the new MIS code.

A batch process performs the transfer of balances upon reclassification, for each GL for which this option has been set.

Blocked

Oracle Banking Current and Savings Account Cloud Service offers you the option to temporarily mark the status of the GL as Blocked. During this period, no entries can be passed into the GL. You can open a GL marked with blocked status by unchecking the blocked status box.

This feature is useful as you need not close the GL. Blocking is temporary whereas closure is permanent.

Reval Split Required

You can choose to break-up revaluation profit/loss for the GL you are defining into:

- Trading P&L – P&L due to revaluation of foreign currency transactions during the day.
- Revaluation P&L – P&L due to revaluation of opening balances (balances without current day's turnover).

The following example compares the accounting entries posted when you do not choose to split revaluation profit/loss and when you do.

Note

The revaluation splitting is done for revaluation-into GL's also.

Refer the chapter 'Account Revaluation Maintenance' in the Core Services User Manual for further details about revaluation.

3.1.2.1 **Indicating Profit and Loss Revaluation Details**

EOD Reval Of FCY Entries (Single Entry)

Journal entries that do not have an offset entry cannot be revalued using the EOD revaluation of FCY entries option. Enable this option if such journal entries are to be revalued.

EOD Reval Of FCY Entries (Entry Pair)

As part of the End of Day processes, before the account revaluation batch process executes on a given business day, the revaluation batch process for performing accounting entry-based revaluation for FCY entries in Income/Expense GLs is run.

This process performs entry-based revaluation for those Income/Expense GLs for which such revaluation has been indicated in the Chart of Accounts. You can enable this option to indicate that the entry wise revaluation of FCY entries posted during the day should be performed during the EOD processes, for each entry pair in the same FCY.

EOD Reval Of FCY Reversals

Enable this option if the revaluation of reversal entries has to be performed as part of the EOD processes. If you leave this box unchecked, the reversal entries will be posted with the Exchange Rate as of event date.

As mentioned earlier, if entry-based revaluation is indicated for a GL, the FCY Entries Revaluation batch, which executes before the normal revaluation batch, will perform the revaluation for the GL.

Refer the Entry-based Revaluation of Income/Expense GLs section for detailed information on the entry-based revaluation batch.

Repost FCY Entries in LCY

While defining Income or Expense type of Leaf GL's you can indicate whether FCY entries have to be reposted as LCY entries during the EOD processes by checking this option.

If you enable this option, you must trigger the GL Reporting Batch (ACIDPRVL) as part of the EOD processes to post FCY entries in LCY. While doing this you should consider the logical order of revaluation as well as intraday posting processes.

The exchange rate at which the original FCY entry was posted is used for reposting in LCY.

Refer the Reposting of FCY entries for Realized P&L GL's in LCY section for detailed information on the batch.

Note

The revaluation parameters that you set for a GL cannot be modified after it is authorized.

Intraday Posting GL

You can choose to post FCY income/expenses booked during the day into a balance sheet GL and have them transferred to the P & L GL after revaluation at the EOD exchange rate. Profit or loss due to this revaluation is posted in LCY equivalent with '0' FCY postings.

While defining an Income/Expense GL in the Chart of Accounts screen, you can specify an intra-day GL into which FCY entries posted into this GL are to be transferred. This designated Intraday GL should be of Asset/Liability type.

The option of specifying an intra-day GL is allowed only for Income/Expense GLs. Another pre-condition is that either or both of EOD Reval of FCY Entries options should be enabled.

Given below is an example that illustrates the entries that are posted if you choose to post income/expense entries into an intra-day GL.

Processing features

- You need to run a batch process at EOD from the following functions:
 - Revaluation of the entry/entries posted into the intra-day GL using the EOD exchange rate.
 - Moving the intra-day GL balances into the actual income/expense GLs.
- If you have defined an intra-day posting GL for the Income/Expense GL that you are defining, then all entries meant for the latter throughout the day (starting with the BOD batch processes) are transferred into the intra-day GL. This continues till you run the batch process to post intra-day entries into the actual Income/Expense GL. Subsequent entries get posted directly into the actual Income/Expense GL.
- The revaluation entries are posted with the same Contract Reference and Event Sequence as that of the original entry.
- The entries are posted with respective event codes for entry-pair and single entry. Thus, for entry-pair the entries are posted using the event RVEP whereas for single entry, entries are posted using the event RVSE.

The revaluation accounting entries for the contract can be seen from the accounting entry view in the contract online.

Currency Restrictions

You can specify currency restrictions only for Internal GLs. In effect, you indicate the currencies in which postings can be made to the GL. The options available are:

- Single currency
- All foreign currencies
- All currencies

By default, you will be able to post entries of transactions in all currencies into a GL. If you indicate Single currency then you should also indicate the specific currency in which transactions can be posted to the GL.

If you indicate 'All' foreign currencies then you can post entries of all transactions in any currency other than the local currency of your bank.

If you select 'All' currencies then no currency based restriction is applicable for transactions posted to the GL.

3.1.2.2 Indicating Position Account Details

Positioning Required

You can retrieve the position of a foreign currency, any time, by opting for *Position Accounting* in your bank. When you opt for position accounting, you maintain a Position GL and a Position Equivalent GL for every foreign currency maintained in your bank. The Position GL reflects the current position in the currency. You can opt for position accounting while indicating your *preferences* in the Bank-Wide Parameters screen.

If you opt for position accounting while defining Bank-Wide Parameters, you can maintain Position GLs and Position Equivalent GLs for every foreign currency that your bank deals in. When maintaining the GLs in your bank, you can opt to link the different currencies, associated with the GL, to:

- The Position GLs that you have specified for the currency (Your specifications in the Currency Definition screen will default here), or

- Position GLs of your choice

In the GL Category field, indicate if you are maintaining a Position GL or a Position Equivalent GL.

The position accounting happens event and entry pair-wise. Each entry is considered. If any currency mismatch is found then position accounting for each posting pairs are considered for position accounting.

Example

You have initiated an FT transaction where account is denominated in USD but the transfer amount is EUR. Charge is calculated in USD. In this case, the system will pass position entries for transfer amount as well as charge amount.

If transfer happens in USD from an USD account while charge is settled in EUR from an EUR account number position entry will be posted as no currency mismatch exists.

Display on Report With

When you maintain a Position GL, you can define the manner in which you would like the currency position to be reported in the Currency-Wise Position report.

In the Display on Report With field, under Position Accounting Details, indicate if you would like the currency position to be reported under one of the following:

- The head Asset
- The head Liability
- Under a separate head (that is, separately, as Currency Position)

Branch Restrictions

You have the option to indicate branch restrictions for an internal leaf GL. By default, both the Head Office and the branches of your bank can post and view entries made to a GL.

You can allow the Head Office, the branches of your bank or both to post entries to a GL. If you indicate Branch GL, only the branches of your bank can post entries to the GL. The Head Office can however view the accounting entries passed to Branch GLs. If you specify Head Office GL then only the Head Office can post entries to the GL. The branches can however view the entries posted to a Head Office GL.

Note

It is important to note that you cannot restrict specific branches from posting entries to a GL.

Posting Restrictions

Posting restrictions, like branch restrictions, can be specified only for internal leaf GLs. This is because, in Oracle Banking Current and Savings Account Cloud Service, you can post entries only to internal leaf GLs.

The posting of entries to an internal leaf GL can be direct or indirect. In the case of direct posting, accounting entries are posted directly to the Internal GL through Data Entry Module of Oracle Banking Current and Savings Account Cloud Service. In case of indirect posting, accounting entries are passed into the GL from the various modules of Oracle Banking Current and Savings Account Cloud Service, for example - a loan or a money market contract.

Back Period Entry Allowed

You can also choose to post back period entries to the GL by enabling the Back Period Entry Allowed option. If you choose not to restrict back period entries, you will be allowed to post journal entry transactions for the GL as long as the period is open.

Note

While posting back-valued transactions, the System verifies whether the Back Period Entry Allowed option has been enabled for the GL. If the option has not been enabled an error message is displayed. This check is also performed while uploading journal entry transactions.

Reconciliation

If the GL that you are creating belongs to the miscellaneous debit or credit type, you should indicate reconciliation preferences. The method in which entries posted to a GL can be reconciled could be one of the following:

- Direct
- Split

In the case of direct reconciliation, each debit entry is offset by the corresponding credit entry and vice versa (e.g. Manager's Check). For Split reconciliation, one debit entry can be offset against multiple credit entries and vice versa (e.g. Sundry Debtors and Creditors).

Revaluing unrealized P&L GLs in Oracle Banking Current and Savings Account Cloud Service

Using Oracle Banking Current and Savings Account Cloud Service, you can compute and book the due income earned not collected and the expense incurred not paid into unrealised (memo) income/expense accounts in a specified currency.

The revaluation process that performs revaluation of the total balance in the GL can be used to revalue unrealised Income/Expense GLs.

The movement of entries from unrealized to realized GLs is performed at the contract level.

3.1.3 GL Linkages Tab

Click the tab titled GL Linkages from the Chart of Accounts screen to define linkages for the GL that you are defining.

The screenshot displays the 'Chart of Accounts Maintenance' window with the 'GL Linkages' tab selected. The window is divided into three main sections for data entry:

- Previous Year Adjustment GL:** Includes a search field for 'Previous Year Adjustment GL'.
- Year End Profit and Loss Accounts:** Includes search fields for 'Profit Account' and 'Loss Account'.
- Parent GL:** Includes a search field for 'Parent GL'.

At the bottom of the window, there are several tabs: 'Statement', 'Position GL Maintenance', 'MIS Group Linkage', 'IBAN Account Number', 'Other GL Linked to This Parent', 'Child General Ledgers', and 'Fields'. On the far right, there are 'Audit' and 'Exit' buttons.

In the GL Linkages screen you maintain the following:

- the parent to which a GL should report
- the year-end profit and loss accounts into which balances would be posted

3.1.3.1 Indicating Parent GL

Parent GL

You can indicate the GL to which the current GL should report. This GL in effect becomes the parent of the current GL. You can select a parent GL from the option list available. The option list will contain only a list of Node GLs that you have already created.

Category

You can assign a Category only to a Head GL (a GL that does not report to another GL). If the GL that you indicated as the parent GL, is a Head GL the category assigned to it is also displayed.

3.1.3.2 Indicating Year-End Profit & Loss Accounts

Profit A/C

You can specify the accounts into which the year-end profit or loss entries for the GL should be posted.

The *profit account* is the account into which all income GL account balances are posted at the end of the year. On the last day of the financial cycle all balances from the account are posted into the year-end profit account. You can select an account code from the option list available.

Loss A/C

The *Loss account* is the account into which all expense GL account balances are posted at the end of the year. On the last day of the financial cycle, all balances from the loss accounts are posted into the year-end loss account.

You can specify the same GL for posting both your profits and losses.

3.1.3.3 Identifying Previous Year Adjustment GL

Prev Yr Adj GL

You can indicate the GL to which the previous year's adjustment entries for unrealized income and expense are to be posted. As a result the system automatically posts adjustment entries between Unrealised Income/Expense GL and an Adjustment GL for the interest/commission accrued in the Previous year, as these would already have moved to the year-end P and L GL during financial closure.

Adjustment entries are passed at the contract level to the effect that the improper balances on Revaluation Income/Expense GL's on account of Reversal of Previous Day's Revaluation entries (if there was a financial movement in between), get corrected.

Note

Revaluation of unrealized P and L GLs is performed only for interest and commission entries and is therefore applicable for the Money Markets, Trade Finance (LC, BC), Securities and Derivatives modules of Oracle Banking Current and Savings Account Cloud Service.

3.1.4 GL Lines Tab

To understand the sequence of steps involved in creating a new reporting line structure, let us take the following example:

Requirement

Assume you need to create a reporting line for your Head Office, representing *investments* of your bank. Under the head Investments, your Head Office wants information classified under *financial investments* and *business investments*.

Further, under business investments, you require to report *holdings in subsidiaries and holdings in associates*.

Solution

To create this new reporting structure, invoke the Reporting Lines Maintenance screen. First create the Head Reporting Line. In our example, it is Investments and assign it a description and a category - asset. Leave the parent details blank, since this does not report to another line.

Then create the lines at the second level, Financial investments, and Business investments. Indicate Investments as the Parent line for both these lines.

Thereafter, create the third level of GLs holdings in subsidiaries and holdings in associates respectively. Specify their parent line as Business investments. The category assigned to the Parent Line is defaulted.

The hierarchical structure of this Head Office reporting line would be as follows:

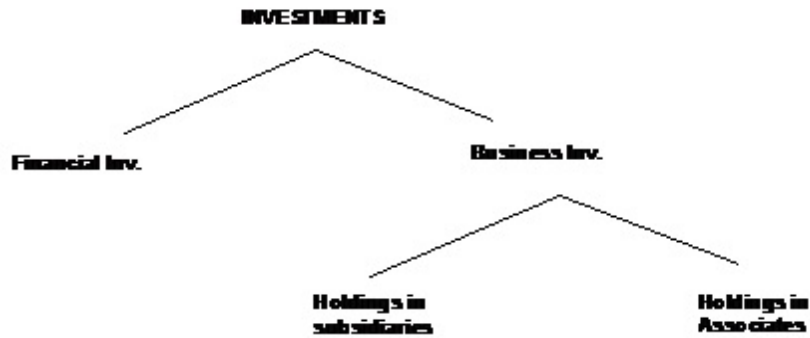

After you have defined Central Bank and Head Office lines, you can indicate the leaf GLs that should report to the line. While creating a GL, you can indicate the Central Bank or Head Office line to which it should report.

Click on the 'Reporting Lines' tab on the 'Chart of Accounts Maintenance' screen to indicate the reporting lines to which leaf GLs should report. A GL that you create can report to Central Bank and Head Office reporting lines.

3.1.4.1 Associating GL with Central Bank Reporting Line

For Central Bank reporting purposes, you should associate a GL with a debit and credit reporting line.

Debit Line

The Central Bank debit line indicates the line to which an account under a GL should report, if in debit.

Credit Line

Similarly, you can indicate the line to which an account under a GL should report, if in credit.

You can select a reporting line from the option list. The option list will contain a list of all the lines maintained in the Reporting Line Maintenance screen. The description of each specified reporting line appears alongside the line number. The debit and credit reporting lines you define for a leaf can be the same.

3.1.4.2 Associating GL with Head Office Reporting Line

In order to include a GL under a Head Office reporting line, you should associate it with debit and credit reporting line.

Debit Line

The Head Office debit line indicates the line to which an account under a GL should report, if in debit.

Credit Line

Similarly, you can indicate the line to which an account under a GL should report, if in credit.

You can select a reporting line from the option list. The option list will contain a list of all the lines maintained in the Reporting Line Maintenance screen. The description of each specified reporting line appears alongside the line number. The debit and credit reporting lines you define for a leaf can be the same. After you have made the required entries save the entries.

3.1.5 Other GL Linked to this Parent Button

Click 'Other GL Linked to this Parent' button from the 'Chart of Accounts' screen to view the hierarchical position of any GL.





You can view the structural hierarchy of a GL based on two criteria:

- The GLs that are at the same level as the GL you are creating
- The GLs that report to the GL you are creating

For example, let us assume that your GL Head of Overdrafts is structured as follows:

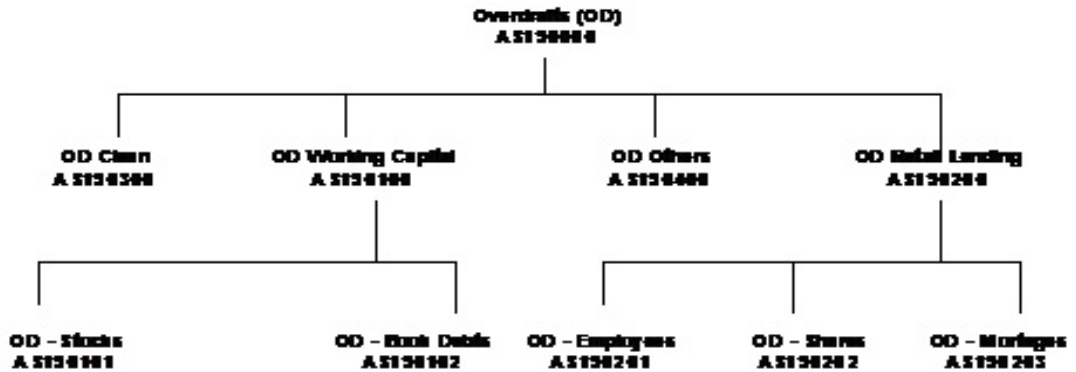

Suppose AS190100 is on display in the field GL Code. On choosing the other GLs linked to this parent option, the following list will be displayed:

GL Code	GL Description
AS190200	OD Retail Lending
AS190300	OD Clean
AS190400	OD Others

If you click on Child GLs for the Current GL the following list will be displayed:

GL Code	GL Description
AS190101	OD Stocks
AS190102	OD Book Debts

Thus by clicking on the second option under hierarchy level, you can view the list of GLs that report to the current GL.

To understand the sequence of steps involved in creating a new GL structure, let us take an example:

For example, assume you are creating an asset Head GL for bank balances held with other banks.

Your GL mask is defined as NNNNNAAD in the Bank-wide Parameters screen. You assign a GL code 50000ASS D to the Head GL. D is the last element of the code, which is system generated and is called the check digit. It will be an alphabet of the English language if it is represented in the mask as d and will be numeric if it is represented as D.

Under GL 50000ASS, you want to create two sub-GLs - 50100ASS representing balances with Federal Reserve Bank and 50200ASS representing balances with Commercial banks.

Under sub-GL 50200ASS stand two GLs -- 50201ASS and 50202ASS representing balances with commercial banks in local currency and foreign currency respectively.

The hierarchical structure of this GL tree is as follows:

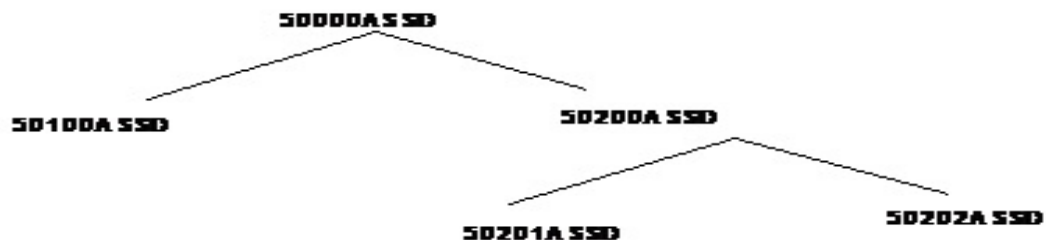

To create this new GL structure, invoke the 'Chart of Accounts' screen, the 'GL Linkages' screen is displayed. Click new icon. A new screen with no prior inputs will be invoked.

You can click on any of the four broad heads listed atop the screen to activate that screen. Follow the given sequence of steps:

Step 1:

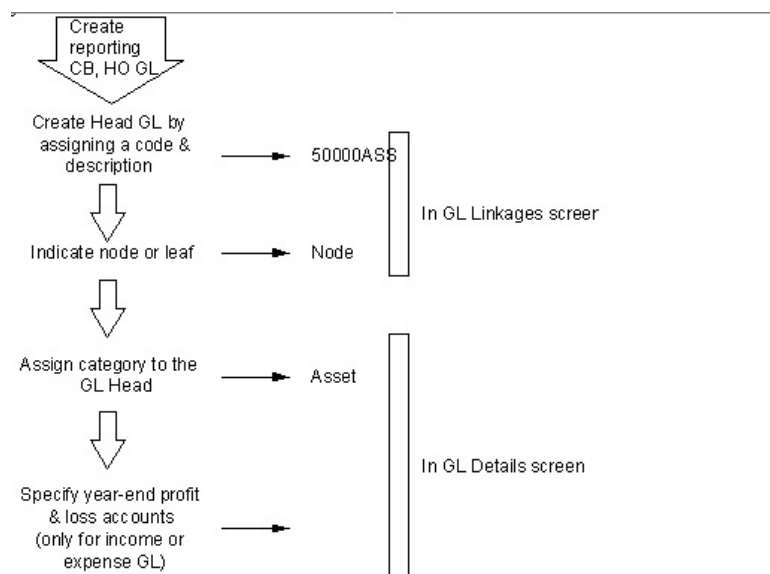

Step 2:

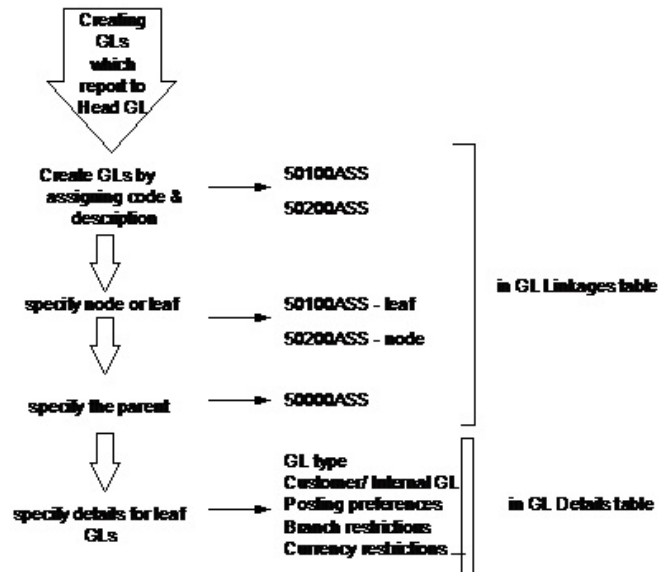

Step 3:



and so on...

3.1.6 Statement Button

For each new GL that you define in the Chart of Accounts, you may need to generate a periodic statement of accounts for transactions involving the GL.

You can indicate whether a periodic statement of accounts needs to be generated for transactions involving the GL through the Statement Details sub-screen in the GL Chart of Accounts screen.

To specify the statement related details click on the 'Statement' button in the Chart of Accounts screen. The 'Statements Detail' screen will be displayed.

Statement Details X

Account Statement

On

Cycle

Type None
 Summary
 Detail

Statement Required

Generate Statement Only On Movement

Media

Address

Address 1

Address 2

Address 3

Exit Save

Account Statement

Indicate that an account statement is to be generated periodically by the system for the particular account by specifying the format in which the statement is to be generated.

The options available are:

- Detailed – indicating that the statement should be a detailed account of all the transactions tracked against the particular GL Code
- Summary - indicating that only a summary of the transaction details is enough

Note

If you do not want a periodic statement of transactions involving the account, you can specify so by selecting the None option.

Cycle

Select the frequency at which the account statement should be generated from the adjoining drop-down list. This list displays the following values:

- Annual
- Semi-annual
- Quarterly
- Monthly
- Fortnightly
- Weekly
- Daily

On

Select the start date and month for the generation of the statement based on the frequency that you specify from the adjoining drop-down list. For a weekly generation of the account statement, specify the day of the week on which account statements should be generated.

For a monthly generation of statement you can specify the day of month. To specify the day of the month for the monthly generation of statements enter a number between 1 and 31 (corresponding to the system date).

If you set the statement date to 30, then account statements will be generated on:

- The last working day for months with less than 30 days
- For months with 30 days on the 30th day. If the 30th day is a holiday, it will be generated on the next working day

If you set the statement date to the 31st of the month, account statements will be generated on:

- The 31st, for months with 31 days
- The last working day for months for months with less than 31 days

Note

For all other cycles, the account statement will be generated on the last day of that cycle. Based on the preferences that you specify, the system generates a statement of accounts automatically, as part of the end of cycle processing.

Generate

Choose to generate the statement of accounts only when there has been a movement of funds into the account or when funds have been transferred out of the account.

For instance, let us assume that on the 21st of August 2001, you have set the account statement generation frequency as Daily for the account LI0202308. On the 5th of September 2001, there has been no movement of funds in the particular account. If you have opted for the Generate Only on Movement option the system will not generate a statement message for 5th Sept 2001.

You can also choose to generate the statement of accounts regardless of whether or not there has been a movement of funds to and from the account.

Statement Required

There may be times when you would have maintained the relevant account statement details for a particular GL. However, you would like to generate the account statements only a month or two later. You can choose to stall the generation of account statement for a temporary period of time by keeping the statement required check box unchecked.

To enable the generation of account statements you can unlock the contract and uncheck this box to re-start the generation of messages.

Media

Identify the media through which the account statement is to be sent to the receiver. A list of all the different types of media maintained in the Media Maintenance screen will be displayed in the option list positioned next to this field. You can select the appropriate media from the available choices.

Address

You may need to send account statement details to your central bank for statutory reporting purposes. While maintaining account statement details for a GL you can capture the mailing address of the receiver of the account statement details. The address that you specify in the first line will be used for correspondence with the party concerned.

3.1.7 IBAN Account Number Button

For an internal Leaf GL you can maintain the Clearing Account number to be used for outgoing payments where the internal GL is the remitter account. Click 'IBAN Account Number' button in the 'Chart of Accounts' screen.

The 'Additional Information' screen is displayed.

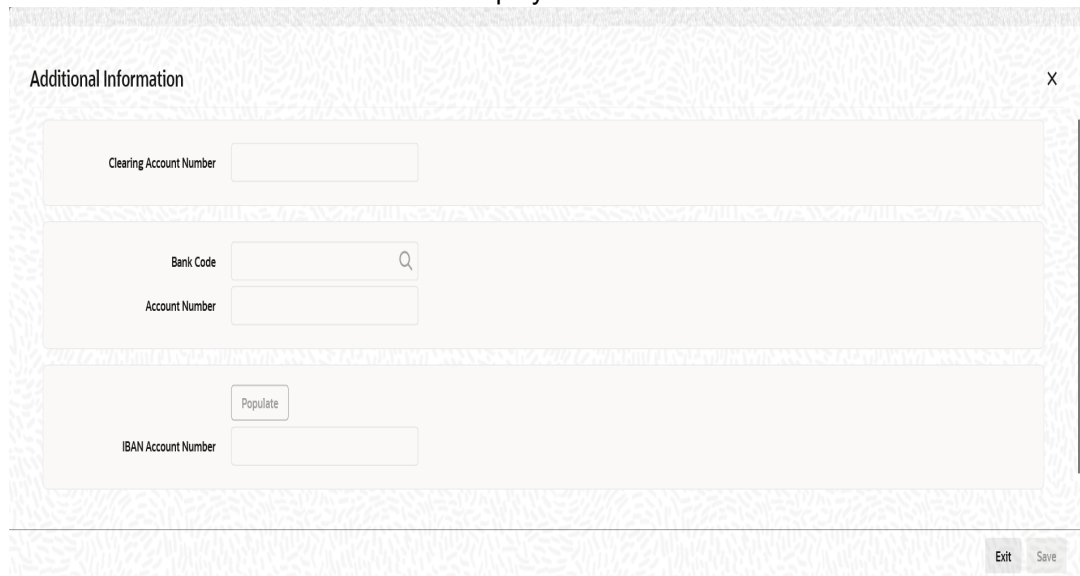

In this screen, you can specify the Clearing Account Number for the GL and the Bank Code of the GL. If a Clearing Account maintained for a GL is found in an uploaded incoming payment the System resolves the actual GL for the payment as per your maintenance in this screen.

Click 'Populate' button to default the IBAN Account Number based on bank code and account number. If the IBAN Number maintained for a GL is found in the incoming payment the System resolves the actual GL as per your maintenance in this screen.

3.1.8 Position GL Maintenance Button

When defining a GL in the Chart of Accounts, you must link all the foreign currencies linked to a GL to a Position GL, and a Position Equivalent GL if you have opted for *position accounting* in the Bank Wide Parameters screen.

If you do not want position accounting for a particular GL, do not choose the Positioning required option under Position Accounting Details in the Chart of Accounts. Click 'Position GL

Maintenance' button in the 'Chart of Accounts' screen. The 'Position GL Maintenance' screen is displayed.

The screenshot shows a web application window titled "Position GL Maintenance". At the top, there is a "GL Code" input field. Below this is a table with the following columns: "Currency", "Position GL", and "Position Equivalent". The table is currently empty, with the text "No data to display." below it. At the bottom of the table area, there is a pagination control showing "Page 1 (0 of 0 items)" and navigation arrows. At the bottom right of the window, there are "Exit" and "Save" buttons.

In this screen, you can:

- Choose the currency of the GL
- Indicate the corresponding Position GL and the Position Equivalent GL defined for the Currency, or a Position GL of your choice.

You can choose to retain the Position GL that defaults (according to your specifications in the Currency Maintenance screen), or indicate a Position GL of your choice.

Note

You should maintain Position GLs before you can identify one for a GL that you are maintaining.

3.1.9 BIC Button

For a leaf GL, you can link the SWIFT BICs representing the sender entities that are authorized to specify the GL account as the debit account for a funds transfer transaction.

While uploading an incoming SWIFT payment message, and deriving the debit and credit accounts, the Oracle Banking Current and Savings Account Cloud Service Straight Through Processing (STP) process checks whether the given Sender SWIFT BIC is authorized to specify a the Leaf GL as the Debit Account for incoming SWIFT payment messages.

To specify the Sender SWIFT BIC information for a leaf GL, click 'BIC' button in the 'Chart of Accounts' screen. The WIN BIC screen is opened, where you can specify the SWIFT BICs of the Sender entities that are authorized to specify the leaf GL as the Debit Account as the Debit Account for incoming SWIFT payment messages.

For details about how Oracle Banking Current and Savings Account Cloud Service processes incoming SWIFT payment message transactions and for details about the STP process, consult the Funds Transfer user manual.

3.1.10 Viewing Chart of Accounts Maintenance Details

You can view the chart of accounts maintenance details in the 'Chart of Accounts Maintenance Summary' screen. You can invoke the 'Chart of Accounts Maintenance' screen by typing 'GLSCHACC' in the field at the top right corner of the Application tool bar and clicking the adjoining arrow button.

Chart of Accounts Maintenance Summary

Search Advanced Search Reset Clear All Records per page 15

Search (Case Sensitive)

Authorization Status Record Status GL Code
General Ledger Description Parent GL Leaf
GL Type Category Alternate GL Code

Search Results Lock Columns 0

<input type="checkbox"/>	Authorization Status	Record Status	GL Code	General Ledger Description	Parent GL	Leaf	GL Type	Category	Currency Restrictions
No data to display.									

Exit

You can query records based on one or more of the following criteria:

- Authorization Status
- GL Code
- Parent GL
- GL Type
- Alternate GL Code
- Record Status
- General Ledger Description
- Leaf
- Category

Click 'Search' button. The system identifies all records satisfying the specified criteria and displays the following details for each one of them:

- Authorization Status
- Record Status
- GL Code
- General Ledger Description
- Parent GL
- Leaf
- GL Type
- Category
- Currency Restrictions
- Currency
- Customer/Internal GL
- Branch Restriction

- Revaluation
- Profit Account
- Loss Account
- Blocked
- Posting Restrictions
- Reconciliation
- Positioning Required
- Display On Report With
- Statement Required
- Generate Statement Only On Movement
- Alternate GL Code

Double click on a record to invoke the detailed screen for that record.

3.2 Reposting of FCY Entries for Realized P&L GLs in LCY

If you have indicated that the entries posted to realized income and expense GL's in FCY are to be posted in LCY, you must trigger the Batch Program during the EOD processes whereby all FCY entries for such GLs are reposted as LCY entries.

The reposted entries are posted against the RPOS event but they will have the same Transaction Reference and Event Sequence number as that of the original transaction.

To trigger the batch process invoke common batch function and choose GLREPDLY as the function id and execute, which will post FCY entries in LCY for those GL for which the Repost FCY entries in LCY option has been enabled.

As part of the End of Day processes, before the account revaluation batch process executes on a given business day, the revaluation batch process for performing accounting entry-based revaluation for FCY entries in Income/Expense GLs is run.

This process performs entry-based revaluation for those Income/Expense GLs for which such revaluation has been indicated in the Chart of Accounts.

Note

If transaction entry happens on STANDARD rate then the system does not post any revaluation, even though you have enabled revaluation for the GL,

It executes according to the sequence of processes as shown below:

- Entry-pair revaluation
- Single entry revaluation
- Reversal revaluation

Entry-pair Revaluation

First, the FCY accounting entries passed during the day into Income/Expense marked for entry-based revaluation are revalued, using the revaluation rate for the rate type defined in the Account Revaluation Maintenance for entry-based revaluation. The revaluation is done only for entry pairs in respect of which:

- both the main and offset entries are in the same FCY
- the FCY amount is greater than zero

The revaluation offset entry is posted to the Account/GL of the actual offset entry of the transaction in respect of which the FCY entries were passed. The offset Account/GL is identified based on the Contract Reference Number, Event Sequence Number and Amount Tag combination, and the revaluation entries are posted with the same Contract Reference Number and Event Sequence Number as the original entry. The event code RVEP is used to pass the entries. Appropriate position entries are also passed.

Single Entry Revaluation

After the entry-pair revaluation, the journal FCY accounting entries (that is, entries without corresponding offset entries) passed during the day are revalued, using the revaluation rate for the rate type defined in the Account Revaluation Maintenance for entry-based revaluation. Only those entries with FCY amounts greater than zero are revalued.

The revaluation offset entry is posted to the Profit/Loss GL maintained for the revalued GL in the Account Revaluation Maintenance, with the same Contract Reference Number and Event Sequence Number as the original entry. The event code RVSE is used to pass the entries. Appropriate position entries are also passed.

Reversal Revaluation

Revaluation of FCY reversal entries into Income/Expense GLs is done for those GLs for which such revaluation has been indicated, in the Chart of Accounts.

If an entry is posted into an Income/Expense GL's with a negative amount, it is considered a reversal entry.

All reversal entries are ordered according to:

- Contract Reference Number
- Event Sequence Number (Reversal event sequence number)
- Debit / Credit Indicator
- Amount Tag
- Account

The entries are consolidated according to amount tags, and the resultant net amounts are revalued using the revaluation rate for the rate type defined in the Account Revaluation Maintenance for entry-based revaluation. The revaluation offset entry is posted into the FX Profit/Loss GL defined for the revalued GL in the Account Revaluation Maintenance, with the same reference number and the event sequence number of the reversal event, with the event code RVRL.

Since the revaluation offset entry in each case is passed with the reference number of the original transaction, the relevant MIS updates are also made just as is done for the original transaction.

The reversal revaluation entries can be viewed in the LCY statement for the revalued Income/Expense GLs.

4. Maintaining Reporting Line Structure

To recall, in the Chart of Accounts screen, you define a GL and set up a GL hierarchy for your bank. We shall call this hierarchy the regular GL structure of the bank. Your Head Office or Central Bank may desire to have the balance sheet and profit and loss account categorized in a structure that is different from the regular GL structure of your bank. Oracle Banking Current and Savings Account Cloud Service offers you the flexibility of defining an alternate reporting structure for Head Office and Central Bank reporting purposes.

This is achieved by setting up *reporting lines*. The heads of financial information required for your Head Office and Central bank are defined as Reporting Lines. Each of these lines is assigned a unique code. After you have set up reporting lines, you can indicate the GLs that should report to the line.

Note

Ideally, you should first set up the Head Office and Central Bank lines and then define the regular GL structure for the bank. The advantage is that when defining the regular GL structure, you can indicate the Head Office or Central Bank line to which a GL should report.

This chapter contains the following section:

- [Section 4.1, "Reporting Line"](#)

4.1 Reporting Line

This section contains the following topic:

- [Section 4.1.1, "Maintaining Reporting Line"](#)

4.1.1 Maintaining Reporting Line

In the Reporting Line Maintenance screen, you can define reporting lines (heads of financial information) and indicate an alternate reporting structure for your Head Office and Central Bank.

To invoke this screen, click on General Ledger in the Application Browser, select Reporting Lines and click on Detailed under it. You can also invoke this screen by typing 'GLDXLINE' in the field at the top right corner of the Application tool bar and clicking on the adjoining arrow button.

To create a new reporting line structure, click new icon.

The screenshot shows the 'Reporting Line Maintenance' window. It features a title bar with window controls (maximize, refresh, close). Below the title bar are two buttons: 'New' and 'Enter Query'. The main content area is a form with the following fields:

- Line Code * (text input)
- Line ID Description * (text input with a help icon)
- Category (dropdown menu, currently showing 'Asset')
- Branch Code (text input)
- Line Type * (dropdown menu, currently showing 'Central Bank Line')
- Leaf (dropdown menu, currently showing 'Leaf Line')
- Line (text input with a search icon)
- Line Description (text input with a help icon)

At the bottom of the window, there are four buttons: 'Fields', 'Change Log', 'Audit', and 'Exit'.

In this table, you capture the following for your Head Office and the Central bank reporting lines:

- The branch code
- A code to identify the reporting line
- A description of the line
- The type of line — Head Office or Central Bank
- Category specified for this line — asset, liability, income, expense, etc.
- The type of line – Node or Leaf
- The parent line code for this reporting line

The reporting lines that you create are, for alternate reporting. Alternate reporting is required when the GL structure defined for the balance sheet of the Head Office or the Central Bank are different from the GL structure created by your bank.

The order in which the GL categories - Asset, Liability, Expense, Income, Contingent Asset, Contingent Liability appear in the balance sheet cannot be changed. However, under a category you can redefine the position of the various GL heads and shift a head from one GL category to another, if required.

For all practical purposes, GL heads appear in order of their numeric sequence number assigned.

Note

Central Bank and Head Office reporting lines can be created only at the Head Office of your bank.

5. Defining Alternate Reporting Lines

Oracle Banking Current and Savings Account Cloud Service offers you the flexibility to define alternate reporting lines for Head Office and Central Bank reporting purposes. If your bank has a network of branches spread over several countries, you can opt to maintain Central Bank (CB) lines at the *branch* level. This means all branches or Regional Offices can maintain CB lines.

In the Reporting Line Maintenance screen you can define reporting lines (heads of financial information) and indicate an alternate reporting structure for your Head Office or Central Bank depending on which branch of the bank you are working at. For instance, if you are operating from the Head Office (HO) level, you will be allowed to define both HO and CB lines. However, if you are working at the branch level, you can only define CB lines.

This chapter contains the following sections:

- [Section 5.1, "Alternate Reporting Line"](#)
- [Section 5.2, "GL Central Bank Line Linkage Maintenance"](#)
- [Section 5.3, "GL MIS Linkages"](#)

5.1 Alternate Reporting Line

This section contains the following topic:

- [Section 5.1.1, "Maintaining Alternate Reporting Line"](#)

5.1.1 Maintaining Alternate Reporting Line

You can invoke the 'Reporting Line Maintenance' screen by typing 'GLDXLINE' in the field at the top right corner of the Application tool bar and clicking the adjoining arrow button.

The screenshot shows the 'Reporting Line Maintenance' application window. At the top left, there are 'New' and 'Enter Query' buttons. The main form area contains the following fields:

- Line Code * (empty)
- Line ID Description * (empty, with a help icon)
- Category: Asset
- Branch Code (empty)
- Line Type * (Central Bank Line)
- Leaf: Leaf Line
- Line (empty, with a search icon)
- Line Description (empty, with a help icon)

At the bottom of the window, there are buttons for 'Fields', 'Change Log', 'Audit', and 'Exit'.

To create a new reporting line structure, click new icon. The 'Reporting Line Maintenance' screen will be displayed without any details except for the 'Branch Code' field. Here the code

assigned to the branch where you are currently working will be defaulted. You will not be allowed to change the branch code.

The other details that you need to specify for your Head Office and Central Bank reporting lines are as follows:

- a code to identify the reporting line
- a description of the line
- the type of line - Head Office or Central Bank
- category specified for this line - asset, liability, income, expense etc
- the parent line code for this reporting line

For detailed information on how to create a new reporting line structure, refer to the chapter on Maintaining a Reporting Line Structure of the General ledger module.

5.2 GL Central Bank Line Linkage Maintenance

This section contains the following topics:

- [Section 5.2.1, "Linking GL to CB Line"](#)
- [Section 5.2.2, "Operations on GL Code to CB Line Linkage Record"](#)

5.2.1 Linking GL to CB Line

Once you define Central Bank lines, you can indicate the leaf GL that should report to the line.

If you are working at the Head Office, you can specify this linkage under the Reporting Lines section of the Chart of Accounts screen. At the branch level you need to indicate this linkage in the GL Code to CB Line Linkage screen.

You can invoke the 'GL Central Bank Line Linkage Maintenance' screen by typing 'GLDXGLLN' in the field at the top right corner of the Application tool bar and clicking the adjoining arrow button.

The screenshot shows the 'GL Central Bank Line Linkage Maintenance' application window. The window title is 'GL Central Bank Line Linkage Maintenance'. The interface includes a top bar with 'New' and 'Enter Query' buttons. The main area is divided into two sections: 'General Ledger Details' and 'Central Bank Lines'. The 'General Ledger Details' section contains fields for 'GL Code *', 'General Ledger Description', and 'Branch Code'. The 'Central Bank Lines' section contains fields for 'Credit Line', 'Debit Line', 'Debit Line Description', and 'Credit Line Description'. At the bottom, there are buttons for 'Fields', 'Change Log', 'Audit', and 'Exit'.

5.2.1.1 Indicating CB Debit Line and CB Credit Line

The CB Debit Line indicates the line to which an account under a GL should report, if in debit.

Similarly, you can indicate the line to which an account under a GL should report, if in credit.

You can select a reporting line from the option list. The option list will contain a list of all the lines maintained in the Reporting Line Maintenance screen. The description of each specified reporting line appears alongside the line number. The debit and credit reporting lines you define for a leaf can be the same.

5.2.2 Operations on GL Code to CB Line Linkage Record

Apart from defining a new linkage you can perform any of the following operations (if any icon is disabled in the application toolbar, it means that the function is not allowed for the record) on an existing record.

- Amend the details of a record
- Authorize a record
- Close the record
- Reopen the record
- Print the details of the record
- Delete the details of the record

For details on these operations refer to the Oracle Banking Current and Savings Account Cloud Service User Manual on Common Procedures.

5.3 GL MIS Linkages

This section contains the following topics:

- [Section 5.3.1, "Linking GL to MIS Class"](#)
- [Section 5.3.2, "Operations on GL MIS Linkages Record"](#)

5.3.1 Linking GL to MIS Class

By linking a GL code to an MIS class you can generate GL reports in which the balances are reported against the entries defined in the linkage. The advantage of a GL to MIS linkage is that it helps you group information under different MIS entities.

The advantage in linking a GL to an MIS class is that the reported information will be grouped based on the MIS Class specified during linkage.

You can invoke the 'GL MIS Linkage Maintenance' screen by typing 'GLDREP' in the field at the top right corner of the Application tool bar and clicking the adjoining arrow button.

GL MIS Linkage Maintenance

New Enter Query

Branch Code *

Report Name *

Description

Ledger Detail

General Ledger Code *	General Ledger Description *	MIS Class *	MIS Class Description *
No data to display.			

Page 1 (0 of 0 items)

Fields Audit Exit

If you are maintaining a new GL-MIS Linkage, click new icon. The 'GL MIS Linkages' screen will be displayed without any values.

5.3.2 Operations on GL MIS Linkages Record

On an existing GL MIS Linkages record, you can perform any of the following operations (if any icon is disabled in the application toolbar, it means that the function is not allowed for the record):

- Amend the details
- Authorize the addition or amendment of a record
- Copy the details record to another
- Close the record
- Reopen the record
- Print the details of a record
- Delete the addition of a record

Refer to the manual on common procedures for details of these operations.

6. GL Report Classification on MIS Class

In order to manage cumbersome information, you can classify it under broad heads called *classes*. An MIS Class is an entity based on which you can classify information relating to customer and internal general ledgers. Based on your requirement, you can categorize information under MIS classes. Each class is assigned a code based on which you can retrieve information.

A class can have several categories under it, for example, under a class called business segment you can have further sub-classifications represented by categories, like, big business, small-scale industries, business for charity etc. This classification into MIS classes helps to manage efficiently information related to GLs.

Requirement:

If you want to have a consolidated report of all the loans disbursed from your bank. You also want to classify the loans into short term, medium term, and long term loans.

However, for information management purposes you want to further classify information of these GLs and sub-ledgers based on:

- The *type of customer* to whom the loan disbursed are categorized, could be:
 - Individual
 - Corporate
 - Banks and
 - Financial Institutions
- The *industry* to which the customer belongs, for instance,
 - Fisheries
 - Agriculture
 - Manufacturing
 - Software

The aim is to see that the GL structure does not become unwieldy and difficult to work with.

Solution

You can set up a GL called Loans. All loans disbursed from your bank will be consolidated at this GL. You should further set up sub-GLs to classify loans into short term, medium term, and long term loans.

We have already defined two GL levels. Instead of adding more GLs and making the structure complex, you can use the MIS class categorization to further classify information.

Therefore, you should set up two MIS classes called Customer Type and Industry type. You can have the MIS Codes Individuals, Banks, Corporate, Financial Institutions reporting to the class Customer Type. You can associate the MIS codes, Fisheries, Agriculture, Manufacturing, and Software to the class Industry Type.

This helps simplify the GL structure of the bank and serves the purpose of providing you the classified information that you require.

Note

MIS classes can be created only at the Head Office of your bank.

This chapter contains the following sections:

- [Section 6.1, "MIS Class Maintenance"](#)
- [Section 6.2, "General Ledger Branch Parameters"](#)
- [Section 6.3, "General Ledger Class Maintenance"](#)

6.1 MIS Class Maintenance

This section contains the following topics:

- [Section 6.1.1, "Maintaining MIS Class"](#)
- [Section 6.1.2, "Saving the record"](#)

6.1.1 Maintaining MIS Class

In order to maintain MIS classes, you need to invoke the 'MIS Class Maintenance' screen by typing 'GLDCLSMT' in the field at the top right corner of the Application tool bar and clicking on the adjoining arrow button. In this screen, you can define various categories based on which reports on general ledgers should be classified. To maintain details of a new MIS class, click new icon.

The screenshot shows the 'MIS Class Maintenance' application window. At the top, there is a title bar with the text 'MIS Class Maintenance' and window control icons. Below the title bar, there is a toolbar with a 'New' icon and an 'Enter Query' text box. The main content area is a form with the following fields: 'MIS Class *' (text input), 'Class Description *' (text input with a help icon), 'Mandatory' (dropdown menu showing 'Yes'), and 'MIS Type' (radio button group with options: Transaction Class, Customer Class, Composite Class, and Fund Class). At the bottom of the form, there is a 'Fields' button on the left and 'Audit' and 'Exit' buttons on the right.

Here you can maintain the following details:

MIS class

In Oracle Banking Current and Savings Account Cloud Service, each MIS class that you maintain is identified by a unique nine-character code called a Class Code. You can follow your own convention for devising this code.

Description

You can specify a short description that will enable you to identify the MIS class quickly. The short description that you specify is for information purposes only and will not be printed on any customer correspondence.

MIS Type

An important detail in defining an MIS class is to specify the *type* of class that you are creating. The MIS class type identifies the basic nature of the class. In Oracle Banking Current and Savings Account Cloud Service you can set up the following type of MIS classes:

- *Transaction class* — A transaction class refers to all transactions that have taken place through any of the front-end modules like foreign exchange, money market etc. Customer Class relates to customer accounts.

- *Customer class* — Select this option if you are defining a customer-based classification.
- *Composite class* — Choose this option to indicate that the MIS class can be used both at customer definition and at the time of processing a transaction.
- *Fund class* — Refer to the Core Services User manual for details on setting up a Fund MIS class

This is the basic feature of a class and will determine the type of MIS codes that can constitute the class. For each of these MIS types you can create a maximum of ten classes.

Mandatory

Using this field, you can indicate whether entering an MIS code is mandatory for a particular MIS class or not. Whenever any transaction is stored, the system checks if an MIS code is supplied for this MIS class invoked in the transaction.

MIS Codes

Under a class, you can indicate the sub-divisions that should be reported under the class. Each of the sub-classes is given unique code identifiers.

The MIS codes that you associate with a class will fall under the class at the time of reporting or consolidation.

Click add icon to associate an MIS code to a class. To remove an MIS class from the list, place your cursor in that row and click delete icon.

The MIS codes that you associate will depend on the Type of MIS Class that you are creating. While setting up the details of a customer, you can associate the customer to a customer type MIS Code. Therefore the set up serves more for management purposes and makes the management of GLs simple and easy.

6.1.2 Saving the record

Click save icon to save the record. Click delete icon to exit without saving the details that you entered. An MIS Class that you have created will be available for use only after it has been authorized by a user bearing another ID.

Similarly, you cannot make any modifications to a Class or Category until the previous modification made, has been authorized.

After you have made the required entries, click 'Exit' button to exit the screen. You will be returned to the Application Browser.

6.2 General Ledger Branch Parameters

This section contains the following topic:

- [Section 6.2.1, "Maintaining GL Branch Parameters"](#)

6.2.1 Maintaining GL Branch Parameters

You can maintain branch level parameters that govern the processing of GL in a particular branch of your bank through the General Ledger Branch Parameters screen. You can invoke the 'General Ledger Branch Parameters Maintenance' screen by typing 'GLDBRPRM' in the field at the top right corner of the Application tool bar and clicking the adjoining arrow button.

The General Ledger Branch Parameter screen will be displayed.

Chart of Accounts Maintenance Summary

Search Advanced Search Reset Clear All Records per page 15

Search (Case Sensitive)

Authorization Status Record Status GL Code
General Ledger Description Parent GL Leaf
GL Type Category Alternate GL Code

Search Results Lock Columns 0

Authorization Status	Record Status	GL Code	General Ledger Description	Parent GL	Leaf	GL Type	Category	Currency Restrictions
No data to display.								

Exit

You will need to maintain the following branch details:

Defining Branch Identification Details

Branch Code

In Oracle Banking Current and Savings Account Cloud Service, each branch of your bank is identified by a unique three-character code called the branch code. This code will be displayed upon invoking the screen.

Description

The description of the branch will be displayed by default when the screen is invoked. You can also specify the name that identifies the branch.

Defining Batch Processing Details

You can define Batch Processing Details in way detailed below.

MIS Average Balance Retention Days

The MIS average balance details will be retained in the system only for those numbers of days you mention in this field. The Retention day is entered always in terms of days and is greater than the system date.

General Ledger Average Balance Retention Days

The GL average balance details will be retained in the system only for those numbers of days you mention in this field. The Retention day is entered always in terms of days and is greater than the system date.

Note

When a GL-MIS average balance report is requested for a date beyond the retention date, the system will display an error message stating that the data is not available.

Account Statement Retention Days

The Customer Account Statistics will be retained in the system only for those numbers of days you mention in this field. Specify the retention days in terms of days and which is greater than the system date.

All records older than the period that you specify are purged as part of the purge process. The purge process should be initiated manually. The current period data is not purged.

General Ledger MIS Process Days

Those events, which have to be triggered automatically, will be processed accordingly during batch process. You have the option to specify whether the batch process should be processed as part of the EOD process till the next working date - 1 day or not.

Check the box to indicate that the processing has to be done till the next working date - 1 day. Leave the box unchecked to indicate otherwise.

General Ledger Average Balance Process Days

Computation of Average Balance can be based on the Next Working Day-1 or System Date. If the average balance calculation basis is NWD-1, the balances of holidays are included in the previous working day. If the calculation basis were System Date, the balances of holidays are included on the next working day provided the next working day is in the same period. If the basis is System Date but the next working day is in the next period, the holidays are considered during the current run.

6.3 General Ledger Class Maintenance

This section contains the following topic:

- [Section 6.3.1, "Maintaining GL Class"](#)

6.3.1 Maintaining GL Class

You can group GL charts of accounts that belong to the particular business entities through the 'General Ledger Class Maintenance' screen. You can invoke the 'General Ledger Branch Parameters Maintenance' screen by typing 'STDGLCMT' in the field at the top right corner of the Application tool bar and clicking the adjoining arrow button.

The screenshot shows the 'GL Class Maintenance' application window. At the top, there are 'New' and 'Enter Query' buttons. Below these are two input fields: 'GL Class Code *' and 'GL Class Name *'. The 'GL Class Name *' field has a small icon to its right. Below the input fields is a section titled 'GL Details' with expand/collapse and list icons. This section contains a table with two columns: 'GL Code' and 'General Ledger Description'. The table is currently empty, displaying 'No data to display.' At the bottom of the table, there is a pagination control showing 'Page 1 (0 of 0 items)' and navigation arrows. At the bottom right of the window, there are 'Audit' and 'Exit' buttons.

GL Class Code

Specify the unique code given to the specific group of GLs. You can enter a maximum of 3 alphanumeric characters.

GL Class Name

Specify the GL Class Code name. You can enter a maximum of 255 alphanumeric characters.

GL Code

Specify the GL code. The adjoining list displays all the GL codes maintained in the system. You can choose the appropriate one.

GL Description

The system displays the GL account description.

7. Maintaining GL Balance Transfer

You can maintain sweep instructions for transferring balance from branch “Stamp duty payable GL” to the head office GL.

This chapter contains the following sections:

- [Section 7.1, "GL Balance Transfer Maintenance"](#)
- [Section 7.2, "Balance Transfer Batch GL"](#)

7.1 GL Balance Transfer Maintenance

This section contains the following topic:

- [Section 7.1.1, "Maintaining GL Balance Transfer Details"](#)

7.1.1 Maintaining GL Balance Transfer Details

You can maintain it through ‘GL Balance Transfer Maintenance’ screen. You can invoke this screen by typing ‘STDGLTRF’ in the field at the top right corner of the Application tool bar and clicking the adjoining arrow button.

The screenshot shows the 'GL Balance Transfer Maintenance' application window. At the top, there is a title bar with the text 'GL Balance Transfer Maintenance' and a search icon. Below the title bar, there is a toolbar with a 'New' button and an 'Enter Query' button. The main area of the application is divided into two sections. The first section, titled 'GL Balance Transfer Maintenance', contains four input fields: 'Branch Code', 'Group Code', 'Description', and 'Transaction Code'. The 'Description' field has a small icon next to it. The second section, titled 'Transfer Details', contains a table with three columns: 'From GL Code', 'To Branch', and 'To GL Code'. The table is currently empty, displaying 'No data to display.' and a pagination control showing 'Page 1 (0 of 0 items)'. At the bottom right of the screen, there are 'Audit' and 'Exit' buttons.

Specify the following details:

Branch Code

Specify the current branch code from where the sweep would take place.

Group Code

Specify the code to group the GL's to be transferred.

Description

Enter the description for the group.

Transaction Code

Select a transaction code to be used for posting transfer entries from the list of values provided.

From GL

Select the GL code to transfer funds from the list of values provided.

Note

This is the inter branch GL used for parking stamp duty collected.

To Branch

Select the branch code from the list of values provided to transfer the balances.

To GL

Select the GL code from the list of values provided to be used for posting sweep entries by the system.

Note

After this batch is executed, the balance on the source GL (stamp duty payable GL) is 0 for the branch. The system then transfers the balances of GL in each currency to the target GL in head office in the same currency.

7.2 **Balance Transfer Batch GL**

This section contains the following topic:

- [Section 7.2.1, "Querying GL Balances"](#)

7.2.1 **Querying GL Balances**

GL balance transfer batch posts transfer entries and is scheduled as part of AEOD post EOTI. It sweeps the balance if any from the branch GL's to the head office GL. If the branch GL has balances in multiple currencies, system transfers the balance for each currency to the head office GL in the same currency. When this batch is executed, system checks for any sweep instruction maintenance available for the current branch and then generates and post entries to sweep balance from branch GL to head office GL.

You can invoke the 'GL Balances Query' screen by typing 'GLDXWBAL' in the field at the top right corner of the Application tool bar and clicking on the adjoining arrow button.

The 'GL Balances Query' screen is shown below:

The screenshot shows the 'GL Balances Query' interface. It features a search bar at the top with the text 'Enter Query'. Below this, there are two columns of input fields. The left column includes 'General Ledger Code', 'Branch', and 'Financial Year'. The right column includes 'General Ledger Description', 'Period Code', 'Currency Code', and 'Alternate GL Code'. Each field has a magnifying glass icon for search. Below the input fields is a section titled 'Balances' which contains a table with columns: GL, Branch, Year, Period, Currency, FCY Balance, LCY Balance, Debit Movement, Credit Movement, Net Movement, and Debit Movement LCY. The table is currently empty, displaying 'No data to display.' Below the table is a pagination control showing 'Page 1 (0 of 0 items)'. At the bottom of the screen, there are two summary buttons: 'Branch Wise Local currency Summary' and 'Bank Wise Local Currency Summary', and an 'Exit' button in the bottom right corner.

Click the Enter Query button to enter the following query criteria.

General Ledger Code

Specify the code used to identify the general ledger.

Branch

Specify the branch code. The adjoining option list displays all valid branch codes maintained in the system. You can select the appropriate one.

Financial Year

Specify the financial year.

General Ledger Description

The system displays the appropriate general ledger description for the general ledger code selected.

Period Code

Specify the period code. The adjoining option list displays all valid period codes maintained in the system. You can select the appropriate one.

Currency Code

Specify the currency code for the transaction. The adjoining option list displays all valid currency codes maintained in the system. You can select the appropriate one.

Alternate GL Code

Specify the Alternate GL code along with the GL code. The adjoining option list displays all valid alternate GL codes maintained in the system. You can select the appropriate one.

Branch

Specify the branch code. The adjoining option list displays all valid branch codes maintained in the system. You can select the appropriate one.

Year

Specify the financial year. The adjoining drop-down list displays all valid financial year codes maintained in the system. You can select the appropriate one.

Period

Specify the period code. The adjoining option list displays all valid period codes maintained in the system. You can select the appropriate one.

Currency

Specify the currency code for the transaction. The adjoining option list displays all valid currency codes maintained in the system. You can select the appropriate one.

FCY Balance

Specify the balance in foreign currency.

LCY Balance

Specify the balance in local currency.

Debit Movement

Indicate whether the debit amount should be moved or not.

Credit Movement

Indicate whether the credit amount should be moved or not.

Net Movement

Indicate whether the net amount should be moved or not.

Debit Movement LCY

Specify the debit amount moved in local currency.

Credit Movement LCY

Specify the credit amount moved in local currency.

Net Movement LCY

Specify the net amount moved in local currency.

8. Error Codes and Messages

This chapter contains the Error Code and Error Messages pertaining to GL.

Error Code	Message
FMS-0001	Duplicate FMS value
FMS-0002	Mapping already exists
GL-0001	Line code cannot be null
GL-0002	Line code length cannot be less than three characters
GL-0003	Line description cannot null
GL-0004	Cannot change the line type
GL-0005	The line type of the parent does not match with that of the line
GL-0006	The category of the parent does not match with that of the child
GL-0007	\$1 is the consolidation point for \$2
GL-0008	Record already exists
GL-0009	First authorize the lines above the current line in the hierarchy
GL-0010	Enter valid parent
GL-0011	Mandatory fields not input
GL-0012	The length of the GL code cannot be lesser than three characters
GL-0013	Duplicate GL code, customer account or account short code
GL-0014	The GL code does not match with the GL Mask
GL-0015	Check digit could not be generated for the current GL code
GL-0016	The scope of currency restriction cannot be reduced
GL-0017	The scope of the branch restriction cannot be reduced
GL-0018	A head office or branch Restriction can be modified to both only
GL-0019	Record already exists
GL-0020	Some branches are not at End of Day
GL-0021	Closure disallowed. Customer Accounts linked to the GL at following nodes: \$1
GL-0022	The type does not allow Modification
GL-0023	Balance for the current GL is not zero at following nodes: \$1
GL-0024	First authorize the GL above the current GL in the hierarchy
GL-0025	Enter the currency

GL-0026	Current GL is a parent of some open GLs
GL-0027	The parent GL for the current GL has been modified to a leaf - cannot open this GL
GL-0028	Spaces not allowed in GL code
GL-0029	Length of the field cannot be less than three characters
GL-0030	A maximum of ten customer classes and ten transaction classes allowed
GL-0031	A maximum of two classes can be maintained for budget for each customer/transaction class
GL-0032	Input mandatory
GL-0033	Gl_Code cannot be null
GL-0034	MIS_Class cannot be null
GL-0035	Invalid record
GL-0036	The Parent_GL for the current GL is unauthorized - cannot open this GL
GL-0037	The Parent_GL for the current GL is closed - cannot open this GL
GL-0038	Before running the consolidated report run the GL report for the branch - \$1
GL-0039	Could not generate the report
GL-0040	Failed to perform the consolidation for the nodes
GL-0041	GL code already used
GL-0042	Failed to update the Balances for the customer GLs
GL-0043	Budget name cannot be empty
GL-0044	Invalid budget description
GL-0045	Financial year cannot be empty
GL-0046	Period code cannot be empty
GL-0047	M I S class cannot be empty
GL-0048	M I S code cannot be empty
GL-0049	Currency code cannot be empty
GL-0050	Amount cannot be empty
GL-0051	Branch cannot be empty
GL-0052	No records available
GL-0053	GL code cannot be empty

GL-0054	All (AL) option cannot be selected, when a currency has been already selected
GL-0055	Input a valid date
GL-0056	Spaces not allowed in report name
GL-0057	Failed to perform consolidation
GL-0058	Spaces are not allowed in MIS class
GL-0059	Spaces are not allowed in MIS code
GL-0060	Change of MIS type is not allowed
GL-0061	Cannot delete the last detail record
GL-0062	Detail records cannot be empty
GL-0063	Duplicate record
GL-0064	All (AL) option has been selected, other currencies not allowed
GL-0065	Enter a valid category
GL-0066	Enter a valid category group
GL-0067	Cannot change the category of the line
GL-0068	Current line is a parent of some open lines
GL-0070	The parent line for the current line is closed - cannot open this line
GL-0071	The parent line for the current line is unauthorized - cannot reopen this line
GL-0072	Budgeting is being done for this GL. Closure disallowed
GL-0073	Reporting is being done for this GL. Closure disallowed
GL-0074	MIS update failed
GL-0075	Budget update failed
GL-0076	This report is being run by another user. Please wait
GL-0077	Type not allowed for customer GL
GL-0078	Type not allowed for internal GL
GL-0079	Category not allowed for customer GL
GL-0080	Financial year/period code cannot be null
GL-0081	Date cannot be null
GL-0082	Report name mandatory
GL-0083	Days cannot be greater than 27 if months present
GL-0084	Days cannot be greater than 364 if years present

GL-0085	Months cannot be greater than 11 if years present
GL-0086	Tenor cannot be negative
GL-0087	Period code cannot be null
GL-0088	Financial year cannot be null
GL-0089	Cannot change leaf to a node
GL-0090	Do you want to close the financial year?
GL-0091	Do you want to close the period?
GL-0092	Could not close financial year
GL-0093	Could not close period
GL-0094	Enter the financial year before the period
GL-0095	Cannot use this MIS class for further allocation order
GL-0096	Interbranch GL - only one MIS group allowed
GL-0097	Mandatory field MIS group cannot be null
GL-0098	A position GL or position eqv. GL cannot be defined as node GLs.
GL-0099	This process can be run only between end of financial input and End of Day
GL-0100	This process has already been run
GL-BUD01	Period code is not maintained for the budget
GL-BUD02	The MIS class 1 for the budget is not maintained
GL-BUD03	The MIS code 1 for the budget is not maintained
GL-BUD04	The MIS class 2 for the budget is not maintained
GL-BUD05	The MIS code 2 for the budget is not maintained.
GL-CPT01	This combination of product, allocation code, transaction type and MIS code for the given financial cycle and period code is already maintained
GL-CPT02	Product or allocation code or transaction type cannot be null
GL-CPT03	Both cost code and cost per transaction cannot be null
GL-CPT04	Financial cycle or period code cannot be null
GL-CPT05	The selected period code is not for the chosen financial cycle
GL-CPT06	Segment code cannot be null
GL-CTG1	Asset accounts should be of debit category
GL-CTG2	Liability accounts should be of credit category
GL-CTG3	Income accounts should be of credit category

GL-CTG4	Expense accounts should be of debit category
GL-CTG5	Invalid FMS account code
GL-DEBUG	1
GL-FIN-CL001	Finance closure successful
GL-FIN-CL002	Finance closure unsuccessful
GL-FMS1	The legal vehicle of the FMS account is not valid
GL-FMS2	Incorrect length of FMS account
GL-FMS3	The currency is not valid
GL-FMS4	The FMS account exists
GL-FMS5	The GL code is a new GL. Do you want to auto-maintain it?
GL-FMS6	The RC code is new. Do you want to auto-maintain it?
GL-FMUP001	Failed to get commit frequency for process ZDWU
GL-FMUP002	No data found in cotms_source_pref for source \$1
GL-FMUP003	Failed to get upload ID for process ZDWU
GL-FMUP004	Failed to translate external entity \$1 for \$2 - check if it is authorized/open or not maintained
GL-FMUP005	GL - \$1 closed
GL-FMUP006	GL - \$1 unauthorized
GL-FMUP007	\$1 duplicate GL
GL-FMUP008	\$1 - failed to insert in GLTMS_GLMaster
GL-FMUP009	\$1 - failed to insert in STTBS_ACCOUNT
GL-FMUP010	MIS group - \$1 closed
GL-FMUP011	MIS group - \$1 unauthorized
GL-FMUP012	Failed to get the Maximum class number for transaction class

GL-FMUP013	RC01 - failed to insert into GLTMS_MIS_Class
GL-FMUP014	\$1 - RC01 - failed to insert into GLTMS_MIS_Code
GL-FMUP015	\$1 - \$2 - failed to insert into GLTMS_GL_MIS_Group
GL-FMUP016	Failed to insert in GLTBS_FMS_Details
GL-FMUP017	Record already exists in GLTBS_FMS_Details
GL-FMUP018	\$1 - \$2 - failed to get start and end date
GL-FMUP019	EOM balances not sent by FMS
GL-FMUP020	AVG balances not sent by FMS
GL-FMUP021	LCY balance not sent but the currency is local currency
GL-FMUP022	No MIS head maintained for transaction code \$1
GL-FMUP023	\$1 - MIS group not maintained
GL-FMUP024	Failed to insert in MITBS_Class_Mapping
GL-FMUP025	Failed to update processed flag
GL-FMUP026	General failure in FMS upload process
GL-FMUP027	No records to process
GL-FMUP028	The record is already processed
GL-FMUP029	\$1 cannot be null
GL-FMUP030	FMS upload successful
GL-FMUP031	Failed to insert in GLTBS_FMS_Master
GL-FMUP032	FMS and ISO currency should be same

GL-FMUP035	Account code invalid
GL-GRP01	Source group name cannot be null
GL-GRP02	Source group name should be unique
GL-GRP03	Please maintain at least one GL code for this group
GL-POS01	Currency field cannot be null
GL-POS02	At least one of the fields (position GL or position eqv. GL) has to be populated
GL-POS03	GL is linked for positioning in GL maintenance - cannot be closed
GL-POS04	GL is linked for positioning in currency maintenance - cannot be closed

-

This chapter contains the following section:

- [Section 9.1, "General Ledger Terms"](#)

9.1 General Ledger Terms

The following terms have been used in this manual.

GL

This module forms the single repository in Oracle Banking Current and Savings Account Cloud Service for financial information and accounting for all types of accounts held by the bank. Balances, turnovers and so on for any account or type of account can be maintained and consolidated.

Leaf GL

A GL that reports to a node GL and is not itself reported to by any other GL.

Node GL

A GL that reports to a main head GL above it and is itself reported to by leaf GLs' under it.

MIS Class

An identifier for the kind of entity that is identified as the basis for MIS reporting

LCY

The local currency in which profit and loss entries can be posted to a GL. Reporting will obtain details in this currency.

FCY

A foreign currency in which record of the profit and loss entries posted to a GL can be maintained.

Chart of Accounts

The structure or framework in which the different GL's are maintained, in the bank

Contingent Asset

One of the categories of head GLs that can be maintained in the structure, for the posting of entries related to contingent assets.

Contingent Liability

One of the categories of head GLs that can be maintained in the structure, for the posting of entries related to contingent liabilities.

Position Accounting

Maintaining the position of a foreign currency, by setting up a Position GL and a Position Equivalent GL for each foreign currency

Reporting Lines

Unique codes assigned to each financial information head required for the Head Office and Central Bank. Reporting lines can be associated with the appropriate GL's that would report to them.

10. Function ID Glossary

Symbols

>\$ENDRANGE>GLSCHACC 3-22

G

GLDBRPRM6-3

GLDCHACC3-2

GLDCLSMT6-2

GLDREP5-4

GLDXGLLN 5-2

GLDXLINE 4-1, 5-1

GLDXWBAL 7-2

GLSCHACC3-22-??

S

STDGLCMT 6-5

STDGLTRF 7-1