

**Oracle® Communications
Convergent Charging Controller**

Diameter Control Agent Technical Guide

Release 6.0.1

April 2017

Copyright

Copyright © 2017, Oracle and/or its affiliates. All rights reserved.

This software and related documentation are provided under a license agreement containing restrictions on use and disclosure and are protected by intellectual property laws. Except as expressly permitted in your license agreement or allowed by law, you may not use, copy, reproduce, translate, broadcast, modify, license, transmit, distribute, exhibit, perform, publish, or display any part, in any form, or by any means. Reverse engineering, disassembly, or decompilation of this software, unless required by law for interoperability, is prohibited.

The information contained herein is subject to change without notice and is not warranted to be error-free. If you find any errors, please report them to us in writing.

If this is software or related documentation that is delivered to the U.S. Government or anyone licensing it on behalf of the U.S. Government, then the following notice is applicable:

U.S. GOVERNMENT END USERS: Oracle programs, including any operating system, integrated software, any programs installed on the hardware, and/or documentation, delivered to U.S. Government end users are "commercial computer software" pursuant to the applicable Federal Acquisition Regulation and agency-specific supplemental regulations. As such, use, duplication, disclosure, modification, and adaptation of the programs, including any operating system, integrated software, any programs installed on the hardware, and/or documentation, shall be subject to license terms and license restrictions applicable to the programs. No other rights are granted to the U.S. Government.

This software or hardware is developed for general use in a variety of information management applications. It is not developed or intended for use in any inherently dangerous applications, including applications that may create a risk of personal injury. If you use this software or hardware in dangerous applications, then you shall be responsible to take all appropriate fail-safe, backup, redundancy, and other measures to ensure its safe use. Oracle Corporation and its affiliates disclaim any liability for any damages caused by use of this software or hardware in dangerous applications.

Oracle and Java are registered trademarks of Oracle and/or its affiliates. Other names may be trademarks of their respective owners.

Intel and Intel Xeon are trademarks or registered trademarks of Intel Corporation. All SPARC trademarks are used under license and are trademarks or registered trademarks of SPARC International, Inc. AMD, Opteron, the AMD logo, and the AMD Opteron logo are trademarks or registered trademarks of Advanced Micro Devices. UNIX is a registered trademark of The Open Group.

This software or hardware and documentation may provide access to or information about content, products, and services from third parties. Oracle Corporation and its affiliates are not responsible for and expressly disclaim all warranties of any kind with respect to third-party content, products, and services unless otherwise set forth in an applicable agreement between you and Oracle. Oracle Corporation and its affiliates will not be responsible for any loss, costs, or damages incurred due to your access to or use of third-party content, products, or services, except as set forth in an applicable agreement between you and Oracle.

Contents

About This Document	v
Document Conventions	vi
Chapter 1	
System Overview	1
Overview	1
What is Diameter Control Agent?	1
Chapter 2	
Configuration.....	5
Overview.....	5
Configuration Overview	5
eserv.config Configuration	6
SLEE.cfg Configuration	7
RAR Configuration.....	8
acs.conf Configuration.....	9
Prepaid Charging Configuration	9
Feature Node Configuration	11
INAP Extensions.....	12
Parameter Mappings	14
Business Scenarios	18
Chapter 3	
Background Processes	23
Overview.....	23
diameterControlAgent Process	23
DCADefaults Configuration Section	24
DCAInstances Configuration Section	34
Services Configuration	58
PeerSchemes Configuration Section	73
Statistics Logged by diameterControlAgent	78
Chapter 4	
Service Specific AVP Mappings.....	81
Overview.....	81
Introduction	81
Basic Array	83
Key Array.....	86
Array with Conditions.....	89
Array with Context	99
Conditional AVP	104
Prefix Tree	112
Timestamp.....	114

Chapter 5

Control Plans 117

Overview.....	117
Check Balance	117
Direct Debiting.....	118
Price Enquiry	119
Refund Account.....	120
Session No Redirect.....	121
Session Redirect	122
Screening	124

Chapter 6

About Installation and Removal 127

Overview.....	127
Installation and Removal Overview.....	127
Checking the Installation	127

Chapter 7

Diameter Charging Agent Call Flows 129

Call Flow Overview.....	129
Initial Request Success	129
Initial Request Release Call	130
Initial Request Multiple Requested Service Units	130
AVP Pass-Through DCA to DCD	132
Screening Successful.....	133
Screening Call Disallowed.....	134
Screening Failure	134
Update Request.....	135
Terminate Request.....	135

Glossary of Terms 137

Index 143

About This Document

Scope

The scope of this document includes all the information required to install, configure and administer the Diameter Control Agent application.

Audience

This guide was written primarily for system administrators and persons installing, configuring and administering the Diameter Control Agent application. However, sections of the document may be useful to anyone requiring an introduction to the application.

Prerequisites

A solid understanding of UNIX and a familiarity with IN concepts are an essential prerequisite for safely using the information contained in this technical guide. Attempting to install, remove, configure or otherwise alter the described system without the appropriate background skills, could cause damage to the system; including temporary or permanent incorrect operation, loss of service, and may render your system beyond recovery.

A familiarity with the Diameter protocol is also required. Refer to the following:

- Internet Engineering Task Force (IETF) specifications:
 - RFC 3588 – Diameter Base Protocol
 - RFC 4006 – Diameter Credit-Control Application
 - RFC 4005 – Diameter Network Access Server Application
- 3GPP TS 32.299 V11.3.0 (2012-03) – 3rd Generation Partnership Project; Technical Specification Group Service and System Aspects; Telecommunication management; Charging management; Diameter charging applications (Release 11)

Although it is not a prerequisite to using this guide, familiarity with the target platform would be an advantage.

This manual describes system tasks that should only be carried out by suitably trained operators.

Related Documents

The following documents are related to this document:

- *Advanced Control Services Technical Guide*
- *Charging Control Services Technical Guide*
- *Charging Control Services User's Guide*
- *Service Management System Technical Guide*
- *Service Management System User's Guide*
- *Service Logic Execution Environment Technical Guide*

Document Conventions

Typographical Conventions

The following terms and typographical conventions are used in the Oracle Communications Convergent Charging Controller documentation.

Formatting Convention	Type of Information
Special Bold	Items you must select, such as names of tabs. Names of database tables and fields.
<i>Italics</i>	Name of a document, chapter, topic or other publication. Emphasis within text.
Button	The name of a button to click or a key to press. Example: To close the window, either click Close , or press Esc .
Key+Key	Key combinations for which the user must press and hold down one key and then press another. Example: Ctrl+P or Alt+F4 .
Monospace	Examples of code or standard output.
Monospace Bold	Text that you must enter.
<i>variable</i>	Used to indicate variables or text that should be replaced with an actual value.
menu option > menu option >	Used to indicate the cascading menu option to be selected. Example: Operator Functions > Report Functions
hypertext link	Used to indicate a hypertext link.

Specialized terms and acronyms are defined in the glossary at the end of this guide.

System Overview

Overview

Introduction

This chapter provides a high-level overview of the application. It explains the basic functionality of the system and lists the main components.

It is not intended to advise on any specific Oracle Communications Convergent Charging Controller network or service implications of the product.

In this Chapter

This chapter contains the following topics.

What is Diameter Control Agent? 1

What is Diameter Control Agent?

Introduction

The Diameter Control Agent (DCA) is a SLEE interface used to translate between Diameter messages and CAP 3 INAP.

Diameter is a protocol which has been designed to supersede RADIUS, and which facilitates AAA (Authentication, Authorization and Accounting), and Credit-Control. This protocol forms the basis of a Credit-Control solution for Oracle IMS (IP Multimedia Subsystem) products.

The DCA acts as a Diameter based credit control server. In doing so, it provides an interface to the Prepaid Charging product (CCS component), to facilitate the use of the billing functionality provided there.

Features

The DCA provides the following features:

- Provides support for AVPs specified in TS 32.299.
 - Allows an AVP to be mapped to any INAP operation argument; for example, InitialDP.calledPartyNumber
 - Allows AVPs from any CCR to be mapped to ACS profile fields
 - Allows ACS Profile fields to be mapped to any CCA response sent to a CC-Client
 - Allows specification of complex mappings between AVPs and ACS Profile fields (including type ARRAY)
- Supports call-screening without the need to start a billing session.
- Provides free call support (the ability to send DIAMETER_CREDIT_CONTROL_NOT_APPLICABLE as a response).
- Support for Mobile Network operators (MNO) who provide their own variations on 3GPP and IETF Diameter standards for Credit Control, including:
 - Service triggering

- Extensions to standards based enumerated values
- Default units may be assumed by operators, but be specified explicitly later in the call flows
- Ability to track elapsed-time at the interface and report back to the client
- Allows result-codes set by the interface to be mapped
- Supports the use of non-standard capabilities negotiation

Per-Message Type AVP Mapping

The AVP mapping rules configurable in DCA are:

- CCR INITIAL_REQUEST
- CCR EVENT_REQUEST
- CCA INITIAL_REQUEST
- CCA EVENT_REQUEST
- CCR UPDATE_REQUEST (one or more existing services) + CCA UPDATE_REQUEST
- CCR TERMINATION_REQUEST + CCA TERMINATION_REQUEST

Diagram

Here is a high level diagram showing Diameter Control Agent in the context of Convergent Charging Controller components.

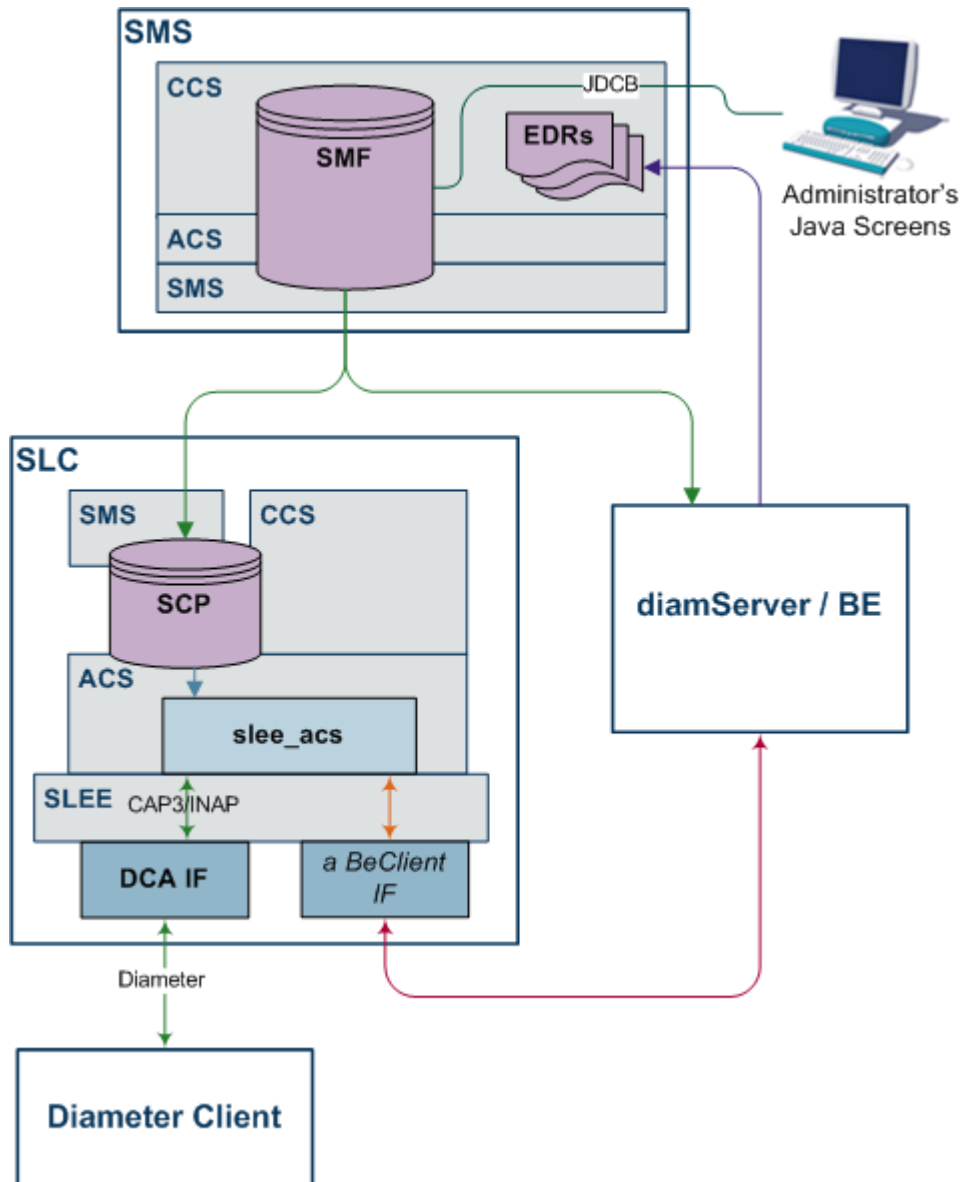

DCA Components

In this diagram, the components that are specific to DCA are:

- Diameter Client
- Diameter messages
- DCA interface
- CAP3/INAP within the SLEE

Screening

DCA screening provides the ability to configure one or more service entries in the `eserv.config` file that do not specify a Service-Identifier or a Rating-Group. Additionally, these services contain a flag indicating that they are for screening. Screening is only available if no default Rating-Group has been specified in the config file.

When a Diameter Initial CCR is received by DCA with no Service-Identifier or Rating-Group, DCA will check the configured services for a service that matches the remaining AVPs. If such a service is found, then the corresponding control plan will be triggered.

The control plans used for screening can perform logic, and will return the result of screening by returning either a continue for success, or a release for failure. In both cases, extra information can be passed between the CCR/CCA and ACS using the inbound and outbound AVP mapping features listed in *Per-Message Type AVP Mapping* (on page 2).

On receipt of the continue or release from ACS, DCA will shut down the dialog to ACS, and return the relevant response to Diameter.

Refer to the following:

- Configuration file parameter `screeningService` (on page 63) in the Services section
- ACS Control Plan for *Screening* (on page 124)

Configuration

Overview

Introduction

This chapter explains how to configure the Oracle Communications Convergent Charging Controller application.

In this chapter

This chapter contains the following topics.

Configuration Overview	5
eserv.config Configuration	6
SLEE.cfg Configuration	7
DCA SLEE Configuration	7
RAR Configuration.....	8
acs.conf Configuration.....	9
Prepaid Charging Configuration	9
Feature Node Configuration	11
INAP Extensions.....	12
Parameter Mappings	14
Business Scenarios	18

Configuration Overview

Introduction

This topic provides a high level overview of how the Diameter Control Agent (DCA) interface is configured.

There are configuration options which are added to the configuration files that are not explained in this chapter. These configuration options are required by the application and should not be changed.

Configuration Components

The Diameter Control Agent is configured by the following components:

Component	Locations	Description	Further Information
eserv.config	All SLC machines	DCA is configured by the <code>DIAMETER</code> section of eserv.config .	<i>eserv.config Configuration</i> (on page 6).
eserv.config	All SLC machines	DCA services mappings are configured in the <code>ccsServiceLibrary</code> section of eserv.config .	<i>CCS Service Library configuration</i> (on page 9).
SLEE.cfg	All SLC machines	The SLEE interface is configured to include the DCA	<i>SLEE.cfg Configuration</i> (on page 7) and <i>SLEE Technical</i>

Component	Locations	Description	Further Information
		service.	<i>Guide.</i>
acs.conf	All SLC machines	Configures the cc extension Digits/INAP extension mappings	<i>acs.conf Configuration</i> (on page 9)

eserv.config Configuration

Introduction

The **eserv.config** file is a shared configuration file, from which many Oracle Communications Convergent Charging Controller applications read their configuration. Each Convergent Charging Controller machine (SMS, SLC, and VWS) has its own version of this configuration file, containing configuration relevant to that machine. The **eserv.config** file contains different sections; each application reads the sections of the file that contains data relevant to it.

The **eserv.config** file is located in the `/IN/service_packages/` directory.

The **eserv.config** file format uses hierarchical groupings, and most applications make use of this to divide the options into logical groupings.

Configuration File Format

To organize the configuration data within the **eserv.config** file, some sections are nested within other sections. Configuration details are opened and closed using either `{ }` or `[]`.

- Groups of parameters are enclosed with curly brackets – `{ }`
- An array of parameters is enclosed in square brackets – `[]`
- Comments are prefaced with a `#` at the beginning of the line

To list things within a group or an array, elements must be separated by at least one comma or at least one line break. Any of the following formats can be used, as in this example:

```
{ name="route6", id = 3, prefixes = [ "00000148", "0000473" ] }
{ name="route7", id = 4, prefixes = [ "000001049" ] }
```

or

```
{ name="route6"
  id = 3
  prefixes = [
    "00000148"
    "0000473"
  ]
}
{ name="route7"
  id = 4
  prefixes = [
    "000001049"
  ]
}
```

or

```
{ name="route6"
  id = 3
  prefixes = [ "00000148", "0000473" ]
}
{ name="route7", id = 4
  prefixes = [ "000001049" ]
}
```

eserv.config Files Delivered

Most applications come with an example **eserv.config** configuration in a file called **eserv.config.example** in the root of the application directory. The example file for DCA is:

```
/IN/service_packages/eserv.config.dca.example
```

Warning: This file is not intended to be changed by the User. Please contact the Oracle support with your queries.

Editing the File

Open the configuration file on your system using a standard text editor. Do not use text editors, such as Microsoft Word, that attach control characters. These can be, for example, Microsoft DOS or Windows line termination characters (for example, ^M), which are not visible to the user, at the end of each row. This causes file errors when the application tries to read the configuration file.

Always keep a backup of your file before making any changes to it. This ensures you have a working copy to which you can return.

Loading eserv.config Changes

If you change the configuration file, you must restart the appropriate parts of the service to enable the new options to take effect.

Diameter eserv.config Configuration

The **eserv.config** file must be configured to enable the DCA to work. All necessary DCA configuration in **eserv.config** is done at installation time by the configuration script. However, you must manually map the service handles for services to the `libdcaCcsSvcExtra.so` library in the `ccsPluginExtend` section of `ccsServiceLibrary`. Refer to *CCS Service Library configuration* (on page 9).

Note: The DCA configuration options in **eserv.config** are explained in the section on the *diameterControlAgent background process* (on page 23).

SLEE.cfg Configuration

Introduction

The **SLEE.cfg** file must be configured to enable the DCA to work. All necessary SLEE configuration is done at installation time by the configuration script, this section is for information only.

The SLEE configuration file is located at `/IN/service_packages/SLEE/etc/SLEE.cfg`.

For more information on SLEE configuration, see *SLEE Technical Guide*.

DCA SLEE Configuration

On installation, the following lines are added to the **SLEE.cfg** configuration file.

```
INTERFACE=dcaIf dca.sh /IN/service_packages/DCA/bin EVENT
SERVICEKEY=INTEGER 1230 Dca_Session
SERVICEKEY=INTEGER 1231 Dca_DD
SERVICEKEY=INTEGER 1232 Dca_RA
SERVICEKEY=INTEGER 1233 Dca_CB
SERVICEKEY=INTEGER 1234 Dca_PE
SERVICE=Dca_Session 1 slee_acs Dca_Session
SERVICE=Dca_DD 1 slee_acs Dca_DD
SERVICE=Dca_RA 1 slee_acs Dca_RA
```

```
SERVICE=Dca_CB 1 slee_acs Dca_CB
SERVICE=Dca_PE 1 slee_acs Dca_PE
```

Note: It is essential for the correct operation of this application that the SLEE Interface type is always set to EVENT.

SERVICEKEY

The SERVICEKEY entries specify the SLEE service keys for the Diameter service.

During dcaScp installation the value of the service keys can be specified, or modified manually after installation, if necessary.

RAR Configuration

Diameter Charging Driver (DCD) can forward re-authorization requests (RARs) to DCA for forwarding on to network elements such as the Online Charging Server (OCS). You enable DCA to process RARs by setting the following parameter:

```
rarHandlingEnabled = true
```

When RAR processing is enabled in DCA, DCA informs DCD that it can process RAR messages, and DCD uses this information to pass on any RARs it receives from the OCS. DCA then forwards the re-authorization response that it receives back from the network to DCD, for DCD to forward on to the OCS. If DCD is not informed by DCA, then DCD will respond to a RAR with a re-authorization acknowledgement (RAA) containing the corresponding result code set in the `rarResultCode` parameter.

Add the following parameters to the DIAMETER configuration section in the `eserv.config` file to enable DCA to process RARs:

```
DIAMETER = {
  DCAInstances = {

    rarHandlingEnabled = true
    rarClientTimeout = int
    rarMaxRetry = int

  }
}
```

See *DCAInstances Parameters* (on page 36) for more information.

You must also add service library entries to the CCS section of the `eserv.config` file using the following syntax:

```
CCS = {
  ccsServiceLibrary = {

    ccsPluginExtend = {
      library="libdcdCcsSvcExtra.so"
      handleName="Dca_Session"
    }
  }
}
```

where `Dca_Session` is the name of the DCA session service.

Ensure the corresponding SERVICEKEY and SERVICE entries in the SLEE configuration file (`SLEE.cfg`) are present for the DCA session service. For example:

```
SERVICEKEY=INTEGER 1230 Dca_Session
SERVICE=Dca_Session 1 slee_acs Dca_Session
```

For more information on RAR processing in DCD, see the RAR configuration section in *Diameter Charging Driver Technical Guide*.

acs.conf Configuration

Introduction

The `acs.conf` file must be configured to enable the application to work. All necessary configuration is done at installation time by the configuration script; this section is for information only.

The ACS configuration file is located at `/IN/service_packages/ACS/etc/acs.conf`.

Refer to *ACS Technical Guide* for details on ACS configuration.

INAP Extension

The following values for cc extension Digits and INAP extension mappings and format are set in `acs.conf` on installation. You can change these, if required.

```
extensionNumber 3 506 asn1Integer value
extensionNumber 4 507 asn1Integer value
extensionNumber 5 501 asn1Integer value
extensionNumber 6 502 asn1Integer value
extensionNumber 7 503 asn1Integer value
extensionNumber 8 504 asn1Integer value
extensionNumber 9 505 octets value
```

Note: The `extensionNumber n` is displayed as `CC Extension Digits n` in the drop-down fields (for example, **Number of Events**) in the macro node configuration screens. See *Control Plans* (on page 117) for examples.

Prepaid Charging Configuration

CCS Service Library configuration

In order for the `PRICE_ENQUIRY`, `DIRECT_DEBITING` and `REFUND_ACCOUNT` services to work properly, you must manually map the service handles for these services to the `libdcaCcsSvcExtra.so` library in the `CCS.ccsServiceLibrary.ccsPluginExtend` section of the `/IN/service_packages/eserv.config` file. For example:

```
CCS = {
    ...
    ccsServiceLibrary = {
        ...
        ccsPluginExtend = [
            {
                library="libdcaCcsSvcExtra.so"
                handleName="Dca_PE"
            }
            {
                library="libdcaCcsSvcExtra.so"
                handleName="Dca_DD"
            }
            {
                library="libdcaCcsSvcExtra.so"
                handleName="Dca_RA"
            }
        ]
    }
}
```

```

    }
  ]
  ...

```

Enabling Named Events

The DCA installation does as much as possible to be usable as soon as it is installed. However, you need to perform one manual procedure in Prepaid Charging before you try to use it first-off. You need to allow the use of the named events that are installed to whatever product types that you employ,

Here is an example of the procedure to follow to allocate product types to a DCA event set.

- | Step | Action |
|------|--|
| 1 | In the SMS main screen, open Services > Prepaid Charging > Rating Management .
Result: The Rating Management screen will display. |
| 2 | Select the Named Event tab. |
| 3 | From the Event Set drop-down box, select DCA Sample Events. |

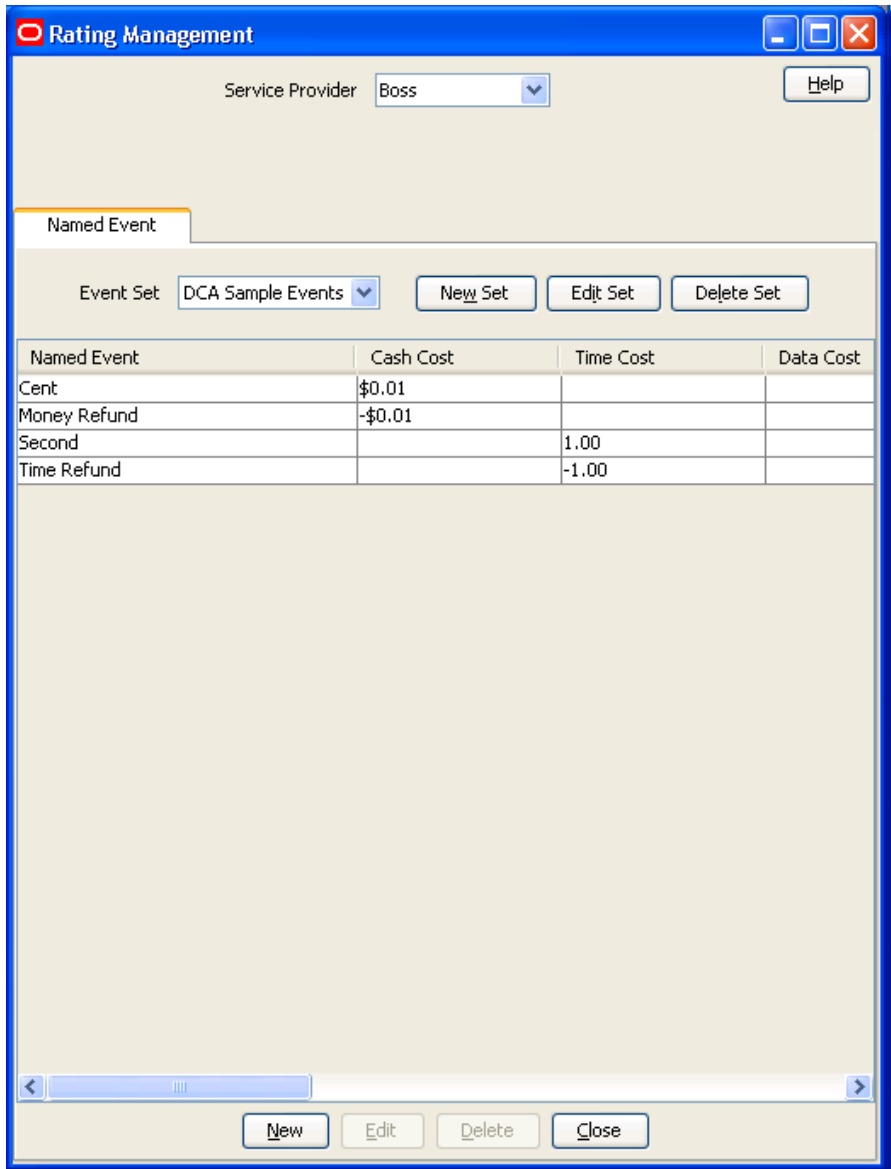

Step	Action
4	From the Named Event grid, select <code>Cent</code> and click Edit . Result: The Edit Named Event screen appears.

- 5 From the **Available Named Event Catalogues** field, select the named event catalogues for this event that will use DCA billing and click **>> Add >>**.
- 6 Click **Save**.
- 7 Repeat steps 4 through 6 for the `Second` named event.

Refer to *CCS User's Guide, Named Event* topic for details.

Feature Node Configuration

Named Event Node

The Named Event node must be configured as shown for the following fields:

- Event Class – A Diameter (DCA) event class
- Number of Events Location – Incoming Session Data

- Number of Events Field – CC Extension Digits 5

Configure Named Event

Node name:

Event Class:

Named Event:

Number of Events

Node dialog Profile

Number of Events:

Number of Events Data Type:

Number of Events Location:

Number of Events Field:

Discount Percentage

Discount:

Allow Negative Balance

Allow:

Named Event Feature Selection

Direct Event Reserve Event Confirm Event Revoke Event Cost of Event

Store Cost

Store Cost:

Charge Cost

ChargeCost Data Type:

ChargeCost Location:

ChargeCost Field:

Exit Branches

1	Success	2	No Credit
3	Billing Fault	4	Unsupported

INAP Extensions

Introduction

As INAP is not designed to contain Diameter AVPs, these will be carried, where necessary, in INAP extensions in the InitialIDP or the Connect. The following pre-defined INAP extension types are used, where appropriate.

The IDP extensions are used by the service loader plug-in to modify the CCS/ACS call context. Also, the control plans may access these extensions by means of suitable `acs.conf` configuration and by use of the `ExtensionDigits[0-9]` call context fields. See *Control Plans* (on page 117) for examples of control plans using these extensions.

In addition, inbound extension profiles may be set using the `encodedExtension` and `extensionFormat` parameters. This enables inbound AVPs within INITIAL or EVENT based Credit-Control-Request messages to be identified for mapping into the IDP passed to ACS. Multiple AVPs can be identified and passed to the target profile tags available within the inbound extensions block.

Note: While you can have multiple AVP mappings, you can have only *three* extension mappings from DCA to `slee_acs`. You can create extension mappings either by specifying an encoded extension value, for example `extensionType = 508`, or by encoding as an extension profile block, which is extension type 701. Note that all profile tags go into one profile block and therefore use only one extension.

Therefore, if you define a profile encoded AVP, you have only 2 more user-defined extensions available. For example, you can have either three AVPs mapped directly to INAP extensions or two AVPs mapped directly to INAP extensions and multiple AVPs that are encoded in one profile block that is mapped to extension type 701.

IDP

The following standard INAP extensions are used in the IDP. This table also lists the mapping of the INAP extensions to the Call Content extension Digits profile buffers.

Extension	Description	Type	cc extension Digits
501	Requested-Service-Units	Asn1Integer	5
502	Requested service unit type: <ul style="list-style-type: none"> • 1 = CC-Time • 2 = CC-Money • 3 = CC-Total-Octets • 4 = CC-Input-Octets • 5 = CC-Output-Octets • 6 = CC-Service-Specific-Units 	Asn1Integer	6
503	Requested-action: <ul style="list-style-type: none"> • 0 = DIRECT_DEBITING • 1 = REFUND_ACCOUNT • 2 = CHECK_BALANCE • 3 = PRICE_ENQUIRY 	Asn1Integer	7
504	Event-Timestamp	Asn1Integer	8
505	Subscription ID	Asn1OctetString	9
506	Currency	Asn1Integer. Value from ISO 4217, for example, 978 = Euro	3
507	Exponent	Asn1Integer. Currency exponent + 0x20. for example, 1E for -2	4
701	Multiple encoded AVPs	Inbound extension profile block	

Note: The cc extension Digits-INAP extension mappings are set in `acs.conf` on installation and can be changed, if required. See *acs.conf Configuration* (on page 9).

Connection

The following INAP extensions are used in the Connect operation.

Extension	Description	Type
601	Granted service units	Asn1Integer
602	Granted service unit type: <ul style="list-style-type: none"> • 1 = CC-Time • 2 = CC-Money • 3 = CC-Total-Octets • 4 = CC-Input-Octets • 5 = CC-Output-Octets • 6 = CC-Service-Specific-Units 	Asn1Integer
603	Cost information (in system currency)	Asn1OctetString

Parameter Mappings

Introduction

This topic describes the mappings between INAP parameters and Diameter AVPs.

CCR

This table describes the mappings for Credit-Control-Request AVPs.

AVP	Action
Session-Id	Used to look up the correct StateMachine in sessionIdToStateMachine .
Origin-Host	The stack code in the DIAMETER module handles this.
Origin-Realm	The stack code in the DIAMETER module handles this.
Destination-Realm	The stack code in the DIAMETER module handles this.
Auth-Application-Id	Throw it out if not 4
Service-Context-Id	Used as part of the key to look up the service.
CC-Request-Type	Used as part of the key to look up the service. Also used to determine the next state in the state machine.
CC-Request-Number	Used in duplicate detection.
Destination-Host	The stack code in the DIAMETER module handles this.
User-Name	Ignored unless mapped to an IDP extension by the AVP mappings in eserv.config .
CC-Sub-Session-Id	Ignored after copying from the request to the answer message. We do not support multiple session IDs but some clients may set this anyway so we just ignore it.
Acct-Multi-Session-Id	Ignored after copying from the request to the answer message. We do not support multiple session IDs but some clients may set this anyway so we just ignore it.
Origin-State-Id	Used to detect a client re-booting and wipe sessions for the host if it has rebooted.

AVP	Action
Event-Timestamp	For EVENT_REQUEST messages, this gets copied into IDP extension type 504.
Subscription-Id	<p>One or more Subscription-Id AVPs may be supplied. The first SIP or E164 type Subscription-Id is copied to:</p> <ul style="list-style-type: none"> • CallingPartyNumber after applying the configured normalization rules and • IDP extension type 505. <p>The first IMSI type Subscription-Id is copied to IMSI.</p> <p>Note: There must be an E164 or SIP type Subscription -Id present. Otherwise the message will be rejected.</p>
Service-Identifier	Used as part of the key to look up the service.
Termination-Cause	Use <code>cmnDebug()</code> to trace this if this transaction is being traced. Otherwise, ignore.
Requested-Service-Unit	<p>The type of the service unit (derived from which sub-AVP is contained within this one) is placed in IDP extension type 502. The value of the sub-AVP is placed in IDP extension type 501.</p> <p>Multiple unit types are supported. You can perform Basic and MSCC services, with the following provisos:</p> <ul style="list-style-type: none"> • The units in Initial request are the units for the whole session, that is, you cannot add another unit mid-session. • If one unit fails to be granted, the entire service is denied. • Multiple units are not suitable for use in event based credit control, because the call or dialog with ACS is a one-shot for each type (likely through a Named Event node). If multiple calls are opened to ACS and one of them happens to fail, it is too late for DCA to go back and revoke the successful cases.
Requested-Action	<p>Used as part of the key to look up the service.</p> <p>Also used to determine the next state in the state machine.</p>
Used-Service-Unit	The cumulative total of all the Used-Service-Unit AVPs is copied to <code>ApplyChargingReport.timeNoTariffSwitch</code> (multiplied by 10 to be in deciseconds if the unit type is Time). The variable <code>dca::StateMachine::totalUsedUnits</code> is used for storing this information.
Multiple-Services-Indicator	<p>If this is set to <code>MULTIPLE_SERVICES_SUPPORTED</code> then DCA will accept the incoming message and subsequent Multiple-Services-Credit-Control AVPs received in CCR/CCA update and final request messages.</p> <p>Note: This parameter will not be mapped to the InitialDP.</p>
Multiple-Services-Credit-Control	<p>This is a grouped AVP that can contain these AVPs:</p> <ul style="list-style-type: none"> • Requested-Service-Unit • Used Service-Unit • Service-Identifier • Rating Group <p>Requires that Multiple-Services-Indicator AVP has been received with value set to <code>MULTIPLE_SERVICES_SUPPORTED</code>.</p> <p>For multiple services credit control, a single session typically comprises multiple services. Each service is identified by either the Service-identifier</p>

AVP	Action
	<p>or Rating-Group (where no Service-identifier). Requests received are handled as follows:</p> <ul style="list-style-type: none"> INITIAL-REQUEST – One IDP is sent for each service. The Diameter session will have multiple INAP dialogs with <code>slee_acs</code>. UPDATE-REQUEST for a new Service-identifier/Rating-Group – Starts a new service within the session and causes DCA to send another IDP. UPDATE-REQUEST with no requested-service-unit AVP – Ends a service within the session. TERMINATION-REQUEST – Ends the whole session. <p>Note:</p> <ul style="list-style-type: none"> If more than one unit type is received within this AVP, DCA will recognize the used-service-unit AVP in update and termination request messages and will extract the relevant unit used. Typically this will be the unit previously specified in the granted service unit. If no relevant unit is found then DCA returns CCA (Multiple-Services-Credit-Control(result-Code = DIAMETER_INVALID_AVP_VALUE)).
Service-Parameter-Info	Ignored unless mapped to an IDP extension by the AVP mappings in <code>eserv.config</code> .
CC-Correlation-Id	Ignored unless mapped to an IDP extension by the AVP mappings in <code>eserv.config</code> .
User-Equipment-Info	Ignored unless mapped to an IDP extension by the AVP mappings in <code>eserv.config</code> .
Proxy-Info	The stack code in the DIAMETER module handles this.
Route-Record	Ignored at present.

CCA

This table describes the mappings for Credit-Control-Answer AVPs.

AVP	Set from
Session-Id	The Session-Id AVP of the first message in this transaction. (stored in <code>dca::StateMachine:: sessionId</code>)
Result-Code	Set to DIAMETER_SUCCESS unless otherwise stated.
Origin-Host	The stack code in the DIAMETER module sets this.
Origin-Realm	The stack code in the DIAMETER module sets this.
Auth-Application-Id	Set to 4
CC-Request-Type	Leave as the stack default, that is, the value of CC-Request-Type from the corresponding request.
CC-Request-Number	Leave as the stack default, that is, the value of CC-Request-Number from the corresponding request.
User-Name	Not set
CC-Session-Failover	Not set (will default to FAILOVER-NOT-SUPPORTED according to <i>RFC 4006</i>)
CC-Sub-Session-Id	Set to the value from the corresponding request message, of present.
Acct-Multi-	Set to the value from the corresponding request message, of present.

AVP	Set from
Session-Id	
Origin-State-Id	Set to <code>dca::ControlAgent::originStateId</code> .
Event-Timestamp	Set to the value of the Event-Timestamp AVP from the corresponding request.
Granted-Service-Unit	For session based services, this is <code>ApplyCharging.maxDuration</code> (divided by 10 if the unit type is Time). The unit type is obtained from the "DCA Unit Type" profile tag, if it is available in the <code>ApplyCharging</code> extension profile block. For Requested-Action type <code>DIRECT_DEBIT</code> , in the success case, this is the same as the Requested-Service-Unit AVP in the corresponding request. Otherwise, not present.
Multiple-Services-Credit-Control	DCA will populate the MSCC AVPs in CCA messages with the following sub-AVPs where applicable: <ul style="list-style-type: none"> • Granted-Units • Rating-Group or Service-Identifier • Result-Code • Time-Quota-Threshold (AVP code 868) • Volume-Quota-Threshold (AVP code 869) • Validity-Time (if applicable) • Final-Unit-Indication (if applicable) <p>Note: Both Time-Quota-Threshold AVP and Volume-Quota-Threshold AVP will be sent with:</p> <ul style="list-style-type: none"> • Vendor_ID 10415 • Quota-Threshold value 0
Cost-Information	For Request-Action type <code>PRICE_ENQUIRY</code> , success case, this comes from the value of extension 603 in the INAP Connect. Otherwise, not set.
Final-Unit-Indication	Final-Unit-Action is set to <code>REDIRECT</code> or <code>TERMINATE</code> depending on the INAP operations received. Redirect-Server is set to the number matched in the <code>redirectNumbers</code> config list or <code>TEL:<Connect destinationRoutingAddress>@<Configured SIP host></code> .
Check-Balance-Result	This is derived from the type of INAP operation received as described in the <i>Check balance, with a result of enough credit</i> (on page 20) scenario.
Credit-Control-Failure-Handling	Set to <code>TERMINATE</code> .
Direct-Debiting-Failure-Handling	Not set. (According to <i>RFC 4006</i> , it will default to <code>TERMINATE_OR_BUFFER</code>).
Validity-Time	Set to the configured validity-time for the service in the graceful termination scenarios only. See the <i>Funds expiry, redirect, top-up and reconnect</i> (on page 21) scenario.
Redirect-Host	Not set.
Redirect-Host-Usage	Not set.
Redirect-Max-Cache-Time	Not set.
Proxy-Info	The stack code in the DIAMETER module sets this.
Route-Record	Not set at the moment.

AVP	Set from
	If we set this in the future, the stack code in the DIAMETER module will set this.
Failed-AVP	Set in some cases when Result-Code != success.

Business Scenarios

Introduction

This topic explains how the flow through the software achieves Diameter server services and also gives more details on the mapping between INAP operations/parameters and Diameter messages/AVPs.

The following scenarios are based on (and named after) the relevant appendixes in *RFC 4006*.

For each business scenario, a message sequence chart is given.

For sample message flows, refer also to the *DCA Messages Flows* chapter in *Sample Message Flows Reference Guide*.

Successful session-based charging, client terminates session

Here is an example successful session-based charging, client terminates session.

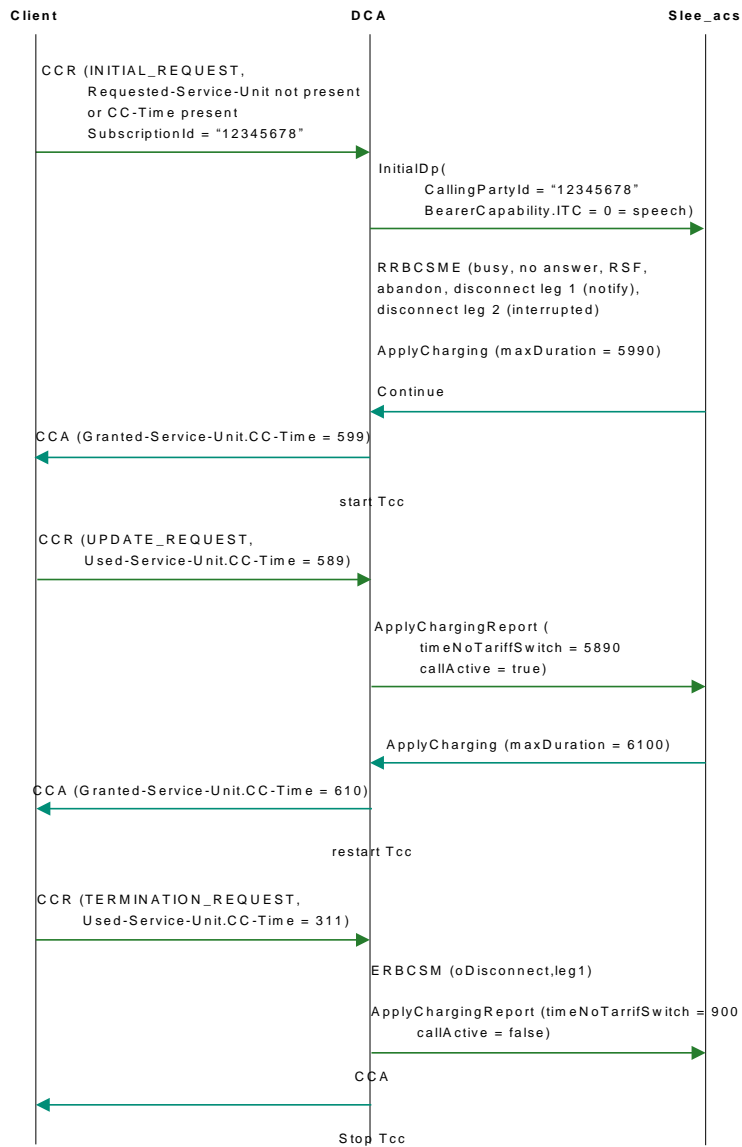

Multimedia messaging direct debit scenario

Here is an example multimedia messaging direct debit scenario.

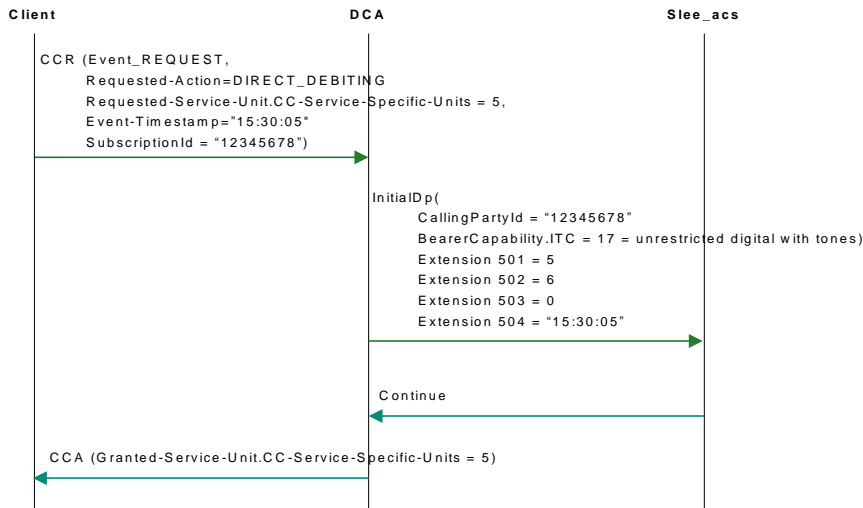

Check balance, with a result of enough credit

Here is an example check balance, with a result of enough credit.

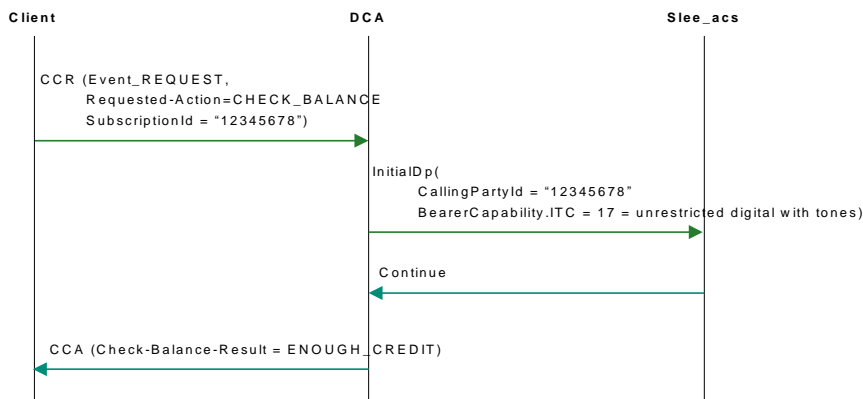

Price enquiry

Here is an example price enquiry.

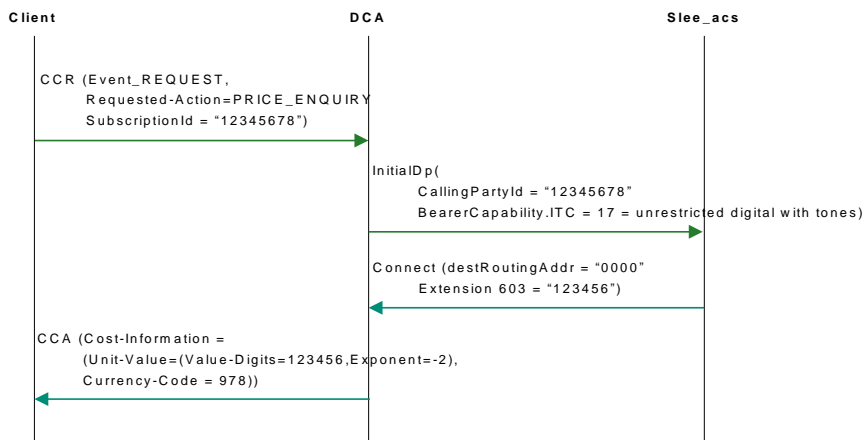

Funds expiry, redirect, top-up and reconnect

Here is an example funds expiry, redirect, top-up and reconnect.

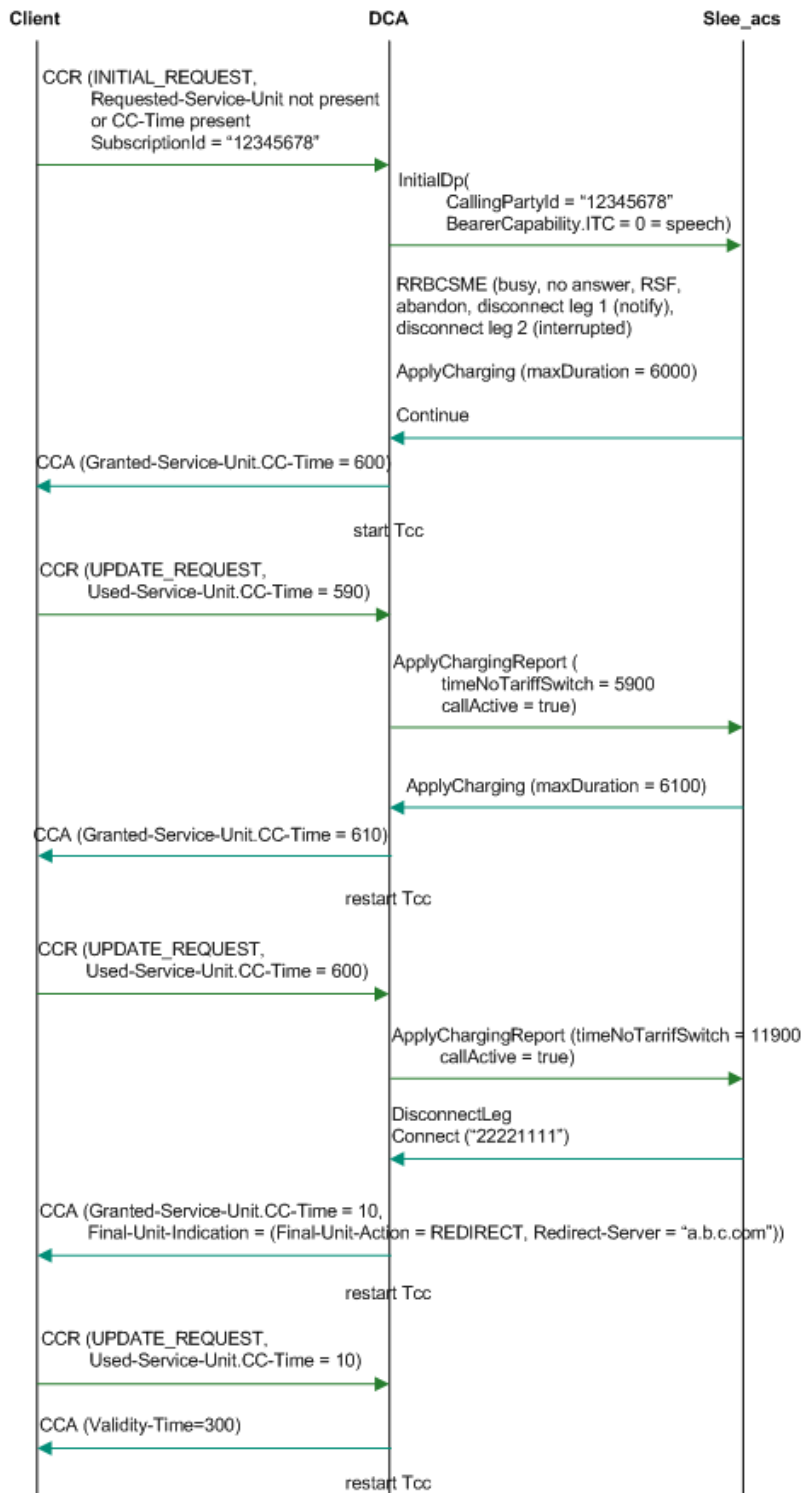

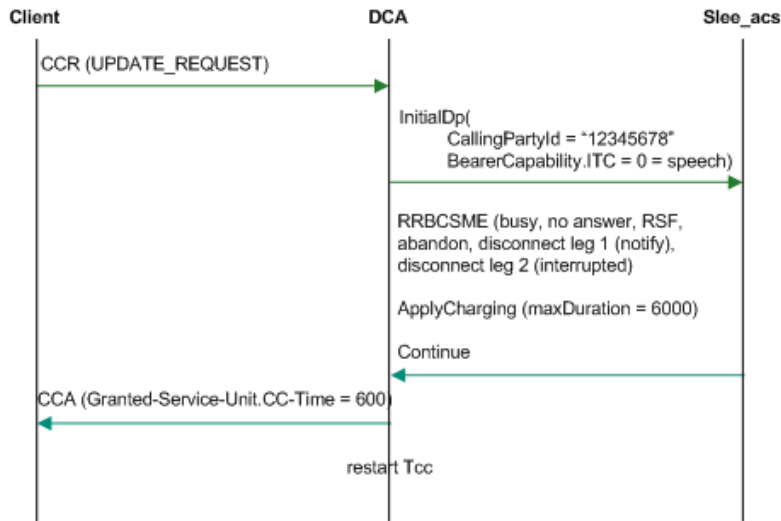

Multiple services credit control scenario

Here is an example multiple services credit control scenario.

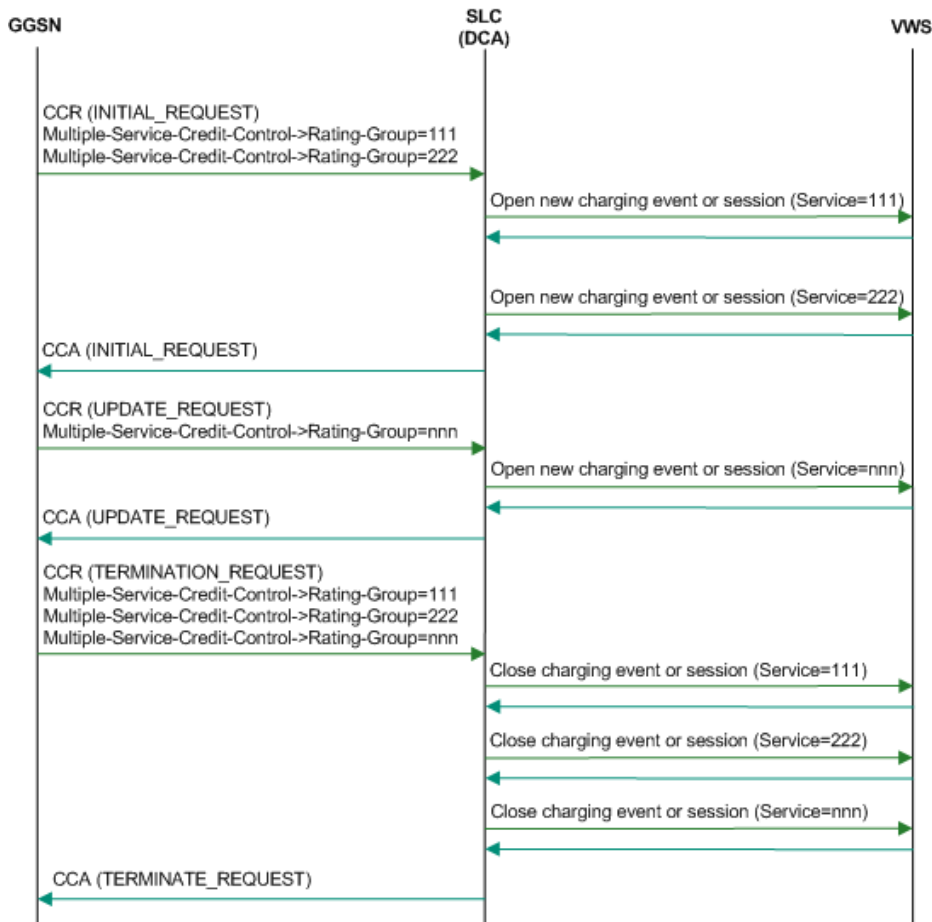

Background Processes

Overview

Introduction

This chapter explains the process which runs automatically as part of the Oracle Communications Convergent Charging Controller application. This process is started automatically by the SLEE.

In this chapter

This chapter contains the following topics.

diameterControlAgent Process	23
DCADefaults Configuration Section	24
DCAInstances Configuration Section	34
Services Configuration	58
PeerSchemes Configuration Section	73
Statistics Logged by diameterControlAgent	78

diameterControlAgent Process

Purpose

The diameterControlAgent executable is a SLEE interface which converts between Diameter messages and CAP3 operations to enable a Diameter client to communicate with a CAP3 SCF.

Startup

This process is started automatically by the SLEE. For more information see *SLEE.cfg Configuration* (on page 7).

DIAMETER Configuration Structure

Here is the high-level structure of the `DIAMETER` configuration section of the `eserv.config` file.

```
DIAMETER = {
    DCADefaults = {
        DCADefaults_parameters
    }

    DCAInstances = [
    # First Instance
    {
    NumberRules = [
        NumberRules_parameters
    ]
        DCAInstances_parameters
    ]

    RedirectNumberMappings = [
```

```
{
    RedirectNumberMappings_parameters
}
]

Tracing = {
    Tracing_parameters
}

Services = [
{
    Services_parameters
}
]

DiameterServer = {
    DiameterServer_parameters
}

} # end of First Instance

] # end of DCAInstances section

PeerSchemes = [
# First Scheme
{
    schemeName = "SchemeA"

    Peers = [

        {
            peerhost1_parameters
        }
        {
            peerhost2_parameters
        }

    ]

}

{
    schemeName = "SchemeB"
    SchemeB_parameters
}

] # End of PeerSchemes section
```

Failure

If the diameterControlAgent fails, no Diameter messages will be processed.

DCADefaults Configuration Section

Example DCADefaults Configuration in eserv.config File

Here is an example DCADefaults section of the DIAMETER configuration in the **eserv.config** file.

```
DCADefaults = {
    sleeServiceKey = 1234
    inapServiceKey = 1234
    maxSessionLengthAfterFinalUnitIndicationsSeconds = 14340
    tcc = 3600
}
```

```

gracefulTerminationValidityTime = 300
validityTime = 30
systemErrorResultCode = 5012
invalidMessageSequenceResultCode = 5012
itc = "udi"

AvpMappings = [
{
  AvpCodes = [
  {
    avpCode = 1234
    mandatory = true
    vendorId = "16747"
  }
  ]

  avpFormat = "OctetString"
  sipScheme = "sip"
  extensionType = 1234
  extensionFormat = "inapnumber"

  conversion = [
    { internal = 1, external = 5030 }
    { internal = 16, external = 2001 }
    { internal = 17, external = 3004 }
    { internal = 42, external = 5006 }
    { internal = 111, external = 3001 }
  ]
  mappingTypes = ["InitialRequest", "InitialResponse", "EventRequest",
"EventResponse"]
}
]
}

```

DCADefaults Parameters

The following parameters are used as defaults if not specified in a Service. They are found within the `DCADefaults = { }` statement.

avpMappings

Syntax: `avpMappings = [mappings_parameters]`
Description: The default service AVP mappings.
Optionality: Mandatory
Notes: See *AvpMappings Parameters* (on page 28).

gracefulTerminationValidityTime

Syntax: `gracefulTerminationValidityTime = seconds`
Description: The number of seconds granted for the user to top up the account during graceful termination. Refer to *RFC 4006 A.7*.
Type: Integer
Optionality: Optional
Allowed: in seconds
Default:
Notes: Not present means no graceful termination.
Example: `gracefulTerminationValidityTime = 300`

`inapServiceKey`

Syntax: `inapServiceKey = value`
Description: The INAP Key value
Type: Integer
Optionality: Mandatory
Allowed: Any 32 bit integer
Example: `inapServiceKey = 1234`

`invalidMessageSequenceResultCode`

Syntax: `invalidMessageSequenceResultCode = code`
Description: The error code for an invalid message sequence result, for example, if TERMINATION_REQUEST is the first message.
Type: Integer
Optionality: Mandatory
Allowed:
Default: 5012 [Diameter unable to comply]
Notes: See Part 7.1 of *RFC 3588* and Part 9 of *RFC 4006* for a list valid codes.
Example: `invalidMessageSequenceResultCode = 5012`

`itc`

Syntax: `itc = infoTransferCapability`
Description: The Bearer Capability Information Element (Q.931 section 4.5.5) contains an Information Transfer Capability (ITC) field that is set automatically by DCA when DCA triggers ACS.
This parameter overrides the ITC value within the Bearer Capability Information Element.
For more details, please see `itc` (on page 62) parameter under the Services section.
Type: Integer, or string
Optionality: Optional
Allowed:
Default:
Notes: If automatic setting of ITC is required, then this parameter should be absent.
Example: `itc = 16`
or
`itc = "3.1kHzAudio"`
or
`itc = 0x10`

`mappingTypes`

Syntax: `mappingTypes = ["mapping_types"]`
Description: Specifies the cases that the mapping applies to.
Type: String Array
Optionality: Optional
Allowed:

Default:

Notes: For more details, please see the `mappingTypes` (on page 70) parameter under the Services section.

Example: `mappingTypes = ["InitialRequest", "UpdateRequest", "EventRequest", "TerminateRequest"]`

`maxSessionLengthAfterFinalUnitIndicationsSeconds`

Syntax: `maxSessionLengthAfterFinalUnitIndicationsSeconds = secs`

Description: The maximum number of seconds that a session can last after the Final-Unit-Indication AVP has been sent to the client.

Type: Integer

Optionality: Optional (default used if not set).

Allowed: A valid integer.

Default: 14340

Example: `maxSessionLengthAfterFinalUnitIndicationsSeconds = 14340`

`sleeServiceKey`

Syntax: `sleeServiceKey = value`

Description: The Service Key value

Type: Integer

Optionality: Mandatory

Allowed: *Refer to SLEE Technical Guide*

Default: N/A

Example: `sleeServiceKey = 1234`

`systemErrorResultCode`

Syntax: `systemErrorResultCode = code`

Description: The error code for a system error

Type: Integer

Optionality: Mandatory

Allowed:

Default: 5012 [Diameter unable to comply]

Notes: See Part 7.1 of *RFC 3588* and Part 9 of *RFC 4006* for a list valid codes

Example: `systemErrorResultCode = 5012`

`tcc`

Syntax: `tcc = value`

Description: The Session supervision timer timeout

Type: Integer

Optionality: Mandatory

Allowed: number of seconds

Default: 3600

Notes: Refer to *RFC 4006*.

Example: `tcc = 3600`

`validityTime`

Syntax: `validityTime = seconds`

Description: The validity time in seconds of granted units. Results in Validity-Time AVP being placed in CCA.

Type: Integer

Optionality: Optional (default used if not set).

Allowed:

Default: -1 (Not included)

Notes:

Example: `validityTime = 30`

AvpMappings Parameters

The following parameters are used for AVP mappings. They are all found within an `AvpMappings = []` array.

You can set up as many AVP mappings as required.

Within this section you can specify AVP codes for mapping. They are all found within an `AvpCodes = []` array.

There MUST be one specified for the base AVP, plus list all extras for grouped AVPs.

AVP Format to Extension Type

This table shows the allowable conversion of AVP format to the Extension type.

AVP Format	Extension Type	Notes
OctetString	INAP Number	Not allowed
Time	INAP Number	Not allowed
String/OctetString	Integer	<ul style="list-style-type: none"> • Must be ASCII digits • Converts to Integer
String	INAP Number	Must be Hex digits
Integer	String/Octets	Converts to string
Time	Integer	Number of seconds since 1 January 1970
Time	String/Octets	In format <code>YYYYMMDDHH24mmss</code>

AVP Casting

Casting between the AVP format and the encoded extension format is supported only for encoded extension formats with variable sizes. All other encoded extension formats are fixed in size and cannot be casted. In the `eserv.config` file, encoded extension formats are defined by the `profileFormat` parameter. See *profileFormat* (on page 69) for more information.

This table shows the `profileFormat` values that have variable sizes (which can be casted) versus fixed sizes (which cannot be casted).

Size Type	profileFormat Value
Variable size	LNSTRING, STRING, NSTRING, and RAW_DATA
Fixed size	INTEGER, INTEGER64, UINTEGER, UINTEGER64, TIME, BOOLEAN,

Size Type	profileFormat Value
	and ARRAY

For example, the following configuration casts an OctetString AVP format (1 byte) as a STRING encoded extension format (1 byte), which is supported:

```
{
  AvpCodes = [
    {
      avpCode = 21 # RAT-Type
      mandatory = true
      vendorId = 10415
    }
  ]
  avpFormat = "OctetString"
  encodedExtension = {
    profileTag = 6760105
    profileFormat = "STRING"
  }
}
```

In contrast, the following configuration attempts to cast an OctetString AVP format (1 byte) as an INTEGER encoded extension format (4 bytes), which is not supported:

```
{
  AvpCodes = [
    {
      avpCode = 21 # RAT-Type
      mandatory = true
      vendorId = 10415
    }
  ]
  avpFormat = "OctetString"
  encodedExtension = {
    profileTag = 6760105
    profileFormat = "INTEGER"
  }
}
```

avpCode

Syntax: avpCode = *code*
Description: The AVP code for this AVP.
Type: Integer
Optionality: Mandatory
Notes: This parameter is an element of the `AvpCodes` parameter array.
Example: avpCode = 1234

AvpCodes

Syntax: AvpCodes = [avpcodes]
Description: The AVP code[s] specifying the AVP.
Type: Array
Optionality: Optional
Allowed:
Default:

Notes: FULLY-QUALIFIED AVP CODE:
If more than 1 element is specified in this array, the AvpCodes refer to a Fully-Qualified "path" into the AVP hierarchy.

RELATIVE AVP CODE:
If only a single entry is specified and if this "AvpCodes" is used within the "AVPs" Array Section, each element in "AvpCodes" is relative and all the nested AVPs collectively form the complete "path" to specifying the AVP within the hierarchy.

Example:

```
AvpCodes = [  
  {  
    avpCode = 1234  
    mandatory = true  
    vendorId = "16747"  
  }  
]
```

avpFormat

Syntax: `avpFormat = "format"`

Description: The format of the AVP.

Type: String

Optionality: Mandatory

Allowed: Allowed values are:

- "OctetString"
- "Integer32"
- "Integer64"
- "Unsigned32"
- "Unsigned64"
- "Address"
- "Time"
- "UTF8String"
- "DiameterIdentity"
- "DiameterURI"
- "Enumerated"
- "Grouped" – Only valid if used in *Service Specific AVP Mappings* (on page 81)

Example: `avpFormat = "OctetString"`

conversion

Syntax: `conversion = [mappings]`

Description: For Integer type formats, you can use this parameter to define a conversion table (for outbound mapping) for further mapping of internal (typically INAP cause, or acsProfile values) to external (that is, Diameter AVP) values.

Type: Parameter array

Optionality: Optional

Allowed:

Default:

Notes:

Example: This example is mapping from internal INAP Cause codes to its Diameter Result-Code.

```
conversion = [
  { internal = 1, external = 5030 }
  { internal = 16, external = 2001 }
  { internal = 17, external = 3004 }
  { internal = 42, external = 5006 }
  { internal = 111, external = 3001 }
]
```

extensionFormat

Syntax: extensionFormat = "*format*"

Description: The format of the extension in ACS.

Type: String

Optionality: Optional

Allowed:

- "inapnumber"
- "asn1integer"
- "octets"
- "encoded" – Only valid if used in Service Specific AVP Mappings. See *encodedExtension* (on page 67).

Notes:

Example: extensionFormat = "inapnumber"

extensionType

Syntax: extensionType = *type*

Description: The InitialDP extension type

Type: Integer

Optionality: Mandatory

Notes: Cannot be a pre-defined INAP extension
nonProfile Encoded Extensions should be considered deprecated

Example: extensionType = 1234

external

Syntax: external = *value*

Description: The external value to be put into the AVP to be sent.

Type: Integer

Optionality: Optional

Allowed:

Default:

Notes: Member of the *conversion* section.

Example: external = 5030

internal

Syntax: internal = *value*

Description: The internal value (typically INAP cause or acsProfile values) from ACS.

Type: Integer

Chapter 3

Optionality: Optional
Allowed:
Default:
Notes: Member of the `conversion` section.
Example: `internal = 1`

mandatory

Syntax: `mandatory = true|false`
Description: Whether the AVP code is mandatory
Type: Boolean
Optionality: Optional
Allowed: true, false
Default: false
Notes: This parameter is an element of the `AvpCodes` parameter array.
Example : `mandatory = true`

noa

Syntax: `noa = value`
Description: The Nature of Address (NOA) for the INAP number. If a SIP Address AVP telephone number is not international, the NOA of a mapped INAP Number will be set to the value specified in this parameter.
Type: Integer
Optionality: Optional (default used if not set).
Allowed:

- 1 – Subscriber
- 2 – Unknown
- 3 – National
- 4 – International

Default: 4
Notes: The NoA field of an INAP Number will be set to International (4) if the mapped SIP address AVP telephone number begins with '+'.
Example: `noa = 2`

sipScheme

Syntax: `sipScheme = "sip_scheme"`
Description: Indicates that the AVP contains a SIP address conforming to the URL scheme configured.
Type: String
Optionality: Optional (default used if not present).
Allowed: Allowed values:

- "sip"
- "tel"

Default: *parameter not present*. No mapping done.

Notes: If specified, the SIP address (if found in the AVP) will be extracted and used in the mapped field sent to ACS. See *sipScheme example configurations* (on page 33).

The following parameter must be set:

- `avpFormat = "UTF8String"` - if not set, AVP mapping will be ignored.

If a `sipScheme` is used, the destination is restricted. It can only be mapped to one of the following:

- `inapField`
- `extensionFormat` (of "inapnumber", or "octets")

If not specified, this indicates that the AVP does not contain a SIP address, so no address information will be extracted from the AVP.

Example: `sipScheme = "sip"`

sipScheme example configurations

The following examples illustrate the use of the `sipScheme` parameter in the `AvpMappings` configuration, and the resulting mappings.

Example 1

Map AVP 1000 to the `calledPartyNumber` field in IDP. For example, with "sip:+12125551212@phone2net.com;tag=887s", the digits **+12125551212** are mapped to `calledPartyNumber`.

```
{
  AvpCodes = [
    {
      avpCode = 1001
    }
  ]
  avpFormat = "UTF8String"
  sipScheme = "sip"
  inapField = ["calledPartyNumber"]
  mappingTypes = ["InitialRequest"]
}
```

Example 2

Map AVP 2000 to extension 7890 of type `InapNumber`. For example, with "tel:+358-555-1234567", the digits **+358-555-1234567** are mapped to extension 7890.

```
{
  AvpCodes = [
    {
      avpCode = 2000
    }
  ]
  avpFormat = "UTF8String"
  sipScheme = "tel"
  extensionFormat = "inapnumber"
  extensionType = 7890
  mappingTypes = ["InitialRequest"]
}
```

Example 3

Map AVP 2000 to extension 8000 of type `InapNumber`. For example, with "tel:555-1234567", the digits **555-1234567** are mapped to extension 8000. Because the number is not internationalized (no leading '+'), you must set the Nature of Address (`noa` parameter) to the configured value of 2.

```
{
  AvpCodes = [
    {
      avpCode = 2000
    }
  ]
  avpFormat = "UTF8String"
  sipScheme = "tel"
  noa = 2
  extensionFormat = "inapnumber"
  extensionType = 8000
  mappingTypes = ["InitialRequest"]
}
```

vendorId

Syntax: vendorId = "id"
Description: The vendor specific AVP, if present.
Type: String
Optionality: Optional
Notes: This parameter is an element of the AvpCodes parameter array.
Example: vendorId = "16747"

DCAInstances Configuration Section

Introduction

Due to the size and complexity of the `DCAInstances` configuration, the description is broken down into the following topics:

- *DCAInstances Parameters* (on page 36)
- *NumberRules Parameters* (on page 43)
- *RedirectNumberMappings Parameters* (on page 45)
- *Tracing Parameters* (on page 46)
- *DiameterServer parameters* (on page 48)
- *Services Configuration* (on page 58)
- *Service Specific AVP Mappings* (on page 81)

DCAInstances configuration structure

Here is the high level structure of the configuration of an instance in the `DCAInstances` section of the `DIAMETER` configuration in the `eserv.config` file.

```
DCAInstances = [
  # First Instance
  {
    NumberRules = [
      NumberRules_parameters
    ]

    dummyDestination = "0000"
    systemCurrencyCode = 978
    systemCurrencyExponent = -2

    multipleServicesRatingGroup = 0
  }
]
```



```

allowDefaultRatingGroup = false

customDefaultUnits = false

dontDiscardRatingGroupInResponse = true

SIPDomain = "SIP_Domain"
SIPPrefix = "SIP_prefix"

ignoreRSU = true
}
rarHandlingEnabled = false
rarClientTimeout = 30
rarMaxRetry = None

RedirectNumberMappings = [
{
  RedirectNumberMappings_parameters
}
]

Tracing = {
  Tracing_parameters.
}

instanceName = "dcaIf"
scheme = "SchemeA"
systemErrorResultCode = 5012
invalidMessageSequenceResultCode = 5012
sessionBasedDuplicateDetection = true
returnServiceResultCodeInRoot = false
ggsnSupportsFinalUnitIndication = true
ccDuplicateStoreSize = 20
maxAnswerReorder = 2
roundingThreshold = "0.5"
roundingDetail = "ceil"
SubscriptionIdTypes = [
  0,
  2,
  1
]

Services = [
{
  Services_parameters.
}
]

DiameterServer = {
  DiameterServer_parameters
}

} # end of First Instance

] # end of Instances section

```

Note: Default settings are specified at installation time.

DCAInstances Parameters

Here are the parameters for the `DCAInstances` section.

`allowDefaultRatingGroup`

Syntax:	<code>allowDefaultRatingGroup = true false</code>
Description:	Whether or not to use the default Rating Group.
Type:	Boolean
Optionality:	Optional (default used if not set).
Allowed:	If set to: <ul style="list-style-type: none"> <code>true</code> and if no Service-Identifier AVP or Rating-Group AVP is received in the initial request CCR, DCA will use the Default Rating Group defined in <code>multipleServicesRatingGroup</code>. <code>false</code> DCA will not use the default Rating Group but instead will wait for the Service-Identifier AVP or Rating-Group AVP in the subsequent request.
Default:	<code>false</code>
Notes:	
Example:	<code>allowDefaultRatingGroup = false</code>

`ccDuplicateStoreSize`

Syntax:	<code>ccDuplicateStoreSize = value</code>
Description:	The number of credit-control messages to maintain, when checking for duplicates.
Type:	Integer
Optionality:	Optional (default used if not set).
Allowed:	
Default:	<code>20</code>
Notes:	Requires <code>sessionBasedDuplicateDetection</code> to be set to <code>true</code> .
Example:	<code>ccDuplicateStoreSize = 10</code>

`customDefaultUnits`

Syntax:	<code>customDefaultUnits = true false</code>
Description:	Applies only when multiple service credit control (MSCC) is in use. Try to accommodate operator-specific ways of handling default units in the following circumstances: <ul style="list-style-type: none"> An initial request with an MSCC having: <ul style="list-style-type: none"> • A Used-Service-Unit AVP containing CC-Time = 0 • No Requested-Service-Unit AVP An update request with an MSCC having: <ul style="list-style-type: none"> • An Used-Service-Unit AVP containing CC-Time = <actual used> • No Requested-Service-Unit AVP
Type:	Boolean
Optionality:	Optional (default used if not set)

- Allowed:**
- true – DCA behaves as if the RSU had been specified with the unit type of CC-Time.
 - false – DCA behaves as it normally does if no RSU has been specified.

Default: false

Notes:

Example: `customDefaultUnits = true`

`dummyDestination`

Syntax: `dummyDestination = "num"`

Description: Used as the Called Party Number in the InitialDP.

Type: Number string

Optionality: Mandatory

Allowed: Digits

Default: 0000

Notes: DCA requires a destination; however we do not use it.

Example: `dummyDestination = "0000"`

`dontDiscardRatingGroupInResponse`

Syntax: `dontDiscardRatingGroupInResponse = true|false`

Description: If set to true, and a Service-Identifier AVP, and a Rating-Group AVP are both received in the request AVP (for MSCC), then the Rating-Group AVP is returned in the CCA response. Otherwise the Rating-Group AVP is not returned.

Type: Boolean

Optionality: Optional (default used if not set).

Default: false

Example: `dontDiscardRatingGroupInResponse = false`

`ggsnSupportsFinalUnitIndication`

Syntax: `ggsnSupportsFinalUnitIndication = true|false`

Description: Whether or not the GGSN supports final unit indication AVPs.

Type: Boolean

Optionality: Optional (default used if not set).

Allowed: true, false

Default: true

Notes: A false value implies a non-compliant GGSN.

Example: `ggsnSupportsFinalUnitIndication = true`

`ignoreRSU`

Syntax: `ignoreRSU = true|false`

Description: Specifies whether DCA ignores any unit types in Requested-Service-Unit AVPs that are included in a request. This parameter applies to session request types only.

Type: Boolean

Optionality: Optional (default used if not set)

Chapter 3

- Allowed:**
- true – DCA ignores any unit types in Requested-Service-Unit AVPs that are included in a request by treating them like empty RSUs.
 - false – DCA recognizes all Requested-Service-Unit AVPs in requests.

Default: false

Notes:

Example: `ignoreRSU = true`

instanceName

Syntax: `instanceName = "name"`

Description: The unique identifying name for this instance.

Type: String

Optionality: Mandatory

Allowed: This must match the interface name in SLEE.cfg. See *SLEE.cfg Configuration* (on page 7).

Default: no default

Notes:

Example: `instanceName = "dcaIf"`

invalidMessageSequenceResultCode

Syntax: `invalidMessageSequenceResultCode = code`

Description: The error code for an invalid message sequence result, for example, if TERMINATION_REQUEST is the first message.

Type: Integer

Optionality: Mandatory

Allowed:

Default: 5012 [Diameter unable to comply]

Notes: See Part 7.1 of *RFC 3588* and Part 9 of *RFC 4006* for a list valid codes.

Example: `invalidMessageSequenceResultCode = 5012`

maxAnswerReorder

Syntax: `maxAnswerReorder = number`

Description: The maximum number of answers to consider for reordering, before giving up, and answering.

Type: Integer

Optionality: Optional (default used if not set).

Allowed:

Default: 10

Notes:

Example: `maxAnswerReorder = 2`

multipleServicesRatingGroup

Syntax: `multipleServicesRatingGroup = value`

Description: Rating Group value used to populate Rating Group AVPs in Multiple Services Credit Control AVPs.

Type: Integer

Optionality: Optional (default used if not set).

Allowed:
Default: 0
Notes:
Example: `multipleServicesRatingGroup = 3`

`originHostMustBeFQDN`

Syntax: `originHostMustBeFQDN = true`
Description: Sets whether the Origin-Host needs to be a fully qualified domain name.
Type: Boolean
Optionality: Optional (default used if not set)
Allowed: `true` = DCA will reject messages
`false` = DCA will accept messages
Default: `true`
Notes: With this parameter set to `true`, DCA will reject messages from an Origin-Host which is not a fully qualified domain name. If this parameter is set to `false`, DCA will accept messages regardless of the Origin-Host parameter.
Example: `originHostMustBeFQDN = true`

`rarClientTimeout`

Syntax: `rarClientTimeout = int`
Description: Specifies the time, in seconds, that the DCA will wait for an RAA response from the Diameter client
Type: Integer
Allowed: `>=0`
Default: 30
Notes: Set `rarClientTimeout` to 0 (zero) to disable timeouts.
Example: `rarClientTimeout=30`

`rarHandlingEnabled`

Syntax: `rarHandlingEnabled = true|false`
Description: Determines whether RAR Handling is enabled in DCD
Type: Boolean
Optionality: Optional (default used if not set)
Allowed: `true, false`
Default: `false`
Notes: When `rarHandlingEnabled` is set to `false`, the DCD responds to an RAR with an RAA containing the corresponding result code set in the `rarResultCode` parameter
Example: `rarHandlingEnabled = false`

`rarMaxRetry`

Syntax: `rarMaxRetry = int`
Description: Specifies the maximum number of times that the DCA will attempt to re-transmit an RAR to the Diameter client
Type: Integer
Allowed: `>=1`

Chapter 3

Default: None
Notes: A single re-transmit is allowed per timeout.

`returnServiceResultCodeInRoot`

Syntax: `returnServiceResultCodeInRoot = true|false`
Description: Whether or not service result codes should always be returned in the root level (against the dictates of RFC 4006).
Type: Boolean
Optionality: Optional (default used if not set).
Allowed: true, false
Default: false
Notes: A true value implies a non-compliant GGSN.
Important: This can only apply (work sensibly) where there is a single service.
Example: `returnServiceResultCodeInRoot = false`

`roundingThreshold`

Syntax: `roundingThreshold = "fraction"`
Description: The threshold for rounding fractional unit values to integers. Fractional parts less than this amount are rounded down, fractional parts greater than this amount are rounded up.
Type: String containing a float
Optionality: Optional (default used if not set).
Allowed: Between 0.0 and 1.0
Default: "0.5"
Notes: If you want to truncate, set this to "1".
If you want to round all non-integers upwards, then set this to "0" and use "floor" for `roundingDetail` parameter).
Example: `roundingThreshold = "0.5"`

`roundingDetail`

Syntax: `roundingDetail = "rounding"`
Description: The direction to round the number when the fractional part equals the `roundingThreshold`.
Type: String
Optionality: Optional (default used if not set)
Allowed: Allowed values are:

- "ceil" means upwards
- "floor" means downwards

Default: "ceil"
Notes:
Example: `roundingDetail = "ceil"`

`scheme`

Syntax: `scheme = "name"`
Description: The name of which scheme configuration this instance uses.
Type: String

Optionality: Mandatory
Allowed: This must be a `SchemeName` from the `PeerSchemes` section.
Default: no default
Notes:
Example: `scheme = "SchemeA"`

`sessionBasedDuplicateDetection`

Syntax: `sessionBasedDuplicateDetection = true|false`
Description: Whether to use CC-Request-Number and Session-Id for duplicate detection for session based services, as specified in *RFC 4006*. Otherwise the algorithm from *RFC 3588* is used.
Type: Boolean
Optionality: Mandatory
Allowed: true, false
Default: true
Notes: Set to false if the clients do not implement this mechanism from *RFC 4006*.
Example: `sessionBasedDuplicateDetection = true`

`SIPDomain`

Syntax: `SIPDomain= "domain"`
Description: The SIP domain for telephone redirections.
Type: String
Optionality: Mandatory
Allowed:
Default: no default
Notes: Used when no `redirectNumberMapping` exists for the given value.
Example: `SIPDomain = "oracle.com"`

`SIPPrefix`

Syntax: `SIPPrefix= "prefix"`
Description: The SIP prefix for telephone redirections.
Type: String
Optionality: Mandatory
Allowed:
Default: "tel+"
Notes: Used in `redirect-server-address` when connect received from `SLEE_acs`.
Used when no `RedirectNumberMapping` exists for the given value.
Example: `SIPDomain = "tel+"`

`SubscriptionIdTypes`

Syntax: `SubscriptionIdTypes = [Ids]`
Description: If there is more than one Diameter Subscription-ID in the request, the Subscription-ID with a Subscription-ID-Type nearest the top of this list is used.
Type: Integer array
Optionality: Optional (default used if not set).

Allowed: Subscription-ID-Types defined in *RFC 3588* are:

- 0 END_USER_E164
The identifier is in international E.164 format (for example, MSISDN), according to the ITU-T E.164 numbering plan defined in [E164] and [CE164].
- 1 END_USER_IMSI
The identifier is in international IMSI format, according to the ITU-T E.212 numbering plan as defined in [E212] and [CE212].
- 2 END_USER_SIP_URI
The identifier is in the form of a SIP URI, as defined in [SIP].
- 3 END_USER_NAI
The identifier is in the form of a Network Access Identifier, as defined in [NAI].
- 4 END_USER_PRIVATE
The Identifier is a credit-control server private identifier.

Default: 0, 2, 1

Notes: If an entry in the list is not matched, then a Diameter error is returned.

Example:

```
SubscriptionIdTypes = [
    0,
    2,
    1
]
```

systemCurrencyCode

Syntax: `systemCurrencyCode = code`

Description: The ISO 4217 code of the currency.

Type: Integer

Optionality: Mandatory

Allowed: ISO 4217 code of the currency.

Default: 978 (Euro)

Notes:

Example: `systemCurrencyCode = 978`

systemCurrencyExponent

Syntax: `systemCurrencyExponent = code`

Description: The exponent value of small units for a big unit in the currency.

Type: Integer

Optionality: Mandatory

Allowed:

Default: -2 (100 small units for every big unit.)

Notes:

Example: `systemCurrencyExponent = -2`

systemErrorResultCode

Syntax: `systemErrorResultCode = code`

Description: The error code for a system error

Type:	Integer
Optionality:	Mandatory
Allowed:	
Default:	5012 [Diameter unable to comply]
Notes:	See Part 7.1 of <i>RFC 3588</i> and Part 9 of <i>RFC 4006</i> for a list valid codes
Example:	<code>systemErrorResultCode = 5012</code>

NumberRules Parameters

The following parameters define the number normalization rules for DCA. They are found within `NumberRules = []`.

This section is optional.

Example NumberRules configuration

Here is an example `NumberRules` section of the `DCAInstances` configuration.

```
NumberRules = [
  { prefix="25", fromNoa=3, min=8, max=9, remove=0, prepend="0" }
  { fromNoa=4, remove=0, prepend="00" }
  { prefix="027", min=9, remove=1, resultNoa=3 }
  { prefix="00", min=5, remove=2, prepend="", resultNoa=4 }
]
```

`fromNoa`

Syntax:	<code>fromNoa = int</code>
Description:	Used when attempting to match the nature of address (NoA) number contained in a message. If there is a match, the <code>fromNoa</code> part of the number rule is evaluated.
Type:	Integer
Optionality:	Required
Allowed:	<ul style="list-style-type: none"> • 2 – For unknown NoAs • 3 – For national NoAs • 4 – For international NoAs
Notes:	If you omit <code>fromNoa</code> from the <code>NumberRules</code> parameter section, then no matching rule will be found.
Example:	<code>fromNoa = 3</code>

`max`

Syntax:	<code>max = num</code>
Description:	Specifies the maximum number of digits a number may contain. To meet the <code>max</code> part of the number rule, the number of digits in the number must be equal to or less than the value of <code>max</code> .
Type:	Integer
Optionality:	Optional (default used if not set)
Default:	999
Example:	<code>max = 9</code>

Chapter 3

min

Syntax:	<code>min = num</code>
Description:	Specifies the minimum number of digits a number may contain. To meet the min part of the number rule, the number of digits in the number must be equal to or greater than the value of <code>min</code> .
Type:	Integer
Optionality:	Optional (default used if not set)
Default:	0
Notes:	The value of the <code>min</code> parameter must be greater than or equal to the value of the <code>remove</code> (on page 44) parameter.
Example:	<code>min = 5</code>

prefix

Syntax:	<code>prefix = "pref"</code>
Description:	Contains a digit or digits. Used to attempt to match the first digit or digits of a prefix number with the specified value. If the digit or digits match, the prefix part of the number rule is met.
Type:	String
Optionality:	Optional
Allowed:	One or more decimal digits
Notes:	This parameter is an element of the <code>NumberRules</code> parameter array.
Example:	<code>prefix = "25"</code>

prepend

Syntax:	<code>prepend = "digits"</code>
Description:	Defines digits added to the beginning of a number.
Type:	String
Optionality:	Optional
Allowed:	Any combination of decimal digits, or a null string ("")
Notes:	<ul style="list-style-type: none">• If the <code>remove</code> and <code>prepend</code> parameters are both used in the same number rule, "<code>prepend</code>" is added to the beginning of the number after the number has been modified by the <code>remove</code> parameter.• The <code>prepend</code> parameter is an element of the <code>NumberRules</code> parameter array.
Example:	<code>prepend = "0"</code>

remove

Syntax:	<code>remove = num</code>
Description:	The number of digits stripped from the beginning of a number.
Type:	Integer
Optionality:	Required
Notes:	The value of the <code>remove</code> parameter must be less than or equal to the value of the <code>min</code> (on page 44) parameter.
Example:	<code>remove = 2</code>

resultNoa

Syntax:	<code>resultNoa = noa</code>
Description:	A nature of address (NOA) sent to the network.
Type:	Integer
Optionality:	Optional
Notes:	<ul style="list-style-type: none"> • A value is typically specified in demoralization rules • This parameter is an element of the <code>NumberRules</code> parameter array
Example:	<code>resultNoa = 4</code>

RedirectNumberMappings Parameters

The following parameters are used to map the redirect number. They are found within `RedirectNumberMappings = []`.

This section is optional.

Example RedirectNumberMappings configuration

Here is an example `RedirectNumberMappings` section of the `DCAInstances` configuration.

```
RedirectNumberMappings = [
{
  prefix = "641234"
  destination = "oracle.com"
  type = "SIP_URI"
}
]
```

destination

Syntax:	<code>destination = "address"</code>
Description:	The destination address string.
Type:	String
Optionality:	Mandatory if the <code>RedirectNumberMappings</code> section is included.
Allowed:	See <i>RFC 4006</i>
Default:	N/A
Example:	<code>destination = oracle.com</code>

prefix

Syntax:	<code>prefix = pref</code>
Description:	A prefix of the destination Routing Address in the connect.
Type:	Number string
Optionality:	Mandatory if the <code>RedirectNumberMappings</code> section is included.
Allowed:	Digits
Default:	N/A
Example:	<code>prefix = 641234</code>

type

Syntax:	<code>type = "type"</code>
Description:	The destination's type.
Type:	String

Optionality:	Required if the <code>RedirectNumberMappings</code> section is included.
Allowed:	<ul style="list-style-type: none"> • IPv4 • IPv6 • URL • SIP_URI
Default:	N/A
Example:	<code>type = "SIP_URI"</code>

Tracing Parameters

The following parameters are used for tracing activities. They are all found within the `Tracing = { }` statement.

Example Tracing configuration

Here is an example `Tracing` section of the `DCAInstances` configuration.

```
Tracing = {
    enabled = true

    OrigAddress = [
        "a.b.c.com.0064212",
        "a.b.c.com.0064213",
        "a.b.c.com.0064214"
    ]

    destinationAddressAvp = 1234

    DestAddress = [
        "a.b.c.com.0064213",
        "a.b.c.com.0064214"
    ]

    traceDebugLevel = "all"
}
```

destAddress

Syntax:	<code>destAddress = ["addr", "addr"]</code>
Description:	List of destination addresses that are to be traced.
Type:	String array
Optionality:	Optional
Allowed:	<ul style="list-style-type: none"> • Any valid addresses • ""
Default:	""
Notes:	<p>"" = trace all known destination addresses.</p> <p><code>destAddress</code> is set to <i>Dest-Realm.Subscription-Id</i>.</p>
Example values:	<pre>destAddress = ["a.b.c.com.0064213", "a.b.c.com.0064214"]</pre>

`destinationAddressAvp`

Syntax: `destinationAddressAvp = avp`
Description: The AVP to use in destination address as *RFC 4006* does not specify this.
Type: Integer
Optionality: Optional
Notes: If not specified, `destinationAddress` is hard-coded to 0000
Example: `destinationAddressAvp = 1234`

`enabled`

Syntax: `enabled = true|false`
Description: Switches tracing on or off.
Type: Boolean
Optionality: Optional
Allowed: true, false
Default: false
Notes: If false, then the parameters in the Tracing section are ignored.
Example: `enabled = false`

`origAddress`

Syntax: `origAddress = ["addr", "addr"]`
Description: List of originating addresses that are to be traced.
Type: String array
Optionality: Optional
Allowed:

- Any valid addresses
- ""

Default: ""
Notes: "" = trace all known originating addresses.
`origAddress` is set to `<Origin-Realm>.<Subscription-Id.>`
Example values:

```
origAddress = [
  "a.b.c.com.0064212",
  "a.b.c.com.0064213",
  "a.b.c.com.0064214"
]
```

`traceDebugLevel`

Syntax: `traceDebugLevel = "level"`
Description: The debug level the tracing be at should.
Type: String
Optionality: Mandatory
Notes: This is a string, with comma separation in it. See `traceDebugLevel` in *ACS Technical Guide*.
Useful flags are `cdaconfig`, `diameterControlAgent`, `cdaObjectCounts`
Example: `traceDebugLevel = "all"`

DiameterServer Parameters

The following parameters are used for a Diameter Server. They are all found within `DiameterServer` = { }.

Example DiameterServer Configuration

Here is an example `DiameterServer` section in the `DCAInstances` configuration.

```
DiameterServer = {
  protocol = "both"
  sctpListenPort = "3868"
  tcpListenPort = "3868"
  tcpBindAddress = "192.168.1.1"
  sctpBindAddress = "192.168.1.2"
  Auth-Application-Id = [ 4, 34, 42 ]
  Acct-Application-Id = 21
  Vendor-Specific-Application-Identifier = [
    {
      Vendor-Id = 111
      Auth-Application-Id = 1234
    }
    {
      Vendor-Id = 111
      Acct-Application-Id = 4321
    }
  ]
  localOriginHost = "creditcontrol.realm3.oracle.com"
  localOriginRealm = "realm3.oracle.com"
  productName = "oracle-dca"
  vendorId = 16247
  Supported-Vendor-Id = [ 16247, 10415 ]
  duplicateTime = 240
  duplicateBytes = 31457280
  connectionTimeout = 30
  watchdogPeriod = 30
  inBufferSize = 16384
  outBufferSize = 16384
  sendOriginStateId = false
  sendQuotaThreshold = true
  thirtyTwoBitQuotaThresholds = true
  percentTimeQuotaThreshold = 80
  percentVolumeQotaThreshold = 80
  commitGrantedOnTerminate = false
  allowMultiServiceIdentifier = false
  finalGrantUnused = false
  sessionLimit = 0
  throttleLimitError = 3004
  overLimitError = 3004
  counterLogInterval = 0
  throttleThreshold = 100
  throttleInterval = 100
  sendCreditLimitReachedOnSessionEnd = false
  chargeOnSessionTimeout = true
  sendAbortOnSessionTimeout = true
  commitGrantedOnSessionTimeout = true
  sessionFallbackTcc = 3600
} # End of DiameterServer section
```

Acct-Application-Id

syntax: Acct-Application-Id = [IDs]

Description: The Acct-Application-Id AVP values to include in the Capabilities Exchange message.

Type: Integer – Single value, or array
Optionality: Optional
Notes: This array may have one or more values, or no value.
 If there is only one value, brackets are not required.
 If neither `Auth-Application-Id`, nor `Acct-Application-Id` is specified,
 then `Auth-Application-Id = 4`.
Examples: `Acct-Application-Id = 21`

`allowMultiServiceIdentifier`

Syntax: `allowMultiServiceIdentifier = true|false`
Description: Whether or not more than one `Service-Identifier` is supported
 for MSSC with a single multiple service credit control AVP.
Type: Boolean
Optionality: Optional (default used if not set).
Allowed:

- `true` – More than one allowed. Triggers a service per `Service-Identifier`
- `false` – More than one not permitted. Only use the first `Service_Identifier`

Default: `false`
Notes:
Example: `allowMultiServiceIdentifier = true`

`Auth-Application-Id`

syntax: `Auth-Application-Id = [IDs]`
Description: The `Auth-Application-Id` AVP values to include in the Capabilities Exchange
 message.
Type: Integer – Single value, or array
Optionality: Optional (default used if not set)
Notes: For Credit control this is 4.
 This array may have one or more values, or no value.
 If there is only one value, brackets are not required.
 The first `Auth-Application-Id` (or 4 if none) is placed in that AVP in the CCR
 messages also.
 If neither `Auth-Application-Id`, nor `Acct-Application-Id` is specified,
 then `Auth-Application-Id = 4`.
Default: `4`
Examples: `Auth-Application-Id = [4, 34, 42]`
 or
`Auth-Application-Id = 4`

`chargeOnSessionTimeout`

Syntax: `chargeOnSessionTimeout = true|false`
Description: Indicates how DCA should manage a timeout with an access device (for example,
 GGSN).
Type: Boolean
Optionality: Optional (default used if not set).

Allowed: If set to true, DCA will attempt to finalize any sessions with ACS that are associated with the timed-out session - and..

there is an outstanding Apply Charging DCA will respond with an Apply Charging Report with either the Total Granted Units or Total Used Units depending on configuration.

a service's charging is via SMCB (armed to report oAnswer; no outstanding ACh) we send ERBCSM(oAnswer) to ACS.

Default: false

Notes:

Example: `chargeOnSessionTimeout = true`

`commitGrantedOnSessionTimeout`

Syntax: `commitGrantedOnSessionTimeout = true|false`

Description: Indicates whether DCA should request that the Total Granted Units or the Total Used Units should be committed.

Type: Boolean

Optionality: Optional (default used if not set).

Allowed:

Default: false

Notes:

Example: `commitGrantedOnSessionTimeout = false`

`commitGrantedOnTerminate`

Syntax: `commitGrantedOnTerminate = true|false`

Description: Whether or not to commit granted funds on session terminate where the used units are not specified.

Type: Boolean

Optionality: Optional (default used if not set).

- Allowed:**
- true – Commit granted (that is, charges for granted units)
 - false – Only commit reported used units (that is, does not charge)

Default: false

Notes:

Example: `commitGrantedOnTerminate = true`

`connectionTimeout`

Syntax: `connectionTimeout = seconds`

Description: How long to wait for a reply before considering there is a transport level problem

Type: Integer

Optionality: Mandatory

Allowed: Seconds

Default: 30

Example: `connectionTimeout = 30`

`counterLogInterval`

Syntax:	<code>counterLogInterval = secs</code>
Description:	The interval in seconds between sending request counts to the syslog file. Set to 0 (zero) if you do not want to log requests.
Type:	Integer
Optionality:	Optional (default used if not set).
Allowed:	
Default:	600
Notes:	This parameter is also used to control the frequency of notice messages that log the number of requests received, and the frequency of warning messages that log the number of throttled requests.
Example:	<code>counterLogInterval = 0</code>

`duplicateBytes`

Syntax:	<code>duplicateBytes = bytes</code>
Description:	How many bytes to allocate to the duplicate detection buffer
Type:	Integer
Optionality:	Mandatory
Default:	31457280 (30 MB)
Example:	<code>duplicateBytes = 31457280</code>

`duplicateTime`

Syntax:	<code>duplicateTime = seconds</code>
Description:	How long to hold End-to-End Identifiers, when considering them for potential duplicates.
Type:	Integer
Optionality:	Mandatory
Allowed:	Seconds
Default:	240
Example:	<code>duplicateTime = 240</code>

`finalGrantUnused`

Syntax:	<code>finalGrantUnused = true false</code>
Description:	Whether or not to allow re-granting of unused units after a final unit indication is sent.
Type:	Boolean
Optionality:	Optional (default used if not set).
Allowed:	true, false
Default:	false
Notes:	
Example:	<code>finalGrantUnused = true</code>

`inBufferSize`

Syntax:	<code>inBufferSize = size</code>
Description:	The size, in bytes, of inbound transport buffer.

Type: Integer
Optionality: Mandatory
Allowed:
Default: 0 (kernel default)
Example: `inBufferSize = 16384`

`throttleLimitError`

Syntax: `throttleLimitError = Int`
Description: The error code generated when a throttle limit is breached.
Type: Integer
Optionality: Optional (default used if not set)
Allowed:
Default: 3004 – Diameter too busy
Notes:
Example: `throttleLimitError = 5006`

`overLimitError`

Syntax: `overLimitError = int`
Description: Sets the error code to use in a throttle-generated CCA, and when rejecting a session because the memory or session limit has been exceeded.
Type: Integer
Optionality: Optional (default used if not set).
Allowed:
Default: 3004 – Diameter too busy
Notes:
Example: `overLimitError = 3004`

`protocol`

Syntax: `protocol = "protocol"`
Description: The protocol for this server.
Type: String
Optionality: Mandatory
Allowed:

- "sctp"
- "tcp"
- "both"

Default: "tcp"
Example: `protocol = "tcp"`

`sctpBindAddress`

Syntax: `sctpBindAddress = "addr"`
Description: The SCTP port to listen on for this instance.
Type: String
Optionality: Mandatory
Default: 0 (that is, INADDR_ANY)
Example: `sctpBindAddress = "192.168.1.2"`

`sctpListenPort`

Syntax: `sctpListenPort = "port"`
Description: The SCTP port to listen on
Type: String
Optionality: Mandatory
Default: "3868"
Example: `sctpListenPort = "3868"`

`sessionLimit`

Syntax: `sessionLimit = int`
Description: Limits the number of credit control sessions that may be created to the specified value.
Type: Integer
Optionality: Optional (default used if not set).
Allowed: A positive value.
Default: 0 – Do not apply a limit.
Notes:
Example: `sessionLimit = 0`

`tcpBindAddress`

Syntax: `tcpBindAddress = "addr"`
Description: The TCP port to listen on for this instance.
Type: String
Optionality: Mandatory
Default: 0 (that is, INADDR_ANY)
Example: `tcpBindAddress = "192.168.1.1"`

`tcpListenPort`

Syntax: `tcpListenPort = "port"`
Description: The TCP port to listen on
Type: String
Optionality: Mandatory
Default: 3868
Example: `tcpListenPort = "3868"`

`throttleThreshold`

Syntax: `throttleThreshold = int`
Description: The number of initial or event requests to allow in a single interval. You set the length of the interval by using the `throttleInterval` parameter. The control agent counts the number of initial reservations or events received in the current interval and rejects new requests once the count has gone above the threshold.
Type: Integer
Optionality: Optional (default used if not set)
Allowed:
Default: 0 – Allow all requests

Notes:

Example: `throttleThreshold = 50`

`throttleInterval`

Syntax: `throttleInterval = int`

Description: The length, in milli-seconds, of each interval for which new requests will be counted and checked against the threshold specified in `throttleThreshold`.

Type: Integer

Optionality: Optional (default used if not set)

Allowed: None

Default: 100

Notes: If the value of the `throttleInterval` is set to any value other than 0 (zero), DCA rejects new requests and reports an error until the time set by the `throttleInterval`.

Example: `throttleInterval = 100`

`localOriginHost`

Syntax: `localOriginHost = "hostname"`

Description: The Origin-Host for messages sent out

Type: String

Optionality: Optional

Default: `"hostname"`

Notes: Recommended to keep the default value as the hostname of the target node, for example the SLC.

Example: `localOriginHost = "creditcontrol.realm3.oracle.com"`

`localOriginRealm`

Syntax: `localOriginRealm = "realmname"`

Description: The Origin-Realm for messages sent out

Type: String

Optionality: Mandatory

Notes: Each realm may contain at most one SLC

Example: `localOriginRealm = "realm3.oracle.com"`

`outBufferSize`

Syntax: `outBufferSize = size`

Description: The size, in bytes, of inbound transport buffer.

Type: Integer

Optionality: Mandatory

Allowed: Bytes

Default: 0 (kernel default)

Example: `outBufferSize = 16384`

`percentTimeQuotaThreshold`

Syntax: `percentTimeQuotaThreshold = percent`

Description: The percentage of granted service units of the time quota threshold.

Type: Integer
Optionality: Optional (default used if not set).
Allowed: 0 to 100 per cent
Default: 0
Notes:
Example: `percentTimeQuotaThreshold = 80`

`percentVolumeQuotaThreshold`

Syntax: `percentVolumeQuotaThreshold = percent`
Description: The percentage of granted service units of the volume quota threshold.
Type: Integer
Optionality: Optional (default used if not set).
Allowed: 0 to 100 percent
Default: 0
Notes:
Example: `percentVolumeQuotaThreshold = 80`

`productName`

Syntax: `productName = "name"`
Description: The product name used in Capabilities-Exchange-Answer
Type: String
Optionality: Mandatory
Allowed:
Default: "esg-dca" (that is, Diameter Control Agent)
Notes:
Example: `productName = "esg-dca"`

`sendAbortOnSessionTimeout`

Syntax: `sendAbortOnSessionTimeout = true|false`
Description: Indicates whether DCA will send an abort session request to the access device when the session with that device times out.
Type: Boolean
Optionality: Optional (default used if not set).
Allowed:
Default: false
Notes:
Example: `sendAbortOnSessionTimeout = false`

`sendCreditLimitReachedOnSessionEnd`

Syntax: `sendCreditLimitReachedOnSessionEnd = true|false`
Description: Indicates if we should reply to the final update request for a service (which DCA sometimes referred to as a sub-session) with a result code of `DIAMETER_CREDIT_LIMIT_REACHED` (4012), rather than `DIAMETER_SUCCESS` (2001).
Type: Boolean

Optionality: Optional (default used if not set).
Allowed:
Default:
Notes: For the record, the last update request for a service contains an MSCC with used service units but no requested-service-units AVP.
Example: `sendCreditLimitReachedOnSessionEnd = false`

`sendOriginStateId`

Syntax: `sendOriginStateId = true|false`
Description: To send or not send the origin state id flag.
Type: Boolean
Optionality: Optional (default used if not set).
Allowed: true, false
Default: true
Notes: Must be set to `false` if you do not want to send
Example: `sendOriginStateId = false`

`sendQuotaThreshold`

Syntax: `sendQuotaThreshold = true|false`
Description: Whether or not to send volume and quota threshold for MSCC.
Type: Boolean
Optionality: Optional (default used if not set).
Allowed: true, false
Default: true
Notes: Must be set to `false` if you do not want to send volume and quota threshold.
Example: `sendQuotaThreshold = false`

`sessionFallbackTcc`

Syntax: `sessionFallbackTcc = seconds`
Description: The session fallback tcc timer (in seconds).
Type: Integer
Optionality: Optional (default used if not set).
Allowed:
Default: 3600
Notes: This value is used as the tcc timer for sessions that do not have an associated service.
Example: `sessionFallbackTcc = 3600`

`Supported-Vendor-Id`

Syntax: `Supported-Vendor-Id = [values]`
Description: The Supported-Vendor-Id AVP values to include in the Capabilities Exchange message.
Type: Integer – Single value, or array
Optionality: Optional
Allowed:
Default:

Notes: This field may be specified as an array with either one or more values, or no value.

If there is only one value, brackets are not required.

Example: Supported-Vendor-Id = [16247, 10415]

thirtyTwoBitQuotaThresholds

Syntax: thirtyTwoBitQuotaThresholds = true|false

Description: Whether to send the Time-Quota-Threshold and Volume-Quota-Threshold AVPs as 32-bit integers (as supported by a Cisco Release 9 GGSN).

Type: Boolean

Optionality: Optional (default used if not set).

Allowed: true, false

Default: true

Notes: If this is false it is sent as a 64-bit integer(as supported by a Cisco Release 7 GGSN).

Example: thirtyTwoBitQuotaThresholds = true

Vendor-Specific-Application-Identifier

Syntax: Vendor-Specific-Application-Identifier = [values]

Description: The Vendor-Specific-Application-Id AVP values

Type: Array

Optionality: Optional

Allowed:

Default:

Notes:

Example:

```
Vendor-Specific-Application-Identifier = [
  {
    Vendor-Id = 111
    Auth-Application-Id = 1234
  }
  {
    Vendor-Id = 111
    Auth-Application-Id = 4321
  }
]
```

vendorId

Syntax: vendorId = id

Description: The Vendor ID to be supplied in the Capabilities-Exchange-Answer.

Type: Integer

Optionality: Mandatory

Allowed: A valid ID

Default: 0

Notes:

Example: vendorId = 16247

watchdogPeriod

Syntax:	watchdogPeriod = <i>seconds</i>
Description:	The period between sending out Device Watchdog messages to next-hop peer.
Type:	Integer
Optionality:	Mandatory
Allowed:	Seconds
Default:	30
Example:	watchdogPeriod =30

Services Configuration

Introduction

The `Services` section of the `DCAInstances` configuration allows you to select a specified service based upon one of the following:

- Service Context ID, Service Identifier, Rating Group, UnitType
- Configurable list of AVP values matched against the inbound message

If the `SelectionAVPs` is specified, then the `serviceContextId`, `serviceIdentifier`, `ratingGroup`, and `unitType` parameters cannot be specified.

Note: The service selection rules are tried in order. If you want the service configured by configurable AVPs to be used first, then put the parameters first in the `Services` section of the `eserv.config` file.

Services configuration structure

Here is the high-level structure of `Services` configuration section of the `DIAMETER` configuration in the `eserv.config` file.

```
Services = [  
  {  
    serviceName = "<Service name>"  
  
    serviceContextId = "<Service-Context-Id>"  
  
    serviceIdentifier = "<Service-Identifier>"  
  
    ratingGroup = "<Rating-Group>"  
  
    screeningService = false  
  
    unitType = "Time"  
  
    selectionAVPsIsChargingKey = false  
  
    conversionFactor = 1.0  
  
    requestedAction="DIRECT_DEBITING"  
  
    sleeServiceKey = 1231  
    inapServiceKey = 1231  
    tcc = 3600  
    gracefulTerminationValidityTime= 300  
    itc = "udi"  
    validityTime = 30  
    sleeTimeout = 10
```



```

SelectionAVPs = [
  {
    AvpCodes = [ { avpCode=5, vendorId=16247 },
                 { avpCode=7, vendorId=16247 } ],
    avpType = "Unsigned64"
    avpValue = 123
    avpValue = "-0x5000000000"
    avpValue = "This Really Is A String"
    isChargingKey = false
  }
]

AVPMappings = [
  {
    base_avpmappings
  }

  {
    basic_arrayavpmappings
  }

  {
    key_array_avpmappings
  }

  {
    array_with_conditions_avpmappings
  }

  {
    array_with_context_avpmappings
  }

  {
    conditional_avp_avpmappings
  }

  {
    prefix_tree_avpmappings
  }

  {
    timestamp_avpmappings
  }
]

```

See *Service Specific AVP Mappings* (on page 81) for a description of the `AVPMappings` configuration and examples of specific configuration and mappings.

Services parameters

The following parameters are used for a service. They are all located within the `Services` array.

As many services as required can be set up.

`AvpCodes`

Syntax: `AvpCodes = [avp_codes]`

Description: For a description of the `AVPCodes` parameters, see `AvpCodes` in the `DCADefaults` section.

Type: Array

Optionality: Optional
Allowed:
Default:
Notes: AvpCodes may be included as a member of the following:

- DCADefaults
- SelectionAVPs (on page 63)
- typeCriteria (on page 73)
- the base *Service Specific AVP Mappings* (on page 81)
- within AVP mappings of each level of a nested array

Example:

```
AvpCodes = [  
  {  
    avpCode = 1234  
    mandatory = true  
    vendorId = "16747"  
  }  
]
```

avpMappings

Syntax: `avpMappings = [avpMappings_parameters]`
Description: The service-specific AVP mappings.
Optionality: Optional
Default: If not present, will use the `avpMappings` in the `DCADefaults` section.
Notes: See *Service Specific AVP Mappings* (on page 81).

avpType

Syntax: `avpType = "type"`
Description: The AVP datatype to match.
Type: String
Optionality: Optional
Allowed: Allowed values are:

- Integer32
- Integer64
- Unsigned32
- Unsigned64
- UTF8String
- Enumerated

Default:
Notes: This is a member of the `SelectionAVPs` array.
Example: `parameter = "Integer32"`

avpValue

Syntax: `avpValue = "value"`
Description: The value to match.
Type: It may be specified either as a number or a quoted string.
Optionality: Optional
Allowed:

Default:

Notes: The config file supports only the signed 32-bit range for numbers. For numbers outside of that range, put it in quotes.

This is a member of the `SelectionAVPs` array.

Example:

```
avpValue = 123
avpValue = "-0x5000000000"
avpValue = "This Really Is A String"
```

`conversionFactor`

Syntax: `conversionFactor = unit`

Description: The conversion factor to use when communicating with ACS.

- Multiplies the value received from ACS by this factor to calculate the Granted-Service-Unit AVP.
- Divides the Used-Service-Unit AVP by this value before sending it to ACS.

Type: Float

Optionality: Mandatory

Allowed:

Default: Defaults to:

- 0.1 for time
- 1048576 for octets
- 1.0 for everything else

Notes: Ignored for CC-Time AVPs (always uses the default of 0.1)

Example: `conversionFactor = 1.0`

`gracefulTerminationValidityTime`

Syntax: `gracefulTerminationValidityTime = seconds`

Description: The number of seconds granted for the user to top up the account during graceful termination. Refer to *RFC 4006 A.7*.

Type: Integer

Optionality: Optional

Allowed: in seconds

Default:

Notes: Not present means no graceful termination.

Example: `gracefulTerminationValidityTime = 300`

`inapServiceKey`

Syntax: `inapServiceKey = value`

Description: The INAP Key value

Type: Integer

Optionality: Optional

Allowed: Any 32 bit integer

Example: `inapServiceKey = 1234`

isChargingKey

Syntax: isChargingKey = true|false

Description:

Type: Boolean

Optionality: Optional (default used if not set).

Allowed: true, false

Default:

Notes: If true, then we may match a Diameter CCR INITIAL_REQUEST, or UPDATE_REQUEST.

If false, then we may only match the INITIAL_REQUEST (or if that is empty, then the first UPDATE_REQUEST).

This is a member of the SelectionAVPs array.

Example: isChargingKey = false

itc

Syntax: itc = infoTransferCapability

Description: The Bearer Capability Information Element (Q.931 section 4.5.5) contains an Information Transfer Capability (ITC) field that is set automatically by DCA when DCA triggers ACS.

This parameter overrides the ITC value within the Bearer Capability Information Element.

Type: Integer or string

Optionality: Optional

Allowed: Allowed values are:

String	Integer	Hex	Description
"speech"	0	0x00	Speech
"udi"	8	0x08	Unrestricted Digital Information
"rdi"	9	0x09	Restricted Digital Information
"3.1kHzAudio"	16	0x10	3.1 kHz audio
"udiTA" or "7kHzAudio"	17	0x11	Unrestricted Digital Information with tones/ announcements
"video"	24	0x18	Video

Default: Defaults to one of the following:

- "speech" (0x00), if the Requested-Service-Unit AVP is set to CC-Time.
- "udi" (0x08), if otherwise.

Notes: If automatic setting of ITC is required, then this parameter should be absent.

Example: itc = 16

or

itc = "3.1kHzAudio"

or

itc = 0x10

`ratingGroup`

Syntax:	<code>ratingGroup = "number"</code>
Description:	The number used to identify the rating group as part of a service triggering rule.
Type:	String
Optionality:	Optional
Allowed:	The value in quotes must be a number.
Default:	
Notes:	This parameter must not be specified if <code>SelectionAVPs</code> is specified.
Example:	<code>ratingGroup = "2"</code>

`requestedAction`

Syntax:	<code>requestedAction = "action"</code>
Description:	The action performed by the service
Type:	String
Optionality:	Optional
Allowed:	<ul style="list-style-type: none"> • DIRECT_DEBITING • REFUND_ACCOUNT • CHECK_BALANCE • PRICE_ENQUIRY
Default:	not present
Notes:	Not present indicates this service is for session based transactions. See <i>RFC 4006 Requested-Action AVP</i> .
Example:	<code>requestedAction = "DIRECT_DEBITING"</code>

`screeningService`

Syntax:	<code>screeningService = true false</code>
Description:	If a screening service is not found for a particular service context ID, then DCA assumes that no screening needs to take place, that is, the session is allowed.
Type:	Boolean
Optionality:	Optional (default used if not set).
Allowed:	true, false
Default:	false
Notes:	If the <code>screeningService</code> flag is true, then <code>serviceIdentifier</code> and <code>ratingGroup</code> should be blank.
Example:	<code>screeningService = false</code>

`SelectionAVPs`

Syntax:	<code>SelectionAVPs = [selection_avps]</code>
Description:	Specifies the AVPs to be matched in an incoming request for the service to be triggered.
Type:	Array
Optionality:	Optional
Allowed:	
Default:	

Notes: All of the selection AVPs must be matched in an incoming request for the service to be triggered.

If `SelectionAVPs` is specified then none of `serviceContextId`, `serviceIdentifier`, `ratingGroup`, or `unitType` can be specified.

Example:

```
SelectionAVPs = [
  {
    AvpCodes = [
      { avpCode=5, vendorId=16247 },
      { avpCode=7, vendorId=16247 } ],
    avpType = "Unsigned64"
    avpValue = 123
    avpValue = "-0x5000000000"
    avpValue = "This Really Is A String"
    isChargingKey = false
  }
]
```

`selectionAVPsIsChargingKey`

Syntax: `selectionAVPsIsChargingKey = true|false`

Description: Indicates whether this AVP is a charging key.

Type: Boolean

Optionality: Optional (default used if not set).

Allowed:

- `true` – Incoming UPDATE_REQUESTS messages matching this rule, for which there is no current session, will start a new session.
- `false` – Such messages will be rejected with a Diameter answer with an error result code.

Default: `false`

Notes:

Example: `selectionAVPsIsChargingKey = false`

`serviceContextId`

Syntax: `serviceContextId = "id"`

Description: The ID of the Service Context

Type: String

Optionality: Mandatory, if `SelectionAVPs` is *not* specified.

Notes: This parameter must not be specified if `SelectionAVPs` is specified.

You must specify both the `ServiceContextId` and `serviceIdentifier` to identify the service. See *RFC 4006*.

Example: `serviceContextId = "3"`

`serviceIdentifier`

Syntax: `serviceIdentifier = "Id"`

Description: The service identifier number.

Type: Number string

Optionality: Optional

Notes: This parameter must not be specified if `SelectionAVPs` is specified.

You must specify both the `ServiceContextId` and `serviceIdentifier` to identify the service. See *RFC 4006*.

Example: `serviceIdentifier = "3"`

`serviceName`

Syntax: `serviceName = "name"`

Description: The unique name of the service

Type: String

Optionality: Mandatory

Allowed: Any string

Default:

Example: `serviceName = "DirectDebitService"`

`sleeServiceKey`

Syntax: `sleeServiceKey = value`

Description: The Service Key value

Type: Integer

Optionality: Optional

Allowed: The value specified in the SERVICEKEY entry in the **SLEE.cfg** file.

For more information about the SERVICEKEY configuration, see *SLEE Technical Guide*

Default: no default

Example: `sleeServiceKey = 1234`

`sleeTimeout`

Syntax: `sleeTimeout = seconds`

Description: How long (in seconds) to wait for a response from the SLEE before the session times out

Type: Integer

Optionality: Optional (default used if not set)

Allowed:

Default: 10

Notes:

Example: `sleeTimeout = 15`

`tcc`

Syntax: `tcc = seconds`

Description: The session supervision timer timeout

Type: Integer

Optionality: Mandatory

Allowed: number of seconds

Default: 3600

Notes: Refer to *RFC 4006*

Example: `tcc = 3600`

unitType

Syntax:	<code>unitType = "type"</code>
Description:	The unit type used in the service
Type:	String
Optionality:	Mandatory, if <code>SelectionAVPs</code> is <i>not</i> specified.
Allowed:	<ul style="list-style-type: none">• "Time"• "Money"• "Total-Octets"• "Input-Octets"• "Output-Octets"• "Service-Specific"
Default:	"Time"
Notes:	This parameter must not be specified if <code>SelectionAVPs</code> is specified.
Example:	<code>unitType = "Time"</code>

validityTime

Syntax:	<code>validityTime = seconds</code>
Description:	The validity time in seconds of granted units. Results in Validity-Time AVP being placed in CCA.
Type:	Integer
Optionality:	Optional (default used if not set).
Allowed:	
Default:	-1 (Not included)
Notes:	
Example:	<code>validityTime = 30</code>

Service Specific AVP Mappings parameters

The `AVPMappings` configuration in the `Services` section contains the following parameters that are used only in the `Services` section, not in other sections of the DIAMETER configuration.

For AVP parameters used throughout the DIAMETER configuration see *AvpMappings Parameters* (on page 28).

contextAVP

Syntax:	<code>contextAVP = true false</code>
Description:	Defines whether the <code>avpCode</code> in the specified <code>AVPs</code> array is the context AVP to use in an <i>Array with Context</i> (on page 99)
Type:	Boolean
Optionality:	Optional.
Allowed:	
Default:	
Notes:	<p>When only a single unique AVP is used to establish context, that AVP is typically the key AVP associated with a data record. However DCA also allows more than 1 sub-AVPs in a hierarchy to be marked for inclusion for context. These multiple AVPs which form the context are know as the Context AVP.</p> <p>Context AVPs are typically used when possible key values are not well known, or unique, or the key might otherwise rely on multiple items from the hierarchy.</p>

Example: `contextAVP = true`

`encodedExtension`

Syntax: `encodedExtension= {profile_parameters}`

Description: This identifies the target tag and type in an incoming extension profile block for this AVP, when `extensionFormat = "encoded"`.

Type: Parameter list

Optionality: Optional

Allowed:

Default:

Notes: If `encodedExtension` is present and `extensionFormat` is absent, `extensionFormat = "encoded"` is assumed. See *extensionFormat* (on page 31) for details.

RAW_DATA profile mappings also have extra options (`octetsStart` and `octetsLength`) for specifying a part of the AVP (for inbound) or profile field (for outbound) to extract.

Example:

```
encodedExtension = {
  profileTag = 99123
  profileFormat = "INTEGER"
  octetsStart = 3
  octetsLength = 0
}
```

`excludeIfMatches`

Syntax: `excludeIfMatches = [avpvalue]`

Description: The value of the AVPs to exclude from the Type Criteria matching.

Type: Array

Optionality: Optional (default used if not set).

Allowed: Integer, string, hex string

Default:

Notes: This parameter can be used as part of the Base mapping outside `AVPs = [...]`.

If used inside `AVPs = [...]` it must be used as part of the `typeCriteria` section. See *typeCriteria* (on page 73) for an example.

Example: **Example 1**

```
excludeIfMatches = [ 101, 105 ]
```

Example 2

```
excludeIfMatches = ["SPAM"]
```

`inapField`

Syntax: `inapField = [field1, field2, ...]`

Description: Identifies the:

- Target INAP field(s) for mapping from this AVP for Inbound Mapping
- Source INAP field(s) for mapping to this AVP for Outbound Mapping

Type: String array

Optionality: Optional

Allowed: The following INAP fields are allowed:

- "additionalCallingpartyId"
- "calledPartyBcdNumber"
- "calledPartyNumber"
- "callingPartyNumber"
- "cause"
- "destinationRoutingAddress"
- "imsi"
- "locationInformation" - see note below
- "locationNumber"
- "maxCallDuration"
- "mscAddress"
- "originalCalledPartyId"
- "redirectingPartyId"
- "timeIfNoTariffSwitch"

Default:

Notes: If the AVP mappings are to and from INAP Field(s), please do not configure or specify parameters associated with `acsProfile` mapping (that is, `extensionFormat` should not be set to "encoded". `encodedExtension` should be absent).

The location information in the AVP is an encoded field. In ACS the location information is split up, to populate the call context buffers of MCC, MNC, LAC, and Cell ID, for originating and terminating. Refer to the *ACS Buffers* topic in *ACS Feature Nodes User's Guide*.

Example: `inapField= ["CalledPartyNumber"]`

`includeIfMatches`

Syntax: `includeIfMatches = [avpvalue]`

Description: The value of the AVPs to include in the Type Criteria matching.

Type: Array

Optionality: Optional (default used if not set).

Allowed: Integer, string, hex string

Default:

Notes: This parameter can be used as part of the Base mapping outside AVPs = [...].

If used inside AVPs = [...] it must be used as part of the `typeCriteria` section. See *typeCriteria* (on page 73) for an example.

Example: **Example 1**

`includeIfMatches = [1, 10, 101, 1001, 10001]`

Example 2

`includeIfMatches = ["GoodNews!", "PrettyGoodNews"]`

`keyArray`

Syntax: `keyArray = true|false`

Description: Defines whether the `avpCode` in the specified AVPs array is the key to use in a *Key Array* (on page 86).

Type: Boolean

Optionality: Optional
Allowed: true, false
Default:
Notes:
Example: `keyArray = true`

`literal`

Syntax: `literal = "value"`
Description: Applies the literal value to the AVP when the outbound message matches the types defined for that mapping.
Type: String
Optionality: Optional
Default:
Notes: Outbound AVP only.
 If a mapping specifies both a literal and an `IncludesIfMatches` conditional AVP, then the literal will override the mapped value if the original value is found in the `IncludesIfMatches` array.
Example: `literal = "1"`

`profileFormat`

Syntax: `profileFormat = "format"`
Description: The format of the profile.
Type: String
Optionality: Optional
Allowed: The value given for this must be one of the valid storage formats for ACS profile fields. The allowable values for this parameter are:

- INTEGER
- INTEGER64
- UINTEGER
- UINTEGER64
- LNSTRING
- NSTRING
- STRING
- TIME
- BOOLEAN
- ARRAY
- RAW_DATA

Default: INTEGER
Notes: See also the related parameter, `profileTag`.
 Part of `encodedExtension`.
 If the `avpFormat` parameter is set to "Grouped" for the AVPs array, then `profileFormat` must be "ARRAY"

Example: `profileFormat = "LNSTRING"`

profileTag

Syntax:	<code>profileTag = num</code>
Description:	The profile tag.
Type:	Integer
Optionality:	Optional
Notes:	This parameter is used to identify the profile tag it will be stored into/retrieved from. See also the related parameter, <code>profileFormat</code> . Part of <code>encodedExtension</code> .
Example:	<code>profileTag = 999</code>

mappingTypes

Syntax:	<code>mappingTypes = ["mapping_types"]</code>
Description:	Defines the message types between DCA and ACS that the mapping applies to.
Type:	String Array
Optionality:	Optional (default used if not set).
Allowed:	For Inbound: <ul style="list-style-type: none">• "InitialRequest"• "UpdateRequest"• "EventRequest"• "TerminateRequest" For Outbound: <ul style="list-style-type: none">• "InitialResponse"• "UpdateResponse"• "EventResponse"• "TerminateResponse"• "FreeCallResponse" – See Notes. One or more mapping types may be specified. Note that the Configuration <code>mappingType</code> does not directly correspond to the CC-Request-Type. See <i>Mapping categories</i> (on page 71).
Default:	<code>mappingTypes = ["InitialRequest", "InitialResponse", "EventRequest", "EventResponse"]</code>
Notes:	If the configuration, within the <code>AVPs</code> array, for inbound is the same as for outbound, include the inbound and outbound message types in the list. Each inbound configuration "Request" <code>mappingType</code> has a counterpart outbound "Response" <code>mappingType</code> that (when defined) is applied to the outbound Diameter message. For example: If an inbound Diameter message has <code>InitialRequest</code> mappings applied, then <code>InitialResponse</code> mappings will be applied to the corresponding outbound Diameter answer. However, if a call is determined to be free, say after screening, or become free mid-session, then any mappings classified as "FreeCallResponse" (for the selected service) will be applied to the outbound Diameter answer instead of the default response mapping type.
Example:	<code>mappingTypes = ["InitialRequest", "UpdateRequest", "EventRequest", "TerminateRequest"]</code>

Mapping categories

This table describes the relationship between CC-Request-Type and Configuration `mappingTypes` for outbound request type mappings:

Diameter Message	CC-Request-Type	Credit Control	Service	Requested-Service-Unit	Used-Service-Unit	Configuration mappingTypes
CCR	INITIAL_REQ	MSCC	New	New	-	InitialRequest
CCR	INITIAL_REQ	Basic	New	New	-	InitialRequest
CCR	UPDATE_REQ	MSCC	New	New	-	InitialRequest
CCR	UPDATE_REQ	MSCC	Existing	Existing UT	Existing UT	UpdateRequest
CCR	UPDATE_REQ	Basic	Existing	Existing UT	Existing UT	UpdateRequest
CCR	UPDATE_REQ	MSCC	Existing	-	Existing UT	TerminateRequest
CCR	TERM_REQ	MSCC	any	-	-	TerminateRequest
CCR	TERM_REQ	Basic	any	-	-	TerminateRequest
CCR	EVENT_REQ	-	-	-	-	EventRequest

Here are the abbreviations used in the table.

Abbreviation	Description
CCR	Credit-Control-Request
INITIAL_REQ	INITIAL_REQUEST
UPDATE_REQ	UPDATE_REQUEST
TERM_REQ	TERMINATION_REQUEST
EVENT_REQ	EVENT_REQUEST
MSCC	Multiple-Services-Credit-Control
Basic	Basic Credit-Control
Existing UT	Existing Unit Type

`octetsLength`

Syntax: `octetsLength = num`
Description: The number of octets to extract from the source data.
Type: Integer
Optionality: Optional (default used if not set).
Allowed:
Default: 0 (copy all octets from `octetsStart` until the end of the field)
Notes: Part of `encodedExtension`.
 Used if `profileFormat` is `RAW_DATA`.
 Used in conjunction with `octetsStart`.
Example: See examples in `octetsStart`.

`octetsStart`

Syntax: `octetsStart = num`
Description: The offset within the source data (AVP or profile field) to start copying from.
Type: Integer

Optionality: Optional (default used if not set).
Allowed:
Default: 0 (start copying from the beginning)
Notes: Negative values can be used to specify an offset from the end of the data.
Part of `encodedExtension`.
Used if `profileFormat` is `RAW_DATA`.
Used in conjunction with `octetsLength`.

Example: Example 1: Copy all data except for the first 3 octets.
`octetsStart = 3`
`octetsLength = 0`
Example 2: Copy the third-to-last and second-to-last octets.
`octetsStart = -3`
`octetsLength = 2`

repeating

Syntax: `repeating = true|false`
Description: Specifies whether the `avpCode` is repeating, that is the Diameter message contains an array-like structure where the `avpCode` is used more than once.
Type: Boolean
Optionality: Optional (default used if not set).
Allowed: true, false
Default: false
Notes: For inbound mappings, the destination will need to be an Array, or Prefix Tree type profile tag, in order to handle the complex structure.
Outbound mappings need to come from an Array or Prefix Tree.
Example: `repeating = true`

timestamp

Syntax: `timestamp = "timestamp"`
Description: The timestamp to record
Type: String
Optionality: Optional
Allowed: The available timestamps are:

- "TIME_REQUEST_RECEIVED32"
- "TIME_REQUEST_RECEIVED64"
- "TIME_NOW32"
- "TIME_NOW64"

Default:
Notes: 'NOW' refers to the time the mapping is processed. For an outbound mapping, it will be as the reply is being created, hopefully immediately before it is sent.
'REQUEST_RECEIVED' is the time the request [that we are processing] entered the Diameter stack.
See *Timestamp* (on page 114) for example usage.
Example: `timestamp = "TIME_REQUEST_RECEIVED32"`

typeCriteria

Syntax: typeCriteria = [criteria]

Description: Lists the criteria to match on, then specifies the AVP that is searched and, if a match is found, mapped to a profile tag.

Type: Parameter section

Optionality: Optional (default used if not set).

Allowed:

Default:

Notes:

Example: In this example, if the value of AVP of 1000.2000.3000 is 1, then map the value of each of the AVPs 1000.2000.3001 to array element as tag 100 in the sub-profile block, as a string.

Note, the parent AvpCodes 1000.2000 are not shown in this example configuration fragment.

```
typeCriteria = [
  {
    includeIfMatches = [ 1 ]
    AvpCodes = [
      { avpCode = 3000
      }
    ]
    avpFormat = "Integer32"
    # What is included if match found
    AVPs = [
      {
        AvpCodes = [
          { avpCode = 3001
            repeating = true
          }
        ]
        avpFormat = "UTF8String"
        encodedExtension = {
          profileTag = 100
          profileFormat = "STRING"
        }
      }
    ]
  }
]
```

See the example mapping for this configuration in *Mapping* (on page 92).

See more examples in:

- *Array with Conditions* (on page 89)
- *Conditional AVP* (on page 104)

PeerSchemes Configuration Section

PeerSchemes configuration structure

Here is a high level structure of the configuration of a scheme in the PeerSchemes section.

```
PeerSchemes = [
```

```

{
  schemeName = "SchemeA"

  Peers = [
  {
    name = "host1"

    protocol = "both"

    permittedOriginHosts = [
      "host1.realm1.oracle.com"
    ]

    RemoteAddresses = [
      "192.168.1.10"
    ]

    netmaskBits = 32

    netmask6Bits = 128

    permittedInstances = 0

    reqSctpInboundStreams = 8
    reqSctpOutboundStreams = 8
  } # end of Peer host1

  {
    peer_host2_parameters
  } # end of Peer host2

  ]
} # End of Scheme A

{
  schemeName = "SchemeB"

  SchemeB_parameters

  } # End of Scheme B
] # End of PeerSchemes section

```

Note: Default settings are specified at installation time.

PeerSchemes parameters

The following parameter is used in the `PeerSchemes` array.

`schemeName`

Syntax: `schemeName = "name"`
Description: The name identifying the scheme.
Type: String
Optionality: Mandatory
Example: `schemeName = "SchemeA"`

Peer host parameters

The following parameters are used for a peer host. They are members of the `Peers` array.

You can be set up as many peer hosts as required. A scheme can have no peers, in which case will accept all connections.

name

Syntax: name = "*name*"
Description: The name identifying either peer, or group of peers.
Type: String
Optionality: Mandatory
Example: name = "host1"

netmaskBits

Syntax: netmaskBits = *bits*
Description: The number of bits for netmask.
Type: Integer
Optionality: Mandatory
Default: 32 (bits for netmask, that is, a single machine (/32))
Example: netmaskBits = 32

netmask6Bits

Syntax: netmask6Bits = *bits*
Description: The number of bits for the IP version 6 prefix
Type: Integer
Optionality: Mandatory
Default: 128 (bits for the address prefix, that is, a single machine (/128))
Example: netmask6Bits = 128

permittedInstances

Syntax: permittedInstances = *num*
Description: The number of permitted instances.
Type: Integer
Optionality: Mandatory
Notes: If set to 0 then allow all.
Example: permittedInstances = 0

permittedOriginHosts

Syntax: permittedOriginHosts = "*host*"
Description: The list of peer names which will be checked against the OriginHost AVP, during the capabilities exchange.
Type: String
Optionality: Mandatory
Example value: permittedOriginHosts = "host1.realm1.oracle.com"

protocol

Syntax: protocol = "*protocol*"
Description: The protocol for this host peer.
Type: String
Optionality: Optional

Allowed:

- "sctp"
- "tcp"
- "both"

Default: If not specified, then it uses the protocol from the *DiameterServer* section. (on page 48)

Example: `protocol = "tcp"`

RemoteAddresses

Syntax: `remoteAddresses = ["ipaddress"]`

Description: The list of remote IP addresses.

Type: Array of string parameters

Optionality: Mandatory

Notes: If an address becomes unavailable the list will be cycled through.

Example: `remoteAddresses = [
"192.168.1.10"
]`

reqSctpInboundStreams

Syntax: `reqSctpInboundStreams = num`

Description: The number of requested inbound sctp streams.

Type: Integer

Optionality: Mandatory

Notes: There is no guarantee you will actually get these.

Example: `reqSctpInboundStreams = 8`

reqSctpOutboundStreams

Syntax: `reqSctpOutboundStreams = num`

Description: The number of requested outbound sctp streams.

Type: Integer

Optionality: Mandatory

Notes: There is no guarantee you will actually get these.

Example: `reqSctpOutboundStreams = 8`

Example PeerSchemes section

Here is an example `PeerSchemes` section of the DIAMETER configuration in the `eserv.config` file.

```
PeerSchemes = [  
  {  
    schemeName = "SchemeA"  
  
    Peers = [  
  
      {  
        name = "host1"  
  
        protocol = "both"  
  
        permittedOriginHosts = [  
          "host1.realm1.oracle.com"  
        ]  
      }  
    ]  
  }  
]
```

```

RemoteAddresses = [
    "192.168.1.10"
]

netmaskBits = 32

netmask6Bits = 128

permittedInstances = 0

reqSctpInboundStreams = 8
reqSctpOutboundStreams = 8
} # end of Peer host1

{
    name = "host2"

    protocol = "sctp"

    permittedOriginHosts = [
        "host1.realm1.oracle.com"
    ]

    RemoteAddresses = [
        "192.168.1.11"
    ]

    netmaskBits = 32

    netmask6Bits = 128

    permittedInstances = 0

    reqSctpInboundStreams = 8
    reqSctpOutboundStreams = 8
} # end of Peer host2
} # End of Scheme A

{
    schemeName = "SchemeB"

    Peers = [
    {
        name = "host1"

        protocol = "both"

        permittedOriginHosts = [
            "host1.realm1.oracle.com"
        ]

        RemoteAddresses = [
            "192.168.1.10"
        ]

        netmaskBits = 32

        netmask6Bits = 128

        permittedInstances = 0

        reqSctpInboundStreams = 8

```

```
        reqSctpOutboundStreams = 8
    } # end of Peer host1

]
} # End of Scheme B
] # End of PeerSchemes section
```

Statistics Logged by diameterControlAgent

Introduction

Diameter statistics are generated by each SLC, and then transferred at periodic intervals to the Service Management System (SMS) for permanent storage and analysis.

An existing statistics system (smsStats) provides functions for the collection of basic statistical events. This is provided in the Convergent Charging Controller SMS application. Refer to *SMS Technical Guide* for details.

DCA statistics

SMS statistics are logged with APPLICATION_ID = 'DCA' (application number 96)

The following statistics are defined:

- DUPLICATES_DETECTED
- INITIAL_REQUESTS_RECEIVED
- INITIAL_REQUESTS_ANSWERED
- UPDATE_REQUESTS_RECEIVED
- UPDATE_REQUESTS_REJECTED_ANSWERED
- TERMINATION_REQUESTS_RECEIVED
- TERMINATION_REQUESTS_ANSWERED
- DIRECT_DEBITS_RECEIVED
- DIRECT_DEBITS_ANSWERED
- ACCOUNT_REFUNDS_RECEIVED
- ACCOUNT_REFUNDS_ANSWERED
- BALANCE_CHECKS_RECEIVED
- BALANCE_CHECKS_ANSWERED
- PRICE_ENQUIRIES_RECEIVED
- PRICE_ENQUIRIES_ANSWERED
- UNSUPPORTED_MESSAGES
- SESSIONS_TIMED_OUT
- GENERIC_ACTION_RECEIVED (Tracks requests for non-standard triggering)
- GENERIC_ACTION_ANSWERED (Tracks answers for non-standard triggering)
- RAR_UNABLE_TO_BE_DELIVERED (RAR cannot deliver RAR to the Diameter client)
- RAR_ERRORS_RECEIVED (RAR received error response to RAR)
- RAR_TIMEOUT (RAR has timed out)
- RAR_SENT (RAR sent from DCA)
- RAR_ANSWERS_RECEIVED (RAA received in response to RAR)
- RAR_UNABLE_TO_COMPLY_RECIEVED (RAA received with UNABLE_TO_COMPLY)
- RAR_LIMITED_SUCCESS_RECEIVED (RAA received with LIMITED_SUCCESS)
- RAR_UNSOLICITED_ANSWER (Unexpected RAA received)

- RAA_EXCEPTION (RAA exception handling)
- RAA_UNKNOWN_SESSION_ID (RAA received with unknown session ID)

For all statistics, the Origin-Realm AVP from the message received is put into SMF_STATISTICS.DETAIL.

Reports

The following reports are available:

- DCA System Stats
- DCA System Stats by Realm

Reports are generated using the SMS Report Functions screen. Refer to the *SMS User's Guide* for details.

Example report

Here is an example DCA System Stats by Realm report.

DCA Statistics Listing by Realm

=====

Start Date: 16 August 2007

Finish Date: 18 August 2007

Report Type: All Entries

Realm: realm2.oracle.com

28 August 2007, 22:50:56

Node Name	Statistics ID	Date	Value
mtv-tst-scp10	DUPLICATES_DETECTED	17 August 07 00:52	1
mtv-tst-scp10	DUPLICATES_DETECTED	17 August 07 00:54	1
mtv-tst-scp10	INITIAL_REQUESTS_ANSWERED	16 August 07 00:02	1
mtv-tst-scp10	INITIAL_REQUESTS_ANSWERED	16 August 07 03:04	1
mtv-tst-scp10	INITIAL_REQUESTS_ANSWERED	16 August 07 22:34	1
mtv-tst-scp10	INITIAL_REQUESTS_ANSWERED	7 August 07 00:52	2
mtv-tst-scp10	INITIAL_REQUESTS_ANSWERED	17 August 07 00:54	2
mtv-tst-scp10	INITIAL_REQUESTS_ANSWERED	17 August 07 01:00	1
mtv-tst-scp10	INITIAL_REQUESTS_RECEIVED	16 August 07 00:02	1
mtv-tst-scp10	INITIAL_REQUESTS_RECEIVED	16 August 07 03:04	1
mtv-tst-scp10	INITIAL_REQUESTS_RECEIVED	16 August 07 22:34	1
mtv-tst-scp10	INITIAL_REQUESTS_RECEIVED	17 August 07 00:52	2
mtv-tst-scp10	INITIAL_REQUESTS_RECEIVED	17 August 07 00:54	2
mtv-tst-scp10	INITIAL_REQUESTS_RECEIVED	17 August 07 01:00	1
mtv-tst-scp10	SESSIONS_TIMED_OUT	17 August 07 00:54	1
mtv-tst-scp10	UPDATE_REQUESTS_ANSWERED	16 August 07 00:02	1
mtv-tst-scp10	UPDATE_REQUESTS_ANSWERED	16 August 07 03:04	1
mtv-tst-scp10	UPDATE_REQUESTS_ANSWERED	16 August 07 22:34	1
mtv-tst-scp10	UPDATE_REQUESTS_ANSWERED	17 August 07 00:52	2
mtv-tst-scp10	UPDATE_REQUESTS_ANSWERED	17 August 07 00:54	2
mtv-tst-scp10	UPDATE_REQUESTS_ANSWERED	17 August 07 01:00	1
mtv-tst-scp10	UPDATE_REQUESTS_RECEIVED	16 August 07 00:02	1
mtv-tst-scp10	UPDATE_REQUESTS_RECEIVED	16 August 07 03:04	1
mtv-tst-scp10	UPDATE_REQUESTS_RECEIVED	16 August 07 22:34	1
mtv-tst-scp10	UPDATE_REQUESTS_RECEIVED	17 August 07 00:52	2
mtv-tst-scp10	UPDATE_REQUESTS_RECEIVED	17 August 07 00:54	2
mtv-tst-scp10	UPDATE_REQUESTS_RECEIVED	17 August 07 01:00	1

Completed

Service Specific AVP Mappings

Overview

Introduction

This chapter explains the structure of the AVP mappings for a service.

In this chapter

This chapter contains the following topics.

Introduction	81
Basic Array	83
Key Array	86
Array with Conditions	89
Array with Context	99
Conditional AVP	104
Prefix Tree	112
Timestamp	114

Introduction

Introduction

The AVP mappings within the `Services` parameter section are organized as shown in *Services configuration structure* (on page 58).

There are two types of configuration formats available:

- 'classic' format:
 - Base
- 'nested' format. These are configured within an array of format `AVPs = []`
 - *Basic Array* (on page 83)
 - *Key Array* (on page 86)
 - *Array with Conditions* (on page 89)
 - *Array with Context* (on page 99)
 - *Conditional AVP* (on page 104)
 - *Prefix Tree* (on page 112)
 - *Timestamp* (on page 114)

Note: If you use classic format, you cannot use nested format in the `eserv.config` file.

Base example

Here is an example of the base AVP mappings in the `Services AVPMappings` section.

General Example 1 – Classic Format. Specify AVP code(s) for this AVP. There MUST be one specified for the base AVP, plus list all extras for grouped AVPs.

```
{
```

```

AvpCodes = [
{
    avpCode = 1234
    mandatory = true|false
    vendorId = "VendorID"
}
]
# The AVP data format.
avpFormat =
"OctetString|Integer32|Integer64|UInteger32|UInteger64|Unsigned32|Unsigned64|
Address|Time|UTF8String|DiameterIdentity|DiameterURI|Enumerated|"
extensionType = 1234
extensionFormat = "inapnumber|asn1integer|octets|encoded"

encodedExtension= {
    profileTag = 99123
    profileFormat = "INTEGER | INTEGER64 | UINTEGER | UINTEGER64 | LNSTRING |
NSTRING | STRING | TIME | BOOLEAN | RAW_DATA"
    octetsStart = 3
    octetsLength = 0
}
inapField = [ field1, field2, ... ]
}

```

Simple conditional

Here is an example using `includeIfMatches` within `Services AvpMappings` section, that is, outside an AVPs array in a `typeCriteria` (on page 73) array.

```

{
    AvpCodes = [
        {
            avpCode = 4700
        }
        {
            avpCode = 2000
        }
    ]
    avpFormat = "UTF8String"
    includeIfMatches = [ "Good News!", "Pretty Good News!", "Over the moon!" ]
    encodedExtension = {
        profileTag = 94701
        profileFormat = "STRING"
    }
}

```

Nested format

Nested formats are generally used to define arrays and conditional AVPs. Definitions are nested in the array formatted `AVPs = []` and mirror the hierarchy of a Grouped AVP.

As groups can contain sub-groups, defined "AVPs" can contain sub-"AVPs".

Example nested format

The following example shows an AVP nested up to four levels deep:

- A root-level AVPs with one entry
- A first-level AVPs with one entry
- A second-level AVPs with two entries
- A third-level AVPs with two entries, which are part of the first entry of the second level AVPs.

Here is the configuration structure in the `DIAMETER Services AvpMappings` array of the example `eserv.config`.

```
AVPs = [ # Root-Level AVPs
  { # 1st Entry of Root-Level AVPs
    AvpCodes = [ ... ]
    AVPs = [ # 1st-Level AVPs
      { # 1st Entry of 1st-Level AVPs
        AvpCodes = [ ... ]
        AVPs = [ # 2nd-Level AVPs
          { # 1st Entry of 2nd-Level AVPs
            AvpCodes = [ ... ]
            AVPs = [ # 3rd-Level AVPs
              { # 1st Entry of 3rd-Level AVPs
                AvpCodes = [ ... ]
                avpFormat = "...
                encodedExtension = {
                  profileTag = 80301
                  profileFormat = "...
                }
              }
              { # 2nd Entry of 3rd-Level AVPs
                AvpCodes = [ ... ]
                avpFormat = "...
                encodedExtension = {
                  profileTag = 80303
                  profileFormat = "...
                }
              } # End of 2nd Entry of 3rd-Level AVPs
            ] # End of 3rd-Level AVPs
          } # End of 1st Entry of 2nd-Level AVPs
          { # 2nd Entry of 2nd-Level AVPs (optional; specify if applicable)
            AvpCodes = [ ... ]
            avpFormat = "...
            encodedExtension = {
              profileTag = 80302
              profileFormat = "...
            }
          } # End of 2nd Entry of 2nd-Level AVPs
        ] # End of 2nd-Level AVPs
      } # End of 1st Entry of 1st-Level AVPs
    ] # End of 1st-Level AVPs
  } # End of 1st Entry of Root-Level AVPs
] # End of Root-Level AVPs
avpFormat = "Grouped"
encodedExtension = {
  profileTag = 8234
  profileFormat = "ARRAY"
}
```

Basic Array

Introduction

Basic Arrays are also known as "simple repeating AVPs". In the simplest case, the repeating AVP is the one which requires mapping to an array in a profile block. DCA will need to establish multiple instances of the same AVP. However you only need define a single Basic Array type mapping definition. The mapping definition needs to establish:

- That the target (or source) profile field is an array

- The format of the elements in the target array (for example, STRING)
- The format of the AVP (such as UTF8String)
- That the AVP code is repeating, that is, `repeating = true`. For a definition, see *repeating* (on page 72).

Note that in this case (unlike Paired-AVPs or Array with Conditions), there is no key or sub-AVPs to consider.

Basic Array configuration

Here is the example basic array configuration in the Services AVPMappings section of the `eserv.config`. In this example, the basic array contains a list of string-type (that is, `profileFormat = "STRING"`) elements.

```
{
  AVPs = [ # Root-Level AVPs
    { # 1st Entry in Root-Level AVPs
      AvpCodes = [
        {
          avpCode = 6000
        }
      ]
      AVPs = [ # 1st Level AVPs
        {
          AvpCodes = [
            {
              avpCode = 1000
            }
          ]
          AVPs = [ # 2nd Level AVPs
            {
              AvpCodes = [
                {
                  avpCode = 2000
                  repeating = true
                }
              ]
              avpFormat = "UTF8String"
              encodedExtension = {
                profileTag = 9998
                profileFormat = "STRING"
              }
            }
          ] # End of 2nd Level AVPs
        }
      ] # End of 1st Level AVPs
    } # End of 1st Entry in Root-Level AVPs
  ] # End of Root-Level AVPs

  # Specify mapping applies INBOUND only.
  mappingTypes = ["InitialRequest", "UpdateRequest", "EventRequest",
    "TerminateRequest"]

  avpFormat = "Grouped"
  encodedExtension = {
    profileTag = 8000
    profileFormat = "ARRAY"
  }
}
```

Note: The parameter setting of `avpFormat = "Grouped"` can only be used in this place in the config file, that is, *outside* an `"AVPs = [...]"` array. Also an `"AVPs = [...]"` array must be defined because "Grouped" makes all the AVPs defined inside the `"AVPs = [...]"` array as belonging to the one group. Because of this it makes no sense to put `avpFormat = "Grouped"` anywhere else except here.

Example Basic Array configuration

Here is a worked example of a basic array: inbound configuration.

```
{
  AVPs = [
    {
      AvpCodes = [
        { avpCode = 1000 }
      ]
      AVPs = [
        {
          AvpCodes = [
            { avpCode = 2000 # <-- 1000.2000
              repeating = true # <-- 2000 is repeating
            }
          ]
          avpFormat = "UTF8String"
          encodedExtension {
            profileTag = 9998 # Array element in sub-profile block
            profileFormat = "STRING"
          }
        }
      ]
    }
  ]

  # Specify mapping applies INBOUND only.
  mappingTypes = ["InitialRequest", "UpdateRequest", "EventRequest",
    "TerminateRequest"]

  # AVPs above are encoded into an ARRAY-type in an ACS Profile Block.
  encodedExtension = {
    profileTag = 8000
    profileFormat = "ARRAY"
  }
}
```

The configuration for basic arrays: outbound is identical to above, except the mapping types are:

```
# Specify mapping applies OUTBOUND only.
mappingTypes = ["InitialResponse", "UpdateResponse", "EventResponse",
  "TerminateResponse"]
```

Mapping

This table shows the mapping of Diameter AVPs to ACS profile blocks resulting from the worked example basic arrays configuration section above. This example is for inbound.

Diameter AVP			Profile Block			
Root AVP	1 st Level	Value	Profile (ARRAY)	Sub-Profile Block	Tag	Value
1000	2000	"049772056"	8000	1	9998	"049772056"
	2000	"6449016000"		2	9998	"6449016000"
	2000	"0800500600"		3	9998	"0800500600"

The mapping is a simple 1:1 mapping. For outbound, the mappings are the same, but in the reverse direction.

Key Array

Introduction

A key array is a set of records where one of the elements within each record can be identified as a key for accessing the record, using the parameter setting `keyAVP = true`.

Key Arrays configuration

Here is the example Key Array configuration in the `Services AVPMappings` section of the `eserv.config`. In this example, elements of the key array contain:

- an integer type Key AVP (`avpCodes = 3000`)
- three Data AVPs.

```
{
  AVPs = [ # Root-Level AVPs
    { # 1st Entry in Root-Level AVPs
      AvpCodes = [
        {
          avpCode = 6100
        }
      ]
    }
  ]
  AVPs = [ # 1st-Level AVPs
    { # 1st Entry in 1st-Level AVPs
      AvpCodes = [
        {
          avpCode = 1000
        }
      ]
    }
  ]
  AVPs = [ # 2nd-Level AVPs
    { # 1st Entry of 2nd-Level AVPs
      AvpCodes = [
        {
          avpCode = 2000
          repeating = true
        }
      ]
    }
  ]
  AVPs = [ # 3rd-Level AVPs (Final Level)
    { # Mapping for Key AVP
      AvpCodes = [
        {
          avpCode = 3000
        }
      ]
      keyAVP = true
      avpFormat = "Integer32"
      encodedExtension = {
        profileTag = 100
        profileFormat = "INTEGER"
      }
    } # End of Mapping for Key AVP
    { # Mapping for 1st Data AVP
      AvpCodes = [
        {
          avpCode = 3001
        }
      ]
    }
  ]
}
```

```

]
avpFormat = "UTF8String"
encodedExtension = {
  profileTag = 101
  profileFormat = "STRING"
}
} # End of Mapping for 1st Data AVP
{ # Mapping for 2nd Data AVP
  AvpCodes = [
    {
      avpCode = 3002
    }
  ]
  avpFormat = "UTF8String"
  encodedExtension = {
    profileTag = 102
    profileFormat = "STRING"
  }
} # End of Mapping for 2nd Data AVP
{ # Mapping for 3rd Data AVP
  AvpCodes = [
    {
      avpCode = 3003
    }
  ]
  avpFormat = "UTF8String"
  encodedExtension = {
    profileTag = 103
    profileFormat = "STRING"
  }
} # End of Mapping for 3rd Data AVP
] # End of 3rd-Level AVPs
} # End of 1st entry of 2nd-Level AVPs
] # End of 2nd Level AVPs
} # End of 1st Entry in 1st-Level AVPs
] # End of 1st-Level AVPs
} # End of 1st Entry in Root-Level AVPs
] # End of Root-Level AVPs Mappings

# Specify mapping applies INBOUND only.
mappingTypes = ["InitialRequest", "UpdateRequest", "EventRequest",
"TerminateRequest"]

avpFormat = "Grouped"
encodedExtension = {
  profileTag = 8001
  profileFormat = "ARRAY"
}
}

```

Example Key Arrays configuration

Here is a worked example of Key Arrays: Inbound configuration.

```

{
  AVPs = [
    {
      AvpCodes = [
        { avpCode = 1000 }
      ]
      AVPs = [
        {
          AvpCodes = [

```

```

        { avpCode = 4400          # <-- 1000.4400
          repeating = true      # <--      4400 is repeating
        }
      ]
    AVPs = [
      {
        AvpCodes = [
          { avpCode = 4410      # <-- 1000.4400.4410
          }
        ]
        keyAVP = true          # <--      4410 is the key,
        others below are data AVPs.
        avpFormat = "Integer32"
        encodedExtension {
          profileTag = 9998    # Array element in sub-profile
          block
          profileFormat = "INTEGER"
        }
      }
      {
        AvpCodes = [
          { avpCode = 4420      # <-- 1000.4400.4420
          }
        ]
        avpFormat = "UTF8String"
        encodedExtension {
          profileTag = 9999    # Array element in sub-profile
          block
          profileFormat = "STRING"
        }
      }
      {
        AvpCodes = [
          { avpCode = 4410      # <-- 1000.4400.4430
          }
        ]
        avpFormat = "UTF8String"
        encodedExtension {
          profileTag = 10000   # Array element in sub-profile
          block
          profileFormat = "STRING"
        }
      }
    ]
  }
}

# Specify mapping applies INBOUND only.
mappingTypes = ["InitialRequest", "UpdateRequest", "EventRequest",
"TerminateRequest"]

encodedExtension = {
  profileTag = 8000
  profileFormat = "ARRAY"
}
}
}

```

The configuration for Key Arrays: Outbound is identical to above, except the mapping types are:

```

# Specify mapping applies OUTBOUND only.
mappingTypes = ["InitialResponse", "UpdateResponse", "EventResponse",
"TerminateResponse"]

```

Mapping

This table shows the mapping of Diameter AVPs to ACS profile blocks resulting from the worked example key array configuration section above. This example is for inbound.

Diameter AVP				Profile Block			
Root AVP	1 st Level	2 nd Level	Value	Profile Block (ARRAY)	Sub-Profile Block	Tag	Value
1000	4400	4410	220	8000	1	9998	220
		4420	"6449016000"			9999	"6449016000"
		4430	"Chris"			10000	"Chris"
	4400	4410	221		2	9998	221
		4420	"123123123"			9999	"123123123"
		4430	"Fred"			10000	"Fred"

The mapping is a simple 1:1 mapping. For outbound, the mappings are the same, but in the reverse direction.

Array with Conditions

Introduction

In the case where the AVP to be mapped is the child of a repeating AVP, or where there are multiple mappings, to be made for different child AVPs, you may apply Array With Conditions mapping.

Array with conditions is a means of performing selective mapping based on the values of other AVPs, that is, not all AVPs are mapped, as DCA only considers or allows specific AVPs to be mapped if and only if a specified criterion is met.

Depending on the mapping type (inbound or outbound), the criteria involves matching the value of an AVP or an acsProfile against a list of known values.

Array with Conditions configuration

Here is the example Array with Conditions configuration in the Services AVPMappings section of the `eserv.config`.

```
{ # Array with Conditions Example
  AVPs = [ # Root-Level AVPs
    {
      AvpCodes = [ # 1st Entry in Root-Level AVPs
        {
          avpCode = 7020
        }
      ]
    }
  ]
  AVPs = [ # 1st-Level AVPs
    { # 1st Entry in 1st-Level AVPs
      AvpCodes = [
        {
          avpCode = 1000
          repeating = true
        }
      ]
    }
  ]
  AVPs = [ # 2nd-Level AVPs
    { # 1st Entry in 2nd-Level AVPs
      AvpCodes = [
        {
          avpCode = 2000
          repeating = true
        }
      ]
    }
  ]
}
```

```

    }
  ]
  TypeCriteria = [
    { # 1st Type Criterion
      includeIfMatches = [ 1, 11, 101 ]
      AvpCodes = [
        {
          avpCode = 3000
        }
      ]
      avpFormat = "Integer32"
      encodedExtension = {
        profileTag = 80100
        profileFormat = "INTEGER"
      }

      # AVPs below will be included if a match is found
      for 1st Type Criterion
      AVPs = [ # Conditional AVPs for 1st Type
      Criterion
        {
          AvpCodes = [
            {
              avpCode = 3001
              repeating = true
            }
          ]
          avpFormat = "UTF8String"
          encodedExtension = {
            profileTag = 80101
            profileFormat = "STRING"
          }# End of Conditional AVPs for 1st Type
          Criterion
        }
      ]
    } # End of 1st Type Criterion
    { # 2nd Type Criterion
      includeIfMatches = [ 2, 22, 202 ]
      AvpCodes = [
        {
          avpCode = 3000
        }
      ]
      avpFormat = "Integer32"
      encodedExtension = {
        profileTag = 80100
        profileFormat = "INTEGER"
      }

      # AVPs below will be included if a match is found
      for 2nd Type Criteria
      AVPs = [ # Conditional AVPs for 2nd Type Criterion
        {
          AvpCodes = [
            {
              avpCode = 3001
              repeating = true
            }
          ]
          avpFormat = "UTF8String"
          encodedExtension = {
            profileTag = 80101
            profileFormat = "STRING"
          }
        }
      ]
    }
  ]

```



```

    }
    ] # End of Conditional AVPs for 2nd Type Criterion
  } # End of 2nd Type Criterion
  ] # End of TypeCriteria
  } # End of 1st Entry of 2nd-Level AVPs
] # End of 2nd-Level AVPs
} # End of 1st Entry of 1st-Level AVPs
] # End of 1st-Level AVPs
} # End of 1st Entry of Root-Level AVPs
] # End of Root-Level AVPs

# Specify mapping applies INBOUND only.
mappingTypes = ["InitialRequest", "UpdateRequest", "EventRequest",
"TerminateRequest"]

avpFormat = "Grouped"
encodedExtension = {
  profileTag = 8020
  profileFormat = "ARRAY"
}
}

```

Array with Conditions - inbound - example 1

Here is a worked example of an array with conditions: inbound configuration.

Map only matching entry, not condition (AVP(3000)==1) inbound

```

{
  AVPs = [
    {
      AvpCodes = [
        { avpCode = 1000 }
      ]
      AVPs = [
        {
          AvpCodes = [
            { avpCode = 2000          # <-- 1000.2000
              repeating = true       # <--      2000 is repeating
            }
          ]
          TypeCriteria = [
            {
              includeIfMatches = [ 1 ]
              AvpCodes = [
                { avpCode = 3000      # <-- 1000.2000.3000 Inbound
                  Only
                }
              ]
              avpFormat = "Integer32" # <-- Inbound Only

              # This is what is included if match found
              AVPs = [
                {
                  AvpCodes = [
                    { avpCode = 3001   # <-- 1000.2000.3001
                      repeating = true # <--      3001 is
                    }
                  ]
                  avpFormat = "UTF8String"
                  encodedExtension = {

```



```

TypeCriteria = [
  {
    includeIfMatches = [ 1 ]
    AvpCodes = [
      { avpCode = 3000      # <-- 1000.2000.3000 Inbound
        Only
      }
    ]
    avpFormat = "Integer32"  # <-- Inbound Only

    # This is what is included if match found
    AVPs = [
      {
        AvpCodes = [
          { avpCode = 3000  # <-- 1000.2000.3000
            }
          ]
        avpFormat = "Integer32"
        encodedExtension = {
          profileTag = 99  # Array element in sub-
          profile block
          profileFormat = "INTEGER"
        }
      }
      {
        AvpCodes = [
          { avpCode = 3001  # <-- 1000.2000.3001
            repeating = true # <--          3001 is
            repeating
          }
          ]
        avpFormat = "UTF8String"
        encodedExtension = {
          profileTag = 100  # Array element in sub-
          profile block
          profileFormat = "STRING"
        }
      }
    ]
  }
]
}

# Specify mapping applies INBOUND only.
mappingTypes = ["InitialRequest", "UpdateRequest", "EventRequest",
"TerminateRequest"]

encodedExtension = {
  profileTag = 8020
  profileFormat = "ARRAY"
}
}

```

Mapping

This table shows the mapping of Diameter AVPs to ACS Profile Blocks resulting from the worked example array with conditions configuration section above. This example is for inbound.

Diameter AVP				Profile Block				
Root AVP	1 st Level	2 nd Level	Value	Profile Block (ARRAY)	Sub-Profile Block	Tag	Value	
1000	2000	3000	1	8000	1	99	1	
		3001	"6449016000"			100	"6449016000"	
		3001	"6449016001"			2	99	1
	2000	3000	2		100	3	99	"6449016001"
		3001	"123123123"				99	1
		3001	"6449016000"				100	"666666666"
		3001	"6449016001"					
		3001	"6449016002"					
		3001	"6449016003"					
		3001	"6449016003"					
	2000	3000	1					
		3001	"666666666"					

Array with Conditions - outbound - example 1

Here is the example array with conditions: outbound configuration.

Map only profileTag100. No typeCriteria against a profileTag. Outgoing AVP 3000 is set using a literal.

```

{
  AVPs = [
    {
      AvpCodes = [
        { avpCode = 1000 }
      ]
      AVPs = [
        {
          AvpCodes = [
            { avpCode = 2000 # <-- 1000.2000
          ]
        }
      ]
      # Just map as follows (no type Criteria specified)
      AVPs = [
        {
          AvpCodes = [
            { avpCode = 3000 # <-- 1000.2000.3000
          ]
          avpFormat = "Integer32"
          literal = 1 # i.e. Outbound only (*not* mapping from profileTag99)
        }
      ]
        {
          AvpCodes = [
            { avpCode = 3001 # <-- 1000.2000.3001
              repeating = true # <-- 3001 is repeating
            }
          ]
          avpFormat = "UTF8String"
          encodedExtension = {
            profileTag = 100 # Array element in sub-profile block
            profileFormat = "STRING"
          }
        }
      ]
    }
  ]
}

```

```

    ]
  }
}
]
# Specify mapping applies OUTBOUND only.
mappingTypes = ["InitialResponse", "UpdateResponse", "EventResponse",
"TerminateResponse"]

encodedExtension = {
  profileTag = 8000
  profileFormat = "ARRAY"
}
}
}

```

Mapping

This table shows the mapping ACS profile blocks to AVPs in the example array with conditions configuration section in this topic. This example is for outbound.

Profile Block				Diameter AVP				
Profile Block (ARRAY)	Sub-Profile Block	Tag	Value	Root AVP	1 st Level AVP	2 nd Level AVP	Value	
8000	1	99	1	1000	2000	3000	1	
		100	"6449016000"			3001	"6449016000"	
		101	"something"			3001	"6449016001"	
	2	99	1	1000	2000	3000	3001	"666666666"
		100	"6449016001"					
		101	"something"					
		102	"else"					
	3	99	1	1000	2000	3000	3001	"666666666"
		100	"666666666"					
		101	"other"					

Array with Conditions - outbound - example 2

Here is the example array with conditions: outbound configuration.

Map only profileTag 100. No typeCriteria against a profileTag. Outgoing AVP 3000 is set using a literal.

```

{
  AVPs = [
    {
      AvpCodes = [
        { avpCode = 1000 }
      ]
      AVPs = [
        {
          AvpCodes = [
            { avpCode = 2000 # <-- 1000.2000
              repeating = true # <-- 2000 is repeating
            }
          ]
        }
      ]
      # Just map as follows (no type Criteria specified)
      AVPs = [
        {
          AvpCodes = [
            { avpCode = 3000 # <-- 1000.2000.3000
            }
          ]
        }
      ]
    }
  ]
}

```

```

    ]
    avpFormat = "Integer32"
    literal = 1 # i.e. Outbound only (*not*
    mapping from profileTag99)
  }
  {
    AvpCodes = [
      { avpCode = 3001 # <-- 1000.2000.3001
      }
    ]
    avpFormat = "UTF8String"
    encodedExtension = {
      profileTag = 100 # Array element in sub-profile
      block
      profileFormat = "STRING"
    }
  }
  ]
}
]
}
]
}
# Specify mapping applies OUTBOUND only.
mappingTypes = ["InitialResponse", "UpdateResponse", "EventResponse",
"TerminateResponse"]

encodedExtension = {
  profileTag = 8000
  profileFormat = "ARRAY"
}
}
}

```

Mapping

This table shows the mapping ACS profile blocks to AVPs in the example array with conditions configuration section in this topic. This example is for outbound.

Profile Block				Diameter AVP				
Profile Block (ARRAY)	Sub-Profile Block	Tag	Value	Root AVP	1st Level AVP	2nd Level AVP	Value	
8000	1	100	"6449016000"	1000	2000	3000	1	
		101	"something"			3001	"6449016000"	
		102	"else"		2000	3000	1	
		103	"and more"			3001	"6449016001"	
	2	2	100	"6449016001"	2000	2000	3000	1
			101	"another"			3001	"6666666666"
			102	"something"		3001		
			103	"more"				
	3	3	100	"6666666666"				
			100	"and"				
			101	"others"				

Array with Conditions - outbound - example 3

Here is the example array with conditions: outbound configuration.

Map only profileTag 100 with typeCriteria specified against profileTag 99. Outgoing AVP 3000 is set based on profileTag 99.

```

{
  AVPs = [
    {

```

```

AvpCodes = [
  { avpCode = 1000 }
]
AVPs = [
  {
    AvpCodes = [
      {avpCode = 2000          # <-- 1000.2000
      }
    ]
    TypeCriteria = [
      {
        includeIfMatches = [ 1 ] # <-- Only profileTag(99)==1
        are mapped
        encodedExtension = {
          profileTag = 99 # Array element in sub-profile
          block
          profileFormat = "INTEGER"
        }

        # This is what is included if match found:
        AVPs = [
          {
            AvpCodes = [
              { avpCode = 3000 # <-- 1000.2000.3000
              }
            ]
            avpFormat = "Integer32"
            encodedExtension = {
              profileTag = 99 # Also include the matched
              value(1) in outbound msg
              profileFormat = "INTEGER"
            }
          }
        ]
        {
          AvpCodes = [
            { avpCode = 3001 # <-- 1000.2000.3001
              repeating = true # <--          3001 is
            }
          ]
          avpFormat = "UTF8String"
          encodedExtension = {
            profileTag = 100 # Array element in sub-
            profile block
            profileFormat = "STRING"
          }
        }
      ]
    ]
  }
]

# Specify mapping applies OUTBOUND only.
mappingTypes = ["InitialResponse", "UpdateResponse", "EventResponse",
"TerminateResponse"]

encodedExtension = {
  profileTag = 8000
  profileFormat = "ARRAY"
}
}

```

Mapping

This table shows the mapping ACS profile blocks to AVPs in the example array with conditions configuration section in this topic. This example is for outbound.

Profile Block				Diameter AVP			
Profile Block (ARRAY)	Sub-Profile Block	Tag	Value	Root AVP	1 st Level AVP	2 nd Level AVP	Value
8000	1	99	1	1000	2000	3000	1
		100	"6449016000"			3001	"6449016000"
		101	"something"			3001	"666666666"
	2	99	2				
		100	"6449016001"				
		101	"something"				
		102	"else"				
	3	99	1				
		100	"6666666666"				
		101	"others"				

Array with Conditions - outbound - example 4

Here is the example array with conditions: outbound configuration.

Map only profileTag 100 with typeCriteria specified against profileTag 99. No AVP 3000 in outgoing diameter message.

```
{
  AVPs = [
    {
      AvpCodes = [
        { avpCode = 1000 }
      ]
      AVPs = [
        {
          AvpCodes = [
            {avpCode = 2000          # <-- 1000.2000
          ]
          TypeCriteria = [
            {
              includeIfMatches = [ 1 ] # <-- Only profileTag(99)==1
              are mapped
              encodedExtension = {
                profileTag = 99 # Array element in sub-profile
                block
                profileFormat = "INTEGER"
              }
            }
          ]
          # This is what is included if match found:
          AVPs = [
            AvpCodes = [
              { avpCode = 3001 # <-- 1000.2000.3001
                repeating = true # <--          3001 is
              }
            ]
            avpFormat = "UTF8String"
            encodedExtension = {
              profileTag = 100 # Array element in sub-
              profile block
              profileFormat = "STRING"
            }
          ]
        }
      ]
    }
  ]
}
```



```

    ]
  }
}
]
# Specify mapping applies OUTBOUND only.
mappingTypes = ["InitialResponse", "UpdateResponse", "EventResponse",
"TerminateResponse"]

encodedExtension = {
  profileTag = 8000
  profileFormat = "ARRAY"
}
}
}

```

Mapping

This table shows the mapping ACS profile blocks to AVPs in the example array with conditions configuration section in this topic. This example is for outbound.

Profile Block				Diameter AVP			
Profile Block (ARRAY)	Sub-Profile Block	Tag	Value	Root AVP	1 st Level AVP	2 nd Level AVP	Value
8000	1	99	1	1000	2000	3001	"6449016000"
		100	"6449016000"			3001	"666666666"
		101	"something"				
	2	99	2				
		100	"6449016001"				
		101	"something"				
	3	99	1				
		100	"666666666"				
		101	"others"				

Array with Context

Introduction

A key array has a limitation in that it cannot handle the situation when the possible key values are not well known, for example, in cases when we may not have a unique key, or the key might otherwise rely on multiple items from the hierarchy. For these cases, you may use Array with Context mapping.

The key here is that DCA allows other sub-AVPs in a hierarchy to be marked as a Context AVP, using the parameter setting `contextAVP = true`. All AVPs marked as a Context AVP then collectively make the items which provide context.

Array with Context configuration

Here is the example Array with Context configuration in the Services `AVPMappings` section of the `eserv.config`.

```

{ # Array with Context Example
  AVPs = [ # Root-Level AVPs
    { # 1st Entry of Root-Level AVPs
      AvpCodes = [

```

```

    {
        avpCode = 7030
    }
]
AVPs = [ # 1st-Level AVPs
    { # 1st Entry of 1st-Level AVPs
        AvpCodes = [
            {
                avpCode = 1000
            }
        ]
        AVPs = [ # 2nd-Level AVPs
            { # 1st Entry of 2nd-Level AVPs
                AvpCodes = [
                    {
                        avpCode = 2000
                        repeating = true
                    }
                ]
                AVPs = [ # 3rd-Level AVPs
                    { # Context AVP
                        AvpCodes = [
                            {
                                avpCode = 3000    # This is AVP
                                7030.1000.2000.3000
                            }
                        ]
                        contextAVP = true
                        avpFormat = "UTF8String"
                        encodedExtension = {
                            profileTag = 80301
                            profileFormat = "STRING"
                        }
                    }
                ]
            } # Data AVP
            AvpCodes = [
                {
                    avpCode = 3001    # This is AVP
                    7030.1000.2000.3001
                    repeating = true
                }
            ]
            avpFormat = "UTF8String"
            encodedExtension = {
                profileTag = 80303
                profileFormat = "STRING"
            }
        } # End of Data AVP
    ] # End of 3rd-Level AVPs
} # End of 1st Entry of 2nd-Level AVPs
{ # 2nd Entry of 2nd-Level AVPs (Context AVP)
    AvpCodes = [
        {
            avpCode = 2001    # This is AVP 7030.1000.2001
        }
    ]
    contextAVP = true
    avpFormat = "UTF8String"
    encodedExtension = {
        profileTag = 80302
        profileFormat = "STRING"
    }
} # End of 2nd Entry of 2nd-Level AVPs (Content AVP)
] # End of 2nd-Level AVPs

```

```

        } # End of 1st Entry of 1st-Level AVPs
    ] # End 1st-Level AVPs
} # End of 1st Entry of Root-Level AVPs
] # End of Root-Level AVPs

# Specify mapping applies INBOUND only.
mappingTypes = ["InitialRequest", "UpdateRequest", "EventRequest",
"TerminateRequest"]

avpFormat = "Grouped"
encodedExtension = {
    profileTag = 8030
    profileFormat = "ARRAY"
}
} # End of Array with Context Example

```

Array with Context - inbound example

Here is an example of the Array with Context configuration in the Services AVPMappings section.

```

{
    AVPs = [
        {
            AvpCodes = [
                {
                    avpCode = 1000
                }
            ]
            AVPs = [
                {
                    AvpCodes = [
                        {
                            avpCode = 2000 # <-- 1000.2000
                            repeating = true # <-- 2000 is repeating
                        }
                    ]
                }
            ]
            AVPs = [
                {
                    AvpCodes = [
                        { avpCode = 3000 # <-- 1000.2000.3000
                        }
                    ]
                    avpFormat = "UTF8String"
                    encodedExtension = {
                        profileTag = 101 # Array element in sub-profile
                        block
                        profileFormat = "STRING"
                    }
                    contextAVP = true
                }
            ]
        }
    ]
    AVPs = [
        {
            AvpCodes = [
                { avpCode = 3001 # <-- 1000.2000.3001
                }
            ]
            avpFormat = "UTF8String"
            encodedExtension = {
                profileTag = 102 # <-- Array element in sub-profile
                block
                profileFormat = "STRING"
            }
        }
    ]
}

```

```

    }
  ]
}
{
  AvpCodes = [
    { avpCode = 2001 # <-- 1000.2001
    }
  ]
  avpFormat = "UTF8String"
  encodedExtension = {
    profileTag = 100 # <-- Array element in sub-profile block
    profileFormat = "STRING"
  }
  contextAVP = true
}
]
}

# Specify mapping applies INBOUND only.
mappingTypes = ["InitialRequest", "UpdateRequest", "EventRequest",
"TerminateRequest"]

encodedExtension = {
  profileTag = 8000
  profileFormat = "ARRAY"
}
}
}

```

Mapping

This table shows the mapping AVPs to ACS profile blocks in the example array with context configuration section in this topic. This example is for inbound.

Diameter Message				Profile Block			
Root AVP	1st Level	2nd Level	Value	Profile Block (ARRAY)	Sub-Profile Block	Tag	Value
1000	2000	3000	"ContextB"	8000	1	100	"RootContext"
		3001	"6449016000"			101	"ContextB"
		3001	"6449016001"			102	"6449016000"
	2001	"RootContext"			2	100	"RootContext"
	2000	3000	"ContextC"			101	"ContextB"
		3001	"123123123"			102	"6449016001"
				3	100	"RootContext"	
					101	"ContextC"	
					102	"123123123"	

Array with Context - outbound example 1

Here is an example of the array with context outbound configuration in the Services AVPMappings section.

AVP 3001 is not repeating in the outbound Diameter message.

```

{
  AVPs = [
    {
      AvpCodes = [
        {
          avpCode = 1000
        }
      ]
    }
  ]
}

```

```

AVPs = [
  {
    AvpCodes = [
      {
        avpCode = 2000      # <-- 1000.2000
        repeating = true   # <--      2000 is repeating
      }
    ]
    AVPs = [
      {
        AvpCodes = [
          { avpCode = 3000 # <-- 1000.2000.3000
          }
        ]
        avpFormat = "UTF8String"
        encodedExtension = {
          profileTag = 101 # Array element in sub-profile
            block
          profileFormat = "STRING"
        }
        contextAVP = true
      }
      {
        AvpCodes = [
          { avpCode = 3001 # <-- 1000.2000.3001 (not
            repeating)
          }
        ]
        avpFormat = "UTF8String"
        encodedExtension = {
          profileTag = 102 # <-- Array element in sub-profile
            block
          profileFormat = "STRING"
        }
      }
    ]
  }
  {
    AvpCodes = [
      { avpCode = 2001      # <-- 1000.2001
      }
    ]
    avpFormat = "UTF8String"
    encodedExtension = {
      profileTag = 100     # <-- Array element in sub-profile block
      profileFormat = "STRING"
    }
    contextAVP = true
  }
]
}

# Specify mapping applies OUTBOUND only.
mappingTypes = ["InitialResponse", "UpdateResponse", "EventResponse",
"TerminateResponse"]

encodedExtension = {
  profileTag = 8000
  profileFormat = "ARRAY"
}
}

```

Mapping

AVP 3001 is not repeating in the outbound Diameter message.

Profile Block				Diameter AVP			
Profile Block (ARRAY)	Sub-Profile Block	Tag	Value	Root AVP	1 st Level AVP	2 nd Level AVP	Value
8000	1	100	"RootContext"	1000	2000	3000	"ContextB"
		101	"ContextB"			3001	"6449016000"
		102	"6449016000"			3000	"ContextB"
	2	100	"RootContext"		2000	3001	"6449016001"
		101	"ContextB"			3000	"ContextC"
		102	"6449016001"			3001	"123123123"
	3	100	"RootContext"	2001			"RootContext"
		101	"ContextC"				
		102	"123123123"				

Array with Context - outbound example 2

Adding `repeating` to the AVP 3001 configuration shown in *Array with Context - outbound example 1* (on page 102), produces the mapping shown in mapping example 2.

```

AvpCodes = [
  { avpCode = 3001 # <-- 1000.2000.3001
    repeating = true # <-- 3001 is repeating
  }
]

```

Mapping

AVP 3001 is repeating in the outbound Diameter message.

Profile Block				Diameter AVP			
Profile Block (ARRAY)	Sub-Profile Block	Tag	Value	Root AVP	1 st Level AVP	2 nd Level AVP	Value
8000	1	100	"RootContext"	1000	2000	3000	"ContextB"
		101	"ContextB"			3001	"6449016000"
		102	"6449016000"			3001	"6449016001"
	2	100	"RootContext"		2000	3000	"ContextC"
		101	"ContextB"			3001	"123123123"
		102	"6449016001"				
	3	100	"RootContext"	2001			"RootContext"
		101	"ContextC"				
		102	"123123123"				

Conditional AVP

Introduction

Conditional AVP enables you to perform a mapping based on the value of another AVP. For example, we might want to map the Service-Parameter-Value AVP in a grouped Service-Parameter-Info AVP to a profile field, but only if its type (specified in the Service-Parameter-Type AVP) is one we are interested in. The conditional AVP includes the `typeCriteria` array to specify the condition to match.

For outbound mapping, conditional AVPs enable mapping to be performed based on the value:

- In a profile block, and/or
- Of another AVP in the outbound message being constructed

Conditional AVP configuration

Here is an example of the Conditional AVP configuration in the Services AVPMappings section of the `eserv.config`.

```
{
  AVPs = [ # Root-Level AVPs
    { # 1st Entry of Root-Level AVPs
      AvpCodes = [
        {
          avpCode = 4000
        }
      ]
      TypeCriteria = [
        { # 1st Criterion
          AvpCodes = [
            {
              avpCode = 4001
            }
          ]
          includeIfMatches = [ 1, 10, 101, 1001, 10001 ]
          avpFormat = "Integer32"

          # This is the AVP that is searched and map if a match is found
          AVPs = [ # Conditional AVPs for 1st Criterion
            {
              AvpCodes = [
                {
                  avpCode = 4002
                }
              ]
              avpFormat = "UTF8String"
              encodedExtension = {
                profileTag = 99123
                profileFormat = "STRING"
              }
            }
          ] # End of Conditional AVPs for 1st Criterion
        } # End of 1st Criterion
        { # 2nd Criterion
          AvpCodes = [
            {
              avpCode = 4001
            }
          ]
          includeIfMatches = [ 2, 20, 202, 2002, 20002 ]
          avpFormat = "Integer32"

          # This is the AVP that is searched and map if a match is found
          AVPs = [ # Conditional AVPs for 2nd Criterion
            {
              AvpCodes = [
                {
                  avpCode = 4002
                }
              ]
              avpFormat = "UTF8String"
              encodedExtension = {
                profileTag = 99124
                profileFormat = "STRING"
              }
            }
          ] # End of Conditional AVPs for 2nd Criterion
        }
      ]
    }
  ]
}
```

```

        } # End of 2nd Criterion
    ] # End of TypeCriteria
} # End of 1st Entry of Root-Level AVPs
] # End of Root-Level AVPs

# Specify mapping applies INBOUND only.
mappingTypes = ["InitialRequest", "UpdateRequest", "EventRequest",
"TerminateRequest"]

# Profile tag 99123 or 99124 is encoded as a child element inside an acsProfile
Array.
encodedExtension = {
    profileTag = 8000
    profileFormat = "ARRAY"
}
} # End of Conditional AVP Example

```

Note: "Conditional AVPs" look similar to a non-repeating / non-ProfileArray case of "Array with Conditions". See *Array with Conditions - inbound - example 1* (on page 91).

If the `avpCode` being matched is not nested, you can map it without using `typeCriteria`, by configuring the condition outside `AVPs = [...]`. See *Simple conditional* (on page 82).

Conditional AVP - inbound example 1

Here is an example of the conditional AVP configuration in the Services AVPMappings section.

Service-Parameter-Info (440)

- Service-Parameter-Type (441)
- Service-Parameter-Value (442)

Map only matching entry, not condition.

In this example, no parent level (ARRAY-type) encoding format is specified here as encoding specified in leaf or child element of AVPs above are encoded at the root level of the ACS profile block.

```

{
  AVPs = [
    {
      AvpCodes = [
        {
          avpCode = 440
        }
      ]
      TypeCriteria = [
        { # Criteria for match value [ 1 ]
          includeIfMatches = [ 1 ]
          AvpCodes = [
            { avpCode = 441          # <-- Inbound only: 441
            }
          ]
          # or if specifying a fully qualified path:
          # AvpCodes = [
          # { avpCode = 440 }
          # { avpCode = 441 }
          # ]
          avpFormat = "Integer32"    # <-- Inbound only

          # This is what to include if match found:
          AVPs = [
            {
              AvpCodes = [
                { avpCode = 442 # <-- 440.442

```



```

    }
  ]
  avpFormat = "UTF8String"
  encodedExtension = {
    profileTag = 99123 # Array element in sub-profile
    block
    profileFormat = "STRING"
  }
}
]
}
{ # Criteria for match value [ 2 ]
  includeIfMatches = [ 2 ]
  AvpCodes = [
    { avpCode = 441          # <-- Inbound only: 441
    }
  ]
  avpFormat = "Integer32"      # <-- Inbound only

  # This is what to include if match found:
  AVPs = [
    {
      AvpCodes = [
        { avpCode = 442 # <-- 440.442
        }
      ]
      avpFormat = "UTF8String"
      encodedExtension = {
        profileTag = 99124 # Array element in sub-profile
        block
        profileFormat = "STRING"
      }
    }
  ]
}
]
}
]
}

# Specify mapping applies INBOUND only.
mappingTypes = ["InitialRequest", "UpdateRequest", "EventRequest",
"TerminateRequest"]
}

```

Mapping example 1

This table shows the mapping AVPs to ACS profile blocks in the example conditional AVPs configuration section in this topic. This example is for inbound.

Diameter AVP			Profile Block	
Root AVP	1 st Level	Value	Tag	Value
440	441	1	99123	"Value for Type 1"
	442	"Value for Type 1"		

or

Diameter AVP			Profile Block	
Root AVP	1 st Level	Value	Tag	Value
440	441	2	99124	"Value for Type 2"
	442	"Value for Type 2"		

Conditional AVP example 1

Here is an example of the conditional AVP configuration in the Services AVPMappings section.

Adding the following configuration to the AVPs to include if match is found to each criterion for match value produces the mapping shown in mapping example 2.

Map only matching entry, not condition.

```

{
  AvpCodes = [
    { avpCode = 441 # <-- 440.441
    }
  ]
  avpFormat = "Integer32"
  encodedExtension = {
    profileTag = 99001 # Array element in sub-profile block
    profileFormat = "INTEGER"
  }
}

```

Mapping example 2

This table shows the mapping AVPs to ACS profile blocks in the example conditional AVPs configuration section in this topic. This example is for inbound.

Diameter AVP			Profile Block	
Root AVP	1st Level	Value	Tag	Value
440	441	1	90001	1
	442	"Value for Type 1"	99123	"Value for Type 1"

or

Diameter AVP			Profile Block	
Root AVP	1st Level	Value	Tag	Value
440	441	2	90001	2
	442	"Value for Type 2"	99124	"Value for Type 2"

Conditional AVP example 3

Here is an example of the conditional AVP configuration in the Services AVPMappings section.

This is the same as *Conditional AVP - inbound example 1* (on page 106) but maps to an acsProfile ARRAY, by adding the following configuration to the end.

Map only matching entry, not condition, but map to an acsProfile ARRAY.

```

  encodedExtension = {
    profileTag = 8000
    profileFormat = "ARRAY"
  }

```

Mapping example 3

This table shows the mapping AVPs to ACS profile blocks in the example conditional AVPs configuration section in this topic. This example is for inbound.

Note similarity with the non-repeating array with conditions.

Diameter AVP			Profile Block			
Root AVP	1 st Level	Value	Profile Block (ARRAY)	Sub-Profile Block	Tag	Value
440	441	1	80001	1	99123	"Value for Type 1"
	442	"Value for Type 1"				

Diameter AVP			Profile Block			
Root AVP	1 st Level	Value	Profile Block (ARRAY)	Sub-Profile Block	Tag	Value
440	441	2	80001	2	99123	"Value for Type 2"
	442	"Value for Type 2"				

Conditional AVP - outbound example 1

Here is an example outbound conditional AVP configuration in the Services AVPMappings section.

No ACS profileTag conditions applicable when mapping to outbound Diameter message.

In this example, no parent level (ARRAY-type) encoding format is specified here as encoding specified in leaf or child element of AVPs above are encoded at the root level of the ACS Profile Block.

```
{
  AVPs = [
    {
      AvpCodes = [
        {
          avpCode = 440
        }
      ]
      TypeCriteria = [
        {
          # Criteria for match tag 99123
          includeIfMatches = [ ] # <-- Match any value as long as
            profileTag 99123 is present
          encodedExtension = {
            profileTag = 99123          # <-- Outbound Only
            profileFormat = "STRING"   # <-- Outbound Only
          }

          # This is what to include if match found:
          AVPs = [
            #Include type sub-AVP 1
            {
              AvpCodes = [
                { avpCode = 441 # <-- 440.441
                }
              ]
              avpFormat = "UTF8String"
              encodedExtension = {
                profileTag = 99123 # Array element in sub-profile
                  block
                profileFormat = "STRING"
              }
            }
          ]
        }
      ]
    }
    { # Criteria for match tag 99124
      includeIfMatches = [ ] # <-- Match any value as long as
        profileTag 99124 is present
    }
  ]
}
```

```

encodedExtension = {
  profileTag = 99124          # <-- Outbound Only
  profileFormat = "STRING"   # <-- Outbound Only
}

# This is what to include if match found:
AVPs = [
  #Include type sub-AVP 2
  {
    AvpCodes = [
      { avpCode = 441 # <-- 440.441
      }
    ]
    avpFormat = "Integer32"
    literal = 2          # not mapped from a tag in the profile
                        block
  }
  {
    AvpCodes = [
      { avpCode = 442 # <-- 440.442
      }
    ]
    avpFormat = "UTF8String"
    encodedExtension = {
      profileTag = 99124 # Array element in sub-profile
                        block
      profileFormat = "STRING"
    }
  }
]

# Specify mapping applies OUTBOUND only.
mappingTypes = ["InitialResponse", "UpdateResponse", "EventResponse",
"TerminateResponse"]
}

```

Mapping example 1 - conditional - outbound

This table shows the mapping ACS profile blocks to AVPs to in the example conditional AVPs configuration section in this topic. This example is for outbound.

Profile Block		Diameter AVP		
Tag	Value	Root AVP	1 st Level	2 nd Level
99123	"Value for Type 1"	440	441	1
			442	"Value for Type 1"

or

Profile Block		Diameter AVP		
Tag	Value	Root AVP	1 st Level	2 nd Level
99124	"Value for Type 2"	440	441	2
			442	"Value for Type 2"

Conditional AVP - outbound example 2

Here is an example outbound conditional AVP configuration in the Services AVPMappings section.

Only the matching entries in ACS Profile Block are mapped in outbound Diameter message (Condition is "profileTag(90001) == 2")

In this example, no parent level (ARRAY-type) encoding format is specified here as encoding specified in leaf or child element of AVPs above are encoded at the root level of the ACS Profile Block.

```

{
  AVPs = [
    {
      AvpCodes = [
        {
          avpCode = 440
        }
      ]
      TypeCriteria = [

        { # Criteria for match value [1] In this example, this is NOT the
          matching entry.
          includeIfMatches = [ 1 ]
          encodedExtension = {
            profileTag = 90001 # <-- Outbound Only
            profileFormat = "STRING" # <-- Outbound Only
          }

          # This is what to include if match found:
          AVPs = [
            #Include type sub-AVP (the matching condition)
            {
              AvpCodes = [
                { avpCode = 441 # <-- 440.441
                }
              ]
              avpFormat = "Integer32"
              encodedExtension = {
                profileTag = 90001 # Array element in sub-profile
                block
                profileFormat = "INTEGER"
              }
            }
          ]
        }
      ]
    }
  ]
}

{ # Criteria for match value [2] In this example, this is the
  matching entry.
  includeIfMatches = [ 2 ]
  encodedExtension = {
    profileTag = 90001 # <-- Outbound Only
    profileFormat = "INTEGER" # <-- Outbound Only
  }

  # This is what to include if match found:
  AVPs = [

```

```

#Include type sub-AVP (the matching condition)
{
  AvpCodes = [
    { avpCode = 441 # <-- 440.441
    }
  ]
  avpFormat = "Integer32"
  encodedExtension = {
    profileTag = 90001 # Array element in sub-profile
    block
    profileFormat = "INTEGER"
  }
}
{
  AvpCodes = [
    { avpCode = 442 # <-- 440.442
    }
  ]
  avpFormat = "UTF8String"
  encodedExtension = {
    profileTag = 99124 # Array element in sub-profile
    block
    profileFormat = "STRING"
  }
}
]
}
]
}
# Specify mapping applies OUTBOUND only.
mappingTypes = ["InitialResponse", "UpdateResponse", "EventResponse",
"TerminateResponse"]
}

```

Mapping example 2 - conditional - outbound

This table shows the mapping ACS profile blocks to AVPs to in the example conditional AVPs configuration section in this topic. This example is for outbound.

Profile Block		Diameter AVP		
Tag	Value	Root AVP	1 st Level	2 nd Level
90001	2	440	441	2
99124	"Value for Type 2"		442	"Value for Type 2"

Prefix Tree

Introduction

Prefix Tree enables you to map repeating AVPs to and from a prefix tree ACS profile block, specified using `profileFormat = "PREFIXTREE"`.

Prefix Tree configuration

Here is an example of the Prefix Tree configuration in the Services AVPMappings section of the `eserv.config` file.

```

{
  AVPs = [ # Root-Level AVPs

```

```

{
  AvpCodes = [
    {
      avpCode = 7100
      vendorId = "<Vendor ID>" # Optional. Vendor specific AVP, if
      present.
    }
  ]
  AVPs = [ # 1st-Level AVPs
    {
      AvpCodes = [
        {
          avpCode = 1000
        }
      ]
      AVPs = [ # 2nd-Level AVPs
        {
          AvpCodes = [
            {
              avpCode = 2000
              repeating = true
            }
          ]
          avpFormat = "UTF8String"
        }
      ] # End of 2nd-Level AVPs
    }
  ] # End of 1st-Level AVPs
}
] # End of Root-Level AVPs
avpFormat = "Grouped"
encodedExtension = {
  profileTag = 8100
  profileFormat = "PREFIXTREE"
}

# Specify mapping applies INBOUND only.
mappingTypes = ["InitialRequest", "UpdateRequest", "EventRequest",
"TerminateRequest"]

# AVPs above are encoded into a PREFIXTREE-type in an ACS Profile Block.
encodedExtension = {
  profileTag = 7000
  profileFormat = "PREFIXTREE"
}
} # End of Prefix Tree example

```

Prefix Tree example

Here is an example of the prefix tree configuration in the `Services AVPMappings` section.

Note that the parent tag is specified outside of the AVPs array block. Parent tag 7000 has type "PREFIXTREE", hence `profileTag` and `profileFormat` for child elements are not applicable as this child AVP is encoded as entries within a prefix tree.

```

{
  AvpCodes = [
    avpCode = 1000
  ]
  AVPs = [
    {
      AvpCodes = [

```

Chapter 4

```
        {
            avpCode = 2000                # <-- 1000.2000
            repeating = true              # <--      2000 is repeating
        }
    ]
    avpFormat = "UTF8String"

}

]
# Specify mapping applies INBOUND only.
mappingTypes = ["InitialRequest", "UpdateRequest", "EventRequest",
"TerminateRequest"]

encodedExtension = {
    profileTag = 7000
    profileFormat = "PREFIXTREE"
}
}
```

To specify outbound, the mappingTypes are specified as:

```
# Specify mapping applies OUTBOUND only.
mappingTypes = ["InitialResponse", "UpdateResponse", "EventResponse",
"TerminateResponse"]
```

Mapping

This table shows the mapping AVPs to ACS profile blocks in the example prefix tree configuration section in this topic. This example is for inbound. For outbound, the mapping direction is reversed.

Diameter AVP			Profile Block	
Root AVP	1 st Level	Value	Profile Block (Prefix Tree)	Value
1000	2000	"049772"	7000	"049772"
	2000	"644901"		"644901"
	2000	"0800500"		"0800500"

Timestamp

Introduction

The DCA interface on the SLC is able to record the time that the:

- Credit-Control-Request (CCR) was received (Time-In)
- Credit-Control-Answer (CCA) was ready to be assembled and sent (Time-Out)

This allows you to track processing time and, for example, identify bottle-necks.

You can map:

- The time a CCR was received into a configurable AVP in the CCA message
- The time a Credit-Control processing for a request was completed, into a configurable AVP in the CCA message

You can copy the timestamp from the incoming Diameter message to the outgoing Diameter message.

Timestamp example 1

This example copies a timestamp (the 3GPP eventtimestamp) from the incoming Diameter message to the outgoing Diameter message.

The data is copied through the profile tag 6291458; this is special cased to be copied from the incoming profile block to the outgoing one. It is an ARRAY tag, so that you can put whatever data you like in it.

```

{
  mappingTypes = ["InitialRequest", "InitialResponse", "UpdateRequest",
  "UpdateResponse"]
  avpFormat = "Grouped"
  extensionFormat = "encoded"
  encodedExtension = {
    profileTag = 6291458
    profileFormat = "ARRAY"
  }
  AVPs = [
    {
      AvpCodes = [
        {
          avpCode = 833
          vendorId = 10415
        }
        {
          avpCode = 6
          vendorId = 16247
          repeating = True
        }
      ]
      avpFormat = "Integer32"
      extensionFormat = "encoded"
      encodedExtension = {
        profileTag = 8192004
        profileFormat = "INTEGER"
      }
    }
  ]
}

```

Timestamp example 2

This example places a received timestamp in the outgoing message. This uses the same repeating AVP as the previous example, so it gets appended to the group.

```

{
  mappingTypes = [ "InitialResponse", "UpdateResponse" ]
  # Any Integer/Unsigned 32/64 or OctetString may be used.
  avpFormat = "Integer32"
  timestamp = "TIME_REQUEST_RECEIVED32"
  AvpCodes = [
    {
      avpCode = 833
      vendorId = 10415
    }
    {
      avpCode = 6
      vendorId = 16247
      repeating = True
    }
  ]
}

```

Note: See the *timestamp* (on page 72) parameter description for a list of values.

Timestamp example 3

This example places a replying timestamp in the outgoing message.

```

{
  mappingTypes = [ "InitialResponse", "UpdateResponse" ]

```

Chapter 4

```
avpFormat = "Integer64"  
timestamp = "TIME_NOW64"  
AvpCodes = [  
  {  
    avpCode = 833  
    vendorId = 10415  
  }  
  {  
    avpCode = 7  
    vendorId = 16247  
    repeating = True  
  }  
]  
}
```

Control Plans

Overview

Introduction

This chapter explains the example Control Plans that are shipped with Oracle Communications Convergent Charging Controller Diameter Control Agent.

These are sufficient to run simple Diameter services. There are:

- for event based services:
 - CHECK_BALANCE
 - DIRECT_DEBITING
 - PRICE_ENQUIRY
 - REFUND_ACCOUNT
- for session based services:
 - Without redirect
 - With redirect to top-up-server functionality
 - Screening

In this chapter

This chapter contains the following topics.

Check Balance	117
Direct Debiting	118
Price Enquiry	119
Refund Account	120
Session No Redirect	121
Session Redirect	122
Screening.....	124

Check Balance

Introduction

The Check Balance control plan determines if the user is able to reserve a specified number of units. It returns either a success or failure only; it does not return the number of units in the balance.

This control plan consists of a start node followed by two Named Event nodes and a terminate unchanged node, with Disconnect nodes as appropriate. The first Named Event node reserves an event type (the `Reserve Event` option selected), appropriate for this service. If the first Named Event node:

- Fails to reserve the event, it goes to a Disconnect node with the reason set to the configured no funds cause.
Successfully reserves the event, the second Named Event node cancels the reservation (the `Revoke Event` option selected). Then, a Terminate Unchanged node sends an INAP Continue, which signals to `diameterControlAgent` that the balance check succeeded.

Check Balance control plan

Here is an example Check Balance control plan.

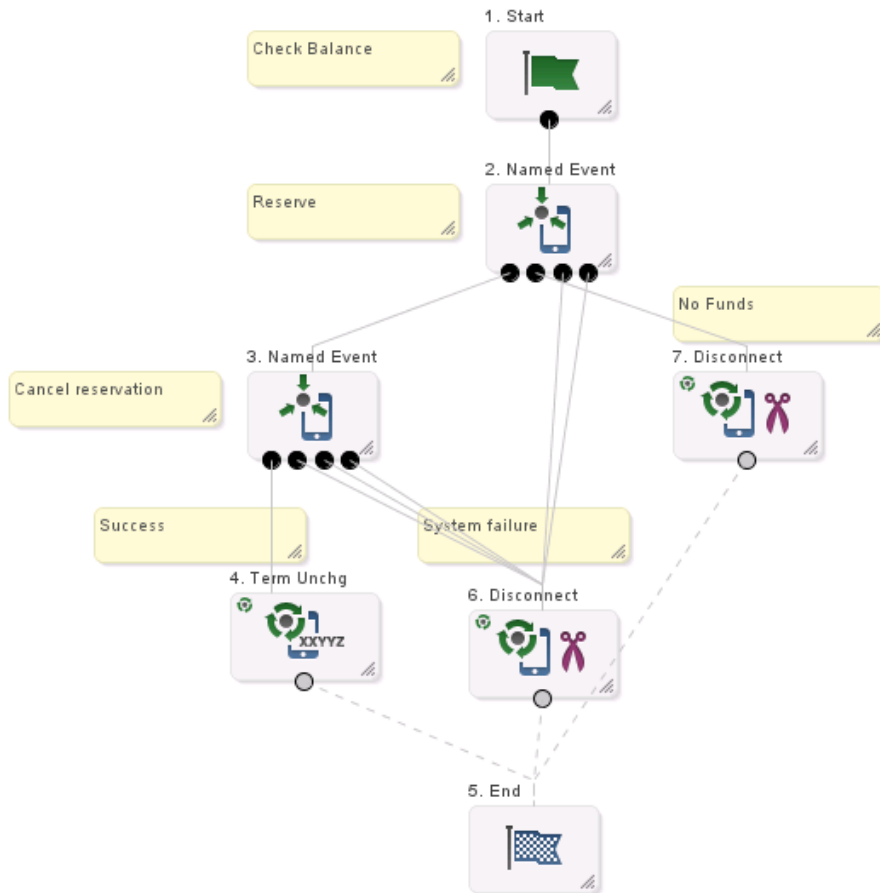

Direct Debiting

Introduction

This control plan starts with two profile branching nodes to determine if this is a time-based direct debit (through INAP extension 502) with an Event-Timestamp AVP (INAP extension 504).

- If it is, a DUCR node is used with the `Debit` option selected to debit the account.
- If it is not, a Named Event node is used with the `Direct Event` option selected to debit the account. The Named Event node reads its number of events from INAP extension 501 (Requested-Service-Units).

Failure branches are connected to Disconnect nodes with appropriate cause values to produce the correct Diameter Result-Code values.

Refer to *INAP Extensions* (on page 12) for details.

Direct Debiting control plan

Here is an example Direct Debiting control plan.

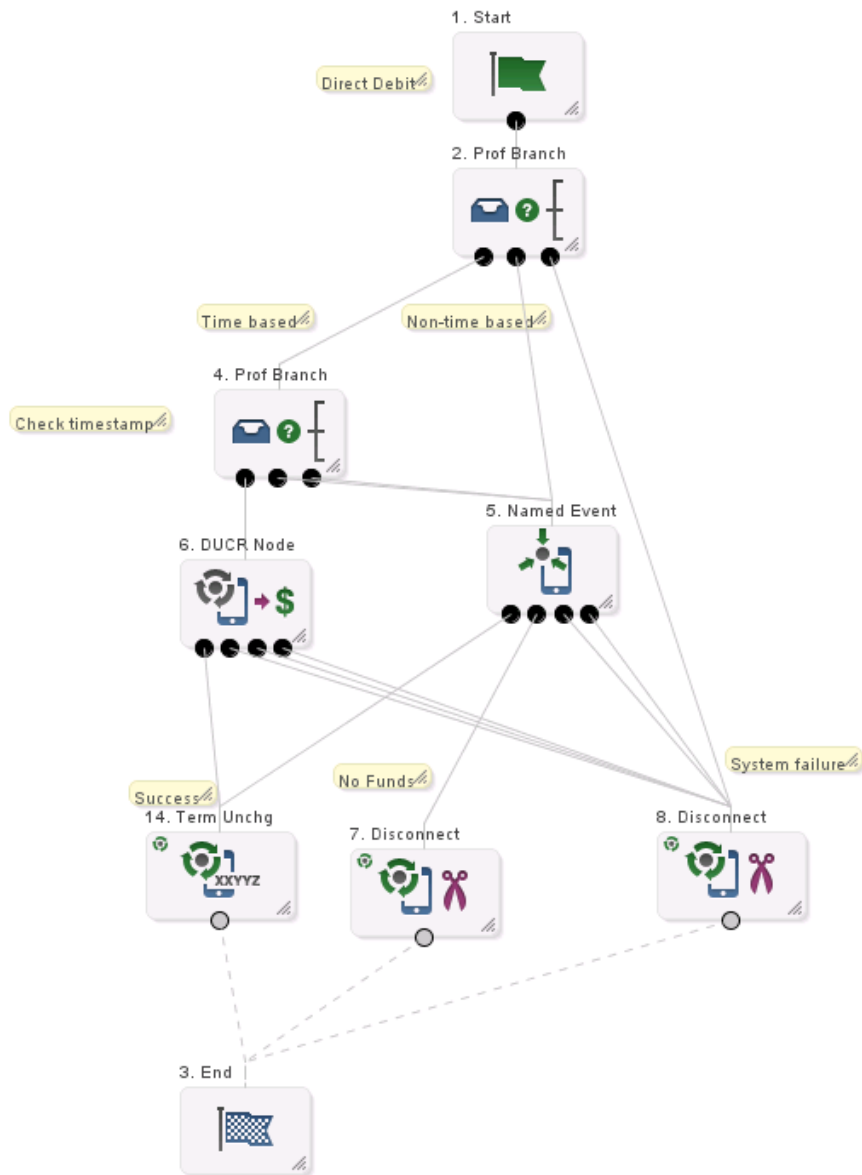

Price Enquiry

Introduction

This control plan has a Named Event node connected to:

- Disconnect nodes (for failures)
- An unconditional terminate node (for successes)

The Named Event node has the `Cost of event` option selected and is configured to store the cost of the event under a tag in the ACS temporary storage area. Then, the DCA service loader plug-in picks up this tag and puts it in INAP extension 603 in the Connect. The `diameterControlAgent` copies this into the Cost-information AVP.

Refer to *INAP Extensions* (on page 12) for details.

Price Enquiry control plan

Here is an example Price Enquiry control plan.

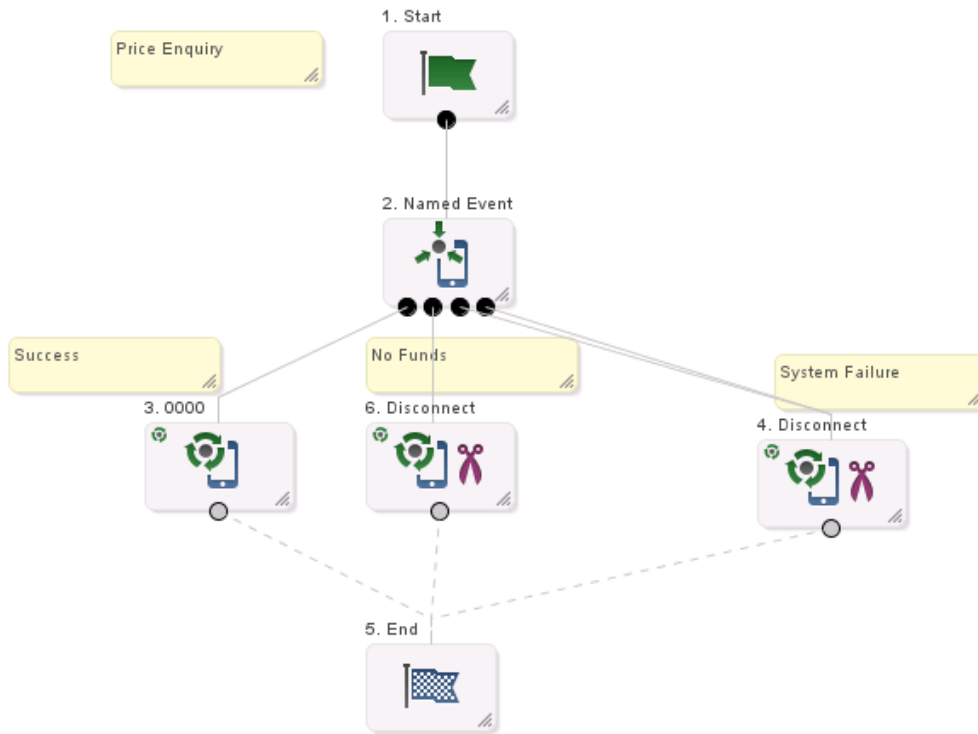

Refund Account

Introduction

The Refund Account control plan is identical to the *Direct Debiting* (on page 118) control plan, except, in the DUCR node, the **Credit** option is selected.

Refund Account control plan

Here is an example Refund Account control plan.

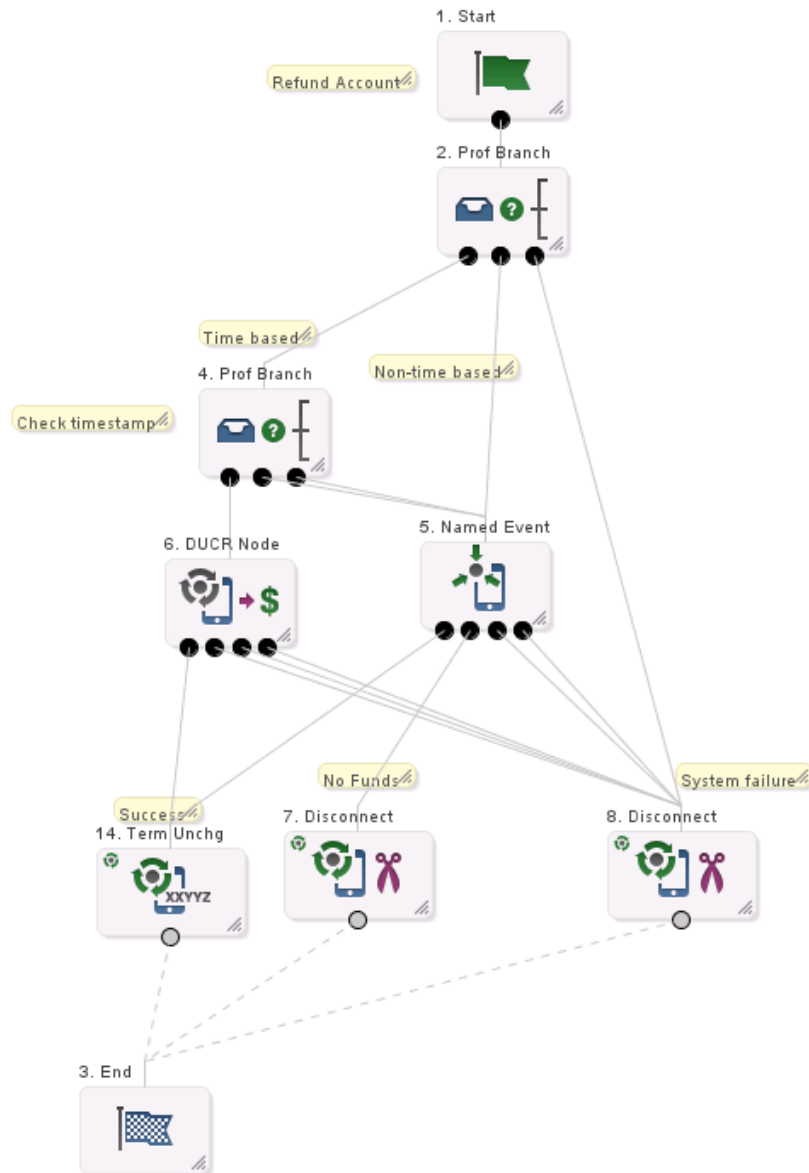

Session No Redirect

Introduction

The Session No Redirect control plan is a session based plan with no redirect to a top-up server.

This consists of a Start node connected to a UATB node. The exits of the UATB node are connected to an End node (Success cases) and to the Disconnect nodes with various release causes. The release causes in the Disconnect nodes are such as to cause diameterControlAgent to use the appropriate Result-Code.

Session No Redirect control plan

Here is an example Session No Redirect control plan.

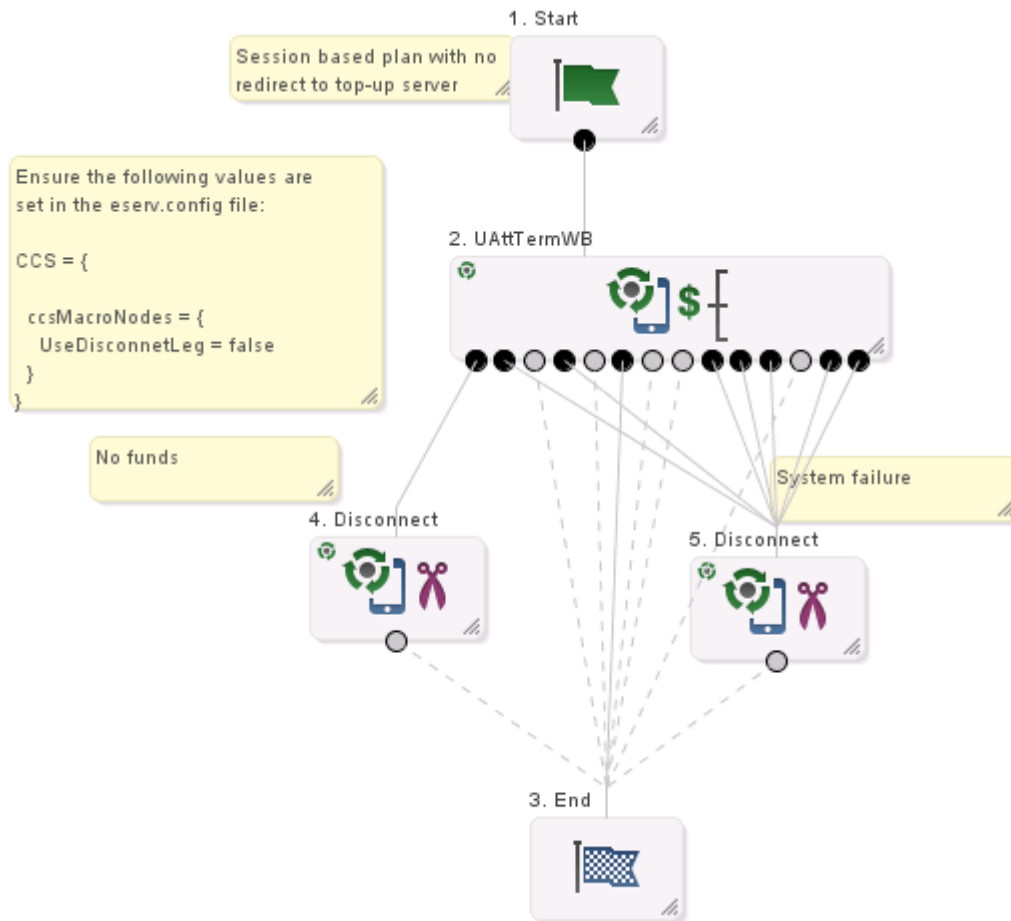

eserv.config configuration

As shown in the notes with this control plan, you need to ensure that the following values are set in the `CCS.ccsMacroNodes` section of the `eserv.config` file.

```
CCS = {
  ccsMacroNodes = {
    UseDisconnectLeg = false
  }
}
```

Refer to the *CCS Technical Guide* for details.

Session Redirect

Introduction

This is the same as the control plan for *Session No Redirect* (on page 121), except the following exits of the UATB node are connected to an unconditional termination node which will contain a number mapped to the address of the top-up-server:

- Declined No Funds

- NSF (Disconnected)

Session Redirect control plan

Here is an example Session Redirect control plan.

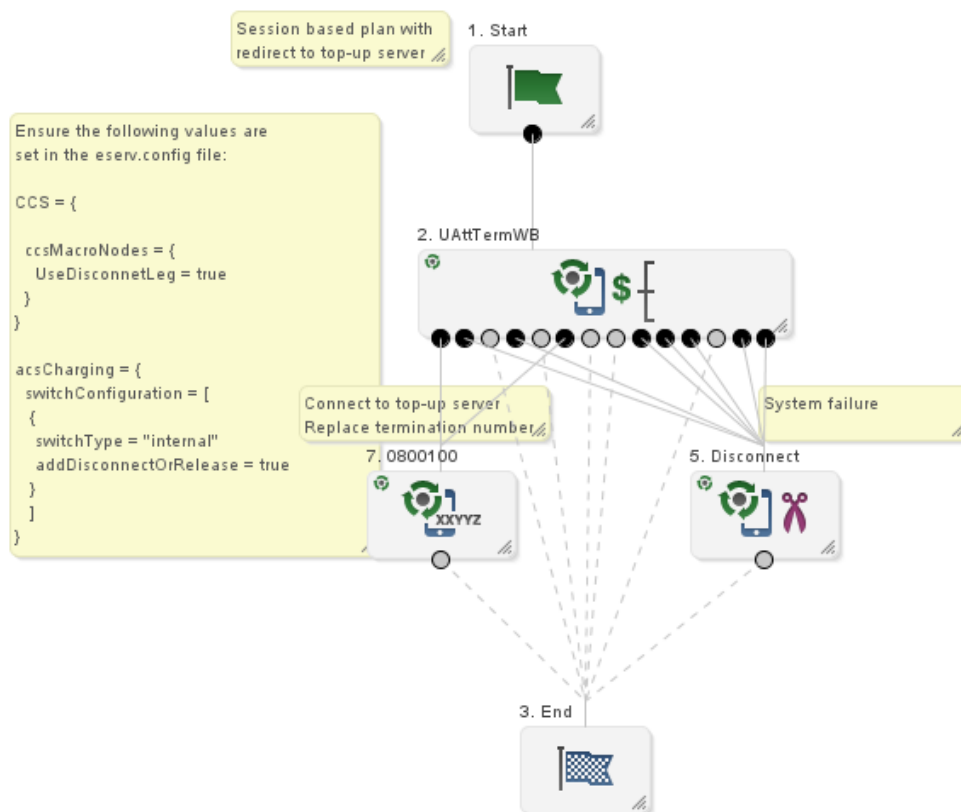

eserv.config configuration

As shown in the notes with this control plan, you need to ensure that the following values are set in the `CCS.ccsMacroNodes` section of the `eserv.config` file.

```

CCS = {
  ccsMacroNodes = {
    UseDisconnectLeg = true
  }
}

```

The switch configuration must also be set in the `acsCharging.switchConfiguration` section.

```

acsCharging = {
  switchConfiguration = [
    {
      switchType = "internal"
      addDisconnectOrRelease = true
    }
  ]
}

```

Refer to *CCS Technical Guide* for details.

Screening

Introduction

The Screening control plan denies service for voice but allows service for data, based on the bearer type received from DCA.

This consists of a Start node connected to a Transmission Type Branch node. The Transmission Type Branch node exits for voice (Exits 1 and 4) are connected to a Disconnect node with a release cause of 50. The exits for non-voice are connected to a Terminate Uncharged node.

Screening control plan

Here is an example Screening control plan.

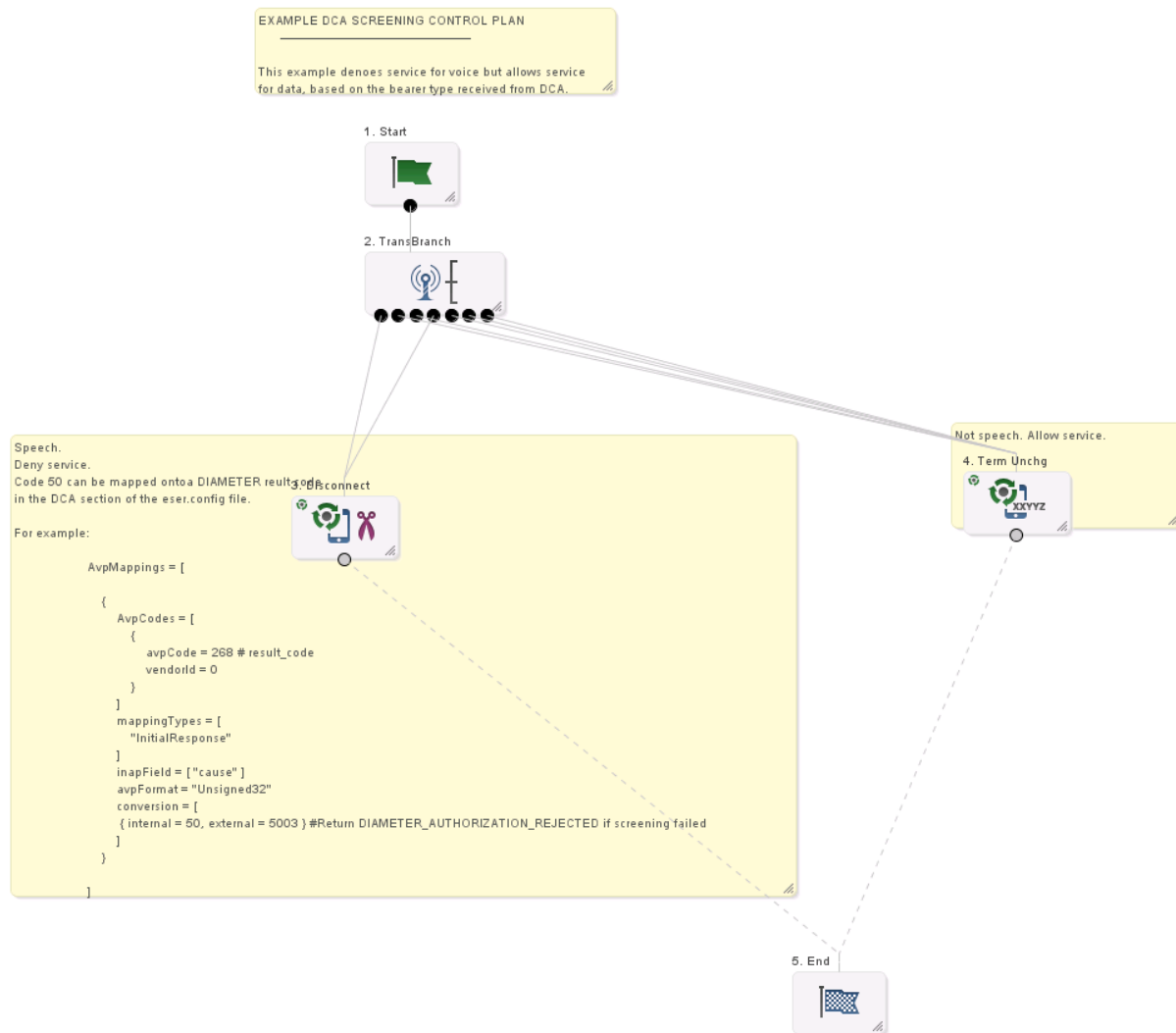

eserv.config configuration

As shown in the notes with this control plan, for this example, you need to ensure that the following values are set in the DIAMETER Services section of the eserv.config file.

```
AvpMappings = [
```

```
{
  AvpCodes = [
    {
      avpCode = 268 # result_code
      vendorId = 0
    }
  ]
  mappingTypes = [
    "InitialResponse"
  ]
  inapField = [ "cause" ]
  avpFormat = "Unsigned32"
  conversion = [
    { internal = 50, external = 5003 } #Return
    DIAMETER_AUTHORIZATION_REJECTED if screening failed
  ]
}
]
```

About Installation and Removal

Overview

Introduction

This chapter provides information about the installed components for the Oracle Communications Convergent Charging Controller application described in this guide. It also lists the files installed by the application that you can check for, to ensure that the application installed successfully.

In this Chapter

This chapter contains the following topics.

Installation and Removal Overview	127
Checking the Installation	127

Installation and Removal Overview

Introduction

For information about the following requirements and tasks, see *Installation Guide*:

- Convergent Charging Controller system requirements
- Pre-installation tasks
- Installing and removing Convergent Charging Controller packages

DCA packages

An installation of Diameter Control Agent includes the following packages, on the:

- SMS:
 - dcaSms
- SLC:
 - dcaScp

Checking the Installation

Introduction

Refer to these check lists to ensure the Diameter Control Agent has been installed correctly.

DCA Scp directories and files

The DCA installation on the SLC creates the following directories:

- `/IN/service_packages/DCA/bin`
- `/IN/service_packages/DCA/etc`

- `/IN/service_packages/DCA/lib`
- `/IN/service_packages/DCA/tmp`

The DCA installation installs the following binaries and interfaces:

- `/IN/services_packages/DCA/bin/diameterControlAgent`

The DCA installation installs the following example configuration file:

- `/IN/services_packages/eserv.config.dca.example`

The DCA installation installs the following shared library:

- `/IN/services_packages/DCA/lib/libdcaCcsSvcExtra.so`

DCA Sms directories

Check that the statistics and control plans have been installed correctly.

The DCA installation on the SMS creates the following directories:

- `/IN/service_packages/DCA/db`
- `/IN/service_packages/DCA/lib`

Diameter Charging Agent Call Flows

Call Flow Overview

Introduction

This chapter lists a sample set of DCA message flows.

In this chapter

This chapter contains the following topics.

Initial Request Success	129
Initial Request Release Call	130
Initial Request Multiple Requested Service Units.....	130
AVP Pass-Through DCA to DCD	132
Screening Successful	133
Screening Call Disallowed.....	134
Screening Failure	134
Update Request.....	135
Terminate Request	135

Initial Request Success

Introduction

This example shows the flow for a successful initial request.

Call flow

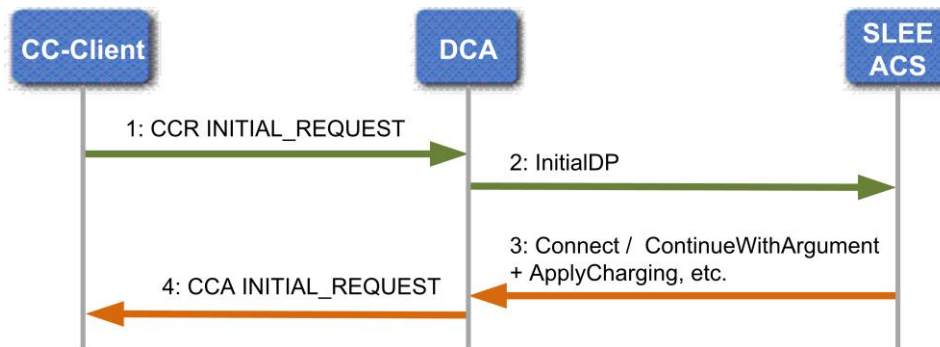

Comments

This table provides additional comments on the call flow.

Operation	Comment
2	This operation contains a profile block encoded in extension 701, consisting of data mapped from AVPs.

Operation	Comment
3	This operation contains a profile block encoded in extension 701, consisting of data mapped to AVPs.

Initial Request Release Call

Introduction

This example shows the flow for a release call.

Call flow

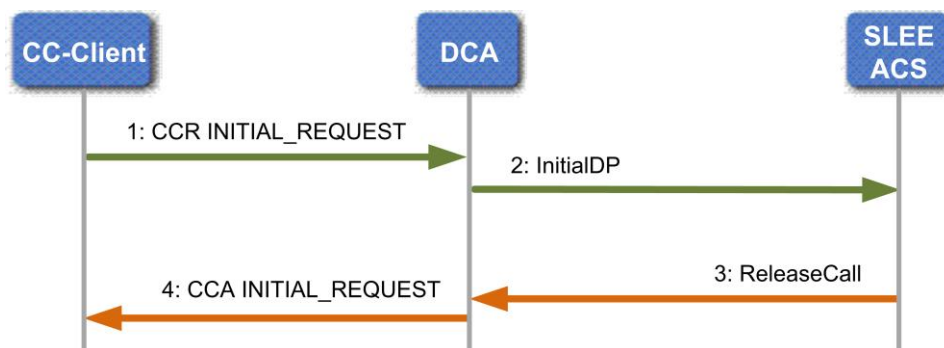

Comments

This table provides additional comments on the call flow.

Operation	Comment
2	This operation contains a profile block encoded in extension 701, consisting of data mapped from AVPs.
3	This operation contains a profile block encoded in extension 701, consisting of data mapped to AVPs.

Initial Request Multiple Requested Service Units

Introduction

This example shows the flow when multiple requests for service units (cash or time) are made.

Call flow

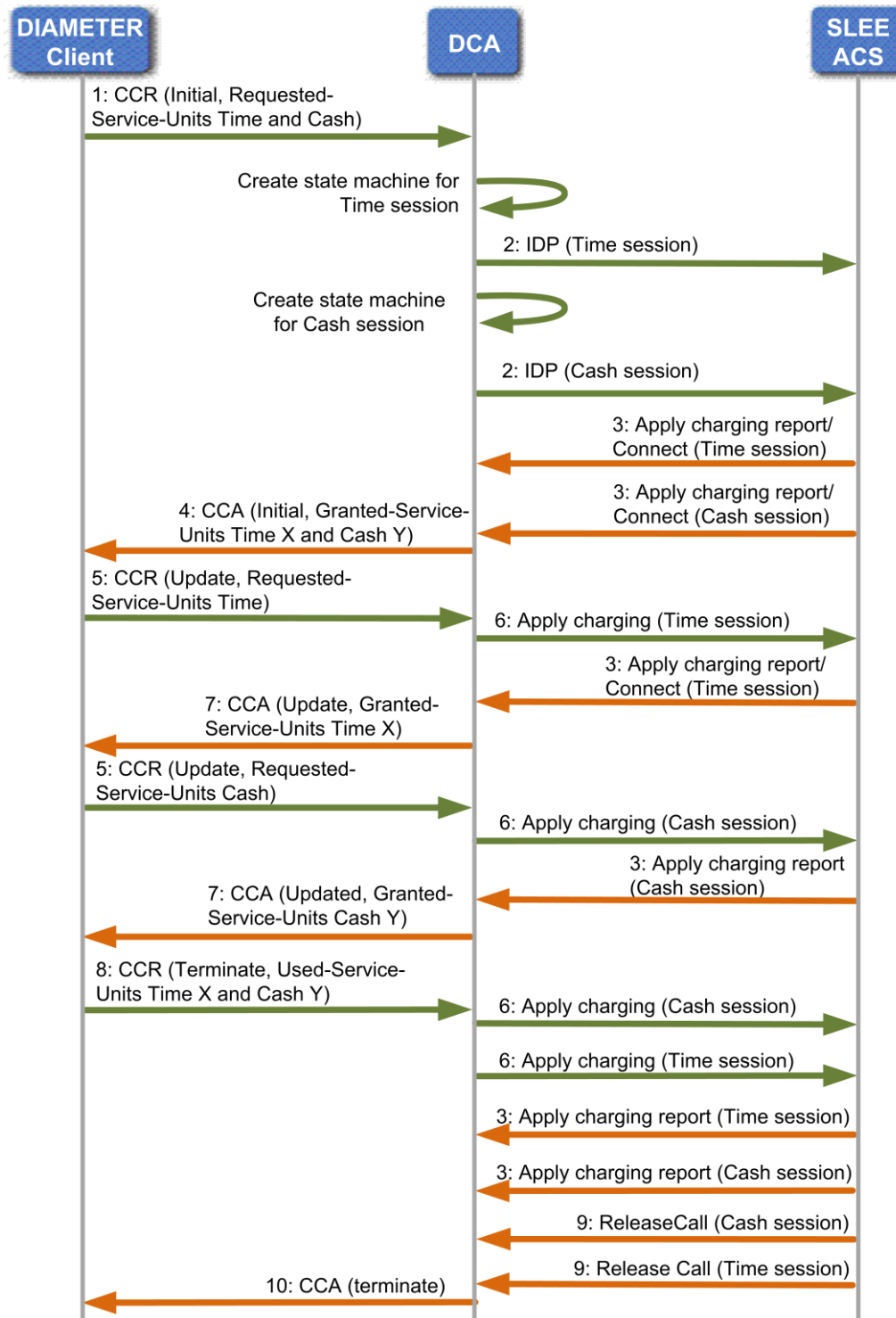

AVP Pass-Through DCA to DCD

Introduction

This example shows the flow when a simple pass through from DCA to DCD is made.

DCA Parameters

A large part of configuration for DCA are AVP to profile block definitions.

The following configuration is required to allow an AVP received by DCA from a CC-Client to be passed through to DCD.

- ACS is configured with an Inbound ARRAY-type profile tag, which is used to pass a repeating AVP to ACS.

Note: This may not be necessary if data is not going to be manipulated in a Control Plan, however this would risk having data corrupted if the chosen tag number already exists, and is used in the Control Plan.

- DCA is configured with an inbound mapping from a repeating AVP in a single grouped AVP to an ARRAY-type profile.
- DCD is configured with an outbound mapping from an ARRAY profile tag in the INCOMING_EXTENSIONS profile block.

The following configuration is required to allow an AVP received from a CC-Server by DCD to be passed through to DCA.

- ACS is configured with an Outbound ARRAY-type profile tag, which is used to pass data from ACS to DCA in the OUTGOING_EXTENSIONS profile block.

Note: This may not be necessary if data is not going to be manipulated in a Control Plan, however this would risk having data corrupted if the chosen tag number already exists, and is used in the control Plan.

- DCD is configured with an inbound mapping to map a repeating AVP in a single grouped AVP to an ARRAY profile in the OUTGOING_EXTENSIONS profile block.
- DCA is configured with an outbound mapping to map an ARRAY profile tag to an AVP.

Call flow

This diagram shows the flow.

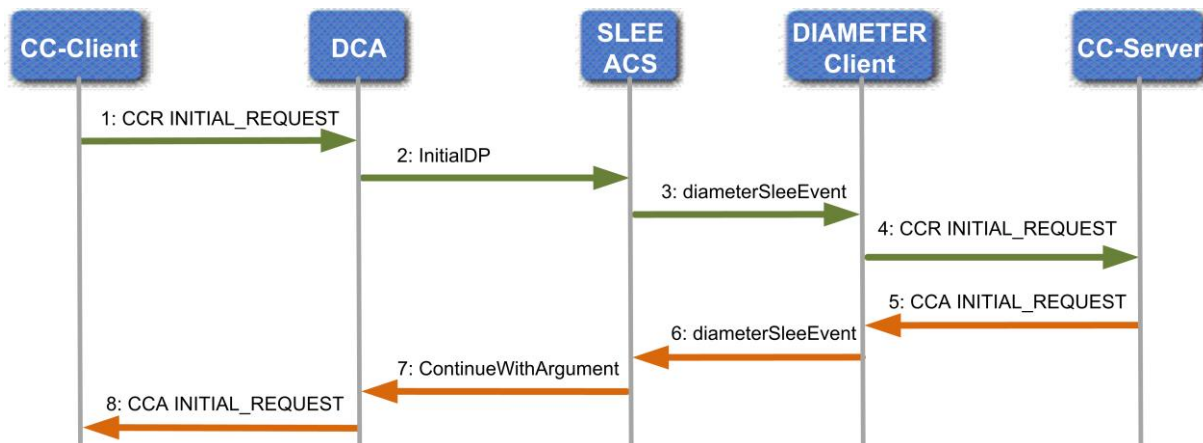

Comments

This table provides additional comments on the call flow.

Operation	Comment
1	CC-Client sends a CCR INITIAL_REQUEST to DCA.
2	DCA sends an InitialDP to ACS containing an ARRAY profile tag in the profile block encoded in the generic_extension_val_extended_os extension (id: 701), in the extensions argument.
3	Upon receipt of the operation, ACS copies the profile tags specified in the generic_extension_val_extended_os into the INCOMING_EXTENSIONS profile block. <ul style="list-style-type: none"> The INCOMING_EXTENSIONS profile block is stored in tsMap->incomingExtensionsBlock in acsChassisContext. In the case of an IDP, the whole generic_extension_val_extended_os extension buffer is re-assigned to tsMap->incomingExtensionsBlock; for an ACR, each profile tag in the extension is individually applied to tsMap->incomingExtensionsBlock.
4	A billing node in the invoked Control Plan results in the DCD actions library being invoked.
5	The DCD actions library: <ul style="list-style-type: none"> encodes the ARRAY profile tag found in the INCOMING_EXTENSIONS profile block as an AVP sends a request in a DiameterSleeEvent to the DCD diameterBeClient.
6	The diameterBeClient sends the CCR request to the CC-Server.
7	CC-Server send a CCA INITIAL_REQUEST.
8	The diameterBeClient sends the response encoded in a DiameterSleeEvent back to ACS

Screening Successful

Call flow

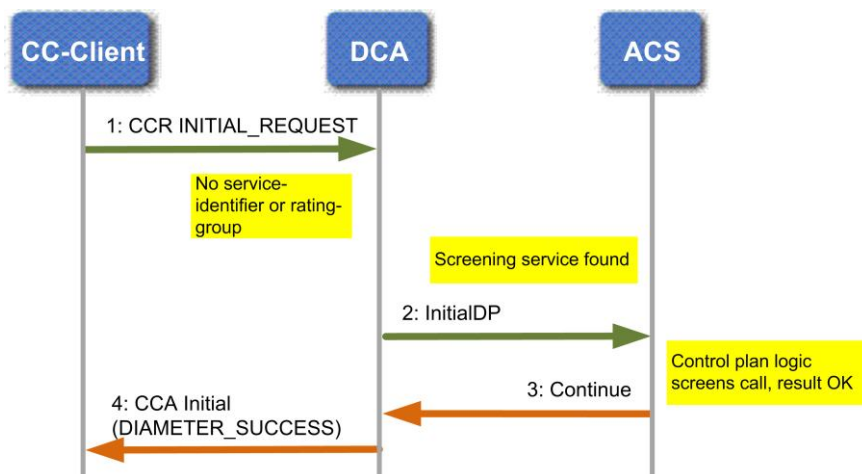

Screening Call Disallowed

Call flow

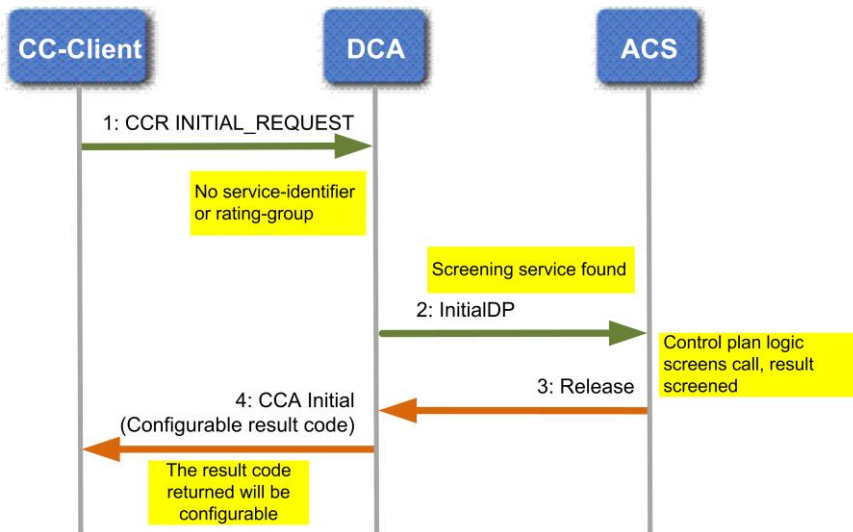

Screening Failure

Call flow

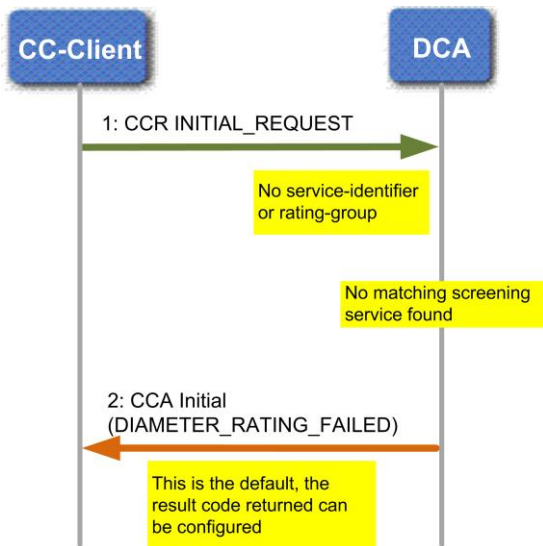

Comments

The call flow shows DIAMETER_RATING_FAILED being returned. This is the default, however the actual returned Result-Code is configurable.

Update Request

Call flow

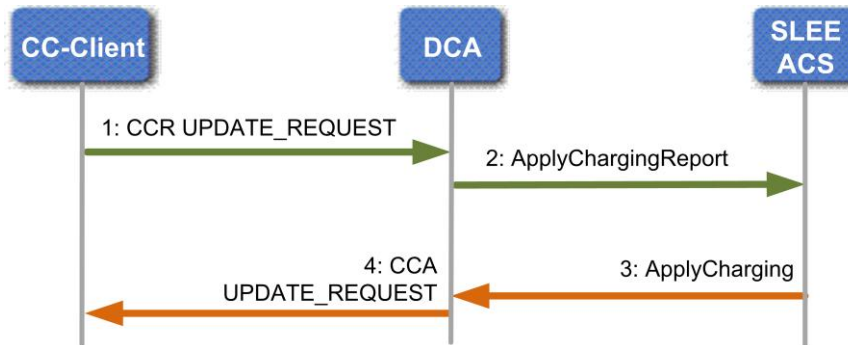

Comments

This table provides additional comments on the call flow.

Operation	Comment
2	This operation contains a profile block encoded in extension 701, consisting of data mapped from AVPs.
3	This operation contains a profile block encoded in extension 701, consisting of data mapped to AVPs.

Terminate Request

Call flow

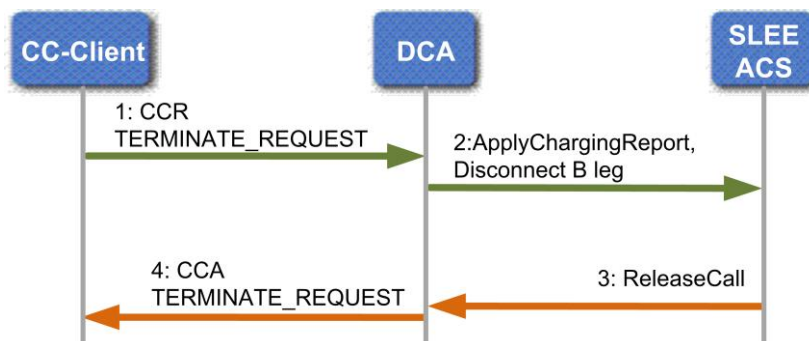

Comments

This table provides additional comments on the call flow.

Operation	Comment
2	This operation contains a profile block encoded in extension 701, consisting of data mapped from AVPs.
3	This operation contains a profile block encoded in extension 701, consisting of data mapped to AVPs.

Glossary of Terms

AAA

Authentication, Authorization, and Accounting. Specified in Diameter RFC 3588.

ACS

Advanced Control Services configuration platform.

AVP

Attribute Value Pair, used in Diameter to represent properties of a particular request or answer.

Call Flow

The path that a caller into the system takes to perform various functions. Often represented diagrammatically as a flowchart or tree-like structure. This shows prompts that the user will hear, with decision points or menus represented by call states.

CAMEL

Customized Applications for Mobile network Enhanced Logic

This is a 3GPP (Third Generation Partnership Project) initiative to extend traditional IN services found in fixed networks into mobile networks. The architecture is similar to that of traditional IN, in that the control functions and switching functions are remote. Unlike the fixed IN environment, in mobile networks the subscriber may roam into another PLMN (Public Land Mobile Network), consequently the controlling function must interact with a switching function in a foreign network. CAMEL specifies the agreed information flows that may be passed between these networks.

CAP

CAMEL Application Part

CC

Country Code. Prefix identifying the country for a numeric international address.

CCA

Credit-Control-Answer, used in Diameter by the credit-control server to acknowledge a Credit-Control-Request (CCR) from the credit-control client.

CCR

Credit-Control-Request, used in Diameter by the credit-control client to request credit authorization from the credit-control server.

CCS

- 1) Charging Control Services component.
- 2) Common Channel Signalling. A signalling system used in telephone networks that separates signalling information from user data.

Convergent

Also “convergent billing”. Describes the scenario where post-paid and pre-paid calls are handed by the same service platform and the same billing system. Under strict converged billing, post-paid subscribers are essentially treated as “limited credit pre-paid”.

Diameter

A feature rich AAA protocol. Utilises SCTP and TCP transports.

DP

Detection Point

DTMF

Dual Tone Multi-Frequency - system used by touch tone telephones where one high and one low frequency, or tone, is assigned to each touch tone button on the phone.

FDA

First Delivery Attempt - the delivery of a short message directly to the SME rather than relaying it through the MC.

GPRS

General Packet Radio Service - employed to connect mobile cellular users to PDN (Public Data Network- for example the Internet).

GSM

Global System for Mobile communication.

It is a second generation cellular telecommunication system. Unlike first generation systems, GSM is digital and thus introduced greater enhancements such as security, capacity, quality and the ability to support integrated services.

HLR

The Home Location Register is a database within the HPLMN (Home Public Land Mobile Network). It provides routing information for MT calls and SMS. It is also responsible for the maintenance of user subscription information. This is distributed to the relevant VLR, or SGSN (Serving GPRS Support Node) through the attach process and mobility management procedures such as Location Area and Routing Area updates.

HPLMN

Home PLMN

IDP

INAP message: Initial DP (Initial Detection Point)

IMS

IP Multimedia Subsystem (3GPP) enables the use of multimedia services based on and built upon Internet applications, services and protocols. These protocols include SIP, which is used to manage the IP multimedia sessions.

IMSI

International Mobile Subscriber Identifier. A unique identifier allocated to each mobile subscriber in a GSM and UMTS network. It consists of a MCC (Mobile Country Code), a MNC (Mobile Network Code) and a MSIN (Mobile Station Identification Number).

The IMSI is returned by the HLR query (SRI-SM) when doing FDA. This tells the MSC exactly who the subscriber is that the message is to be sent to.

IN

Intelligent Network

INAP

Intelligent Network Application Part - a protocol offering real time communication between IN elements.

Initial DP

Initial Detection Point - INAP Operation. This is the operation that is sent when the switch reaches a trigger detection point.

IP

1) Internet Protocol

2) Intelligent Peripheral - This is a node in an Intelligent Network containing a Specialized Resource Function (SRF).

IP address

Internet Protocol Address - network address of a card on a computer.

ISDN

Integrated Services Digital Network - set of protocols for connecting ISDN stations.

ITU

International Telecommunication Union

LAC

Location Area Code. This is an integer value specified as the third level of detail in the location area information. One LAC contains multiple Cell IDs or SAs.

MC

Message Centre. Also known as SMSC.

MCC

Mobile Country Code. In the location information context, this is padded to three digits with leading zeros. Refer to ITU E.212 ("Land Mobile Numbering Plan") documentation for a list of codes.

MNC

Mobile Network Code. The part of an international address following the mobile country code (MCC), or at the start of a national format address. This specifies the mobile network code, that is, the operator owning the address. In the location information context, this is padded to two digits with a leading zero. Refer to ITU E.212 ("Land Mobile Numbering Plan") documentation for a list of codes.

MS

Mobile Station

MSC

Mobile Switching Centre. Also known as a switch.

MSIN

Mobile Station Identification Number.

MSISDN

Mobile Station ISDN number. Uniquely defines the mobile station as an ISDN terminal. It consists of three parts; the country code (CC), the national destination code (NDC) and the subscriber number (SN).

MT

Mobile Terminated

NOA

Nature Of Address - a classification to determine in what realm (Local, National or International) a given phone number resides, for the purposes of routing and billing.

PLMN

Public Land Mobile Network

RAA

Session message: Re-Auth Answer

RADIUS

Remote Authentication Dial-In User Service - a system of distributed security that secures remote access to networks and network services against unauthorised access.

RAR

Session message: Re-Auth Request

SCF

Service Control Function - this is the application of service logic to control functional entities in providing Intelligent Network services.

SCTP

Stream Control Transmission Protocol. A transport-layer protocol analogous to the TCP or User Datagram Protocol (UDP). SCTP provides some similar services as TCP (reliable, in-sequence transport of messages with congestion control) but adds high availability.

Session

Diameter exchange relating to a particular user or subscriber access to a provided service (for example, a telephone call).

SGSN

Serving GPRS Support Node

SIP

Session Initiation Protocol - a signaling protocol for Internet conferencing, telephony, event notification and instant messaging. (IETF)

SLC

Service Logic Controller (formerly UAS).

SLEE

Service Logic Execution Environment

SME

Short Message Entity - This is an entity which may send or receive short messages. It may be located in a fixed network, a mobile, or an SMSC.

SMS

Depending on context, can be:

- Service Management System hardware platform
- Short Message Service
- Service Management System platform
- Convergent Charging Controller Service Management System application

SN

Service Number

SRF

Specialized Resource Function – This is a node on an IN which can connect to both the SSP and the SLC and delivers additional special resources into the call, mostly related to voice data, for example play voice announcements or collect DTMF tones from the user. Can be present on an SSP or an Intelligent Peripheral (IP).

SRI

Send Routing Information - This process is used on a GSM network to interrogate the HLR for subscriber routing information.

SSP

Service Switching Point

TCP

Transmission Control Protocol. This is a reliable octet streaming protocol used by the majority of applications on the Internet. It provides a connection-oriented, full-duplex, point to point service between hosts.

URI

Uniform Resource Identifier.

URL

Uniform Resource Locator. A standard way of specifying the location of an object, typically a web page, on the Internet.

VLR

Visitor Location Register - contains all subscriber data required for call handling and mobility management for mobile subscribers currently located in the area controlled by the VLR.

VWS

Oracle Voucher and Wallet Server (formerly UBE).

Index

A

- AAA • 137
- About Installation and Removal • 127
- About This Document • v
- Acct-Application-Id • 48
- ACS • 137
- acs.conf Configuration • 6, 9, 14
- allowDefaultRatingGroup • 36
- allowMultiServiceIdentifier • 49
- Array with Conditions • 73, 81, 89
- Array with Conditions - inbound - example 1 • 91, 106
- Array with Conditions - Inbound - example 2 • 92
- Array with Conditions - outbound - example 1 • 94
- Array with Conditions - outbound - example 2 • 95
- Array with Conditions - outbound - example 3 • 96
- Array with Conditions - outbound - example 4 • 98
- Array with Conditions configuration • 89
- Array with Context • 66, 81, 99
- Array with Context - inbound example • 101
- Array with Context - outbound example 1 • 102, 104
- Array with Context - outbound example 2 • 104
- Array with Context configuration • 99
- Audience • v
- Auth-Application-Id • 49
- AVP • 137
- AVP Casting • 28
- AVP Format to Extension Type • 28
- AVP Pass-Through DCA to DCD • 132
- avpCode • 29
- AvpCodes • 29, 59
- avpFormat • 30
- avpMappings • 25, 60
- AvpMappings Parameters • 25, 28, 66
- avpType • 60
- avpValue • 60

B

- Background Processes • 23
- Base example • 81
- Basic Array • 81, 83
- Basic Array configuration • 84
- Business Scenarios • 18

C

- Call flow • 129, 130, 131, 132, 133, 134, 135
- Call Flow • 137
- Call Flow Overview • 129

- CAMEL • 137
- CAP • 137
- CC • 137
- CCA • 16, 137
- ccDuplicateStoreSize • 36
- CCR • 14, 137
- CCS • 137
- CCS Service Library configuration • 5, 7, 9
- chargeOnSessionTimeout • 49
- Check Balance • 117
- Check Balance control plan • 118
- Check balance, with a result of enough credit • 17, 20
- Checking the Installation • 127
- Comments • 129, 130, 133, 134, 135
- commitGrantedOnSessionTimeout • 50
- commitGrantedOnTerminate • 50
- Conditional AVP • 73, 81, 104
- Conditional AVP - inbound example 1 • 106, 108
- Conditional AVP - outbound example 1 • 109
- Conditional AVP - outbound example 2 • 110
- Conditional AVP configuration • 105
- Conditional AVP example 1 • 107
- Conditional AVP example 3 • 108
- Configuration • 5
- Configuration Components • 5
- Configuration File Format • 6
- Configuration Overview • 5
- Connection • 14
- connectionTimeout • 50
- contextAVP • 66
- Control Plans • 9, 12, 117
- Convergent • 138
- conversion • 30
- conversionFactor • 61
- Copyright • ii
- counterLogInterval • 51
- customDefaultUnits • 36

D

- DCA Components • 3
- DCA packages • 127
- DCA Parameters • 132
- DCA Scp directories and files • 127
- DCA SLEE Configuration • 7
- DCA Sms directories • 128
- DCA statistics • 78
- DCADefaults Configuration Section • 24
- DCADefaults Parameters • 25
- DCAInstances Configuration Section • 34
- DCAInstances configuration structure • 34
- DCAInstances Parameters • 8, 34, 35
- destAddress • 46
- destination • 45
- destinationAddressAvp • 47
- Diagram • 3

- Diameter • 138
- Diameter Charging Agent Call Flows • 129
- DIAMETER Configuration Structure • 23
- Diameter eserv.config Configuration • 7
- diameterControlAgent Process • 7, 23
- DiameterServer Parameters • 34, 48, 76
- Direct Debiting • 118, 120
- Direct Debiting control plan • 119
- Document Conventions • vi
- dontDiscardRatingGroupInResponse • 37
- DP • 138
- DTMF • 138
- dummyDestination • 37
- duplicateBytes • 51
- duplicateTime • 51

E

- Editing the File • 7
- enabled • 47
- Enabling Named Events • 10
- encodedExtension • 31, 67
- eserv.config configuration • 122, 123, 124
- eserv.config Configuration • 5, 6
- eserv.config Files Delivered • 7
- Example Basic Array configuration • 85
- Example DCADefaults Configuration in eserv.config File • 24
- Example DiameterServer Configuration • 48
- Example Key Arrays configuration • 87
- Example nested format • 82
- Example NumberRules configuration • 43
- Example PeerSchemes section • 76
- Example RedirectNumberMappings configuration • 45
- Example report • 79
- Example Tracing configuration • 46
- excludelfMatches • 67
- extensionFormat • 31, 67
- extensionType • 31
- external • 31

F

- Failure • 24
- FDA • 138
- Feature Node Configuration • 11
- Features • 1
- finalGrantUnused • 51
- fromNoa • 43
- Funds expiry, redirect, top-up and reconnect • 17, 21

G

- ggsnSupportsFinalUnitIndication • 37
- GPRS • 138
- gracefulTerminationValidityTime • 25, 61
- GSM • 138

H

- HLR • 138
- HPLMN • 138

I

- IDP • 13, 138
- ignoreRSU • 37
- IMS • 138
- IMSI • 139
- IN • 139
- INAP • 139
- INAP Extension • 9
- INAP Extensions • 12, 118, 120
- inapField • 67
- inapServiceKey • 26, 61
- inBufferSize • 51
- includelfMatches • 68
- Initial DP • 139
- Initial Request Multiple Requested Service Units • 130
- Initial Request Release Call • 130
- Initial Request Success • 129
- Installation and Removal Overview • 127
- instanceName • 38
- internal • 31
- Introduction • 1, 5, 6, 7, 9, 12, 14, 18, 34, 58, 78, 81, 83, 86, 89, 99, 104, 112, 114, 117, 118, 119, 120, 121, 122, 124, 127, 129, 130, 132
- invalidMessageSequenceResultCode • 26, 38
- IP • 139
- IP address • 139
- isChargingKey • 62
- ISDN • 139
- itc • 26, 62
- ITU • 139

K

- Key Array • 68, 81, 86
- Key Arrays configuration • 86
- keyArray • 68

L

- LAC • 139
- literal • 69
- Loading eserv.config Changes • 7
- localOriginHost • 54
- localOriginRealm • 54

M

- mandatory • 32
- Mapping • 73, 85, 89, 92, 94, 95, 96, 98, 99, 102, 104, 114
- Mapping categories • 70, 71
- Mapping example 1 • 107

- Mapping example 1 - conditional - outbound • 110
- Mapping example 2 • 108
- Mapping example 2 - conditional - outbound • 112
- Mapping example 3 • 108
- mappingTypes • 26, 27, 70
- max • 43
- maxAnswerReorder • 38
- maxSessionLengthAfterFinalUnitIndicationsSeconds • 27
- MC • 139
- MCC • 139
- min • 44
- MNC • 140
- MS • 140
- MSC • 140
- MSIN • 140
- MSISDN • 140
- MT • 140
- Multimedia messaging direct debit scenario • 20
- Multiple services credit control scenario • 22
- multipleServicesRatingGroup • 38

N

- name • 75
- Named Event Node • 11
- Nested format • 82
- netmask6Bits • 75
- netmaskBits • 75
- noa • 32
- NOA • 140
- NumberRules Parameters • 34, 43

O

- octetsLength • 71
- octetsStart • 71
- origAddress • 47
- originHostMustBeFQDN • 39
- outBufferSize • 54
- overLimitError • 52
- Overview • 1, 5, 23, 81, 117, 127

P

- Parameter Mappings • 14
- Peer host parameters • 74
- PeerSchemes Configuration Section • 73
- PeerSchemes configuration structure • 73
- PeerSchemes parameters • 74
- percentTimeQuotaThreshold • 54
- percentVolumeQuotaThreshold • 55
- Per-Message Type AVP Mapping • 2, 4
- permittedInstances • 75
- permittedOriginHosts • 75
- PLMN • 140
- prefix • 44, 45
- Prefix Tree • 81, 112

- Prefix Tree configuration • 112
- Prefix Tree example • 113
- Prepaid Charging Configuration • 9
- prepend • 44
- Prerequisites • v
- Price enquiry • 20
- Price Enquiry • 119
- Price Enquiry control plan • 120
- productName • 55
- profileFormat • 28, 69
- profileTag • 70
- protocol • 52, 75
- Purpose • 23

R

- RAA • 140
- RADIUS • 140
- RAR • 140
- RAR Configuration • 8
- rarClientTimeout • 39
- rarHandlingEnabled • 39
- rarMaxRetry • 39
- ratingGroup • 63
- RedirectNumberMappings Parameters • 34, 45
- Refund Account • 120
- Refund Account control plan • 121
- Related Documents • v
- RemoteAddresses • 76
- remove • 44
- repeating • 72, 84
- Reports • 79
- reqSctpInboundStreams • 76
- reqSctpOutboundStreams • 76
- requestedAction • 63
- resultNoa • 45
- returnServiceResultCodeInRoot • 40
- roundingDetail • 40
- roundingThreshold • 40

S

- SCF • 140
- scheme • 40
- schemeName • 74
- Scope • v
- Screening • 4, 124
- Screening Call Disallowed • 134
- Screening control plan • 124
- Screening Failure • 134
- Screening Successful • 133
- screeningService • 4, 63
- SCTP • 141
- sctpBindAddress • 52
- sctpListenPort • 53
- SelectionAVPs • 60, 63
- selectionAVPsIsChargingKey • 64
- sendAbortOnSessionTimeout • 55
- sendCreditLimitReachedOnSessionEnd • 55

- sendOriginStateId • 56
- sendQuotaThreshold • 56
- Service Specific AVP Mappings • 30, 34, 59, 60, 81
- Service Specific AVP Mappings parameters • 66
- serviceContextId • 64
- serviceIdentifier • 64
- SERVICEKEY • 8
- serviceName • 65
- Services Configuration • 34, 58
- Services configuration structure • 58, 81
- Services parameters • 59
- Session • 141
- Session No Redirect • 121, 122
- Session No Redirect control plan • 122
- Session Redirect • 122
- Session Redirect control plan • 123
- sessionBasedDuplicateDetection • 41
- sessionFallbackTcc • 56
- sessionLimit • 53
- SGSN • 141
- Simple conditional • 82, 106
- SIP • 141
- SIPDomain • 41
- SIPPrefix • 41
- sipScheme • 32
- sipScheme example configurations • 33
- SLC • 141
- SLEE • 141
- SLEE.cfg Configuration • 5, 7, 23, 38
- sleeServiceKey • 27, 65
- sleeTimeout • 65
- SME • 141
- SMS • 141
- SN • 141
- SRF • 141
- SRI • 141
- SSP • 142
- Startup • 23
- Statistics Logged by diameterControlAgent • 78
- SubscriptionIdTypes • 41
- Successful session-based charging, client terminates session • 19
- Supported-Vendor-Id • 56
- System Overview • 1
- systemCurrencyCode • 42
- systemCurrencyExponent • 42
- systemErrorResultCode • 27, 42

T

- tcc • 27, 65
- TCP • 142
- tcpBindAddress • 53
- tcpListenPort • 53
- Terminate Request • 135
- thirtyTwoBitQuotaThresholds • 57

- throttleInterval • 54
- throttleLimitError • 52
- throttleThreshold • 53
- timestamp • 72, 115
- Timestamp • 72, 81, 114
- Timestamp example 1 • 114
- Timestamp example 2 • 115
- Timestamp example 3 • 115
- traceDebugLevel • 47
- Tracing Parameters • 34, 46
- type • 45
- typeCriteria • 60, 67, 68, 73, 82
- Typographical Conventions • vi

U

- unitType • 66
- Update Request • 135
- URI • 142
- URL • 142

V

- validityTime • 28, 66
- vendorId • 34, 57
- Vendor-Specific-Application-Identifier • 57
- VLR • 142
- VWS • 142

W

- watchdogPeriod • 58
- What is Diameter Control Agent? • 1