

Oracle® Communications
Network Charging and Control

CAP3 GPRS Control Agent Technical Guide

Release 12.0.0

December 2017

Copyright

Copyright © 2017, Oracle and/or its affiliates. All rights reserved.

This software and related documentation are provided under a license agreement containing restrictions on use and disclosure and are protected by intellectual property laws. Except as expressly permitted in your license agreement or allowed by law, you may not use, copy, reproduce, translate, broadcast, modify, license, transmit, distribute, exhibit, perform, publish, or display any part, in any form, or by any means. Reverse engineering, disassembly, or decompilation of this software, unless required by law for interoperability, is prohibited.

The information contained herein is subject to change without notice and is not warranted to be error-free. If you find any errors, please report them to us in writing.

If this is software or related documentation that is delivered to the U.S. Government or anyone licensing it on behalf of the U.S. Government, then the following notice is applicable:

U.S. GOVERNMENT END USERS: Oracle programs, including any operating system, integrated software, any programs installed on the hardware, and/or documentation, delivered to U.S. Government end users are "commercial computer software" pursuant to the applicable Federal Acquisition Regulation and agency-specific supplemental regulations. As such, use, duplication, disclosure, modification, and adaptation of the programs, including any operating system, integrated software, any programs installed on the hardware, and/or documentation, shall be subject to license terms and license restrictions applicable to the programs. No other rights are granted to the U.S. Government.

This software or hardware is developed for general use in a variety of information management applications. It is not developed or intended for use in any inherently dangerous applications, including applications that may create a risk of personal injury. If you use this software or hardware in dangerous applications, then you shall be responsible to take all appropriate fail-safe, backup, redundancy, and other measures to ensure its safe use. Oracle Corporation and its affiliates disclaim any liability for any damages caused by use of this software or hardware in dangerous applications.

Oracle and Java are registered trademarks of Oracle and/or its affiliates. Other names may be trademarks of their respective owners.

Intel and Intel Xeon are trademarks or registered trademarks of Intel Corporation. All SPARC trademarks are used under license and are trademarks or registered trademarks of SPARC International, Inc. AMD, Opteron, the AMD logo, and the AMD Opteron logo are trademarks or registered trademarks of Advanced Micro Devices. UNIX is a registered trademark of The Open Group.

This software or hardware and documentation may provide access to or information about content, products, and services from third parties. Oracle Corporation and its affiliates are not responsible for and expressly disclaim all warranties of any kind with respect to third-party content, products, and services unless otherwise set forth in an applicable agreement between you and Oracle. Oracle Corporation and its affiliates will not be responsible for any loss, costs, or damages incurred due to your access to or use of third-party content, products, or services, except as set forth in an applicable agreement between you and Oracle.

Contents

About This Document	v
Document Conventions	vi
Chapter 1	
System Overview	1
Overview	1
What is the CAP3GPRS Control Agent?	1
Chapter 2	
Configuration	3
Overview	3
Configuration Overview	3
eserv.config Configuration	4
Switch Type Configuration for CAP3GPRS	4
CAP3GPRS eserv.config Configuration	6
SLEE.cfg Configuration	18
Incoming and Outgoing Session Data	19
Parameter Mappings	21
Chapter 3	
Background Processes	27
Overview	27
cap3gprsControlAgent Process	27
Statistics Logged by the CAP3GPRS Control Agent	27
Chapter 4	
CAP3GPRS Operations and Message Sequences	29
Overview	29
Supported CAP3 GPRS and CAP3 INAP Operations	29
GPRS Context Flows	30
Message Flows for GPRS Sessions	39
Activity Test Flows	45
Chapter 5	
Troubleshooting	47
Overview	47
Message Sequences and Memory Leaks	47
Chapter 6	
About Installation and Removal	49
Overview	49
Installation and Removal Overview	49

Glossary of Terms.....	51
Index.....	57

About This Document

Scope

The scope of this document includes all the information required to install, configure and administer the Oracle Communications Network Charging and Control (NCC) CAP version 3 GPRS Control Agent (CAP3GPRS Control Agent) application.

Audience

This guide was written primarily for system administrators and persons installing, configuring and administering the CAP3GPRS Control Agent application. However, sections of the document may be useful to anyone requiring an introduction to the application.

Prerequisites

A solid understanding of UNIX and a familiarity with IN concepts are essential prerequisites for safely using the information contained in this technical guide. Attempting to install, remove, configure or otherwise alter the described system without the appropriate background skills could cause damage to the system; including temporary or permanent incorrect operation, loss of service, and may render your system beyond recovery.

A familiarity with the CAP version 3 GPRS protocol is also required. Refer to the following document:

CAMEL Application Part (CAP) specification (3GPP TS 29.078), version 4.8.0 Release 4

This manual describes system tasks that should only be carried out by suitably trained operators.

Related Documents

The following documents are related to this document:

- *Advanced Control Services Technical Guide*
- *CAP3GPRS Compliance Protocol Conformance Statement Guide*
- *Charging Control Services Technical Guide*
- *Charging Control Services User's Guide*
- *Service Management System Technical Guide*
- *Service Management System User's Guide*
- *Service Logic Execution Environment Technical Guide*

Document Conventions

Typographical Conventions

The following terms and typographical conventions are used in the Oracle Communications Network Charging and Control (NCC) documentation.

Formatting Convention	Type of Information
Special Bold	Items you must select, such as names of tabs. Names of database tables and fields.
<i>Italics</i>	Name of a document, chapter, topic or other publication. Emphasis within text.
Button	The name of a button to click or a key to press. Example: To close the window, either click Close , or press Esc .
Key+Key	Key combinations for which the user must press and hold down one key and then press another. Example: Ctrl+P or Alt+F4 .
Monospace	Examples of code or standard output.
Monospace Bold	Text that you must enter.
<i>variable</i>	Used to indicate variables or text that should be replaced with an actual value.
menu option > menu option >	Used to indicate the cascading menu option to be selected. Example: Operator Functions > Report Functions
hypertext link	Used to indicate a hypertext link.

Specialized terms and acronyms are defined in the glossary at the end of this guide.

System Overview

Overview

Introduction

This chapter provides a high-level overview of the Oracle Communications Network Charging and Control (NCC) CAP version 3 GPRS Control Agent (CAP3GPRS Control Agent). It describes the main functionality and components of the CAP3GPRS Control Agent.

This guide is not intended to advise on any specific NCC network or service implications of the product.

In this chapter

This chapter contains the following topics.

What is the CAP3GPRS Control Agent? 1

What is the CAP3GPRS Control Agent?

Introduction

The CAP3GPRS Control Agent is a SLEE application that translates between CAP3 GPRS messages and internal INAP operations.

The CAP3GPRS protocol is used to charge for data usage on GSM mobile devices.

Billing Using the UATB Feature Node

You should include the Universal Attempt Termination with Billing (UATB) feature node in control plans that are triggered by the CAP3GPRS Control Agent. You use the UATB feature node to bill for sessions.

For more information about the UATB feature node, see *Feature Nodes Reference Guide*.

Note: For volume billing, time will be converted to volume by using the multiplication factor set in *conversionFactor* (on page 14). A single GPRS request may bill for time or volume, but not both.

System Overview Diagram

This diagram shows how the CAP3GPRS Control Agent is implemented in an NCC system.

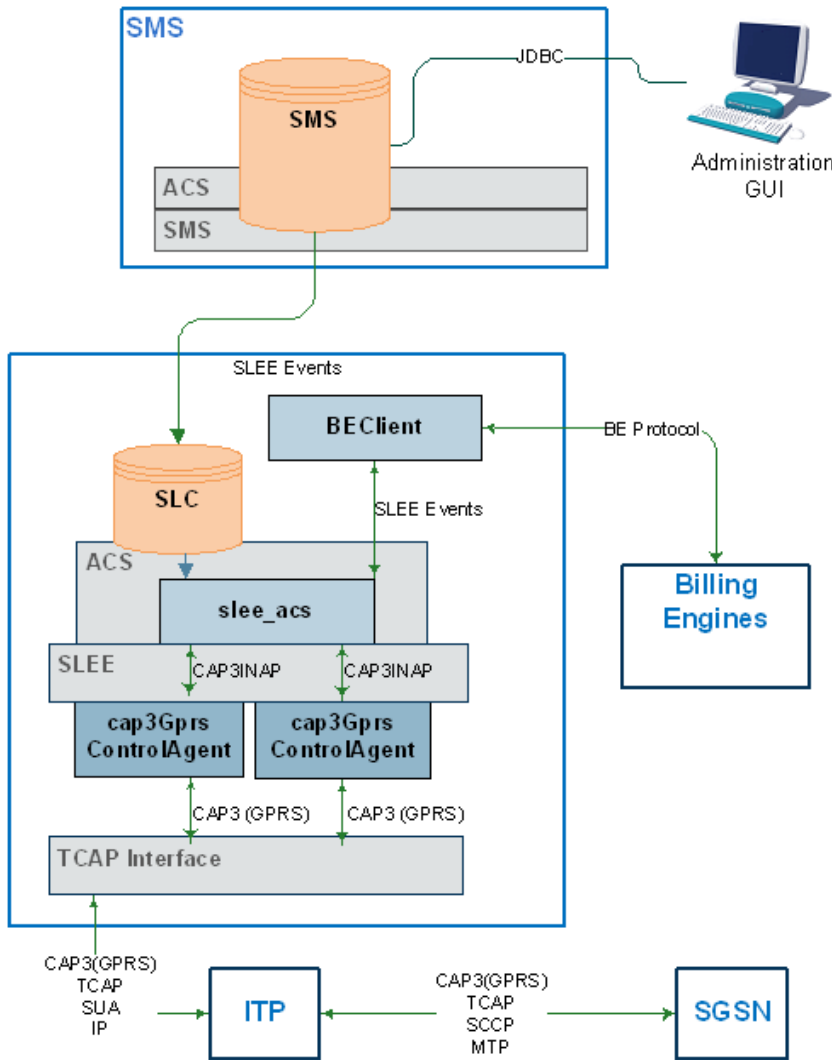

For more information about NCC system architecture, see the discussion on NCC system architecture in the *System Administrator's Guide*.

Configuration

Overview

Introduction

This chapter describes the configuration options for the Oracle Communications Network Charging and Control (NCC) CAP version 3 GPRS Control Agent (CAP3GPRS Control Agent).

In this chapter

This chapter contains the following topics.

Configuration Overview	3
eserv.config Configuration	4
Switch Type Configuration for CAP3GPRS	4
CAP3GPRS eserv.config Configuration	6
SLEE.cfg Configuration	18
Incoming and Outgoing Session Data	19
Parameter Mappings	21

Configuration Overview

Introduction

This section provides a high-level overview of how you configure the CAP3GPRS Control Agent.

The configuration files contain some configuration settings that are not explained in this chapter. These configuration settings are required by the application and should not be changed.

Configuration Components

This table lists the components of the CAP3GPRS Control Agent that you can configure, and the configuration file where each component is configured.

Component	Configuration File	Further Information
CAP3GPRS switch type	Configure the switch type for CAP3GPRS in the <code>acsCharging</code> section of <code>eserv.config</code> on SLC nodes.	<i>Switch Type Configuration for CAP3GPRS</i> (on page 4)
cap3gprsControl Agent	Configure the <code>cap3gprsControlAgent</code> binary in the <code>CAP3GPRS</code> section of <code>eserv.config</code> on SLC nodes.	<i>CAP3GPRS eserv.config Configuration</i> (on page 6)
cap3gprsControl Agent application ACSGPRS service	Configure the <code>cap3gprsControlAgent</code> application and the ACSGPRS service in <code>SLEE.cfg</code> on SLC nodes.	<i>SLEE.cfg Configuration</i> (on page 18) and <i>SLEE Technical Guide</i>

eserv.config Configuration

Introduction

The **eserv.config** file is a shared configuration file, from which many Oracle Communications Network Charging and Control (NCC) applications read their configuration. Each NCC machine (SMS, SLC, and VWS) has its own version of this configuration file, containing configuration relevant to that machine. The **eserv.config** file contains different sections; each application reads the sections of the file that contains data relevant to it.

The **eserv.config** file is located in the `/IN/service_packages/` directory.

The **eserv.config** file format uses hierarchical groupings, and most applications make use of this to divide the options into logical groupings.

Example Configuration File

Most applications come with an example of the section of the **eserv.config** configuration specific to that application, in a file called **eserv.config.example** in the root of the application directory. The example file for CAP3GPRS Control Agent is `/IN/service_packages/CAP3GPRS/etc/eserv.config.example`.

This example file contains commented examples of all of the parameters you can use to configure the application. You can use the example configuration for reference if you need to update the configuration for the control agent in the **eserv.config** file; for example, to add an optional parameter configuration.

Switch Type Configuration for CAP3GPRS

Introduction

The `acsCharging` section of **eserv.config** defines the switch types used to control the switch communication flows for the UATB feature node. You use the UATB feature node in control plans that are triggered by the CAP3GPRS Control Agent, to bill for sessions.

You must include a definition for the `cap3` switch type in the `acsCharging` section of **eserv.config**.

Example: This example shows the default `cap3` switch type configuration.

```
acsCharging = {
  swithConfiguration = [
    {
      switchType = "cap3"
      addContinue = false
      addDisconnectOrRelease = false
    }
  ]
}
```

For more information about `acsCharging` configuration, see *CCS Technical Guide*.

acsCharging Parameters

`switchConfiguration`

Syntax: `switchConfiguration = [switch_parameters]`

Description: Defines the switch type that will be used by the control agent during sessions.

Type: Array

Optionality: Required

Default: None
Notes: Additional switch types may be defined for other services. For more information, see *CCS Technical Guide*.

Example:

```
switchConfiguration = [
  {
    switchType = "cap3"
    addContinue = false
    addDisconnectOrRelease = false
  }
]
```

switchType

Syntax: `switchType = "str"`
Description: Sets the switch type for a UATB feature node.
Type: String
Optionality: Required
Allowed: Use "cap3" switch type for CAP3GPRS.
Default: None
Example: `switchType = "cap3"`

addContinue

Syntax: `addContinue = true|false`
Description: Defines whether the UATB feature node should enable send responses, add responses, and continue responses to the TCAP to enable charging for a successful subsequent reservation on the Voucher and Wallet Server.
Type: Boolean
Optionality: Optional (default used if not set)
Allowed: true, false
Default: false
Example: `addContinue = false`

addDisconnectOrRelease

Syntax: `addDisconnectOrRelease = true|false`
Description: Sets whether the UATB feature node can release or disconnect sessions during billing scenarios; for example, if the calling party has exhausted his or her funds or the maximum call limit has been reached.
Type: Boolean
Optionality: Optional (default used if not set)
Allowed:

- true – Enable release or disconnect calls
- false – Disable release or disconnect calls

Default: false
Example: `addDisconnectOrRelease = true`

CAP3GPRS eserv.config Configuration

Introduction

The CAP3GPRS section in `eserv.config` configures the `cap3gprsControlAgent` binary process. See *cap3gprsControlAgent Process* (on page 27) for details.

Note: The CAP3GPRS Control Agent is configured at installation time by the post installation configuration script that runs automatically. You only need to modify this configuration if you want to change the default configuration.

Example CAP3GPRS Section

Here is an example CAP3GPRS section in the `eserv.config` configuration file.

```
CAP3GPRS = {

    sleepTimeMicroseconds = 10000
    sendContinueWithApplyCharging = true
    sendContinueWithRRGPRSE = true
    defaultCalledPartyNumber = "4839100008"
    defaultBillingType = 1
    defaultSessionTreatment = 1
    armAllEdpsAtOnce = true
    displayMessageSequences = false
    minimumInstancesForObjectCounting = 1000
    tssf = 10
    maxInactiveTimeForVolume = 600
    timeBillingInactiveTimeTolerance = 10
    activityTestResultTimeout = 10
    tcapInterfaceName = "sua_if"
    alarmOnLatency = true
    latencyInterval = 10
    releaseCauseInsufficientFunds = 26
    releaseCauseNetworkError = 38
    sendAbortForDetachEventType = false
    sendAbortForDisconnectEventType = false
    armConnectEstablishAckOnContextChangeOfPosition = true

    Services = [
        {
            serviceName = "AcsGprs"
            gprsServiceKey = 8111
            sleeServiceKey = 1
            inapServiceKey = 110
            calledPartyNumber = "4839100009"
            billingType = 1
            conversionFactor = 104857.6
            sessionTreatment = 1
        }
    ]

    NumberRules = [

        { fromNoa=4, remove=0, prepend="00" }
        { fromNoa=3, remove=0, prepend="0064" }
    ]

    Tracing = {

        OrigAddress = [
            "0064212",
```

```

        "0064213",
        "0064214"
    ]

    DestAddress = [
        "0064213",
        "0064214"
    ]

    traceDebugLevel = "cap3gprsMessageSequences"
}
}

```

CAP3GPRS Parameters

sleepTimeMicroseconds

Syntax: `sleepTimeMicroseconds = microsecs`

Description: The maximum number of microseconds to sleep when there are no SLEE events to process.

Type: Integer

Optionality: Optional (default used if not set)

Default: 100

Example: `sleepTimeMicroseconds = 10000`

sendContinueWithApplyCharging

Syntax: `sendContinueWithApplyCharging = true|false`

Description: Whether or not to send ContinueGPRS operations with ApplyCharging INAP operations.

Type: Boolean

Optionality: Optional (default used if not set)

Allowed:

- true – Send ContinueGPRS
- false – Do not send ContinueGPRS

Default: true

Example: `sendContinueWithApplyCharging = true`

sendContinueWithRRGPRSE

Syntax: `sendContinueWithRRGPRSE = true|false`

Description: Whether or not to send ContinueGPRS messages with RequestReportGPRSEvent INAP operations.

Type: Boolean

Optionality: Optional (default used if not set)

Allowed:

- true – Send ContinueGPRS
- false – Do not send ContinueGPRS

Default: true

Example: `sendContinueWithRRGPRSE = true`

Chapter 2

defaultCalledPartyNumber

Syntax:	<code>defaultCalledPartyNumber = "num"</code>
Description:	The default called party BCD number to put in the InitialDP that is used by CCS for CLI-DN charging.
Type:	String
Optionality:	Optional (default used if not set)
Allowed:	A valid destination number.
Default:	0000
Example:	<code>defaultCalledPartyNumber = "4839100008"</code>

defaultBillingType

Syntax:	<code>defaultBillingType = int</code>
Description:	Sets the default billing type to either time or volume.
Type:	Integer
Optionality:	Optional (default used if not set)
Allowed:	0 – Sets the default billing type to time. 1 – Sets the default billing type to volume.
Default:	1
Example:	<code>defaultBillingType = 0</code>

defaultSessionTreatment

Syntax:	<code>defaultSessionTreatment = int</code>
Description:	Defines the default method used by CAP3GPRS Control Agent to handle InitialDPGPRS operations during a session.
Type:	Integer
Optionality:	Optional (default used if not set)
Allowed:	<ul style="list-style-type: none">• 1 – Send ApplyCharging INAP operations for the duration of the session and do not arm PDP context establishment.• 2 – Send ContinueGPRS operations, and monitor individual PDP contexts during the session, but do not monitor the session as a whole.
Default:	1
Example:	<code>defaultSessionTreatment = 1</code>

armAllEdpsAtOnce

Syntax:	<code>armAllEdpsAtOnce = true false</code>
Description:	Whether to arm all EDPs in a single RequestReportGPRSEvent operation, or wait for ContextEstablishmentAcknowledgement before arming disconnect.
Type:	Boolean
Optionality:	Optional (default used if not set)
Allowed:	<ul style="list-style-type: none">• true – Arm all EDPs in a single RequestReportGPRSEvent operation.• false – Wait for ContextEstablishmentAcknowledgement
Default:	true
Example:	<code>armAllEdpsAtOnce = true</code>

`displayMessageSequences`

Syntax:	<code>displayMessageSequences = true false</code>
Description:	Whether or not to display message sequences to standard output. Message sequences are displayed as one line per message.
Type:	Boolean
Optionality:	Optional (default used if not set)
Allowed:	<ul style="list-style-type: none"> • <code>true</code> – Display message sequences to standard output • <code>false</code> – Do not display message sequences
Default:	<code>false</code>
Notes:	Here is an example message output:

```
SLEECALLID 1234567 GPRS SCF->slee_acs:TCAP_BEGIN(InitialDP)
```

You can use `grep` and `sed` UNIX commands to collect all the output from a particular session and remove the first two fields from each line. The output would then look like this:

```
GPRS SCF->slee_acs:TCAP_BEGIN(InitialDP)
slee_acs->GPRS
SCF:TCAP_CONTINUE (ApplyCharging (releaseIfDurationExceeded) \n, RequestReport
BCSNEEvent\n, Continue)
GPRS SCF-
>SGSN:TCAP_CONTINUE (RequestReportBCSNEEvent (ContextEstablishmentAcknowledge
ment, disconnect) \n, ContinueGPRS)
SGSN->GPRS SCF:TCAP_END()
....
```

You can then convert this type of output to a graphical message sequence, by using a web-based sequence diagrams tool. For example:

<http://www.plantuml.com/plantuml/>

Example: `displayMessageSequences = true`

`minimumInstancesForObjectCounting`

Syntax:	<code>minimumInstancesForObjectCounting = int</code>
Description:	Sets the minimum number of instances allowed of a class for object counting debugging. For example, if you set the <code>cap3gprsObjectReport</code> debug flag, then the CAP3GPRS Control Agent prints a debug line every time the number of a class of objects reaches a multiple of <code>minimumInstancesForObjectCounting</code> . You can use the reported output to help identify the source of any memory leaks. See <i>Finding the Cause of a Memory Leak</i> (on page 48) for more information.
Type:	Integer
Optionality:	Optional (default used if not set)
Default:	1000
Notes:	If you set the <code>cap3gprsObjectCounts</code> debug flag, then the CAP3GPRS Control Agent produces one debug line every time the number of objects for a class changes. For more information about debug and debug flags, see <i>System Administrator's Guide</i> .
Example:	<code>minimumInstancesForObjectCounting = 900</code>

Chapter 2

tssf

Syntax: `tssf = secs`
Description: Sets the tssf timer in seconds. The CAP3GPRS Control Agent runs this timer whenever it sends an operation to `slee_acs` that needs a response. If the timer expires before `slee_acs` responds, the control agent logs an error and closes the dialog with the GGSN.
Type: Integer
Optionality: Optional (default used if not set)
Default: 10
Example: `tssf = 10`

maxInactiveTimeForVolume

Syntax: `maxInactiveTimeForVolume = secs`
Description: Sets the number of seconds to wait before sending ActivityTestGPRS operations for volume billing.
Type: Integer
Optionality: Optional (default used if not set)
Default: 3600
Notes: This parameter does not apply when billing by time.
Example: `maxInactiveTimeForVolume = 600`

timeBillingInactiveTimeTolerance

Syntax: `timeBillingInactiveTimeTolerance = secs`
Description: Sets the number of seconds to add to the time taken for duration billing in ApplyCharging INAP operations. This value is used to calculate the time to wait before sending ActivityTestGPRS operations.
Type: Integer
Optionality: Optional (default used if not set)
Default: 10
Notes: This parameter does not apply when billing by volume.
Example: `timeBillingInactiveTimeTolerance = 10`

activityTestResultTimeout

Syntax: `activityTestResultTimeout = secs`
Description: How long to wait (in seconds) for an ActivityTestGPRS result.
Type: Integer
Optionality: Optional (default used if not set)
Default: 10
Example: `activityTestResultTimeout = 10`

tcapInterfaceName

Syntax: `tcapInterfaceName = "if_name"`
Description: The TCAP interface name to use for sending ActivityTestGPRS operations. The named interface must be configured in `SLEE.cfg`. For information about configuring interfaces in `SLEE.cfg`, see *SLEE Technical Guide*.
Type: String
Optionality: Required

Default: None

Notes: If this configuration entry is missing or empty, then the ActivityTestGPRS operation will not be sent.

Example: `tcapInterfaceName = "sua_if"`
Where `sua_if` is the name for the SIGTRAN TCAP interface.

alarmOnLatency

Syntax: `alarmOnLatency = true|false`

Description: Sets whether or not notice alarms should be generated with latency information for IDPs and ACRs (Diameter Accounting-Request Commands), for example when waiting on `slee_acs`.

Type: Boolean

Optionality: Optional (default used if not set)

Allowed:

- `true` – Include latency information
- `false` – Do not include latency information

Default: `false`

Example: `alarmOnLatency = true`

latencyInterval

Syntax: `latencyInterval = secs`

Description: How long (in seconds) to wait between each latency report.

Type: Integer

Optionality: Optional (default used if not set)

Default: 60

Notes: To prevent any latency reporting, set `latencyInterval` to 0 (zero).

Example: `latencyInterval = 10`

releaseCauseInsufficientFunds

Syntax: `releaseCauseInsufficientFunds = int`

Description: The cause value to send in the releaseGPRS message when a call is released due to insufficient funds.

Type: Integer

Optionality: Optional (default used if not set)

Default: 26 – 'Insufficient resources' SM cause in TS 24.008

Notes: Because the SGSN does not necessarily follow TS 24.009, another cause value may be more appropriate than 26, for a given SGSN.

Example: `releaseCauseInsufficientFunds = 26`

releaseCauseNetworkError

Syntax: `releaseCauseNetworkError = int`

Description: The cause value to send in releaseGPRS messages when a call is released due to a network error, such as a timeout, or an incorrect message sequence.

Type: Integer

Optionality: Optional (default used if not set)

Default: 38 – 'Network failure' SM cause in TS 24.008

Notes: Because the SGSN does not necessarily follow TS 24.008, another cause value may be more appropriate than 38, for a given SGSN.

Example: `releaseCauseNetworkError = 38`

`sendAbortForDetachEventType`

Syntax: `sendAbortForDetachEventType = true|false`

Description: Whether to send TCAP_ABORT or ContinueGPRS in response to a 'detach' GPRS event type in an InitialDPGPRS.

Type: Boolean

Optionality: Optional (default used if not set)

Allowed:

- true – Send TCAP_ABORT in the response.
- false – Send ContinueGPRS in the response.

Default: false

Example: `sendAbortForDetachEventType = true`

`sendAbortForDisconnectEventType`

Syntax: `sendAbortForDisconnectEventType = true|false`

Description: Whether to send TCAP_ABORT or ContinueGPRS in response to a 'disconnect' GPRS event type in an InitialDPGPRS.

Type: Boolean

Optionality: Optional (default used if not set)

Allowed:

- true – Send TCAP_ABORT in the response.
- false – Send ContinueGPRS in the response.

Default: false

Example: `sendAbortForDisconnectEventType = true`

`armConnectEstablishAckOnContextChangeOfPosition`

Syntax: `armConnectEstablishAckOnContextChangeOfPosition = true | false`

Description: Specifies whether the CAP3GPRS control agent returns applyChargingGPRS when the GPRS event type is pdp-ContextChangeOfPosition.

Type: Boolean

Optionality: Optional (default used if not set)

Allowed:

- true – Returns applyChargingGPRS
- false – Does not return applyChargingGPRS

Default: true

Notes:

Example: `armConnectEstablishAckOnContextChangeOfPosition = true`

Services Parameters

You configure a CAP3GPRS service by configuring the parameters in the CAP3GPRS, Services section of `eserv.config`. You can configure one or more services.

The following example `Services` section configures the `AcsGprs` service:

```
Services = [  
  {  
    serviceName = "AcsGprs"  
    gprsServiceKey = 8111
```

```

sleeServiceKey = 1
inapServiceKey = 110
calledPartyNumber = "4839100009"
billingType = 1
conversionFactor = 104857.6
sessionTreatment = 1
}
]

```

serviceName

Syntax: `serviceName = "name"`

Description: The unique name of the service.

Type: String

Optionality: Required

Allowed: Any string

Default: Default

Example:: `serviceName = "AcsGprs"`

gprsServiceKey

Syntax: `gprsServiceKey = int`

Description: The incoming GPRS service key number.

Type: Integer

Optionality: Optional (default used if not set)

Default: 1

Example: `gprsServiceKey = 8111`

sleeServiceKey

Syntax: `sleeServiceKey = int`

Description: The SLEE service key for the `serviceName` (on page 13) service. Used when sending an InitialDP to the SLEE. For more information about service keys, see *SLEE Technical Guide*.

Type: Integer

Optionality: Optional (default used if not set)

Default: 1

Example: `sleeServiceKey = 12`

inapServiceKey

Syntax: `inapServiceKey = int`

Description: Sets the INAP service key to use when sending InitialDP to the SLEE.

Type: Integer

Optionality: Optional (default used if not set)

Default: 1

Example: `inapServiceKey = 110`

calledPartyNumber

Syntax: `calledPartyNumber = "called_number"`

Description: The called party BCD number to put in the InitialDP. It is used by CCS for CLI-DN charging.

Type: String
Optionality: Optional (default used if not set)
Allowed: A valid destination number.
Default: Defaults to the value specified in the `defaultCalledPartyNumber` parameter.
Example: `calledPartyNumber = "4839100009"`

`billingType`

Syntax: `billingType = int`
Description: Sets whether to bill based on time or volume.
Type: Integer
Optionality: Optional (default used if not set)
Allowed: 0 – Sets the billing type to time
1 – Sets the billing type to volume
Default: Defaults to the value of `defaultBillingType`.
Example: `billingType = 1`

`conversionFactor`

Syntax: `conversionFactor = num`
Description: The conversion factor to use when communicating with ACS to change deciseconds to octets. This factor is applied only when `billingType` is set to 1 (for volume billing).
Type: Float
Optionality: Optional (default used if not set)
Default: 104857.6 (converts one megabyte to one second)
Notes: The billing engine charges based on the number of deciseconds used. When charging by volume, the number of "fake" deciseconds is calculated by applying the conversion factor to the number of bytes used. The actual conversion factor used is determined by the system administrator responsible for designing the service.
Example: `conversionFactor = 104857.6`

`sessionTreatment`

Syntax: `sessionTreatment = int`
Description: Sets how the CAP3GPRS Control Agent handles an InitialDPGPRS operation for a session.
Type: Integer
Optionality: Optional (default used if not set)
Allowed:

- 1 – Send ApplyCharging INAP operations for the duration of the session and do not arm PDP context establishment.
- 2 – Send ContinueGPRS operations to monitor individual PDP contexts during the session, but do not monitor the session as a whole.

Default: Defaults to the value of `defaultSessionTreatment`.
Example: `sessionTreatment = 1`

NumberRules Parameters

You can configure the number normalization rules for the CAP3GPRS Control Agent by configuring the parameters in the optional `NumberRules` section of `eserv.config`.

Example:

```
NumberRules = [
  { fromNoa=4, min=1, max=9, remove=0, prepend="" }
  { fromNoa=3, remove=0, prepend="0064", prefix="", targetNoa=4 }
  { fromNoa=1, remove=0, prepend="0064", prefix="", targetNoa=4 }
]
```

`fromNoa`

Syntax: `fromNoa = int`

Description: Used when attempting to match the nature of address (NoA) number contained in a message. If there is a match, the `fromNoa` part of the number rule is evaluated.

Type: Integer

Optionality: Required

Allowed:

- 2 – For unknown NoAs
- 3 – For national NoAs
- 4 – For international NoAs

Notes: If you omit `fromNoa` from the `NumberRules` parameter section, then no matching rule will be found.

Example: `fromNoa = 3`

`max`

Syntax: `max = num`

Description: Specifies the maximum number of digits a number may contain. To meet the `max` part of the number rule, the number of digits in the number must be equal to or less than the value of `max`.

Type: Integer

Optionality: Optional (default used if not set)

Default: 999

Example: `max = 9`

`min`

Syntax: `min = num`

Description: Specifies the minimum number of digits a number may contain. To meet the `min` part of the number rule, the number of digits in the number must be equal to or greater than the value of `min`.

Type: Integer

Optionality: Optional (default used if not set)

Default: 0

Notes: The value of the `min` parameter must be greater than or equal to the value of the `remove` (on page 16) parameter.

Example: `min = 5`

Chapter 2

prefix

Syntax:	<code>prefix = "pref"</code>
Description:	Contains a digit or digits. Used to attempt to match the first digit or digits of a prefix number with the specified value. If the digit or digits match, the prefix part of the number rule is met.
Type:	String
Optionality:	Optional
Allowed:	One or more decimal digits
Notes:	This parameter is an element of the <code>NumberRules</code> parameter array.
Example:	<code>prefix = "25"</code>

prepend

Syntax:	<code>prepend = "digits"</code>
Description:	Defines digits added to the beginning of a number.
Type:	String
Optionality:	Optional
Allowed:	Any combination of decimal digits, or a null string ("")
Notes:	<ul style="list-style-type: none">• If the <code>remove</code> and <code>prepend</code> parameters are both used in the same number rule, "<code>prepend</code>" is added to the beginning of the number after the number has been modified by the <code>remove</code> parameter.• The <code>prepend</code> parameter is an element of the <code>NumberRules</code> parameter array.
Example:	<code>prepend = "0"</code>

remove

Syntax:	<code>remove = num</code>
Description:	The number of digits stripped from the beginning of a number.
Type:	Integer
Optionality:	Required
Notes:	The value of the <code>remove</code> parameter must be less than or equal to the value of the <code>min</code> (on page 15) parameter.
Example:	<code>remove = 2</code>

targetNoa

Syntax	<code>targetNoa = int</code>
Description:	Target nature of address.
Type:	Integer
Optionality:	Optional
Notes:	<ul style="list-style-type: none">• A value is typically specified in denormalization rules.• The <code>targetNoa</code> parameter is an element of the <code>NumberRules</code> parameter array.
Example:	<code>targetNoa = 4</code>

Tracing Parameters

The following parameters are used for tracing activities. They are all found within the `Tracing = { }` statement.

enabled

Syntax: `enabled = true|false`
Description: Switches tracing on or off.
Type: Boolean
Optionality: Optional
Allowed: true, false
Default: false
Notes: If false, then the parameters in the Tracing section are ignored.
Example: `enabled = false`

OrigAddress

Syntax: `OrigAddress = ["addr", "addr" ...]`
Description: Lists the originating addresses to be traced.
Type: String
Optionality: Optional (default used if not set)
Allowed:

- Any valid addresses
- ""

Default: ""
Example:

```
OrigAddress = [
    "0064212",
    "0064213",
    "0064214"
]
```

DestAddress

Syntax: `DestAddress = ["addr", "addr" ...]`
Description: Lists the destination addresses to be traced.
Type: String
Optionality: Optional (default used if not set)
Allowed:

- Any valid address
- ""

Default: ""
Example:

```
DestAddress = [
    "0064212",
    "0064213",
]
```

traceDebugLevel

Syntax: `traceDebugLevel = "str, str"`
Description: Sets the debug tracing level.
Type: String
Optionality: Required
Allowed: For example, set `traceDebugLevel` to:

- "all" to switch on all debug for traced numbers
- "cap3gprsMessageSequences" to only record message sequences for traced numbers.

Default: N/A

Notes: This is a comma separated string. See *ACS Technical Guide* for more information.

Example: `traceDebugLevel = "cap3gprsMessageSequences"`

SLEE.cfg Configuration

Introduction

The **SLEE.cfg** file is configured to enable the CAP3GPRS Control Agent to work. All necessary SLEE configuration is done at installation time by the configuration script; this section is for information only.

The SLEE configuration file is located in `/IN/service_packages/SLEE/etc/SLEE.cfg`.

See *SLEE Technical Guide* for information about configuring the SLEE.

CAP3GPRS Control Agent SLEE Configuration

During installation, the following lines are automatically added to the configuration in **SLEE.cfg**:

```
APPLICATION=cap3GprsControlAgent cap3GprsControlAgent.sh
/IN/service_packages/CAP3GPRS/bin 1 1 1000
SERVICE=ACSGPRS 1 cap3GprsControlAgent ACSGPRS
SERVICEKEY=INTEGER 8111 ACSGPRS
```

Note: **SLEE.cfg** must contain at least one **SERVICE** line and one **SERVICEKEY** line referring to the `cap3GprsControlAgent APPLICATION` line.

SERVICEKEY values

Here is an example **SERVICEKEY** entry in **SLEE.cfg**.

```
SERVICEKEY=INTEGER 0x1920000004b ACSGPRS
```

In this example the **SERVICEKEY** has the value of `0x1920000004b`. This number can be broken down into three parts.

- 1 The service key always starts with `0x1`.
- 2 The next two digits (`92`) are the SCCP sub-system number from the SCCP called party address in hexadecimal digits.
- 3 The last digits are the `serviceKey` parameter in `InitialDPGPRS` operations (also in hex).

The example configuration causes all `InitialDPGPRS` operations sent to sub-system number `146` and with `serviceKey 75`, to use the `ACSGPRS` service.

Example Configuration

```
APPLICATION=cap3GprsControlAgent cap3GprsControlAgent.sh
/IN/service_packages/CAP3GPRS/bin 1 1 1000
SERVICE=ACSGPRS 1 cap3GprsControlAgent ACSGPRS
SERVICEKEY=INTEGER 0x1000000004b ACSGPRS
SERVICEKEY=INTEGER 0x1920000004b ACSGPRS
SERVICEKEY=INTEGER 0x1920000004c ACSGPRS
SERVICEKEY=INTEGER 8111 ACSGPRS
SERVICEKEY=INTEGER 8112 ACSGPRS
SERVICEKEY=INTEGER 8113 ACSGPRS
SERVICEKEY=INTEGER 8114 ACSGPRS
SERVICEKEY=INTEGER 8115 ACSGPRS
```

Incoming and Outgoing Session Data

Introduction

The CAP3GPRS Control Agent determines incoming and outgoing session data values from ACS profile tag values.

Note: Profile tags are stored in profile blocks and configured in the ACS user interface (UI). See the discussion on ACS configuration in *ACS User's Guide* for more information.

IDP Extensions Parameter

The CAP3GPRS Control Agent passes a profile block to ACS in the `InitialDP.extensions` parameter as extension type 701. The `slee_acs` process makes the profile tags from this profile block available to a feature node through the **Session data, Incoming Session Data** option in the feature node configuration window.

IDP Profile Tags

This table lists the information written into IDP extension type 701 by the CAP3GPRS Control Agent.

Profile Tag Number	Name
18030001	GPRS Access Point Name
18030002	GPRS Event Type
18030003	GPRS Requested QOS Delay Class
18030004	GPRS Requested QOS Reliability Class
18030005	GPRS Requested QOS Peak Throughput
18030006	GPRS Requested QOS Precedence Class
18030007	GPRS Requested QOS Mean Throughput
18030008	GPRS Long Requested QOS Priority Level
18030009	GPRS Long Requested QOS Traffic Class
18030010	GPRS Long Requested QOS Delivery Order
18030011	GPRS Long Requested QOS Delivery Of Erroneous SDU
18030012	GPRS Long Requested QOS Max SDU Size
18030013	GPRS Long Requested QOS Max Bit Rate For Up Link
18030014	GPRS Long Requested QOS Max Bit Rate For Down Link
18030015	GPRS Long Requested QOS Residual BER
18030016	GPRS Long Requested QOS SDU Error Ratio
18030017	GPRS Long Requested QOS Transfer Delay
18030018	GPRS Long Requested QOS Traffic Handling Priority
18030019	GPRS Long Req QOS Guaranteed Rate For Up Link
18030020	GPRS Long Req QOS Guaranteed Rate For Down Link
18030021	GPRS Subscribed QOS Delay Class
18030022	GPRS Subscribed QOS Reliability Class
18030023	GPRS Subscribed QOS Peak Throughput
18030024	GPRS Subscribed QOS Precedence Class
18030025	GPRS Subscribed QOS Mean Throughput

Profile Tag Number	Name
18030026	GPRS Long Subscribed QOS Priority Level
18030027	GPRS Long Subscribed QOS Traffic Class
18030028	GPRS Long Subscribed QOS Delivery Order
18030029	GPRS Long Subscribed QOS Delivery Of Erroneous SDU
18030030	GPRS Long Subscribed QOS Max SDU Size
18030031	GPRS Long Subscribed QOS Max Bit Rate For Up Link
18030032	GPRS Long Subscribed QOS Max Rate For Down Link
18030033	GPRS Long Subscribed QOS Residual BER
18030034	GPRS Long Subscribed QOS SDU Error Ratio
18030035	GPRS Long Subscribed QOS Transfer Delay
18030036	GPRS Long Subscribed QOS Traffic Handling Priority
18030037	GPRS Long Sub QOS Guaranteed Rate For Up Link
18030038	GPRS Long Sub QOS Guaranteed Rate For Down Link
18030039	GPRS Negotiated QOS Delay Class
18030040	GPRS Negotiated QOS Reliability Class
18030041	GPRS Negotiated QOS Peak Throughput
18030042	GPRS Negotiated QOS Precedence Class
18030043	GPRS Negotiated QOS Mean Throughput
18030044	GPRS Long Negotiated QOS Priority Level
18030045	GPRS Long Negotiated QOS Traffic Class
18030046	GPRS Long Negotiated QOS Delivery Order
18030047	GPRS Long Negotiated QOS Delivery Of Erroneous SDU
18030048	GPRS Long Negotiated QOS Max SDU Size
18030049	GPRS Long Negotiated QOS Max Bit Rate For Up Link
18030050	GPRS Long Negotiated QOS Max Rate For Down Link
18030051	GPRS Long Negotiated QOS Residual BER
18030052	GPRS Long Negotiated QOS SDU Error Ration
18030053	GPRS Long Negotiated QOS Transfer Delay
18030054	GPRS Long Negotiated QOSTraffic Handling Priority
18030055	GPRS Long Neg QOS Guaranteed Rate For Up Link
18030056	GPRS Long Neg QOS Rate For Down Link
18030057	GPRS Routing Area Identity Country Code
18030058	GPRS Routing Area Identity Network Code
18030059	GPRS Routing Area Identity Location Area Code
18030060	GPRS Routing Area Identity Routing Area Code
18030061	GPRS Charging ID
18030062	GPRS SGSN Capabilities
18030063	GPRS Location Information Country Code
18030064	GPRS Location Information Network Code
18030065	GPRS Location Information Location Area Code
18030066	GPRS Location Information Cell Identity

Profile Tag Number	Name
18030067	GPRS Location Information SAI Present
18030068	GPRS PDP Initiation Type
18030069	GPRS GGSN Address
18030070	GPRS Secondary PDP Context
18030071	GPRS Billing Type
18030072	GPRS SGSN Number Digits
18030073	GPRS SGSN Number NoA

ApplyChargingReport.extensions Parameter

The CAP3GPRS Control Agent passes a profile block to ACS in the `ApplyChargingReport.extensions` parameter as extension type 701. The `slee_acs` process makes the profile tags from this profile block available to feature node through the **Session data, Incoming Session Data** option in the feature node configuration window.

ApplyCharging Report Profile Tags

This table lists the information written into ApplyChargingReport extension type 701 by the CAP3GPRS Control Agent

Field	Description
18030201	GPRS Total Transferred Volume
18030202	GPRS 32 Bit Transferred Volume
18030203	GPRS Transferred Volume Rollover

Connect.extensions Parameter

When a feature node writes session data into the feature node configuration option for outgoing session data, the `slee_acs` sends a profile block in the `Connect.extensions` parameter as extension type 701. The CAP3GPRS Control Agent can then use the applicable profile tags from this profile block.

Connect Profile Tags

This table lists the information derived from the outgoing connect extension type 701 by the CAP3GPRS Control Agent.

Field	Description
18030001	GPRS Access Point Name
18030071	GPRS Billing Type

Parameter Mappings

Introduction

This section describes the mappings between INAP parameters and CAP3GPRS parameters.

GPRS Parameters Received from the SGSN

This table lists the mappings for GPRS parameters received from the SGSN.

GPRS Parameter	Mapping
InitialIDPGPRS.serviceKey	Identifies the correct service using the configuration defined in the CAP3GPRS, Services section of eserv.config .
InitialIDPGPRS.gPRSEventType	Put in IDP.incomingExtensions. Used by the state machine logic, for example, when selecting billing type.
InitialIDPGPRS.requestedQOS	Put in IDP.incomingExtensions.
InitialIDPGPRS.subscriberQOS	Put in IDP.incomingExtensions.
InitialIDPGPRS.negotiatedQOS	Put in IDP.incomingExtensions.
InitialIDPGPRS.routingArealIdentity	Put in IDP.incomingExtensions.
InitialIDPGPRS.chargingID	Put in IDP.incomingExtensions.
InitialIDPGPRS.sgsnCapabilities	Put in IDP.incomingExtensions.
InitialIDPGPRS.cellGlobalIdOrServiceAreaIdOrLAI	Put in IDP.incomingExtensions.
InitialIDPGPRS.sai_Present	Put in IDP.incomingExtensions.
InitialIDPGPRS.pDPInitiationType	Put in IDP.incomingExtensions.
InitialIDPGPRS.ggsnAddress	Put in IDP.incomingExtensions.
InitialIDPGPRS.sgsnNumber	Put in IDP.incomingExtensions.
InitialIDPGPRS.secondaryPDP-context	Put in IDP.incomingExtensions.
InitialIDPGPRS.mSISDN	Put in IDP.callingpartynumber.
InitialIDPGPRS.iMSI	Put in IDP.iMSI.
InitialIDPGPRS.accessPointName	Put in IDP.incomingExtensions.
EntityReleasedGPRS.gPRSCause	Put in EventReportBCSM.routeSelectFailureSpecificInfo
ApplyChargingReportGPRS.volumeIfNoTariffSwitch	Add 4294967296 multiplied by transferredVolumeRollover. Divide by conversion factor and put in ApplyChargingReport.timeifNoTariffSwitch. Put the unmodified value of volumelfNoTariffSwitch (without applying the conversion factor) in ApplyChargingReport.incomingExtensions.
ApplyChargingReportGPRS.transferredVolumeRollover	Add 4294967296 multiplied by transferredVolumeRollover. Divide by conversion factor and put in ApplyChargingReport.timeifNoTariffSwitch. Put the unmodified value of transferredVolumeRollover (without applying the conversion factor) in ApplyChargingReport.incomingExtensions.
ApplyChargingReport	Multiply by 10 and put in ApplyCharging.timeifNoTariffSwitch.

GPRS Parameter	Mapping
GPRS.timeGPRSIfNoTariffSwitch	
ApplyChargingReportGPRS.active	Used in state machine logic and put in ApplyChargingReport.callActive.
EventReportGPRS.GPSEventType	Used in state machine logic.

GPRS Parameters Sent to SGSN

This table lists the GPRS parameters sent to SGSN, and defines how they are set.

GPRS Parameter	Definition
RequestReportGPRS.eventtypeGPRS	Set by state machine logic.
RequestReportGPRS.monitorMode	Set by state machine logic.
ApplyChargingGPRS.maxElapsedTime	Set to ApplyCharging.maxDuration divided by 10 for duration billing.
ApplyChargingGPRS.maxTransferredVolume	Set to ApplyCharging.maxDuration multiplied by conversion factor for volume billing.
connectGPRS.accessPointName	Set from Connect.outgoingExtensions.
FurnishChargingGPRS.fciGPRSBillingCharacteristics	Set from FurnishChargingInformation.fciBillingChargingCharacteristics.
SendChargingGPRS.sciGPRSBillingChargingCharacteristics	Set from SendChargingInformation.sciBillingChargingCharacteristics.

INAP Parameters Sent to slee_acs

This table lists the INAP parameters sent to slee_acs, and defines how they are set.

INAP Parameter	Definition
IDP.callingPartyNumber	Set to IDPGPRS.mSISDN.
IDP.iMSI	Set to IDPGPRS.iMSI.
IDP.calledPartyBCDNumber	Set from the calledpartyNumber defined in the CAP3GPRS, Services section of <code>eserv.config</code> .
IDP.eventTypeBCSM	Set to analyzedInformation.
IDP.bearerCapability	Set to indicated "Speech" for duration billing or "unrestricted digital information with tones and announcements" for volume billing.
IDP.extensions	The binary data that is placed in extension 701 (incoming extensions), and that contains various pieces of information, such as the transferredVolumeRollover value.
ApplyChargingReport.callActive	Set to ApplyChargingReportGPRS.active or to false if in StateOpenFinal.

INAP Parameter	Definition
ApplyChargingReport.callReleaseAtTcpExpiry	Only set if ApplyChargingReportGPRS (active = true) is received in StateOpenFinal.
ApplyChargingReport.timeifNoTariffSwitch	Set to one of: <ul style="list-style-type: none"> 10 * (elapsedTime + 86400 * elapsedTimeRollover) for duration billing (transferredVolume + 4294967296) / conversion factor for volume billing
EventReportBCSM.routeSelectFailureSpecificInfo	Set to EntityReleaseGPRS.gPRSCause.
EventReportBCSM.messageType	If EventReportBCSM.eventTypeBCSM is set to: <ul style="list-style-type: none"> routeSelectFailure (RSF) then EventReportBCSM.messageType is set to request. oDisconnect or oAnswer then EventReportBCSM.messageType is set to notification.
EventReportBCSM.receivingSideID	Set to leg 1.
EventReportBCSM.oDisconnectSpecificInfo	Set to 31.
EventReportBCSM.eventTypeBCSM	Set according to state machine logic to one of: <ul style="list-style-type: none"> routeSelectFailure oAnswer oDisconnect.

INAP Parameters Received from slee_acs

This table lists the INAP parameters received from slee_acs and how they are mapped in GPRS.

INAP Parameter	GPRS Mapping
ApplyCharging.releaseDurationExceeded	Put into either StateOpen or StateOpenFinal as determined by the state machine.
ApplyCharging.maxDuration	For duration billing, divide by ten and put in the ApplyChargingGPRS.maxElapsedTime parameter. For volume billing, multiply by conversion factor and put in the ApplyChargingGPRS.maxTransferredVolume parameter.
Connect.extensions	Outgoing extensions (extension 701) used to change billing type to set access point name in ConnectGPRS.
EventReportBCSM.eventTypeBCSM	Used in state machine logic.
EventReportBCSM.monitormode	Used in state machine logic.
Connect.destinationRoutingAddress	Ignored.
ReleaseCall.reason	Used in ReleaseGPRS.fciGPRSBilling.
FurnishChargingInformation.fciBillingChargingCharacteristics	Put in FurnishChargingGPRS.fciGPRSBillingChargingCharacteristics

INAP Parameter	GPRS Mapping
ics	
SendChargingInformation.sciBillingChargingCharacteristics	Put in SendChargingGPRS.sciGPRSBillingChargingCharacteristics.

Background Processes

Overview

Introduction

This chapter describes the background process that is run automatically by the Oracle Communications Network Charging and Control (NCC) CAP version 3 GPRS Control Agent (CAP3GPRS Control Agent) and lists the statistics that are logged by the control agent.

In this chapter

This chapter contains the following topics.

cap3gprsControlAgent Process.....	27
Statistics Logged by the CAP3GPRS Control Agent	27

cap3gprsControlAgent Process

Purpose

The cap3GprsControlAgent binary is a SLEE application that translates between CAP3 GPRS messages and CAP3 INAP operations. It enables a CAP3 SGSN client to talk to a CAP3 SCF such as CCS or ACS.

Startup

The cap3gprsControlAgent binary process is started automatically by the SLEE. For more information, see *SLEE.cfg Configuration* (on page 18).

Configuration

The cap3gprsControlAgent binary process is configured by the CAP3GPRS section in **eserv.config**. For details, see *CAP3GPRS eserv.config Configuration* (on page 6).

Failure

If the cap3gprsControlAgent fails, no operations will be processed for the CAP3GPRS Control Agent.

Statistics Logged by the CAP3GPRS Control Agent

Introduction

CAP3GPRS statistics are generated by each Service Logic Controller (SLC), and then transferred at periodic intervals to the Service Management System (SMS) for permanent storage and analysis.

The statistics are logged by the smsStats functions provided by the SMS application. For more information, see *SMS Technical Guide*.

CAP3GPRS Statistics

The following statistics are logged for the CAP3GPRS Control Agent. Each statistic logged has APPLICATION_ID = 'CAP3GPRS' (application number 113):

- IDPGPRS_RECEIVED
- GPRS_TIMED_OUT
- IN_TIMED_OUT
- ENDED_IN_ERROR
- CHARGED_USER_DISCONNECTED
- CHARGED_TERMINATED_NO_FUNDS
- RELEASED
- NOT_CHARGED
- CHARGED
- CHARGED_ERROR
- CONTINUE_GPRS_NO_TRIGGER
- IDP_SENT
- NOT_CHARGED_CONNECT
- NOT_CHARGED_CONTINUE

For each statistic, the gprsEventType from the original InitialDPGPRS is put into the statistics detail field, SMF_STATISTICS.DETAIL, in the form of a string (for example: "ContextEstablishment").

CAP3GPRS Statistics Reports

You can generate the following statistics reports for the CAP3GPRS Control Agent:

- CAP3GPRS System Stats
- CAP3GPRS System Stats by EDP

For each report type, you can specify whether to report on all entries or only totals.

When you run the CAP3GPRS System Stats by EDP report, you specify the EDP to report on by selecting one of the following EDPs:

- attach
- attachChangeOfPosition
- ContextEstablishment
- ContextEstablishmentAcknowledgement, or
- Unsupported

You generate reports from the Report Functions window in the SMS UI. See *SMS User's Guide* for more information.

CAP3GPRS Operations and Message Sequences

Overview

Introduction

This chapter lists the INAP and GPRS operations supported by the Oracle Communications Network Charging and Control (NCC) CAP version 3 GPRS Control Agent (CAP3GPRS Control Agent), and provides example message sequence charts that show the flows through the software when messages are sent or received by the CAP3GPRS Control Agent.

In this chapter

This chapter contains the following topics.

Supported CAP3 GPRS and CAP3 INAP Operations.....	29
GPRS Context Flows.....	30
Message Flows for GPRS Sessions	39
Activity Test Flows.....	45

Supported CAP3 GPRS and CAP3 INAP Operations

CAP3 GPRS Supported Operations

The CAP3GPRS Control Agent supports the following CAP3 GPRS operations:

- ApplyChargingReportGPRS
- EntityReleasedGPRS
- EventReportGPRS
- InitialDPGPRS
- ApplyChargingGPRS
- RequestReportGPRSEvent
- ConnectGPRS
- ContinueGPRS
- ReleaseGPRS
- SendChargingInformationGPRS
- FurnishChargingInformationGPRS

CAP3 INAP Supported Operations

The CAP3GPRS Control Agent supports the following CAP3 INAP operations:

- ApplyCharging
- ApplyChargingReport
- Connect

- Continue
- EventReportBCSM
- FurnishChargingInformation
- InitialDP
- ReleaseCall
- RequestReportBCSMEvent
- SendChargingInformation

GPRS Context Flows

Introduction

This section details the GPRS PDP context flows that the CAP3GPRS Control Agent can produce. For all these message sequences the `IDPGPRS.gprsEventType` is 11 (ContextEstablishment).

Received ApplyCharging(releaseIfDurationExceeded)

Here is an example message sequence for an ApplyCharging(releaseIfDurationExceeded) operation received by the CAP3GPRS Control Agent.

Note: Billing can be configured for either duration or volume.

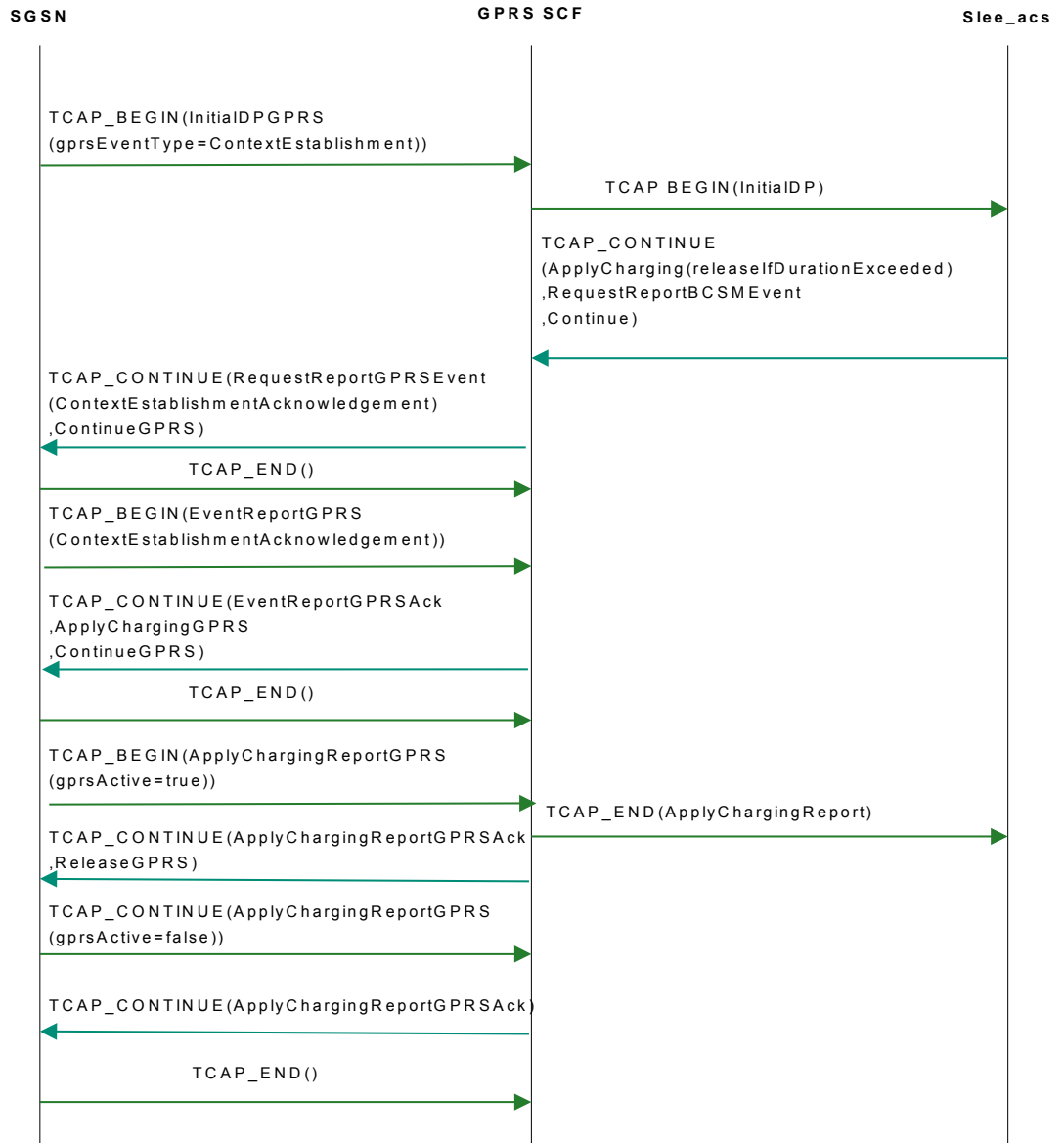

Credit Expiry Example 1

Here is an example message sequence for a credit expiry after several successful balance updates.

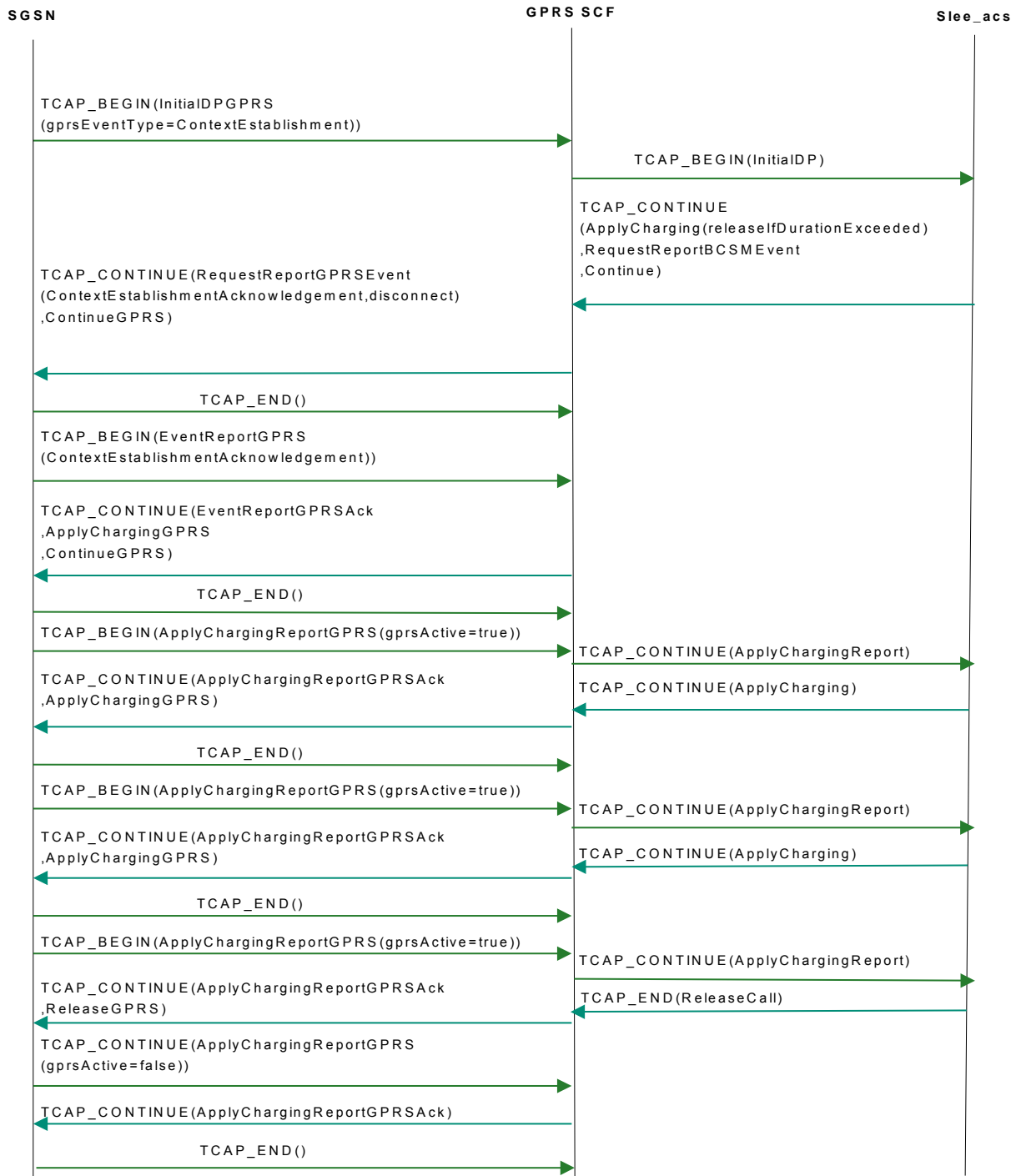

INAP Connect, New accessPointName, with No Charging

Here is an example message sequence where an INAP connect specifies a new accessPointName with no charging.

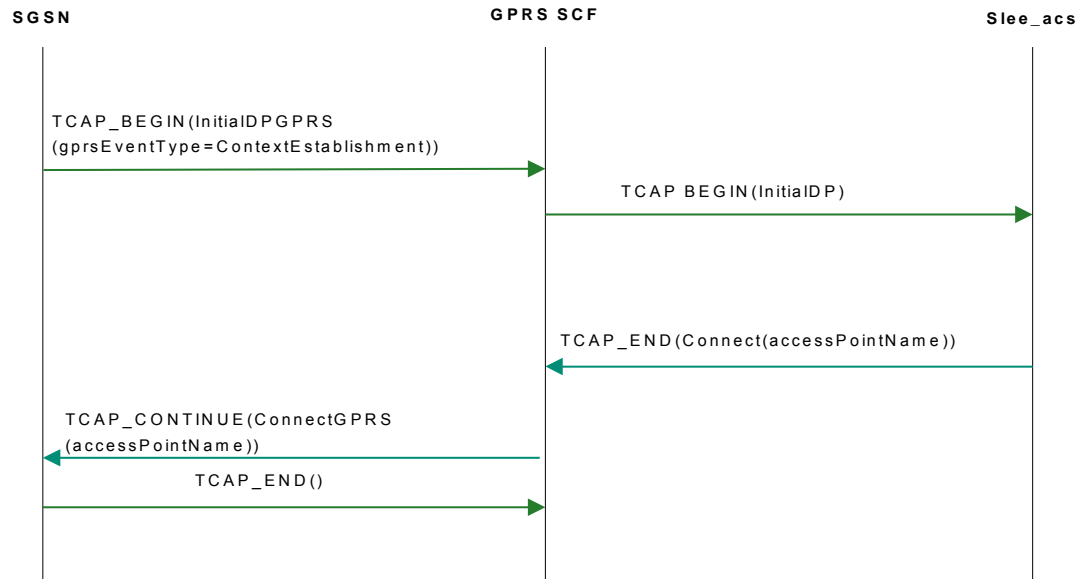

INAP Connect, New accessPointName, with Charging

Here is an example message sequence where an INAP connect specifies a new accessPointName with charging.

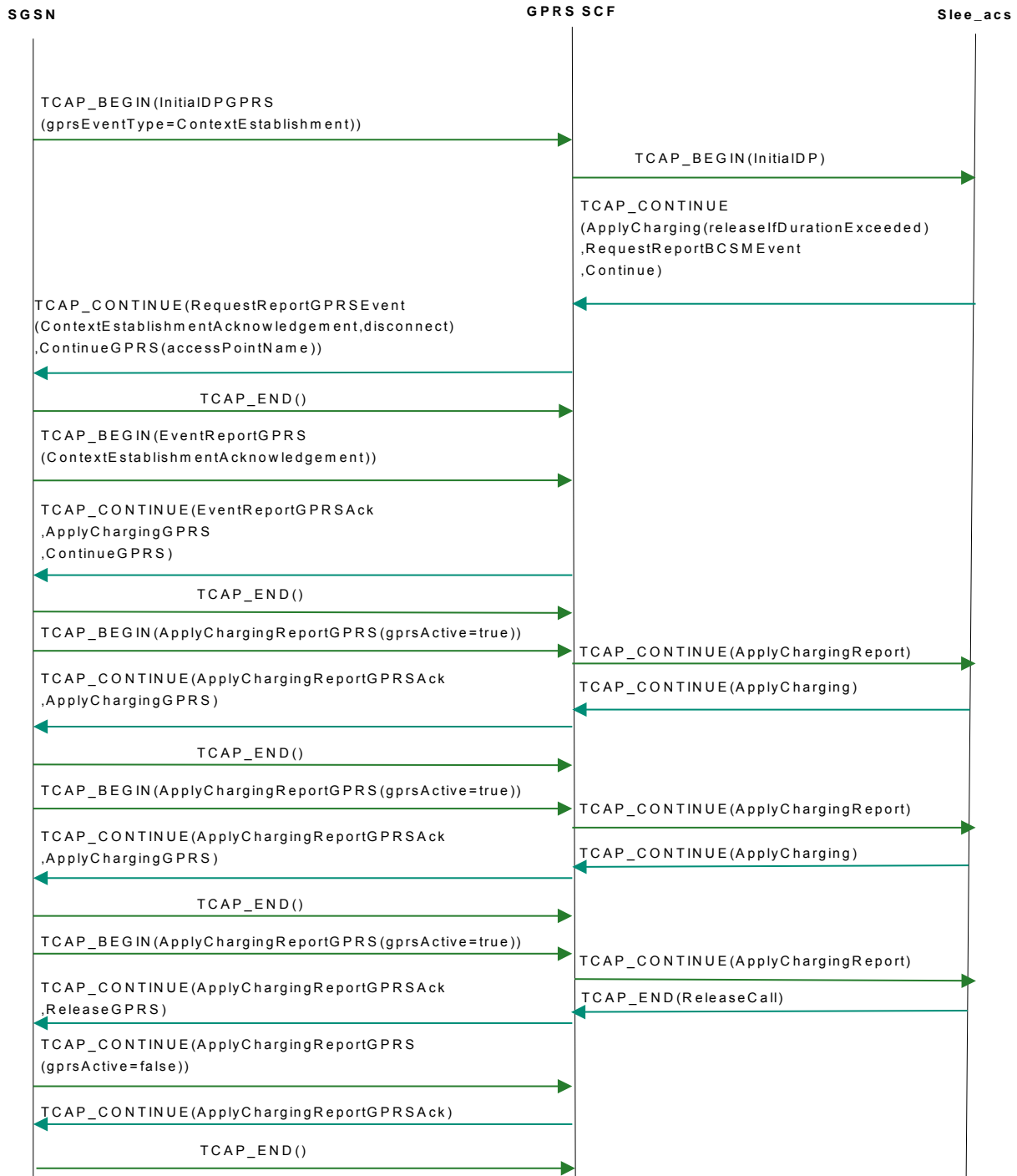

INAP Continue Received

Here is an example message sequence for an INAP Continue received.

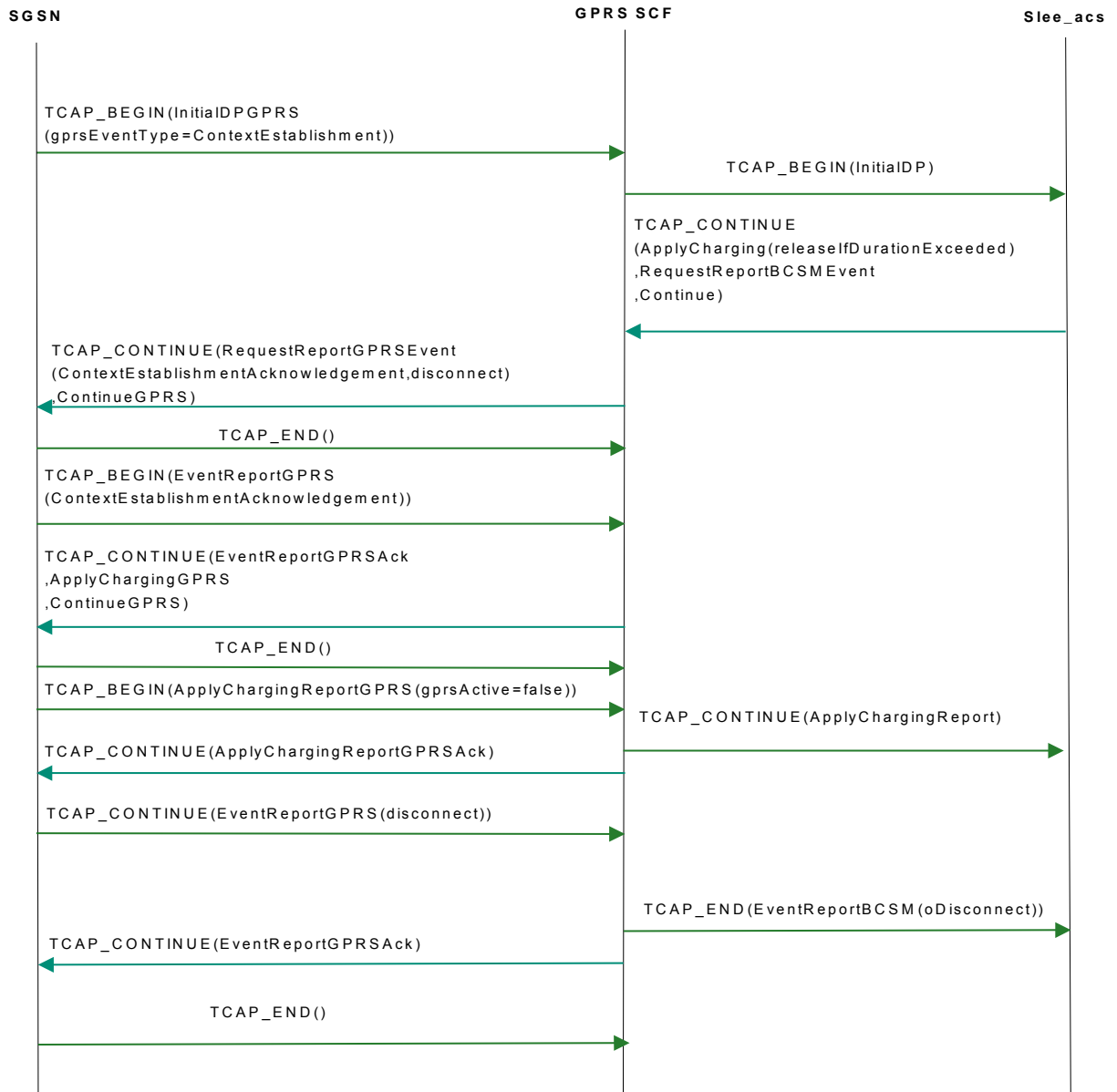

User Disconnects with Charging

Here is an example message sequence for user disconnects with charging.

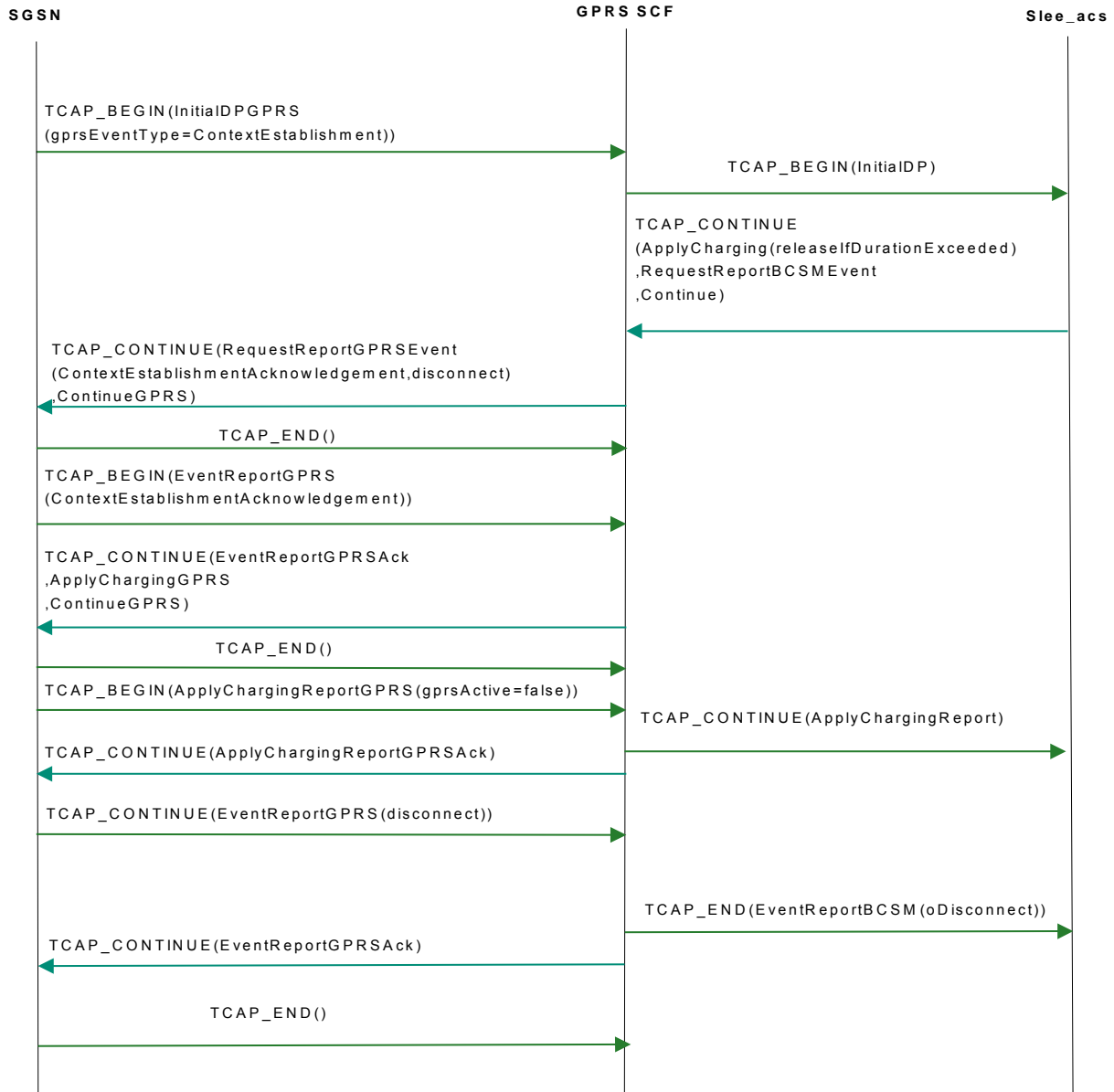

PDP Context Detached, Example 1

Here is an example message sequence for a PDP context detached before context establishment acknowledgement (first variant).

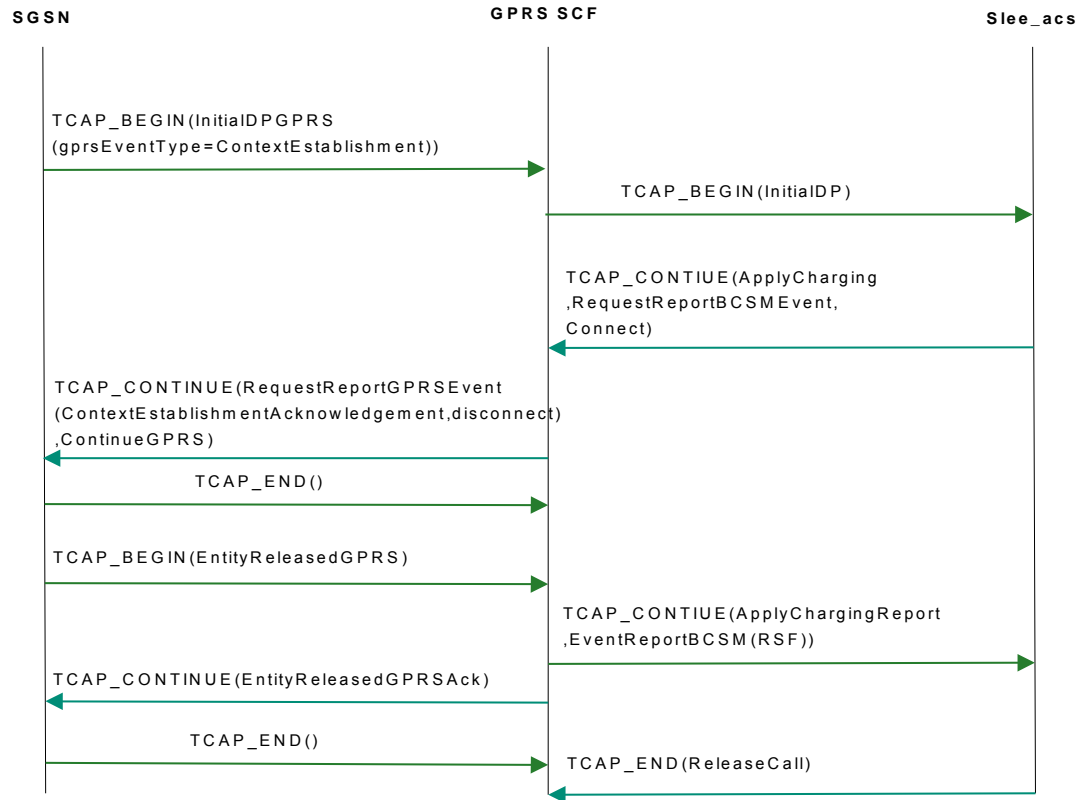

PDP Context Detached, Example 2

Here is an example message sequence for a PDP context detached before context establishment acknowledgement (second variant).

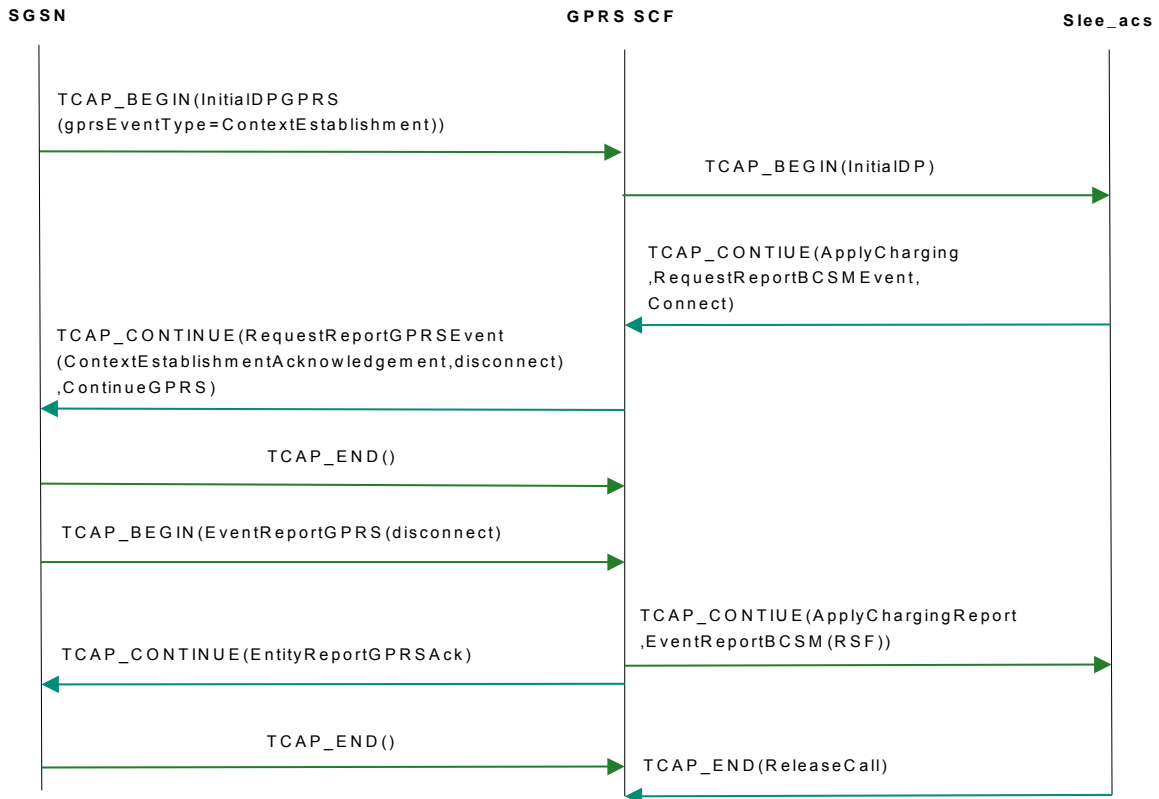

ReleaseCall Operation Received from slee_acs

Here is an example message sequence for a ReleaseCall operation received from slee_acs.

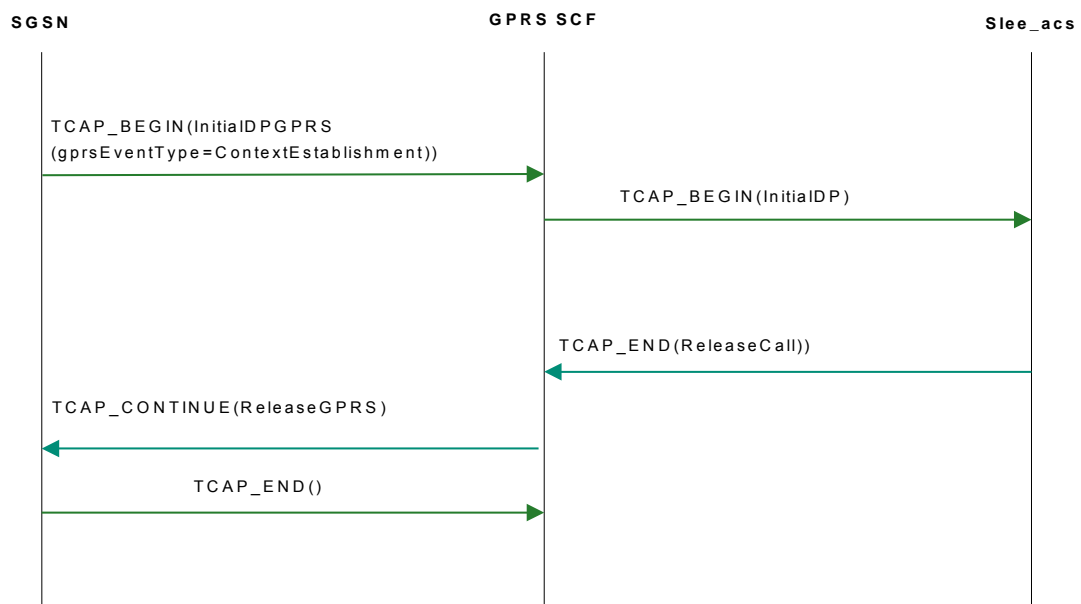

Message Flows for GPRS Sessions

Introduction to GPRS Sessions

This section details the message sequences that the CAP3GPRS Control Agent can produce for GPRS sessions. The message sequences start with an InitialDPGPRS for the session as a whole (rather than for individual PDP contexts). The CAP3GPRS Control Agent will not arm the ContextEstablishment or ContextEstablishmentAcknowledgement EDPs for these sessions. This means that billing for individual PDP contexts must be done by using separate InitialDPGPRS operations, and therefore the control agent will only charge for the session as a whole. The IDPGPRS.gprsEventType is 1 (attach) in all cases.

Note: Volume billing is not available for GPRS sessions.

Received ApplyCharging(releaseDurationExceeded)

Here is an example message sequence for a ApplyCharging(releaseDurationExceeded) operation received by the CAP3GPRS Control Agent.

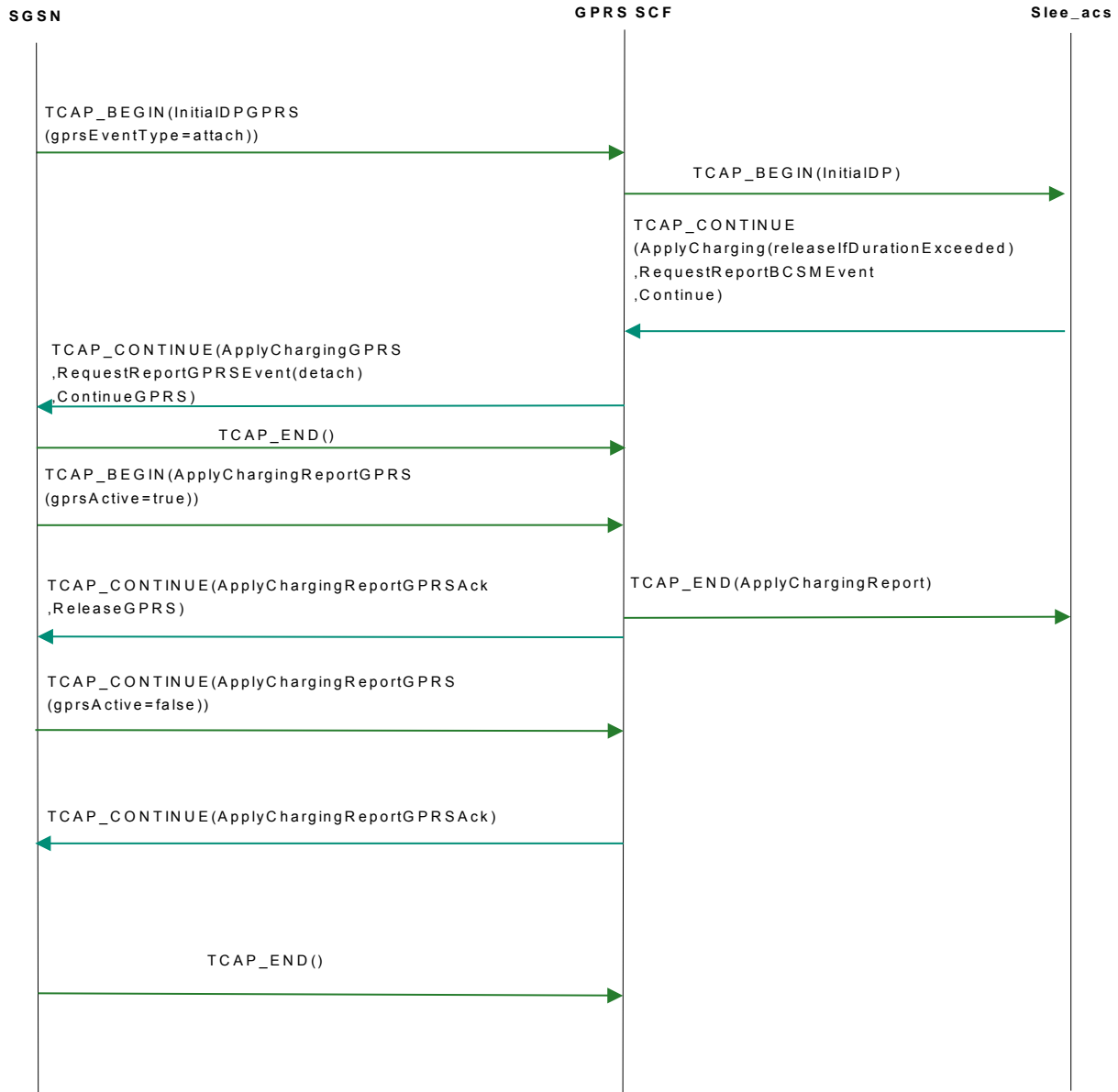

Credit Expiry, Example 2

Here is an example message sequence for credit expiry after several successful balance updates.

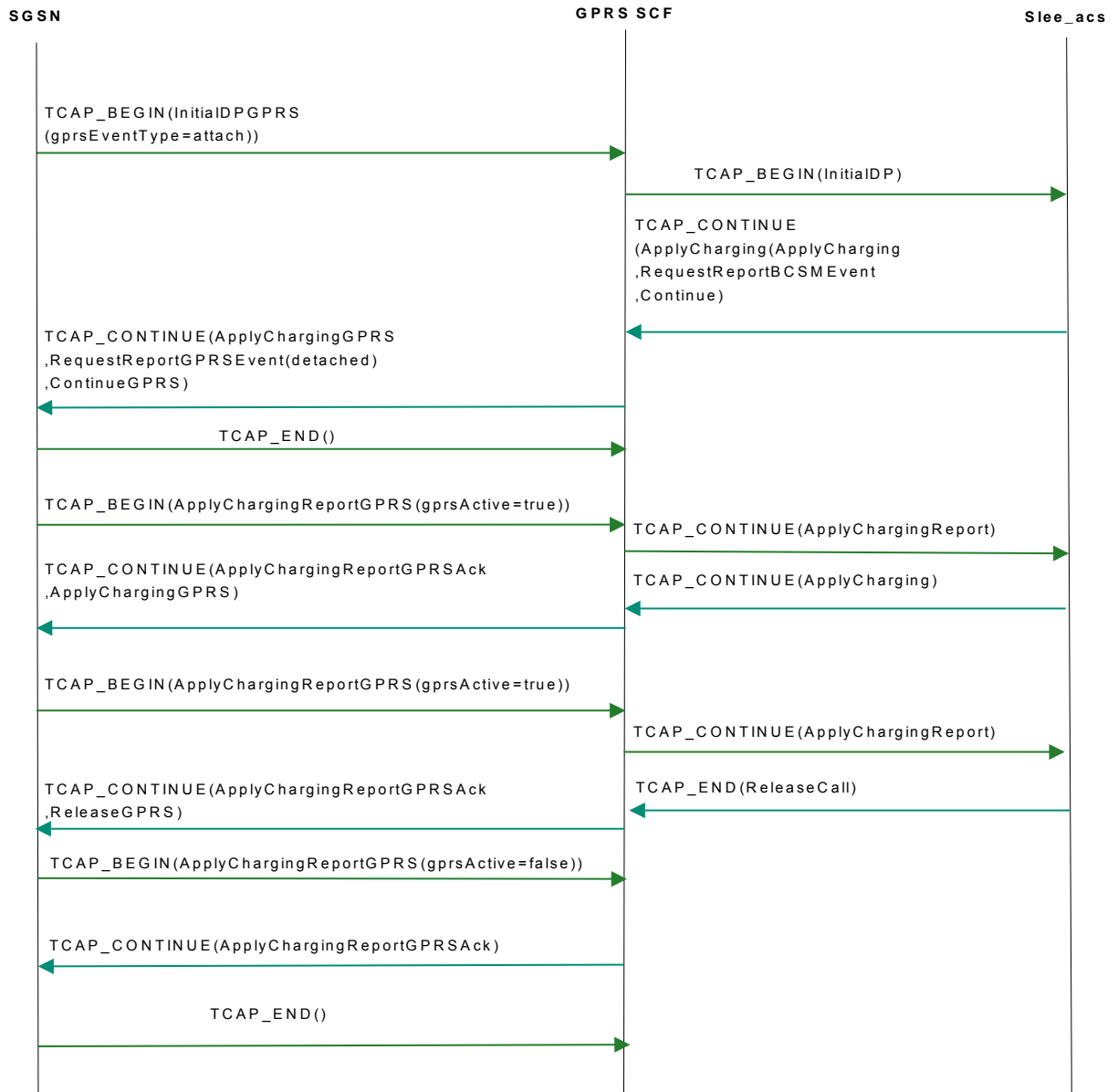

INAP Connect, New accessPointName with No Charging

Here is an example message sequence for INAP connect request that specifies new accessPointName with no charging. This shows what can happen when an error occurs during control plan processing. The CAP3GPRS protocol does not support changing accessPointName for event types other than ContextEstablishment and therefore aborts the dialog.

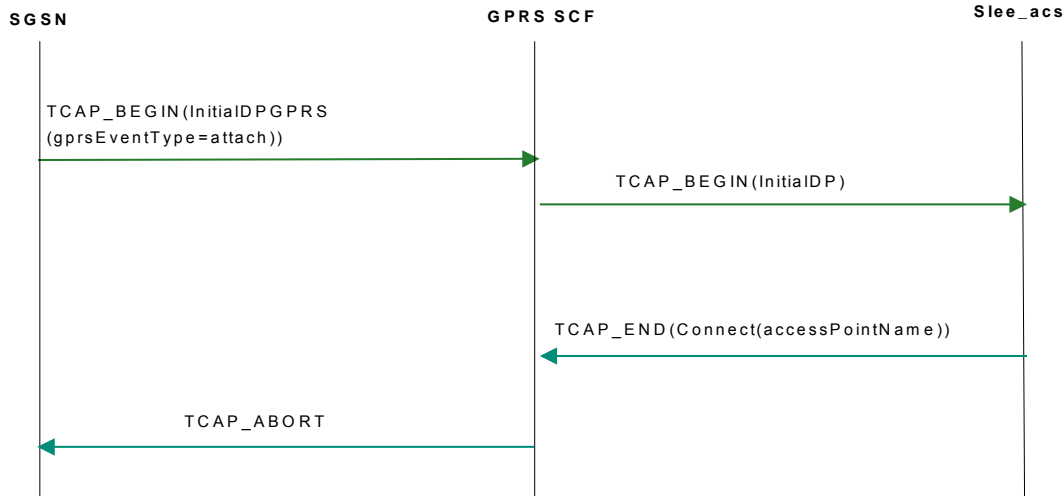

INAP Connect, New accessPointName, with Charging

Here is an example message sequence for INAP connect request that specifies new accessPointName with charging. This example shows what can happen when an error occurs during control plan processing. The CAP3GPRS protocol does not support changing accessPointName for event types other than ContextEstablishment and therefore aborts the dialog.

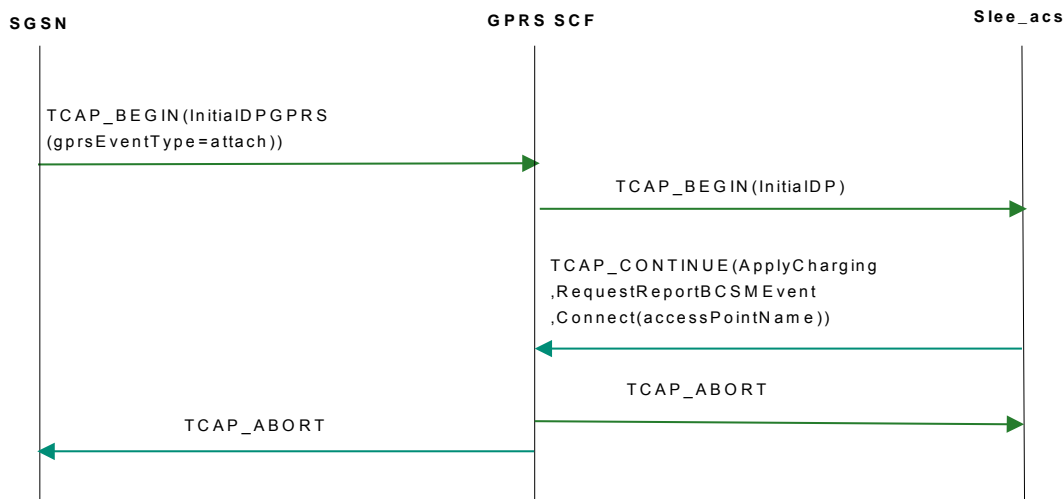

INAP Continue Received

Here is an example INAP continue received message sequence.

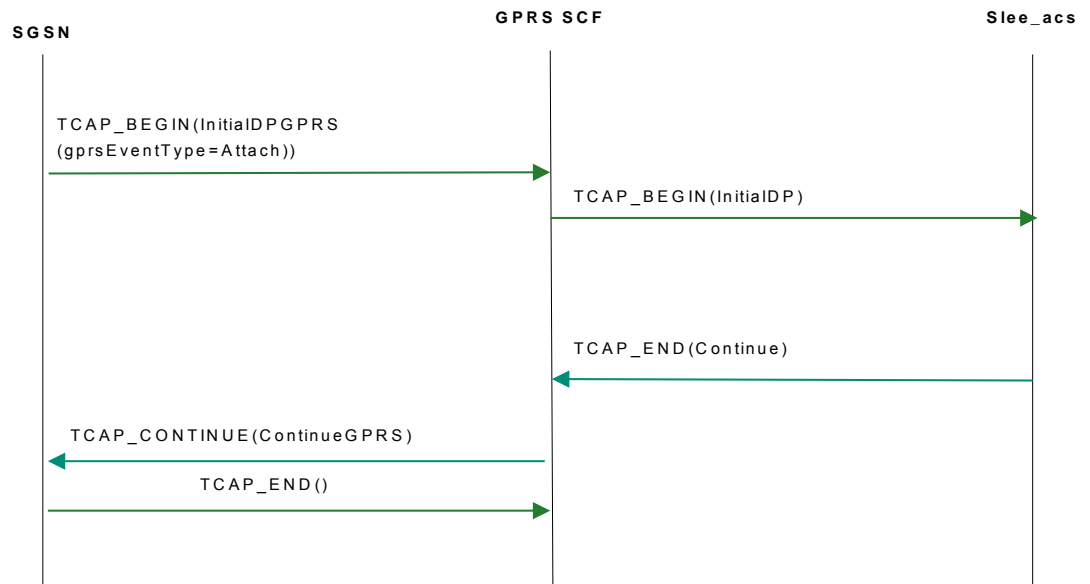

User Disconnects with Charging

Here is an example user disconnects with charging message sequence.

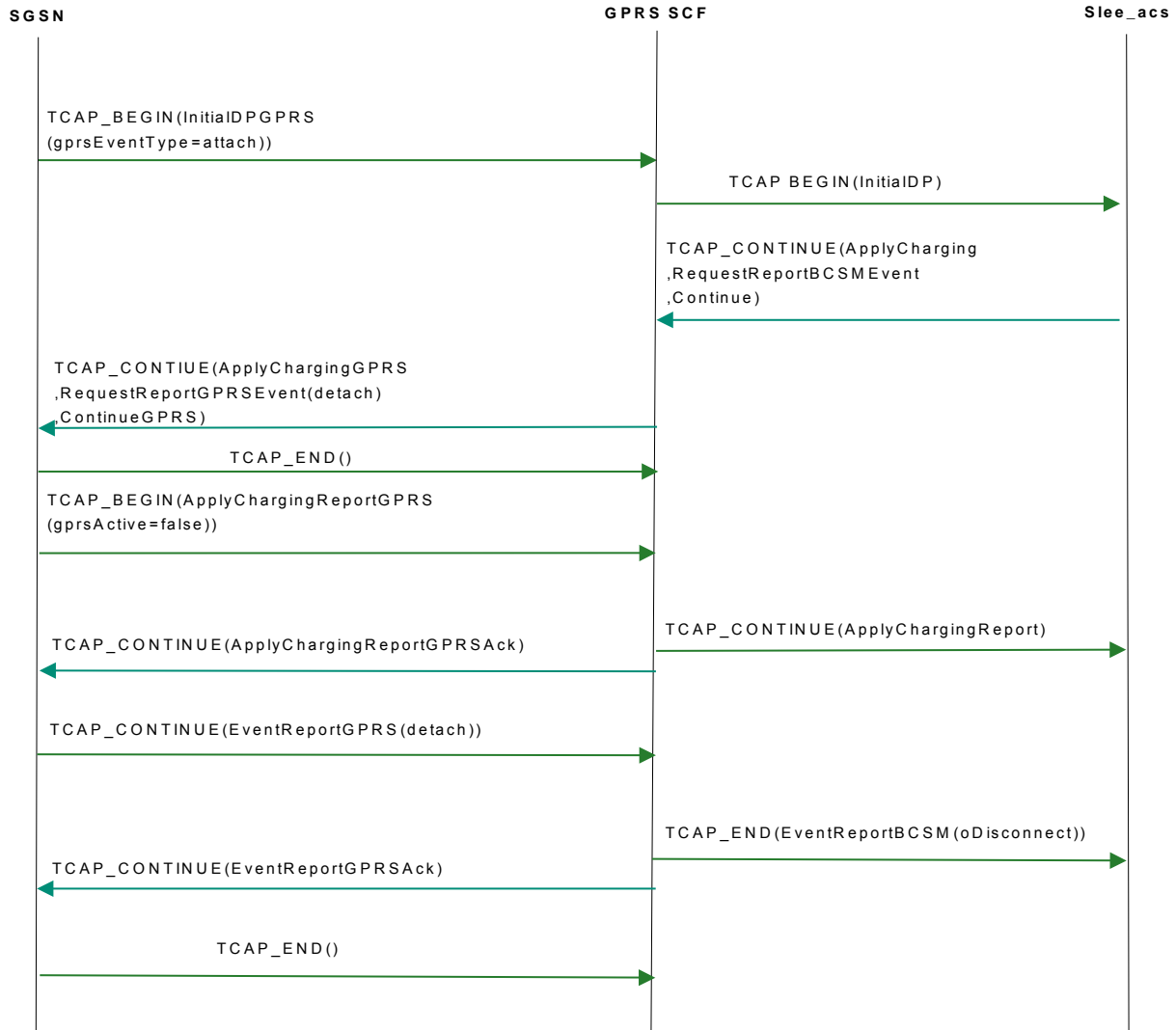

ReleaseCall Operation from slee_acs

Here is an example message sequence for a ReleaseCall operation received from slee_acs.

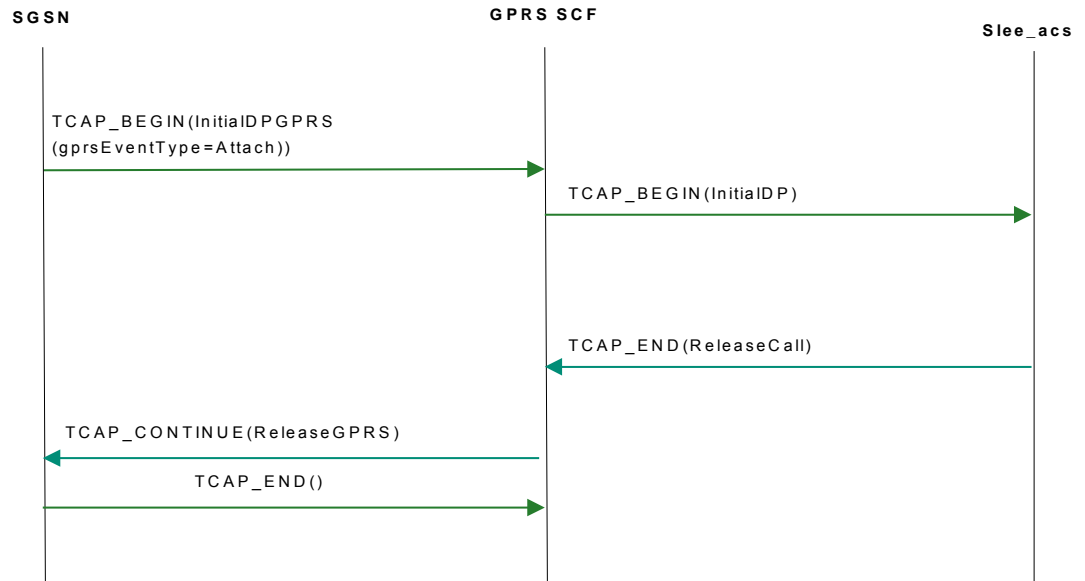

No Charging for Session

Here is an example message sequence for sessions with no charging.

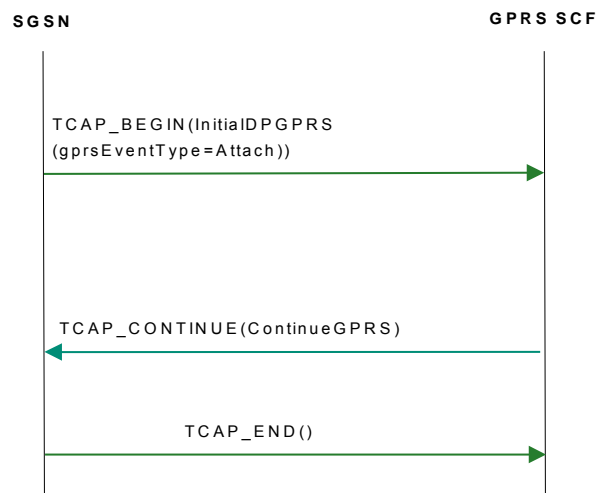

Activity Test Flows

Inactive Session Check

If a session has been inactive (no TCAP messages have been received) for longer than the maximum period configured for the operation timer, then the CAP3GPRS Control Agent sends an `ActivityTestGPRS` to the SGSN to determine whether the session is still open.

ActivityTestGPRS Message Sequence Example

Here is an example ActivityTestGPRS message sequence. The session is aborted if it is no longer active.

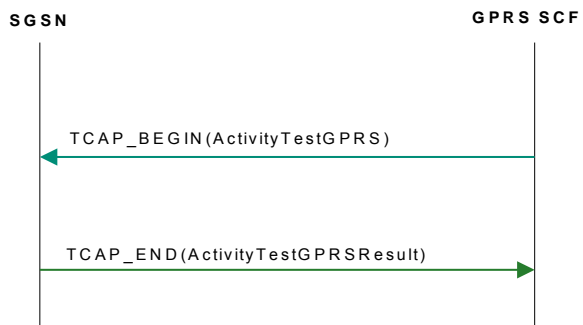

Troubleshooting

Overview

Introduction

This chapter explains how to investigate message sequences and memory leaks in the Oracle Communications Network Charging and Control (NCC) CAP version 3 GPRS Control Agent (CAP3GRPS Control Agent).

In this chapter

This chapter contains the following topics.

Message Sequences and Memory Leaks 47

Message Sequences and Memory Leaks

Determining the Message Sequence for a Session

This example explains how you can set the `Tracing.OrigAddress` and `Tracing.traceDebugLevel` parameters and then determine the message sequence for a session by starting a data session using a test phone.

Step	Action
1	Open the <code>eserv.config</code> configuration file, located in the <code>/IN/service_packages/</code> directory, in a text editor.
2	Set <code>Tracing.OrigAddress</code> to: <pre>OrigAddress = ["num"]</pre> Where <code>num</code> is your test phone number (that is, the calling number).
3	Set <code>Tracing.traceDebugLevel</code> to: <pre>cap3gprsMessageSequences</pre>
4	Save and close the <code>eserv.config</code> file.
5	Force the <code>cap3gprsControlAgent</code> to re-read its configuration by entering the following command: <pre>-kill -HUP pid</pre> Where <code>pid</code> is the PID for the <code>cap3gprsControlAgent</code> binary.
6	Start a data session using your test phone.
7	Look at the <code>cap3gprsControlAgent.log</code> file. You should see a line like this for each test session: <pre>SLEECALLID num GPRS SCF->slee_acs:TCAP_BEGIN(InitialDP)</pre> Where <code>num</code> is your test phone number.

Step	Action
8	<p>Copy the lines relevant to your test session to a text file and remove the first two columns. For example, type:</p> <pre>grep num sed 's/SLEECALLID[0-9]*//g' cap3gprsControlAgent.log > sequence.txt</pre> <p>Where <i>num</i> is your test phone number.</p> <p>Tip: All the lines relating to your test session will have the same SLEECALLID.</p>
9	<p>Use a web sequence diagrams tool, such as PlantUMLServer, to view the sequence chart for the message. See the documentation for the sequence diagrams tool for information on how to use it.</p>

Finding the Cause of a Memory Leak

To find the cause of a memory leak:

Step	Action
1	<p>Insert the following lines into the <code>cap3GprsControlAgent.sh</code> startup file immediately before the <code>exec</code> line:</p> <pre>DEBUG=cap3gprsObjectReport export DEBUG</pre>
2	<p>Ensure that a debug line is not written each time an object is created or deleted by adding the following line in the CAP3GPRS section of <code>eserv.config</code>:</p> <pre>minimumInstancesForObjectCounting = 1000</pre>
3	<p>Restart the SLEE by entering the following command as the user root:</p> <pre>SUPPORT/bin/slee-ctrl start</pre>

Each time the number of a particular type of object reaches a multiple of 1000, a line will be written to the log file detailing the number of this type of object. This will make any object that is leaking easy to identify.

Example cap3GprsControlAgent.sh Startup File

```
#!/usr/bin/bash
DEBUG=cap3gprsObjectReport
export DEBUG
exec /IN/service_packages/CAP3GPRS/bin/cap3GprsControlAgent >>
/IN/service_packages/CAP3GPRS/tmp/cap3GprsControlAgent.log
```

About Installation and Removal

Overview

Introduction

This chapter provides information about the installed components for the Oracle Communications Network Charging and Control (NCC) CAP version 3 GPRS Control Agent (CAP3GPRS Control Agent) and the CAP3GPRS files you can check for to ensure the control agent was successfully installed.

In this chapter

This chapter contains the following topics.

Installation and Removal Overview 49

Installation and Removal Overview

Introduction

For information about the following requirements and tasks, see *Installation Guide*:

- NCC system requirements
- Pre-installation tasks
- Installing and removing NCC packages

CAP3GPRS Control Agent Installed Packages

When you install the CAP3GPRS Control Agent, the following packages are installed:

- The cap3gprsSms package on the SMS node
- The cap3gprsScp package on the SLC node

Checking the cap3gprsSms Installation

Check that the following directories have been created on the SMS:

`/IN/service_packages/CAP3GPRS/db`

`/IN/service_packages/CAP3GPRS/lib`

Checking the cap3gprsScp Installation

Check that the following directories have been created on the SLC:

`/IN/service_packages/CAP3GPRS/bin`

`/IN/service_packages/CAP3GPRS/etc`

`/IN/service_packages/CAP3GPRS/lib`

`/IN/service_packages/CAP3GPRS/tmp`

Chapter 6

Check that the binary and the example configuration file for the CAP3GPRS Control Agent have been installed on the SLC:

/IN/services_packages/CAP3GPRS/bin/cap3GprsControlAgent

/IN/services_packages/CAP3GPRS/etc/eserv.config.example

Glossary of Terms

AAA

Authentication, Authorization, and Accounting. Specified in Diameter RFC 3588.

ACS

Advanced Control Services configuration platform.

ANI

Automatic Number Identification - Term used in the USA by long-distance carriers for CLI.

CAMEL

Customized Applications for Mobile network Enhanced Logic

This is a 3GPP (Third Generation Partnership Project) initiative to extend traditional IN services found in fixed networks into mobile networks. The architecture is similar to that of traditional IN, in that the control functions and switching functions are remote. Unlike the fixed IN environment, in mobile networks the subscriber may roam into another PLMN (Public Land Mobile Network), consequently the controlling function must interact with a switching function in a foreign network. CAMEL specifies the agreed information flows that may be passed between these networks.

CAP

CAMEL Application Part

CC

Country Code. Prefix identifying the country for a numeric international address.

CCS

- 1) Charging Control Services component.
- 2) Common Channel Signalling. A signalling system used in telephone networks that separates signalling information from user data.

CLI

Calling Line Identification - the telephone number of the caller. Also referred to as ANI.

Connection

Transport level link between two peers, providing for multiple sessions.

Diameter

A feature rich AAA protocol. Utilises SCTP and TCP transports.

DP

Detection Point

EDP

Event Detection Point.

FDA

First Delivery Attempt - the delivery of a short message directly to the SME rather than relaying it through the MC.

GPRS

General Packet Radio Service - employed to connect mobile cellular users to PDN (Public Data Network- for example the Internet).

GSM

Global System for Mobile communication.

It is a second generation cellular telecommunication system. Unlike first generation systems, GSM is digital and thus introduced greater enhancements such as security, capacity, quality and the ability to support integrated services.

HLR

The Home Location Register is a database within the HPLMN (Home Public Land Mobile Network). It provides routing information for MT calls and SMS. It is also responsible for the maintenance of user subscription information. This is distributed to the relevant VLR, or SGSN (Serving GPRS Support Node) through the attach process and mobility management procedures such as Location Area and Routing Area updates.

HPLMN

Home PLMN

IDP

INAP message: Initial DP (Initial Detection Point)

IMSI

International Mobile Subscriber Identifier. A unique identifier allocated to each mobile subscriber in a GSM and UMTS network. It consists of a MCC (Mobile Country Code), a MNC (Mobile Network Code) and a MSIN (Mobile Station Identification Number).

The IMSI is returned by the HLR query (SRI-SM) when doing FDA. This tells the MSC exactly who the subscriber is that the message is to be sent to.

IN

Intelligent Network

INAP

Intelligent Network Application Part - a protocol offering real time communication between IN elements.

Initial DP

Initial Detection Point - INAP Operation. This is the operation that is sent when the switch reaches a trigger detection point.

ISUP

ISDN User Part - part of the SS7 protocol layer and used in the setting up, management, and release of trunks that carry voice and data between calling and called parties.

ITU

International Telecommunication Union

MC

Message Centre. Also known as SMSC.

MCC

Mobile Country Code. In the location information context, this is padded to three digits with leading zeros. Refer to ITU E.212 ("Land Mobile Numbering Plan") documentation for a list of codes.

MNC

Mobile Network Code. The part of an international address following the mobile country code (MCC), or at the start of a national format address. This specifies the mobile network code, that is, the operator owning the address. In the location information context, this is padded to two digits with a leading zero. Refer to ITU E.212 ("Land Mobile Numbering Plan") documentation for a list of codes.

MS

Mobile Station

MSC

Mobile Switching Centre. Also known as a switch.

MSIN

Mobile Station Identification Number.

MT

Mobile Terminated

MTP

Message Transfer Part (part of the SS7 protocol stack).

PLMN

Public Land Mobile Network

SAI

Service Area Indicator. The 3G equivalent of a Cell ID. The smallest granularity (fourth component) of a location information field.

SCCP

Signalling Connection Control Part (part of the SS7 protocol stack).

SCF

Service Control Function - this is the application of service logic to control functional entities in providing Intelligent Network services.

SCTP

Stream Control Transmission Protocol. A transport-layer protocol analogous to the TCP or User Datagram Protocol (UDP). SCTP provides some similar services as TCP (reliable, in-sequence transport of messages with congestion control) but adds high availability.

Session

Diameter exchange relating to a particular user or subscriber access to a provided service (for example, a telephone call).

SGSN

Serving GPRS Support Node

SLC

Service Logic Controller (formerly UAS).

SLEE

Service Logic Execution Environment

SME

Short Message Entity - This is an entity which may send or receive short messages. It may be located in a fixed network, a mobile, or an SMSC.

SMS

Depending on context, can be:

- Service Management System hardware platform
- Short Message Service
- Service Management System platform
- NCC Service Management System application

SN

Service Number

SRI

Send Routing Information - This process is used on a GSM network to interrogate the HLR for subscriber routing information.

SS7

A Common Channel Signalling system is used in many modern telecoms networks that provides a suite of protocols which enables circuit and non-circuit related information to be routed about and between networks. The main protocols include MTP, SCCP and ISUP.

System Administrator

The person(s) responsible for the overall set-up and maintenance of the IN.

TCAP

Transaction Capabilities Application Part – layer in protocol stack, message protocol.

TCP

Transmission Control Protocol. This is a reliable octet streaming protocol used by the majority of applications on the Internet. It provides a connection-oriented, full-duplex, point to point service between hosts.

VLR

Visitor Location Register - contains all subscriber data required for call handling and mobility management for mobile subscribers currently located in the area controlled by the VLR.

VWS

Oracle Voucher and Wallet Server (formerly UBE).

Index

A

AAA • 51
About Installation and Removal • 49
About This Document • v
ACS • 51
acsCharging Parameters • 4
Activity Test Flows • 45
ActivityTestGPRS Message Sequence Example
• 46
activityTestResultTimeout • 10
addContinue • 5
addDisconnectOrRelease • 5
alarmOnLatency • 11
ANI • 51
ApplyCharging Report Profile Tags • 21
ApplyChargingReport.extensions Parameter •
21
armAllEdpsAtOnce • 8
armConnectEstablishAckOnContextChangeOfP
osition • 12
Audience • v

B

Background Processes • 27
Billing Using the UATB Feature Node • 1
billingType • 14

C

calledPartyNumber • 13
CAMEL • 51
CAP • 51
CAP3 GPRS Supported Operations • 29
CAP3 INAP Supported Operations • 29
CAP3GPRS Control Agent Installed Packages •
49
CAP3GPRS Control Agent SLEE Configuration
• 18
CAP3GPRS eserv.config Configuration • 3, 6,
27
CAP3GPRS Operations and Message
Sequences • 29
CAP3GPRS Parameters • 7
CAP3GPRS Statistics • 28
CAP3GPRS Statistics Reports • 28
cap3gprsControlAgent Process • 6, 27
CC • 51
CCS • 51
Checking the cap3gprsScp Installation • 49
Checking the cap3gprsSms Installation • 49
CLI • 51
Configuration • 3, 27
Configuration Components • 3
Configuration Overview • 3
Connect Profile Tags • 21

Connect.extensions Parameter • 21
Connection • 51
conversionFactor • 1, 14
Copyright • ii
Credit Expiry Example 1 • 32
Credit Expiry, Example 2 • 41

D

defaultBillingType • 8
defaultCalledPartyNumber • 8
defaultSessionTreatment • 8
DestAddress • 17
Determining the Message Sequence for a
Session • 47
Diameter • 51
displayMessageSequences • 9
Document Conventions • vi
DP • 51

E

EDP • 52
enabled • 17
eserv.config Configuration • 4
Example CAP3GPRS Section • 6
Example cap3GprsControlAgent.sh Startup File
• 48
Example Configuration • 18
Example Configuration File • 4

F

Failure • 27
FDA • 52
Finding the Cause of a Memory Leak • 9, 48
fromNoa • 15

G

GPRS • 52
GPRS Context Flows • 30
GPRS Parameters Received from the SGSN •
22
GPRS Parameters Sent to SGSN • 23
gprsServiceKey • 13
GSM • 52

H

HLR • 52
HPLMN • 52

I

IDP • 52
IDP Extensions Parameter • 19
IDP Profile Tags • 19
IMSI • 52
IN • 52
Inactive Session Check • 45
INAP • 52

- INAP Connect, New accessPointName with No Charging • 42
- INAP Connect, New accessPointName, with Charging • 34, 42
- INAP Connect, New accessPointName, with No Charging • 33
- INAP Continue Received • 35, 43
- INAP Parameters Received from slee_acs • 24
- INAP Parameters Sent to slee_acs • 23
- inapServiceKey • 13
- Incoming and Outgoing Session Data • 19
- Initial DP • 53
- Installation and Removal Overview • 49
- Introduction • 1, 3, 4, 6, 18, 19, 21, 27, 30, 49
- Introduction to GPRS Sessions • 39
- ISUP • 53
- ITU • 53

L

- latencyInterval • 11

M

- max • 15
- maxInactiveTimeForVolume • 10
- MC • 53
- MCC • 53
- Message Flows for GPRS Sessions • 39
- Message Sequences and Memory Leaks • 47
- min • 15, 16
- minimumInstancesForObjectCounting • 9
- MNC • 53
- MS • 53
- MSC • 53
- MSIN • 53
- MT • 53
- MTP • 53

N

- No Charging for Session • 45
- NumberRules Parameters • 15

O

- OrigAddress • 17
- Overview • 1, 3, 27, 29, 47, 49

P

- Parameter Mappings • 21
- PDP Context Detached, Example 1 • 37
- PDP Context Detached, Example 2 • 38
- PLMN • 53
- prefix • 16
- prepend • 16
- Prerequisites • v
- Purpose • 27

R

- Received
 - ApplyCharging(releaseDurationExceeded) • 40
- Received
 - ApplyCharging(releaseSelfDurationExceeded) • 30
- Related Documents • v
- ReleaseCall Operation from slee_acs • 45
- ReleaseCall Operation Received from slee_acs • 38
- releaseCauseInsufficientFunds • 11
- releaseCauseNetworkError • 11
- remove • 15, 16

S

- SAI • 54
- SCCP • 54
- SCF • 54
- Scope • v
- SCTP • 54
- sendAbortForDetachEventType • 12
- sendAbortForDisconnectEventType • 12
- sendContinueWithApplyCharging • 7
- sendContinueWithRRGPRSE • 7
- SERVICEKEY values • 18
- serviceName • 13
- Services Parameters • 12
- Session • 54
- sessionTreatment • 14
- SGSN • 54
- SLC • 54
- SLEE • 54
- SLEE.cfg Configuration • 3, 18, 27
- sleepTimeMicroseconds • 7
- sleeServiceKey • 13
- SME • 54
- SMS • 54
- SN • 54
- SRI • 55
- SS7 • 55
- Startup • 27
- Statistics Logged by the CAP3GPRS Control Agent • 27
- Supported CAP3 GPRS and CAP3 INAP Operations • 29
- Switch Type Configuration for CAP3GPRS • 3, 4
- switchConfiguration • 4
- switchType • 5
- System Administrator • 55
- System Overview • 1
- System Overview Diagram • 2

T

- targetNoa • 16

TCAP • 55
tcapInterfaceName • 10
TCP • 55
timeBillingInactiveTimeTolerance • 10
traceDebugLevel • 17
Tracing Parameters • 16
Troubleshooting • 47
tssf • 10
Typographical Conventions • vi

U

User Disconnects with Charging • 36, 44

V

VLR • 55
VWS • 55

W

What is the CAP3GPRS Control Agent? • 1