

**Oracle® Communications  
Network Charging and Control**

Subscriber Event Service User's and Technical Guide

Release 12.0.0

December 2017

# Copyright

Copyright © 2017, Oracle and/or its affiliates. All rights reserved.

This software and related documentation are provided under a license agreement containing restrictions on use and disclosure and are protected by intellectual property laws. Except as expressly permitted in your license agreement or allowed by law, you may not use, copy, reproduce, translate, broadcast, modify, license, transmit, distribute, exhibit, perform, publish, or display any part, in any form, or by any means. Reverse engineering, disassembly, or decompilation of this software, unless required by law for interoperability, is prohibited.

The information contained herein is subject to change without notice and is not warranted to be error-free. If you find any errors, please report them to us in writing.

If this is software or related documentation that is delivered to the U.S. Government or anyone licensing it on behalf of the U.S. Government, then the following notice is applicable:

U.S. GOVERNMENT END USERS: Oracle programs, including any operating system, integrated software, any programs installed on the hardware, and/or documentation, delivered to U.S. Government end users are "commercial computer software" pursuant to the applicable Federal Acquisition Regulation and agency-specific supplemental regulations. As such, use, duplication, disclosure, modification, and adaptation of the programs, including any operating system, integrated software, any programs installed on the hardware, and/or documentation, shall be subject to license terms and license restrictions applicable to the programs. No other rights are granted to the U.S. Government.

This software or hardware is developed for general use in a variety of information management applications. It is not developed or intended for use in any inherently dangerous applications, including applications that may create a risk of personal injury. If you use this software or hardware in dangerous applications, then you shall be responsible to take all appropriate fail-safe, backup, redundancy, and other measures to ensure its safe use. Oracle Corporation and its affiliates disclaim any liability for any damages caused by use of this software or hardware in dangerous applications.

Oracle and Java are registered trademarks of Oracle and/or its affiliates. Other names may be trademarks of their respective owners.

Intel and Intel Xeon are trademarks or registered trademarks of Intel Corporation. All SPARC trademarks are used under license and are trademarks or registered trademarks of SPARC International, Inc. AMD, Opteron, the AMD logo, and the AMD Opteron logo are trademarks or registered trademarks of Advanced Micro Devices. UNIX is a registered trademark of The Open Group.

This software or hardware and documentation may provide access to or information about content, products, and services from third parties. Oracle Corporation and its affiliates are not responsible for and expressly disclaim all warranties of any kind with respect to third-party content, products, and services unless otherwise set forth in an applicable agreement between you and Oracle. Oracle Corporation and its affiliates will not be responsible for any loss, costs, or damages incurred due to your access to or use of third-party content, products, or services, except as set forth in an applicable agreement between you and Oracle.

# Contents

|  |           |
|--|-----------|
| About This Document .....                              | v         |
| Document Conventions .....                             | vi        |
| <b>Chapter 1</b>                                       |           |
| <b>System Overview .....</b>                           | <b>1</b>  |
| Overview .....   | 1         |
| Subscriber Event Service .....                         | 1         |
| <b>Chapter 2</b>                                       |           |
| <b>Getting Started .....</b>                           | <b>13</b> |
| Overview .....   | 13        |
| Accessing Subscriber Event Service Configuration ..... | 13        |
| <b>Chapter 3</b>                                       |           |
| <b>SES Configuration Screens .....</b>                 | <b>17</b> |
| Overview .....   | 17        |
| Messages .....   | 17        |
| Inbound General Messages .....                         | 21        |
| Inbound Messages .....                                 | 23        |
| Outbound General Messages .....                        | 25        |
| Outbound Messages .....                                | 28        |
| Trigger Rules .....                                    | 30        |
| Contact History .....                                  | 34        |
| <b>Chapter 4</b>                                       |           |
| <b>Using SES Feature Nodes .....</b>                   | <b>39</b> |
| Overview .....   | 39        |
| Example Control Plan - In-Roamer .....                 | 39        |
| Example Control Plan - Out-Roamer .....                | 40        |
| <b>Chapter 5</b>                                       |           |
| <b>Configuration .....</b>                             | <b>43</b> |
| Overview .....   | 43        |
| eserv.config Configuration .....                       | 43        |
| sesTrigger .....                                       | 44        |
| macroNodes .....                                       | 55        |
| dbCleanup .....  | 58        |
| serviceLibrary .....                                   | 59        |
| SLEE.cfg Configuration .....                           | 59        |
| acs.conf Configuration .....                           | 60        |
| <b>Chapter 6</b>                                       |           |
| <b>Background Processes .....</b>                      | <b>61</b> |
| Overview .....   | 61        |
| dbCleanup .....  | 61        |

|                  |    |
|------------------|----|
| Statistics ..... | 61 |
| Replication..... | 62 |

## **Chapter 7**

### **About Installation and Removal ..... 67**

|  |    |
|--|----|
| Overview.....                          | 67 |
| Installation and Removal Overview..... | 67 |

### **Glossary of Terms..... 69**

### **Index..... 75**

# About This Document

## Scope

The scope of this document includes all functionality a user must know in order to effectively install and operate the Subscriber Event Service application. It does not include detailed design of the service.

## Audience

This guide is written primarily for Subscriber Event Service administrators. However, the overview sections of the document are useful to anyone requiring an introduction.

## Prerequisites

A solid understanding of UNIX and a familiarity with IN concepts are an essential prerequisite for safely using the information contained in this technical guide. Attempting to install, remove, configure or otherwise alter the described system without the appropriate background skills, could cause damage to the system; including temporary or permanent incorrect operation, loss of service, and may render your system beyond recovery.

Although it is not a prerequisite to using this guide, familiarity with the target platform would be an advantage. See also the relevant standards, for example, Q713.

This manual describes system tasks that should only be carried out by suitably trained operators.

## Related Documents

The following documents are related to this document:

- *Service Management System Technical Guide*
- *Control Plan Editor User's Guide*
- *Service Logic Execution Environment Technical Guide*

# Document Conventions

## Typographical Conventions

The following terms and typographical conventions are used in the Oracle Communications Network Charging and Control (NCC) documentation.

| Formatting Convention                    | Type of Information  |
|--|--|
| <b>Special Bold</b>                      | Items you must select, such as names of tabs.<br>Names of database tables and fields.  |
| <i>Italics</i>                           | Name of a document, chapter, topic or other publication.<br>Emphasis within text.  |
| <b>Button</b>                            | The name of a button to click or a key to press.<br><b>Example:</b> To close the window, either click <b>Close</b> , or press <b>Esc</b> .       |
| <b>Key+Key</b>                           | Key combinations for which the user must press and hold down one key and then press another.<br><b>Example:</b> <b>Ctrl+P</b> or <b>Alt+F4</b> . |
| Monospace                                | Examples of code or standard output.   |
| <b>Monospace Bold</b>                    | Text that you must enter.  |
| <i>variable</i>                          | Used to indicate variables or text that should be replaced with an actual value.   |
| <b>menu option &gt; menu option &gt;</b> | Used to indicate the cascading menu option to be selected.<br><b>Example:</b> <b>Operator Functions &gt; Report Functions</b>                    |
| <a href="#">hypertext link</a>           | Used to indicate a hypertext link.   |

Specialized terms and acronyms are defined in the glossary at the end of this guide.

# System Overview

## Overview

### Introduction

This chapter explains what the Subscriber Event Service is and how it works.

### In this chapter

---

This chapter contains the following topics.

|                                |   |
|--------------------------------|---|
| Subscriber Event Service ..... | 1 |
|--------------------------------|---|

## Subscriber Event Service

### Introduction

The Subscriber Event Service (SES) enables a service provider to send text messages to roaming subscribers (both their own and foreign subscribers) when they roam in and out of their network.

For example, a network operator may wish to greet all in-bound roamers with a "Welcome to our network", or "Thank you for using our network" message to all out-roaming subscribers.

Messages can be used to convey anything the network operator wants, for instance, advising of cheap rates at certain times of day.

### In-Roaming diagram

This diagram shows the sequence of network activities that occur when a subscriber enters your network.

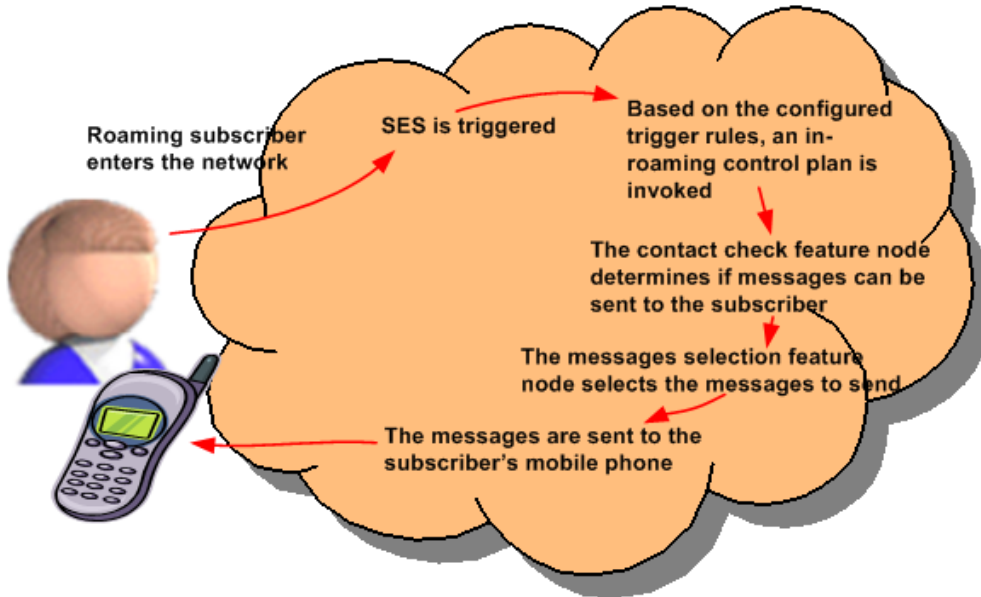

### Out-Roaming diagram

This diagram shows the sequence of network activities that occur when a subscriber leaves your network.

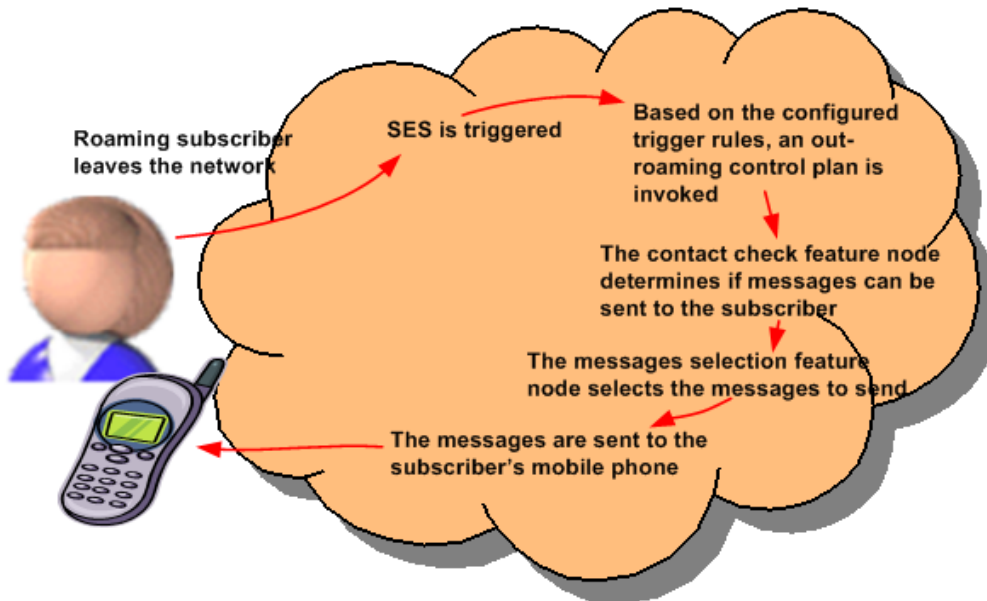



## Network diagram

This diagram shows how the NCC SLC receives notification that a subscriber is roaming.

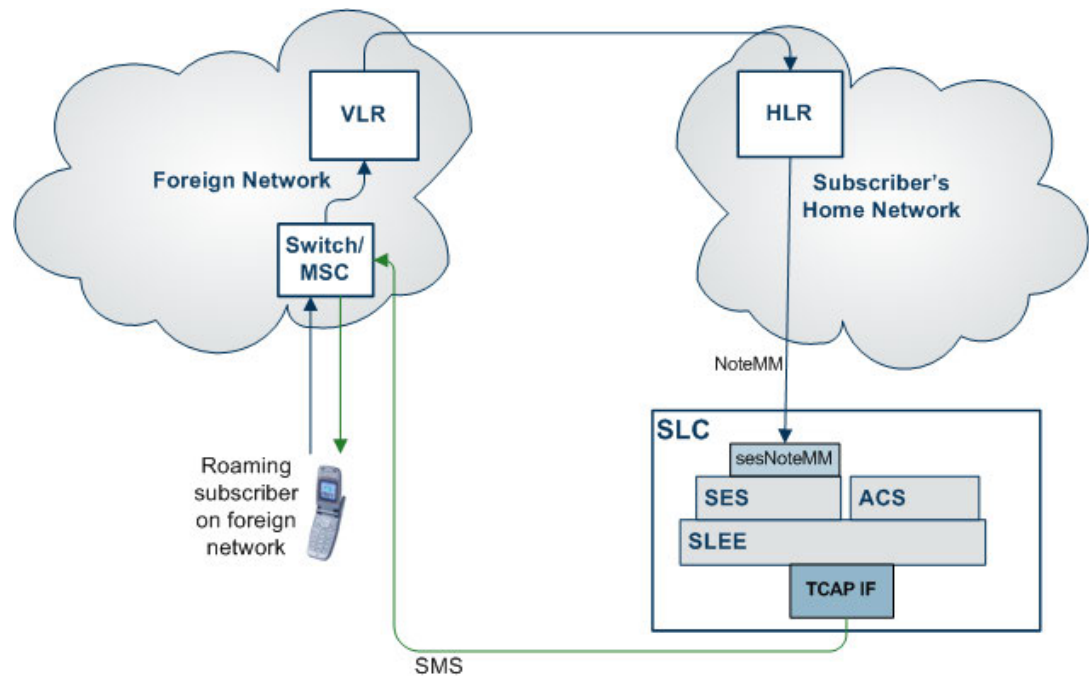

## Message rules

The messages can be configured as priority or non-priority. When selecting messages to send, all the priority messages are selected before any non-priority messages. The number of messages to select and send is configurable.

Messages can also be configured as general (they can be sent to any subscriber), or non-general (they can only be sent to specific subscribers, based on country code (MCC) and network code (MNC) of the subscriber).

## Example scenarios

In this example the messages available have been configured as priority or non priority messages for country/ network code as follows:

| Priority Messages | Country - network code | Non Priority Messages | Country - network code |
|-------------------|------------------------|-----------------------|------------------------|
| Welcome from 123  | 123 - 98               | Free texting          | 531 - 01               |
| Welcome from 531  | 531 - 01               | Cheap text day        | any                    |
| Cut rate calls    | 123 - 98               | Extra minutes         | any                    |
| Flybys            | any                    | Easy top up           | any                    |
| Secure PIN        | any                    | Cheaper text          | any                    |
| Outages           | any                    | Local weather         | any                    |
| Upgrade deals     | any                    |                       |                        |

## Chapter 1

The inbound general messages set up using the **Inbound General Messages** (on page 21) tab are:

| Priority Messages | Non Priority Messages |
|-------------------|-----------------------|
| Flybys            | Cheap text day        |
| Secure PIN        | Extra minutes         |

The inbound network specific messages set up using the **Inbound Messages** (on page 23) tab are:

| Priority Messages | Non Priority Messages |
|-------------------|-----------------------|
| Welcome from 123  | Free texting          |
| Welcome from 531  |                       |

The outbound general messages set up using the **Outbound General Messages** (on page 25) tab are:

| Priority Messages | Non Priority Messages |
|-------------------|-----------------------|
| Flybys            | Easy top up           |
| Secure PIN        | Cheaper text          |
| Outages           | Local weather         |
| Upgrade deals     |                       |

The outbound network specific messages set up using the **Outbound Messages** (on page 28) tab are:

| Priority Messages | Non Priority Messages |
|-------------------|-----------------------|
| Cut rate calls    | Free texting          |

**Note:** The same messages can be used in any of the inbound/ outbound lists.

The maximum number of inbound messages has been configured at four.

The maximum number of outbound messages has been configured at five.

The days since contact is configured at two days.

## Example in-roaming control plan

Here is the example in-roaming control plan used in scenarios 1 and 2.

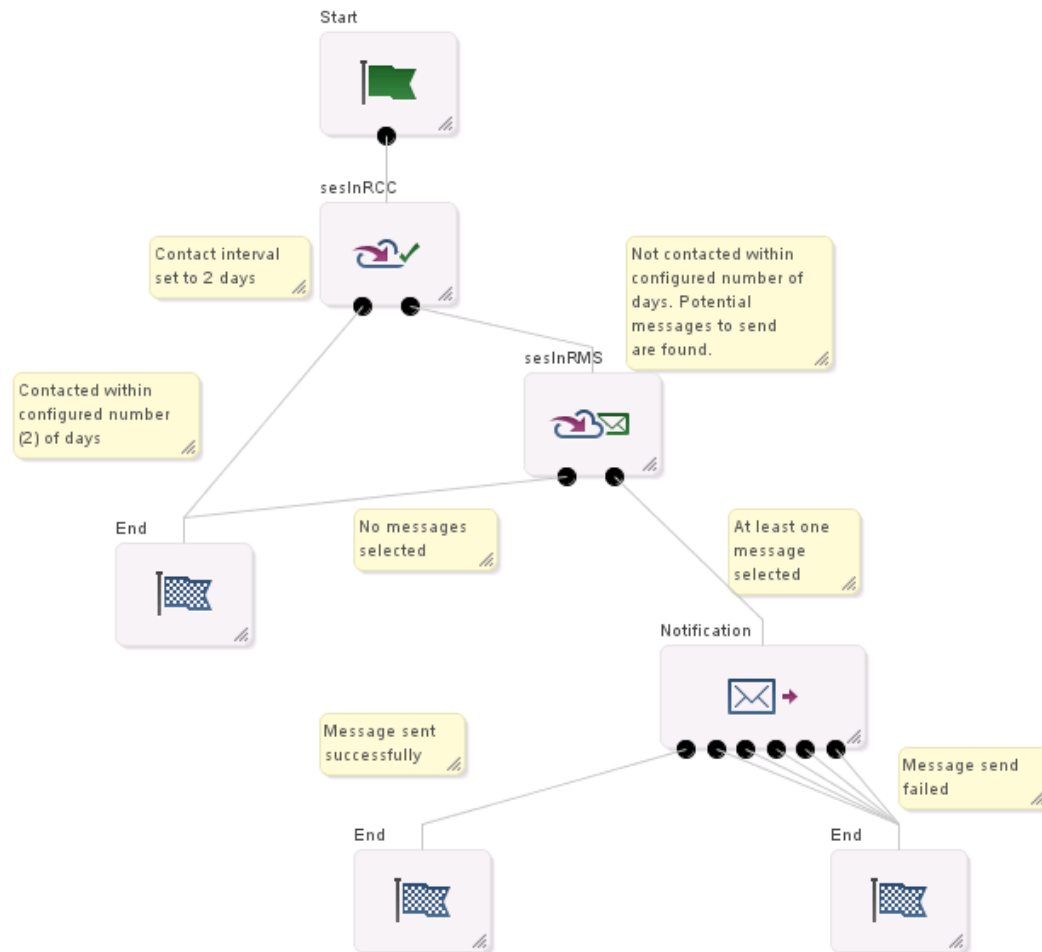

For more information about:

- Control plans, see *CPE User's Guide*
- SES feature nodes, see *Feature Nodes Reference Guide*

## Scenario 1

A roaming subscriber enters the network from a non specific country and network. The message selection in the control plan is based on latest available.

The following actions occur:

| Step | Action   |
|------|--|
| 1    | SES is triggered by the network.   |
| 2    | The control plan using the In-Roamer Contact Check and In-Roamer Messages Selection feature nodes is executed.   |
| 3    | If, within the configured two days, the subscriber: <ul style="list-style-type: none"> <li>• Has been contacted, the 'Contacted' branch on the In-Roamer Contact Check feature node is taken and the subscriber gets no messages.</li> <li>• Has not been contacted, the 'Not Contacted' exit is taken.</li> </ul> |

| Step | Action  |
|------|---|
| 4    | Two lists of messages (priority and non priority) are created from the inbound general messages list, based on the maximum number of messages to be sent, specified in the In-Roamer Messages Selection feature node, and the priority assigned to the message. In this example the list consists of the messages: <ul style="list-style-type: none"> <li>• Flybys (priority general message)</li> <li>• Secure PIN (priority general message)</li> <li>• Cheap text day (non priority message)</li> <li>• Extra minutes (non priority message).</li> </ul> |
| 5    | The messages are sent to the subscriber.  |

## Scenario 2

A roaming subscriber enters the network from country code 531 and network code 01. The message selection in the control plan is based on latest available.

The following actions occur:

| Step | Action   |
|------|--|
| 1    | SES is triggered by the network.   |
| 2    | The control plan using the In-Roamer Contact Check and In-Roamer Messages Selection feature nodes is executed.   |
| 3    | If, within the configured two days, the subscriber: <ul style="list-style-type: none"> <li>• Has been contacted, the 'Contacted' branch on the In-Roamer Contact Check feature node is taken and the subscriber gets no messages.</li> <li>• Has not been contacted, the 'Not Contacted' exit is taken.</li> </ul>   |
| 4    | Two lists of messages (priority and non priority) are created from both the inbound messages and inbound general messages lists, based on the maximum number of messages to be sent, specified in the In-Roamer Messages Selection feature node, and the priority assigned to the message. In this example the list consists of the messages: <ul style="list-style-type: none"> <li>• Welcome from 531 (priority specific 531 country message)</li> <li>• Flybys (priority general message)</li> <li>• Secure PIN (priority general message)</li> <li>• Free texting (non priority specific 531 country message)</li> </ul> |
| 5    | The messages are sent to the subscriber.   |

### Example out-roaming control plan

Here is the example control plan used in scenarios 3, 4, and 5.

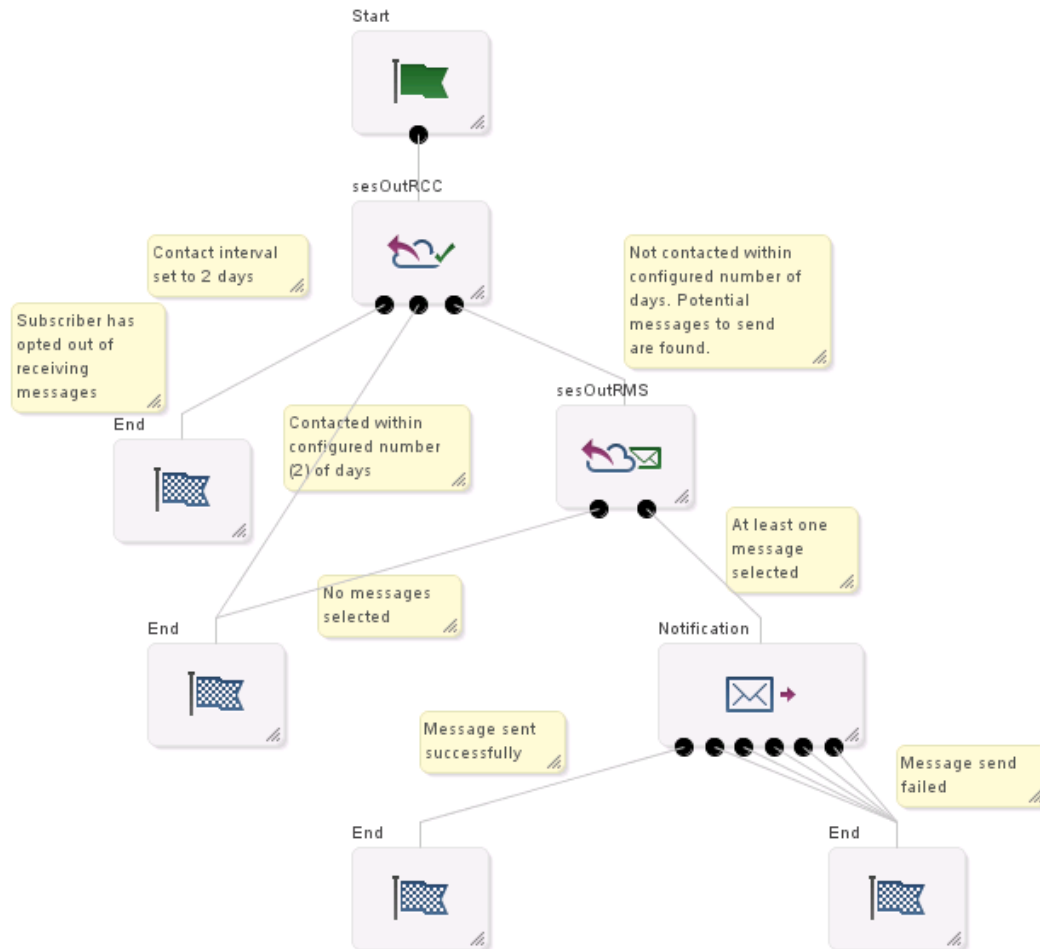

For more information about:

- Control plans, see *CPE User's Guide*
- SES feature nodes, see *Feature Nodes Reference Guide*

### Scenario 3

A roaming subscriber leaves the network to a specific country (531) and network (01). The message selection in the control plan is based on latest available.

The following actions occur:

| Step | Action  |
|------|---|
| 1    | SES is triggered by the network.  |
| 2    | The control plan using the Out-Roamer Contact Check and Out-Roamer Messages Selection feature nodes is executed.  |
| 3    | If the subscriber: <ul style="list-style-type: none"> <li>• Has been contacted within the configured two days, the 'Contacted' branch on the Out-Roamer Contact Check feature node is taken and the subscriber gets no messages.</li> </ul> |

| Step | Action  |
|------|---|
|      | <ul style="list-style-type: none"> <li>Has opted out, the 'Opted Out' exit is taken and the subscriber gets no messages.</li> <li>Has not been contacted within the configured two days, the 'Not Contacted' exit is taken.</li> </ul>  |
| 4    | <p>Two lists of messages (priority and non priority) are created from both the outbound messages and outbound general messages lists, based on the maximum number of messages to be sent, specified in the Out-Roamer Messages Selection feature node, and the priority assigned to the message.</p> <p>In this example the list consists of the messages:</p> <ul style="list-style-type: none"> <li>Cut rate calls (priority specific 531 country message)</li> <li>Flybys (priority general message)</li> <li>Secure PIN (priority general message)</li> <li>Outages (priority general message)</li> <li>Upgrade deals (priority general message).</li> </ul> <p><b>Note:</b> The message limit stops any of the general non priority messages being sent.</p> |
| 5    | The messages are sent to the subscriber.  |

## Scenario 4

A roaming subscriber leaves the network to a country and network not specified in SES. The message selection in the control plan is based on latest available.

The following actions occur:

| Step | Action  |
|------|---|
| 1    | SES is triggered by the network.  |
| 2    | The control plan using the Out-Roamer Contact Check and Out-Roamer Messages Selection feature nodes is executed.  |
| 3    | <p>If the subscriber:</p> <ul style="list-style-type: none"> <li>Has been contacted within the configured two days, the 'Contacted' branch on the Out-Roamer Contact Check feature node is taken and the subscriber gets no messages.</li> <li>Has opted out, the 'Opted Out' exit is taken and the subscriber gets no messages.</li> <li>Has not been contacted within the configured two days, the 'Not Contacted' exit is taken.</li> </ul>  |
| 4    | <p>Two lists of messages (priority and non priority) are created from the outbound general messages list, based on the maximum number of messages to be sent, specified in the Out-Roamer Messages Selection feature node, and the priority assigned to the message.</p> <p>In this example the list consists of the messages:</p> <ul style="list-style-type: none"> <li>Flybys (priority general message)</li> <li>Secure PIN (priority general message)</li> <li>Outages (priority general message)</li> <li>Upgrade deals (priority general message)</li> <li>Easy top up (non-priority general message to fulfill the message count).</li> </ul> |
| 5    | The messages are sent to the subscriber.  |

## Scenario 5

A roaming subscriber leaves the network to a specific country (531) and network (01). The message selection in the control plan is based on random.

The following actions occur:

| Step | Action  |
|------|---|
| 1    | SES is triggered by the network.  |
| 2    | The control plan using the Out-Roamer Contact Check and Out-Roamer Messages Selection feature nodes is executed.  |
| 3    | <p>If the subscriber:</p> <ul style="list-style-type: none"> <li>• has been contacted within the configured two days, the 'Contacted' branch on the Out-Roamer Contact Check feature node is taken and the subscriber gets no messages.</li> <li>• Has opted out, the 'Opted Out' exit is taken and the subscriber gets no messages.</li> <li>• Has not been contacted within the configured two days, the 'Not Contacted' exit is taken.</li> </ul>  |
| 4    | Two lists of messages (priority and non priority) are created from both the outbound messages and outbound general messages lists, based on the maximum number of messages to be sent, specified in the Out-Roamer Messages Selection feature node, and the priority assigned to the message.   |
| 5    | <p>A selection is made randomly from the priority lists until the message count is reached or the list is exhausted.</p> <p>In this case a random selection creates a list like:</p> <ul style="list-style-type: none"> <li>• Cut rate calls (priority specific 531 country message)</li> <li>• Flybys (priority general message)</li> <li>• Secure PIN (priority general message)</li> <li>• Outages (priority general message)</li> <li>• Upgrade deals (priority general message)</li> </ul> <p><b>Note:</b> The message limit for this example stops any of the non priority messages being sent.</p> |
| 6    | <p>A further selection is made randomly from the non priority lists until the message count is reached or the list is exhausted.</p> <p>In this example the final list could consist of messages:</p> <ul style="list-style-type: none"> <li>• Free texting (non priority specific 531 country message)</li> <li>• Easy top up (non priority general message)</li> <li>• Cheaper text (non priority general message)</li> <li>• Local weather (non priority general message)</li> </ul>   |
| 7    | The messages are sent to the subscriber.  |

## Architectural diagram

Here is a diagram of the Subscriber Event Service architecture.

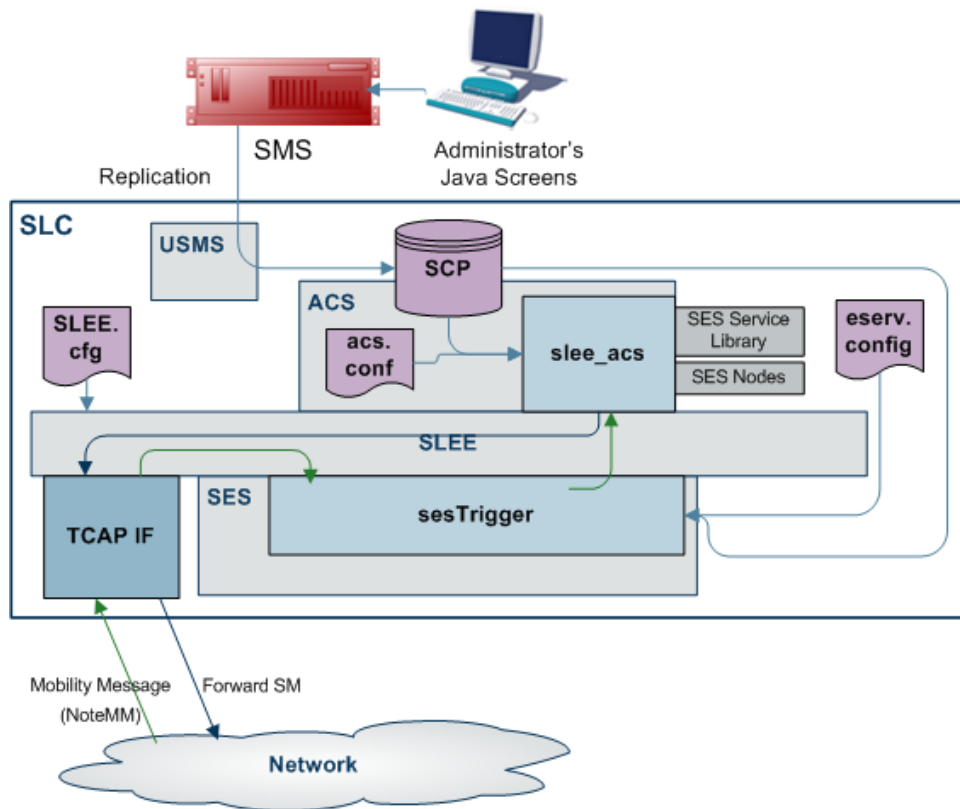

## SES configuration diagram

This diagram shows the three configuration areas to fully enable SES.



**Note:** The Trigger Rules used depend on the contents of the `databaseLogin` parameter. If present and has a value, the SES trigger rules from the `eserv.config` are used, if missing or empty, the SES Configuration rules on the **Trigger Rules** (on page 30) tab are used.

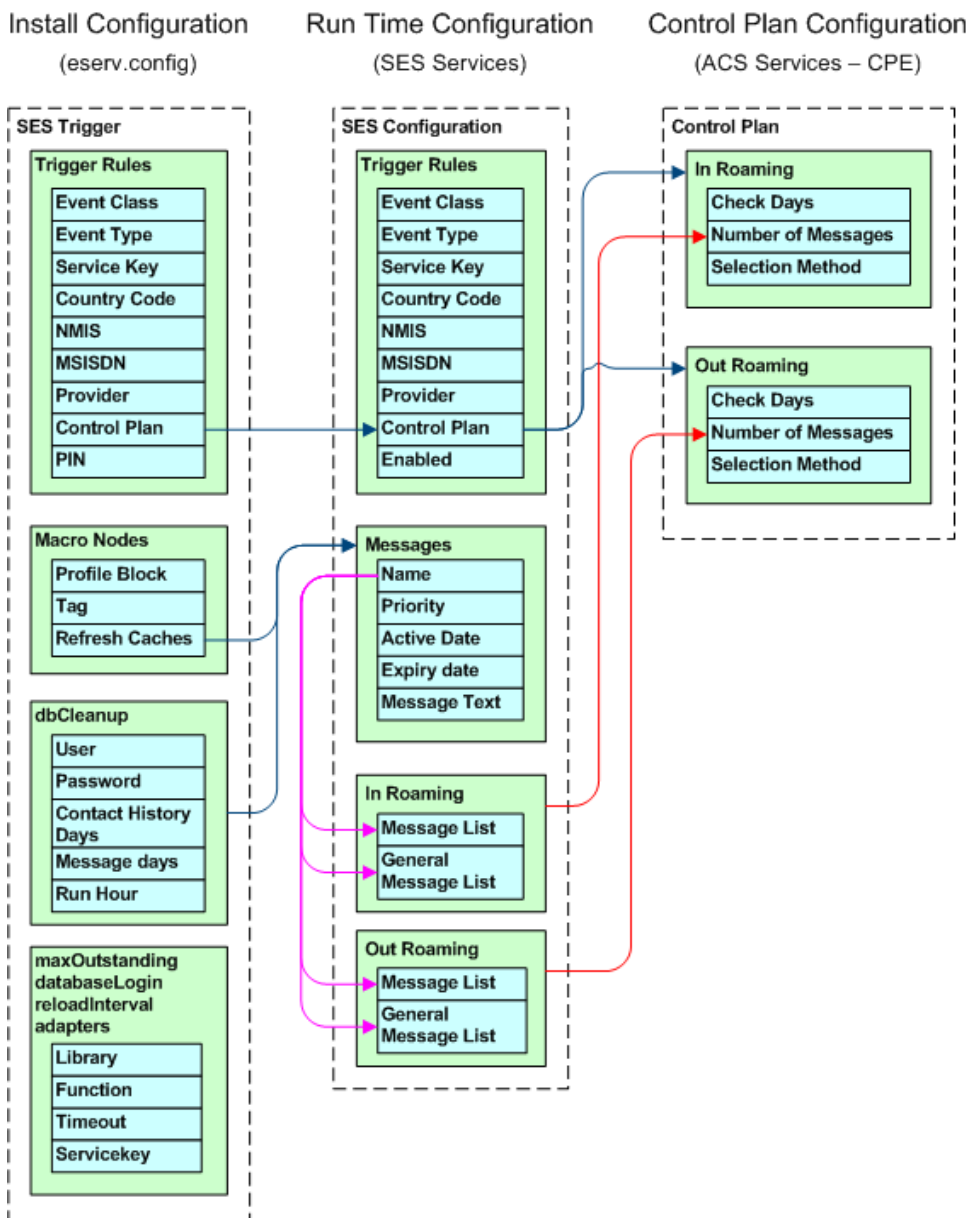



# Getting Started

## Overview

### Introduction

This chapter explains how to access the Subscriber Event Service configuration screens.

### In this chapter

---

This chapter contains the following topics.

Accessing Subscriber Event Service Configuration ..... 13

## Accessing Subscriber Event Service Configuration

### Accessing SMS

To access Service Management System, launch the application using the Webstart icon of the SMS machine that SES has been installed on.

For more information, see *SMS User's Guide*.

After a short while the login screen appears.

## SMS Login screen

Here is an example of the SMS Login screen.



## Logging into SMS

Follow these steps to log into SMS.

| Step | Action   |
|------|--|
| 1    | In the <b>User Name</b> field, type your username.   |
| 2    | In the <b>Password</b> field, type your password.  |
|      | <b>Notes:</b> <ul style="list-style-type: none"> <li>• Passwords are case sensitive.</li> <li>• You have three attempts to enter a correct username and password before the User ID is locked. If this happens, you must see your System Administrator to re-activate it.</li> </ul> |
| 3    | Click <b>OK</b> .<br><b>Result:</b> You see the Service Management System main screen.   |

## Accessing SES

Follow these steps to access the SES configuration screens.

| Step | Action  |
|------|---|
| 1    | Select the <b>Services &gt; SES Service</b> menu options. |

| Step | Action |
|------|--------|
|------|--------|

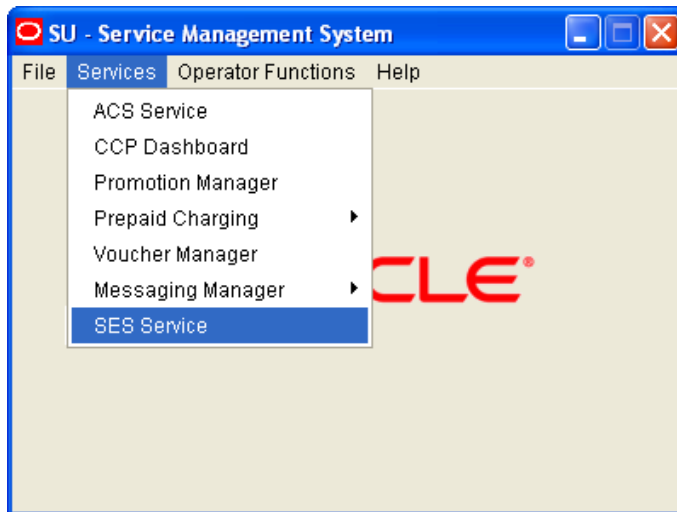

**Result:** You see the SES Configuration screen, defaulting to the Trigger Rules tab.

### General screen information

The contents of screen records can be sorted by single clicking the column heading to sort by.

The status bar at the bottom of the screen shows update details for the row selected.

**Example:**

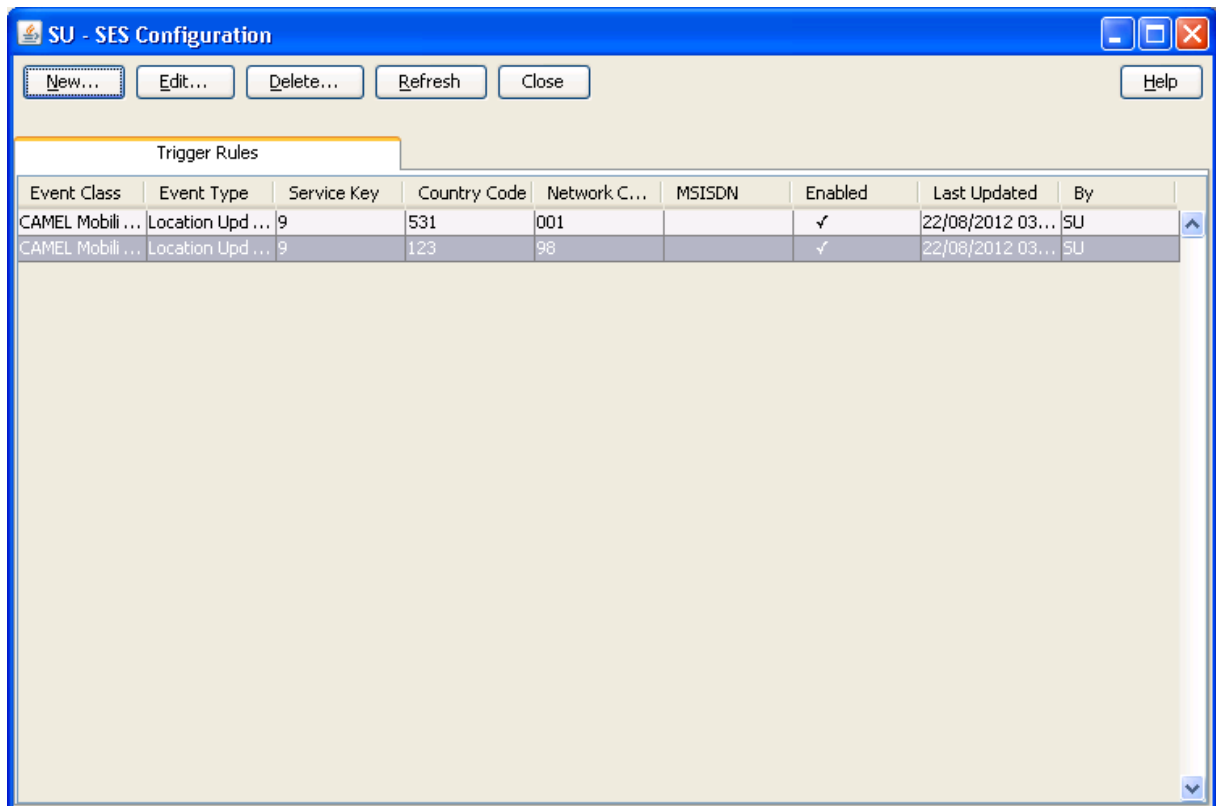



# SES Configuration Screens

## Overview

### Introduction

This chapter explains the functions of each SES configuration screen.

The topics are presented in the recommended sequence of configuration.

### In this chapter

---

This chapter contains the following topics.

|                                |    |
|--------------------------------|----|
| Messages .....                 | 17 |
| Inbound General Messages ..... | 21 |
| Inbound Messages .....         | 23 |
| Outbound General Messages..... | 25 |
| Outbound Messages .....        | 28 |
| Trigger Rules .....            | 30 |
| Contact History .....          | 34 |

## Messages

### Introduction

This tab is enables you to configure all the messages available within SES, including their availability dates and whether they are priority or not. You must add messages using this tab first, so that they will be available on the other message tabs.

There are two types of messages that a handset roaming into or out of the network can receive:

- General messages: those that can be sent to any handset
- Messages: those that can be sent to country and network specific handsets

## Messages tab

Here is an example of the **Messages** tab.

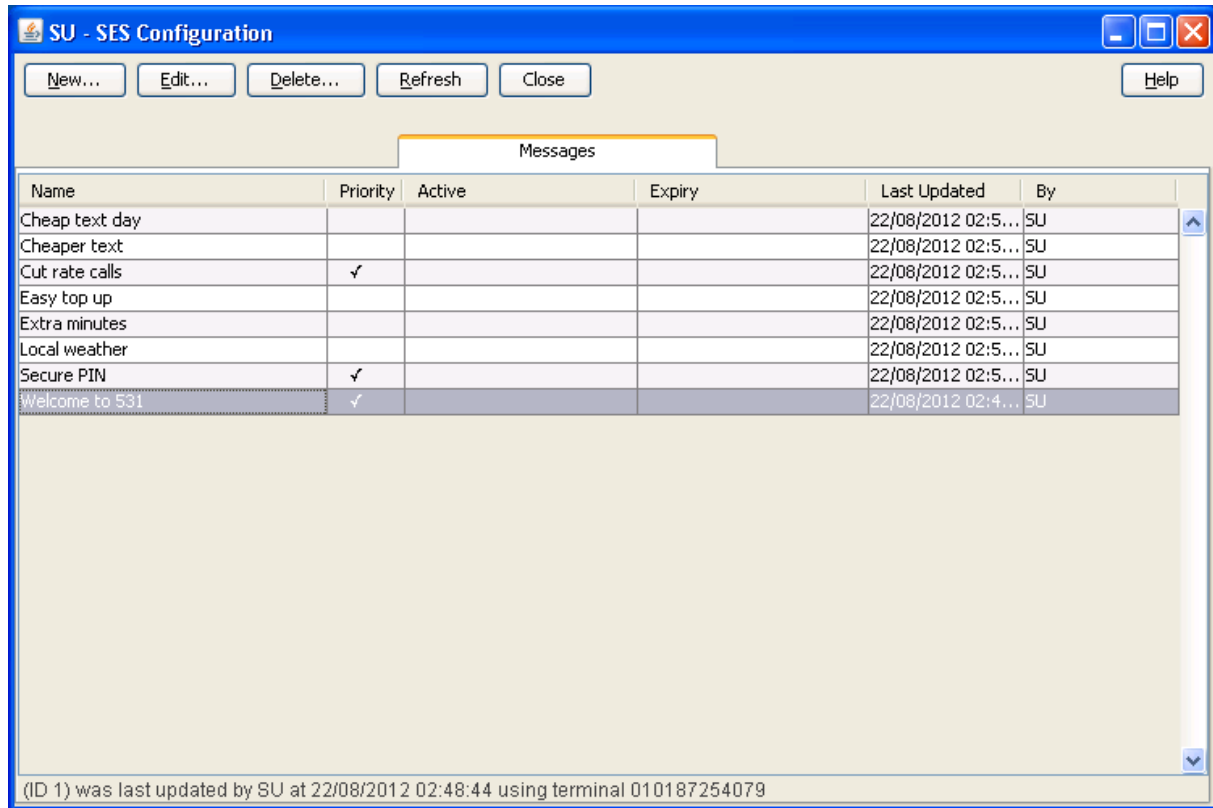

### Messages tab columns

This table describes the content of each column.

| Field        | Description   |
|--------------|---|
| Name         | A user friendly message name.   |
| Priority     | Indicates if this message is priority or not priority.<br><b>Note:</b> Priority messages are always looked at first to fulfill the number to send parameter, see Inbound/Outbound Roaming Messages. |
| Active       | When the message was (will be) available for selection.   |
| Expiry       | When the message was (will be) unavailable for selection.   |
| Last Updated | Date and time stamp for the last update to this message.  |
| By           | Username of user that made the last update.   |

**Note:** The Activity, Expiry and Last Updated times are in relation to the time zone configured for SMS. (See *Service Management System Technical Guide*).

### Adding new messages

Follow these steps to add new messages.

| Step | Action                          |
|------|---------------------------------|
| 1    | Select the <b>Messages</b> tab. |



| Step | Action |
|------|--------|
|------|--------|

**Result:** The current messages are listed.

2 Click **New....**

**Result:** The New Message screen appears.

3 Enter a message **Name**. This name should be meaningful and descriptive for a user, for example "Free texting".

4 Select the **Priority** check box, if required, to make this a priority message. This means it will be selected before non-priority messages.

5 To:

- Set an availability date and time for this message, select the **Active** check box.  
**Result:** The **Wait until** date and time boxes become available. Enter or select the relevant values.
- Make the message available immediately, deselect the **Active** check box.

6 To:

- Set an expiry date and time for this message, select the **Expiry** check box.  
**Result:** The **Expires on** date and time boxes become available. Enter or select the relevant values.
- Make the message never expire, deselect the **Expiry** check box. It can be edited later if required.

7 Enter the text of the message that will be sent to a subscriber.

**Tip:** The maximum message length is 120 ASCII characters.

**Result:** The **Save** button becomes available.

8 Click **Save**.

## Editing messages

Follow these steps to edit messages.

| Step | Action   |
|------|--|
| 1    | Select the <b>Messages</b> tab.<br><b>Result:</b> The current messages are listed. |
| 2    | In the table, select the message to edit.  |
| 3    | Click <b>Edit...</b><br><b>Result:</b> The Edit Message screen appears.            |

|   |   |
|---|---|
| 4 | Make the required changes to the fields, as described in <i>Adding new messages</i> (on page 18). |
| 5 | Click <b>Save</b> .   |

## Deleting messages

Follow these steps to delete messages.

| Step | Action  |
|------|---|
| 1    | Select the <b>Messages</b> tab.<br><b>Result:</b> The current messages are listed.  |
| 2    | In the table, select the message to delete.<br><b>Warning:</b> You should only delete messages that have expired.<br>Expired messages are automatically deleted by <i>dbCleanup</i> (on page 58) after a configured number of days. |
| 3    | Click <b>Delete...</b><br><b>Result:</b> The Delete Message confirmation screen appears.  |
| 4    | Click <b>Delete</b> .   |

## Inbound General Messages

### Introduction

This tab allows you to set up the available messages that can be sent to any subscriber inbound to the network, as against messages that are matched on country and network codes.

### Inbound General Messages tab

Here is an example of the Inbound General Messages tab.

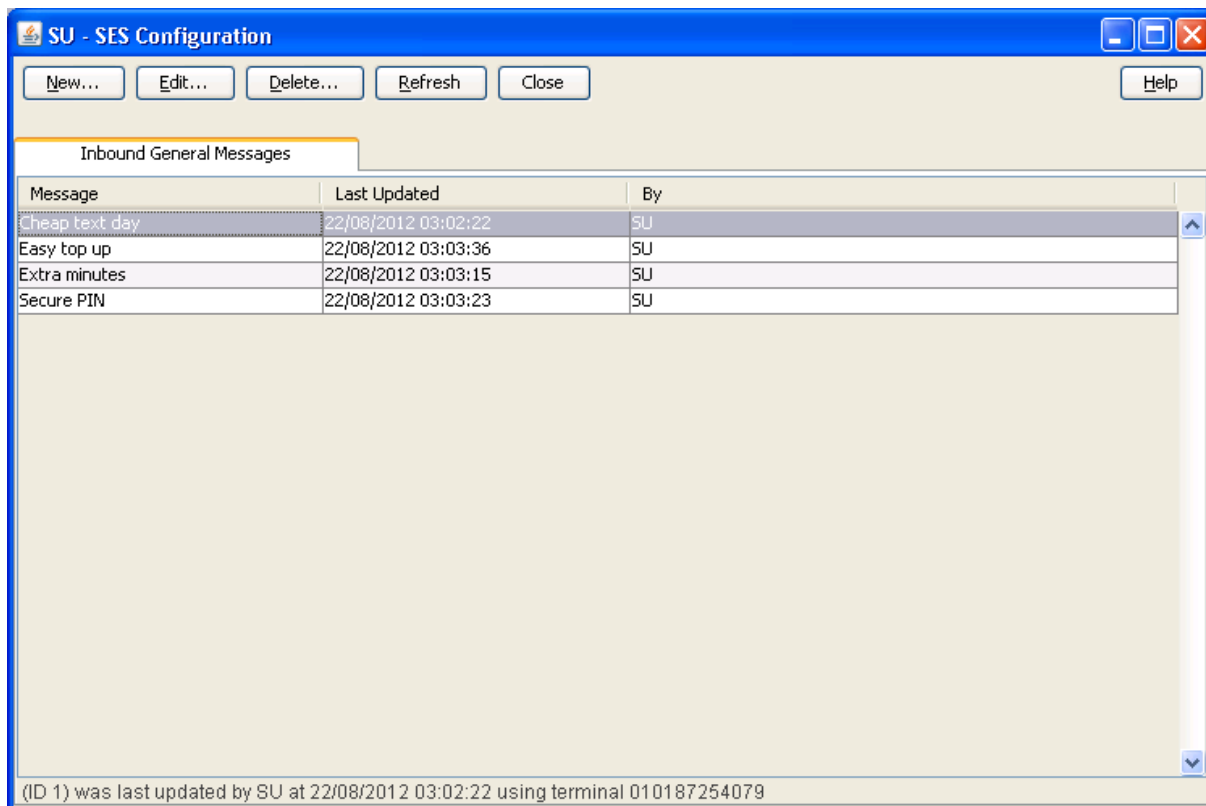

### Inbound general messages tab columns

This table describes the content of each column.

| Field        | Description  |
|--------------|--|
| Message      | The message name.  |
| Last Updated | Date and time stamp for the last update to this message (SMS time zone value). |
| By           | Username of user that made the last update.                                    |

### Adding new inbound general messages

Follow these steps to add new inbound general messages.

| Step | Action  |
|------|---|
| 1    | Select the <b>Inbound General Messages</b> tab. |

| Step | Action |
|------|--------|
|------|--------|

- Result:** The current inbound general messages are listed.
- 2 Click **New....**  
**Result:** The New Inbound General Message screen appears.

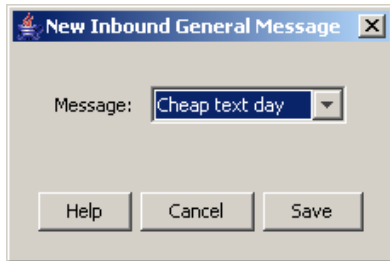

- 3 Select the required **Message** from the drop down list.  
**Tip:** This is the list of messages maintained on the **Messages tab** (on page 17).
- 4 Click **Save**.

### Editing inbound general messages

Follow these steps to change an existing inbound general message.

| Step | Action |
|------|--------|
|------|--------|

- 1 Select the **Inbound General Messages** tab.  
**Result:** The current inbound general messages are listed.
- 2 In the table, select the message to edit.
- 3 Click **Edit....**  
**Result:** The Edit Inbound General Message screen appears.

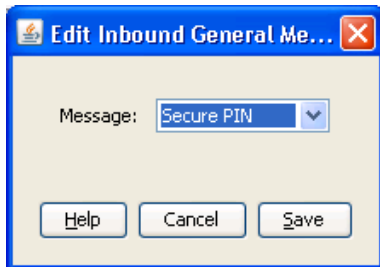

- 4 Select the required **Message** from the drop down list.
- 5 Click **Save**.

### Deleting inbound general messages

Follow these steps to delete inbound general messages.

| Step | Action |
|------|--------|
|------|--------|

- 1 Select the **Inbound General Messages** tab.  
**Result:** The current inbound general messages are listed.
- 2 In the table, select the message to delete.
- 3 Click **Delete....**  
**Result:** The Delete Inbound General Message screen appears.
- 4 Click **Delete**.

## Inbound Messages

### Introduction

This tab allows you to set up the available messages that can be sent to a subscriber inbound to the network from a specific country and network, as against general messages that are not matched on country and network codes.

### Inbound Messages tab

Here is an example of the **Inbound Messages** tab.

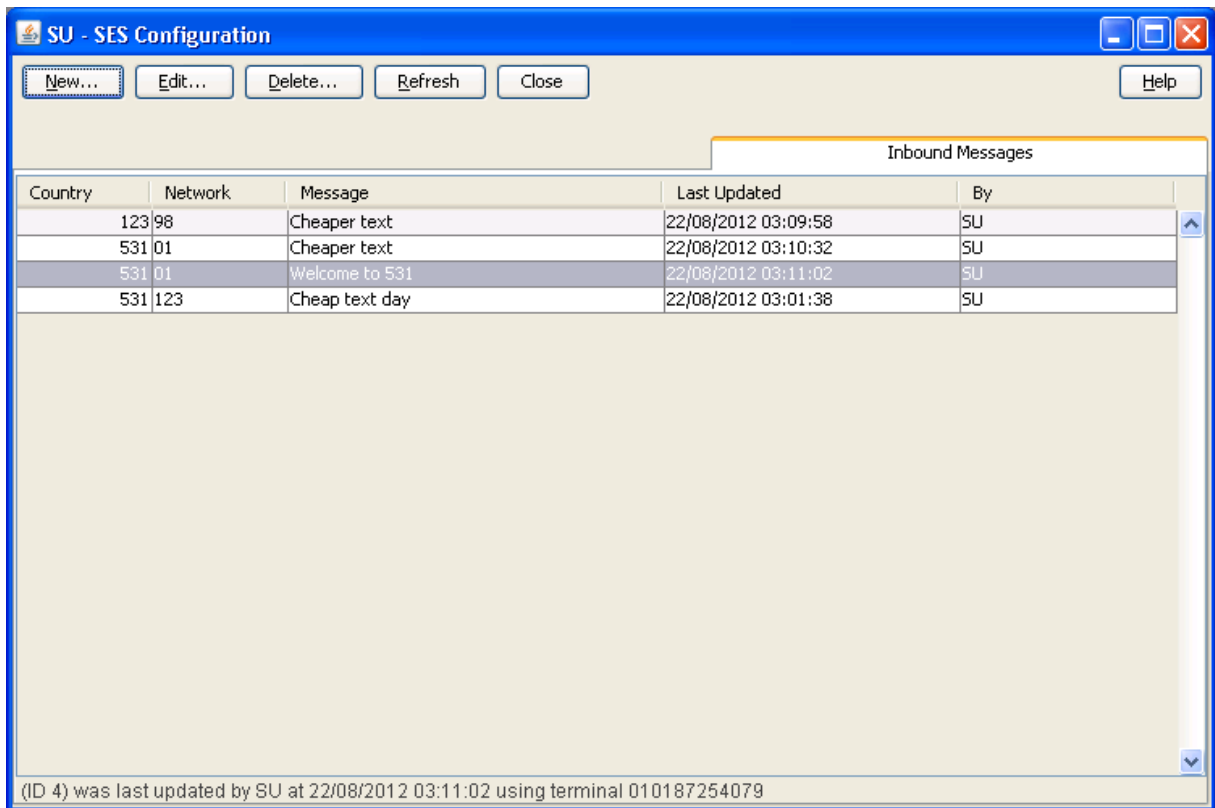

### Inbound messages tab columns

This table describes the content of each column.

| Field        | Description  |
|--------------|--|
| Country      | The country code the subscriber has just roamed from.                          |
| Network      | The network the subscriber has just roamed from.                               |
| Message      | The message name.  |
| Last Updated | Date and time stamp for the last update to this message (SMS time zone value). |
| By           | Username of user that made the last update.                                    |

## Adding new inbound messages

Follow these steps to add new inbound messages.

| Step | Action   |
|------|--|
| 1    | Select the <b>Inbound Messages</b> tab.<br><b>Result:</b> The current inbound messages are listed. |
| 2    | Click <b>New....</b><br><b>Result:</b> The New Inbound Network Specific Message screen appears.    |

|   |   |
|---|---|
| 3 | Enter the <b>Country Code</b> (MCC) to associate with the message.  |
| 4 | Enter the <b>Network Code</b> (MNC) to associate with the message.<br><b>Warning:</b> You must input the code with the correct number of leading zeroes, for example 01 (2-digit MNC), or 123 (3 digit MNC)<br><b>Result:</b> The <b>Save</b> button becomes available. |
| 5 | Select the <b>Message</b> to associate with the Country and Network Code from the drop down list.<br><b>Tip:</b> This is the list of messages maintained on the <b>Messages</b> tab (on page 17).   |
| 6 | Click <b>Save</b> .<br><b>Note:</b> For a list of MCC and MNC, refer to ITU E.212 ("Land Mobile Numbering Plan") documentation.   |

## Editing inbound messages

Follow these steps to edit an existing inbound message.

| Step | Action   |
|------|--|
| 1    | Select the <b>Inbound Messages</b> tab.<br><b>Result:</b> The current inbound messages are listed. |
| 2    | In the table, select the Inbound Message to edit.  |
| 3    | Click <b>Edit....</b><br><b>Result:</b> The Edit Inbound Network Specific Message screen appears.  |

| Step | Action |
|------|--------|
|------|--------|

- |   |   |
|---|---|
| 4 | Make the required changes to the fields, as described in <i>Adding new inbound messages</i> (on page 24). |
| 5 | Click <b>Save</b> .   |

## Deleting inbound messages

Follow these steps to delete inbound messages.

| Step | Action |
|------|--------|
|------|--------|

- |   |   |
|---|---|
| 1 | Select the <b>Inbound Messages</b> tab.<br><b>Result:</b> The current inbound messages are listed.                |
| 2 | In the table, select the inbound message to delete.   |
| 3 | Click <b>Delete...</b><br><b>Result:</b> The Delete Inbound Network Specific Message confirmation screen appears. |
| 4 | Click <b>Delete</b> .   |

## Outbound General Messages

### Introduction

This tab lists the available messages that can be sent to any subscriber out bound from the network, as against messages that are matched on country and network codes.

## Outbound General Messages tab

Here is an example of the Outbound General Messages tab.

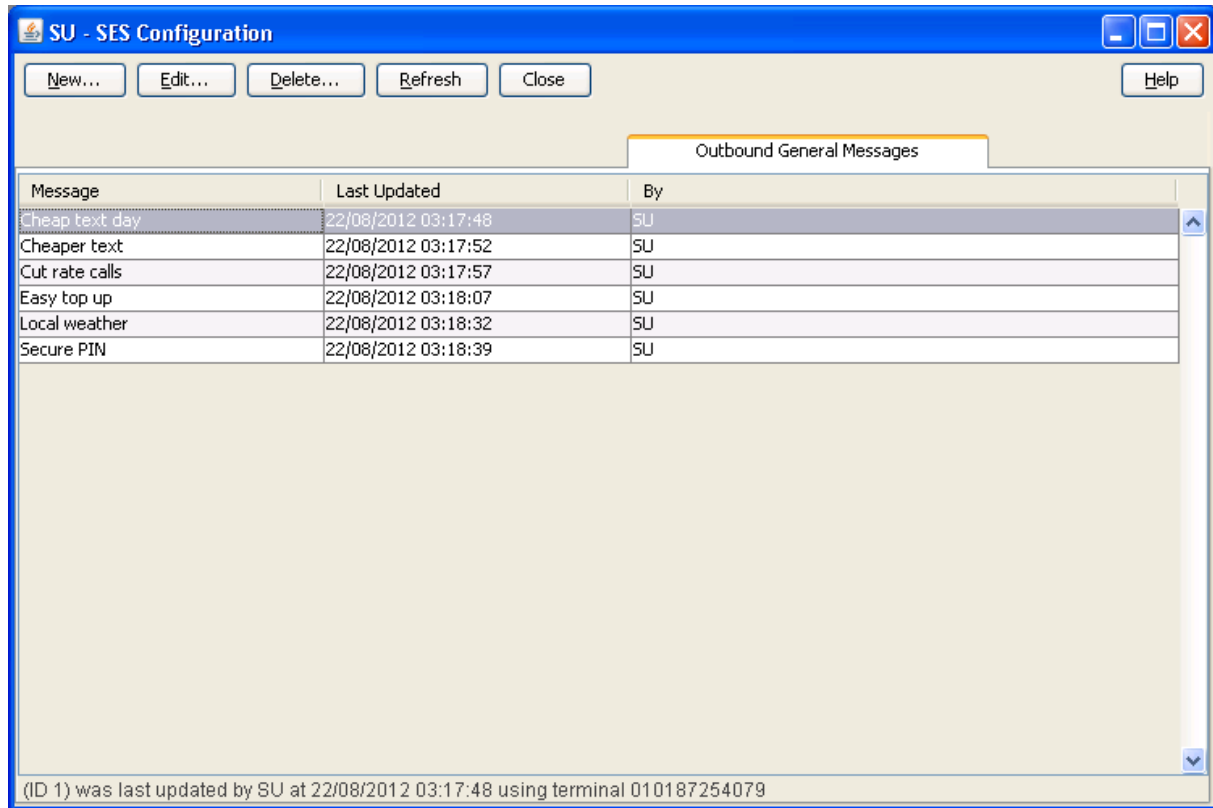

## Outbound general messages tab columns

This table describes the content of each column.

| Field        | Description  |
|--------------|--|
| Message      | The message name.  |
| Last Updated | Date and time stamp for the last update to this message (SMS time zone value). |
| By           | Username of user that made the last update.                                    |

## Adding new outbound general messages

Follow these steps to add new outbound general messages.

| Step | Action   |
|------|--|
| 1    | Select the <b>Outbound General Messages</b> tab.<br><b>Result:</b> The current outbound general messages are listed. |
| 2    | Click <b>New....</b><br><b>Result:</b> The New Outbound General Message screen appears.                              |



| Step | Action |
|------|--------|
|------|--------|

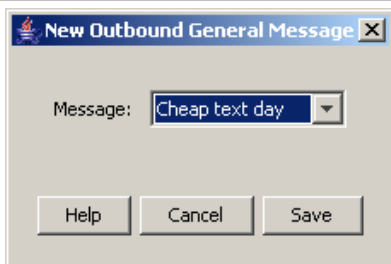

- 3 Select the **Message** from the drop down list.

**Tip:** This is the list of messages maintained on the **Messages tab** (on page 17).

The default is the first message in the list.

- 4 Click **Save**.

## Editing outbound general messages

Follow these steps to change an outbound general message.

| Step | Action |
|------|--------|
|------|--------|

- 1 Select the **Outbound General Messages** tab.  
**Result:** The current outbound general messages are listed.
- 2 In the table, select the message you want to edit.
- 3 Click **Edit...**  
**Result:** The Edit Outbound General Message screen appears.

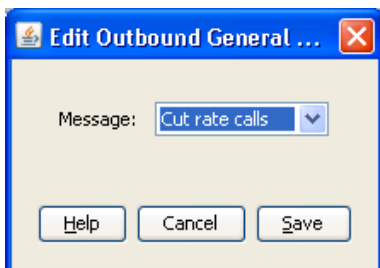

- 4 Select the **Message** from the drop down list.
- 5 Click **Save**.

## Deleting outbound general messages

Follow these steps to delete outbound general messages.

| Step | Action |
|------|--------|
|------|--------|

- 1 Select the **Outbound General Messages** tab.  
**Result:** The current outbound general messages are listed.
- 2 In the table, select the general outbound message to delete.
- 3 Click **Delete...**  
**Result:** The Delete Outbound General Message confirmation screen appears.
- 4 Click **Delete**.

# Outbound Messages

## Introduction

This tab lists the available messages that can be sent to any subscriber out bound from the network to a specific country and network, as against general messages that are not matched on country and network codes.

## Outbound Messages tab

Here is an example of the **Outbound Messages** tab.

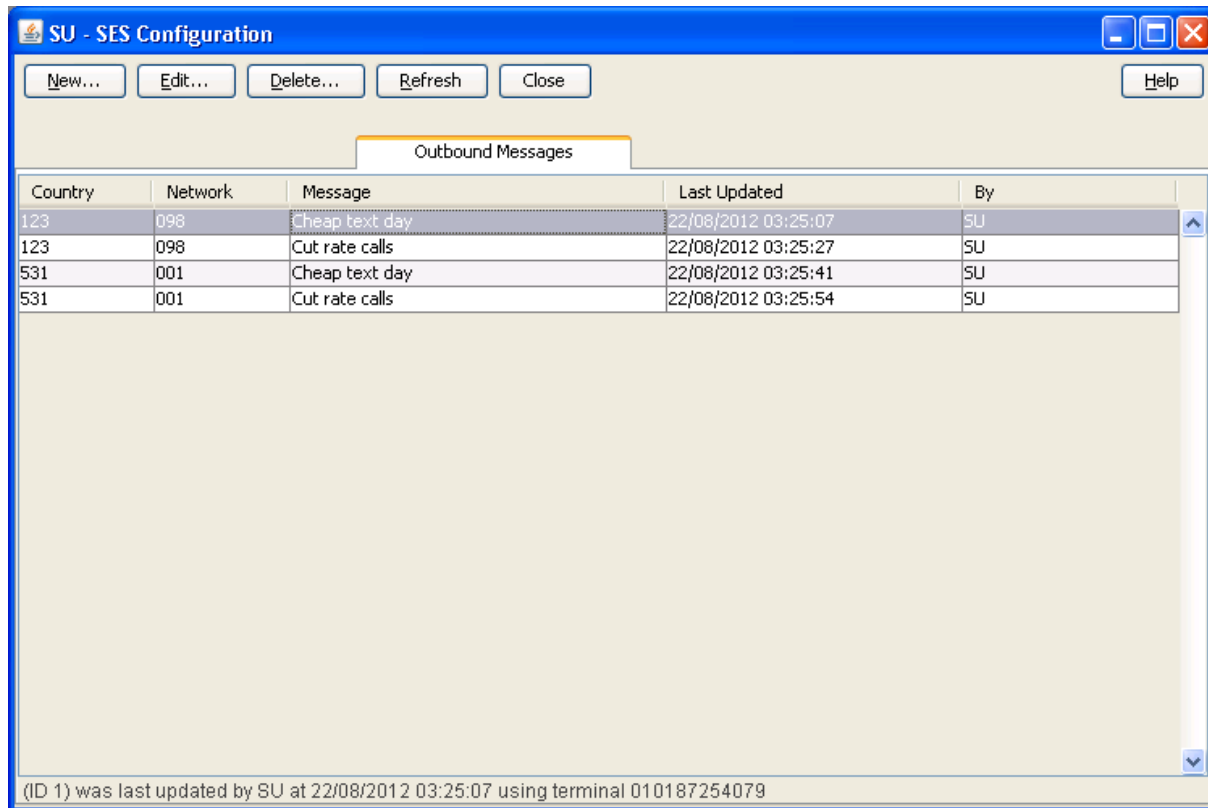

## Outbound messages tab columns

This table describes the content of each column.

| Field        | Description  |
|--------------|--|
| Country      | The country code the subscriber is roaming to.                                 |
| Network      | The network the subscriber is roaming to.                                      |
| Message      | The message name.  |
| Last Updated | Date and time stamp for the last update to this message (SMS time zone value). |
| By           | Username of user that made the last update.                                    |

## Adding new outbound messages

Follow these steps to add new outbound messages.

| Step | Action   |
|------|--|
| 1    | Select the <b>Outbound Messages</b> tab.<br><b>Result:</b> The current outbound messages are listed. |
| 2    | Click <b>New...</b><br><b>Result:</b> The New Outbound Network Specific Message screen appears.      |

|   |  |
|---|--|
| 3 | Enter the <b>Mobile Country Code</b> (MCC) to associate with the message.  |
| 4 | Enter the <b>Mobile Network Code</b> (MNC) to associate with the message.<br><b>Result:</b> The <b>Save</b> button becomes available.  |
| 5 | Select the <b>Message</b> to associate with the Country and Network Code from the drop down list.<br><br><b>Tip:</b> This is the list of messages maintained on the <b>Messages</b> <i>tab</i> (on page 17). |
| 6 | Click <b>Save</b> .  |

**Note:** For a list of MCC and MNC, refer to ITU E.212 ("Land Mobile Numbering Plan") documentation.

## Editing outbound messages

Follow these steps to edit an outbound message.

| Step | Action   |
|------|--|
| 1    | Select the <b>Outbound Messages</b> tab.<br><b>Result:</b> The current outbound messages are listed. |
| 2    | In the table, select the Outbound Message to edit.   |
| 3    | Click <b>Edit...</b><br><b>Result:</b> The Edit Outbound Network Specific Message screen appears.    |

| Step | Action |
|------|--------|
|------|--------|

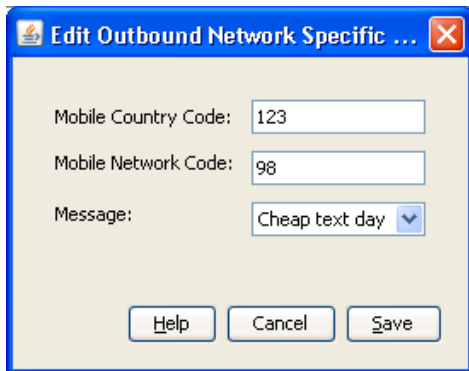

- |   |  |
|---|--|
| 4 | Make the required changes to the fields, as described in <i>Adding new outbound messages</i> (on page 29). |
| 5 | Click <b>Save</b> .  |

## Deleting outbound messages

Follow these steps to delete outbound messages.

| Step | Action |
|------|--------|
|------|--------|

- |   |  |
|---|--|
| 1 | Select the <b>Outbound Messages</b> tab.<br><b>Result:</b> The current outbound messages are listed.               |
| 2 | In the table, select the outbound message to delete.   |
| 3 | Click <b>Delete...</b><br><b>Result:</b> The Delete Outbound Network Specific Message confirmation screen appears. |
| 4 | Click <b>Delete</b> .  |

## Trigger Rules

### Introduction

This tab enables you to define the rules for what to trigger on receipt of MAP Mobility Notification messages. You can select control plans to be run which can send text messages. For example, sending welcome and farewell messages in response to IMSI attach and detach messages.

There are two sets of trigger rules that may be established. The rule set used depends on the contents of the `databaseLogin` parameter in the `sesTrigger` (on page 44) section of the `eserv.config` file. If the parameter is:

- Missing or empty, the **Trigger Rules** tab set is used
- Otherwise the rules in the configuration file are used

## Trigger Rules tab

Here is an example of the **Trigger Rules** tab.

| Event Class      | Event Type       | Service Key | Country Code | Network C... | MSISDN | Enabled | Last Updated     | By |
|------------------|------------------|-------------|--------------|--------------|--------|---------|------------------|----|
| CAMEL Mobili ... | Location Upd ... | 9           | 531          | 001          |        | ✓       | 22/08/2012 03... | SU |
| CAMEL Mobili ... | Location Upd ... | 9           | 123          | 98           |        | ✓       | 22/08/2012 03... | SU |

## Trigger rules tab columns

This table describes the content of each column.

| Field        | Description   |
|--------------|---|
| Event Class  | The basic type of event. Currently just CAMEL Mobility Management is supported.   |
| Event Type   | The exact type of message.  |
| Service Key  | This is a parameter of the CAMEL Mobility Management event that allows different services to be treated differently.  |
| Country Code | The MCC the subscriber is roaming to or from.<br><b>Note:</b> For a list of MCC, refer to ITU E.212 ("Land Mobile Numbering Plan") documentation.   |
| Network Code | The home network (MNC) for the subscriber.<br>The Country Code and Network Code are both used as prefixes in the IMSI and CAMEL Mobility Management events. These two codes identify the subscriber home network.<br><b>Note:</b> For a list of MNC, refer to ITU E.212 ("Land Mobile Numbering Plan") documentation. |

| Field        | Description  |
|--------------|--|
| MSISDN       | Mobile Station ISDN number.  |
| Enabled      | This rule is active indicator (selected = active),                             |
| Last Updated | Date and time stamp for the last update to this message (SMS time zone value). |
| By           | Username of user that made the last update.                                    |

Not visible on this tab, but required when adding or editing a trigger rule.

| Field            | Description  |
|------------------|--|
| Service Provider | The telco providing the SES service/ACS customer.              |
| Control Plan     | The control plan to execute once a trigger match has occurred. |

## Adding new trigger rules

Follow these steps to add new trigger rules.

| Step | Action   |
|------|--|
| 1    | Select the <b>Trigger Rules</b> tab.<br><b>Result:</b> The Trigger Rules are listed. |
| 2    | Click <b>New....</b><br><b>Result:</b> The New Trigger Rule screen appears.          |

**Tip:** A blank field results in a match against everything for that field and is therefore optional.

3 Select the **Event Class** from the drop down.

| Step | Action   |
|------|--|
|      | <b>Warning:</b> This field is mandatory.   |
| 4    | Select the <b>Event Type</b> from the drop down list.<br>Can be one of: <ul style="list-style-type: none"> <li>• Any</li> <li>• Location update in the same VLR service area</li> <li>• Location update to another VLR service area</li> <li>• IMSI attach</li> <li>• MS initiated IMSI detach (explicit detach)</li> <li>• Network initiated IMSI detach (implicit detach)</li> <li>• Subscriber Busy</li> <li>• Subscriber Idle</li> </ul>   |
|      | <b>Warning:</b> This field is mandatory.   |
| 5    | Enter the <b>Service Key</b> if required.  |
| 6    | Enter the <b>Country Code</b> (MCC) if required.   |
| 7    | Enter the <b>Network Code</b> (MNC) if required.   |
| 8    | Enter the <b>MSISDN</b> if required.   |
| 9    | Select the <b>Enabled</b> check box to make this trigger available.  |
| 10   | Perform one of the following: <ul style="list-style-type: none"> <li>• Select the <b>Service Provider</b> from the drop down list, or, if the list is blank</li> <li>• Enter the initial digits and press <b>Enter</b> to search and validate the entry. If you leave the field blank and press <b>Enter</b> the drop down list will be populated with all available Service Providers.</li> </ul> <p><b>Result:</b> The Service Provider value is validated and selected as valid and the control plan drop down list is populated.</p> |
|      | <b>Warning:</b> This field is mandatory.   |
| 12   | Perform one of the following: <ul style="list-style-type: none"> <li>• Select the <b>Control Plan</b> from the drop down list</li> <li>• Enter the initial digits and press <b>Enter</b> to search and validate the entry</li> </ul> <p><b>Result:</b> The control plan value is validated and ticked as valid, and the <b>Save</b> button becomes available.</p>  |
|      | <b>Warning:</b> This field is mandatory.   |
| 13   | Click <b>Save</b> .  |

**Note:** For a list of MCC and MNC, refer to ITU E.212 ("Land Mobile Numbering Plan") documentation.

## Editing trigger rules

Follow these steps to edit trigger rules.

| Step | Action   |
|------|--|
| 1    | Select the <b>Trigger Rules</b> tab.<br><b>Result:</b> The Trigger Rules are listed. |
| 2    | In the table, select the Trigger Rule to edit.                                       |
| 3    | Click <b>Edit...</b>   |

| Step | Action |
|------|--------|
|------|--------|

**Result:** The Edit Trigger Rule screen appears.

- 3 Make the required changes to the fields, as described in *Adding new trigger rules* (on page 32).
- 4 Click **Save**.

## Deleting trigger rules

Follow these steps to delete trigger rules.

| Step | Action |
|------|--------|
|------|--------|

- 1 Select the **Trigger Rules** tab.  
**Result:** The Trigger Rules are listed.
- 2 In the table, select the trigger rule to delete.
- 3 Click **Delete....**  
**Result:** The Delete Trigger Rule confirmation screen appears.
- 4 Click **Delete**.

## Contact History

### Introduction

This tab enables you to view the roaming subscriber's history of messages sent. The available history is governed by the number of days history messages are kept in the database (defined in `dbCleanup` (on page 58) configuration).



The contact history is added to every time a message is successfully sent to an in-roaming or out-roaming subscriber. Population of history will be performed by an external application, for example, Deliver SM.

## Contact History tab

Here is an example of the **Contact History** tab.

**Tip:** This tab is empty until a search for the contents is started. See *Viewing contact history* (on page 36).

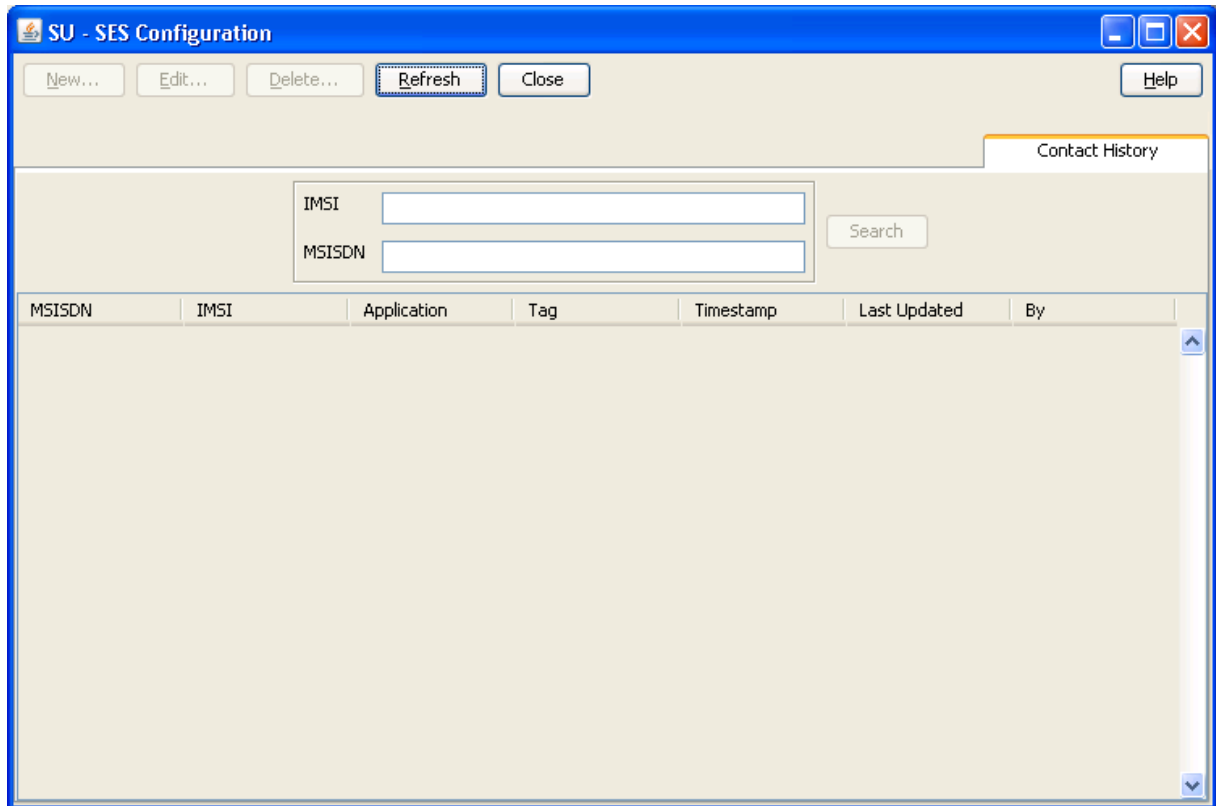

## Contact tab columns

This table describes the contents of each column.

| Field        | Description   |
|--------------|---|
| MSISDN       | Mobile Station ISDN number.   |
| IMSI         | International Mobile Subscriber Identity.   |
| Application  | When present, configuration information from the application which populated the contact history, for example. Deliver SM feature node. |
| Tag          | All messages sent are tagged by the sending feature node. These tags are internal, auto generated and informative only.                 |
| Timestamp    | Time message sent to the subscriber (SMS time zone value).  |
| Last Updated | Date message sent to the subscriber (SMS time zone value).  |
| By           | Username or application name that made the last update.   |

## Viewing contact history

Follow these steps to view the contact history for a subscriber.

| Step | Action |
|------|--------|
|------|--------|

- 1 Select the **Contact History** tab.  
**Result:** The contact history screen shows with unpopulated columns.
- 2 Type either the **IMSI** or the **MSISDN** (both is not allowed) of the subscriber to view the history of.

**Tip:** In either case, just the leading digits may be entered to broaden the search results.

**Result:** The **Search** button becomes available.

- 3 Click **Search**.

**Result:** The search results for the requested IMSI or MSISDN are displayed in the grid.

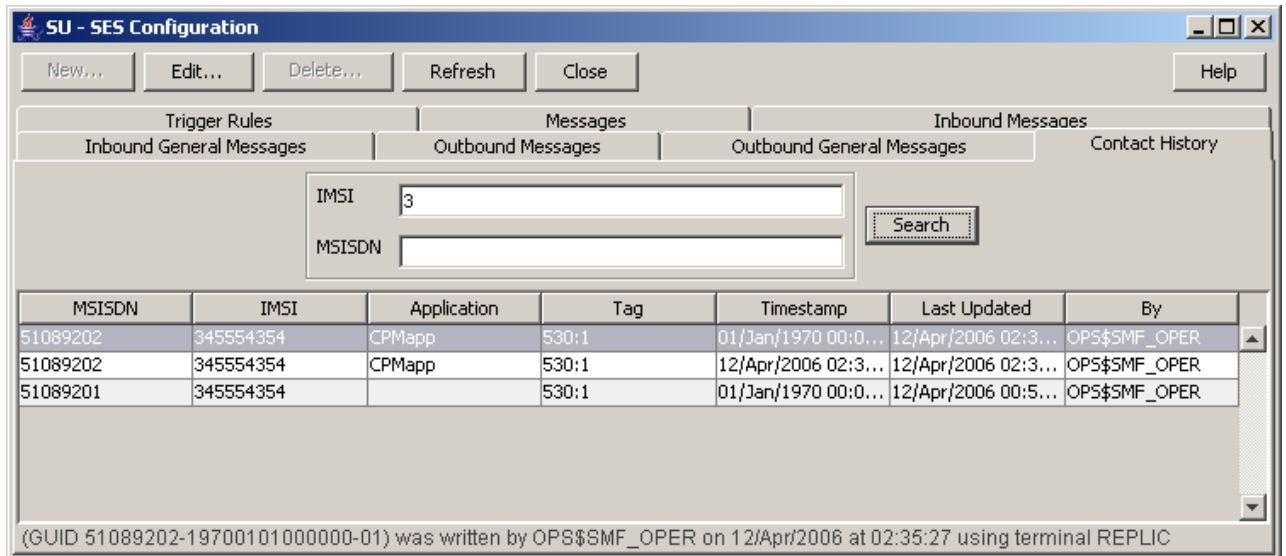

- 4 To view the actual message text, select the message row and click **Edit...**

**Result:** The message details are displayed.

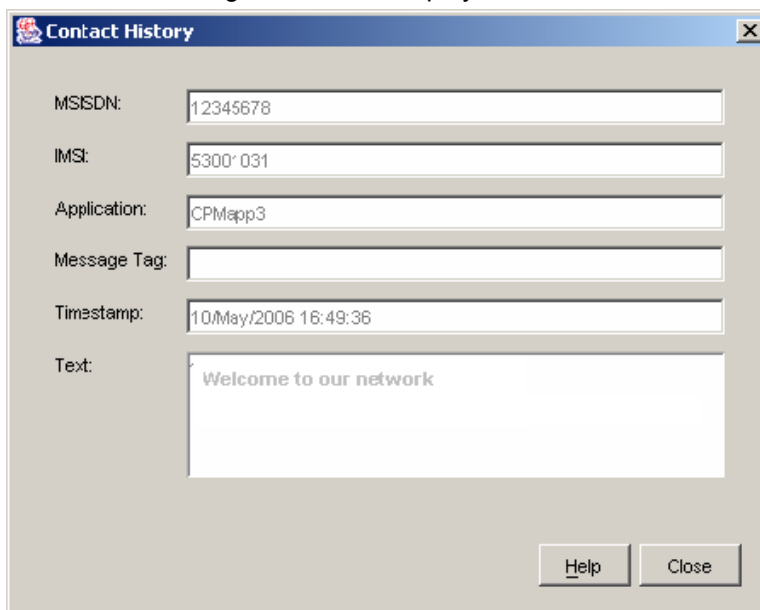

| Step | Action                      |
|------|-----------------------------|
| 5    | Click <b>Close</b> to exit. |



# Using SES Feature Nodes

## Overview

### Introduction

This chapter explains how SES uses ACS. This includes details on the SES specific feature nodes that are used in the ACS Control Plan Editor (CPE). These check subscribers on entering or leaving a network using SES and determine whether to send them messages and if so, determine the number of messages to be sent.

For an overview of ACS and the ACS Control Plan Editor, see the relevant ACS or CPE user's guides.

### In this chapter

---

This chapter contains the following topics.

|  |    |
|--|----|
| Example Control Plan - In-Roamer ..... | 39 |
| Example Control Plan - Out-Roamer..... | 40 |

## Example Control Plan - In-Roamer

### In-roaming control plan process

This example shows how the SES in-roaming feature nodes can be used in a control plan. For this example the In-Roamer Contact Check feature node has been configured at two days, and the In-Roamer Messages Selection feature node has been configured at two messages.

The following list of actions typify the sequence of in-roaming events.

- 1 A roaming subscriber enters the network and the network triggers SES.
- 2 The subscriber details match the configuration requirements from the Trigger Rules.
- 3 The example control plan is invoked.
- 4 The In-Roamer Contact Check (sesInRCC) feature node determines if this subscriber has been sent messages within the contact period of 2 days.
- 5 If there has been contact within the contact period, the control plan exits.
- 6 The In-Roamer Messages Selection (sesInRMS) feature node checks for messages (up to the configured total) to send.
- 7 If there were no messages found to send, the control plan exits.
- 8 A node that sends short messages (Notification) attempts to send the messages.

## In-roaming control plan

Here is an example in-roaming control plan.

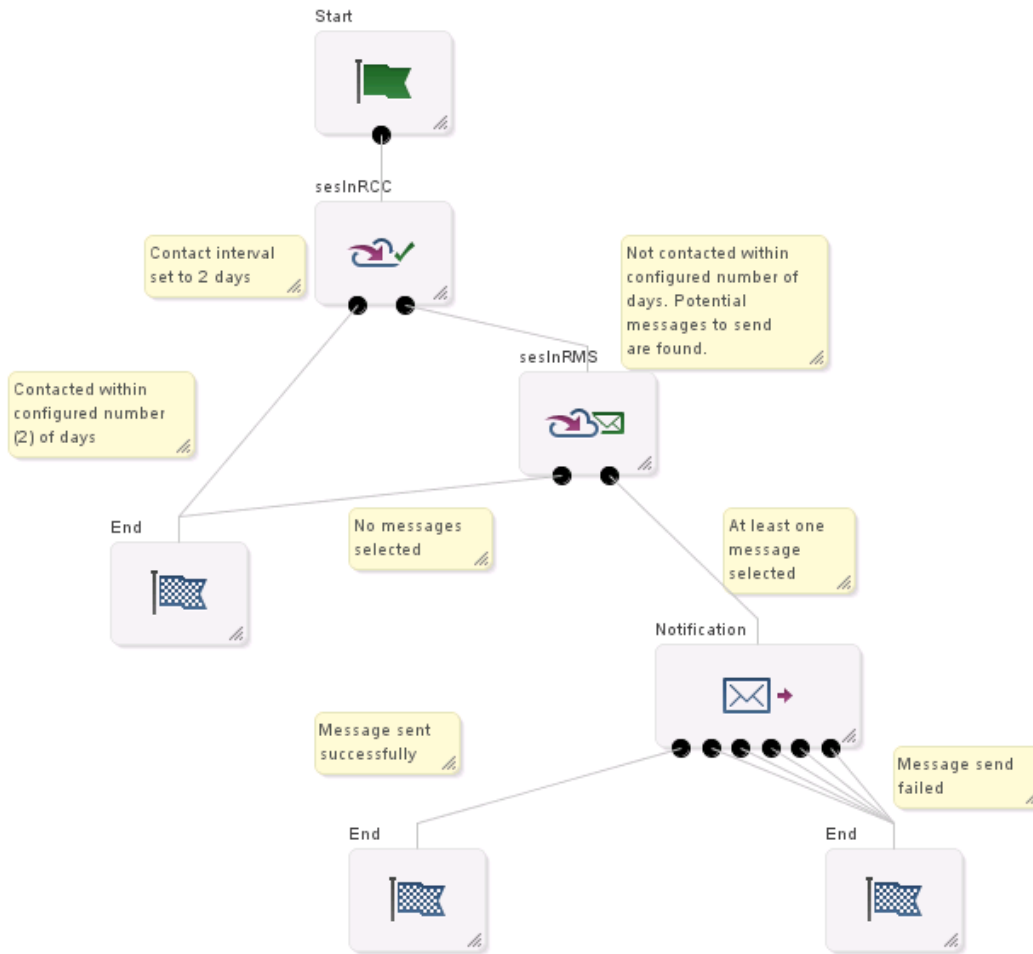

## Example Control Plan - Out-Roamer

### Out-roaming control plan process

This example shows how the out-roaming feature nodes can be used in a control plan. For this example the Out-Roamer Contact Check feature node has been configured at two days, and the Out-Roamer Messages Selection node has been configured at two messages.

The following list of actions typify the sequence of out-roaming events.

- 1 A roaming subscriber leaves the network and the network triggers SES.
- 2 The subscriber details match the configuration requirements from the Trigger Rules.
- 3 The example control plan is invoked.
- 4 The Out-Roamer Contact Check feature node determines if this subscriber has been sent messages within the contact period of 2 days (sesOutRCC).
- 5 If the subscriber has opted out of receiving messages, the control plan exits (this could be other control plan features) (End).
- 6 If there has been contact within the contact period, the control plan exits (this could be other control plan features) (End).

- 7 The Out-Roamer Messages Selection feature node (sesOutRMS) checks for messages (up to the configured total) to send.
- 8 If there were no messages found to send, the control plan exits (this could be other control plan features) (End).
- 9 A feature node that sends short messages (Notification) attempts to send the messages (followed by other control plan features).

## Out-roaming control plan

Here is an example out-roaming control plan.

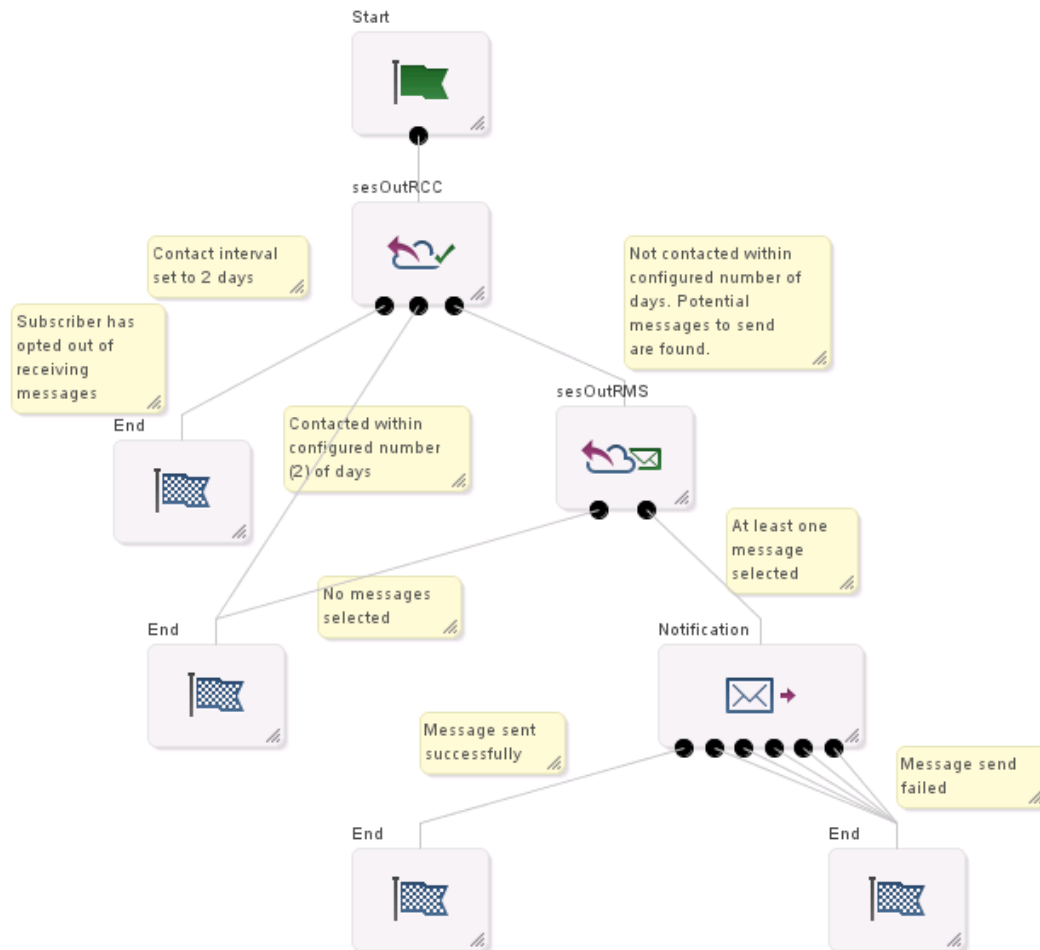





# Configuration

## Overview

### Introduction

This chapter explains the Subscriber Event Service configuration requirements.

### In this chapter

---

This chapter contains the following topics.

|                                 |    |
|---------------------------------|----|
| eserv.config Configuration..... | 43 |
| sesTrigger.....                 | 44 |
| macroNodes .....                | 55 |
| dbCleanup .....                 | 58 |
| serviceLibrary .....            | 59 |
| SLEE.cfg Configuration .....    | 59 |
| acs.conf Configuration.....     | 60 |

## eserv.config Configuration

### Introduction

The **eserv.config** file is a shared configuration file, from which many Oracle Communications Network Charging and Control (NCC) applications read their configuration. Each NCC machine (SMS, SLC, and VWS) has its own version of this configuration file, containing configuration relevant to that machine. The **eserv.config** file contains different sections; each application reads the sections of the file that contains data relevant to it.

The **eserv.config** file is located in the `/IN/service_packages/` directory.

The **eserv.config** file format uses hierarchical groupings, and most applications make use of this to divide the options into logical groupings.

### Configuration File Format

To organize the configuration data within the **eserv.config** file, some sections are nested within other sections. Configuration details are opened and closed using either `{ }` or `[ ]`.

- Groups of parameters are enclosed with curly brackets – `{ }`
- An array of parameters is enclosed in square brackets – `[ ]`
- Comments are prefaced with a `#` at the beginning of the line

To list things within a group or an array, elements must be separated by at least one comma or at least one line break. Any of the following formats can be used, as in this example:

```
{ name="route6", id = 3, prefixes = [ "00000148", "0000473" ] }
{ name="route7", id = 4, prefixes = [ "000001049" ] }
```

or

```
{ name="route6"
```

## Chapter 5

```
    id = 3
    prefixes = [
        "00000148"
        "0000473"
    ]
}
{ name="route7"
  id = 4
  prefixes = [
    "000001049"
  ]
}
```

or

```
{ name="route6"
  id = 3
  prefixes = [ "00000148", "0000473" ]
}
{ name="route7", id = 4
  prefixes = [ "000001049" ]
}
```

### eserv.config Files Delivered

Most applications come with an example **eserv.config** configuration in a file called **eserv.config.example** in the root of the application directory, for example, `/IN/service_packages/eserv.config.example`.

### Editing the File

Open the configuration file on your system using a standard text editor. Do not use text editors, such as Microsoft Word, that attach control characters. These can be, for example, Microsoft DOS or Windows line termination characters (for example, ^M), which are not visible to the user, at the end of each row. This causes file errors when the application tries to read the configuration file.

Always keep a backup of your file before making any changes to it. This ensures you have a working copy to which you can return.

### Loading eserv.config Changes

If you change the configuration file, you must restart the appropriate parts of the service to enable the new options to take effect.

### Restarting

The following processes are restarted after configuration changes as indicated.

| Process    | Restart Action                               |
|------------|--|
| sesTrigger | Sighup of sesTrigger or restart of the SLEE. |
| macronodes | Sighup of slee_acs or restart of the SLEE.   |

## sesTrigger

### sesTrigger configuration

Here is a high level view of the Subscriber Event Service (SES) trigger section of the **eserv.config**.

```
SES = {
  sesTrigger = {
```

```

maxOutstanding = 0
databaseLogin = "SCP/SCP"
reloadInterval = 600
pollTime = 20000
adapters = {
    xml_subscriber = {
        library = "libeaxXmlSubscriber.so"
        rejectLevel = 300
        rejectLevelReportPeriod = 6
        performanceReportPeriod = 10

        function = "sesLoadAdapter"
        timeout = 5
        called_party_noa = 0
        serviceKey = 120
        balance_service_key = 130 #
        redeem_service_key = 422 #
        balance_type_index = -1 # old value 0
        balance_amount_index = -1

        redeem_type_index = -1
        redeem_amount_index = 0
        faked_call_party = "0"
        listen_port = 1888
        connection_timeout = 60
        #remote_hosts = [ "10.21.120.235" ]
        log = true

# getSubscriberBalance
        balance_fields = [
            {
                name = "Active End" # the XML field name
                type = "date"
                announcementId = 2
                # >= 0 = variable part ID
                # the position of the value in the INAP Play
                Announcement
                # < 0 = use variable announcement ID
                required = false
                # required means the parameter is required to produce the
                XML response
                # if the parameter is missing the XML message will fail
            }
            {
                name = "Grace End"
                type = "date"
                announcementId = 3
                # >= 0 = variable part ID
                # the position of the value in the INAP Play
                Announcement
                # < 0 = use variable announcement ID
                required = false
                # if true and can not extract value the xml request will
                be failed
            }
        ]

# VoucherRedeem
        redeem_fields = [
            {
                name = "New Balance" # the XML field name
                type = "int"
                announcementId = 1

```

```

        # >= 0 = variable part ID
        # the position of the value in the INAP Play Announcement
        # < 0 = use variable announcement ID
        required = false
        # if true and can not extract value the xml request will be
failed
    }
    {
        name = "Active End" # the XML field name
        type = "date"
        announcementId = 2
        # >= 0 = variable part ID
        # the position of the value in the INAP Play Announcement
        # < 0 = use variable announcement ID
        required = false
        # if true and can not extract value the xml request will be
failed
    }
    {
        name = "Grace End"
        type = "date"
        announcementId = 3
        # >= 0 = variable part ID
        # the position of the value in the INAP Play Announcement
        # < 0 = use variable announcement ID
        required = false
        # if true and can not extract value the xml request will be
failed
    }
}
} # End of xml_subscriber
} # End of adapters
} # End of sesTrigger section.
} # End of SES section.

```

## sesTrigger parameters

SES trigger application accepts the following trigger parameters.

adapters

**Syntax:** adapters = {*adapter1\_name*}{**adapter2\_name**}

**Description:** The adapters section specifies the adapter(s) required for SES to work.

**Type:** String

**Optionality:** Mandatory.

**Allowed:** Must be the default string.

**Default:**

- notemm, and/or
- xml\_subscriber

**Notes:** See the relevant adapter parameter lists below.

**Example:**

```

adapters = {
  notemm = {
    library = "libseseNoteMM.so"
    function = "sesLoadAdapter"
    timeout = 5
    serviceKey = 120
  }
}
{
  xml_subscriber = {
    library = "libeaxXmlSubscriber.so"
  }
}

```

```

        function = "sesLoadAdapter"
        timeout = 5
        serviceKey = 511
        balance_service_key = 511
        voucher_service_key = 512
        balance_type_index = 0
        balance_amount_index = 1
        redeem_type_index = 0
        redeem_amount_index = 1
        faked_call_party = "0"
        listen_port = 8088
        remote_hosts = [ "host1.xyz.com", "host2.xyz.com" ]
        connection_timeout = 60
        log = true
    }
}

```

#### databaseLogin

**Syntax:** databaseLogin = <"user/password">

**Description:** Identifies where to get the trigger rules from.

**Type:** String

**Optionality:** Optional; if missing the default is used.

**Allowed:** Any valid user and password combination string.

**Default:** "SCP/SCP"

**Notes:** Setting databaseLogin to empty means use the trigger rules below instead of loading them from the database.

**Example:** databaseLogin = ""

#### maxOutstanding

**Syntax:** maxOutstanding = num

**Description:** Maximum number of transactions to ACS that may be outstanding at any time.

**Type:** Integer

**Optionality:** Optional; if missing the default is used.

**Allowed:** Any positive decimal integer, including 0.

**Default:** 0

**Notes:** 0 means no limit. If this limit is reached, any new requests will be rejected.

**Example:** maxOutstanding = 0

#### pollTime

**Syntax:** pollTime = msec

**Description:** PollTime for TCP/IP sockets in micro-seconds.

**Type:** Integer

**Optionality:** Optional, if missing the default is used.

**Allowed:** Any positive decimal integer

**Default:** 100000 (micro seconds)

**Notes:**

**Example:** pollTime = 20000

reloadInterval

**Syntax:** reloadInterval = *seconds*  
**Description:** How often to reload configuration (including database), in seconds.  
**Type:** Integer  
**Optionality:** Optional; if missing the default is used.  
**Allowed:** Any positive decimal integer, including 0.  
**Default:** 0  
**Notes:** 0 means never. In any case, we always reload on getting a SIGHUP.  
**Example:** reloadInterval = 0

### notemm adapter parameters

These are the configuration parameters specific to the notemm adapter.

function

**Syntax:** function = "*name*"  
**Description:** The entry point to this shared library.  
**Type:** string  
**Optionality:** Mandatory  
**Allowed:** Must be "sesLoadAdapter"  
**Example:** function = "sesLoadAdapter"

library

**Syntax:** library = "*name*"  
**Description:** The shared library to load.  
**Type:** String  
**Optionality:** Mandatory  
**Allowed:** Any valid library name.  
**Default:** "libeaxXmlSubscriber.so"  
**Notes:**  
**Example:** library = "libeaxXmlSubscriber.so"

serviceKey

**Syntax:** serviceKey = *skey*  
**Description:** Service key for this adapter. This is the serviceKey used for triggering to ACS.  
**Type:** Integer  
**Optionality:** Optional; if missing the default is used.  
**Allowed:** Any valid service key.  
**Default:** 511  
**Notes:**  
**Example:** serviceKey = 511

timeout

**Syntax:** timeout = *seconds*  
**Description:** Timeout, in seconds, on transactions.  
**Type:** Positive integer

**Optionality:** Mandatory  
**Allowed:** Any positive number, including 0  
**Default:** 0  
**Note:** 0 means no timeout.  
 This timeout should be set to a higher than a retry timeout parameter, if it exists, of any node, used in conjunction with this service, that sends a short message. This will prevent SES trigger from timing out before all messages are successfully sent.  
**Example:** `timeout = 5`

## xml\_subscriber adapter parameters

These are the configuration parameters specific to the xml\_subscriber adapter.

### balance\_amount\_index

**Syntax:** `balance_amount_index = value`  
**Description:** Where to extract subscriber amount information from the PlayAnnouncement.  
**Type:** Integer  
**Optionality:** Optional (default used if not set).  
**Allowed:** -1 means to use the fixed announcements  
 0 or greater is the (0-based) index  
**Default:** 1  
**Notes:**  
**Example:** `balance_amount_index = 1`

### balance\_service\_key

**Syntax:** `balance_service_key = skey`  
**Description:** The service key for get-balance triggering to ACS.  
**Type:** Integer  
**Optionality:** Optional (default used if not set).  
**Allowed:** Any valid service key.  
**Default:** 511  
**Notes:**  
**Example:** `balance_service_key = 511`

### balance\_type\_index

**Syntax:** `balance_type_index = value`  
**Description:** Where to extract subscriber balance unit information from the PlayAnnouncement.  
**Type:** Integer  
**Optionality:** Optional (default used if not set).  
**Allowed:** -1 means to use the fixed announcements  
 0 or greater is the (0-based) index  
**Default:** 0  
**Notes:**  
**Example:** `balance_type_index = 0`

## Chapter 5

### called\_party\_noa

**Syntax:** `called_party_noa = noa`  
**Description:** The called party nature of address configured.  
**Type:** Integer  
**Optionality:** Optional (default used if not set).  
**Allowed:**  
**Default:** 0  
**Notes:**  
**Example:** `called_party_noa = 0`

### connection\_timeout

**Syntax:** `connection_timeout = seconds`  
**Description:** Idle timeout on HTTP connections, in seconds.  
**Type:** Integer  
**Optionality:** Optional (default used if not set).  
**Allowed:**

- 0 means no timeout
- Any positive integer

**Default:** 0  
**Notes:**  
**Example:** `connection_timeout = 60`

### faked\_call\_party

**Syntax:** `faked_call_party = "value"`  
**Description:** Number to add to the IDP as "called party", seeing as how we don't have one. Some service loaders need this.  
**Type:** Numerical string  
**Optionality:** Mandatory  
**Allowed:**  
**Default:** "0"  
**Notes:**  
**Example:** `faked_call_party = "0"`

### function

**Syntax:** `function = "name"`  
**Description:** The entry point to this shared library.  
**Type:** string  
**Optionality:** Mandatory  
**Allowed:** Must be "sesLoadAdapter"  
**Example:** `function = "sesLoadAdapter"`

### library

**Syntax:** `library = "name"`  
**Description:** The shared library to load.  
**Type:** String  
**Optionality:** Mandatory



**Allowed:** Any valid library name.  
**Default:** No default  
**Notes:**  
**Example:** `library = "libeaxXmlSubscriber.so"`

#### `listen_port`

**Syntax:** `listen_port = port`  
**Description:** Port to listen on.  
**Type:** Integer  
**Optionality:** Optional (default used if not set).  
**Allowed:** Any valid port number.  
**Default:** 8088  
**Notes:**  
**Example:** `listen_port = 8088`

#### `log`

**Syntax:** `log = true|false`  
**Description:** Whether or not to log individual requests.  
**Type:** Integer  
**Optionality:** Mandatory  
**Allowed:** true, false  
**Default:** true  
**Notes:**  
**Example:** `log = true`

#### `performanceReportPeriod`

**Syntax:** `performanceReportPeriod = seconds`  
**Description:** Defines the period (in seconds) after which a performance report will be generated.  
**Type:** Integer  
**Optionality:** Optional (default used if not set).  
**Allowed:**  
**Default:** 0 - no report will be generated  
**Notes:**

- The reporting time is aligned with the system clock, NOT the application start time.
- The first performance report after SLEE startup may differ to that which is configured for the `performanceReportPeriod`, depending on when the SLEE was started within the clock aligned performance period.

**Example:** `performanceReportPeriod = 10`

#### `redeem_amount_index`

**Syntax:** `redeem_amount_index = value`  
**Description:** Where to extract voucher redeem unit information from the PlayAnnouncement.  
**Type:** Integer  
**Optionality:** Optional (default used if not set).

## Chapter 5

**Allowed:** Any positive decimal integer, including 0.

**Default:** 1

**Notes:**

**Example:** `redeem_amount_index = 1`

`redeem_type_index`

**Syntax:** `redeem_type_index = value`

**Description:** Where to extract voucher redeem unit information from the PlayAnnouncement.

**Type:** Integer

**Optionality:** Optional, if missing the default is used.

**Allowed:** Any positive decimal integer, including 0.

**Default:** 0

**Notes:**

**Example:** `redeem_type_index = 0`

`rejectLevel`

**Syntax:** `rejectLevel = num`

**Description:** Determines the maximum number of new connections allowed per second. sesTrigger rejects any new connection that comes in over and above what is configured.

**Type:** Integer

**Optionality:** Optional (default used if not set).

**Allowed:**

**Default:** 0 - no traffic limit

**Notes:** Any negative number is treated as 0, that is, no limit set.

**Example:** `rejectLevel = 300`

`rejectLevelReportPeriod`

**Syntax:** `rejectLevelReportPeriod = seconds`

**Description:** Defines the period (in seconds) after which a reject report will be generated.

**Type:** Integer

**Optionality:** Optional (default used if not set).

**Allowed:**

**Default:** 0 - no report will be generated

**Notes:**

- The reporting time is aligned with the system clock, NOT the application start time.
- The first performance report after SLEE startup may differ to that which is configured for the rejectLevelReportPeriod, depending on when the SLEE was started within the clock aligned performance period.

**Example:** `rejectLevelReportPeriod = 10`

`remote_hosts`

**Syntax:** `remote_hosts = ["host1", "host2, . . . .", "hostn"]`

**Description:** List of remote hosts to allow connections from.

**Type:** Array of strings

**Optionality:** Optional (default used if not set).

**Allowed:** Any valid host names.  
**Default:** [] (empty)  
**Notes:** Empty means to allow connections from any hosts.  
**Example:** `remote_hosts = [ "host1.xyz.com", "host2.xyz.com" ]`

`serviceKey`

**Syntax:** `serviceKey = skey`  
**Description:** Service key for this adapter. This is the `serviceKey` used for triggering to ACS.  
**Type:** Integer  
**Optionality:** Optional; if missing the default is used.  
**Allowed:** Any valid service key.  
**Default:** 511  
**Notes:**  
**Example:** `serviceKey = 511`

`timeout`

**Syntax:** `timeout = seconds`  
**Description:** Timeout, in seconds, on transactions.  
**Type:** Positive integer  
**Optionality:** Mandatory  
**Allowed:** Any positive number, including 0  
**Default:** 0  
**Note:** 0 means no timeout.  
 This timeout should be set to a higher than a retry timeout parameter, if it exists, of any node, used in conjunction with this service, that sends a short message. This will prevent SES trigger from timing out before all messages are successfully sent.  
**Example:** `timeout = 5`

`voucher_service_key`

**Syntax:** `voucher_service_key = skey`  
**Description:** The service key for voucher-redeem triggering to ACS.  
**Type:** Integer  
**Optionality:** Optional (default used if not set).  
**Allowed:** Any valid service key.  
**Default:** 512  
**Notes:**  
**Example:** `voucher_service_key = 512`

## rules parameters

The trigger rules provide match information in order to determine the control plan to use.

Matching is done on:

- `event_class`, and
- `event_type`, then if needed

## Chapter 5

- `msisdn` (treated as a prefix).  
SES trigger application accepts the following rules parameters.

**Note:** The rules config is only used if `databaseLogin` is present and empty above; otherwise the database is used.

`enabled`

**Syntax:** `enabled = true|false`

**Description:**

**Type:** Boolean

**Optionality:** Mandatory

**Allowed:** true, false

**Default:** none

**Notes:**

**Example:** `enabled = true`

`event_class`

**Syntax:** `event_class = class`

**Description:** The event class to match against for control plan triggering.

**Type:** Integer

**Optionality:** Mandatory

**Allowed:** Any valid event class.

**Default:** none

**Notes:** Used in conjunction with `event_type` and `msisdn`.

**Example:** `event_class = 4`

`event_type`

**Syntax:** `event_type = type`

**Description:** The event type to match against for control plan triggering.

**Type:** Integer

**Optionality:** Mandatory

**Allowed:**

- 1 (subscriber balance)
- 2 (voucher redeem)

**Default:** none

**Notes:** Used in conjunction with `event_class` and `msisdn`

**Example:** `event_type = 1`

`msisdn`

**Syntax:** `msisdn = value`

**Description:** The subscriber key to match against for control plan triggering.

**Type:** Integer

**Optionality:** Optional

**Allowed:** Any valid subscriber number or part number representing the start or number prefix of the subscriber.

**Default:** none

**Notes:** Used in conjunction with the `event_class` and `event_type` parameters when there are different triggers required that are based on subscriber number.

**Example:** `msisdn = "1234"`

`pin`

**Syntax:** `pin = "value"`

**Description:** Override for the generated PIN, if wanted.

**Type:** string

**Optionality:** Optional

**Allowed:**

**Default:** none

**Notes:** This is only used with the SES service loader.

**Example:** `pin = "xmlsubbal"`

`plan`

**Syntax:** `plan = "name"`

**Description:** The control plan to trigger to if the event class, event type and (when used) the `msisdn` are matched against.

**Type:** String

**Optionality:** Mandatory

**Allowed:** Any valid control plan name.

**Default:** none

**Notes:** The control plan must have already been cleanly compiled and saved.

This is only used with the SES service loader.

**Example:** `plan = "LEralph"`

`provider`

**Syntax:** `provider = "id"`

**Description:** The ID of the service provider.

**Type:** String

**Optionality:** Mandatory

**Allowed:** Any valid service provider ID.

**Default:** none

**Notes:** This is only used with the SES service loader.

**Example:** `provider = "su"`

## macroNodes

### macroNodes configuration

Here is an example of the Subscriber Event Service `SES.macroNodes` section of the `eserv.config`.

```
SES = {
    macroNodes = {
        outRoamerContactCheck = {
            optOutProfile = {
                block = 8
                tag = 0x500050
            }
        }
    }
}
```

```

    }
    inRoamerMessagesSelection = {
        generalMessageCache = {
            flushPeriodSeconds = 300
        }
    }
    outRoamerMessagesSelection = {
        generalMessageCache = {
            flushPeriodSeconds = 300
        }
    }
} # end of macroNodes
}

```

## macroNodes parameters

`macroNodes` accepts the following parameters.

### outRoamerContactCheck parameters

The contact check parameters are held within the `optOutProfile` parameter set. There can be as many `optOutProfile` parameter sets as required. Any out-roamer subscribers matching this parameter will be ne sent any messages.

`block`

|                     |  |
|---------------------|--|
| <b>Syntax:</b>      | <code>block = value</code>   |
| <b>Description:</b> | The profile block to use. This is where the flag is stored.  |
| <b>Type:</b>        | Integer  |
| <b>Optionality:</b> | Mandatory  |
| <b>Allowed:</b>     | Numbers 1 to 16 depending on which of the following is required. <ul style="list-style-type: none"> <li>1 VPN Network</li> <li>2 VPN Station</li> <li>3 Customer</li> <li>4 Call Plan</li> <li>5 Global</li> <li>6 CLI Subscriber</li> <li>7 Service Number</li> <li>8 Application Specific 1/CCS Account Reference</li> <li>9 Application Specific 2</li> <li>10 Application Specific 3</li> <li>11 Application Specific 4</li> <li>12 Application Specific 5</li> <li>13 Application Specific 6</li> <li>14 Application Specific 7</li> <li>15 Application Specific 8</li> <li>16 Any Valid</li> </ul> |
| <b>Default:</b>     | 8  |
| <b>Notes:</b>       | For a full description of profile blocks, refer to <i>CPE User's Guide</i> .   |
| <b>Example:</b>     | <code>block = 8</code>   |

`tag`

|                     |   |
|---------------------|---|
| <b>Syntax:</b>      | <code>tag = value</code>                                    |
| <b>Description:</b> | The tag in this profile where the opted out flag is stored. |

|                     |  |
|---------------------|--|
| <b>Type:</b>        | Hex value  |
| <b>Optionality:</b> | Mandatory  |
| <b>Allowed:</b>     | Hex value of any valid tag.  |
| <b>Default:</b>     | 0x500050   |
| <b>Notes:</b>       | This should be the same one as used by the PI for your installation.<br>For a full description of profile tags, refer to the <i>CPE User's Guide</i> . |
| <b>Example:</b>     | <code>tag = 0x500050</code>  |

### **inRoamerMessagesSelection parameters**

This parameter signals how often to update the in-roamer messages cache.

`flushPeriodSeconds`

|                     |  |
|---------------------|--|
| <b>Syntax:</b>      | <code>flushPeriodSeconds = seconds</code>      |
| <b>Description:</b> | How often to reload the general message cache. |
| <b>Type:</b>        | Integer  |
| <b>Optionality:</b> | Mandatory                                      |
| <b>Allowed:</b>     |  |
| <b>Default:</b>     | 300  |
| <b>Notes:</b>       |  |
| <b>Example:</b>     | <code>flushPeriodSeconds = 300</code>          |

`generalMessageCache`

|                     |   |
|---------------------|---|
| <b>Syntax:</b>      | <code>generalMessageCache = {parameter}</code>                              |
| <b>Description:</b> | The general message cache parameters.                                       |
| <b>Type:</b>        | List of parameters.   |
| <b>Optionality:</b> | Mandatory   |
| <b>Allowed:</b>     |   |
| <b>Default:</b>     |   |
| <b>Notes:</b>       |   |
| <b>Example:</b>     | <code>generalMessageCache = {<br/>    flushPeriodseconds = 300<br/>}</code> |

### **outRoamerMessagesSelection parameters**

This parameter signals how often to update the out-roamer messages cache.

`flushPeriodSeconds`

|                     |  |
|---------------------|--|
| <b>Syntax:</b>      | <code>flushPeriodSeconds = seconds</code>      |
| <b>Description:</b> | How often to reload the general message cache. |
| <b>Type:</b>        | Integer  |
| <b>Optionality:</b> | Mandatory                                      |
| <b>Allowed:</b>     |  |
| <b>Default:</b>     | 300  |
| <b>Notes:</b>       |  |
| <b>Example:</b>     | <code>flushPeriodSeconds = 300</code>          |

### generalMessageCache

|                     |   |
|---------------------|---|
| <b>Syntax:</b>      | <code>generalMessageCache = {parameter}</code>                    |
| <b>Description:</b> | The general message cache parameters.                             |
| <b>Type:</b>        | List of parameters.   |
| <b>Optionality:</b> | Mandatory   |
| <b>Allowed:</b>     |   |
| <b>Default:</b>     |   |
| <b>Notes:</b>       |   |
| <b>Example:</b>     | <pre>generalMessageCache = {     flushPeriodseconds = 300 }</pre> |

## dbCleanup

### Introduction

dbCleanup removes messages and old contact information from the database on a regular basis. Refer to *dbCleanup* (on page 61) for more information. The frequency is provided through these parameters.

### dbCleanup configuration

Here is an example of the Subscriber Event Service `SES.dbCleanup` section of the `eserv.config`.

```
SES = {
  dbCleanup = {
    user = "ses_admin"
    password = "ses_admin"
    hour = 0
    contactHistoryDays = 7
    messagesDays = 10
  } # end of dbCleanup
}
```

### dbCleanup parameters

dbCleanup accepts the following parameters.

#### contactHistoryDays

How long to keep SES contact history information for after the text message is sent.

|                 |                              |
|-----------------|------------------------------|
| <b>Default:</b> | 7                            |
| <b>Allowed:</b> | Integer number of days.      |
| <b>Note:</b>    | This parameter is mandatory. |

#### hour

The hour in which to run the clean up.

|                 |   |
|-----------------|---|
| <b>Default:</b> | 0   |
| <b>Allowed:</b> | 0 to 23 to indicate what hour to start in, for example: <ul style="list-style-type: none"><li>• 0 for between midnight and 1am</li><li>• 14 for between 2pm and 3pm</li></ul> |
| <b>Note:</b>    | This parameter is mandatory.  |



**messagesDays**

How long to keep SES messages after they have expired.

**Default:** 10

**Allowed:** Integer number of days.

**Note:** This parameter is mandatory.

**password**

The password of the authorized user.

**Default:** ses\_admin

**Allowed:** ses\_admin

**Note:** This parameter is mandatory.

**user**

The authorized identification that can perform the removal activities.

**Default:** ses\_admin

**Allowed:** ses\_admin

**Note:** This parameter is mandatory.

## serviceLibrary

### serviceLibrary configuration

Here is an example of the Subscriber Event Service `SES.serviceLibrary` section of the `eserv.config`.

```
SES = {
  serviceLibrary = {
    loadAccountReferenceProfile = true
  }
}
```

### serviceLibrary parameters

`serviceLibrary` accepts the following parameter.

**loadAccountReferenceProfile**

Whether to load the profile from the `CCS_ACCT_REFERENCE` table, based on the `MSISDN`.

**Default:** true

**Allowed:** true, false

**Note:** Optional

## SLEE.cfg Configuration

### Lines inserted

The installation of SES inserts the following lines into the installed `SLEE.cfg` file.

```
INTERFACE=sesIf sesTrigger.sh /IN/service_packages/SES/bin EVENT # Added by sesScp
SERVICEKEY=INTEGER 1111 sesIf # Added by sesScp <<< servicekey for the sesTrigger
```

## Chapter 5

```
SERVICEKEY=INTEGER 1121 SES # Added by sesScp <<< servicekey for talking to the SES service
loaded by slee_acs
SERVICE=SES 1 slee_acs SES # Added by sesScp <<< defining the SES service in slee_acs
```

**Note:** The SERVICEKEY lines will need to be modified on most sites.

## acs.conf Configuration

### Lines inserted

The installation of SES inserts the following lines into the installed **acs.conf** file.

```
MacroNodePluginFile libsesMacroNodes.so # Added by sesScp
ServiceEntry (SES,libsesService.so) # Added by sesScp
```

# Background Processes

## Overview

### Introduction

This chapter explains the SES background processes.

### In this chapter

---

This chapter contains the following topics.

|                   |    |
|-------------------|----|
| dbCleanup .....   | 61 |
| Statistics .....  | 61 |
| Replication ..... | 62 |

## dbCleanup

### Introduction

This SMS process is responsible for cleaning up the contact history so that it does not get too big. The amount of contact history it keeps is configurable. See *dbCleanup* (on page 58) for details. It is run from the inittab on non-clustered machines and it is a cluster service on clustered SMSs.

### Stopping and starting the process

Enter the following commands to stop the process:

1. `cd /opt/ESERVsesDbCleanup/util`
2. `./stopsesDbCleanup -h logical_hostname`
3. `scstat | grep sesDbCleanup-harg`  
No records should be returned.

## Statistics

### Introduction

An existing statistics system provides functions for the collection of basic statistical events. This is provided in the NCC SMS application and provisioned at installation. Statistics can be viewed using the SMS application (**Operator Functions > Stats Viewer** menu options), see *Service Management System Technical Guide*.

Below are tables describing each statistic type and event type.

## Statistic types collected

The following statistic types are available for collection. Each statistic event (see *statistic events collected* below) has these six statistics collected.

| Statistic Type                   | Description  |
|----------------------------------|--|
| <i>statistic_event_FAILED</i>    | Triggered to ACS and received a failure response.  |
| <i>statistic_event_REJECTED</i>  | Did not successfully trigger to ACS.               |
| <i>statistic_event_SUCCESS</i>   | Triggered to ACS and received a success response.  |
| <i>statistic_event_THROTTLED</i> | Rejected due to too many outstanding transactions. |
| <i>statistic_event_TIMEOUT</i>   | Triggered to ACS and never heard back.             |
| <i>statistic_event_TOTAL</i>     | Total of all the above events.                     |

## Statistic events collected

The following statistic events are available for collection.

**Note:** Each of these events can have up to six statistics collected.

| Statistic Event                                  | Description   |
|--|---|
| <i>NOTEEMM_LOC_UP_SAME_VLR_StatisticType</i>     | Location update in the same VLR service area.                       |
| <i>NOTEEMM_LOC_UP_OTHER_VLR_StatisticType</i>    | Location update to another VLR service area.                        |
| <i>NOTEEMM_IMSI_ATTACH_StatisticType</i>         | IMSI attach.  |
| <i>NOTEEMM_MS_IMSI_DETACH_StatisticType</i>      | MS initiated IMSI detach (explicit detach).                         |
| <i>NOTEEMM_NET_IMSI_DETACH_StatisticType</i>     | Network initiated IMSI detach (implicit detach).                    |
| <i>NOTEEMM_ROUTE_UP_SAME_SGSN_StatisticType</i>  | Routing area update in the same SGSN service area.                  |
| <i>NOTEEMM_SGSN_UP_NEW_SGSN_StatisticType</i>    | Routing area update to another SGSN service area.                   |
| <i>NOTEEMM_SGSN_DISCONNECT_StatisticType</i>     | Routing area update to other SGSN disconnect by detach.             |
| <i>NOTEEMM_GPRS_ATTACH_StatisticType</i>         | GPRS attach.  |
| <i>NOTEEMM_MS_GPRS_DETACH_StatisticType</i>      | MS initiated GPRS detach.   |
| <i>NOTEEMM_NET_GPRS_DETACH_StatisticType</i>     | Network initiated GPRS detach.                                      |
| <i>NOTEEMM_NET_XFER_MS_UNREACH_StatisticType</i> | Network initiated transfer to the "not reachable for paging" state. |

### Examples:

```
NOTEEMM_LOC_UP_SAME_VLR_FAILED
NOTEEMM_LOC_UP_SAME_VLR_REJECTED
NOTEEMM_LOC_UP_SAME_VLR_SUCCESS
```

## Replication

### Introduction

This topic explains the replication system used for SES. Replication is the system which transfers data between nodes in the IN installation.

## Replicating SES tables

Follow these steps to replicate the SES tables.

| Step | Action |
|------|--------|
|------|--------|

- 1 Select the **Operator Functions > Node Management** menu options from the Service Management System main screen.

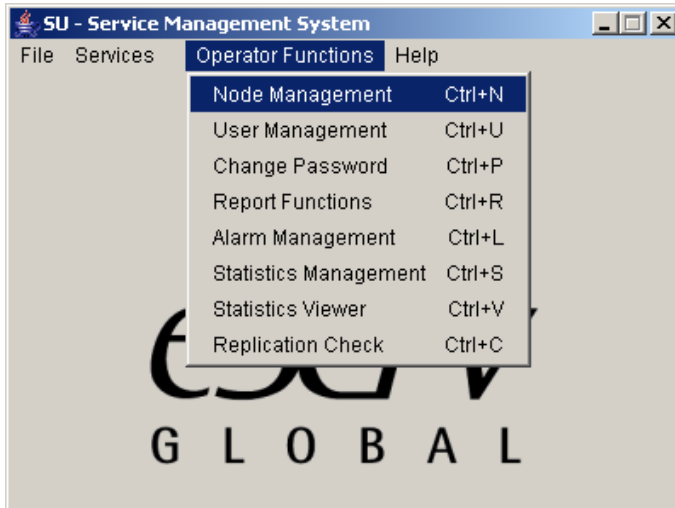

**Result:** The Node Management screen opens.

- 2 Select the **Table Replication** tab.

**Result:** The top level table types are shown.

- 3 Scroll down the left hand panel until the `Ses_Service` type is in view.

- 4 Expand the `Ses_Service` type.

**Result:** The tables for replication are shown.

**Step Action**

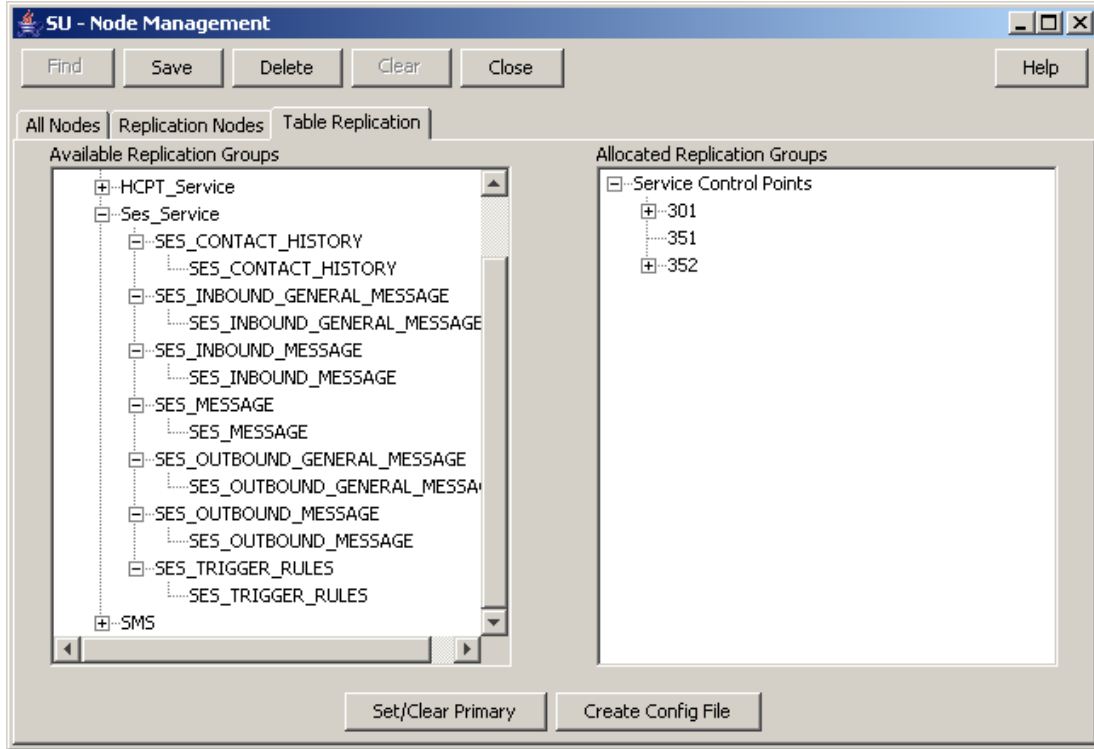

- 5 Select and drag each of the SES Service tables you wish to replicate from the left panel to each of the configured SLC nodes in the Allocated Replication Groups panel.

**Example:**

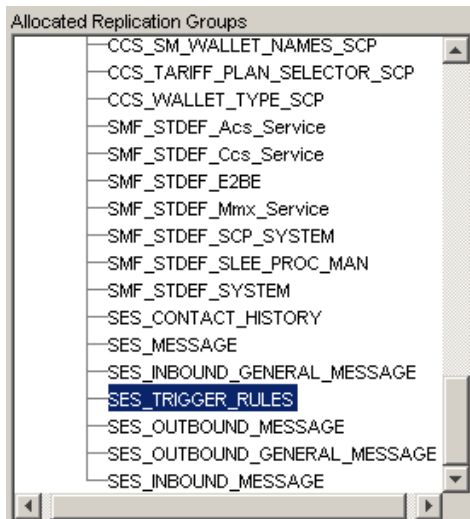

**Tip:** You must select SES\_MESSAGE, before you can select the other message tables.

- 6 Click **Save**.  
**Result:** The replication is saved and the Save Complete confirmation displays.



- 7 Click **OK**.

| Step | Action  |
|------|---|
| 8    | <p>Click <b>Create Config File</b>.</p> <p><b>Result:</b> A new config file is created and pushed out to the relevant nodes enabling the replicated tables to be used, and the confirmation is displayed.</p>  |
| 9    | Click <b>OK</b> .   |
| 10   | Click <b>Close</b> .  |

**Note:** For more information on replication, refer to *Service Management System Technical Guide*.





# About Installation and Removal

## Overview

### Introduction

This chapter provides information about the installed components for the Oracle Communications Network Charging and Control (NCC) application described in this guide. It also lists the files installed by the application that you can check for, to ensure that the application installed successfully.

### In this Chapter

---

This chapter contains the following topics.

Installation and Removal Overview ..... 67

## Installation and Removal Overview

### Introduction

For information about the following requirements and tasks, see *Installation Guide*:

- NCC system requirements
- Pre-installation tasks
- Installing and removing NCC packages

### SES packages

An installation of Subscriber Event Service includes the following packages, on the:

- SMS:
  - sesSms
  - sesCluster (for clustered SMS)
- SLC:
  - sesScp



# Glossary of Terms

## ACS

Advanced Control Services configuration platform.

## ANI

Automatic Number Identification - Term used in the USA by long-distance carriers for CLI.

## CAMEL

Customized Applications for Mobile network Enhanced Logic

This is a 3GPP (Third Generation Partnership Project) initiative to extend traditional IN services found in fixed networks into mobile networks. The architecture is similar to that of traditional IN, in that the control functions and switching functions are remote. Unlike the fixed IN environment, in mobile networks the subscriber may roam into another PLMN (Public Land Mobile Network), consequently the controlling function must interact with a switching function in a foreign network. CAMEL specifies the agreed information flows that may be passed between these networks.

## CC

Country Code. Prefix identifying the country for a numeric international address.

## CCS

- 1) Charging Control Services component.
- 2) Common Channel Signalling. A signalling system used in telephone networks that separates signalling information from user data.

## CLI

Calling Line Identification - the telephone number of the caller. Also referred to as ANI.

## CPE

Control Plan Editor (previously Call Plan Editor) - software used to define the logic and data associated with a call -for example, "if the subscriber calls 0800 *nnnnnn* from a phone at location *xxx* then put the call through to *bb bbb bbbb*".

## DP

Detection Point

## DTMF

Dual Tone Multi-Frequency - system used by touch tone telephones where one high and one low frequency, or tone, is assigned to each touch tone button on the phone.

## FDA

First Delivery Attempt - the delivery of a short message directly to the SME rather than relaying it through the MC.

## **GPRS**

General Packet Radio Service - employed to connect mobile cellular users to PDN (Public Data Network- for example the Internet).

## **GSM**

Global System for Mobile communication.

It is a second generation cellular telecommunication system. Unlike first generation systems, GSM is digital and thus introduced greater enhancements such as security, capacity, quality and the ability to support integrated services.

## **GUI**

Graphical User Interface

## **HLR**

The Home Location Register is a database within the HPLMN (Home Public Land Mobile Network). It provides routing information for MT calls and SMS. It is also responsible for the maintenance of user subscription information. This is distributed to the relevant VLR, or SGSN (Serving GPRS Support Node) through the attach process and mobility management procedures such as Location Area and Routing Area updates.

## **HPLMN**

Home PLMN

## **HTTP**

Hypertext Transport Protocol is the standard protocol for the carriage of data around the Internet.

## **IDP**

INAP message: Initial DP (Initial Detection Point)

## **IMSI**

International Mobile Subscriber Identifier. A unique identifier allocated to each mobile subscriber in a GSM and UMTS network. It consists of a MCC (Mobile Country Code), a MNC (Mobile Network Code) and a MSIN (Mobile Station Identification Number).

The IMSI is returned by the HLR query (SRI-SM) when doing FDA. This tells the MSC exactly who the subscriber is that the message is to be sent to.

## **IN**

Intelligent Network

## **INAP**

Intelligent Network Application Part - a protocol offering real time communication between IN elements.

## **Initial DP**

Initial Detection Point - INAP Operation. This is the operation that is sent when the switch reaches a trigger detection point.

## **In-Roamer**

A roaming subscriber entering a mobile phone network.

## **IP**

1) Internet Protocol

2) Intelligent Peripheral - This is a node in an Intelligent Network containing a Specialized Resource Function (SRF).

## **ISDN**

Integrated Services Digital Network - set of protocols for connecting ISDN stations.

## **ITU**

International Telecommunication Union

## **MAP**

Mobile Application Part - a protocol which enables real time communication between nodes in a mobile cellular network. A typical usage of the protocol would be for the transfer of location information from the VLR to the HLR.

## **MC**

Message Centre. Also known as SMSC.

## **MCC**

Mobile Country Code. In the location information context, this is padded to three digits with leading zeros. Refer to ITU E.212 ("Land Mobile Numbering Plan") documentation for a list of codes.

## **MNC**

Mobile Network Code. The part of an international address following the mobile country code (MCC), or at the start of a national format address. This specifies the mobile network code, that is, the operator owning the address. In the location information context, this is padded to two digits with a leading zero. Refer to ITU E.212 ("Land Mobile Numbering Plan") documentation for a list of codes.

## **MS**

Mobile Station

## **MSC**

Mobile Switching Centre. Also known as a switch.

## **MSIN**

Mobile Station Identification Number.

## **MSISDN**

Mobile Station ISDN number. Uniquely defines the mobile station as an ISDN terminal. It consists of three parts; the country code (CC), the national destination code (NDC) and the subscriber number (SN).

## **MT**

Mobile Terminated

## **Out-Roamer**

A roaming subscriber leaving their mobile phone network.

## **PI**

Provisioning Interface - used for bulk database updates/configuration instead of GUI based configuration.

## **PIN**

Personal Identification Number

## **PLMN**

Public Land Mobile Network

## **SCP**

Service Control Point. Also known as SLC.

## **Service Provider**

See Telco.

## **SES**

Subscriber Event Service is an application that enables a service provider to send text messages to roaming subscribers (both their own and foreign subscribers) when they roam in and out of their network.

## **SGSN**

Serving GPRS Support Node

## **SLC**

Service Logic Controller (formerly UAS).

## **SLEE**

Service Logic Execution Environment

## **SME**

Short Message Entity - This is an entity which may send or receive short messages. It may be located in a fixed network, a mobile, or an SMSC.

## **SMS**

Depending on context, can be:

- Service Management System hardware platform

- Short Message Service
- Service Management System platform
- NCC Service Management System application

## **SN**

Service Number

## **SRF**

Specialized Resource Function – This is a node on an IN which can connect to both the SSP and the SLC and delivers additional special resources into the call, mostly related to voice data, for example play voice announcements or collect DTMF tones from the user. Can be present on an SSP or an Intelligent Peripheral (IP).

## **SRI**

Send Routing Information - This process is used on a GSM network to interrogate the HLR for subscriber routing information.

## **SSP**

Service Switching Point

## **System Administrator**

The person(s) responsible for the overall set-up and maintenance of the IN.

## **TCP**

Transmission Control Protocol. This is a reliable octet streaming protocol used by the majority of applications on the Internet. It provides a connection-oriented, full-duplex, point to point service between hosts.

## **Telco**

Telecommunications Provider. This is the company that provides the telephone service to customers.

## **Telecommunications Provider**

See Telco.

## **VLR**

Visitor Location Register - contains all subscriber data required for call handling and mobility management for mobile subscribers currently located in the area controlled by the VLR.

## **VPN**

The Virtual Private Network product is an enhanced services capability enabling private network facilities across a public telephony network.

## **VWS**

Oracle Voucher and Wallet Server (formerly UBE).





# Index

## A

- About Installation and Removal • 67
- About This Document • v
- Accessing SES • 14
- Accessing SMS • 13
- Accessing Subscriber Event Service
  - Configuration • 13
- ACS • 69
- acs.conf Configuration • 60
- adapters • 46
- Adding new inbound general messages • 21
- Adding new inbound messages • 24, 25
- Adding new messages • 18, 20
- Adding new outbound general messages • 26
- Adding new outbound messages • 29, 30
- Adding new trigger rules • 32, 34
- ANI • 69
- Architectural diagram • 10
- Audience • v

## B

- Background Processes • 61
- balance\_amount\_index • 49
- balance\_service\_key • 49
- balance\_type\_index • 49
- block • 56

## C

- called\_party\_noa • 50
- CAMEL • 69
- CC • 69
- CCS • 69
- CLI • 69
- Configuration • 43
- Configuration File Format • 43
- connection\_timeout • 50
- Contact History • 34
- Contact History tab • 35
- Contact tab columns • 35
- contactHistoryDays • 58
- Copyright • ii
- CPE • 69

## D

- databaseLogin • 47
- dbCleanup • 20, 34, 58, 61
- dbCleanup configuration • 58
- dbCleanup parameters • 58
- Deleting inbound general messages • 22
- Deleting inbound messages • 25
- Deleting messages • 20
- Deleting outbound general messages • 27
- Deleting outbound messages • 30

- Deleting trigger rules • 34
- Document Conventions • vi
- DP • 69
- DTMF • 69

## E

- Editing inbound general messages • 22
- Editing inbound messages • 24
- Editing messages • 20
- Editing outbound general messages • 27
- Editing outbound messages • 29
- Editing the File • 44
- Editing trigger rules • 33
  - enabled • 54
- eserv.config Configuration • 43
- eserv.config Files Delivered • 44
- event\_class • 54
- event\_type • 54
- Example Control Plan - In-Roamer • 39
- Example Control Plan - Out-Roamer • 40
- Example in-roaming control plan • 5
- Example out-roaming control plan • 7
- Example scenarios • 3

## F

- faked\_call\_party • 50
- FDA • 69
- flushPeriodSeconds • 57
- function • 48, 50

## G

- General screen information • 15
- generalMessageCache • 57, 58
- Getting Started • 13
- GPRS • 70
- GSM • 70
- GUI • 70

## H

- HLR • 70
- hour • 58
- HPLMN • 70
- HTTP • 70

## I

- IDP • 70
- IMSI • 70
- IN • 70
- INAP • 70
- Inbound General Messages • 4, 21
- Inbound General Messages tab • 21
- Inbound general messages tab columns • 21
- Inbound Messages • 4, 23
- Inbound Messages tab • 23
- Inbound messages tab columns • 23
- Initial DP • 70

- In-Roamer • 71
- inRoamerMessagesSelection parameters • 57
- In-roaming control plan • 40
- In-roaming control plan process • 39
- In-Roaming diagram • 2
- Installation and Removal Overview • 67
- Introduction • 1, 17, 21, 23, 25, 28, 30, 34, 43, 58, 61, 62, 67
- IP • 71
- ISDN • 71
- ITU • 71

## L

- library • 48, 50
- Lines inserted • 59, 60
- listen\_port • 51
- loadAccountReferenceProfile • 59
- Loading eserv.config Changes • 44
- log • 51
- Logging into SMS • 14

## M

- macroNodes • 55
- macroNodes configuration • 55
- macroNodes parameters • 56
- MAP • 71
- maxOutstanding • 47
- MC • 71
- MCC • 71
- Message rules • 3
- Messages • 17, 22, 24, 27, 29
- Messages tab • 18
- Messages tab columns • 18
- messagesDays • 59
- MNC • 71
- MS • 71
- MSC • 71
- MSIN • 71
- msisdh • 54
- MSISDN • 71
- MT • 72

## N

- Network diagram • 3
- notemm adapter parameters • 48

## O

- Outbound General Messages • 4, 25
- Outbound General Messages tab • 26
- Outbound general messages tab columns • 26
- Outbound Messages • 4, 28
- Outbound Messages tab • 28
- Outbound messages tab columns • 28
- Out-Roamer • 72
- outRoamerContactCheck parameters • 56
- outRoamerMessagesSelection parameters • 57

- Out-roaming control plan • 41
- Out-roaming control plan process • 40
- Out-Roaming diagram • 2
- Overview • 1, 13, 17, 39, 43, 61, 67

## P

- password • 59
- performanceReportPeriod • 51
- PI • 72
- pin • 55
- PIN • 72
- plan • 55
- PLMN • 72
- pollTime • 47
- Prerequisites • v
- provider • 55

## R

- redeem\_amount\_index • 51
- redeem\_type\_index • 52
- rejectLevel • 52
- rejectLevelReportPeriod • 52
- Related Documents • v
- reloadInterval • 48
- remote\_hosts • 52
- Replicating SES tables • 63
- Replication • 62
- Restarting • 44
- rules parameters • 53

## S

- Scenario 1 • 5
- Scenario 2 • 6
- Scenario 3 • 7
- Scenario 4 • 8
- Scenario 5 • 9
- Scope • v
- SCP • 72
- Service Provider • 72
- serviceKey • 48, 53
- serviceLibrary • 59
- serviceLibrary configuration • 59
- serviceLibrary parameters • 59
- SES • 72
- SES configuration diagram • 10
- SES Configuration Screens • 17
- SES packages • 67
- sesTrigger • 30, 44
- sesTrigger configuration • 44
- sesTrigger parameters • 46
- SGSN • 72
- SLC • 72
- SLEE • 72
- SLEE.cfg Configuration • 59
- SME • 72
- SMS • 72
- SMS Login screen • 14

- SN • 73
- SRF • 73
- SRI • 73
- SSP • 73
- Statistic events collected • 62
- Statistic types collected • 62
- Statistics • 61
- Stopping and starting the process • 61
- Subscriber Event Service • 1
- System Administrator • 73
- System Overview • 1

## **T**

- tag • 56
- TCP • 73
- Telco • 73
- Telecommunications Provider • 73
- timeout • 48, 53
- Trigger Rules • 11, 30
- Trigger Rules tab • 31
- Trigger rules tab columns • 31
- Typographical Conventions • vi

## **U**

- user • 59
- Using SES Feature Nodes • 39

## **V**

- Viewing contact history • 35, 36
- VLR • 73
- voucher\_service\_key • 53
- VPN • 73
- VWS • 73

## **X**

- xml\_subscriber adapter parameters • 49