

**Oracle® Communications
Convergent Charging Controller**

Provisioning Interface User's and Technical Guide

Release 12.0.1

April 2018

Copyright

Copyright © 2018, Oracle and/or its affiliates. All rights reserved.

This software and related documentation are provided under a license agreement containing restrictions on use and disclosure and are protected by intellectual property laws. Except as expressly permitted in your license agreement or allowed by law, you may not use, copy, reproduce, translate, broadcast, modify, license, transmit, distribute, exhibit, perform, publish, or display any part, in any form, or by any means. Reverse engineering, disassembly, or decompilation of this software, unless required by law for interoperability, is prohibited.

The information contained herein is subject to change without notice and is not warranted to be error-free. If you find any errors, please report them to us in writing.

If this is software or related documentation that is delivered to the U.S. Government or anyone licensing it on behalf of the U.S. Government, then the following notice is applicable:

U.S. GOVERNMENT END USERS: Oracle programs, including any operating system, integrated software, any programs installed on the hardware, and/or documentation, delivered to U.S. Government end users are "commercial computer software" pursuant to the applicable Federal Acquisition Regulation and agency-specific supplemental regulations. As such, use, duplication, disclosure, modification, and adaptation of the programs, including any operating system, integrated software, any programs installed on the hardware, and/or documentation, shall be subject to license terms and license restrictions applicable to the programs. No other rights are granted to the U.S. Government.

This software or hardware is developed for general use in a variety of information management applications. It is not developed or intended for use in any inherently dangerous applications, including applications that may create a risk of personal injury. If you use this software or hardware in dangerous applications, then you shall be responsible to take all appropriate fail-safe, backup, redundancy, and other measures to ensure its safe use. Oracle Corporation and its affiliates disclaim any liability for any damages caused by use of this software or hardware in dangerous applications.

Oracle and Java are registered trademarks of Oracle and/or its affiliates. Other names may be trademarks of their respective owners.

Intel and Intel Xeon are trademarks or registered trademarks of Intel Corporation. All SPARC trademarks are used under license and are trademarks or registered trademarks of SPARC International, Inc. AMD, Opteron, the AMD logo, and the AMD Opteron logo are trademarks or registered trademarks of Advanced Micro Devices. UNIX is a registered trademark of The Open Group.

This software or hardware and documentation may provide access to or information about content, products, and services from third parties. Oracle Corporation and its affiliates are not responsible for and expressly disclaim all warranties of any kind with respect to third-party content, products, and services unless otherwise set forth in an applicable agreement between you and Oracle. Oracle Corporation and its affiliates will not be responsible for any loss, costs, or damages incurred due to your access to or use of third-party content, products, or services, except as set forth in an applicable agreement between you and Oracle.

Contents

About This Document	v
Document Conventions	vi
Chapter 1	
System Overview	1
Overview	1
Introduction to the Provisioning Interface	1
PI Commands	4
Chapter 2	
Configuration.....	5
Overview.....	5
Configuration Overview	5
eserv.config Configuration.....	6
About Configuring PI Commands in eserv.config	31
Defining the Screen Language.....	38
Defining the Help Screen Language	40
Defining a Password Policy	41
Chapter 3	
PI Administration Screen.....	43
Overview.....	43
PI Administration Screen	43
PI Commands.....	44
PI Hosts	46
PI MAC Pairs	49
PI Users	51
PI Ports.....	55
Chapter 4	
PI Tester Screen	59
Overview.....	59
PI Tester Screen.....	59
General	60
Management Tests.....	62
Connection tests.....	63
Chapter 5	
Background Processes	65
Overview.....	65
PImanager	65
PIprocess.....	67
PIbeClient	68
PIbatch	68
PIbatch XML	70
Pluser	72

Chapter 6

PI Management Commands 73

Overview.....	73
Debug Command	73
Traceon Command.....	75
Traceoff Command.....	76
State Command.....	76
Kill Command	76
Sendrate Command	77
Logstats on/off Command	78

Chapter 7

About Installation and Removal 81

Overview.....	81
Installation and Removal Overview	81
Checking the Installation	82

Glossary of Terms 85

Index 89

About This Document

Scope

The scope of this document includes all the information required to install, configure and administer the provisioning interface (PI) application. It does not include detailed design of the service.

Audience

This guide was written primarily for system administrators and persons installing, configuring and administering the PI application. However, sections of the document may be useful to anyone requiring an introduction to the application.

Prerequisites

A solid understanding of Unix and a familiarity with IN concepts are an essential prerequisite for safely using the information contained in this technical guide. Attempting to install, remove, configure or otherwise alter the described system without the appropriate background skills, could cause damage to the system; including temporary or permanent incorrect operation, loss of service, and may render your system beyond recovery.

This manual describes system tasks that should only be carried out by suitably trained operators.

Related Documents

The following documents are related to this document:

- *ACS Provisioning Interface Commands*
- *CCS Provisioning Interface Commands*
- *MM Provisioning Interface Commands*
- *NP Provisioning Interface Commands*
- *VPN Provisioning Interface Commands*
- *Charging Control Services Technical Guide*
- *Service Management System Technical Guide*
- *Voucher and Wallet Server Technical Guide*

Document Conventions

Typographical Conventions

The following terms and typographical conventions are used in the Oracle Communications Convergent Charging Controller documentation.

Formatting Convention	Type of Information
Special Bold	Items you must select, such as names of tabs. Names of database tables and fields.
<i>Italics</i>	Name of a document, chapter, topic or other publication. Emphasis within text.
Button	The name of a button to click or a key to press. Example: To close the window, either click Close , or press Esc .
Key+Key	Key combinations for which the user must press and hold down one key and then press another. Example: Ctrl+P or Alt+F4 .
Monospace	Examples of code or standard output.
Monospace Bold	Text that you must enter.
<i>variable</i>	Used to indicate variables or text that should be replaced with an actual value.
menu option > menu option >	Used to indicate the cascading menu option to be selected. Example: Operator Functions > Report Functions
hypertext link	Used to indicate a hypertext link.

Specialized terms and acronyms are defined in the glossary at the end of this guide.

System Overview

Overview

Introduction

This chapter provides a high-level overview of the application. It explains the basic functionality of the system and lists the main components.

It is not intended to advise on any specific Oracle Communications Convergent Charging Controller network or service implications of the product.

In this Chapter

This chapter contains the following topics.

Introduction to the Provisioning Interface	1
PI Commands	4

Introduction to the Provisioning Interface

Introduction

The Provisioning Interface (PI) provides a mechanism for manipulating data in the SMF database using an API. It enables bulk or scripted operations on the SMF data to be completed, where a human operator using the Java administration screens would be inefficient or error-prone.

The PI provides a reliable, extensible, network aware interface based on interoperability standards (for example XML).

Component diagram

This diagram shows the PI components and processes.

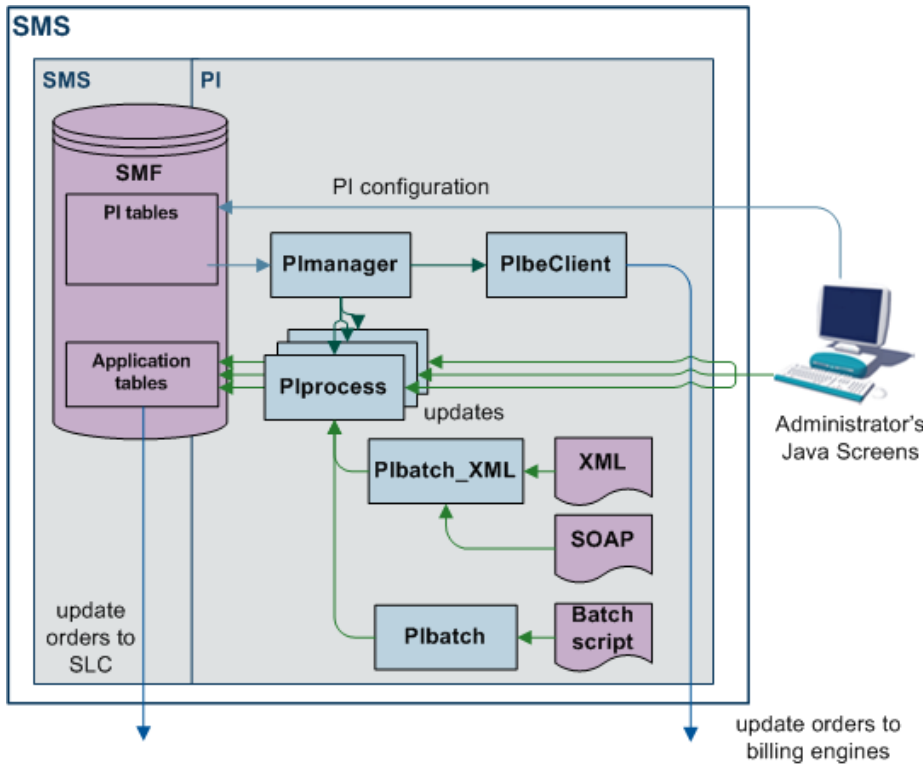

Component descriptions

This table describes the main components involved in the Provisioning Interface application.

Component	Description	Further Information
SMF database	The main SMF database holds the configuration details which are updated by the PI and some PI configuration details. The SMF holds configuration data for: <ul style="list-style-type: none"> • The system • Client accounts • Services 	<i>SMS Technical Guide</i>
PI Administration screens	Enables an administrator to interact with the SMF database. The PI screens enable you to add new PI commands, users and hosts to the system and send test messages to specific PI processes.	<i>PI Administration Screen (on page 43)</i>
PI Tester screens	Test the system by sending individual commands to PI processes.	<i>PI Tester Screen (on page 59)</i>
Plmanager	Starts and stops PI processes. Plmanager will start as many Plprocesses as specified in the PI_PORTS table on the SMF database.	<i>Plmanager (on page 65)</i>
Plprocess	Runs on an SMS listening at a specific port for PI commands.	<i>Plprocess (on page 67)</i>
Plbatch	Sends multiple PI commands to the Plprocesses. Plbatch can take instructions from a batch file, enabling	<i>Plbatch (on page 68)</i>

Component	Description	Further Information
	complex treatments of the data in the SMF database to take place.	
PIbatch_XML	Sends multiple PI commands to the PIprocesses. PIbatch_XML takes instructions from XML and SOAP files.	<i>PIbatch XML</i> (on page 70)
eserv.config	The configuration file for PI. Note: Not all installations require this file to be configured.	eserv.config Configuration (on page 6)

Process

This table describes the process involved in running a PI command.

Note: The security/authentication parts of this process will only happen if the security plug-in is active in your deployment.

Step	Action
1	The first message sent to the server to start a new connection is a login message. Note: All communication between the client and the SMS uses the ASCII, HTTP/1.1, or HTTPS/1.1 protocol over TCP/IP. This enables all messages to be passed on a single connection for the duration of the session.
2	On successful login, the server will optionally send a security token. If security is used, then this token should be included in future request messages to confirm authentication.
3	A client system sends PI command to the relevant network port on the SMS.
4	The server process will check the authentication state, if configured to do so, and pass the requested command to the appropriate handler.
5	The server will respond on the same network connection with a message containing the response. The response will consist of any returned data, and, if configured, the new security token for use in future messages to the PI.
6	An end session command will be sent from either the server or the client to the other party.
7	The session is closed.

Triggering BPL tasks

This process describes how a PI command triggers a BPL task.

For more information about BPL tasks, see *CCS User's Guide* and *CCS Technical Guide*.

Stage	Description
1	A client system sends the CCSBPL command to the relevant network port on the SMS.
2	The <i>PIprocess</i> (on page 67) for that port calls the libPI_CCSBPL library and sends the request to the smsTrigDaemon to trigger the BPL task process. For more information about the BPL task process, see <i>SMS Technical Guide</i> .
3	When the BPL has been processed, the smsTrigDaemon returns the result of the command to PIprocess.
4	PIprocess translates the response into a PI command response for the CCSBPL

Stage	Description
	command and returns it to the client system.

PI Commands

Introduction

The provisioning interface uses TCP/IP-based UNIX sockets to receive provisioning commands and parameters. These are translated into SQL commands that update prepaid application tables of the SMF and E2BE Oracle databases.

Note: The output from the PI command is limited to 2,000 characters. When the output exceeds this limit, the output is truncated to the "<command>:ACK" message.

PI command installation

The PI commands which are available depend on which packages were run when the PI was installed. For details about the commands available for your installation, see the PI commands guide for your applications.

Example: For the commands for CCS, see CCS Provisioning Interface Commands

Command package details

This table shows the functionality installed by each package.

Functionality	Required	Package
Framework to execute a PI command.	Required	piSms
Core CCS commands and VWS client.	Required	piCcsSms
Command definitions for a subscriber domain.	Optional	piSubscriberSms
Command definitions for a wallet domain.	Optional	piWalletSms
Command definitions for a voucher domain.	Optional	piVoucherSms
Command definitions for the Social Networking Service Template.	Optional	piSrmSms

For more information about installing these packages, see *Installation and Removal Overview* (on page 81).

Configuration

Overview

Introduction

This chapter explains how to configure the Oracle Communications Convergent Charging Controller application.

In this chapter

This chapter contains the following topics.

Configuration Overview	5
eserv.config Configuration	6
About Configuring PI Commands in <code>eserv.config</code>	31
Defining the Screen Language	38
Defining the Help Screen Language	40
Defining a Password Policy	41

Configuration Overview

Introduction

Most of the configuration required to set up the PI is completed automatically when the packages are installed, or when the configuration scripts are run. However, some tasks must be completed by hand after the packages have been installed.

Configuration components

This table describes the configuration required to configure the PI.

Component	Description	Further information
<code>eserv.config</code>	This file provides a centralized location for configuring Convergent Charging Controller software, including PI. This file should be updated with any relevant details from the <code>eserv.config.pi_example</code> file added during installation.	<i>eserv.config Configuration</i> (on page 6)
PI administration screens	PI uses Java screens to administer user accounts, connections and commands. These screens will be populated with data entered during the installation, but may require additional configuration.	<i>PI Administration Screen</i> (on page 43)

eserv.config Configuration

Introduction

The **eserv.config** file is a shared configuration file, from which many Oracle Communications Convergent Charging Controller applications read their configuration. Each Convergent Charging Controller machine (SMS, SLC, and VWS) has its own version of this configuration file, containing configuration relevant to that machine. The **eserv.config** file contains different sections; each application reads the sections of the file that contains data relevant to it.

The **eserv.config** file is located in the `/IN/service_packages/` directory.

The **eserv.config** file format uses hierarchical groupings, and most applications make use of this to divide the options into logical groupings.

Configuration File Format

To organize the configuration data within the **eserv.config** file, some sections are nested within other sections. Configuration details are opened and closed using either `{ }` or `[]`.

- Groups of parameters are enclosed with curly brackets – `{ }`
- An array of parameters is enclosed in square brackets – `[]`
- Comments are prefaced with a `#` at the beginning of the line

To list things within a group or an array, elements must be separated by at least one comma or at least one line break. Any of the following formats can be used, as in this example:

```
{ name="route6", id = 3, prefixes = [ "00000148", "0000473" ] }
{ name="route7", id = 4, prefixes = [ "000001049" ] }
```

or

```
{ name="route6"
  id = 3
  prefixes = [
    "00000148"
    "0000473"
  ]
}
{ name="route7"
  id = 4
  prefixes = [
    "000001049"
  ]
}
```

or

```
{ name="route6"
  id = 3
  prefixes = [ "00000148", "0000473" ]
}
{ name="route7", id = 4
  prefixes = [ "000001049" ]
}
```

eserv.config Files Delivered

Most applications come with an example **eserv.config** configuration in a file called **eserv.config.example** in the root of the application directory, for example, `/IN/service_packages/eserv.config.example`.

Editing the File

Open the configuration file on your system using a standard text editor. Do not use text editors, such as Microsoft Word, that attach control characters. These can be, for example, Microsoft DOS or Windows line termination characters (for example, ^M), which are not visible to the user, at the end of each row. This causes file errors when the application tries to read the configuration file.

Always keep a backup of your file before making any changes to it. This ensures you have a working copy to which you can return.

Loading eserv.config Changes

If you change the configuration file, you must restart the appropriate parts of the service to enable the new options to take effect.

eserv.config.pi_example

The PI comes with an example of the PI's **eserv.config** configuration in a file called **eserv.config.pi_example** in the root of the application directory. This example configuration should be copied into the main **eserv.config** file to provide a base for the application's configuration.

Optional sections in eserv.config

Some sections of the **eserv.config** file are only required if your deployment has a specific component. For example, the `PIbeClient` section is required only if a VWS Voucher and Wallet Server is used.

eserv.config subsections

The `pi` section of the **eserv.config** file has the following structure.

```
pi = {
  general = {}

  authentication = {}

  throttling = {}

  PIbeClient = {}

  ssl = {}

  soap = {}
}
```

Parameters for each subsection are described below.

General

Here is an example of the general sub section of the PI **eserv.config** configuration.

```
general = {
  # debug = 'N'
  # oraUser = "/"
  # synstamp = 'Y'
  # timeout = 30
  # logLevel = 0
  # securityPlugin = ""
  # correlationRequestTagName = "CORRELATE"
  # correlationResponseTagName = "CORRELATE"
}
```

Chapter 2

The parameters are described in detail below.

`coreWhenProcessUnresponsive`

Syntax: `coreWhenProcessUnresponsive = true|false`
Description: Specifies how the PImanager process responds when PImanager process is unresponsive.
Type: Boolean
Optionality: Optional (default used if not set)
Allowed:

- `true` – PImanager sends a SIGABRT signal when PImanager process is unresponsive.
- `false` – PImanager sends a SIGTERM signal when PImanager process is unresponsive.

Default: `False`
Notes:
Example: `coreWhenProcessUnresponsive = true`

`correlationRequestTagName`

Syntax: `correlationRequestTagName = "name"`
Description: The expected correlation tag in the XML message.
Type: String
Optionality: Optional (default used if not set).
Allowed:
Default: `"CORRELATE"`
Notes:
Example: `correlationRequestTagName = "CORRELATE"`

`correlationResponseTagName`

Syntax: `correlationResponseTagName = "name"`
Description: The expected correlation tag in the XML response.
Type: String
Optionality: Optional (default used if not set).
Allowed:
Default: `'correlationRequestTagName'` value
Notes: If not set it will be the value on `'correlationRequestTagName'`.
Example: `correlationResponseTagName = "CORRELATE"`

`debug`

Syntax: `debug = Y|N`
Description: Turn debug on or off.
Type: String
Optionality: Optional (default used if not set).
Allowed:
Default: `N`
Notes: Only turn on in extreme circumstances as it turns on debug for all parts of PI.
Command line equivalent: `"-D"` (Y), missing (N).
Example: `debug = 'N'`

`loglevel`

Switches the PIprocess trace on or off.

Default: 0

Allowed: 1 switches the PIprocess trace on.
0 switches the PIprocess trace off

`oraUser`

Defines the Oracle user name and password.

Default: "/"

Note: This parameter is not usually required as the default "/" is correct.
Command line equivalent: "-u /"

`securityPlugin`

The name of any security plug-in used.

Default: ""

Allowed: string

`synstamp`

Turns the synstamp on or off.

Default: Y

Allowed: Y turns synstamp on
N turns synstamp off

Note: Command line equivalent of "-s Y".

`timeout`

The maximum allowed time, in seconds, for a PI command. If, for example, you set `timeout = 30`, timeout will occur after 30 seconds.

Default: -1

Allowed: -1 No timeout.
positive integer Seconds before timeout.

Note: The command line equivalent would be "-t 30".

authentication

The authentication subsection of the PI `eserv.config` configuration supports these parameters.

```
authentication = {
    timeout = 0
    noAuthTokenForAnyPIError = false
}
```

The parameter is described in detail below.

`timeout`

Syntax: `timeout = seconds`

Description: Authentication token timeout.

Type: Integer

Optionality: Optional (default used if not set).

Allowed:

Default: 0 (no timeout)
Notes:
Example: `timeout = 0`

`noAuthTokenForAnyPIError`

Syntax: `noAuthTokenForAnyPIError = True | False`
Description: Specifies whether the PI returns an authentication token when an error condition occurs.
Type: Boolean
Optionality: Optional
Allowed: `true` The PI does not return an authentication token when an error condition occurs.
`false` The PI returns an authentication token when an error condition occurs.
Default: `false`
Notes:
Example: `noAuthTokenForAnyPIError = False`

Throttling

The throttling subsection of the PI `eserv.config` configuration supports these parameters.

```
throttling = {
    sendRate = 0<int>
}
```

The parameter is described in detail below.

`sendRate`

The maximum number of PI commands per second.

Default: 0
Allowed: 0 no limit
 positive integer commands per second.

PIbeClient

The `PIbeClient` section of the `eserv.config` file configures the *PIbeClient* (on page 68) process. Here is the structure of the section.

```
PIbeClient = {
    namedEventCanSendDebitBalanceNegative = 'n|y'
    oracleLogin = "usr/pwd"

    beLocationPlugin = "lib"
    clientName = "name"

    heartbeatPeriod = microsecs
    messageTimeoutSeconds = seconds
    maxOutstandingMessages = int
    reportPeriodSeconds = seconds
    connectionRetryTime = seconds

    plugins = [
        {
            config="confStr",
            library="lib",
```



```

        function="str"
    }
    [...]
]

confStr = {
    plug-in_configuration
}

notEndActions = [
    {type="str", action="[ACK |NACK]"}
    [...]
]
}

```

The parameters are described in detail below.

clientName

Syntax: `clientName = "name"`

Description: The unique client name of the process.

Type: String

Optionality: Required

Allowed: Must be unique

Default: The hostname of the local machine.

Notes: The server generates `clientId` from a hash of `name`.
If more than one client attempts to connect with the same name, then some connections will be lost.
This parameter is used by `libBeClientIF`.

Example: `clientName = "PIbeClient"`

connectionRetryTime

Syntax: `connectionRetryTime = seconds`

Description: The maximum number of seconds the client process will wait for a connection to succeed before attempting a new connection.

Type: Integer

Optionality: Required

Allowed:

Default: 5

Notes: This parameter is used by `libBeClientIF`.

Example: `connectionRetryTime = 2`

heartbeatPeriod

Syntax: `heartbeatPeriod = microseconds`

Description: The number of microseconds during which a Voucher and Wallet Server heartbeat message must be detected, or the `BeClient` process will switch to the other VWS in the pair.

Type: Integer

Optionality: Required

Allowed: 0 Disable heartbeat detection.
positive integer Heartbeat period.

Default: 3000000

Chapter 2

Notes: 1 000 000 microseconds = 1 second.
If no heartbeat message is detected during the specified time, client process switches to the other Voucher and Wallet Server in the pair.
This parameter is used by libBeClientIF.

Example: `heartbeatPeriod = 10000000`

`maxOutstandingMessages`

Syntax: `maxOutstandingMessages = num`

Description: The maximum number of messages allowed to be waiting for a response from the Voucher and Wallet Server.

Type: Integer

Optionality: Required

Allowed:

Default: If this parameter is not set, the maximum is unlimited.

Notes: If more than this number of messages are waiting for a response from the Voucher and Wallet Server, the client process assumes the Voucher and Wallet Server is overloaded. In this event, the client process refuses to start new calls but continues to service existing calls.

The messages are queued until the Voucher and Wallet Server has reduced its outstanding load.

This parameter is used by libBeClientIF.

Example: `maxOutstandingMessages = 100`

`messageTimeoutSeconds`

Syntax: `messageTimeoutSeconds = seconds`

Description: The time that the client process will wait for the server to respond to a request.

Type: Integer

Units: Seconds

Optionality: Required

Allowed: 1-604800 Number of seconds to wait.

0 Do not time out.

Default: 2

Notes: After the specified number of seconds, the client process will generate an exception and discard the message associated with the request.

This parameter is used by libBeClientIF.

Example: `messageTimeoutSeconds = 2`

`namedEventCanSendDebitBalanceNegative`

Determines whether a named billable event charge can be sent a negative debit balance.

Default: n

Allowed: y negatives will be allowed

Y negatives will be allowed

n only positives will be allowed

`notEndActions`

Syntax: `notEndActions = [`
 `{type="str", action="[ACK|NACK]"}`
 `[...]`
`]`

Description: The `notEndActions` parameter array is used to define the messages associated with dialogs that should not have their dialog closes, because the dialog is closed by default. This facilitates failover.

Type: Parameter array.

Optionality: Required

Allowed:

Default:

Notes: If the incoming dialog for a call closes and the last response received was of the `notEndActions` type, the client process sends an ABRT message. The ABRT message allows the VWS to remove the reservation. An example of this situation would be where `slee_acs` has stopped working.

This parameter is used by `libBeClientIF`.

For more information about `slee_acs`, see *ACS Technical Guide*.

Example:

```
notEndActions = [
    {type="IR ", action="ACK "}
    {type="SR ", action="ACK "}
    {type="SR ", action="NACK"}
    {type="INER", action="ACK "}
    {type="SNER", action="ACK "}
    {type="SNER", action="NACK"}
]
```

`action`

Syntax:

Description: Action to take with a message.

Type:

Optionality:

Allowed:

- "NACK"
- "ACK"

Default:

Notes:

Example:

`type`

The type of message.

`oracleLogin`

Identifies the `PlbeClient` when it logs on to the database.

Default: `"/"`

Chapter 2

plugins

Syntax:	<pre>plugins = [{ config="" library="lib" function="str" } ...]</pre>
Description:	Defines any client process plug-ins to run. Also defines the string which maps to their configuration section.
Type:	Parameter array
Optionality:	Optional (as plug-ins will not be loaded if they are not configured here, this parameter must include any plug-ins which are needed to supply application functions; for more information about which plug-ins to load, see the <code>BeClient</code> section for the application which provides the <code>BeClient</code> plug-ins).
Allowed:	
Default:	Empty (that is, do not load any plug-ins).
Notes:	The <code>libclientBcast</code> plug-in must be placed last in the plug-ins configuration list. For more information about the <code>libclientBcast</code> plug-in, see <code>libclientBcast</code> . This parameter is used by <code>libBeClientIF</code> .
Example:	<pre>plugins = [{ config="broadcastOptions" library="libclientBcast.so" function="makeBroadcastPlugin" }]</pre>

config

Syntax:	<code>config="name"</code>
Description:	The name of the configuration section for this plug-in. This corresponds to a configuration section within the <code>plugins</code> section in the <code>eserv.config</code> file.
Type:	String
Optionality:	Required (must be present to load the plug-in)
Allowed:	
Default:	No default
Notes:	
Example:	<code>config="voucherRechargeOptions"</code>

function

Syntax:	<code>function="str"</code>
Description:	The function the plug-in should perform.
Type:	String
Optionality:	Required (must be present to load the plug-in)
Allowed:	
Default:	No default
Notes:	
Example:	<code>function="makeVoucherRechargePlugin"</code>

library

Syntax:	<code>library="lib"</code>
Description:	The filename of the plug-in library.
Type:	String
Optionality:	Required (must be present to load the plug-in)
Allowed:	
Default:	No default
Notes:	
Example:	<code>library="libccsClientPlugins.so"</code>

Voucher and wallet plugins

There are four plug-ins which provide functionality for the PlbeClient:

- 1 Voucher recharge (VRW)
- 2 Voucher type recharge (VTR)
- 3 Merge wallets (MGW)
- 4 *Broadcast* (on page 20)

Note: The broadcast plug-in configuration must be placed last in the `plugins` configuration section.

Each plug-in can have a configuration section. The name of this subsection will match the string provided for the config parameter in the `plugins` subsection.

Example: The Voucher Recharge plug-in has config set to `voucherRechargeOptions`. So the configuration section for this plug-in is:

```
voucherRechargeOptions = {
    ...
}
```

reportPeriodSeconds

Syntax:	<code>reportPeriodSeconds = seconds</code>
Description:	The number of seconds separating reports of failed messages.
Type:	Integer
Units:	Seconds
Optionality:	Required
Allowed:	
Default:	10
Notes:	<p>BeClient issues a failed message report:</p> <ul style="list-style-type: none"> • For timed-out messages • For unrequested responses • For new calls rejected because of congestion • For messages with invalid Voucher and Wallet Server identifiers • If new and subsequent requests fail because both Voucher and Wallet Servers have stopped working <p>WWS heartbeat detection must be enabled for the parameter to work. Set <code>reportPeriodSeconds</code> to more than <code>heartbeatPeriod</code>.</p> <p>This parameter is used by <code>libBeClientIF</code>.</p>
Example:	<code>reportPeriodSeconds = 10</code>

Voucher Recharge plug-in

The Voucher Recharge BeClient plug-in executes voucher recharges.

The `plugins` section must include the following configuration to load this plug-in.

```
{
    config="voucherRechargeOptions",
    library="libccsClientPlugins.so",
    function="makeVoucherRechargePlugin"
}
```

Note: The VRW plug-in requires the broadcast plug-in.

The voucher recharge plug-in supports the following configuration.

```
voucherRechargeOptions = {
    srasActivatesPreuseAccount=true|false
    voucherServerCacheLifetime = seconds
    voucherServerCacheCleanupInterval = seconds
    sendBadPin = true|false
    voucherRechargeTriggers = [
        "str"
    ]
}
```

The parameters are described in detail below.

`sendBadPin`

Syntax: `sendBadPin = true|false`

Description: Whether or not to increment the Bad PIN count for a failed voucher redeem.

Type: Boolean

Optionality: Optional

Allowed:

- `true` – Increment Bad PIN count for each failed attempt to recharge a voucher.
- `false` – Do not increment Bad PIN count for failed attempts to recharge a voucher.

Default: `false`

Notes: This parameter:

- applies only to an invalid voucher number or voucher PIN. It does not apply to failed wallet recharges
- is part of the `voucherRechargeOptions` parameter group

Example: `sendBadPin = false`

`srasActivatesPreuseAccount`

Syntax: `srasActivatesPreuseAccount = true|false`

Description: Sets whether or not alternate subscribers can activate subscriber accounts which are in a pre-use state.

Type: Boolean

Optionality: Optional

Allowed:

- `true` – A scratch card alternate subscriber can activate a pre-use account.
- `false` – A scratch card alternate subscriber cannot activate a pre-use account.

Default: `true`

Notes: This parameter is:

- Not used by `ccsBeOrb`
- Part of the `voucherRechargeOptions` parameter group

Example: `srasActivatesPreuseAccount = false`

`voucherRechargeTriggers`

Syntax: `voucherRechargeTriggers = [`
 `"VRW "`
 `]`

Description: This message triggers the voucher recharge plug-in.

Type: Array

Optionality: Required

Allowed: VRW

Default:

Notes: This parameter array is part of the `voucherRechargeOptions` parameter group.

Example:

`voucherServerCacheCleanupInterval`

Syntax: `voucherServerCacheCleanupInterval = seconds`

Description: Time in seconds between purges of the voucher server id cache.

Type: Integer

Optionality: Optional

Allowed: Any positive decimal integer.

Default: 60 (seconds)

Notes:

Example: `voucherServerCacheCleanupInterval = 60`

`voucherServerCacheLifetime`

Syntax: `voucherServerCacheLifetime = seconds`

Description: Time in seconds to hold items in the voucher server ID cache.

Type: Integer

Optionality: Optional

Allowed: Any positive decimal integer.

Default: 600 (seconds)

Notes:

Example: `voucherServerCacheLifetime = 600`

Voucher Type Recharge plug-in

The Voucher Type Recharge PlbeClient plug-in executes voucher type recharges.

The `plugins` section must include the following configuration to load this plug-in.

```
{
    config="voucherTypeRechargeOptions",
    library="libccsClientPlugins.so",
    function="makeVoucherTypeRechargePlugin"
}
```

Note: The VTR plug-in requires the broadcast plug-in.

The voucher recharge plug-in supports the following configuration.

```
voucherTypeRechargeOptions = {
```

```

    srasActivatesPreuseAccount=true|false
    voucherTypeRechargeTriggers = [
        "VTR "
    ]
}

```

The parameters are described in detail below.

srasActivatesPreuseAccount

Syntax:	<code>srasActivatesPreuseAccount = true false</code>
Description:	Sets whether or not alternate subscribers can activate subscriber accounts which are in a pre-use state.
Type:	Boolean
Optionality:	Optional
Allowed:	<ul style="list-style-type: none"> • true – A scratch card alternate subscriber can activate a pre-use account. • false – A scratch card alternate subscriber cannot activate a pre-use account.
Default:	true
Notes:	This parameter is: <ul style="list-style-type: none"> • Not used by <code>ccsBeOrb</code> • Part of the <code>voucherRechargeOptions</code> parameter group
Example:	<code>srasActivatesPreuseAccount = false</code>

voucherTypeRechargeTriggers

Syntax:	<code>voucherTypeRechargeTriggers = [str [...]]</code>
Description:	Starts the voucher type recharge plug-in.
Type:	Array
Optionality:	Required
Allowed:	VRW
Default:	
Notes:	This parameter array is part of the <code>voucherTypeRechargeOptions</code> parameter group.
Example:	<code>voucherTypeRechargeTriggers = ["VTR "]</code>

Merge Wallets plug-in

The Merge Wallets PibeClient plug-in executes wallet merges.

The `plugins` section must include the following configuration to load this plug-in.

```

{
    config = "mergeWalletsOptions",
    library = "libccsClientPlugins.so",
    function = "makeMergeWalletsPlugin"
}

```

Note: The VTR plug-in requires the broadcast plug-in.

The merge wallets plug-in supports the following configuration.

```

mergeWalletsOptions = {
    oracleLogin = "usr/pwd"
    mergeBucketExpiryPolicy = "str"
    mergeWalletExpiryPolicy = "str"
    allowedSourceWalletStates = "str[,...]"
}

```



```

mergeWalletsTriggers = [
    "str [...]"
]

```

The parameters are described in detail below.

allowedSourceWalletStates

Syntax: `allowedSourceWalletStates = "str[...]"`

Description: The states the source wallet must be in to allow it to be merged with another wallet.

Type: String

Optionality: Required

Allowed:

P	Pre-use
A	Active
D	Dormant
S	Suspended
F	Frozen
T	Terminated

Default: None

Notes: At least one state must be included, or all merged will be disallowed.

Example: `allowedSourceWalletStates = "PA"`

mergeBucketExpiryPolicy

Syntax: `mergeBucketExpiryPolicy = "str"`

Description: Determines how the bucket expiry policy is treated.

Type: String

Optionality: Optional (default used if not set).

Allowed:

merge	policy is merged
move	policy is moved

Default: merge

Notes:

Example: `mergeBucketExpiryPolicy = "move"`

mergeWalletExpiryPolicy

Syntax: `mergeWalletExpiryPolicy = "str"`

Description: Determines the way expiry dates for merged wallets are managed.

Type: String

Optionality: Optional

Allowed:

best	The expiry date of the wallet with the most time left is used.
ignore	The expiry date of the source wallet is ignored.

Default: best

Notes:

Example: `mergeWalletExpiryPolicy = "best"`

mergeWalletsTriggers

Syntax:	<pre>mergeWalletsTriggers = ["str [...]"]</pre>
Description:	Wallets of this type starts the merge wallets plug-in.
Type:	Array of strings.
Optionality:	Required
Allowed:	MGW
Default:	None
Notes:	The syntax must be typed exactly as shown in the example.
Example:	<pre>mergeWalletsTriggers = ["MGW "]</pre>

oracleLogin

Syntax:	<pre>oracleLogin = "usr/pwd"</pre>
Description:	The login details the BeClient should use to log in to the SMF database, when performing merge wallet functions.
Type:	String
Optionality:	Optional
Allowed:	
Default:	/
Notes:	
Example:	<pre>oracleLogin = "smf/smf"</pre>

Broadcast plug-in

The Broadcast PlbeClient plug-in overrides the beLocationPlugin that would normally load connection details from the database.

The `plugins` section must include the following configuration to load this plug-in.

```
{
    config="",
    library="libccsClientPlugins.so",
    function="makeBroadcastPlugin"
}
```

Notes:

- This plug-in must be the last in the `plugins` subsection.
- This plug-in has no configuration.
- The broadcast plug-in is required by the VRW and VTR plug-ins.

notEndActions

The state conversions subsection supports the following parameter.

```
notEndActions = [
    {type="str", action="str"}
    ...
]
```

The parameter is described in detail below.

`notEndActions`

Syntax: `notEndActions = [`
 `{type="str", action="[ACK|NACK]"}`
 `[...]`
`]`

Description: The `notEndActions` parameter array is used to define the messages associated with dialogs that should not have their dialog closes, because the dialog is closed by default. This facilitates failover.

Type: Parameter array.

Optionality: Required

Allowed:

Default:

Notes: If the incoming dialog for a call closes and the last response received was of the `notEndActions` type, the client process sends an ABRT message. The ABRT message allows the VWS to remove the reservation. An example of this situation would be where `slee_acs` has stopped working.

This parameter is used by `libBeClientIF`.

For more information about `slee_acs`, see *ACS Technical Guide*.

Example:

```
notEndActions = [
    {type="IR ", action="ACK "}
    {type="SR ", action="ACK "}
    {type="SR ", action="NACK"}
    {type="INER", action="ACK "}
    {type="SNER", action="ACK "}
    {type="SNER", action="NACK"}
]
```

voucherStateConversions

The state conversions subsection supports the following parameter.

```
voucherStateConversions = {
    str = "ESCHER"[,
    ...]
}
```

The parameter is described in detail below.

`voucherStateConversions`

Syntax: `voucherStateConversions = {`
 `str = "ESCHER"[,`
 `[...]`
`}`

Description: Converts from ESCHER encoding to a single character and back.

Type: Array

Optionality:

Allowed:

Default:

Notes:

Example:

```
voucherStateConversions = {
    A = "ACTV",
    F = "FRZN",
```

```

        R = "RDMD"
    }

```

stateConversions

The `stateConversions` subsection supports the following parameter.

```

stateConversions = {
    str = "ESCHER"[,
    ...]
}

```

The parameter is described in detail below.

stateConversions

Syntax:

```

stateConversions = {
    str = "ESCHER"[,
    ...]
}

```

Description: Converts from ESCHER encoding to a single character and back.

Type: Array

Optionality:

Allowed:

Default:

Notes:

Example:

```

stateConversions = {
    A = "ACTV",
    P = "PREU",
    D = "DORM",
    F = "FROZ",
    S = "SUSP",
    T = "TERM"
}

```

billingEngines

The `billingEngines` subsection supports the following configuration.

```

billingEngines = [
    {
        id = int,
        primary = { ip="ip", port=port },
        secondary = {{ ip="ip", port=port }
    }
]

```

This section overrides connection details that `beLocationPlugin` obtains from the database. It identifies the Voucher and Wallet Servers and assigns their Internet connection details.

Note: This section is optional, and is often commented out.

The parameters are described in detail below.

`id`

Syntax: `id = int`

Description: This unique identifier for this Voucher and Wallet Server configuration.

Type: Integer

Optionality: Required, if this section is used

Allowed:
Default:
Notes: This parameter is part of the `billingEngines` parameter array.
Example: `id = 1`

`primary`

Syntax: `primary = { ip="ip", port=port }`
Description: The `primary` parameter group defines the Internet Protocol (IP) address and associated port number of the primary Voucher and Wallet Server.
Type: Parameter array
Optionality: Required if this section is used

Allowed:
Default:
Notes: This parameter is part of the `billingEngines` parameter array.
Examples: `primary = { ip="192.0.2.0", port=1500 }`
`primary = { ip = "2001:db8:0000:1050:0005:0600:300c:326b", port=1500 }`
`primary = {ip = "2001:db8:0:0:0:500:300a:326f", port=1500 }`
`primary = { ip = "2001:db8::c3", port=1500 }`

`secondary`

Syntax: `secondary = { ip="ip", port=port }`
Description: The `secondary` parameter group defines the Internet Protocol (IP) address and associated port number of the secondary Voucher and Wallet Server.
Type: Array
Optionality: Required, if this section is used

Allowed:
Default:
Notes: This parameter is part of the `billingEngines` parameter array.
Examples: `secondary = { ip="192.0.2.1", port=1500 }`
`secondary = { ip = "2001:db8:0000:1050:0005:0600:300c:326b", port=1500 }`
`secondary = {ip = "2001:db8:0:0:0:500:300a:326f", port=1500 }`
`secondary = { ip = "2001:db8::c3", port=1500 }`

`ip`

Syntax: `ip = "ip"`
Description: The Internet Protocol (IP) address of the Voucher and Wallet Server.
Type: String
Optionality: Required
Allowed: IP version 4 (IPv4) addresses, IP version 6 (IPv6) addresses
Default: None

Notes: This parameter is part of either the primary, or the secondary parameter group of the `billingEngines` parameter array. You can use the industry standard for omitting zeros when specifying IPv6 addresses.

Examples:

```
ip = "192.0.2.0"
ip = "2001:db8:0000:1050:0005:0600:300c:326b"
ip = "2001:db8:0:0:0:500:300a:326f"
ip = "2001:db8::c3"
```

`port`

Syntax: `port = port`

Description: The port number associated with the address of the Voucher and Wallet Server.

Type: Integer

Optionality: Required

Allowed:

Default: None

Notes: This parameter is part of either the primary or secondary parameter group of the `billingEngines` parameter array.

Example: `port = 1500`

ssl

Here is an example of the `ssl` subsection of the PI `eserv.config` configuration.

```
ssl = {
    allowINSECURESSLv3 = false
    certificateFile = "/IN/service_packages/PI/my_sslCertificate.pem"
    keyFile = "/IN/service_packages/PI/my_sslKey.pem"
}
```

The parameters in this subsection are described in detail below.

`allowINSECURESSLv3`

Syntax: `allowINSECURESSLv3 = true|false`

Description: Whether to allow use of SSLv3 in the SSL handshake for SSL enabled systems. For example, set this parameter to true for customers with an ASP that must use the SSLv3 protocol version. Use of SSLv3 and SSLv2 is disabled by default.

Type: Boolean

Optionality: Optional (default used if not set)

Allowed:

- true – Use of SSLv3 protocol version enabled.
- false – Use of SSLv3 protocol version disabled.

Default: false

Notes: The `allowINSECURESSLv3` parameter can be set for the DAP, PI and OSD components. You should set `allowINSECURESSLv3` to true if the ASP is able to use only SSLv3 protocol version. Otherwise set `allowINSECURESSLv3` to false.

Example: `allowINSECURESSLv3 = true`

`certificateFile`

Syntax: `certificateFile = "filename"`

Description: The file name of the PEM Base64 encoded DER certificate to be used when accepting HTTPS connections.

Type: String

Optionality: Optional – only required if the interface used is SOAP/HTTPS.

Allowed:

Default: None

Notes:

Example: `certificateFile =
"/IN/service_packages/PI/sslCertificate.pem"`

`keyFile`

Syntax: `keyFile = "filename"`

Description: The file name of the private key used to create the certificate.

Type: String

Optionality: Optional – only required if the interface used is SOAP/HTTPS.

Allowed:

Default: None

Notes:

Example: `keyFile = "/IN/service_packages/PI/privKey.pem"`

soap

Note: The template WSDL files for the CCS, ACS, and NP PI commands are installed in the `/IN/service_packages/PI/etc` directory on the SMS server. You use the WSDL files when developing or configuring clients to allow them to generate the SOAP PI commands that are defined by the WSDL files. Update the template WSDL files with the PI server information (IP address and ports) before you distribute or publish them. After updating the template WSDL files, you may publish the WSDL files on the SMS server using a HTTP Server in an accessible directory; for example, `/IN/html`.

Here is an example structure of the `soap` subsection of the PI `eserv.config` configuration.

```
soap = {
    implicitLoginsSupported = false
    validateAuthStrings = true
    expansionRules = [
        {
            command = "CCSCD1"
            action = "QRY"
            parameter = "BALANCES"
            itemName = "BALANCE_ITEM"
            itemSeparator = "|"
            elementSeparator = ":"
            elementNames = [ "BALANCE_TYPE_NAME", "*BUCKETS" ]
        }
        {
            next_rule_parameters
        }
    ]
}
```

Chapter 2

```
    {
      next_rule_parameters
    }
    {
      next_rule_parameters
    }
  ]
}
```

These parameters are described in detail below.

validateAuthStrings

Syntax: `validateAuthStrings = true|false`

Description: Turning this variable false will bypass checking of AUTH strings.

Type: Boolean

Optionality: Optional (default used if not set).

Allowed:

Default: `true`

Notes: That is useful in situations where a pool of connections is used for access to PI web services and the clients wish to be able to use any open connection for whichever command they wish execute next, regardless of which one they used for the preceding request.

Example: `validateAuthStrings = true`

implicitLoginsSupported

Syntax: `implicitLoginsSupported = true|false`

Description: Turning the following variable true will allow any incoming SOAP request to contain username and password. If such a request is received on an unauthenticated connection, the fields will be used to do an implicit Login (just like a real Login only no LoginResponse is sent).
If the login fails a fault is returned; if it succeeds the command is executed.

Type: Boolean

Optionality: Optional (default used if not set).

Allowed:

Default: `false`

Notes: That is useful in situations where a pool of connections is used for access to PI web services and the clients wish to be free from knowing whether or not a particular connection requires authentication before use.

Example: `implicitLoginsSupported = false`

expansionRules

By default when returning PI responses in SOAP format, PI assembles them simplistically by using the parameter name as the tag name, and the value as the tag value. For example the name/value pair `MSISDN="1234"` is rendered

```
<pi:MSISDN>1234</pi:MSISDN>
```

However, some commands return complex, repeating, nested elements in a single response parameter, and the customer may wish to configure so-called expansion rules that cause these to be exploded out into a more XML-like and accessible style.

For any parameter of any command, an expansion rule can be configured, to explain how PI should unpack its value (normally by tokenizing on some separator such as "|"). The expansion rule concept allows for the situation where a list of struct-like items are assembled, with list items being separated by one sort of delimiter (e.g. "|") and the fields within each list item being separated by another (e.g. ":").

A rule is also allowed to treat an element as something which itself requires expansion, as shown in the CCSCD1=QRY BALANCES rule below.

Note: All these examples are real world in the sense that they can help provide a more usable rendering of the parameter values returned by PI in each case, but it is a matter of customer preference as to whether or not they are activated at a site.

If you choose to use or update the `expansionRules` configuration and if you are using SOAP integration, update your published or distributed WSDL files to match the modified output format of the response. For more information see *soap* (on page 25).

PI command parameters, present or future, may require similar rules (or different ones).

Here is an example of the expansion rules sub-section.

```

expansionRules = [
  {
    command = "CCSCD1"
    action = "QRY"
    parameter = "BALANCES"
    itemName = "BALANCE_ITEM"
    itemSeparator = "|"
    elementSeparator = ":"
    elementNames = [ "BALANCE_TYPE_NAME", "*BUCKETS" ]
  }
  {
    command = "CCSCD1"
    action = "QRY"
    parameter = "*BUCKETS"
    itemName = "BUCKET_ITEM"
    itemSeparator = "|"
    elementSeparator = ":"
    elementNames = [
      "BUCKET_VALUE",
      "BUCKET_EXPIRY"
    ]
  }
  {
    command = "CCSCD7"
    action = "QRY"
    parameter = "EDRS"
    itemName = "EDR_ITEM"
    itemSeparator = "|"
    elementSeparator = ":"
    elementNames = [
      "RECORD_DATE",
      "WALLET_TYPE",
      "CHARGING_DOMAIN_ID",
      "CALL_ID",
      "SCP_ID",
      "SEQUENCE_NUMBER",
      "EXTRA_INFORMATION"
    ]
  }
  {
    command = "CCSVR1"
    action = "QRY"
    parameter = "BALANCES"
    itemName = "BALANCE_ITEM"
    itemSeparator = "|"
    elementSeparator = ":"
    elementNames = [

```

```

        "BALANCE_TYPE",
        "AMOUNT",
        "POST_USE_EXPIRY",
        "START_DATE",
        "END_DATE",
        "NEW_BUCKET",
        "POLICY",
        "MISSING_BALANCE_POLICY",
        "REPLACE_BALANCE"
    ]
}
]

```

eserv.config file example `eserv.config.pi_example`

PI comes with a file named `eserv.config.pi_example`. It is located in the root of the application directory. This file contains a commented example of the pi section of an `eserv.config` configuration file. As a starting point, when configuring features of the provisioning interface, copy `eserv.config.pi_example` into the main `eserv.config` file.

The content of the `eserv.config.pi_example` file is copied below. Most of the comments have been removed.

```

pi = {
    localTZ = "TimeZone"

    general = {
        # debug = 'N'
        # oraUser = "/"
        # synstamp = 'Y'
        # timeout = 30
        # logLevel = 0
        # securityPlugin = ""
        # correlationRequestTagName = "CORRELATE"
        # correlationResponseTagName = "CORRELATE"
    }

    throttling = {
        # sendRate = 0
    }

    PIbeClient = {

        clientName = "PIbeClient"

        oracleLogin = "/"

        heartbeatPeriod = 1000000

        maxOutstandingMessages = 100

        connectionRetryTime = 2

        plugins = [ # pluggable functionality for the billing engine interface.
            { # Voucher recharge (VRW) plugin (need the broadcast plugin)
                config="voucherRechargeOptions",
                library="libccsClientPlugins.sl",
                function="makeVoucherRechargePlugin"
            }
            { # Broadcast plugin needed by VRW
                config="", # no config
                library="libclientBcast.sl",
                function="makeBroadcastPlugin"
            }
        ] # Broadcast one message to one BE of each pair
    }
}

```

```

    # Activated by sending a message to BE ID 0.
]

# Config for voucher recharge plugin
voucherRechargeOptions = {
    # Should Scratch Card Alternate Subscriber activate a preuse a/c?
    # Not used by the PIbeClient
    srasActivatesPreuseAccount=false
    voucherRechargeTriggers = [
        "VRW " # this type of message triggers this plugin
    ]
}

notEndActions = [
    {type="IR ", action="ACK "}
    {type="SR ", action="ACK "}
    {type="SR ", action="NACK"}
    {type="INER", action="ACK "}
    {type="SNER", action="ACK "}
    {type="SNER", action="NACK"}
]

stateConversions = {
    A = "ACTV",
    P = "PREU",
    D = "DORM",
    F = "FROZ",
    S = "SUSP",
    T = "TERM"
}

voucherStateConversions = {
    A = "ACTV",
    F = "FRZN",
    R = "RDMD"
}

# billingEngines = [
#     {
#         id = 1, # pair ID
#         primary   = { ip="PRIMARY_BE_IP", port=1500 },
#         secondary = { ip="SECONDARY_BE_IP", port=1500 }
#     }
# ]

ssl = {
    allowINSECURESSLv3 = false
    certificateFile = "/IN/service_packages/PI/my_sslCertificate.pem"
    keyFile = "/IN/service_packages/PI/my_sslKey.pem"
}

soap = {
    implicitLoginsSupported = false
    validateAuthStrings = true
    expansionRules = [
        {
            command = "CCSCD1"
            action = "QRY"
        }
    ]
}

```

```

parameter = "BALANCES"
itemName = "BALANCE_ITEM"
itemSeparator = "|"
elementSeparator = ":"
elementNames = [ "BALANCE_TYPE_NAME", "*BUCKETS" ]
}
{
command = "CCSCD1"
action = "QRY"
parameter = "*BUCKETS"
itemName = "BUCKET_ITEM"
itemSeparator = "|"
elementSeparator = ":"
elementNames = [
    "BUCKET_VALUE",
    "BUCKET_EXPIRY"
]
}
{
command = "CCSCD7"
action = "QRY"
parameter = "EDRS"
itemName = "EDR_ITEM"
itemSeparator = "|"
elementSeparator = ":"
elementNames = [
    "RECORD_DATE",
    "WALLET_TYPE",
    "CHARGING_DOMAIN_ID",
    "CALL_ID",
    "SCP_ID",
    "SEQUENCE_NUMBER",
    "EXTRA_INFORMATION"
]
}
{
command = "CCSVR1"
action = "QRY"
parameter = "BALANCES"
itemName = "BALANCE_ITEM"
itemSeparator = "|"
elementSeparator = ":"
elementNames = [
    "BALANCE_TYPE",
    "AMOUNT",
    "POST_USE_EXPIRY",
    "START_DATE",
    "END_DATE",
    "NEW_BUCKET",
    "POLICY",
    "MISSING_BALANCE_POLICY",
    "REPLACE_BALANCE"
]
}
]
}
}

```

About Configuring PI Commands in `eserv.config`

Introduction

Some of the application commands support configuration in the `eserv.config` file.

Note: If the commands package which includes the related command have not be installed, these parameters are not supported.

Local time zone

The Local time zone subsection supports the following parameter.

```
localTZ = "TimeZone"
```

The parameter is described in detail below.

localTZ

Syntax:	<code>localTZ = "TimeZone"</code>
Description:	Sets the time zone the PI uses for sending and receiving dates.
Type:	String
Optionality:	Optional (default used if not set).
Allowed:	The time zone name must be a valid UNIX time zone name such as CET or GMT.
Default:	The time zone of the SMS machine (typically GMT).
Notes:	PI automatically accounts for summer time alterations within this time zone.
Example:	

Setting the Control Plan Export File Directory for ACSCPL PI Commands

You use the ACSCPL=EXP PI command to export control plans to `.cpl` files. The PI exports control plans to the following directory by default:

`/IN/service_packages/PI/callplans`

You can set a different control plan export directory by configuring the `exportCallPlanDirectory` parameter in the `pi`, ACSCPL section of the `eserv.config` configuration file:

```
pi = {
  ACSCPL = {
    exportCallPlanDirectory = "str"
  }
}
```

The `exportCallPlanDirectory` parameter has the following characteristics:

`exportCallPlanDirectory`

Syntax:	<code>exportCallPlanDirectory = "str"</code>
Description:	The directory to which the PI exports control plan files.
Type:	String
Optionality:	Optional (default used if not set)
Default:	<code>/IN/service_packages/PI/callplans</code>
Example:	<code>exportCallPlanDirectory = "/IN/service_packages/PI/myControlPlans"</code>

Getting Information About Voucher Changes by Using PI Commands

When changing a voucher state or marking a voucher as frozen, you can use PI commands to record and return the reason for the change, and the user to whom it applied.

To record the data, the `CCSVR1=CHG` command (change voucher status) and `CCSVR1=FRZ` command (mark voucher frozen) have an optional `DESCRIPTION` parameter that you can use to record the reason for the action.

To retrieve the data, the `CCSVR1=QRY` command (query a recharge voucher) can return the following information:

- The reason for a voucher state change. This information is in the `DESCRIPTION` field. This field is limited to 50 characters and is truncated if the input is too long.
- The user for the voucher state change. This information is in the `STATE_CHANGE_USER` field.

You can disable having the `CCSVR1=QRY` command return the `DESCRIPTION` and `STATE_CHANGE_USER` fields by editing the `pi.CCSVR1.QRY.suppressField` in the `eserv.config` file. To configure this entry, enter the fields you want to suppress, separated by the pipe (|) character. The default is to display all fields. This entry is read only on the first call to `CCSVR1=QRY`.

The following example suppresses both fields; `DESCRIPTION` and `STATE_CHANGE_USER`:

```
pi = {
  CCSVR1 = {
    QRY = {
      suppressFields = "DESCRIPTION|STATE_CHANGE_USER"
    }
  }
}
```

CCSCD1

The `CCSCD1` subsection of the PI `eserv.config` configuration supports these parameters.

```
CCSCD1 = {
  ADD = {
    initialState = "state"
    noWalletCreateBeIds = [ BE1, BE2 ]
    useSystemLanguage = 'Y|N'
  }
  CHG = {
    createEmptyBalance = true|false
  }
  QRY = {
    currencyType = "str"
  }
}
```

The parameters in the `ADD`, `CHG`, and `QRY` subsections are described in detail below.

`initialState`

Syntax:	<code>initialState = "state"</code>
Description:	The initial wallet state for wallets created using the <code>CCSCD1=ADD_INITIAL_STATE</code> command.
Type:	String
Optionality:	Optional

Allowed:

P	Pre-use
A	Active
D	Dormant
S	Suspended
F	Frozen
T	Terminated

Default: P

Notes: For more information about the CCSCD1 command, see CCS Provisioning Interface Commands.

Example: `initialState = "P"`

`noWalletCreateBeIds`

Syntax: `noWalletCreateBeIds = [be_ids]`

Description: Comma separated list of billing engine IDs that may not be used for wallet creation.

Type: Array

Optionality: Optional (default used if missing).

Allowed: List of valid billing engine IDs.

Default: Not set

Notes:

Example: `noWalletCreateBeIds = [1, 2]`

`createEmptyBalance`

Syntax: `createEmptyBalance = true|false`

Description: When `createEmptyBalance` is set to true, allows a balance with no existing buckets to be created with a zero (0.0) value.

Type: Boolean

Optionality: Optional (default used if not set)

Allowed:

- true – Allow balances to be created with a zero value.
- false – Do not allow balances to be created with a zero value.

Default: false

Notes: Setting `createEmptyBalance` to true enables you to use the CCSCD1=CHG PI command to provision the expiry date for the balance so that any subsequent recharges into the balance have the correct expiry date extension (based on the "Best" balance expiry policy).

Example: `createEmptyBalance = true`

`currencyType`

Syntax: `currencyType = "str"`

Description: Sets the type of currency.

Type: String

Optionality: Optional

Allowed:

user	Use the user's wallet currency type.
system	Use the system currency type.

Default: user

Chapter 2

Notes: For more information about the CCSCD1 command, see CCS Provisioning Interface Commands .

Example: `currencyType = "user"`

`useSystemLanguage`

Syntax: `useSystemLanguage = 'Y|N'`

Description: Sets whether to use the system language for new subscribers, or the subscriber's language.

Type: Boolean

Optionality: Optional (default used if not set)

Allowed: Y – Use the system language
N – Use the subscriber's language

Default: Y

Notes:

Example: `useSystemLanguage = 'N'`

CCSCD3

The CCSCD3 subsection of the PI `eserv.config` configuration supports these parameters.

```
CCSCD3 = {  
    CTR = {  
        creditTransferCP = "creditTransferControlPlan"  
    }  
    RCH = {  
        fixedVoucherNumberLength = 10  
        defaultScenarioName = "str"  
        activatePreuseAccount = "true"  
    }  
}
```

The parameters in this subsection are described in detail below.

`creditTransferCP`

The name of the credit transfer control plan.

Default: "CREDIT_TRANSFER"

Type: String

`fixedVoucherNumberLength`

Syntax: `fixedVoucherNumberLength = num`

Description: The voucher number length. Must be set correctly when performing scenario recharges and the scenario name is specified.

Type: Integer

Optionality: Optional (default used if not set).

Allowed: Valid voucher number length

Default: 10

Notes:

Example: `fixedVoucherNumberLength = 10`

defaultScenarioName

Syntax:	<code>defaultScenarioName = "scenario"</code>
Description:	Specifies the default scenario to use.
Type:	String
Optionality:	Optional (default used if not set).
Allowed:	A valid scenario name.
Default:	Default
Notes:	
Example:	<code>defaultScenarioName = "Default"</code>

activatePreuseAccount

Syntax:	<code>activatePreuseAccount = "true false"</code>
Description:	Sets whether or not to activate pre-use wallets for recharge attempts.
Type:	Boolean
Optionality:	Optional (default used if not set).
Allowed:	<ul style="list-style-type: none"> • true – Activate pre-use wallets for recharge attempts. • false – Do not activate pre-use wallets.
Default:	true
Notes:	Quoted value is required.
Example:	<code>activatePreuseAccount = "false"</code>

CCSBPL

The `CCSBPL` subsection of the `PI eserv.config` configuration supports these parameters.

```
CCSBPL = {
    notifyEagain = true
    maxFifoReadRetry = 10
    triggerTimeoutSeconds = 10
}
```

The parameters in this subsection are described in detail below.

notifyEagain

Syntax:	<code>notifyEagain = true false</code>
Description:	Whether or not to display notice alarms for missed reads from the Fifo queue.
Type:	Boolean
Optionality:	Optional (default used if not set).
Allowed:	<ul style="list-style-type: none"> • true – Display notice alarms for missed reads. • false – Do not display notice alarms for missed reads.
Default:	false
Notes:	
Example:	<code>notifyEagain = true</code>

maxFifoReadRetry

Syntax:	<code>maxFifoReadRetry = maximum</code>
Description:	Sets the maximum number of times to retry reading from the Fifo queue.
Type:	Integer

Optionality: Optional (default used if not set).

Allowed:

Default: 10

Notes:

Example: `maxFifoReadRetry = 20`

`triggerTimeoutSeconds`

Syntax: `triggerTimeoutSeconds = seconds`

Description: Sets the timeout, in seconds, for waiting for a response from smsTrigDaemon.

Type: Integer

Optionality: Optional (default used if not set)

Allowed:

Default: 10

Notes:

Example: `triggerTimeoutSeconds = 5`

CCSVR1

The CCSVR1 subsection of the PI `eserv.config` configuration supports these parameters.

```
CCSVR1 = {
    acsCustomerId = 0|1
    QRY= {
        suppressScenario = 'Y|N'
        suppressFields = "str1|str2"
        DECRYPT_PRIVATE_SECRET = 'Y|N'
    }
}
```

`acsCustomerId`

Syntax: `acsCustomerId = nnn`
where nnn is a positive number

Description: Sets the default acsCustomerId to use for CCSVR1 commands where PROVIDER is not specified on the command.

Type: Integer

Optionality: Optional. If not defined, no default is used and PROVIDER must be specified on the CCSVR1 command.

Allowed: nnn
Must be an existing numeric service provider Id (> 0).

Default: No default

Notes: Sending PROVIDER in the PI command line overrides this value.

Example: `acsCustomerId = 1`

`suppressScenario`

Syntax: `suppressScenario = 'Y|N'`

Description: Determines whether or not to suppress the SCENARIO return parameter if the voucher has an associated scenario.

Type: Boolean

Optionality: Optional (default used if not set).

Allowed:	Y	Do not return the SCENARIO return parameter even if the voucher has an associated scenario.
	N	Return the SCENARIO return parameter if the voucher has an associated scenario.
Default:	N	
Notes:	If an invalid parameter value is specified, then 'N' is assumed and an error alarm is output to the PImanager log file.	
Example:	<code>suppressScenario = 'N'</code>	

`suppressFields`

Syntax:	<code>suppressFields = "str1 str2.."</code>
Description:	Lists the fields to suppress from the results displayed for the CCSVR1=QRY PI command, where <i>str1</i> and <i>str2</i> are fields output by the CCSVR1 query command.
Type:	Parameter list
Optionality:	Optional (default used if not set)
Allowed:	
Default:	Display all fields
Notes:	
Example:	<code>suppressFields = "DESCRIPTION STATE_CHANGE_USER"</code>

`decrypt_private_secret`

Syntax:	<code>DECRYPT_PRIVATE_SECRET = value</code>
Description:	The voucher private secret will be decrypted to obtain the original HRN.
Type:	Boolean
Optionality:	Optional (default used if not set)
Allowed:	Y or N
Default:	N
Notes:	
Example:	<code>DECRYPT_PRIVATE_SECRET = Y</code>

CCSCD9

The CCSCD9 subsection of the PI `eserv.config` configuration supports these parameters.

```
CCSCD9 = {
  QRY = {
    suppressEmptyField = true|false
  }
}
```

The parameter in the QRY subsection is described in detail below.

`suppressEmptyFields`

Syntax:	<code>suppressEmptyFields = true false</code>
Description:	Specifies how to handle empty profile tag name fields.
Type:	Boolean
Optionality:	Optional (default used if not set)
Allowed:	<ul style="list-style-type: none"> • <code>true</code> – If the tag name field is not in the profile, no tag name is printed. • <code>false</code> – It prints empty profile tag name fields with a null value.

Default: false
Notes:
Example: `suppressEmptyFields = true`

CCSSC1

`defaultBEDomainID`

Syntax: `defaultBEDomainID = id`
Description: BE pair ID to query when no SUBSCRIBER supplied to query for their BE pair supplied for CCSSC1=QRY command.
Type: Integer
Optionality: Optional (default used if not set).
Allowed:
Default: -1
Notes: Must match a value in the CCS_DOMAIN.DOMAIN_ID database table.
-1 = find the first domain that supports charging.
Example: `defaultBEDomainID = 2`

Specifying the Maximum PQYZ Records to Query in the NP Database

You use the NPYZ1=QRY PI command to query the NP database for PQYZ entries. By default, the maximum number of records returned is 1500. You can specify a different maximum by configuring the `pqyzMaxRecords` parameter in the pi, NP section of the `eserv.config` configuration file:

```
pi = {  
  NP = {  
    pqyzMaxRecords = int  
  }  
}
```

The `pqyzMaxRecords` parameter has the following characteristics:

`pqyzMaxRecords`

Syntax: `pqyzMaxRecords = int`
Description: The maximum number of records returned when you query the NP database for multiple PQYZ entries that match one or more destination addresses.
Type: Integer
Optionality: Optional (default used if not set)
Default: 1500
Notes: The PI outputs an error if the query finds more records than the configured maximum.
Example: `pqyzMaxRecords = 500`

Defining the Screen Language

Introduction

The default language file sets the language that the Java administration screens start in. The user can change to another language after logging in.

The default language can be changed by the system administrator.

By default, the language is set to English. If English is your preferred language, you can skip this step and proceed to the next configuration task, *Defining the Help Screen Language* (on page 40).

Default.lang

When PI is installed, a file called *Default.lang* is created in the application's language directory in the screens module. This contains a soft-link to the language file which defines the language which will be used by the screens.

If a **Default.lang** file is not present, the **English.lang** file will be used.

The PI **Default.lang** file is `/IN/html/PI/language/Default.lang`.

Example Screen Language

If Dutch is the language you want to set as the default, create a soft-link from the **Default.lang** file to the **Dutch.lang** file.

Procedure

Follow these steps to set the default language for your PI Java administration screens.

Step	Action
1	Change to the following directory: <code>/IN/html/PI/language</code> Example command: <code>cd /IN/html/PI/language</code>
2	Check that the Default.lang file exists in this directory.
3	If the required file does not exist, create an empty file called Default.lang .
4	Ensure that the language file for your language exists in this directory. The file should be in the format: <code>language.lang</code> Where: <code>language</code> = your language. Example: <code>Spanish.lang</code>
5	If the required language file does not exist, perform one of the following actions: <ul style="list-style-type: none"> • Create a new one with your language preferences • Contact Oracle support <p>To create a language file, you will need a list of the phrases and words used in the screens. These should appear in a list with the translated phrase in the following format: <code>original phrase=translated phrase</code> Any existing language file should have the full set of phrases. If you do not have an existing file to work from, contact Oracle support with details.</p>
6	Create a soft link between the Default.lang file, and the language file you want to use as the default language for the PI Java administration screens. Example command: <code>ln -s Dutch.lang Default.lang</code>

Defining the Help Screen Language

Introduction

The default Helpset file sets the language that the help system for the Java Administration screens start in. The user can change to another language after logging in.

The default language can be changed by the system administrator. By default, the language is set to English.

Default_PI.hs

When PI is installed, a file called **Default_PI.hs** is created in the application's language directory in the screens module. This contains a soft-link to the language file which defines the language which will be used by the screens.

If a **Default_PI.hs** file is not present, the **English_PI.hs** file will be used.

If a **Default_PI.hs** file is present, the default language will be used.

The default file is `/IN/html/PI/helpertext/Default_PI.hs`.

Example helpset language

If Dutch is the language you want to set as the default, create a soft-link from the **Default_PI.hs** file to the **Dutch_PI.hs** file.

Procedure

Follow these steps to set the default language for your PI Java Administration screens.

Step	Action
1	Change to the following directory: <code>/IN/html/PI/helpertext</code> Example command: <code>cd /IN/html/PI/helpertext</code>
2	check that the Default_PI.hs file exists in this directory.
3	If the required file does not exist, create an empty file called Default_PI.hs .
4	Ensure that the language file for your language exists in this directory. The file should be in the format: <code>language_PI.hs</code> Where: <code>language</code> = your language. Example: <code>Dutch_PI.hs</code>
5	If the required language file does not exist, perform one of the following: <ul style="list-style-type: none"> • Create a new one with your language preferences • Contact Oracle support <p>To create a language file, you will need a list of the phrases and words used in the screens. These should appear in a list with the translated phrase in the following format: <code>original phrase=translated phrase</code> Any existing language file should have the full set of phrases. If you do not have an existing file to work from, contact Oracle support with details.</p>
6	Create a soft link between the Default_PI.hs file, and the language file you want to use as the default language for the SMS Java administration screens.

Example command: `ln -s Dutch_PI.hs Default_PI.hs`

Defining a Password Policy

Password verification functions are a feature in the Oracle database and allow a site to configure their own, usually stricter, password verification policy. A password policy is site dependent, based on the password verification function specified.

The strength checking function for a PI user password is listed in a database profile called PI_USERS. This profile is used globally for all the PI users.

The profile also contains limits:

- **PASSWORD_LIFE_TIME:** The number of days after a password change that a password is unusable. After this time, at PI login, the validation fails and the password must be reset. If the PI password has expired, then a cmnError ERROR message is logged at login time.
- **PASSWORD_GRACE_TIME:** The number of days before a password expires that login is still allowed with a cmnError WARNING message being logged that the password is close to expiry.

When a new PI user is created, and or an existing PI user's password is changed, their password strength is checked. If this check fails, an error message is displayed. This error message is configurable and is set by a parameter in **sms.jnlp**.

The following example shows the parameter in **sms.jnlp**:

```
<property name="jnlp.sms.piUsersPasswordPolicyMessage" value="The new password must be at least 9 characters long and have at least 2 uppercase characters, 2 lowercase characters, 2 digits and 2 special characters, and must be 4 characters or more different from the previous password if there was one." />
```

Note: This policy message describes the policy provided by NCC by default for PI Users, which uses the ORA12C_STRONG_VERIFY_FUNCTION to verify the strength of PI User passwords.

If this parameter is not set, then a default message saying the password has failed the PI password policy is displayed.

When a user logs into PI, if the verification of the user password fails, then the number of the failed login attempts is incremented. If this value reaches 3, then the PI user's account is locked and the Lock Reason field in the PI Users tab displays the reason. To continue using the account, the account must then be unlocked by changing the password for the PI User in the PI Users tab. When a password is reset, the Failed Logins field is set to 0, the Lock Reason is cleared, and the Last Password Change field is set to the current time.

Password Policy Requirements

A password policy allows a site to specify that a password meets a number of requirements. For example, the requirements could include one or more of the following requirements:

- Contains a minimum number of characters
- Contains a minimum number of digits
- Contains a minimum number of letters
- Contains a minimum number of special characters
- Does not contain double-quote characters
- Differs from a previous password by a specified number of characters

Example Password Policy

The following is an example of a password policy:

- Contains a minimum of 9 characters
- Contains a minimum of 2 digits
- Contains a minimum of 2 letters
- Contains a minimum of 2 special characters
- Differs from a previous password by 4 characters

Password Verification Function

The PI_USERS database profile uses the function named by resource_name PASSWORD_VERIFY_FUNCTION as the name of the database function to call for PI User password strength checking. By default, PASSWORD_VERIFY_FUNCTION is set to ORA12C_STRONG_VERIFY_FUNCTION, which is a verify function supplied with Oracle 12c.

It is possible to change the password verify function to another one.

The following rules should be followed for any new password verification function:

- 1 It must be a PL/SQL function with the following signature:
routine_name (userid_parameter IN VARCHAR2, password_parameter IN VARCHAR2, old_password_parameter IN VARCHAR2) RETURN BOOLEAN
- 2 The function must be owned by the SYS user.
- 3 The function must have execute permission for PUBLIC granted to it.

The database-provided SQL file (\$ORACLE_HOME/rdbms/admin/utlpwdmg.sql) defines the standard password verification functions and additional helper functions.

PI Administration Screen

Overview

Introduction

This chapter explains how to use the PI Administration screen.

In this chapter

This chapter contains the following topics.

PI Administration Screen	43
PI Commands	44
PI Hosts	46
PI MAC Pairs	49
PI Users	51
PI Ports	55

PI Administration Screen

Introduction

The Administration screen manages users and templates in the Provisioning Interface. It contains these tabs:

- Users
- Hosts
- Ports
- Commands
- MAC Pairs

Accessing the PI Administration screen

Follow the steps below to access the Administration screen.

Step	Action
1	Select the Services menu from the Service Management System main menu.

Step	Action
------	--------

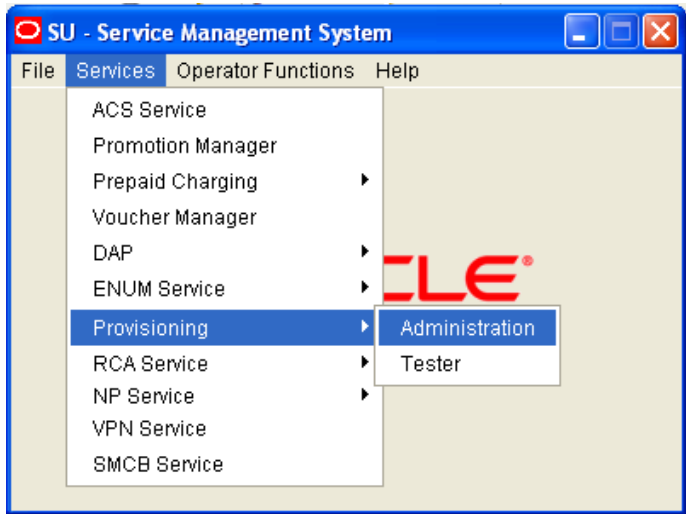

2 Select **Provisioning**.

3 Select **Administration**.

Result: You see the PI Administration screen, showing the **Commands** tab.

PI Commands

Introduction

The **Commands** tab of the PI Administration screen enables you to set the security level for PI commands.

Note: Commands cannot be added to or removed from the list of available commands.

Commands tab

Here is an example **Commands** tab.

Name	Security Level	Subscriber Dom...	Wallet Domain	Voucher
ACSCLI=ADD	1	Y	N	N
ACSCLI=DEL	1	Y	N	N
ACSCLI=QRY	1	Y	N	N
ACSPFL=CHG	1	Y	N	N
ACSPFL=QRY	1	Y	N	N
CCSBPL=EXE	1	Y	N	N
CCSCC1=CHG	1	N	Y	N
CCSCC1=QRY	1	N	Y	N
CCSCD1=ADD	1	Y	Y	N
CCSCD1=CHG	1	Y	Y	N
CCSCD1=DEL	1	Y	Y	N
CCSCD1=MSW	1	N	Y	N
CCSCD1=QRY	1	Y	Y	N
CCSCD2=QRY	1	N	Y	N
CCSCD3=CTR	1	N	Y	N
CCSCD3=RCH	1	N	Y	Y
CCSCD4=CHG	1	Y	Y	N
CCSCD5=CHG	1	Y	N	N
CCSCD6=CHG	1	Y	N	N
CCSCD7=QRY	1	N	Y	N
CCSCD8=ADD	1	Y	Y	N
CCSCD8=CHG	1	Y	Y	N
CCSCD8=DEL	1	Y	Y	N
CCSCD9=CHG	1	Y	N	N
CCSCD9=QRY	1	Y	N	N

Commands fields

This table describes the function of each field.

Field	Description
Name	The PI command name.
Security Level	The security level required to execute the command.
Subscriber Domain	Indicates the command applies to an account that belongs to the subscriber domain, that is, the account exists on the SMS, the account wallet may be on a VWS or on a third party billing engine.
Wallet Domain	Indicates the command applies to an account that belongs to the wallet domain, that is, both the account and wallet exists on the SMS and VWS.
Voucher Domain	Indicates the command applies to a voucher that belongs to the voucher domain, that is, a voucher that exists on the VWS.

Example screen

The following example shows the edit dialog box for the CCSCD1=ADD PI command.

The screenshot shows a dialog box titled "CCSCD1=ADD". It has a "Help" button in the top right corner. The "Security Level" is set to "1". There are two tables for parameter configuration:

Parameter	Required
PRODUCT	Y
AUTH_HASH_FN_NAME	N
BYPASS_NUMBER	N
CHARGING_DOMAIN	N
END_MSISDN	N

Parameter	Required
PRODUCT	Y
ACCOUNT_NUMBER	N
BYPASS_NUMBER	N
CHARGING_DOMAIN	N
CURRENCY	N

At the bottom, there are "Save" and "Cancel" buttons.

Editing PI commands

Follow these steps to edit a PI command.

Step	Action
1	From the list of PI commands on the Commands tab, select the command you want to edit.
2	Click Edit . Result: The edit dialog box for the selected command appears. See <i>Commands fields</i> (on page 45) for a description of each field.
3	Change the Security Level as required. Note: Range is 1 to 99 (highest) inclusive.
4	Click Save . Result: The details are saved to the database.
5	Soft restart the PI. For details, see <i>Soft PI Restart</i> (on page 66). Result: The updated configuration details will be loaded by the PImanager.

PI Hosts

Introduction

The **Hosts** tab of the PI Administration screen enables you to configure the hosts from which PI commands can be run. Before a new client can connect, it must be added to the database.

Hosts tab

Here is an example **Hosts** tab.

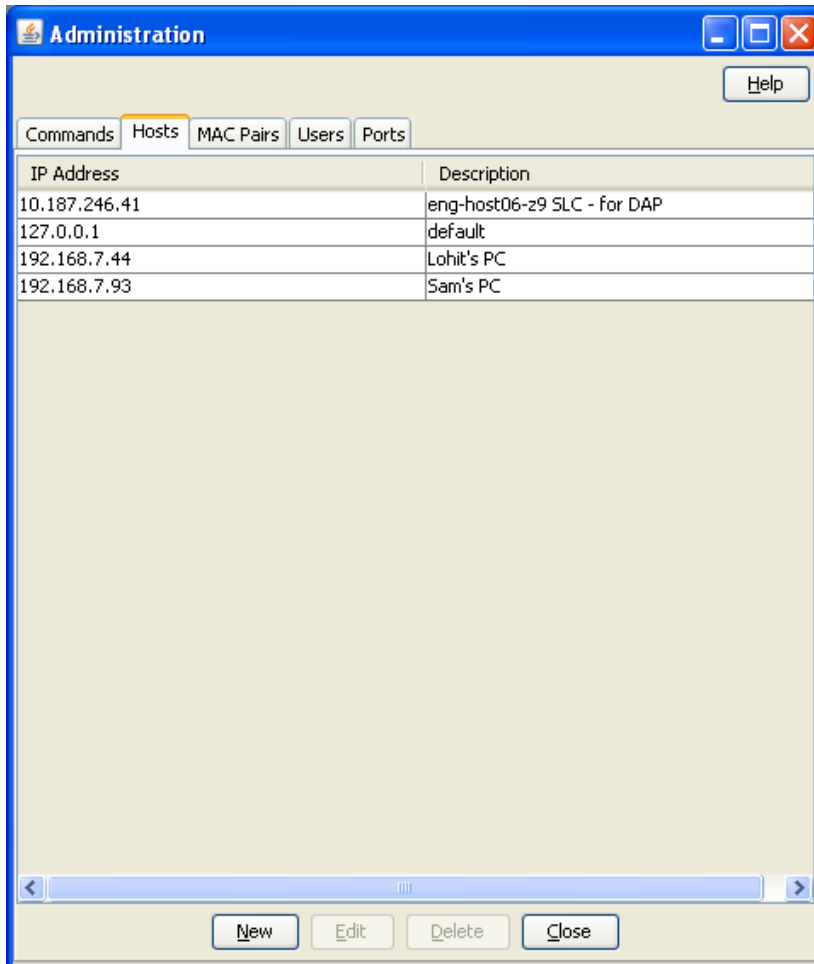

Hosts fields

This table describes the function of each field.

Field	Description
IP Address	The unique IP address of the host which will be allowed to run commands in the PI. Note: You cannot modify the IP address after it is first saved.
Description	A description of the host defined in the IP Address field, such as the hostname. The PI does not use the description value when connecting to the host.

PI Hosts screen

Here is an example PI Hosts screen.

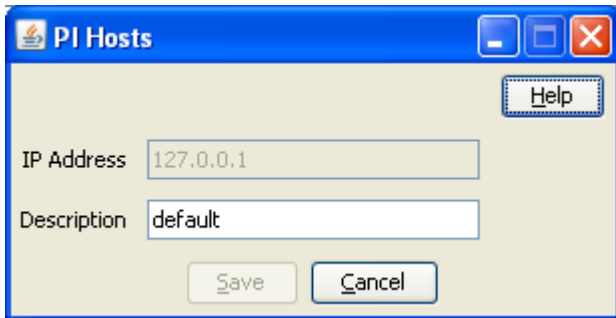

Adding hosts

Follow these steps to add new hosts to the PI.

Step	Action
1	On the Hosts tab, click New . Result: The <i>PI Hosts screen</i> (on page 48) displays. See <i>Hosts fields</i> (on page 47) for a description of each field.
2	In the IP Address field, type the IP address of the host.
3	In the Description field, type a description for the host, such as the hostname.
4	Click Save . Result: The new host details are saved in the database.
5	Soft restart the PI. For details, see <i>Soft PI Restart</i> (on page 66). Result: The updated configuration details will be loaded by the PImanager.

Editing hosts

Follow these steps to edit host information in the PI.

Step	Action
1	On the Hosts tab, select from the list the host to edit.
2	Click Edit . Result: The PI Hosts screen appears showing the data for the selected host record. See <i>Hosts fields</i> (on page 47) for a description of each field.
3	Change the host Description as required.
4	Click Save . Result: The details are saved to the database.
5	Soft restart the PI. For details, see <i>Soft PI Restart</i> (on page 66). Result: The updated configuration details will be loaded by the PImanager.

Deleting hosts

Follow these steps to delete a host from the PI.

Step	Action
1	In the Hosts tab, select from the list the host to delete.

Step	Action
2	Click Delete . Result: The Delete Confirmation screen displays.
3	Click OK . Result: The host is removed from the database.
4	Soft restart the PI. For details, see <i>Soft PI Restart</i> (on page 66). Result: The updated configuration details will be loaded by the PImanager.

PI MAC Pairs

Introduction

The **MAC Pairs** tab of the Administration screen enables you to configure the MAC pairs from which commands can be run in PI. MAC pairs are the security keys to encode and decode encrypted data.

MAC Pairs tab

Here is an example **MAC Pairs** tab.

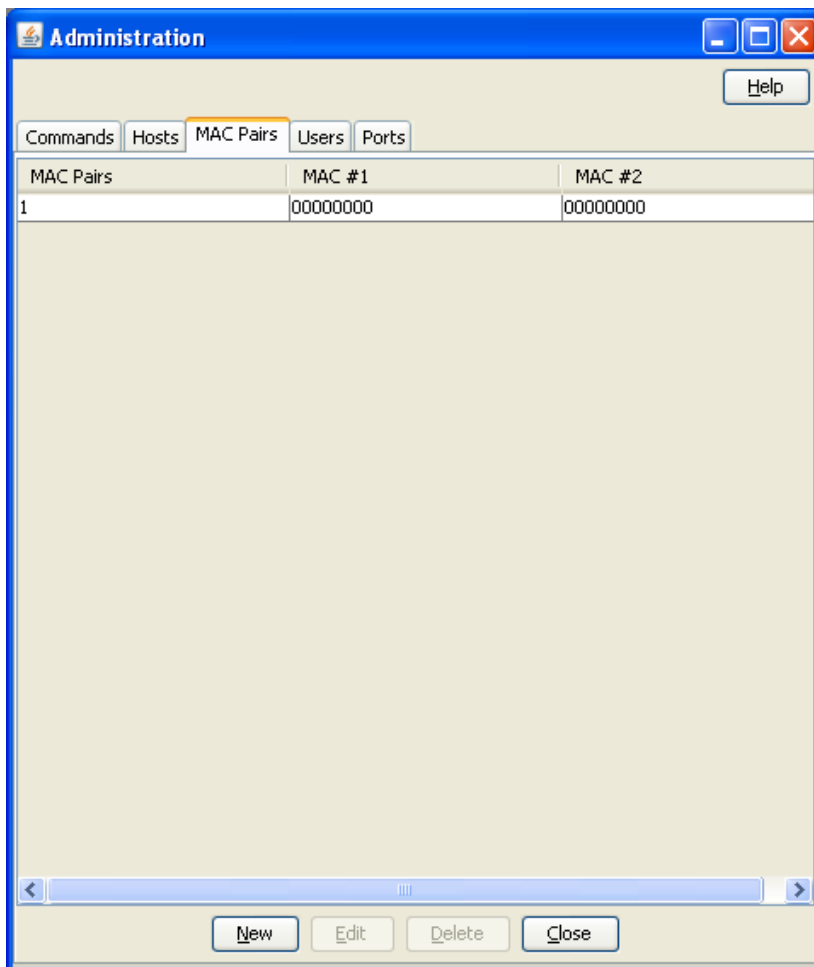

MAC Pairs fields

This table describes the function of each field.

Field	Description
MAC Pair	The unique MAC pair number for this MAC pair. Note: This field cannot be changed after it is first saved.
MAC #1	The MAC address of the first MAC address in this MAC pair. This must be an 8 digit number.
MAC #2	The MAC address of the second MAC address in this MAC pair. This must be an 8 digit number.

PI MACS screen

Here is an example PI MACS edit screen.

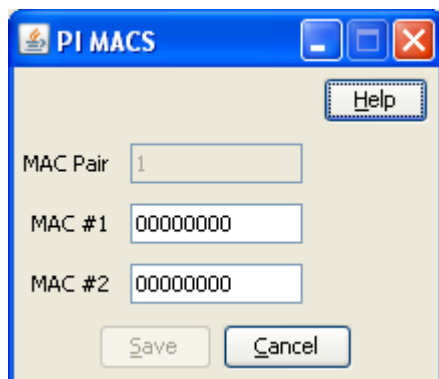

Adding MAC Pairs

Follow these steps to add new MAC pairs to the PI.

Step	Action
1	On the MAC Pairs tab, click New . Result: The <i>PI MACS screen</i> (on page 50) displays. See <i>MAC Pairs fields</i> (on page 50) for a description of each field.
2	Enter in the MAC Pair field the unique MAC pair number.
3	Enter in the MAC #1 field the MAC address of the first entry for the MAC pair.
4	Enter in the MAC #2 field the MAC address of the second entry for the MAC pair.
5	Click Save . Result: The new MAC pair details are saved in the database.
6	Soft restart the PI. For details, see <i>Soft PI Restart</i> (on page 66). Result: The updated configuration details will be loaded by the PImanager.

Editing MAC Pairs

Follow these steps to edit MAC pair information in the PI.

Step	Action
1	On the MAC Pairs tab, select from the list the MAC pair to edit.

Step	Action
2	Click Edit . Result: The <i>PI MACS screen</i> (on page 50) fields will be populated with the data for the selected MAC pair record. See <i>MAC Pairs fields</i> (on page 50) for a description of each field.
3	Change the MAC pair details as required.
4	Click Save . Result: The details are saved to the database.
5	Soft restart the PI. For details, see <i>Soft PI Restart</i> (on page 66). Result: The updated configuration details will be loaded by the PImanager.

Deleting MAC Pairs

Follow these steps to delete a MAC pair from the PI.

Step	Action
1	On the MAC Pairs tab, select from the list the MAC pair to delete.
2	Click Delete . Result: The Delete Confirmation screen displays.
3	Click OK . Result: The MAC pairs are removed from the database.
4	Soft restart the PI. For details, see <i>Soft PI Restart</i> (on page 66). Result: The updated configuration details will be loaded by the PImanager.

PI Users

Introduction

The **Users** tab of the PI Administration screen enables you to add new PI users and to edit and delete existing PI users.

When you add a new PI user you select the service providers to associate with the user. The PI user can run PI commands only for those service providers. This allows you to restrict the data that the PI user can query or modify through the PI. The PI returns a NACK if a PI user attempts to run a PI command for a service provider that they are not associated with.

In addition, you specify the connection details and security level of the PI user. The first command sent to the PI by the PI user will be a connect command, specifying the username and password. PI users can access only those commands that have a security level less than or equal to their security level. Users can use only the MAC pair specified in their profile and are restricted to using the port specified on the screen.

Users tab

The following example screen shows the **Users** tab in the PI Administration screen.

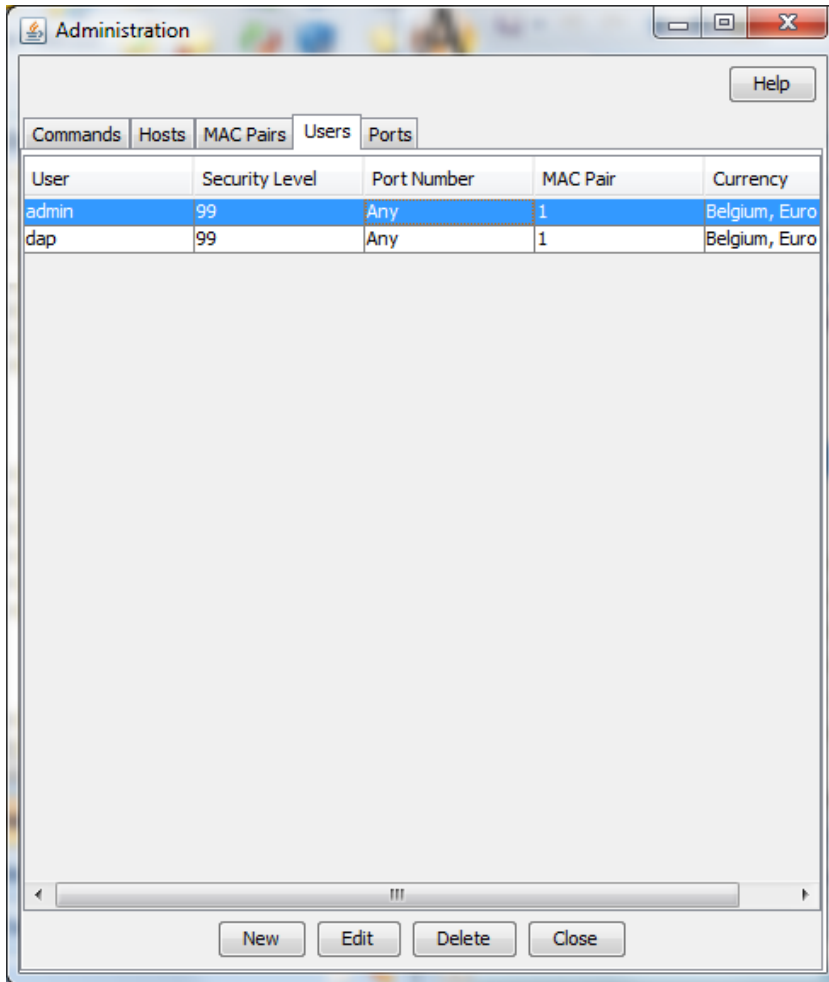

PI Users screen

The following example screen shows the PI Users screen.

The screenshot shows a window titled "PI Users" with a "Help" button in the top right corner. The main area contains several input fields and dropdown menus:

- User: Text input field
- Enter Password: Text input field
- Confirm Password: Text input field
- Security Level: Text input field
- Allow CCSVR1 Private Secret Decryption: Check box (unchecked)
- Port Number: Dropdown menu (value: 2999)
- MAC Pair: Dropdown menu (value: 1)
- Currency: Dropdown menu (value: United Kingdom, Pound Sterling (GBP))
- Last Password Change: Text input field
- Failed Logins: Text input field
- Lock Reason: Text input field

At the bottom, there are two lists of service providers:

- Available Service Providers: Boss, OCNCCtemplate
- Associated Service Providers: (empty)

Between the lists are "Add" and "Remove" buttons. At the bottom of the window are "Save" and "Cancel" buttons.

Users fields

The following table describes the function of each field in the PI Users screen.

Field	Description
User	The unique username for this user. Note: This field cannot be changed after it is first saved.
Enter Password	Sets the password for this PI user.
Confirm Password	Confirms the user's password.
Security Level	The security level for this user. Specify a value between 1 and 99 (inclusive) The user will be able to run PI commands with security levels equal to or lower than this number.
Allow CCSVR1 Private Secret	Permission for the user to decrypt voucher private secret to obtain HRN.

Field	Description
Decryption	
Port Number	The port number this user can connect from.
MAC Pair	The MAC pair this user can connect from. MAC pairs are the security keys to encode and decode encrypted data.
Currency	The reporting currency for this user.
Last Password Change	Date of the last successful password change for this PI User.
Failed Logins	The number of login failures since the last successful login.
Lock Reason	<p>Displays the reason that a user has been locked out of the system.</p> <p>If a user fails to log in to the system in three successive attempts, the system locks the account and the following text is displayed:</p> <p>LOCKED: Failed login, maximum attempts exceeded.</p> <p>For more information about locked accounts, see Unlocking locked PI users.</p> <p>Warning: When you create a user, leave this field blank to avoid creating a locked account.</p>
Available Service Providers	The list of service providers that you can associate with this user.
Associated Service Providers	The list of service providers associated with this user. For PI commands that allow a service provider to be specified, the data that this user can update or query through the PI is restricted to data that is managed by a service provider in this list.

Adding PI users

Follow these steps to add a new PI user.

Step	Action
1	<p>On the Users tab, click New.</p> <p>Result: The PI Users screen appears. See <i>Users fields</i> (on page 53) for a description of each field.</p>
2	In the User field, type a unique username for the PI user you want to add.
3	In the Enter Password field, type the user's password.
4	In the Confirm Password field, retype the user's password to confirm.
5	In the Security Level field, type the command security level for this user. Specify a value between 1 and 99 (inclusive). The user will be able to run PI commands with security levels equal to or lower than this number.
6	From the Port Number list, select the port the user can connect from. To allow the user to connect from any port, select <i>Any</i> .
7	From the MAC Pair list, select the MAC pair the user will connect from.
8	From the Currency list, select the reporting currency for the user.
9	<p>Add the service providers the PI user will be able to run PI commands for to the list of associated service providers:</p> <ul style="list-style-type: none"> To add a service provider to the list, select the service provider in the Available Service Providers box and click Add. To remove a service provider from the list, select the service provider in the Associated Service Providers box and click Remove.

Step	Action
10	Click Save . Result: The new user details are saved in the database.

Editing PI users

Follow these steps to edit the details of a PI user.

Step	Action
1	From the list of PI users on the Users tab, select the user whose details you want to edit.
2	Click Edit . Result: The PI Users screen is populated with the data from the selected user record. See <i>Users fields</i> (on page 53) for a description of each field.
3	Change the user details as required.
4	Click Save . Result: The details are saved to the database.

Deleting PI users

Follow these steps to delete a PI user.

Step	Action
1	From the list of PI users on the Users tab, select the user you want to delete.
2	Click Delete . Result: The Delete Confirmation dialog box appears.
3	Click OK . Result: The PI user is removed from the database.
4	Soft restart the PI. For details, see <i>Soft PI Restart</i> (on page 66). Result: The updated configuration details will be loaded by the PImanager.

PI Ports

Introduction

The **Ports** tab of the PI Administration screen enables the configuration of the ports the PIprocesses listens on.

Ports tab

Here is an example Ports tab.

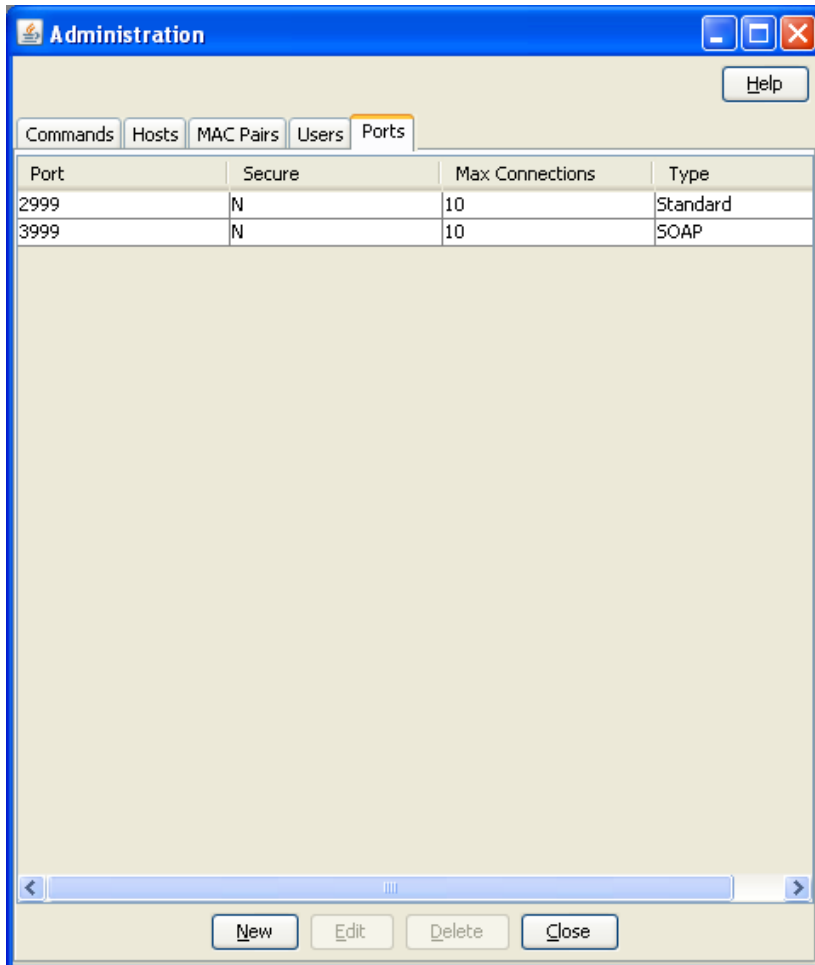

Ports fields

This table describes the function of each field.

Field	Description
Port	The unique port number which will have a PIprocess listening on it. Note: This field cannot be changed after it is first saved.
Secure	If Y, the port will be secure. If N, the port will be insecure.
Max. Connections	The maximum number of concurrent connections to the port.
Type	The type of PI commands which can be run on this port.

PI Ports screen

Here is an example PI Ports screen.

Adding ports

Follow these steps to add new ports to the PI.

Step	Action
1	On the Ports tab, click New . Result: The PI Ports screen appears. See <i>Ports fields</i> (on page 56) for a description of each field.
2	Enter in the Port field the port number.
3	Select the Secure check box if this port should be secure. Deselect the Secure check box if this port is not required to be secure.
4	In the Max. Connections field, type the maximum number of concurrent connections this port will support.
5	From the Type list, select the type of commands that can be run on this port.
6	Click Save . Result: The new port details are saved in the database.
7	Hard restart the PI. See <i>Hard PI Restart</i> (on page 66). Result: The new configuration details are loaded by the PImanager.

Editing ports

Follow these steps to edit port information in the PI.

Step	Action
1	On the Ports tab, select the port you want to edit.
2	Click Edit . Result: The PI Ports screen is populated with the data from the selected port record. See <i>Ports fields</i> (on page 56) for a description of each field.
3	Change the port details as required.
4	Click Save . Result: The details are saved to the database.
5	Hard restart the PI. See <i>Hard PI Restart</i> (on page 66).

Step	Action
------	--------

Result: The new configuration details are loaded by the PImanager.

Deleting ports

Follow these steps to delete a port from the PI.

Step	Action
------	--------

- 1 On the **Ports** tab, select the port to delete.
- 2 Click **Delete**.
Result: The Delete Confirmation dialog box appears.
- 3 Click **OK**.
Result: The port is removed from the database.
- 4 Hard restart the PI. See *Hard PI Restart* (on page 66).
Result: The new configuration details are loaded by the PImanager.

PI Tester Screen

Overview

Introduction

This chapter explains how to use the PI Tester for standard ports screen.

In this chapter

This chapter contains the following topics.

PI Tester Screen.....	59
General	60
Management Tests.....	62
Connection tests	63

PI Tester Screen

Introduction

Use the PI Tester for standard ports screen to check that the PI commands are returning the correct results. It contains the following tabs:

- General
- Management
- Connection

Accessing the PI Tester screen

Follow these steps to access the PI Tester for standard ports screen.

Step	Action
1	Select the Services menu from the Service Management System main menu.

Step	Action
------	--------

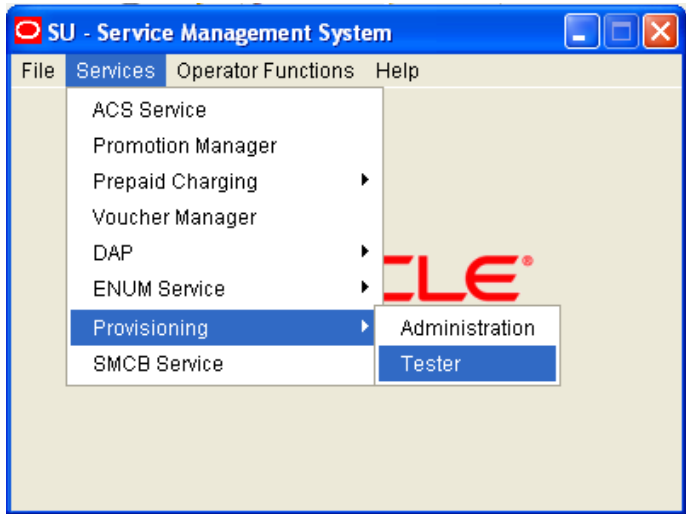

2 Select **Provisioning**.

3 Select **Tester**.

Result: You see the PI Tester for standard ports screen.

General

Introduction

Use the **General** tab of the PI Tester for standard ports screen to modify general test attributes such as the test user and MAC address, and to view the results of management commands.

Note: The fields on the **General** tab are populated automatically. You only need to change them if you do not want to use the default value for a field.

General tab

Here is an example **General** tab.

General fields

This table describes the function of each field.

Note: These fields are automatically populated with the default values.

Field	Description
Username	The user carrying out the tests. The user, defined in the Users tab of the Administration screen, must have the appropriate permissions. Typically, the admin user is used.
Password	The password for the user.
MAC key	The MAC key to use. This ensures the connection is secure.
PI Server	The PI server to connect to.
Port	The port to connect to. The list of available ports only includes port numbers defined for the PI server the screens came from.
Management responses	Displays the results of management commands entered on the Management tab of the PI Tester screen.

Editing the General tab

Follow these steps to change the general test attributes.

Step	Action
1	Select the General tab on the PI Tester for standard ports screen.
2	Change the values for the general attributes as required.

Management Tests

Introduction

Use the **Management** tab in the PI Tester for standard ports screen to send management commands to the PI server, using the values from the **General** tab. The following commands are available:

- Kill – To kill the PI connection for a selected user
- State – To see the current state of the PI commands, hosts and users
- Trace – To set up a trace on the port specified in the **General** tab

Note: The test responses are reported on the **General** tab.

Management tab

Here is an example **Management** tab.

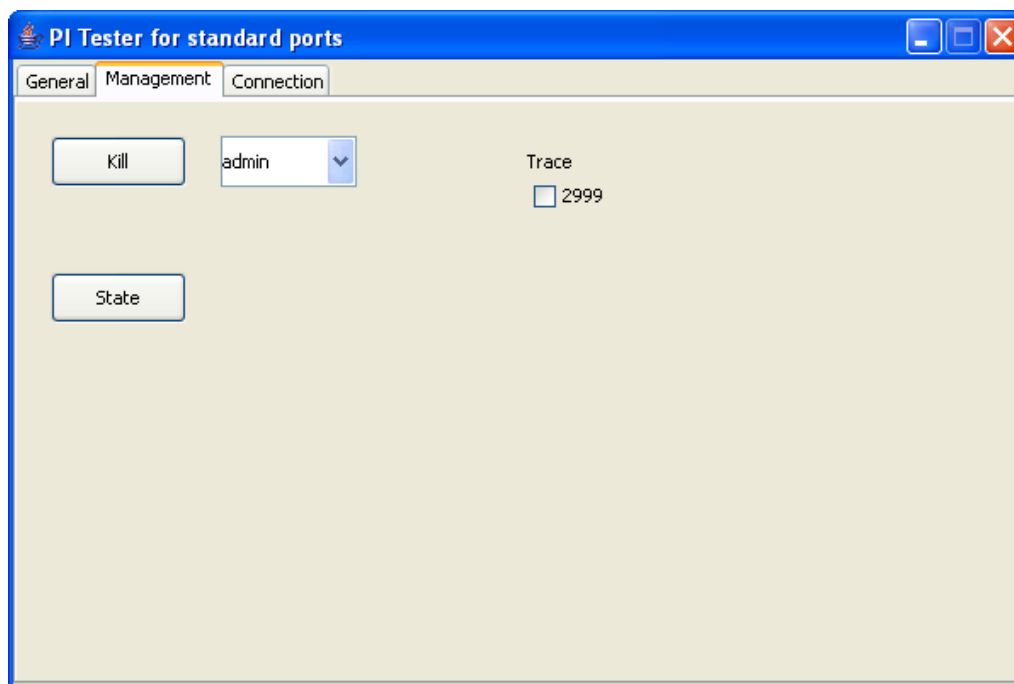

Management fields

This table describes the function of each field.

Field	Description
User selection box	Lets you select a user from the drop down list. You can then kill the user's connection by clicking Kill .
Trace	Lets you switch tracing on, for the port specified on the General tab. The trace log, PI<port>.log is saved to the following directory: <ul style="list-style-type: none"> • if the PImanager was started with the inittab or the startup script, it is saved in /IN/service_packages/SMS. • if the PImanager was started manually, it is saved in /IN/service_packages/MOB_PP/bin.

Using management tests

The following steps explain how to use the management tests.

Step	Action
1	To kill a user's connection, select the user from the list, and click Kill .
2	To find out the state of commands, hosts and users, click State .
3	To put a trace on the port currently selected in the General tab, select the Trace box.

Connection tests

Introduction

Use the **Connection** tab on the PI Tester for standard ports screen to enter commands directly, and check the results. The results appear in the results window on the **Connection** tab.

For PL/SQL commands, the parameters must be entered in the correct order. For C commands, the required parameters must be entered before the optional parameters. See your specific commands specification for details on the syntax to use for commands and the expected results.

Note: The commands you specify may alter the database, so you should use this facility with caution, especially when testing on a live database.

Connection tab

Here is an example **Connection** tab.

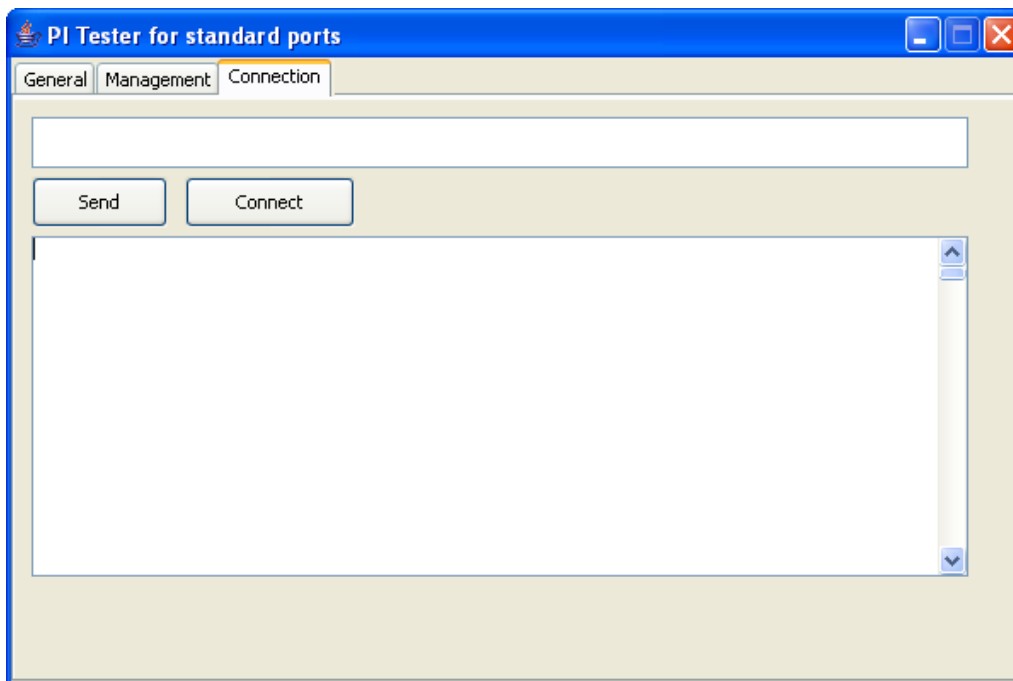

Using connection tests

Follow these steps to run tests from the **Connection** tab on the PI Tester for standard ports screen.

Step	Action
1	<p>Click Connect to set up a connection to the PI server specified on the General tab in the PI Tester for standard ports screen.</p> <p>Result: The results of the connection attempt, including the systamp that will be used later, appear in the lower window.</p>
2	<p>In the upper text box, type in the commands you want to test, and click Send. You must use the following format:</p> <pre>COMMAND=ACTION:REQUIRED_PARAMETER=VALUE,REQUIRED_PARAMETER=VALUE,OPTIONAL_PARAMETER=VALUE,OPTIONAL_PARAMETER=VALUE,SYNSTAMP=NUMBER</pre> <p>Result: The commands are sent to the PI process and the results appear in the lower window.</p>
3	<p>Click Disconnect to disconnect from the PI server.</p>

Background Processes

Overview

Introduction

This chapter explains the PI processes which are used. The PImanager is started using the inittab, and the PIbatch process is started manually.

In this chapter

This chapter contains the following topics.

PImanager	65
PIprocess.....	67
PIbeClient	68
PIbatch.....	68
PIbatch XML	70
PIuser	72

PImanager

Purpose

PImanager starts and stops PI processes as required.

Startup

PImanager can be started by either of two methods:

inittab script

The PImanager should normally be started from the **inittab** script.

```
/IN/service_packages/PI/bin/PImanagerStartup.sh
```

If PImanager is started this way, the output will be shown on the screen, rather than put in the log file.

Started directly

The process can be started directly, using the following code:

```
$ su - smf_oper
$ cd /IN/service_packages/PI/bin
$ ./PImanager [-u <user/password>] [-S <Y|N>] [-t <n>] [-M <m>] [-h] &
```

If PImanager is started this way, the output will be shown on the screen, rather than put in the log file.

Optional parameters

This table describes the optional parameters.

Parameter	Default	Description
<code>-u</code> <i>username/password</i>	/	The Oracle username and password.
<code>-S</code> <i>Y N</i>	Y	Turn on synstamp processing.
<code>-t</code> <i>n</i>	no timeout	Set the timeout to <i>n</i> seconds.
<code>-M</code> <i>m</i>	use database setting	Override database settings for the <i>PIprocess</i> (on page 67) mode of operation <ul style="list-style-type: none"> • 0=Standard • 1=XML with command mode • 2=XML session mode • 3=SOAP
<code>-h</code>		Display usage and exit.

Shutdown

To stop the PImanager when it is running from the `inittab` file, use the utility script (as root user):

```
/IN/service_packages/PI/bin/PIstop.sh.
```

This will also stop all PIprocesses.

To restart after stopping with `PIstop.sh`, use the utility script (as root user):

```
/IN/service_packages/PI/bin/PIstart.sh.
```

To stop the PImanager when not running from the `inittab` file, send the PImanager a `kill -TERM` signal. This will stop the PImanager and any associated PIprocesses.

Reinitializing the PImanager

The PI can be re-initialized using either a “hard” or “soft” reset. The preferred way should be to use the soft reset.

Soft PI Restart

A soft reset is performed by using the utility script:

```
/IN/service_packages/PI/bin/PIreread.sh
```

This causes the PImanager to instruct the PIprocesses to re-read the database. However, the PIprocesses will not re-read the database until all connections have been dropped.

Note: This will not cause the PImanager to start any new PIprocesses added using the *PI Ports* (on page 55) screen. A hard reset must be done in this case.

Hard PI Restart

To do a hard reset, for example, if new PIprocesses have been added using the *PI Ports* screen, use the script:

```
/IN/service_packages/PI/bin/PIrestart.sh
```

This terminates the PImanager and all PIprocesses, and the `inittab` will then restart them.

Note: All connections to the PIprocesses will be lost.

Failure

If the PImanager fails, no commands will be processed. All PIprocesses will also fail.

Output

The PImanager writes error messages to the system messages file, and also writes additional output to `/IN/service_packages/PI/tmp/PImanager.log`.

PIprocess

Purpose

The PIprocess waits for TCP/IP connections, and processes commands sent to it. These commands can be management commands, such as "Connect", "Status" and "Disconnect", or PIcommands, such as "Query Subscriber".

The PIprocess checks that the user and remote host are valid, and then processes the command, either loading the command from a shared library, or executing a PL/SQL function in the database.

Startup

PIprocesses are started by the PImanager process.

If PIprocesses are added using the PI Port screens, the PImanager must be hard restarted to start the new PIprocess processes.

Shutdown

PIprocesses are shut down or restarted using the command scripts for the PImanager which started them, or by sending it a `kill -TERM` signal.

Reinitialising a PIprocess

To force a PIprocess to re-read the database, send it a `kill -HUP` signal. The PIprocess will re-read the database when all connections to it have closed. It is preferable to re-initialize the PImanager (see above) rather than individual PIprocesses.

Configuration

PIprocess is configured using PImanager's configuration.

Failure

If PIprocess fails, PIcommands sent to the port that PIprocess is running on will fail.

Output

The PIprocess writes error messages to the system messages file, and also writes additional output to `/IN/service_packages/PI/tmp/PImanager.log`.

PlbeClient

Purpose

The PlbeClient interacts with billing engines. It is only available for installations which include CCS. If VWS is installed, PlbeClient will connect to the beServer on the Voucher and Wallet Server.

CCS process

PlbeClient is installed by the piCcsSms package. It will only be available on your system if you have installed CCS.

Startup

PlbeClients are started by the Plmanager process as needed.

Shutdown

PlbeClient are shutdown or restarted using the command scripts for the Plmanager which started them, or by sending it a **kill -TERM** signal.

Configuration

The PlbeClient is configured in the `PI` section of `eserv.config`. For more information see *PlbeClient* (on page 10).

Output

The PlbeClient writes error messages to the system messages file, and also writes additional output to `/IN/service_packages/PI/tmp/Plmanager.log`.

Plbatch

Purpose

The PI batch program is a utility to allow multiple PI commands to be sent to Plprocesses, with the commands being specified in a file.

Startup

Plbatch is started with the command line:

```
PIbatch -D script server
```

Configuration

The Plbatch accepts the following command line arguments.

Usage:

```
PIbatch script server
```

Plbatch input files

The Plbatch input scripts contain one command per line. You must order the commands as follows:

- 1 `!c port user password [synstamp] [mac]` – To instruct the Plbatch to connect to the PI on the given port number, using the specified username and password, with the optional synstamp, and with the MAC provided.
- 2 List the PI commands and Plbatch commands. The MAC and SYNSTAMP for commands are supplied automatically.

Note: If you place a ";" on the command line, you will have to include the MAC and SYNSTAMP in the command.
- 3 `!d` – To instruct the Plbatch to disconnect from the PI.

Note: When you place the \$ character at the beginning of a line, it is executed as a shell command.

Example input file

This is an example Plbatch input file.

```
!c 2999 admin admin 151111111
debug on
state
CCSCD4=CHG:MSISDN=1473111222,ADD=1234
!d
```

Note: The MAC address in the "!c" connection string is constructed from the data in the MAC Pairs tab on the PI Administration screens. It is the MAC Pair number prefixed to either the first or second MAC address, as required. In this example, the MAC Pair number is 1 and the MAC Address is 51111111.

Failure

If Plbatch fails, the commands in the batch file will not be executed. Individual commands in the batch file can also fail.

Output

The results of the PI batch program are placed in a file. The file has the same name as Plbatch input file and a `.result` file extension.

The following text appears in the output file for each command sent to the PI:

"Running command *command_name* *the_command_result* End of output from *command_name*"

The output file can also contain some of the following information:

- the `->` symbol followed by text sent to the PI,
- the `<` symbol followed by text received from the PI,
- comments from the input script,
- and when the Plbatch disconnects from the PI, the word "Disconnected" is written to the output file.

Results file example

This is an example Plbatch results file.

```
->admin,admin;
<-ACK,SYNSTAMP=2005021010342483;
->CCSCD1=DEL:MSISDN=1107,SYNSTAMP=2005021010342484,MAC=135424;
<-CCSCD1=DEL:DELETEUser:NACK:1-MSISDN 1107 is not
valid,SYNSTAMP=2005021010342484,MAC=114357;
Disconnected
```

PIbatch XML

Purpose

For PIbatch, the XML formatted PI commands are read from an input file, sent to the PIprocess, and results are optionally returned to a results file.

Startup

PIbatch_xml is started with the command line:

```
PIbatch_XML [-u username] [-p password] [-h hostname] [-n port_number] [-l loop] [-t throttle] [-f trace_file] [file...]
```

Configuration

The PIbatch_xml accepts the following command line arguments.

Usage:

```
PIbatch_XML [-u usr] [-p pwd] [-h host] [-n port] [-l loop] [-t throttle] [-f trace_file] [-M mode] [-c chunk] [-i implicit] [-S ssl] [file...]
```

The available parameters are:

Parameter	Default	Description
-u <i>usr</i>	admin	The username that should be used for logging into the PIprocess.
-p <i>pwd</i>	admin	The password that should be used when logging into the PIprocess.
-h <i>host</i>	localhost	The host name of the PI server.
-n <i>port</i>	2999	The port number of the PIprocess.
-l <i>loop</i>	1	How many times to loop through the commands.
-t <i>throttle</i>	no limit	Maximum number of requests per second.
-f <i>trace file</i>	no file	File to append the PI responses to.
-M <i>mode</i>	1	Mode of operation <ul style="list-style-type: none"> • 1=XML • 2=SOAP
-c <i>chunk</i>	Y	Stipulate chunking (Y N) in the incoming documents (document is in sections preceded by length parameters, and terminated by a single zero on the last line).
-i <i>implicit</i>	Y	Request implicit login (if Y, do not send initial Login request since the document is assumed to contain user credentials).
-S <i>ssl</i>	Y	Request SSL (secure) operation (value Y creates secure connection)
<i>file</i>	standard input	The input file. More than one input file can be specified.

PIbatch xml input file

The input file format is a list of XML formatted PI commands. Each input file can have more than one command. There may be more than one input file.

```
<?xml version="1.0"?>
<methodCall>
  <methodName>PI.OP</methodName>
```

```

<params>
  <param><value><string>@TOKEN@</string></value></param>
  <param><value><string>command_name</string></value></param>
  <param><value><string>action_name</string></value></param>
  <param><value><struct>
    <member>
      <name>param_name</name>
      <value><string>param_value</string></value>
    </member>
  </struct></value></param>
</params>
</methodCall>

```

@TOKEN@: Will be replaced with the authentication token by the PIbatch_XML program.

PIbatch_XML supports sending/receiving SOAP requests/responses. Here is an example SOAP request.

PIbatch_XML SOAP input file example:

```

<env:Envelope
  xmlns:env="http://schemas.xmlsoap.org/soap/envelope/"
  xmlns:xsd="http://www.w3.org/2001/XMLSchema"
  xmlns:xsi="http://www.w3.org/2001/XMLSchema-instance"
  xmlns:enc="http://schemas.xmlsoap.org/soap/encoding/"
  xmlns:ns1="http://uk.oracle.com/pi">
  <env:Body>
    <ns1:command_name>
      <ns1:AUTH>@TOKEN@</ns1:AUTH>
      <ns1:param_name1>param_value</ns1:param_name1>
      <ns1:param_name2>param_value</ns1:param_name2>
      <ns1:param_name3>param_value</ns1:param_name3>
      etc...
    </ns1:command_name>
  </env:Body>
</env:Envelope>

```

Where *command_name* and *param_name* would be substituted with the actual PI command and parameters to be executed.

SOAP Example:

```

<env:Envelope
  xmlns:env="http://schemas.xmlsoap.org/soap/envelope/"
  xmlns:xsd="http://www.w3.org/2001/XMLSchema"
  xmlns:xsi="http://www.w3.org/2001/XMLSchema-instance"
  xmlns:enc="http://schemas.xmlsoap.org/soap/encoding/"
  xmlns:ns1="http://uk.oracle.com/pi">
  <ns1:CCSCD1_ADD>
    <ns1:AUTH>@TOKEN@</ns1:AUTH>
    <ns1:MSISDN>6122000193</ns1:MSISDN>
    <ns1:PROVIDER>Boss</ns1:PROVIDER>
    <ns1:PRODUCT>nzcl</ns1:PRODUCT>
    <ns1:CHARGING_DOMAIN>5</ns1:CHARGING_DOMAIN>
  </ns1:CCSCD1_ADD>
</env:Body>
</env:Envelope>

```

Output

The output file is simply written with the responses from the PI. See the relevant PI command definition for details.

Pluser

Purpose

Use the Pluser utility to create new PI users and passwords to enable users to log into the PI remotely.

For security reasons, before a PI user can run PI commands for a service provider you must associate the service provider with the PI user. This will ensure that the PI user is able to modify and query the data only for those service providers that they are associated with.

To associate a service provider with a PI user, edit the PI user details on the **PI Users** tab in the PI Administration screen. For more information, see *PI Users* (on page 51).

Startup

Start Pluser from the command line by using the following syntax:

```
Pluser -s security_level [-d db_login] [-u username] [-p password] [-n port] [-m mac_pair] [-c currency_code]
```

Configuration

The following table describes the Pluser command line parameters.

Parameter	Description
-s <i>security_level</i>	The PI security level for the new PI user. The new PI user will be able to run PI commands with security levels equal to or lower than this number. Specify a number between 1 and 99 inclusive.
-d <i>db_login</i>	(Optional) The username and password for the Oracle database login ID. Defaults to / if not set.
-u <i>username</i>	(Optional) The username for the new PI user. Pluser prompts for the username if not set. You must specify a unique name.
-p <i>password</i>	(Optional) The password for the new PI user. Pluser prompts for the password if not set and checks for strength based on the password policy that is set. For admin users, this password can be set at installation time from OUI invoking the Pluser command and skips strength checking of the password.
-n <i>port</i>	(Optional) The port number that the PI user will use for remote login. Defaults to all ports if not set.
-m <i>mac_pair</i>	(Optional) The MAC pair the new PI user can connect from. Defaults to 1 (one) if not set.
-c <i>currency_code</i>	(Optional) The reporting currency for the new PI user. Defaults to the system currency if not set.

PI Management Commands

Overview

Introduction

This chapter explains the Oracle Communications Convergent Charging Controller Provisioning Interface (PI) management commands.

In this chapter

This chapter contains the following topics.

Debug Command	73
Traceon Command.....	75
Traceoff Command.....	76
State Command.....	76
Kill Command	76
Sendrate Command	77
Logstats on/off Command	78

Debug Command

Purpose

The PI can run in debug mode. You should use this mode only to trace faults.

Debug mode can be turned on or off for each component or command while the PI is running. To do this, in the PItester screen, send a debug command to the PIprocess.

The general list of components that can be specified is:

- PIbatch (turn debug on in PIbatch)
- PImanager (turn debug on in PImanager)
- PIprocess (turn debug on in non-command parts of PIprocess)
- PIcCommands (turn debug on in common parts of PI commands)

If piCcsSms is installed:

- PIbeClient (turn debug on in non-beClientIF parts of PIbeClient)

For the 3 different types of PI command syntax only the standard and XML currently support the ability to dynamically turn debug on and off for specified PI commands. PI XML SOAP does not currently support this functionality and requires a restart of the PI to turn debug on or off.

Note: Refer to your specific *Command Specification* for details of all the available commands.

Format

The format of the debug command is:

```
debug {on/off} component1 [component2] [component3] ... [component];
```

Component is the command, or command with the equals sign converted to an underscore.

Example:

- CCSCD1_ADD
- CCSCD1_DEL

The format of the dynamic debug for XML commands is:

Example PI XML debug commands:

```
<?xml version="1.0"?>
<methodCall>
  <methodName>PI.Debug</methodName>
  <params>
    <param>
      <value>
        <string>@TOKEN@</string>
      </value>
    </param>
    <param>
      <value>
        <struct>
          <member>
            <name>component1</name>
            <value>
              <string>off</string>
            </value>
          </member>
          <member>
            <name>component2</name>
            <value>
              <string>on</string>
            </value>
          </member>
        </struct>
      </value>
    </param>
  </params>
</methodCall>
```

Example

The following command examples turns debug on for CCSCD1=ADD:

```
debug on CCSCD1_ADD;
```

To turn on debug for CCSCD1=ADD and CCSCD1=DEL commands, use:

```
debug on CCSCD1_ADD CCSCD1_DEL;
```

To turn on debug for all CCSCD1 commands, use

```
debug on CCSCD1
```

Note: This also turns on PlcCommands but only for the command used, that is, CCSCD1_ADD.

The following PI XML command example turns debug on for CCSCD1=ADD and off for CCSCD1=DEL:

```
<?xml version="1.0"?>
<methodCall>
  <methodName>PI.Debug</methodName>
  <params>
    <param>
      <value><string>@TOKEN@</string></value>
    </param>
```



```

    <param>
      <value>
        <struct>
          <member>
            <name>CCSCD1=ADD</name><value><string>off</string></value>
          </member>
          <member>
            <name>CCSCD1=DEL</name><value><string>off</string></value>
          </member>
        </struct>
      </value>
    </param>
  </params>
</methodCall>

```

Note: This turns DEBUG+PlcCommands on or off, but only for the command(s) specified (CCSCD1=ADD and CCSCD1=DEL).

Output

Debug prints output to the `//IN/service_packages/PI/tmp/PImanager.log` file.

The `//IN/service_packages/PI/tmp/PImanager.log` file will only log successfully completed debug {on/off} commands for the PIprocess.

Example:

```

Oct 5 23:22:17 PIprocess:2998(21833) About to turn debug on for CCSCD1=ADD
Oct 5 23:22:17 PIprocess:2998(21833) About to turn debug off for CCSCD1=DEL

```

When dynamic PI command debug is on, the output is printed to the `//IN/service_packages/PI/tmp/PImanager.log` file.

Traceon Command

Purpose

The traceon command enables tracing of all PI commands. The tracing results are output to a file.

Tip: This command is now deprecated. We recommend you use the debug command instead.

Format

The format of the traceon command is:

```
traceon;
```

Example

The following command enables tracing of PI commands:

```
traceon;
```

Output

PI command tracing is output to the following file:

```
PIport_number.trace
```

Traceoff Command

Purpose

This command disables tracing.

Tip: This command is deprecated. We recommend you use the debug command instead.

Format

The format of the traceoff command is:

```
traceoff;
```

Example

The following command disables tracing of PI commands:

```
traceoff;
```

State Command

Purpose

Use the state command to print the current state of the PIprocess.

Format

The format of the state command is:

```
state;
```

Example

The following command prints the current state of the PI process:

```
state;
```

Output

The current state of the PI process is output to the following file:

```
PIport_number.state
```

Kill Command

Purpose

Use the kill command to kill a connection from a given username.

Format

The format of the kill command is:

```
kill username;
```

Example

The following command kills the connection from user bob:

```
kill bob;
```

Sendrate Command

Purpose

Use the sendrate command to specify the maximum number of PI commands that an individual PIprocess will send per second for processing by the billing engine. This allows each PIprocess to place only the desired load on the billing engine.

Example: Setting the sendrate for the port being used by PIbatch to the minimum rate of one, keeps its load to a minimum. This helps preserve the billing engine capacity for "live" usage.

Tip: The default sendrate can be set for all PIprocesses in `eserv.config`. For details, see `eserv.config Configuration` (on page 6).

Format

The format of the sendrate command is:

```
sendrate n;
```

The available parameter is:

Parameter	Default	Description
<i>n</i>		The number of PI commands to send to the billing engine per second. This must be a whole number. Tip: To turn throttling off, set the sendrate to 0 (zero).

Checking the sendrate

You can use the state command to check the sendrate for the PI processes. This reports the values for all connected PI processes. For details see *State Command* (on page 76).

PIbatch sendrate

You can use the sendrate command to control the sendrate when using PIbatch. You:

1. Add the sendrate command to the batch input file after the connect line
2. Add a second sendrate command before the disconnect line to reset the sendrate to its original value

Warning: This will affect all connections to this PIprocess.

Batch optimization

To optimize the batch, the sendrate can be calculated as follows. The resulting number must be rounded up to the nearest whole number:

$\text{sendrate} = \text{number of commands} / \text{maximum time for batch (seconds)}$

Example: For 40000 commands in 4 hours (14400 seconds) the $\text{sendrate} = 40000 / 14400 = 2.8$. The rounded up value for the sendrate is 3.

Using sendrate for performance

You can use the `sendrate` command to control the load put on the billing engine by the different PI processes.

This can be achieved by setting the default `sendrate` in `eserv.config`, and then overriding the default for each individual PIprocess requiring a different value.

To override the default values, connect to each PIprocess port in turn and set the `sendrate` to the desired value.

Example

In this example there are three PIprocesses running on ports 2999, 3000, 3001. PIbatch is running on port 3001 and it needs to run at a lower rate than the other processes so that it does not overload the billing engines. A higher rate is required for the process running on port 2999. This can be achieved in the following way:

Set the throttling parameter in `eserv.config` as:

```
pi = {
  throttling = {
    sendRate = 2
  }
}
```

Then in a PIbatch script define the `sendrate` for ports 3001 and 2999:

```
# start of PIbatch script
# set PIbatch port to lower rate
!c 3001 PIuser PIpasword mac_number
sendrate 1
state
!d

# set shop port 2999 to higher rate
!c 2999 PIuser PIpasword mac_number
sendrate 3
state
!d
# end of PIbatch script
```

Logstats on/off Command

Purpose

Use the `logstats on` or `logstats off` command to switch the output of the timing statistics on, or off, every 30 seconds.

The following five statistics are collected for each command, over a 30 second time period:

- Number of successful uses of the command
- Number of unsuccessful uses of the command
- Minimum response time (in milliseconds)
- Average response time (in milliseconds)
- Maximum response time (in milliseconds)

Note: These statistics are for a single period; they are not cumulative.

Output

The output from the statistics has the following format:

command name followed by the five statistics separated by a slash (/) character.

COMMAND=ACTION 12/13/1/2/3

Example Output:

```
Jul 31 15:30:59 PProcess:2999(1001) Statistics for last 30 seconds (<command>
<successful>/<failed>/<min>/<max>/<avg>):
Jul 31 15:30:59 PProcess:2999(1001) ACSCLI=ADD 0/0/0/0/0 ACSCLI=DEL 0/0/0/0/0 ACSCLI=QRY
0/0/0/0/0
```

About Installation and Removal

Overview

Introduction

This chapter provides information about the installed components for the Oracle Communications Convergent Charging Controller application described in this guide. It also lists the files installed by the application that you can check for, to ensure that the application installed successfully.

In this Chapter

This chapter contains the following topics.

Installation and Removal Overview	81
Checking the Installation	82

Installation and Removal Overview

Introduction

For information about the following requirements and tasks, see *Installation Guide*:

- Convergent Charging Controller system requirements
- Pre-installation tasks
- Installing and removing Convergent Charging Controller packages

PI packages

An installation of Provisioning Interface includes the following packages, on the SMS:

- piSms
- piCluster (if installing on a clustered SMS)
- piAcsSms
- piCcsSms
- piSubscriberSms
- piVoucherSms
- piSrmSms
- piWalletSms
- piVpnSms
- piXmsSms
- npPISms

Packages and dependencies

The Prepaid Charging v3.0 on-line provisioning interface engine can be delivered in up to six packages:

- piSms – A framework to execute a PI command. This package is always required.

- piCcsSms – Commands and UBE client. This package is always required.
- piSubscriberSms – Command definitions for a subscriber domain. This package is optional.
- piWalletSms – Command definitions for a wallet domain. This package is optional.
- piVoucherSms – Command definitions for a voucher domain. This package is optional.
- piSrmSms – Command definitions for the subscriber relationship manager. This package is optional.

Packages must be installed as shown in the hierarchy:

- 1 piSms
- 2 piCcsSms
- 3 The rest in any order

Packages have the hierarchy shown in the following diagram:

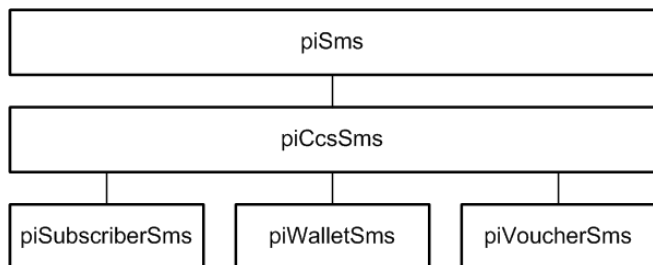

Updating the eserv.config file manually

Note that at the end of the installation script of some PI packages, there is note advising the installer to manually update the **eserv.config** file using the contents of the example config file. After installation, follow these instructions to configure the **eserv.config** file. For example:

```
Example configuration files have been installed to
  /IN/service_packages/PI/etc/eserv.config.pi_example.CCS and
  /IN/service_packages/PI/etc/eserv.config.pi_example.CCS.full
Please use these as a guide to setting up your runtime
configuration file at
  /IN/service_packages/eserv.config
```

for example. If there is no existing pi section in **eserv.config**, copy the entire contents of the **eserv.config**.pi_example.CCS file to the end of the runtime configuration file. If there is a pi section, copy the relevant items into the pi section.

See *eserv.config Configuration* (on page 6) for details.

Checking the Installation

Introduction

This topic provides a list of things which should be checked to ensure the installation was successful.

Process list

When the application is running correctly, the following processes are run by smf_oper:

- Plmanager
- Plprocess (if PI has been set up on more than one port, there should be as many Plprocesses as configured ports)

Note: Plbatch may also be running.

Checking the commands

When you install a PI commands package, this inserts the new commands into new rows in the PI_COMMANDS database table. After completing the installation, check this table to ensure the new commands have been added.

Database tables

The following database tables are added to the SMF database:

- PI_COMMANDS
- PI_HOSTS
- PI_PORTS
- PI_MACS
- PI_USERS

Glossary of Terms

ACS

Advanced Control Services configuration platform.

API

Application Programming Interface

ASP

- Application Service Provider, or
- Application Server Process. An IP based instance of an AS. An ASP implements a SCTP connection between 2 platforms.

CC

Country Code. Prefix identifying the country for a numeric international address.

CCS

- 1) Charging Control Services component.
- 2) Common Channel Signalling. A signalling system used in telephone networks that separates signalling information from user data.

Connection

Transport level link between two peers, providing for multiple sessions.

Convergent

Also “convergent billing”. Describes the scenario where post-paid and pre-paid calls are handed by the same service platform and the same billing system. Under strict converged billing, post-paid subscribers are essentially treated as “limited credit pre-paid”.

cron

Unix utility for scheduling tasks.

DAP

Data Access Pack. An extension module for ACS which allows control plans to make asynchronous requests to external systems over various protocols including XML and LDAP.

DTMF

Dual Tone Multi-Frequency - system used by touch tone telephones where one high and one low frequency, or tone, is assigned to each touch tone button on the phone.

GUI

Graphical User Interface

HRN

Hidden Reference Number or Human Readable Number

HTML

HyperText Markup Language, a small application of SGML used on the World Wide Web.

It defines a very simple class of report-style documents, with section headings, paragraphs, lists, tables, and illustrations, with a few informational and presentational items, and some hypertext and multimedia.

HTTP

Hypertext Transport Protocol is the standard protocol for the carriage of data around the Internet.

IN

Intelligent Network

IP

1) Internet Protocol

2) Intelligent Peripheral - This is a node in an Intelligent Network containing a Specialized Resource Function (SRF).

IP address

Internet Protocol Address - network address of a card on a computer.

ISDN

Integrated Services Digital Network - set of protocols for connecting ISDN stations.

Messaging Manager

The Messaging Manager service and the Short Message Service components of Oracle Communications Convergent Charging Controller product. Component acronym is MM (formerly MMX).

MM

Messaging Manager. Formerly MMX, see also *XMS* (on page 88) and *Messaging Manager* (on page 86).

MSISDN

Mobile Station ISDN number. Uniquely defines the mobile station as an ISDN terminal. It consists of three parts; the country code (CC), the national destination code (NDC) and the subscriber number (SN).

NP

Number Portability

PI

Provisioning Interface - used for bulk database updates/configuration instead of GUI based configuration.

PIN

Personal Identification Number

PL/SQL

Oracle's Procedural Language for stored procedures and packages.

Service Provider

See Telco.

SGML

Standard Generalized Markup Language. The international standard for defining descriptions of the structure of different types of electronic document.

SLC

Service Logic Controller (formerly UAS).

SMS

Depending on context, can be:

- Service Management System hardware platform
- Short Message Service
- Service Management System platform
- Convergent Charging Controller Service Management System application

SN

Service Number

SOAP

Simple Object Access Protocol. An XML-based messaging protocol.

SQL

Structured Query Language is a database query language.

SRF

Specialized Resource Function – This is a node on an IN which can connect to both the SSP and the SLC and delivers additional special resources into the call, mostly related to voice data, for example play voice announcements or collect DTMF tones from the user. Can be present on an SSP or an Intelligent Peripheral (IP).

SSL

Secure Sockets Layer protocol

SSP

Service Switching Point

TCP

Transmission Control Protocol. This is a reliable octet streaming protocol used by the majority of applications on the Internet. It provides a connection-oriented, full-duplex, point to point service between hosts.

Telco

Telecommunications Provider. This is the company that provides the telephone service to customers.

Telecommunications Provider

See Telco.

VPN

The Virtual Private Network product is an enhanced services capability enabling private network facilities across a public telephony network.

VWS

Oracle Voucher and Wallet Server (formerly UBE).

WSDL

Web Services Description Language.

XML

eXtensible Markup Language. It is designed to improve the functionality of the Web by providing more flexible and adaptable information identification.

It is called extensible because it is not a fixed format like HTML. XML is a 'metalanguage' — a language for describing other languages—which lets you design your own customized markup languages for limitless different types of documents. XML can do this because it's written in SGML.

XMS

Three letter code used to designate some components and path locations used by the Oracle Communications Convergent Charging Controller *Messaging Manager* (on page 86) service and the Short Message Service. The published code is *MM* (on page 86) (formerly *MMX*).

Index

A

- About Configuring PI Commands in eserv.config • 31
- About Installation and Removal • 81
- About This Document • v
- Accessing the PI Administration screen • 43
- Accessing the PI Tester screen • 59
- ACS • 85
- acsCustomerId • 36
- action • 13
- activatePreuseAccount • 35
- Adding hosts • 48
- Adding MAC Pairs • 50
- Adding PI users • 54
- Adding ports • 57
- allowedSourceWalletStates • 19
- allowINSECURESSLv3 • 24
- API • 85
- ASP • 85
- Audience • v
- authentication • 9

B

- Background Processes • 65
- billingEngines • 22
- Broadcast plug-in • 15, 20

C

- CC • 85
- CCS • 85
- CCS process • 68
- CCSBPL • 35
- CCSCD1 • 32
- CCSCD3 • 34
- CCSCD9 • 37
- CCSSC1 • 38
- CCSVR1 • 36
- certificateFile • 25
- Checking the commands • 83
- Checking the Installation • 82
- Checking the sendrate • 77
- clientName • 11
- Command package details • 4
- Commands fields • 45, 46
- Commands tab • 45
- Component descriptions • 2
- Component diagram • 2
- config • 14
- Configuration • 5, 67, 68, 70, 72
- Configuration components • 5
- Configuration File Format • 6
- Configuration Overview • 5
- Connection • 85
- Connection tab • 63

- Connection tests • 63
- connectionRetryTime • 11
- Convergent • 85
- Copyright • ii
- coreWhenProcessUnresponsive • 8
- correlationRequestTagName • 8
- correlationResponseTagName • 8
- createEmptyBalance • 33
- creditTransferCP • 34
- cron • 85
- currencyType • 33

D

- DAP • 85
- Database tables • 83
- debug • 8
- Debug Command • 73
- decrypt_private_secret • 37
- Default.lang • 39
- Default_PI.hs • 40
- defaultBEDomainID • 38
- defaultScenarioName • 35
- Defining a Password Policy • 41
- Defining the Help Screen Language • 39, 40
- Defining the Screen Language • 38
- Deleting hosts • 48
- Deleting MAC Pairs • 51
- Deleting PI users • 55
- Deleting ports • 58
- Document Conventions • vi
- DTMF • 85

E

- Editing hosts • 48
- Editing MAC Pairs • 50
- Editing PI commands • 46
- Editing PI users • 55
- Editing ports • 57
- Editing the File • 7
- Editing the General tab • 61
- eserv.config Configuration • 3, 5, 6, 77, 82
- eserv.config file example
 - eserv.config.pi_example • 28
- eserv.config Files Delivered • 6
- eserv.config subsections • 7
- eserv.config.pi_example • 7
- Example • 74, 75, 76, 77
- Example helpset language • 40
- Example input file • 69
- Example Password Policy • 42
- Example screen • 46
- Example Screen Language • 39
- expansionRules • 26
- exportCallPlanDirectory • 31

F

- Failure • 67, 69

fixedVoucherNumberLength • 34
Format • 73, 75, 76, 77
function • 14

G

General • 7, 60
General fields • 61
General tab • 61
Getting Information About Voucher Changes by
Using PI Commands • 32
GUI • 85

H

Hard PI Restart • 57, 58, 66
heartbeatPeriod • 11
Hosts fields • 47, 48
Hosts tab • 47
HRN • 86
HTML • 86
HTTP • 86

I

id • 22
implicitLoginsSupported • 26
IN • 86
initialState • 32
inittab script • 65
Installation and Removal Overview • 4, 81
Introduction • 1, 4, 5, 6, 31, 38, 40, 43, 44, 46,
49, 51, 55, 59, 60, 62, 63, 81, 82
Introduction to the Provisioning Interface • 1
ip • 23
IP • 86
IP address • 86
ISDN • 86

K

keyFile • 25
Kill Command • 76

L

library • 15
Loading eserv.config Changes • 7
Local time zone • 31
localTZ • 31
loglevel • 9
Logstats on/off Command • 78

M

MAC Pairs fields • 50, 51
MAC Pairs tab • 49
Management fields • 62
Management tab • 62
Management Tests • 62
maxFifoReadRetry • 35
maxOutstandingMessages • 12

Merge Wallets plug-in • 18
mergeBucketExpiryPolicy • 19
mergeWalletExpiryPolicy • 19
mergeWalletsTriggers • 20
messageTimeoutSeconds • 12
Messaging Manager • 86, 88
MM • 86, 88
MSISDN • 86

N

namedEventCanSendDebitBalanceNegative •
12
noAuthTokenForAnyPIError • 10
notEndActions • 13, 20, 21
notifyEagain • 35
noWalletCreateBelds • 33
NP • 86

O

Optional parameters • 66
Optional sections in eserv.config • 7
oracleLogin • 13, 20
oraUser • 9
Output • 67, 68, 69, 71, 75, 76, 78
Overview • 1, 5, 43, 59, 65, 73, 81

P

Packages and dependencies • 81
Password Policy Requirements • 41
Password Verification Function • 42
PI • 86
PI Administration Screen • 2, 5, 43
PI command installation • 4
PI Commands • 4, 44
PI Hosts • 46
PI Hosts screen • 48
PI MAC Pairs • 49
PI MACS screen • 50, 51
PI Management Commands • 73
PI packages • 81
PI Ports • 55, 66
PI Ports screen • 57
PI Tester Screen • 2, 59
PI Users • 51, 72
PI Users screen • 53
PIbatch • 2, 68
PIbatch input files • 68
PIbatch sendrate • 77
PIbatch XML • 3, 70
PIbatch xml input file • 70
PIbeClient • 10, 68
PImanager • 2, 65
PIN • 87
PIprocess • 2, 3, 66, 67
PIuser • 72
PL/SQL • 87
plugins • 14

- port • 24
- Ports fields • 56, 57
- Ports tab • 56
- pqyzMaxRecords • 38
- Prerequisites • v
- primary • 23
- Procedure • 39, 40
- Process • 3
- Process list • 82
- Purpose • 65, 67, 68, 70, 72, 73, 75, 76, 77, 78

R

- Reinitialising a PIprocess • 67
- Reinitializing the PImanager • 66
- Related Documents • v
- reportPeriodSeconds • 15
- Results file example • 69

S

- Scope • v
- secondary • 23
- securityPlugin • 9
- sendBadPin • 16
- sendRate • 10
- Sendrate Command • 77
- Service Provider • 87
- Setting the Control Plan Export File Directory for ACSCPL PI Commands • 31
- SGML • 87
- Shutdown • 66, 67, 68
- SLC • 87
- SMS • 87
- SN • 87
- soap • 25, 27
- SOAP • 87
- Soft PI Restart • 46, 48, 49, 50, 51, 55, 66
- Specifying the Maximum PQYZ Records to Query in the NP Database • 38
- SQL • 87
- strasActivatesPreuseAccount • 16, 18
- SRF • 87
- ssl • 24
- SSL • 87
- SSP • 87
- Started directly • 65
- Startup • 65, 67, 68, 70, 72
- State Command • 76, 77
- stateConversions • 22
- suppressEmptyFields • 37
- suppressFields • 37
- suppressScenario • 36
- synstamp • 9
- System Overview • 1

T

- TCP • 88
- Telco • 88

- Telecommunications Provider • 88
- Throttling • 10
- timeout • 9
- Traceoff Command • 76
- Traceon Command • 75
- Triggering BPL tasks • 3
- triggerTimeoutSeconds • 36
- type • 13
- Typographical Conventions • vi

U

- Updating the eserv.config file manually • 82
- Users fields • 53, 54, 55
- Users tab • 52
- useSystemLanguage • 34
- Using connection tests • 64
- Using management tests • 63
- Using sendrate for performance • 78

V

- validateAuthStrings • 26
- Voucher and wallet plugins • 15
- Voucher Recharge plug-in • 16
- Voucher Type Recharge plug-in • 17
- voucherRechargeTriggers • 17
- voucherServerCacheCleanupInterval • 17
- voucherServerCacheLifetime • 17
- voucherStateConversions • 21
- voucherTypeRechargeTriggers • 18
- VPN • 88
- VWS • 88

W

- WSDL • 88

X

- XML • 88
- XMS • 86, 88