

**Oracle® Communications
Convergent Charging Controller**

CAP3 GPRS Protocol Implementation Conformance
Statement

Release 12.0.0

December 2017

Copyright

Copyright © 2017, Oracle and/or its affiliates. All rights reserved.

This software and related documentation are provided under a license agreement containing restrictions on use and disclosure and are protected by intellectual property laws. Except as expressly permitted in your license agreement or allowed by law, you may not use, copy, reproduce, translate, broadcast, modify, license, transmit, distribute, exhibit, perform, publish, or display any part, in any form, or by any means. Reverse engineering, disassembly, or decompilation of this software, unless required by law for interoperability, is prohibited.

The information contained herein is subject to change without notice and is not warranted to be error-free. If you find any errors, please report them to us in writing.

If this is software or related documentation that is delivered to the U.S. Government or anyone licensing it on behalf of the U.S. Government, then the following notice is applicable:

U.S. GOVERNMENT END USERS: Oracle programs, including any operating system, integrated software, any programs installed on the hardware, and/or documentation, delivered to U.S. Government end users are "commercial computer software" pursuant to the applicable Federal Acquisition Regulation and agency-specific supplemental regulations. As such, use, duplication, disclosure, modification, and adaptation of the programs, including any operating system, integrated software, any programs installed on the hardware, and/or documentation, shall be subject to license terms and license restrictions applicable to the programs. No other rights are granted to the U.S. Government.

This software or hardware is developed for general use in a variety of information management applications. It is not developed or intended for use in any inherently dangerous applications, including applications that may create a risk of personal injury. If you use this software or hardware in dangerous applications, then you shall be responsible to take all appropriate fail-safe, backup, redundancy, and other measures to ensure its safe use. Oracle Corporation and its affiliates disclaim any liability for any damages caused by use of this software or hardware in dangerous applications.

Oracle and Java are registered trademarks of Oracle and/or its affiliates. Other names may be trademarks of their respective owners.

Intel and Intel Xeon are trademarks or registered trademarks of Intel Corporation. All SPARC trademarks are used under license and are trademarks or registered trademarks of SPARC International, Inc. AMD, Opteron, the AMD logo, and the AMD Opteron logo are trademarks or registered trademarks of Advanced Micro Devices. UNIX is a registered trademark of The Open Group.

This software or hardware and documentation may provide access to or information about content, products, and services from third parties. Oracle Corporation and its affiliates are not responsible for and expressly disclaim all warranties of any kind with respect to third-party content, products, and services unless otherwise set forth in an applicable agreement between you and Oracle. Oracle Corporation and its affiliates will not be responsible for any loss, costs, or damages incurred due to your access to or use of third-party content, products, or services, except as set forth in an applicable agreement between you and Oracle.

Contents

About This Document	v
Document Conventions	vi
Chapter 1	
Compliance Statement.....	1
Overview.....	1
About CAP3GPRS Compliance	1
CAP3GPRS Configuration for Message Sequences	2
Chapter 2	
CAP3GPRS Message Sequences.....	5
Overview.....	5
Message Sequences for Sessions	5
Message Sequences with PDP Contexts.....	9
Message Sequences for ActivityTestGPRS	18
Chapter 3	
Operations Supported by CAP3GPRS Control Agent.....	25
Overview.....	25
Operations Sent from SGSN to the Control Agent.....	25
Operations Sent to SGSN from the Control Agent.....	28
Glossary of Terms	33
Index	37

About This Document

Scope

This statement of compliance compares the Oracle Communications Convergent Charging Controller CAP version 3 GPRS Control Agent (CAP3GPRS Control Agent) to:

- The GPRS specific parts of the CAMEL Application Part (CAP) Phase 3 specification document, *ETSI TS 129.078 v4.8.0*.

Audience

This guide is intended for use by software engineers and testers who need a description of the message sequences used by the CAP3GPRS Control Agent.

Related Documents

The following documents are related to this document:

- *ACS Technical Guide*
- *CAP3GPRS Control Agent Technical Guide*
- *CCS Technical Guide*
- *CCS User's Guide*
- *SMS Technical Guide*
- *SMS User's Guide*
- *SLEE Technical Guide*

Document Conventions

Typographical Conventions

The following terms and typographical conventions are used in the Oracle Communications Convergent Charging Controller documentation.

Formatting Convention	Type of Information
Special Bold	Items you must select, such as names of tabs. Names of database tables and fields.
<i>Italics</i>	Name of a document, chapter, topic or other publication. Emphasis within text.
Button	The name of a button to click or a key to press. Example: To close the window, either click Close , or press Esc .
Key+Key	Key combinations for which the user must press and hold down one key and then press another. Example: Ctrl+P or Alt+F4 .
Monospace	Examples of code or standard output.
Monospace Bold	Text that you must enter.
<i>variable</i>	Used to indicate variables or text that should be replaced with an actual value.
menu option > menu option >	Used to indicate the cascading menu option to be selected. Example: Operator Functions > Report Functions
hypertext link	Used to indicate a hypertext link.

Specialized terms and acronyms are defined in the glossary at the end of this guide.

Compliance Statement

Overview

Introduction

This chapter introduces the Oracle Communications Convergent Charging Controller CAP version 3 GPRS Control Agent (CAP3GPRS Control Agent) compliance limitations and configuration.

In this chapter

This chapter contains the following topics.

About CAP3GPRS Compliance.....	1
CAP3GPRS Configuration for Message Sequences	2

About CAP3GPRS Compliance

Introduction to CAP3GPRS Compliance

This document states the compliance of the CAP3GPRS Control Agent against the following GPRS specific parts of the CAP 3 specification document, *ETSI TS 129 078 V4.8.0*:

- Section 8, GPRS Control
- Section 12, Services assumed from lower layers

The CAP3GPRS Control Agent translates between CAP 3 GPRS messages and CAP 3 INAP operations. For more information about the CAP3GPRS Control Agent and how to configure it, see *CAP3GPRS Control Agent Technical Guide*.

For information about specific parameters that directly affect message sequences, see *CAP3GPRS Configuration for Message Sequences* (on page 2).

The CAP3GPRS Control Agent produces message sequences for:

- Sessions. For more information and examples, see *Message Sequences for Sessions* (on page 5).
- PDP contexts. For more information and examples, see *Message Sequences with PDP Contexts* (on page 9).
- ActivityTestGPRS operations. For more information and examples, see *Message Sequences for ActivityTestGPRS* (on page 18).

For information about the operations supported by CAP3GPRS Control Agent and details of the individual parameters within these operations, see *Operations Supported by CAP3GPRS Control Agent* (on page 25).

For an explanation of how TCAP message dialogs are used in message sequences, see *TCAP Message Dialog Portion Parameters* (on page 1).

TCAP Message Dialog Portion Parameters

This section describes how the CAP3GPRS Control Agent complies with the following sections of the CAP 3 specification document, *ETSI TS 129 078 V4.8.0*:

- 12.1.1.3.7, Default mapping to TC dialogue parameters, User information
- 12.1.7, gprsSSF-gsmSCF interface

All the message sequences in this document relate to either a single charging session or to a PDP context within a charging session. Each message sequence for a session can be thought of as a conversation between the CAP3GPRS Control Agent and the SGSN that consists of several TCAP dialogs. The SGSN repeatedly ends one TCAP dialog, by sending an empty TCAP_END message, and then starts a new dialog for the same conversation by sending a TCAP_BEGIN message.

Note: The TCAP_BEGIN may come from a different SGSN if the subscriber has moved.

The CAP3GPRS Control Agent uses the destination reference parameter, in the **User Information** parameter in the transaction portion of each TCAP_BEGIN, to identify the conversation. The CAP3GPRS Control Agent correlates all the TCAP dialogs by using the following method:

- 1 The first TCAP_BEGIN in the message sequence contains the originating reference but no destination reference. The CAP3GPRS Control Agent uses the received originating reference as the destination reference in all TCAP messages it subsequently sends to the SGSN.
- 2 The CAP3GPRS Control Agent generates a correlation ID that it uses as the originating reference in all messages it subsequently sends to the SGSN.
- 3 The SGSN uses the correlation ID as the destination reference in all messages it sends to the CAP3GPRS Control Agent for this conversation.

CAP3GPRS Configuration for Message Sequences

Parameters that Affect Message Sequences

This table lists the CAP3GPRS Control Agent configuration parameters that directly affect the message content, and message sequences, that are sent and received by the control agent.

For more information about CAP3GPRS Control Agent configuration, see *CAP3GPRS Control Agent Technical Guide*.

Parameter Definition	Default Value	Description
<code>sendContinueWithApplyCharging = true false</code>	true	Sets whether to send ContinueGPRS operations in ApplyCharging message sequences.
<code>sendContinueWithRRGPRSE = true false</code>	true	Sets whether to send ContinueGPRS operations in RequestReportGPRSEvent message sequences.
<code>billingType = 0 1</code>	1	Sets whether to bill for time or volume. Where: <ul style="list-style-type: none"> • 0 – Bills for time • 1 – Bills for volume
<code>sessionTreatment = 1 2</code>	1	Sets how the control agent handles an InitialDPGPRS operation for a session. Where: <ul style="list-style-type: none"> • 1 – Sends ApplyCharging for the session duration and does not arm the PDP context • 2 – Sends ContinueGPRS to monitor individual PDP contexts
<code>armAllEdpsAtOnce = true false</code>	true	Sets whether to arm all EDPs in a single RequestReportGPRSEvent, or wait for ContextEstablishmentAcknowledgement before arming disconnect.
<code>maxInactiveTimeForVolume = int</code>	3600	(For volume billing) Sets the number of seconds to wait before sending ActivityTestGPRS.

Parameter Definition	Default Value	Description
<code>timeBillingInactiveTimeTolerance = int</code>	10	(For duration billing) Sets the number of seconds to add to the time from <code>ApplyCharging</code> when calculating the time to wait before sending <code>ActivitytestGPRS</code> .
<code>activityTestResultTimeout = int</code>	10	Sets the number of seconds to wait for an <code>ActivityTestGPRS</code> result.
<code>releaseCauseInsufficientFunds = int</code>	26	The cause value to send in <code>ReleaseGPRS</code> operations for calls released due to insufficient funds.
<code>releaseCauseNetworkError = int</code>	38	The cause value to send in <code>ReleaseGPRS</code> operations for calls released due to a network error, such as a timeout, or an incorrect message sequence.
<code>sendAbortForDetachEventType = true false</code>	false	Sends either <code>TCAP_ABORT</code> (when true), or <code>ContinueGPRS</code> (when false) in response to a detached GPRS event type in an <code>InitialDPGPRS</code> .
<code>sendAbortForDisconnectEventType = true false</code>	false	Sends either <code>TCAP_ABORT</code> (when true), or <code>ContinueGPRS</code> (when false) in response to a <code>disconnect</code> GPRS event type in an <code>InitialDPGPRS</code> .

GPRS Event Type Definition in InitialDPGPRS Operations

The CAP3GPRS Control Agent accepts all valid values of the ENUMERATED GPRS event type in `InitialDPGPRS` operations. The control agent rejects invalid event types in an `InitialDPGPRS` by logging an error and sending a TCAP abort.

The following syntax defines the valid ENUMERATED GPRS event types in `InitialDPGPRS` operations:

```
GPRSEventType ::= ENUMERATED {
    attach (1),
    attachChangeOfPosition (2),
    detached (3),
    pdp-ContextEstablishment (11),
    pdp-ContextEstablishmentAcknowledgement (12),
    disconnect (13),
    pdp-ContextChangeOfPosition (14)
}
```

The CAP3GPRS Control Agent:

- Treats `attach` (1) and `attachChangeOfPosition` (2) as the start of a new data session, and then:
 - Uses the `ApplyChargingGPRS` operation, if `sessionTreatment` is set to 1, to monitor the duration of the session for charging purposes. Otherwise the control agent ignores the session by sending `ContinueGPRS`.
 - Assumes that, if charging for separate PDP contexts is required, an `InitialDPGPRS` will be received for each PDP context so that each one can be charged separately. Therefore, when the control agent receives this type of event, it does not send a `RequestReportGPRSEvent` to arm for PDP context establishment.
- Recognizes that `pdp-ContextEstablishment` (11) and `pdp-ContextEstablishmentAcknowledgement` (12) and `pdp-ContextChangeOfPosition` (14) are relevant to particular PDP contexts. You can configure the control agent to monitor these contexts for charging purposes.

Chapter 1

- Responds to `detached (3)` and `disconnect (13)` event types by sending either a TCAP abort or a ContinueGPRS. You can configure which message to send in the `sendAbortForDetachEventType` and `sendAbortForDisconnectEventType` parameters. For details, see *Parameters that Affect Message Sequences* (on page 2). The control agent will also log an error if it sends a TCAP abort.

CAP3GPRS Message Sequences

Overview

Introduction

This chapter describes the message sequences that can be produced by the Oracle Communications Convergent Charging Controller CAP version 3 GPRS Control Agent (CAP3GPRS Control Agent), and provides example message flows.

In this chapter

This chapter contains the following topics.

Message Sequences for Sessions	5
Message Sequences with PDP Contexts	9
Message Sequences for ActivityTestGPRS	18

Message Sequences for Sessions

Introduction to Message Sequences for Sessions

The CAP3GPRS Control Agent can produce the message sequences for sessions as described in the following sections:

- *Continue GPRS Session Message Sequence* (on page 5)
- *Successful Session Charging Message Sequence* (on page 6)
- *Subscriber Disconnects Session Message Sequence* (on page 7)
- *Service Denied Session Message Sequence* (on page 8)
- *Terminate Session Message Sequence* (on page 8)

About Sending ContinueGPRS in Messages

If `sendContinueWithRRGPRSE` is set to `true` then the control agent sends ContinueGPRS in the message sequences for:

- Successful session charging
- Subscriber disconnects session
- Terminate session

The same message sequence is produced when `sendContinueWithRRGPRSE` is set to `false`, except that the control agent does not send a ContinueGPRS operation.

ContinueGPRS Session Message Sequence

The CAP3GPRS Control Agent sends the ContinueGPRS operation in response to an InitialDPGPRS for a session where:

- The `gprsEventType` is set to either `attach` or `attachChangeOfPosition`.

Chapter 2

- The `sessionTreatment` parameter for the CAP3GPRS Control Agent is set to 2 (send ContinueGPRS operation).

ContinueGPRS Session Example

This example shows a ContinueGPRS session message flow where `gprsEventType` is set to `attach`:

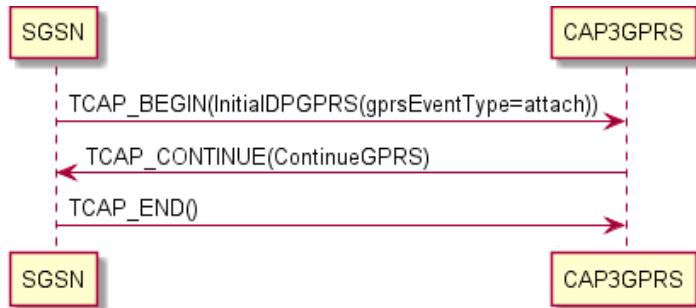

Successful Session Charging Message Sequence

The CAP3GPRS Control Agent supports message sequences for successful charging for the duration of a session where:

- The `gprsEventType` is either set to `attach` or `attachChangeOfPosition`.
- The `sessionTreatment` parameter for the CAP3GPRS Control Agent is set to 1 (send ApplyCharging operation).

Session Charging Successful Example

This example shows a session charging successful message flow where `gprsEventType` is set to `attach`.

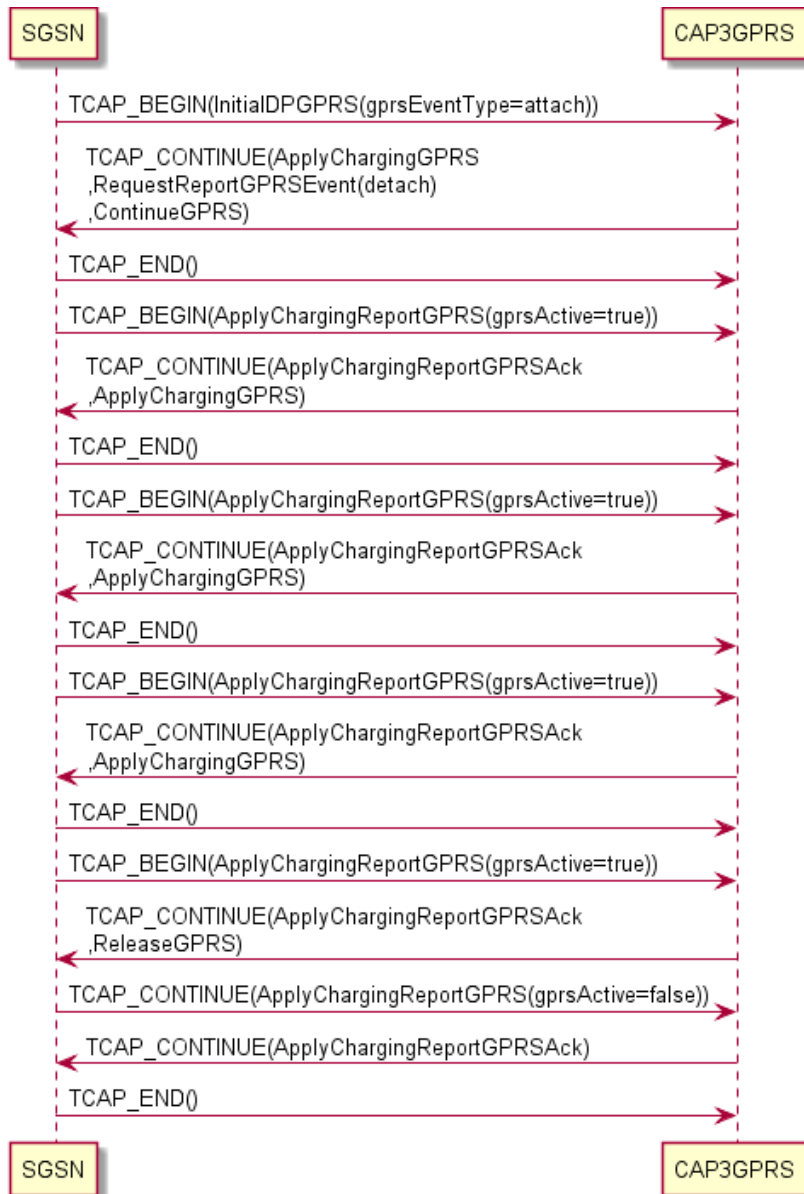

Subscriber Disconnects Session Message Sequence

The CAP3GPRS Control Agent supports message sequences for a subscriber disconnects session where:

- The `gprsEventType` is either set to `attach` or `attachChangeOfPosition`.
- The `sessionTreatment` parameter for the CAP3GPRS Control Agent is set to 1 (send ApplyCharging operation).

Disconnect Session Example

This example shows a subscriber disconnects session message flow where `gprsEventType` is set to `attach`.

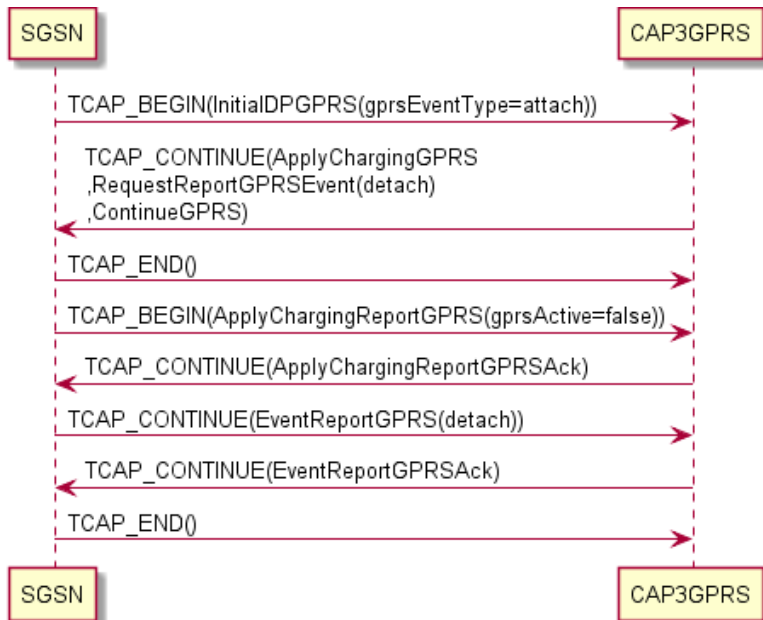

Service Denied Session Message Sequence

The CAP3GPRS Control Agent supports service denied for a subscriber message sequences where:

- The `gprsEventType` is set to either `attach` or `attachChangeOfPosition`.
- The `sessionTreatment` parameter for the CAP3GPRS Control Agent is set to 1 (send `ApplyCharging` operation).

For example, the control agent produces a service denied message sequence if the subscriber has no funds, or if the subscriber's MSISDN is not recognized.

Service Denied Session Example

This example shows a service denied message flow where `gprsEventType` is set to `attach`.

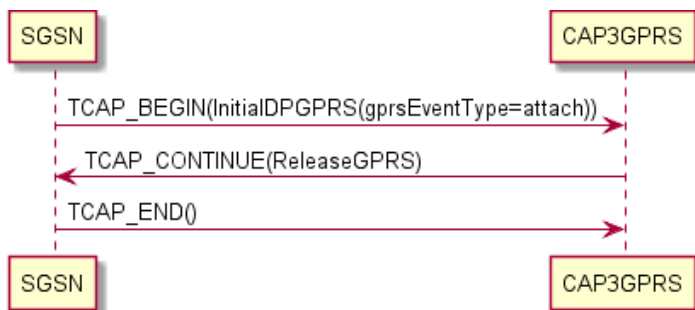

Terminate Session Message Sequence

The CAP3GPRS Control Agent supports terminate session message sequences where:

- The `gprsEventType` is set to either `attach` or `attachChangeOfPosition`.
- The `sessionTreatment` parameter for the CAP3GPRS Control Agent is set to 1 (send `ApplyCharging` operation).

For example, the control agent produces the terminate session message sequence if the subscriber runs out of funds in the middle of a session.

Terminate Session Example

This example shows a terminate session message flow for a subscriber who runs out of funds during the session, and where `gprsEventType` is set to `attach`.

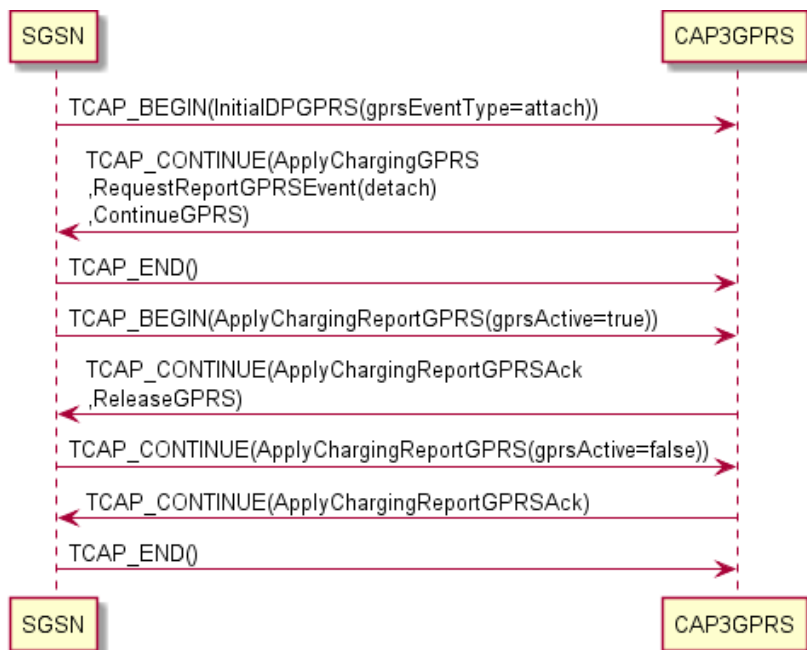

Message Sequences with PDP Contexts

Introduction to Message Sequences with PDP Context

The CAP3GPRS Control Agent can support message sequences, where each message sequence relates to a single PDP context within a session, as described in the following sections:

- *ContextEstablishmentAcknowledgement Message Sequence* (on page 10)
- *ContextEstablishment with Successful Charging Message Sequence* (on page 11)
- *Subscriber Disconnects Session (ContextEstablishment) Message Sequence* (on page 12)
- *Service Denied (ContextEstablishment) Message Sequence* (on page 13)
- *Session Terminated (ContextEstablishment) Message Sequence* (on page 14)
- *ConnectGPRS (ContextEstablishment) Message Sequence* (on page 14)
- *EntityReleased (ContextEstablishment) Message Sequence* (on page 15)
- *SCI and FCI Message Sequences* (on page 15)

Important: For all message sequences in this section, except context establishment acknowledgement with successful charging, the `InitialDPGPRS` is for `ContextEstablishment` and therefore the CAP3GPRS Control Agent must explicitly arm the `ContextEstablishmentAcknowledgement` event detection point.

About Sending ContinueGPRS in Messages

The following configuration determines whether or not the control agent sends `ContinueGPRS` in messages containing `RequestReportGPRSEvent` and `ApplyChargingGPRS` operations:

Chapter 2

- If `sendContinueWithRRGPRSE = true` then the control agent sends a ContinueGPRS in the message containing the RequestReportGPRSEvent; otherwise it does not send ContinueGPRS in the message.
- If `sendContinueWithApplyCharging = true` then the control agent sends a ContinueGPRS in the message containing the first ApplyChargingGPRS; otherwise it does not send ContinueGPRS in the message.

Note: When these parameters are set to `false`, the message sequences that the control agent produces are the same, except that the control agent does not send a ContinueGPRS operation.

ContextEstablishmentAcknowledgement Message Sequence

The CAP3GPRS Control Agent supports message sequences for ContextEstablishmentAcknowledgement with successful charging.

Context Establishment Acknowledgement Example

This example shows a ContextEstablishmentAcknowledgement with successful charging message flow, where `sendContinueWithRRGPRSE` is set to `true`.



ContextEstablishment with Successful Charging Message Sequence

The CAP3GPRS Control Agent supports message sequences for ContextEstablishment with successful charging.

Note: Because the InitialDPGPRS is for contextEstablishment, the CAP3GPRS Control Agent explicitly arms the contextEstablishmentAcknowledgement event detection point.

ContextEstablishment with Successful Charging Example

This example shows a ContextEstablishment with successful charging message flow where:

- `sendContinueWithRRGPRSE` is set to `true`
- `sendContinueWithApplyCharging` is set to `true`



Subscriber Disconnects Session (ContextEstablishment) Message Sequence

The CAP3GPRS Control Agent supports ContextEstablishment message sequences for subscriber disconnects sessions.

Note: Because the InitialDPGPRS is for ContextEstablishment, the CAP3GPRS Control Agent explicitly arms the ContextEstablishmentAcknowledgement event detection point.

Subscriber Disconnects Session (ContextEstablishment) Example

This example shows a ContextEstablishment message flow for subscriber disconnects session where:

- `sendContinueWithRRGPRSE` is set to `true`
- `sendContinueWithApplyCharging` is set to `true`



Service Denied (ContextEstablishment) Message Sequence

The CAP3GPRS Control Agent supports service denied for subscriber ContextEstablishment message sequences. For example, the control agent produces a service denied message sequence if the subscriber has no funds, or if the subscriber's MSISDN is not recognized.

Service Denied (ContextEstablishment) Example

This example shows a ContextEstablishment message flow for subscriber denied service.



Session Terminated (ContextEstablishment) Message Sequence

The CAP3GPRS Control Agent supports ContextEstablishment message sequences for session terminated service because the subscriber's funds have expired.

Note: Because the InitialDPGPRS is for ContextEstablishment, the CAP3GPRS Control Agent explicitly arms the ContextEstablishmentAcknowledgement event detection point.

Session Terminated (ContextEstablishment) Example

This example shows a ContextEstablishment message flow for session terminated because the subscriber's funds have expired, where:

- `sendContinueWithRRGPRSE` is set to `true`
- `sendContinueWithApplyCharging` is set to `true`

Note: The CAP3GPRS Control Agent:

- Produces the same message sequence when these parameters are set to false, except it does not send a ContinueGPRS in messages.
- Only sends ConnectGPRS if the event type in InitialDPGPRS is ContextEstablishment.



ConnectGPRS (ContextEstablishment) Message Sequence

The CAP3GPRS Control Agent supports ContextEstablishment ConnectGPRS message sequences.

ConnectGPRS (ContextEstablishment) Example

This example shows a ConnectGPRS ContextEstablishment message flow.

Note: The service logic used in this example assumes that no charging is required, and that the ConnectGPRS operation tells the SGSN to connect to a new access point.

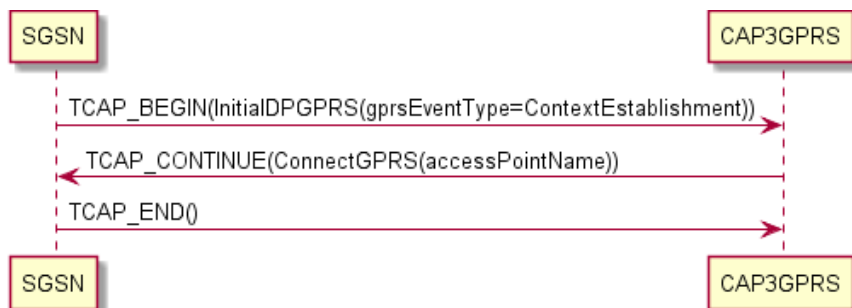

EntityReleased (ContextEstablishment) Messages

The CAP3GPRS Control Agent supports EntityReleased ContextEstablishment message sequences.

Note: Because the InitialDPGPRS is for ContextEstablishment, the CAP3GPRS Control Agent explicitly arms the ContextEstablishmentAcknowledgement event detection point.

EntityReleased (ContextEstablishment) Example

This diagram shows how the CAP3GPRS Control Agent handles EntityReleasedGPRS operations in an example ConnectGPRS ContextEstablishment message flow.

In the example message flow, `sendContinueWithRRGPRSE` is set to `true`.

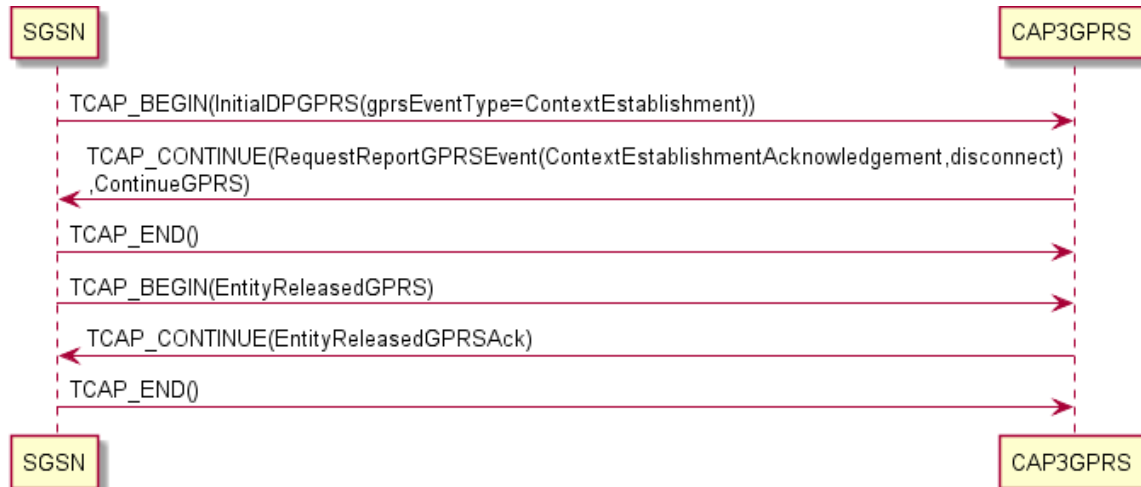

SCI and FCI Message Sequences

The CAP3GPRS Control Agent can send message sequences for SendChargingInformationGPRS (SCI) and FurnishChargingInformationGPRS (FCI) for any InitialDPGPRS event type (including ContextEstablishment) that it supports. You can send:

- Only one of the operations.
- Both operations.
- Neither operation.

Chapter 2

You can configure whether the CAP3GPRS Control Agent sends SCI and FCI data, for example, by including a Set Tariff Code feature node in the control plan, or by using a Convergent Charging Controller Software Developer Kit customized plugin.

For more information about the Set Tariff Code feature node, see *Feature Nodes Reference Guide*. For more information about configuring control plans, see *CPE User's Guide*.

For more information about Convergent Charging Controller Software Developer Kit (SDK), see *SDK Developer's Guide*.

SCI and FCI (ContextEstablishment) Example

In this example ContextEstablishment message flow, the CAP3GPRS Control Agent sends both SendChargingInformationGPRS and FurnishChargingInformationGPRS. The control agent always sends SendChargingInformationGPRS first.

In this example, the following configuration has been set for the control agent:

- `sendContinueWithRRGPRSE` is set to `true`
- `sendContinueWithApplyCharging` is set to `true`

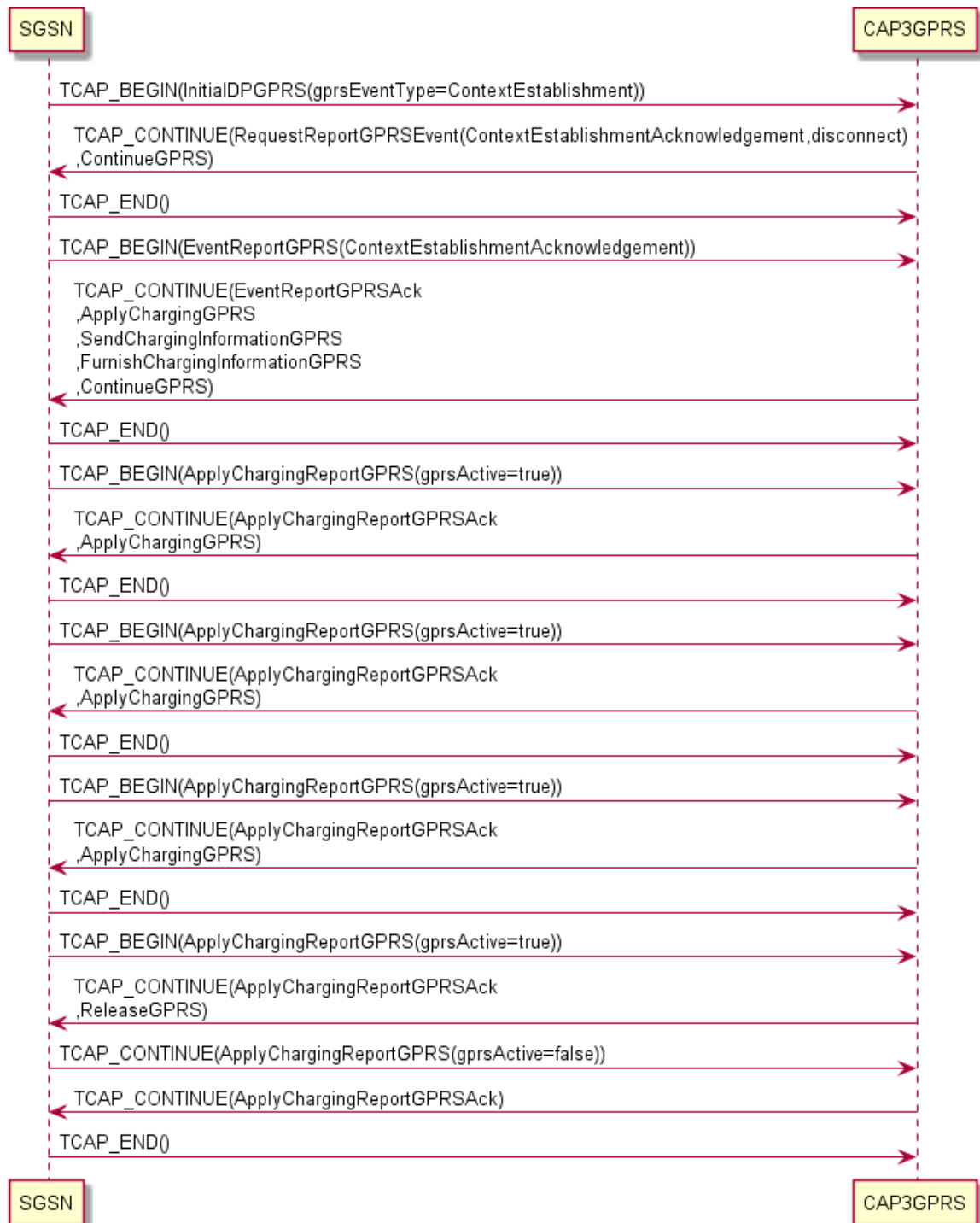

Message Sequences for ActivityTestGPRS

Introduction to Message Sequences for ActivityTestGPRS

The CAP3GPRS Control Agent supports ActivityTestGPRS message sequences. The control agent produces different ActivityTestGPRS message sequences depending on whether charging is for volume or for duration. The event type in InitialDPGPRS does not affect ActivityTestGPRS message sequences.

For volume charging, the CAP3GPRS Control Agent sends an ActivityTestGPRS operation after a period of activity to check that the session is still alive. If:

- The session is still alive, charging continues.
- The session does not exist, charging is finalized and resources used for this session are cleaned up.

For duration charging, if the SGSN does not respond within a set timeframe (that is, the time set in ApplyChargingGPRS plus the value of timeBillingInactiveTimeTolerance), then an error has occurred. In this case, ActivityTestGPRS is used to establish whether a session still exists, and end the session if it does, before finalizing charging and cleaning up.

Volume Charging, Session Still Exists Example

This example shows the ActivityTestGPRS message flow when charging for volume and the session still exists.

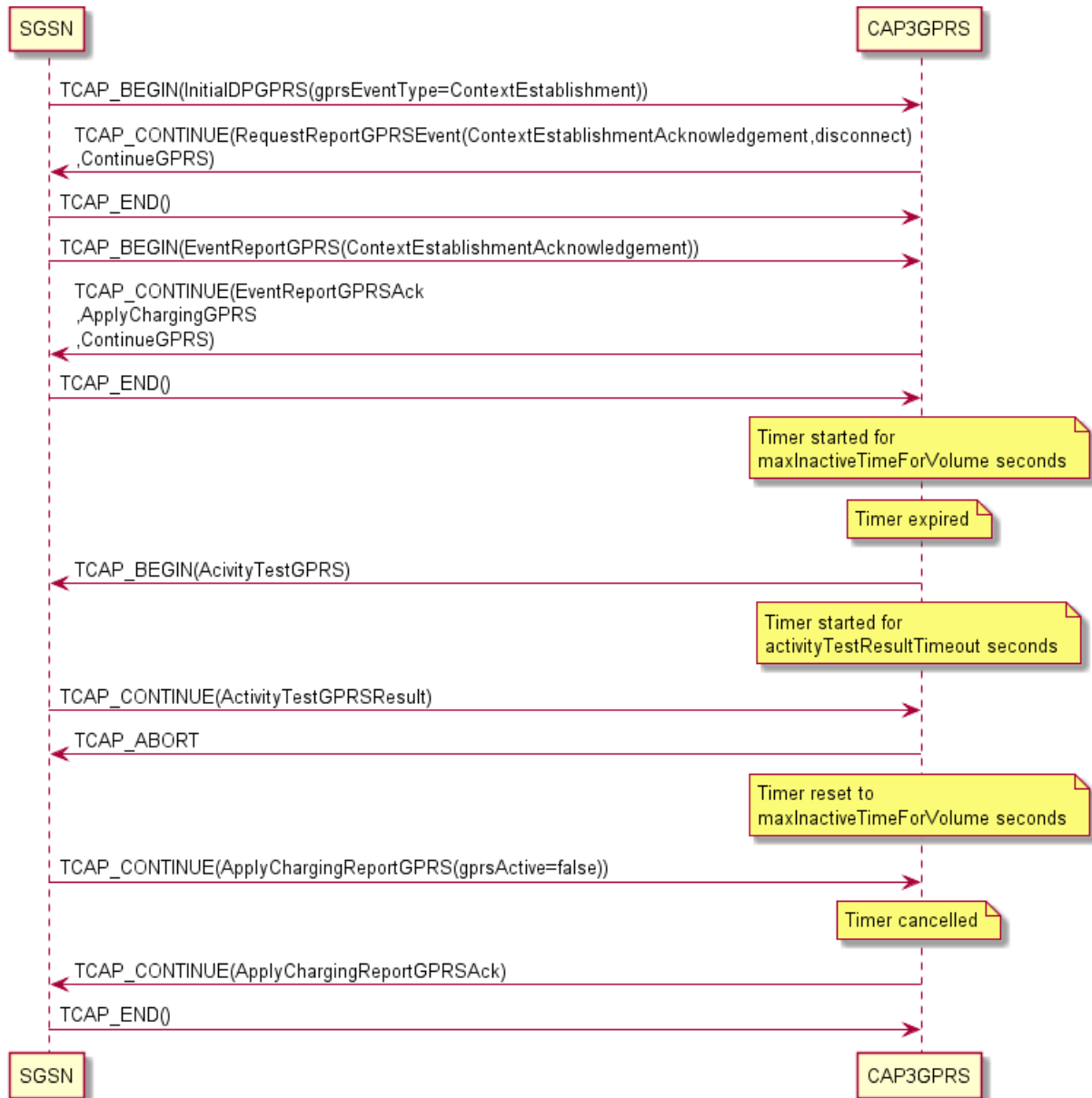

Volume Charging, Session Timeout Example

This example shows the ActivityTestGPRS message flow when charging for volume and the session times out.

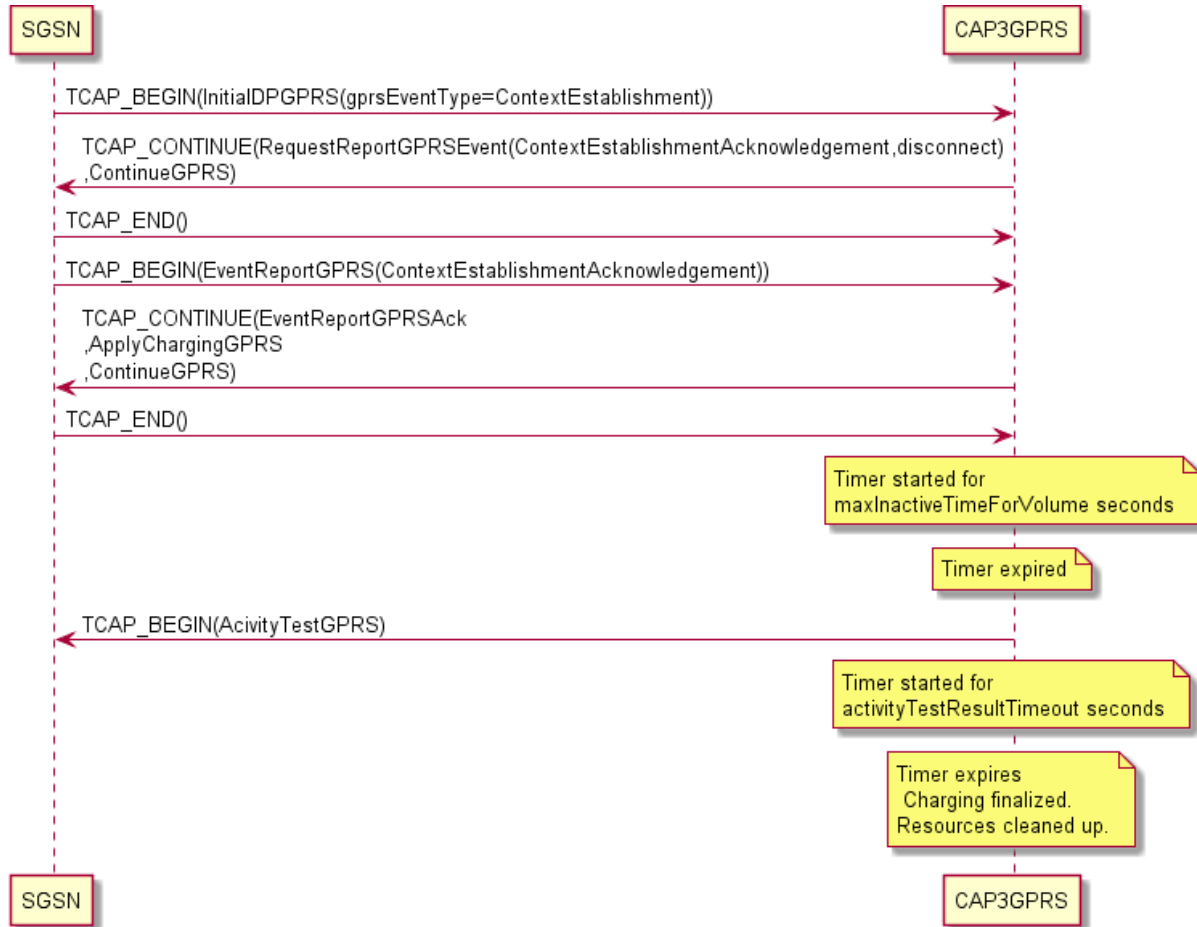

Volume Charging, Error Returned Example

This example shows the ActivityTestGPRS message flow when charging for volume and an error is returned.

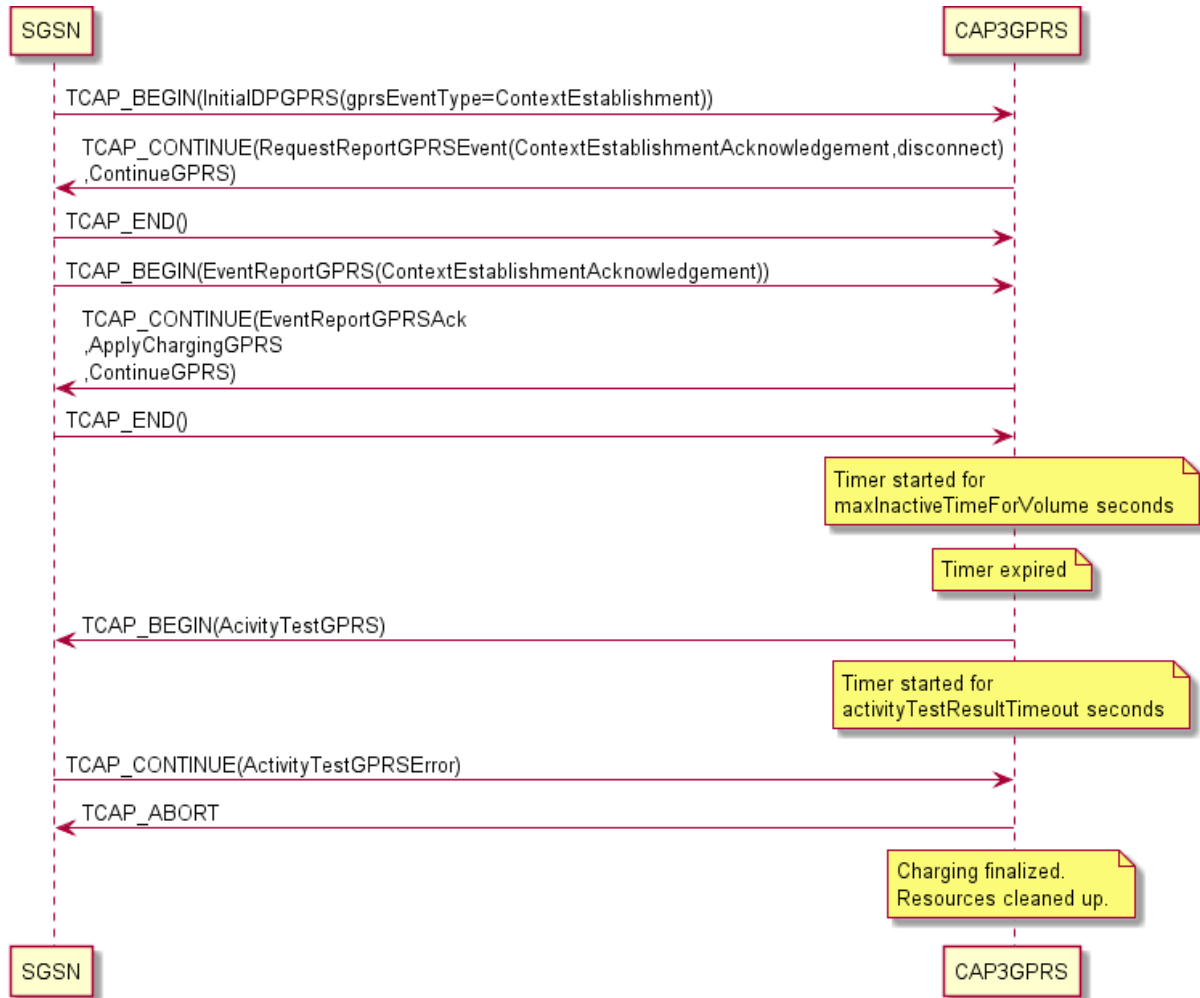

Duration Charging, Session Still Exists Example

This example shows the ActivityTestGPRS message flow when charging for duration and the session still exists.

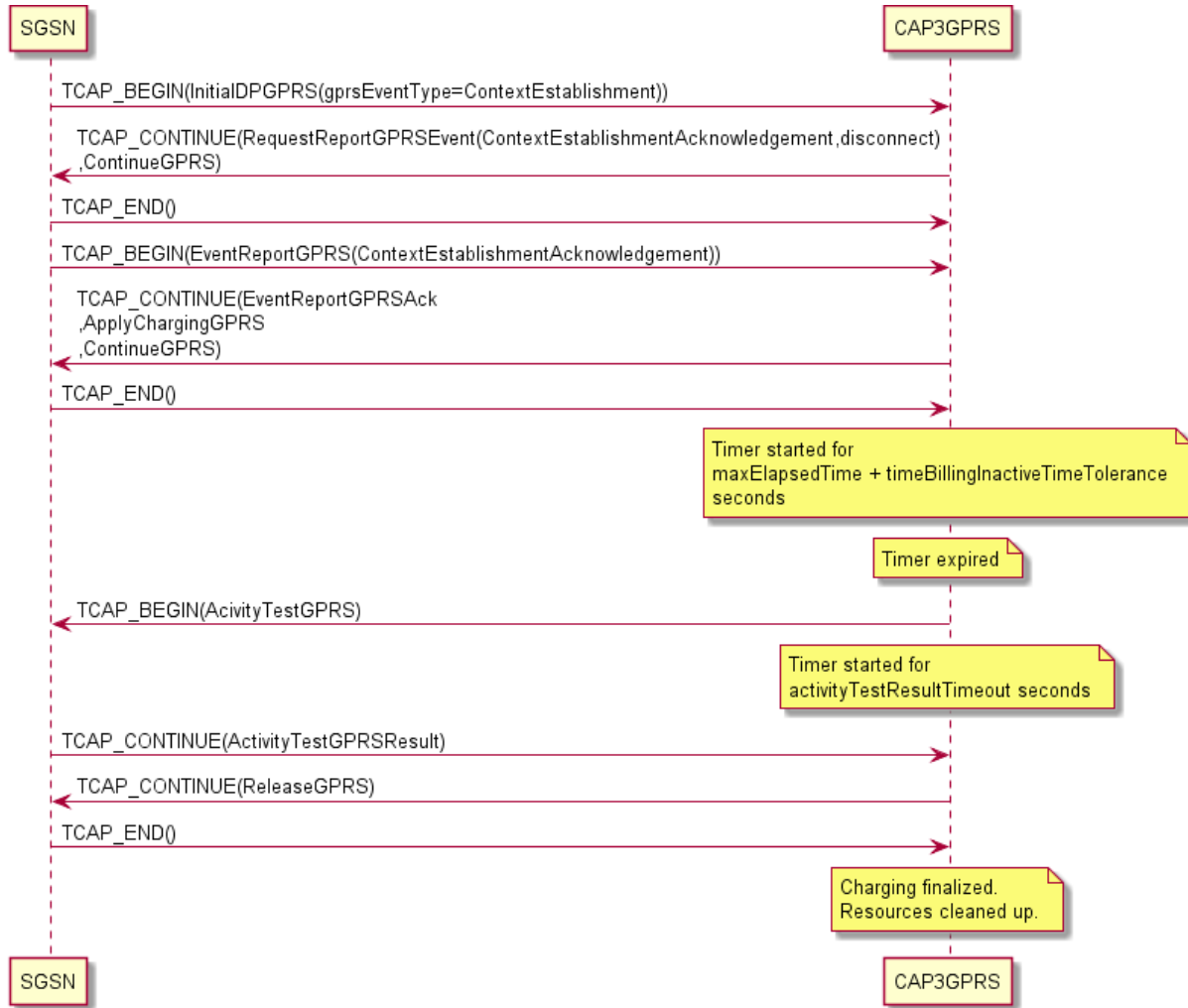

Duration Charging, Session Timeout Example

This example shows the ActivityTestGPRS message flow when charging for duration and the session times out.

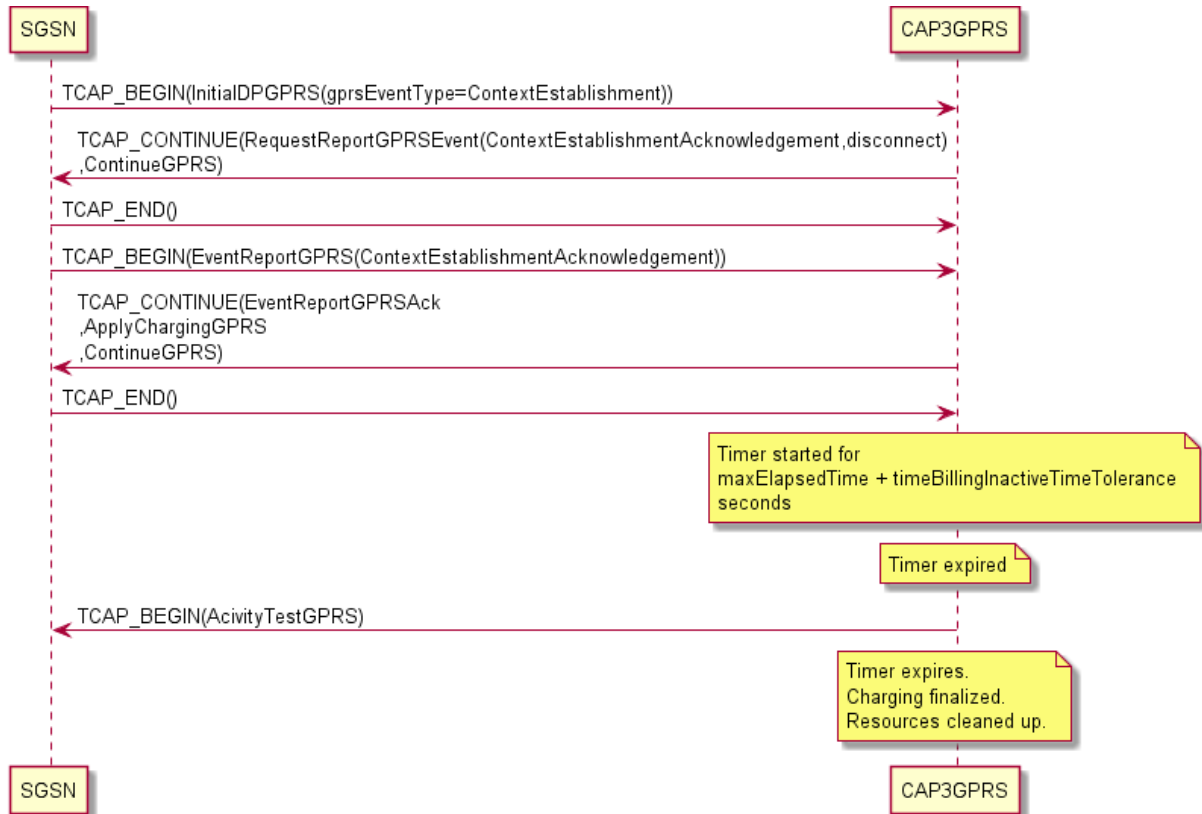

Duration Charging, Error Returned Example

This example shows the ActivityTestGPRS message flow when charging for duration and an error is returned.

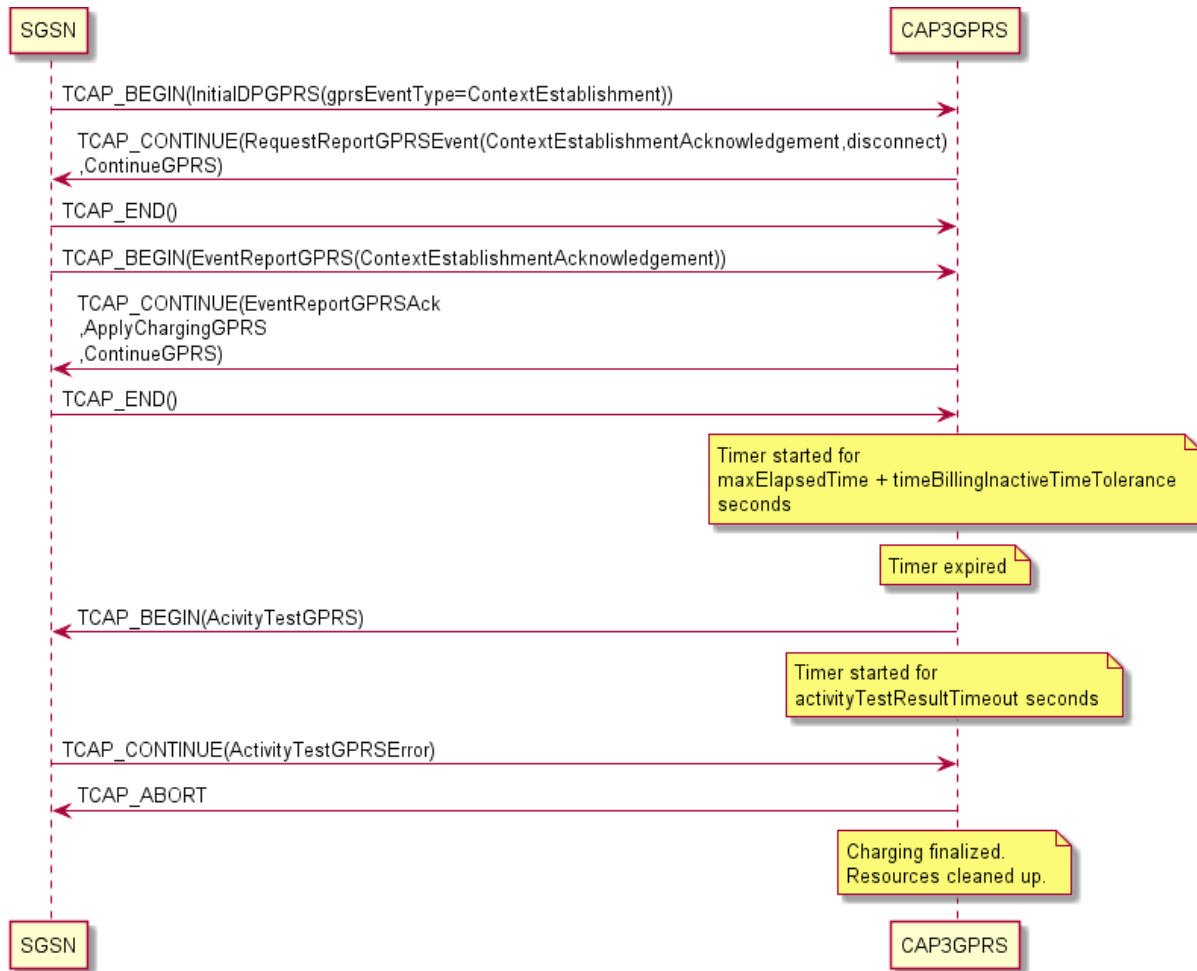

Operations Supported by CAP3GPRS Control Agent

Overview

Introduction

This chapter lists the operations supported by the Oracle Communications Convergent Charging Controller CAP version 3 GPRS Control Agent (CAP3GPRS Control Agent), and provides details about the supported parameters for each operation.

In this chapter

This chapter contains the following topics.

Operations Sent from SGSN to the Control Agent.....	25
Operations Sent to SGSN from the Control Agent.....	28

Operations Sent from SGSN to the Control Agent

About Operations Sent from SGSN

This section lists the supported operations that may be sent from the SGSN to the CAP3GPRS Control Agent, and provides details about the supported parameters for each operation. For example operations, see *CAP3GPRS Message Sequences* (on page 5).

The following operations are the only operations sent from the SGSN that may be received by the CAP3GPRS Control Agent:

- *ApplyChargingReportGPRS Operation* (on page 25)
- *EntityReleasedGPRS Operation* (on page 26)
- *InitialDPGPRS Operation* (on page 26)
- *EventReportGPRS Operation* (on page 28)

Note: The CAP3GPRS Control Agent:

- Replies with TCAP_ABORT if it receives an unsupported operation from the SGSN.
- Ignores any unsupported parameters in operations sent by the SGSN.

ApplyChargingReportGPRS Operation

This section describes how the CAP3GPRS Control Agent complies with the following sections of the CAP 3 specification document, *ETSI TS 129 078 V4.8.0*:

- 8.1, gsmSCF/gprsSSF operations and arguments
- 11.6, ApplyChargingReportGPRS procedure

This table lists the parameters used in ApplyChargingReportGPRS operations, and identifies the parameters that are supported by the CAP3GPRS Control Agent.

Parameter	Supported	Notes
chargingResult	Supported	Reports used time, or used volume, to the billing engine.
qualityOfService	Supported	Defines the <code>qualityOfService</code> parameters that you can use as a basis for making decisions in the control plan service logic.
active	Supported	Indicates whether the GPRS session or PDP context is still active. Used in charging scenarios.
pDPID	Not supported	Not relevant, because the CAP3GPRS Control Agent does not send RequestReportGPRSEvent operations to arm for PDP context establishment.
chargingRollOver	Supported	You can base decisions in the control plan service logic on the value of <code>chargingRollOver</code> . Based on this parameter, the control agent calculates: <ul style="list-style-type: none"> For time rollover, a period of time to be used by the billing engine that is greater than one day. For volume rollover, a 64-bit volume to be used if the billing engine supports 64-bit volumes.

EntityReleasedGPRS Operation

This section describes how the CAP3GPRS Control Agent complies with the following sections of the CAP 3 specification document, *ETSI TS 129 078 V4.8.0*:

- 8.1, gsmSCF/gprsSSF operations and arguments
- 11.22, EntityReleasedGPRS procedure

This table lists the parameters used in EntityReleasedGPRS operations, and identifies the parameters that are supported by the CAP3GPRS Control Agent.

Parameter	Supported	Notes
gPRSCause	Supported	You can base decisions in the control plan service logic on the value of <code>gPRSCause</code> .
pDPID	Not supported	NA

InitialDPGPRS Operation

This section describes how the CAP3GPRS Control Agent complies with the following sections of the CAP 3 specification document, *ETSI TS 129 078 V4.8.0*:

- 8.1, gsmSCF/gprsSSF operations and arguments
- 11.31, InitialDPGPRS procedure

This table lists the parameters used in InitialDPGPRS operations, and identifies the parameters that are supported by the CAP3GPRS Control Agent.

Parameter	Supported	Notes
serviceKey	Supported	Determines the control plan used. You can base decisions in the control plan service logic on the value of <code>serviceKey</code> .
gPRSEventType	Supported	Defines the GPRS event type. The control agent supports the following event types: <ul style="list-style-type: none"> • <code>attach</code> (1) • <code>attachChangeOfPosition</code> (2) • <code>detached</code> (3) • <code>pdp-ContextEstablishment</code> (11) • <code>pdp-ContextEstablishmentAcknowledgement</code> (12) • <code>disconnect</code> (13) • <code>pdp-ContextChangeOfPosition</code> (14) For more information, see <i>GPRS Event Type Definition in InitialDPGPRS Operations</i> (on page 3).
mSISDN	Supported	May be used to select the subscriber to charge, and also to influence the amount charged. You can base decisions in the control plan service logic on the value of <code>mSISDN</code> .
iMSI	Supported	May be used to select the subscriber to charge. You can base decisions in the control plan service logic on the value of <code>iMSI</code> .
timeAndTimeZone	Not Supported	NA
gPRSMSCClass	Not Supported	NA
endUserAddresses	Not Supported	NA
qualityOfService	Supported	Defines the individual <code>qualityOfService</code> parameters that are available. You can base decisions in the control plan service logic on the value of these parameters.
accessPointName	Supported	You can base decisions in the control plan service logic on the value of <code>accessPointName</code> .
routingAreaIdentity	Supported	You can base decisions in the control plan service logic on the value of <code>routingAreaIdentity</code> .
chargingID	Supported	You can base decisions in the control plan service logic on the value of <code>chargingID</code> .
sGSNCapabilities	Supported	You can base decisions in the control plan service logic on the value of <code>sGSNCapabilities</code> .
locationInformationGPRS	Supported	Defines the individual <code>locationInformationGPRS</code> parameters that are available. You can base decisions in the control plan service logic on these parameters.
pDPInitiationType	Supported	You can base decisions in the control plan service logic on the value of <code>pDPInitiationType</code> .
extensions	Not supported	NA

Parameter	Supported	Notes
gGSNAddress	Supported	You can base decisions in the control plan service logic on the value of gGSNAddress.
secondaryPDP-context	Supported	You can base decisions in the control plan service logic on the value of secondaryPDP-context.
iMEI	Not supported	NA

EventReportGPRS Operation

This section describes how the CAP3GPRS Control Agent complies with the following sections of the CAP 3 specification document, *ETSI TS 129 078 V4.8.0*:

- 8.1, gsmSCF/gprsSSF operations and arguments
- 11.25, EventReportGPRS procedure

This table lists the parameters used in EventReportGPRS operations, and identifies the parameters that are supported by the CAP3GPRS Control Agent.

Parameter	Supported	Notes
gPRSEventType	Supported	Defines the GPRS event type. For examples of how gPRSEventType is used, see <i>CAP3GPRS Message Sequences</i> (on page 5).
miscGPRSInfo	Not supported	NA
gPRSEventSpecificInformation	Not supported	NA
pDPID	Not supported	NA

Operations Sent to SGSN from the Control Agent

About Operations Sent to SGSN

This section lists the operations that the CAP3GPRS Control Agent may send to the SGSN, and provides details about the parameters that are supported for each operation. For example operations, see *CAP3GPRS Message Sequences* (on page 5).

The following operations are the only operations that the CAP3GPRS Control Agent sends to the SGSN:

- *ActivityTestGPRS Operation* (on page 29)
- *ApplyChargingGPRS Operation* (on page 29)
- *ConnectGPRS Operation* (on page 29)
- *ContinueGPRS Operation* (on page 29)
- *ReleaseGPRS Operation* (on page 30)
- *RequestReportGPRSEvent Operation* (on page 30)
- *FurnishChargingInformationGPRS Operation* (on page 30)
- *SendChargingInformationGPRS Operation* (on page 31)

Note: Only supported parameters are included in the operations that the CAP3GPRS Control Agent sends.

ActivityTestGPRS Operation

This section describes how the CAP3GPRS Control Agent complies with the following sections of the CAP 3 specification document, *ETSI TS 129 078 V4.8.0*:

- 8.1, gsmSCF/gprsSSF operations and arguments
- 11.2, ActivityTestGPRS procedure

There are no parameters for the ActivityTestGPRS operation.

ApplyChargingGPRS Operation

This section describes how the CAP3GPRS Control Agent complies with the following sections of the CAP 3 specification document, *ETSI TS 129 078 V4.8.0*:

- 8.1, gsmSCF/gprsSSF operations and arguments
- 11.4, ApplyChargingGPRS procedure

This table lists the parameters used in ApplyChargingGPRS operations, and identifies the parameters that are supported by the CAP3GPRS Control Agent.

Parameter	Supported	Notes
chargingCharacteristics	Supported	Enables either billing by time, or billing by volume.
tariffSwitchInterval	Not supported	NA
pDPID	Not supported	NA

ConnectGPRS Operation

This section describes how the CAP3GPRS Control Agent complies with the following sections of the CAP 3 specification document, *ETSI TS 129 078 V4.8.0*:

- 8.1, gsmSCF/gprsSSF operations and arguments
- 11.14, ConnectGPRS procedure

This table lists parameters used in ConnectGPRS operations, and identifies the parameters that are supported by the CAP3GPRS Control Agent.

Parameter	Supported	Notes
accessPointName	Supported	Defines the Access Point Name for the PDP context.
pDPID	Not supported	NA

ContinueGPRS Operation

This section describes how the CAP3GPRS Control Agent complies with the following sections of the CAP 3 specification document, *ETSI TS 129 078 V4.8.0*:

- 8.1, gsmSCF/gprsSSF operations and arguments
- 11.18, ContinueGPRS procedure

This table lists the parameter used in ContinueGPRS operations. The parameter is not supported by the CAP3GPRS Control Agent.

Parameter	Supported	Notes
pDPID	Not supported	NA

ReleaseGPRS Operation

This section describes how the CAP3GPRS Control Agent complies with the following sections of the CAP 3 specification document, *ETSI TS 129 078 V4.8.0*:

- 8.1, gsmSCF/gprsSSF operations and arguments
- 11.36, ReleaseGPRS procedure

This table lists the parameters used in ReleaseGPRS operations, and identifies the parameters that are supported by the CAP3GPRS Control Agent.

Parameter	Supported	Notes
gPRSCause	Supported	<p>You configure the release cause values that trigger the CAP3GPRS Control Agent to send ReleaseGPRS in the following locations:</p> <ul style="list-style-type: none"> • In the control plan service logic, you configure the cause value for each circumstance that will trigger ReleaseGPRS. • In the CAP3GPRS section of the <code>eserv.config</code> file, you configure the cause value that will trigger ReleaseGPRS for a timeout or an invalid message sequence, and for the expiration of funds. <p>For more information about CAP3GPRS configuration, see <i>CAP3GPRS Control Agent Technical Guide</i>.</p>
pDPID	Not supported	NA

RequestReportGPRSEvent Operation

This section describes how the CAP3GPRS Control Agent complies with the following sections of the CAP 3 specification document, *ETSI TS 129 078 V4.8.0*:

- 8.1, gsmSCF/gprsSSF operations and arguments
- 11.39, RequestReportGPRS procedure

This table lists the parameters used in RequestReportGPRSEvent operations, and identifies the parameters that are supported by the CAP3GPRS Control Agent.

Parameter	Supported	Notes
gPRSEvent	Supported	Defines the GPRS event in RequestReportGPRSEvent operations.
pDPID	Not supported	NA

FurnishChargingInformationGPRS Operation

This section describes how the CAP3GPRS Control Agent complies with the following sections of the CAP 3 specification document, *ETSI TS 129 078 V4.8.0*:

- 8.1, gsmSCF/gprsSSF operations and arguments
- 11.28, FurnishChargingInformationGPRS procedure

This table lists the parameters used in FurnishChargingInformationGPRS operations, and identifies the parameters that are supported by the CAP3GPRS Control Agent.

Parameter	Supported	Notes
fCIGPRSBillingChargingCharacteristics	Supported	<p>See CAP 3 specification document, <i>ETSI TS 129 078 V4.8.0</i>, for details of the format and contents of this parameter.</p> <p>The CAP3GPRS Control Agent provides only the following support for this parameter:</p> <ul style="list-style-type: none"> • You may specify a static string of hex digits in the control plan data to represent the whole parameter. <p>Note: Customization, by using the Convergent Charging Controller Software Developer Kit, would be required to support dynamic data in this parameter.</p>

SendChargingInformationGPRS Operation

This section describes how the CAP3GPRS Control Agent complies with the following sections of the CAP 3 specification document, *ETSI TS 129 078 V4.8.0*:

- 8.1, gsmSCF/gprsSSF operations and arguments
- 11.45, SendChargingInformationGPRS procedure

This table lists the parameters used in SendChargingInformationGPRS operations, and identifies the parameters that are supported by the CAP3GPRS Control Agent.

Parameter	Supported	Notes
sCIGPRSBillingChargingCharacteristics	Supported	<p>See CAP 3 specification document, <i>ETSI TS 129 078 V4.8.0</i>, for details of the format and contents of this parameter.</p> <p>The CAP3GPRS Control Agent provides only the following support for this parameter:</p> <ul style="list-style-type: none"> • You may specify a static string of hex digits in the control plan data to represent the whole parameter. <p>Note: Customization, by using the Convergent Charging Controller Software Developer Kit, would be required to support dynamic data in this parameter.</p>

Glossary of Terms

ACS

Advanced Control Services configuration platform.

CAMEL

Customized Applications for Mobile network Enhanced Logic

This is a 3GPP (Third Generation Partnership Project) initiative to extend traditional IN services found in fixed networks into mobile networks. The architecture is similar to that of traditional IN, in that the control functions and switching functions are remote. Unlike the fixed IN environment, in mobile networks the subscriber may roam into another PLMN (Public Land Mobile Network), consequently the controlling function must interact with a switching function in a foreign network. CAMEL specifies the agreed information flows that may be passed between these networks.

CAP

CAMEL Application Part

CC

Country Code. Prefix identifying the country for a numeric international address.

CCS

- 1) Charging Control Services component.
- 2) Common Channel Signalling. A signalling system used in telephone networks that separates signalling information from user data.

Convergent

Also "convergent billing". Describes the scenario where post-paid and pre-paid calls are handed by the same service platform and the same billing system. Under strict converged billing, post-paid subscribers are essentially treated as "limited credit pre-paid".

CPE

Control Plan Editor (previously Call Plan Editor) - software used to define the logic and data associated with a call -for example, "if the subscriber calls 0800 *nnnnnn* from a phone at location *xxx* then put the call through to *bb bbb bbbb*".

ETSI

European Telecommunications Standards Institute

FCI

Furnish Charging Information. An INAP operation sent from ACS to the SSP to control the contents of EDRs produced by the SSP.

GPRS

General Packet Radio Service - employed to connect mobile cellular users to PDN (Public Data Network- for example the Internet).

IN

Intelligent Network

INAP

Intelligent Network Application Part - a protocol offering real time communication between IN elements.

ISDN

Integrated Services Digital Network - set of protocols for connecting ISDN stations.

MSISDN

Mobile Station ISDN number. Uniquely defines the mobile station as an ISDN terminal. It consists of three parts; the country code (CC), the national destination code (NDC) and the subscriber number (SN).

PLMN

Public Land Mobile Network

SCI

Send Charging Information. An INAP operation sent from ACS to the SSP to control real time charging by the SSP.

SGSN

Serving GPRS Support Node

SLEE

Service Logic Execution Environment

SMS

Depending on context, can be:

- Service Management System hardware platform
- Short Message Service
- Service Management System platform
- Convergent Charging Controller Service Management System application

SN

Service Number

SSP

Service Switching Point

Switching Point

Anything that can send and receive C7 messages.

TCAP

Transaction Capabilities Application Part – layer in protocol stack, message protocol.

Index

A

About CAP3GPRS Compliance • 1
About Operations Sent from SGSN • 25
About Operations Sent to SGSN • 28
About Sending ContinueGPRS in Messages • 5, 9
About This Document • v
ACS • 33
ActivityTestGPRS Operation • 28, 29
ApplyChargingGPRS Operation • 28, 29
ApplyChargingReportGPRS Operation • 25
Audience • v

C

CAMEL • 33
CAP • 33
CAP3GPRS Configuration for Message Sequences • 1, 2
CAP3GPRS Message Sequences • 5, 25, 28
CC • 33
CCS • 33
Compliance Statement • 1
ConnectGPRS (ContextEstablishment) Example • 14
ConnectGPRS (ContextEstablishment) Message Sequence • 9, 14
ConnectGPRS Operation • 28, 29
Context Establishment Acknowledgement Example • 10
ContextEstablishment with Successful Charging Example • 11
ContextEstablishment with Successful Charging Message Sequence • 9, 11
ContextEstablishmentAcknowledgement Message Sequence • 9, 10
ContinueGPRS Operation • 28, 29
ContinueGPRS Session Example • 6
ContinueGPRS Session Message Sequence • 5
Convergent • 33
Copyright • ii
CPE • 33

D

Disconnect Session Example • 8
Document Conventions • vi
Duration Charging, Error Returned Example • 24
Duration Charging, Session Still Exists Example • 22
Duration Charging, Session Timeout Example • 23

E

EntityReleased (ContextEstablishment) Example • 15
EntityReleased (ContextEstablishment) Messages • 9, 15
EntityReleasedGPRS Operation • 25, 26
ETSI • 33
EventReportGPRS Operation • 25, 28

F

FCI • 33
FurnishChargingInformationGPRS Operation • 28, 30

G

GPRS • 34
GPRS Event Type Definition in InitialDPGPRS Operations • 3, 27

I

IN • 34
INAP • 34
InitialDPGPRS Operation • 25, 26
Introduction to CAP3GPRS Compliance • 1
Introduction to Message Sequences for ActivityTestGPRS • 18
Introduction to Message Sequences for Sessions • 5
Introduction to Message Sequences with PDP Context • 9
ISDN • 34

M

Message Sequences for ActivityTestGPRS • 1, 18
Message Sequences for Sessions • 1, 5
Message Sequences with PDP Contexts • 1, 9
MSISDN • 34

O

Operations Sent from SGSN to the Control Agent • 25
Operations Sent to SGSN from the Control Agent • 28
Operations Supported by CAP3GPRS Control Agent • 1, 25
Overview • 1, 5, 25

P

Parameters that Affect Message Sequences • 2, 4
PLMN • 34

R

Related Documents • v

ReleaseGPRS Operation • 28, 30
RequestReportGPRSEvent Operation • 28, 30

S

SCI • 34
SCI and FCI (ContextEstablishment) Example • 16
SCI and FCI Message Sequences • 9, 15
Scope • v
SendChargingInformationGPRS Operation • 28, 31
Service Denied (ContextEstablishment) Example • 13
Service Denied (ContextEstablishment) Message Sequence • 9, 13
Service Denied Session Example • 8
Service Denied Session Message Sequence • 5, 8
Session Charging Successful Example • 7
Session Terminated (ContextEstablishment) Example • 14
Session Terminated (ContextEstablishment) Message Sequence • 9, 14
SGSN • 34
SLEE • 34
SMS • 34
SN • 34
SSP • 34
Subscriber Disconnects Session (ContextEstablishment) Example • 13
Subscriber Disconnects Session (ContextEstablishment) Message Sequence • 9, 12
Subscriber Disconnects Session Message Sequence • 5, 7
Successful Session Charging Message Sequence • 5, 6
Switching Point • 35

T

TCAP • 35
TCAP Message Dialog Portion Parameters • 1
Terminate Session Example • 9
Terminate Session Message Sequence • 5, 8
Typographical Conventions • vi

V

Volume Charging, Error Returned Example • 21
Volume Charging, Session Still Exists Example • 18
Volume Charging, Session Timeout Example • 20