

**Oracle® Communications
Convergent Charging Controller**

Advanced Control Services Technical Guide

Release 12.0.2

December 2018

Copyright

Copyright © 2018, Oracle and/or its affiliates. All rights reserved.

This software and related documentation are provided under a license agreement containing restrictions on use and disclosure and are protected by intellectual property laws. Except as expressly permitted in your license agreement or allowed by law, you may not use, copy, reproduce, translate, broadcast, modify, license, transmit, distribute, exhibit, perform, publish, or display any part, in any form, or by any means. Reverse engineering, disassembly, or decompilation of this software, unless required by law for interoperability, is prohibited.

The information contained herein is subject to change without notice and is not warranted to be error-free. If you find any errors, please report them to us in writing.

If this is software or related documentation that is delivered to the U.S. Government or anyone licensing it on behalf of the U.S. Government, then the following notice is applicable:

U.S. GOVERNMENT END USERS: Oracle programs, including any operating system, integrated software, any programs installed on the hardware, and/or documentation, delivered to U.S. Government end users are "commercial computer software" pursuant to the applicable Federal Acquisition Regulation and agency-specific supplemental regulations. As such, use, duplication, disclosure, modification, and adaptation of the programs, including any operating system, integrated software, any programs installed on the hardware, and/or documentation, shall be subject to license terms and license restrictions applicable to the programs. No other rights are granted to the U.S. Government.

This software or hardware is developed for general use in a variety of information management applications. It is not developed or intended for use in any inherently dangerous applications, including applications that may create a risk of personal injury. If you use this software or hardware in dangerous applications, then you shall be responsible to take all appropriate fail-safe, backup, redundancy, and other measures to ensure its safe use. Oracle Corporation and its affiliates disclaim any liability for any damages caused by use of this software or hardware in dangerous applications.

Oracle and Java are registered trademarks of Oracle and/or its affiliates. Other names may be trademarks of their respective owners.

Intel and Intel Xeon are trademarks or registered trademarks of Intel Corporation. All SPARC trademarks are used under license and are trademarks or registered trademarks of SPARC International, Inc. AMD, Opteron, the AMD logo, and the AMD Opteron logo are trademarks or registered trademarks of Advanced Micro Devices. UNIX is a registered trademark of The Open Group.

This software or hardware and documentation may provide access to or information about content, products, and services from third parties. Oracle Corporation and its affiliates are not responsible for and expressly disclaim all warranties of any kind with respect to third-party content, products, and services unless otherwise set forth in an applicable agreement between you and Oracle. Oracle Corporation and its affiliates will not be responsible for any loss, costs, or damages incurred due to your access to or use of third-party content, products, or services, except as set forth in an applicable agreement between you and Oracle.

Contents

About This Document	vii
Document Conventions	viii
Chapter 1	
System Overview	1
Overview	1
What is Advanced Control Services?	1
What are the Main Components of ACS?	3
What are the Functions of ACS?	7
ACS CDR/EDR	7
Chapter 2	
Security Overview	9
Overview	9
About Secure SSL Connection to the Database	9
Security in ACS	10
Defining the Security Levels	11
Setting up ACS Security through SMS	13
Setting up ACS Security without using SMS	17
Chapter 3	
Configuring the Environment	21
Overview	21
Configuring the Environment	21
Defining the Screen Language	22
Defining the Help Screen Language	24
Setting up the Screens	25
Chapter 4	
Configuring the eserv.config	45
Overview	45
eserv.config Configuration	45
ACS Configuration in the eserv.config File	46
MRC Configuration	70
Chapter 5	
Configuring the acs.conf	73
Overview	73
acs.conf	73
acsChassis Plug-ins	75
acsStatisticsDBInserter (SMS)	78
acsCompilerDaemon (SMS)	81
acsProfileCompiler	84
acsStatsMaster (SLC)	85
acsChassis Single Instance Parameters (SLC)	87
acsStatsLocal (SLC)	113

acsChassis Emergency Numbers (SLC).....	113
acsChassis INAP Extension Parameters	114
acsChassis Normalization Parameters (SLC)	117
acsChassis SLEE Event Size Parameter (SLC)	123
acsChassis ServiceEntry Configuration (SLC).....	123
acsChassis SRF Configuration (SLC)	131
acsChassis SCF Configuration (SLC)	134
acsChassis SSF Configuration (SLC)	138
acsChassis EDR Configuration (SLC)	143
acsChassis Service Library Configuration (SLC)	152
acsChassis Service Normalisation Parameters (SLC)	153
acsChassis AWOL Configuration	153
Get Hunting Number Node Configuration	156
Number Matching Node Configuration	156
Play Variable Part Announcement Node Configuration	157
Profile Date Compare Node Configuration	158
acs.conf Example	158

Chapter 6

Background Processes 167

Overview.....	167
Automated ACS Processes (SMS Machine)	167
acsCompilerDaemon	168
acsSnCpActAlarms	169
acsDbCleanup.sh	171
acsProfileCompiler	171
acsStatisticsDBInserter	172
Automated ACS Processes (SLC Machine).....	173
acsStatsMaster	173
libacsChassisActions.....	174
libacsMacroNodes	174
libacsService	175

Chapter 7

Tools and Utilities 177

Overview.....	177
acsAddCallPlan	177
acsAddCustomer	179
acsAddGeography.....	180
acsAddServiceNumber.....	181
acsDecompile	182
acsDumpControlPlan	183
acsMonitorCompiler	184
acsProfile	184
acsScheduleCallPlan	187
acsSetupAnnouncement	187
Usage:	188
numberDataImport	188

Chapter 8

Pre-installation..... 193

Overview.....	193
---------------	-----

ACS Client Specifications.....	193
Preparing the System.....	194
Chapter 9	
About Installation and Removal.....	197
Overview.....	197
Installation and Removal Overview.....	197
Installing acsSms Packages on a Clustered SMS.....	197
Checking the Installation.....	199
System Manifest.....	201
Chapter 10	
Post-Installation Procedures.....	203
Overview.....	203
Using Announcements.....	203
ACS Global Control Plans.....	204
Appendix A	
Time Zones.....	205
Appendix B	
ASCII Codes.....	213
Glossary of Terms.....	217
Index.....	229

About This Document

Scope

The scope of this document includes all the information required to install, configure and administer the Advanced Control Services (ACS) application.

Audience

This guide was written primarily for system administrators and persons installing and administering the ACS application. The documentation assumes that the person using this guide has a good technical knowledge of the system.

Prerequisites

Although there are no prerequisites for using this guide, familiarity with the target platform would be an advantage.

A solid understanding of Unix and a familiarity with IN concepts are an essential prerequisite for safely using the information contained in this guide. Attempting to install, remove, configure or otherwise alter the described system without the appropriate background skills, could cause damage to the system; including temporary or permanent incorrect operation, loss of service, and may render your system beyond recovery.

This manual describes system tasks that should only be carried out by suitably trained operators.

Related documents

The following documents are related to this document:

- *Advanced Control Services User's Guide*
- *Open Services Development User's and Technical Guide*
- *Service Logic Execution Environment Technical Guide*
- *Service Management System Technical Guide*
- *Service Management System User's Guide*
- *XML TCAP Interface Technical Guide*

Document Conventions

Typographical Conventions

The following terms and typographical conventions are used in the Oracle Communications Convergent Charging Controller documentation.

Formatting Convention	Type of Information
Special Bold	Items you must select, such as names of tabs. Names of database tables and fields.
<i>Italics</i>	Name of a document, chapter, topic or other publication. Emphasis within text.
Button	The name of a button to click or a key to press. Example: To close the window, either click Close , or press Esc .
Key+Key	Key combinations for which the user must press and hold down one key and then press another. Example: Ctrl+P or Alt+F4 .
Monospace	Examples of code or standard output.
Monospace Bold	Text that you must enter.
<i>variable</i>	Used to indicate variables or text that should be replaced with an actual value.
menu option > menu option >	Used to indicate the cascading menu option to be selected. Example: Operator Functions > Report Functions
hypertext link	Used to indicate a hypertext link.

Specialized terms and acronyms are defined in the glossary at the end of this guide.

System Overview

Overview

Introduction

This chapter provides a high-level overview of the application. It explains the basic functionality of the system and lists the main components.

It is not intended to advise on any specific Oracle Communications Convergent Charging Controller network or service implications of the product.

In this Chapter

This chapter contains the following topics.

What is Advanced Control Services?	1
What are the Main Components of ACS?	3
What are the Functions of ACS?	7
ACS CDR/EDR	7

What is Advanced Control Services?

Description

Advanced Control Services (ACS) is an application that allows service providers to define enhanced call interaction to be triggered in the case of one or more of the following:

- Calls to specific dialed numbers (service numbers)
- Calls from specific calling numbers (CLI numbers)
- All calls triggered to a specified INAP service key

Call Processing and Features

The call processing consists of an arbitrary call-processing diagram, which makes decisions and performs actions chosen from a rich set of feature nodes.

These nodes include basic features such as. time routing (day, week, year), proportional routing, calling and called prefixes, special numbers, failover routing, and VIP customers. They include telephony actions such as announcement playing, IVR prompting, number redirection, account code, and PIN entry.

Other Features

In addition, many ancillary functions are provided, such as detailed logging and analysis information, event counting and branching, customer self-administration, multi-lingual support for announcements and user interfaces, and many more features as described in *ACS User's Guide*.

Call Routing Services

These features make ACS an ideal application to provide a wide range of common and popular call routing services, for example:

- FreePhone
- Premium Rate
- TeleVote
- Follow Me/Personal Numbering
- Call Screening (Incoming)

Plus common residential/small business services, for example:

- Account Code Validation
- Toll Barring (With PIN Override)
- Hot Line
- Call Screening (Outgoing)
- Basic Friends & Family

What are the Main Components of ACS?

Diagram of main components

The schematic diagram below depicts the main components of ACS on the IN platform.

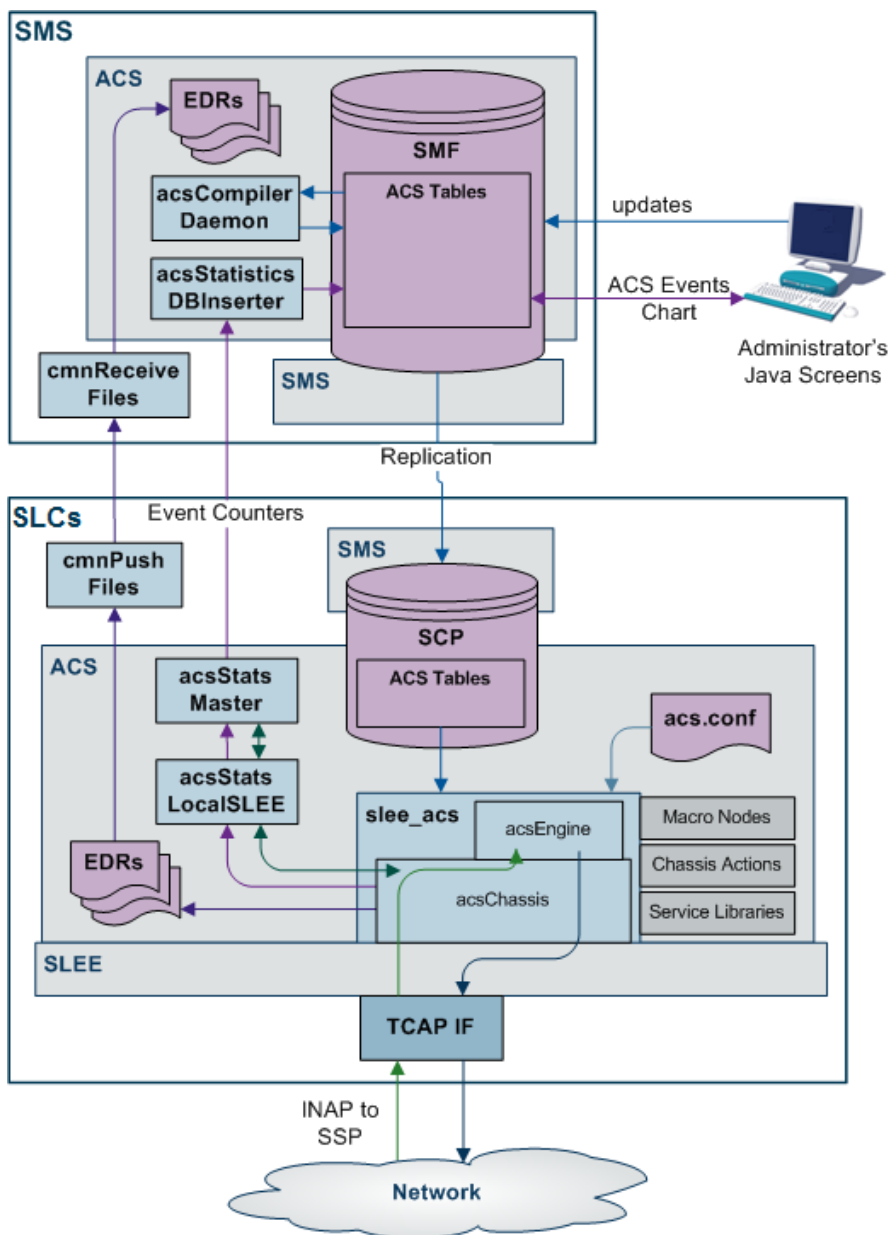

Standard Profile Block List

Here are the profile blocks available with a new installation of ACS.

Name	Description
Any Valid Profile	Allows you to search for relevant tags in all profiles that have been loaded.

Name	Description
App Specific Profile 1 App Specific Profile 2 App Specific Profile 3 App Specific Profile 4 App Specific Profile 5 App Specific Profile 6 App Specific Profile 7 App Specific Profile 8	Contains information specific to an application, for example, Messaging Manager.
CLI Subscriber Profile	Contains most of the information you can specify in the CLI tab of the Numbers screen, for example: <ul style="list-style-type: none"> • Account code • Language • Follow me number Note: Only relevant to the 0800 service.
Call Context	Allows access to information received from the network, including the list of buffers as described in ACS Buffers.
Control Plan Profile	This profile contains current switch node exits only.
Customer Profile	Contains customer information, for example: <ul style="list-style-type: none"> • Incoming barred/allowed list type • Incoming barred/allowed list • PIN rights • Default language • Incoming barred/allowed ignore • Termination number ranges • Termination number range policy
Global Profile	Contains global information, for example: <ul style="list-style-type: none"> • PIN rights • Multi-lingual announcements • Default language • Control plan version hiding
Incoming Session Data	Data which comes in over the network. Examples include: <ul style="list-style-type: none"> • InitialDP received for voice • MO Forward SM for SMS using Messaging Manager • Diameter CCR (INITIAL_REQUEST)
Outgoing Session Data	Data which goes out over the network.
Service Number Profile	Contains most of the information you can specify in the Service Number tab of the Numbers screen, for example: <ul style="list-style-type: none"> • Account code • Language • Follow me number Note: Only relevant to the 0800 service.
Temporary Storage	Stores the data in memory and does not write it to the database. It exists for the duration of the control plan execution only.

Name	Description
VPN Network Profile	<p>Contains most of the information you can specify in the VPN edit network, for example:</p> <ul style="list-style-type: none"> • Account Code maximum length • Outgoing barred/allowed list type • Incoming barred/allowed list type • VPN network SD no check • VPN present private address <p>Note: Only relevant if you have the VPN service installed.</p>
VPN Station Profile	<p>Contains most of the information you can specify in the VPN edit station, for example:</p> <ul style="list-style-type: none"> • Outgoing barred/allowed list type • Incoming barred/allowed list type • VPN bar all incoming • VPN bar off network incoming <p>Note: Only relevant if you have the VPN service installed.</p>

ACS Primary Tags

Here is a list of ACS primary tags.

Note: These tags are preloaded on installation of ACS and are displayed on the ACS Configuration screen, **Profile Tag Details** tab.

Description	Hex	Decimal
DO NOT USE	0x0000	0
PIN Prefix	0x0001	1
PIN Length	0x0002	2
Account Code Prefix	0x0003	3
Account Code Max Length	0x0004	4
A/S Prefix	0x0005	5
A/S Length	0x0006	6
Off Net Prefix	0x0007	7
S/D Prefix	0x0008	8
Outgoing Barred/Allowed List Type	0x0009	9
Outgoing Barred/Allowed List	0x000a	10
Incoming Barred/Allowed List Type	0x000b	11
Incoming Barred/Allowed List	0x000c	12
Account Code Values	0x000d	13
Account Code Policy	0x000e	14
-RESERVED-	0x000f	15
Divert RSF	0x0010	16
Divert Busy	0x0011	17

Description	Hex	Decimal
Divert No Answer	0x0012	18
Divert Follow Me	0x0013	19
Divert TOW Schedule	0x0014	20
PIN Digits	0x0015	21
PIN Rights	0x0016	22
Off Net Bar	0x0017	23
Follow on Break Out Sequence	0x0018	24
Station is Manager	0x0019	25
Speed List	0x001a	26
Divert Barred/Allowed List Type	0x001b	27
Divert Barred/Allowed List	0x001c	28
Divert Locations	0x001d	29
Break Limit	0x001e	30
LCR Old National	0x001f	31
LCR New National	0x0020	32
LCR Old International	0x0021	33
LCR New International	0x0022	34
Multi Lingual Announcements	0x0023	35
Number Lists	0x0024	36
Language	0x0025	37
Switch Configuration	0x0026	38
Virtual Message List	0x0027	39
Number Of Messages	0x0028	40
GUI Language	0x0029	41
Carrier Code	0x002a	42
Barred Categories	0x002b	43
Outgoing Barred/Allowed Ignore	0x002c	44
Incoming Barred/Allowed Ignore	0x002d	45
Divert Barred/Allowed Ignore	0x002e	46
Account Code Minimum Length	0x002f	47
Timezone Geographical Map	0x0030	48
PIN Encryption Method	0x0031	49
Silent Disconnect	0x0032	50
Postpaid Flag	0x0033	51
Hunt On Busy	0x0034	52
Hunt On No Answer	0x0035	53
Hunt Always	0x0036	54
Hunt RESERVED	0x0037	55
Help Line Address	0x0038	56
Legacy	0x0039	57
Disable	0x003a	58
VARs	0x003b	59

Description	Hex	Decimal
VARS Mapping	0x003c	60
Toll Free Beep ID	0x003d	61
Toll Free Beep Type	0x003e	62
Termination Number Ranges	0x003f	63
Termination Number Range Policy	0x0040	64
Control Plan Version Hiding	0x0041	65
Toll Free Beeps Required	0x0042	66
Bar Pay Phone Callers	0x0043	67
Bar Cell Phone Callers	0x0044	68

Note: Each service may have its own specific tags in a separate tag range.

What are the Functions of ACS?

Introduction

Calls using the ACS service will follow a control plan, and given varying circumstances will be directed to a terminating point. A control plan is effectively a flow chart defining the decisions and actions made to determine the routing of a call.

A control plan may consist of multiple different decision or action nodes called feature nodes. Each feature node has one input and a number of outputs determined by the type of feature node. The exceptions to this are the Start and End feature nodes that have only one output or one input respectively.

Each output from a feature node can lead to another feature node. The output used when exiting a feature node during call processing is determined by the functionality of that feature node. For example, a day of week feature node has multiple outputs, which are used depending on the current day of the week, and an internal customer defined mapping of the day of week to an output.

ACS CDR/EDR

Introduction

All ACS EDR information is located in the *Event Detail Record Reference Guide*.

Security Overview

Overview

Purpose

This chapter describes the security features of the Advanced Control Services application.

In this chapter

This chapter contains the following topics.

About Secure SSL Connection to the Database	9
Security in ACS	10
Defining the Security Levels	11
Setting up ACS Security through SMS	13
Setting up ACS Security without using SMS	17

About Secure SSL Connection to the Database

Enabling Secure SSL Connection to the Database

Convergent Charging Controller supports secure network logins through Secure Socket Layer (SSL) connections from the Convergent Charging Controller UI to the database. SSL is the default method for connecting to the database when you install Convergent Charging Controller. You can also enable SSL after installing Convergent Charging Controller.

For information about enabling SSL connections to the database, see *SMS Technical Guide*.

Enabling SSL for ACS

You can access the ACS through the Services menu in the SMS UI, or you can access it directly from:

- Your Web browser by using the appropriate URL
- A Java WebStart URL
- The desktop or Start menu by using the CCP shortcut

If you access the ACS through the SMS UI and SSL is already enabled, no further action is required to enable SSL for the ACS. For information about enabling SSL on the SMS, see *SMS Technical Guide*.

If you access the ACS directly, enable SSL connections to the database by:

- Creating the Oracle wallet that identifies the database server on the SMS node. Its location must be specified in the **listener.ora** and **sqlnet.ora** files.
- Modifying the **listener.ora** file to also listen on port 2484. Use the TCPS protocol for secure SSL connections to the database.

Note: The standard Oracle listener TCP port is 1521. However, SSL connections use the standard port for the TCPS protocol, port 2484, instead. If there is a firewall between screen clients and the SMS, you must open port 2484 in the firewall.

For more information about enabling SSL by configuring the Oracle wallet and updating the `listener.ora` and `sqlnet.ora` files, see *SMS Technical Guide*.

The following additional configuration must be set in the `acs.jnlp` file:

- The `jnlp.sms.secureConnectionDatabaseHost` Java application property (on non-clustered systems) or the `jnlp.sms.secureConnectionClusterDatabaseHost` Java application property (on clustered systems) must specify the database connection in the `CONNECT_DATA` part. In addition the `PROTOCOL` part must be set to `TCPS` and the `PORT` part must be set to `2484`.
- Set the `jnlp.sms.EncryptedSSLConnection` Java application property to `true`. The Convergent Charging Controller UI connects to the database by using encrypted SSL connections by default.

Note: If you use non-SSL connections to the database, you must set `jnlp.sms.EncryptedSSLConnection` to `false`.

See *Java Application Properties* (on page 25) for more information.

Security in ACS

Introduction

This chapter describes the ACS security system and gives instructions for its use. ACS will always be installed as a service that is available through Service Management System, but may also be accessed directly.

ACS maintains its own security system, distinct from that of SMS.

Accessing ACS through SMS

When ACS is accessed through the Service Management System, the SMS security settings take precedence over the ACS security settings. ACS is accessed through SMS as shown below:

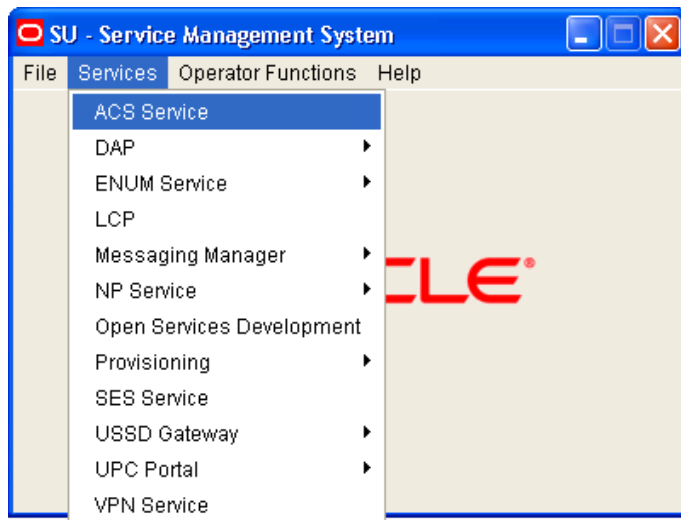

Accessing ACS directly

ACS security settings are only valid when ACS is accessed directly (that is, not through the SMS).

Accessing ACS directly displays the ACS Logon screen.



Defining the Security Levels

Introduction

The ACS security system, that applies when ACS is accessed directly, operates by assigning tiered permission levels to ACS customers, to manage the degree of access that each customer has to the features of ACS.

These permissions range from a Level 7 super user to a Level 1 user with read-only access to the system. When ACS is installed, a super user is automatically created, with full access to the system. Only one super user is allowed and cannot be deleted. Other users are created as required, with permission levels appropriate to the desired degree of access.

Note: These ACS permissions apply only when the user has accessed ACS without accessing the Service Management System screens. Any user who logs on through the SMS takes the SMS permission level associated with the SMS login used.

ACS User Privilege Levels

The diagram below shows the various user privilege levels. See *Permission Levels* for a description of each level.

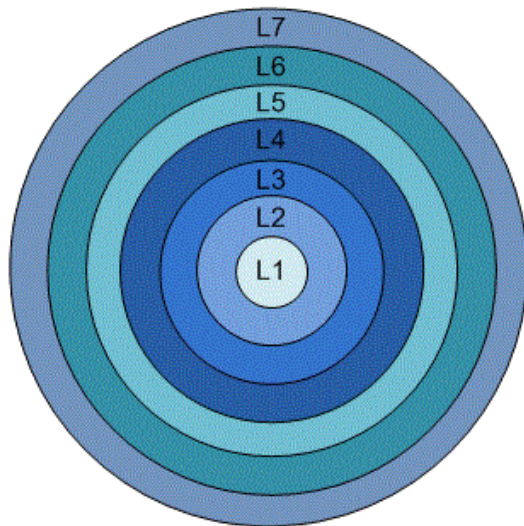

Permission Levels

There are seven levels of security within the ACS application.

Level	Description
1	Read only access to information for their customer. <ul style="list-style-type: none"> • May change own password
2	Access of permission 1 and in addition: <ul style="list-style-type: none"> • Change any switch feature nodes in the control plans of their customers to point to other output branches
3	User has access of permission 2 and in addition: <ul style="list-style-type: none"> • Change all the feature node data in the control plans for their customers • Add and remove statistics counters • Edit the effective date and time and control plan used by a service number or CLI
4	User has access of permission 3 and in addition: <ul style="list-style-type: none"> • Edit the structures of the control plans of their customers • Add, edit and delete customer contacts • Add, edit and delete authorization codes • Add a second instance of a currently allocated service number or CLI • Add, edit and delete private holiday and geography sets
5	User has access of permission 4 and in addition: <ul style="list-style-type: none"> • Add users, delete users, change passwords and change privileges.
6	ACS V2 system administrator has access to add, delete and modify all aspects of ACS V2, including all public data and announcements: <ul style="list-style-type: none"> • Add and delete customers • Add and delete termination numbers • Set resource allocations for users • Manage other customers

Level	Description
	<ul style="list-style-type: none"> • Details of the feature nodes are fixed and may not be changed • Advanced editing options on CPE available
7	User has full access to ACS and in addition: <ul style="list-style-type: none"> • Add and delete other level 6 users

Setting up ACS Security through SMS

Introduction

A Telco must set up SMS users for all users accessing the Service Management System. These SMS users must have a SMS security template assigned to them. All users who access the SMS use the security settings that are set up in the template assigned to them. When accessed through the SMS screens, the SMS security system takes precedence and the following steps are required.

Example:

A Telco may set up an ACS system administrator template, for users who perform a system administrator role, perhaps as a Telco help desk operator. The following example shows setting up this ACS system administrator user to access ACS through the SMS, and then having this user create an ACS customer.

Procedure

Follow these steps to set the security for a user.

Step	Action
1	Set up an SMS user, using the User tab of the SMS User Management screen.

Step Action

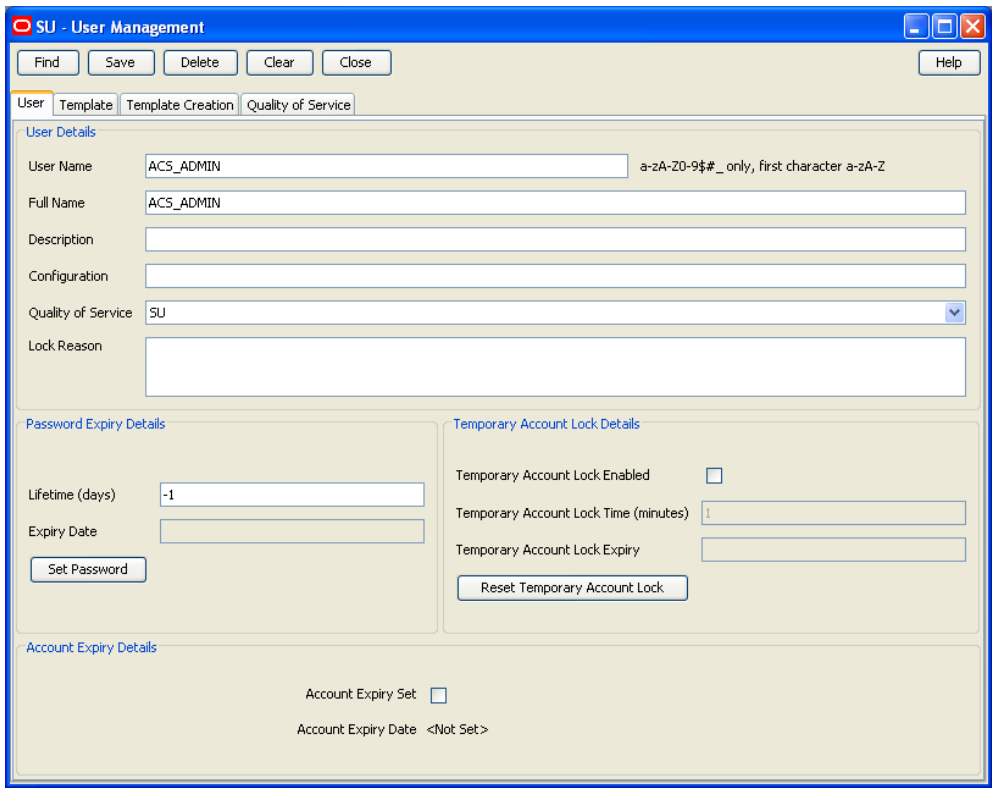

See *SMS User's Guide* for further details about the SMS screens.

2 Enter and confirm a password for the new SMS user.



When this user logs onto the SMS, the user name and password are entered into the Login dialog.

3 **Important:** Follow this step *only if you are required to create a new template* for a user, which should rarely arise.

- a. Create a template for the permissions that are to be allocated to the new user. Do this on the **Template Creation** tab of the SMS User Management screen.
- b. Select the required permission for each ACS feature from the tree diagram in the **Available Permissions** list. Using the mouse, drag the selected permission to the **Allocated Permissions** list.
- c. The entries in the **Allocated Permissions** list indicate the level of access granted to any user allocated this template.
- d. Name the template and save the settings.

Step	Action
------	--------

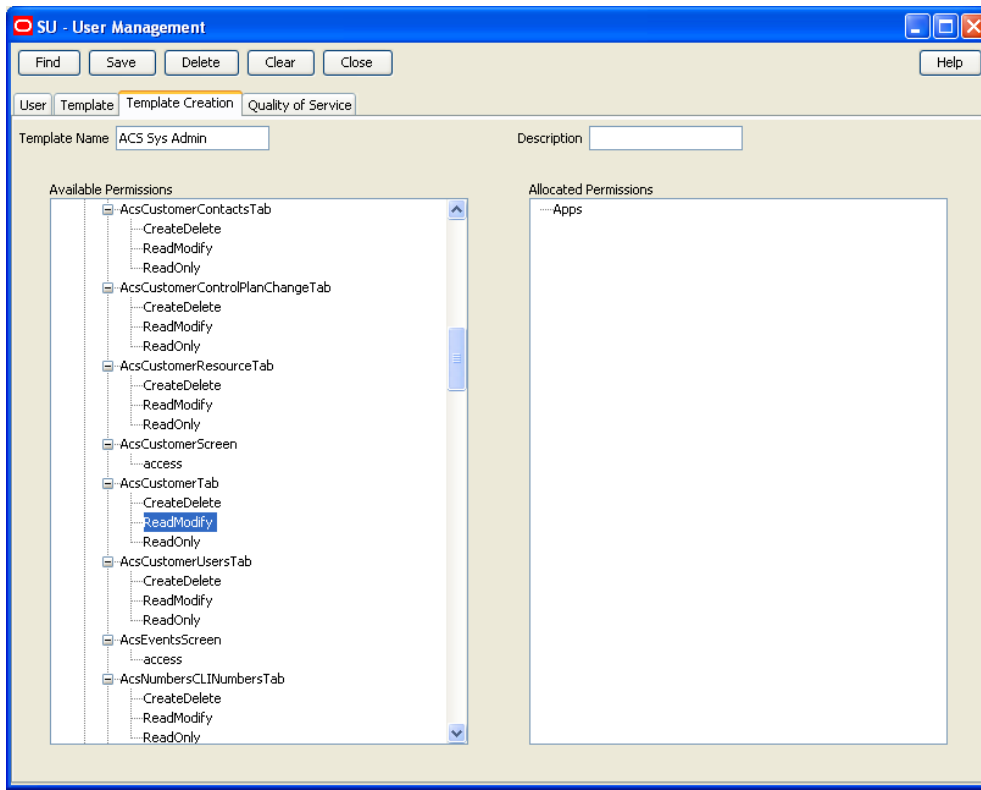

See *SMS User's Guide* for further details about SMS screens.

- 4 Assign a template to the user using the **Template** tab of the SMS User Management screen.
 Allocate the new template to the new user. The user is then granted the specific access to ACS that has been set in the **Template Creation** tab.
 To allocate a template, select the required template in the **Available Templates** list and click **Add**. The template will appear in the **Allocated Templates** list.
Note: You are able to assign any number of users to a template.

Step	Action
------	--------

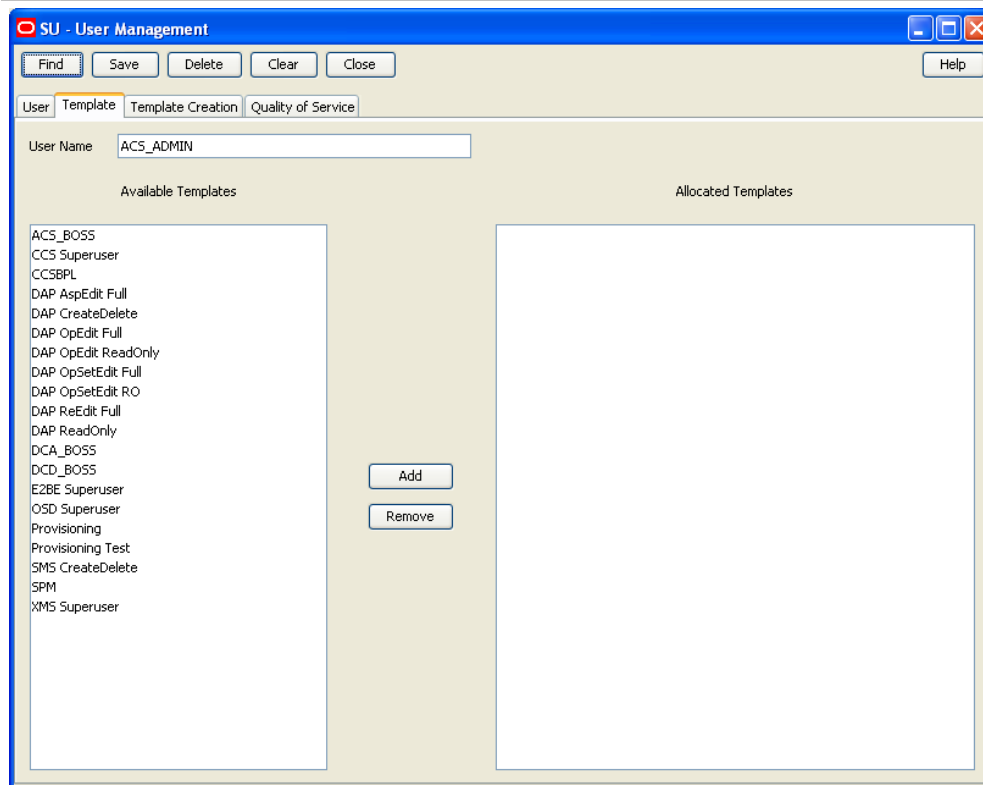

- 5 Close and restart the SMS UI.
- 6 Log in using the new user name and password.
- 7 Open the ACS Customer screen, accessed through the ACS main screen and set up an ACS customer for the SMS user.

Where the allocated template gives the SMS user full access to ACS, an ACS customer may be created with ACS user permissions up to level 5.

Only the ACS Boss user may create and delete ACS level 6 users. On the New Customer screen, select the **Create User for Customer** option, to automatically create a user for that customer.

Step	Action
------	--------

This same user may also need to have set up for them an ACS system administrator user. The Telco will set up a level 6 user, who has full access to the ACS system but cannot add or delete other level 6 users. This will be for direct access to ACS and may be achieved as shown in the example below.

Setting up ACS Security without using SMS

Introduction

When ACS is not accessed through the Service Management System UI, the SMS security system does not apply.

Procedure

Follow these steps to set the security for a level 6 user.

Step	Action
1	Enter the ACS screens as the Boss user (permission level 7). Set up a new ACS customer, using the Customer tab of the ACS Customer screen. See <i>ACS User's Guide</i> for further details about the ACS screens.

New Customer

Customer Name: User Level 5

Description: [Empty]

Customer Reference: 33554

Customer Type: Normal

Attached To: Telco Reseller (Reseller1) Agent

Resource Multiplier: 1

Use override control plan:

Override Control Plan: ACS Management1 (Version: 1)

Language: English

PIN: [Masked]

Management ID: 45352

Managed Customer:

Create User for Customer:

Termination Number Range Rules:

- Own Range
- Default Range
- No Checking

Buttons: Save, Cancel, Help

- 2 Select the new customer from the list at the top of the ACS Customer screen. Using the **User** tab, create a user for the new customer, with Permission Level 6.

Step Action

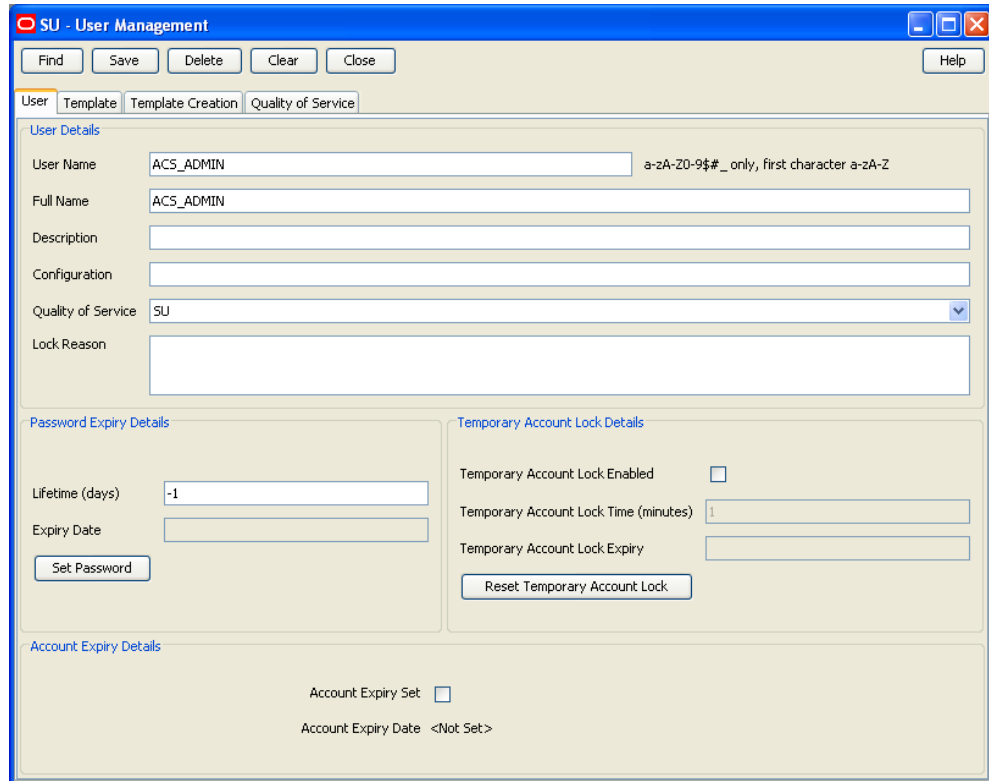

SU - User Management

Find Save Delete Clear Close Help

User Template Template Creation Quality of Service

User Details

User Name ACS_ADMIN a-zA-Z0-9\$#_ only, first character a-zA-Z

Full Name ACS_ADMIN

Description

Configuration

Quality of Service SU

Lock Reason

Password Expiry Details

Lifetime (days) -1

Expiry Date

Set Password

Temporary Account Lock Details

Temporary Account Lock Enabled

Temporary Account Lock Time (minutes) 1

Temporary Account Lock Expiry

Reset Temporary Account Lock

Account Expiry Details

Account Expiry Set

Account Expiry Date <Not Set>

- 3 The customer may then log in directly, and with full access, to ACS (without having access to the SMS screens) using this user and password, in this example created using the **Users** tab of the ACS Customer screen.

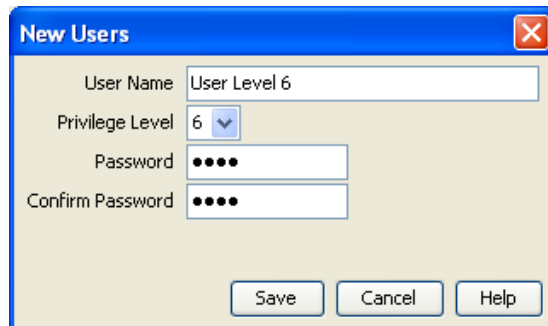

New Users

User Name User Level 6

Privilege Level 6

Password ●●●●

Confirm Password ●●●●

Save Cancel Help

Configuring the Environment

Overview

Purpose

This chapter describes the steps required to configure ACS.

Configuration file

Many ACS tools and processes depend on a shared configuration file. This file **acs.conf** is located in the `$ACS_ROOT/etc` directory. The configuration file consists of several sections named for the executable they control. Each section contains a name value pair representing a single configuration option.

If the operator changes the **acs.conf** file, the corresponding service needs to be restarted, so that the configuration file is reread and the changes take effect.

Final configuration

It is important to complete the final configuration of ACS after this chapter. See *ACS User's Guide - Setting up ACS for the First Time*.

In this chapter

This chapter contains the following topics.

Configuring the Environment	21
Defining the Screen Language	22
Defining the Help Screen Language	24
Setting up the Screens	25

Configuring the Environment

Setting the ACS Root Directory

The ACS installation depends on a single environment variable to determine the location of the configuration and other support files.

If the software is not installed in the default location, the UNIX system accounts used to execute the service logic and ancillary tools must have this environment variable defined.

The `ACS_ROOT` variable will only need to be modified if you intend to manually configure two ACS installations side-by-side on the same machine.

Important: This should only be done in consultation with a qualified Oracle engineer.

If you are not required to manually configure two ACS installations, side-by-side, on the same machine the `ACS_ROOT` variable does not need to be set.

Variable	Default	Description
<code>ACS_ROOT</code>	<code>//N/service_packages/ACS</code>	ACS installation base directory

ACS_ROOT

Description: The ACS installation base directory**Type:** String**Optionality:** Optional (default used if not set).**Default:** `//IN/service_packages/ACS`

Oracle Variables

The ACS account (acs_oper) requires the standard ORACLE environment variables to be present.

Oracle usr/pwd String

While it is possible to specify the usr/pwd string a process uses to connect to Oracle, it is recommended to use the defaults.

Most ACS processes are run by the UNIX user acs_oper. The OPS\$ACS_OPER Oracle operator account corresponds to acs_oper. This allows acs_oper to log on to oracle as OPS\$ACS_OPER without specifying a user name or password (that is, the process uses the default of "/"). A separate Oracle password is not needed for OPS\$ACS_OPER because it is, in Oracle terms, identified externally.

Configuration Files

ACS is configured by the following components:

Component	Locations	Description	Further Information
acs.conf	all SMSs and VWSs in the \$(ACS_ROOT)/etc directory	This file consists of several sections named for the ACS executable they control. There are different configuration options in the acs.conf on the SMS to the configuration options in the acs.conf on the SLC.	<i>Configuring the acs.conf</i> (on page 73)
SLEE.cfg	all SLCs	This file sets up SLEE interfaces and applications.	<i>SLEE Technical Guide</i>
eserv.config	all SMSs and VWSs	ACS has some additional configuration in the ACS section of eserv.config .	<i>eserv.config Configuration</i> (on page 45)

Defining the Screen Language

Introduction

The default language file sets the language that the Java administration screens start in. The user can change to another language after logging in.

The default language can be changed by the system administrator.

By default, the language is set to English. If English is your preferred language, you can skip this step and proceed to the next configuration task, *Defining the Help Screen Language* (on page 24).

Default.lang

When ACS is installed, a file called **Default.lang** is created in the application's language directory in the screens module. This contains a soft-link to the language file that defines the language that will be used by the ACS UI.

If a **Default.lang** file is:

- Not present, the **English.lang** file will be used
- Present, a user must explicitly set their language to their required language in the Tools screen or the default language will be used

The ACS **Default.lang** file is located in the `/IN/html/Acs_Service/language/` directory.

Example Screen Language

If Dutch is the language you want to set as the default, create a soft-link from the **Default.lang** file to the **Dutch.lang** file.

Procedure

Follow these steps to set the default language for your ACS user interface (UI).

Step	Action
1	Go to the <code>/IN/html/Acs_Service/language</code> directory. Example command: <code>cd /IN/html/Acs_Service/language</code>
2	Ensure the Default.lang file exists in this directory.
3	If the required file does not exist, create an empty file called Default.lang .
4	Ensure that the language file for your language exists in this directory. The file should be in the format: <code>language.lang</code> Where: <code>language</code> is your language. Example: Spanish.lang
5	If the required language file does not exist, perform one of the following actions: <ul style="list-style-type: none"> • Create a new one with your language preferences • Contact Oracle support. <p>To create a language file, you will need a list of the phrases and words used in the screens. These should appear in a list with the translated phrase in the following format: <code>original phrase=translated phrase</code></p> <p>Any existing language file should have the full set of phrases. If you do not have an existing file to work from, contact Oracle support.</p>
6	Create a soft link between the Default.lang file, and the language file you want to use as the default language for the SMS UI. Example command: <code>ln -s Dutch.lang Default.lang</code>

Defining the Help Screen Language

Introduction

The default Helpset file sets the language that the help system for the Java Administration screens start in. The user can change to another language after logging in.

The default language can be changed by the system administrator. By default, the language is set to English.

Default_Acs_Service.hs

When ACS is installed, a file called **Default_Acs_Service.hs** is created in the application's language directory in the screens module. This contains a soft-link to the language file which defines the language that will be used by the ACS UI.

If a **Default_Acs_Service.hs** file is:

- Not present, the **English_Acs_Service.hs** file will be used.
- Present, a user must explicitly set their language to their required language in the Tools screen or the default language will be used.

The **Default_Acs_Service.hs** file is located in the `/IN/html/Acs_Service/helpertext/` directory.

Example Helpset Language

If Dutch is the language you want to set as the default, create a soft-link from the **Default_Acs_Service.hs** file to the **Dutch_Acs_Service.hs** file.

Procedure

Follow these steps to set the default language for your ACS user interface (UI).

Step	Action
1	Go to the <code>/IN/html/Acs_Service/helpertext</code> directory. Example command: <code>cd /IN/html/Acs_Service/helpertext</code>
2	Check to see if the Default_Acs_Service.hs file exists in this directory.
3	If the required file does not exist, create an empty file called Default_Acs_Service.hs .
4	Check if the language file for your language exists in this directory. The file should be in the format: <code>language_Acs_Service.hs</code> Where: <code>language</code> is your language. Example: Dutch_Acs_Service.hs
5	If the required language file does not exist, perform one of the following actions: <ul style="list-style-type: none"> • Create a new one with your language preferences • Contact Oracle support <p>To create a language file, you will need a list of the phrases and words used in the screens. These should appear in a list with the translated phrase in the following format: <code>original phrase=translated phrase</code></p> <p>Any existing language file should have the full set of phrases. If you do not have an existing file to work from, contact Oracle support.</p>
6	Create a soft link between the Default_Acs_Service.hs file, and the language file you want to

use as the default language for the ACS UI.

Example command:

```
ln -s Dutch_Acs_Service.hs Default_Acs_Service.hs
```

Setting up the Screens

Accessing ACS

There are several ways to access the ACS user interface (UI). For example:

- Use Java WebStart by entering the following URL in a Web browser:
`http://SMS_hostname/acs.jnlp`
- Open the Service Management System application, and then select **ACS Service** from the **Services** menu.
- Enter the following at the Windows command line:
`c:\> javaws http://SMS_hostname/acs.jnlp`

Where *SMS_hostname* is the hostname of an SMS in the IN.

For more information about the ACS UI, see *ACS User's Guide*.

About Customizing the ACS UI

You can customize the ACS UI by setting Java application properties in the following files located in the `/IN/html/` directory:

- `acs.jnlp`
- `sms.jnlp`

You use the following syntax to set a Java application property in the `acs.jnlp` or the `sms.jnlp` file:

```
<property name="property" value="value" />
```

Where:

- *property* is the name of the Java application property
- *value* is the value to which that property is set

Important: Some Java application properties may be set in both the `acs.jnlp` file and in the `sms.jnlp` file. You must specify the same value in both files.

Java Application Properties

The following application properties are available to customize the UI:

```
jnlp.acs.ACSDefaultCustomerIsPrepaid
```

Syntax: `<property name="jnlp.acs.ACSDefaultCustomerIsPrepaid" value="value" />`

Description: Specifies whether the ACS New Customer screen has the **Prepaid Charging Customer** check box selected by default.

Type: String

Optionality: Optional

Allowed:

- True
- t(rue)
- Yes
- y(es)
- 1

All other values are considered to be false.

Default: True

Notes: If set to:

- True – The **Prepaid Charging Customer** check box is selected by default.
- False – The **Prepaid Charging Customer** check box is cleared by default.

Example: `<property name="jnlp.acs.ACSDefaultCustomerIsPrepaid" value="True" />`

`jnlp.acs.ACSStartScreenVersion`

Syntax: `<property name="jnlp.acs.ACSStartScreenVersion" value="num" />`

Description: This property is provided for backwards compatibility only. It allows you to display the version of the ACS main screen for releases prior to NCC release 5.0.3. The current version of the ACS main screen is displayed by default.

Type: String

Optionality: Optional

Allowed:

- 1 – The version of the ACS main screen for releases prior to NCC release 5.0.3 is displayed that includes the **Events** button. The ACS events feature is now deprecated. Use this setting only if you want to access existing events configuration in ACS.
- Not set – The current version of the ACS main screen is displayed.

Default: Not set

Notes: This property is provided for backwards compatibility.

Example: `<property name="jnlp.acs.ACSStartScreenVersion" value="1" />`

`jnlp.acs.allowCallPlanSchedulingInPast`

Syntax: `<property name="jnlp.acs.allowCallPlanSchedulingInPast" value="value" />`

Description: Specifies whether control plans can be scheduled to start in the past.

Type: String

Optionality: Optional

Allowed:

- True
- t(rue)
- Yes
- y(es)
- 1

All other values are considered to be false.

Default: False

Notes: If set to:

- True – Control plans can be scheduled to start in the past.
- False – Control plans cannot be scheduled to start in the past.

Example: `<property name="jnlp.acs.allowCallPlanSchedulingInPast" value="t" />`

`jnlp.acs.allowRefInCustCombo`

Syntax: `<property name="jnlp.acs.allowRefInCustCombo" value="value" />`

Description: Specifies whether users can perform searches in the ACS UI by using the customer reference number rather than the customer name.

Type: String

Optionality: Optional

Allowed:

- True
- t(rue)
- Yes
- y(es)
- 1

All other values are considered to be false.

Default: False

Notes: If set to:

- True – Allows searches using the customer reference number only.
- False – Requires searches to include a customer name along with a customer reference number.

Example: `<property name="jnlp.acs.allowRefInCustCombo" value="t" />`

`jnlp.acs.autoCloseCompileDialog`

Syntax: `<property name="jnlp.acs.autoCloseCompileDialog" value="value" />`

Description: Specifies whether the CPE compiler report closes automatically after a control plan compiles successfully.

Type: String

Optionality: Optional

Allowed:

- True
- t(rue)
- Yes
- y(es)
- 1

All other values are considered to be false.

Default: False

Notes: If set to:

- True – The CPE compiler report closes automatically after a control plan compiles successfully.
- False – The CPE compiler report remains open after a control plan compiles successfully.

Example: `<property name="jnlp.acs.autoCloseCompileDialog" value="t" />`

`jnlp.acs.autoCloseCPE`

Syntax: `<property name="jnlp.acs.autoCloseCPE" value="value" />`

Description: Specifies whether the Control Plan Editor closes automatically after a control plan compiles successfully.

Type: String

Optionality:	Optional
Allowed:	<ul style="list-style-type: none"> • True • t(rue) • Yes • y(es) • 1 <p>All other values are considered to be false.</p>
Default:	False
Notes:	<p>If set to:</p> <ul style="list-style-type: none"> • True – The CPE closes automatically after a control plan compiles successfully. • False – The CPE remains open after a control plan compiles successfully.
Example:	<code><property name="jnlp.acs.autoCloseCPE" value="t" /></code>

`jnlp.sms.clusterDatabaseHost`

Syntax: `<property name="jnlp.sms.clusterDatabaseHost" value =
"(DESCRIPTION=
(LOAD_BALANCE=YES) (FAILOVER=ON) (ENABLE=BROKEN)
(ADDRESS_LIST=(ADDRESS=(PROTOCOL=type) (HOST=name) (PORT=port))
(ADDRESS=(PROTOCOL=type) (HOST=name) (PORT=port)))
(CONNECT_DATA=(SERVICE_NAME=SMF) (FAILOVER_MODE=(TYPE=SESSION)
(METHOD=BASIC) (RETRIES=5) (DELAY=3))))" />`

Description: Specifies the connection string (including a host and an alternative host address, in case the first IP address is unavailable) for non-SSL cluster-aware connection to the database.

To use non-SSL connections to the database, set the `jnlp.sms.EncryptedSSLConnection` property to false.

Type: String

Optionality: Optional

Allowed:

Default: By default, *port* is set to 1521.

Notes: If present, this property is used instead of the `jnlp.sms.databaseID` property.

Example: `<property name="jnlp.sms.clusterDatabaseHost" value =
"(DESCRIPTION=
(LOAD_BALANCE=YES) (FAILOVER=ON) (ENABLE=BROKEN)
(ADDRESS_LIST=(ADDRESS=(PROTOCOL=TCP) (HOST=smsphysnode1)
(PORT=1521))
(ADDRESS=(PROTOCOL=TCP) (HOST=smsphysnode2) (PORT=1521)))
(CONNECT_DATA=(SERVICE_NAME=SMF) (FAILOVER_MODE=(TYPE=SESSION)
(METHOD=BASIC) (RETRIES=5) (DELAY=3))))" />`

`jnlp.acs.connectionsDialog`

Syntax: `<property name="jnlp.acs.connectionsDialog" value="value" />`

Description: Specifies whether the Control Plan Editor displays the Manage Node Exits dialog box when you hold down the **Shift** key while dragging the mouse to connect a feature node exit to a feature node entry.

Type: String

Optionality: Optional (default used if not set)

- Allowed:**
- shown – CPE displays the Manage Node Exits dialog box.
 - hidden – CPE does not display the Manage Node Exits dialog box.

Default: shown

Notes:

Example: `<property name="jnlp.acs.connectionsDialog" value="hidden" />`

`jnlp.acs.cpeLineDrawingMechanism`

Syntax: `<property name="jnlp.acs.cpeLineDrawingMechanism" value="connection_type" />`

Description: Specifies the type of connector lines that the Control Plan Editor displays. You use connector lines to connect feature nodes in control plans.

Connector lines can be angled or straight lines:

- Angled connector lines bend around feature nodes where possible instead of crossing over them. Angled connector lines are colored when highlighted.
- HV connector lines use a combination of horizontal and vertical lines to connect feature nodes and may cross over other feature nodes. HV connector lines can be black or colored when highlighted.

Type: String

Optionality: Optional

- Allowed:**
- ColouredNodeConnectionDrawer – The CPE displays connectors as angled lines that are colored when highlighted.
 - HVNodeConnectionDrawer – The CPE displays connectors as horizontal and vertical lines that are black.
 - ColouredHVNodeConnectionDrawer – The CPE displays horizontal and vertical lines that are colored when highlighted.

Default: ColouredNodeConnectionDrawer

Notes:

Example: `<property name="jnlp.acs.cpeLineDrawingMechanism" value="HVNodeConnectionDrawer" />`

`jnlp.sms.database`

Syntax: `<property name="jnlp.sms.database" value="SMF" />`

Description: Specifies the Oracle SID for the SMF database.

Type: String

Optionality: Optional (default used if not set)

Allowed:

Default: SMF

Notes: Set at installation.

Example: `<property name="jnlp.sms.database" value="SMF" />`

`jnlp.sms.databaseHost`

Syntax: `<property name="jnlp.sms.databaseHost" value = "ip:port:sid" />`

Description: Sets the IP address and port to use for non-SSL connections to the SMF database, and the database SID.

- To use non-SSL connections to the database, set *port* to 1524 and the `jnlp.sms.EncryptedSSLConnection` property to false.
- To use SSL connections to the database, set the `jnlp.sms.EncryptedSSLConnection` property to true and set either the `jnlp.sms.secureConnectionDatabaseHost` property or the `jnlp.sms.secureConnectionClusterDatatbaseHost` property appropriately. When the `jnlp.sms.EncryptedSSLConnection` property is set to true or is undefined, `jnlp.sms.databaseHost` is ignored.

Type: String

Optionality: Optional

Allowed:

Default: Not set. Secure SSL connection is enabled at installation by default.

Notes: Internet Protocol version 6 (IPv6) addresses must be enclosed in square brackets []; for example: `[2001:db8::n:n:n:n:n:n]` where *n* is a group of 4 hexadecimal digits. The industry standard for omitting zeros is also allowed when specifying IP addresses.

Examples:

```
<property name="jnlp.sms.databaseHost" value =
"192.0.2.1:2484:SMF" />
<property name="jnlp.sms.databaseHost" value =
"[2001:db8:0000:1050:0005:0600:300c:326b]:2484:SMF" />
<property name="jnlp.sms.databaseHost" value =
"[2001:db8:0:0:0:500:300a:326f]:2484:SMF" />
<property name="jnlp.sms.databaseHost" value =
"[2001:db8::c3]:2484:SMF" />
```

`jnlp.sms.databaseID`

Syntax: `<property name="jnlp.sms.databaseID" value="port:sid" />`

Description: Specifies the SQL*Net port for connecting to the database, and the database SID.

Type: String

Optionality: Required

Allowed:

Default: 1521:SMF

Notes:

- To use non-SSL connections to the database, set *port* to 1521 and the `jnlp.sms.EncryptedSSLConnection` property to false.
- To use SSL connections to the database, set the `jnlp.sms.EncryptedSSLConnection` property to true and set either the `jnlp.sms.secureConnectionDatabaseHost` property or the `jnlp.sms.secureConnectionClusterDatatbaseHost` property appropriately. When the `jnlp.sms.EncryptedSSLConnection` property is set to true or is undefined, `jnlp.sms.databaseID` is ignored.

Example: `<property name="jnlp.sms.databaseID" value="1521:SMF" />`

`jnlp.sms.dbPassword`

Syntax:	<code><property name="jnlp.sms.dbPassword" value="password" /></code>
Description:	Specifies the database password. This password is for a special database user that the ACS Logon screen uses before the user logs in. This property is set during installation and is then not changed.
Type:	String
Optionality:	Optional (default used if not set)
Allowed:	
Default:	<code>acs_public</code>
Notes:	Do not change this value.
Example:	<code><property name="jnlp.sms.dbPassword" value="acs_public" /></code>

`jnlp.sms.dbUser`

Syntax:	<code><property name="jnlp.sms.dbUser" value="user" /></code>
Description:	Specifies the database user name. This is a special database user that the ACS Logon screen uses before the user logs in. This property is set during installation and is then not changed.
Type:	String
Optionality:	Optional (default used if not set)
Allowed:	
Default:	<code>acs_public</code>
Notes:	Do not change this value.
Example:	<code><property name="jnlp.sms.dbUser" value="acs_public" /></code>

`jnlp.acs.defaultTelcoManaged`

Syntax:	<code><property name="jnlp.acs.defaultTelcoManaged" value="value" /></code>
Description:	Specifies whether new ACS customer accounts are marked as being managed by a Telecommunications Operator (telco) by default. Telco-managed customers are customers that never log into ACS but are managed explicitly (and without resource limits) by the telco. This property controls whether the Managed Customer check box is selected in the ACS New Customer Details dialog box by default.
Type:	String
Optionality:	Optional
Allowed:	<ul style="list-style-type: none"> • True • t(rue) • Yes • y(es) • 1 <p>All other values are considered to be false.</p>
Default:	True
Notes:	If set to: <ul style="list-style-type: none"> • True – The Managed Customer check box is selected by default. • False – The Managed Customer check box is clear by default.
Example:	<code><property name="jnlp.acs.defaultTelcoManaged" value="f" /></code>

`jnlp.sms.EncryptedSSLConnection`

Syntax: `<property name="jnlp.sms.EncryptedSSLConnection" value = "value" />`

Description: Specifies whether connections to the client UI use encrypted SSL.

Type: Boolean

Optionality: Optional (default used if not set)

Allowed: true – Use encrypted SSL connections to access the client UI.

false – Use non-SSL connections to access the client UI.

Default: true

- Notes:**
- To use SSL connections to the database, set the `jnlp.sms.EncryptedSSLConnection` property to true and set either the `jnlp.sms.secureConnectionDatabaseHost` property or the `jnlp.sms.secureConnectionClusterDatatbaseHost` property appropriately.
 - To use non-SSL connections to the database, set the `jnlp.sms.EncryptedSSLConnection` property to false.

Example: `<property name="jnlp.sms.EncryptedSSLConnection" value = "true" />`

`jnlp.sms.host`

Syntax: `<property name="jnlp.sms.host" value="IPaddress" />`

Description: Specifies the Internet Protocol (IP) address for the SMS host machine that is set at installation.

Type: String

Optionality: Required

- Allowed:**
- IP version 4 (IPv4) addresses
 - IP version 6 (IPv6) addresses

Default: No default

Notes: You can use the industry standard for omitting zeros when specifying IP addresses.

Examples:

```
<property name="jnlp.sms.host" value="192.0.2.0" />
<property name="jnlp.sms.host"
value="2001:db8:0000:1050:0005:0600:300c:326b" />
<property name="jnlp.sms.host"
value="2001:db8:0:0:0:500:300a:326f" />
<property name="jnlp.sms.host" value="2001:db8::c3" />
```

`jnlp.acs.issuePCClockWarning`

Syntax: `<property name="jnlp.acs.issuePCClockWarning" value="value" />`

Description: Specifies whether a warning is raised when the user's PC clock time is more than two minutes faster or slower than the SMS platform's clock time.

Type: String

Optionality: Optional

- Allowed:**
- True
 - t(rue)
 - Yes
 - y(es)

- 1

All other values are considered to be false.

Default: True

Notes: If set to:

- True – A warning is raised.
- False – A warning is not raised.

Example: `<property name="jnlp.acs.issuePCClockWarning" value="t" />`

`jnlp.sms.logo`

Syntax: `<property name="jnlp.sms.logo" value="file" />`

Description: Specifies the logo displayed on the splash screen immediately before the ACS Logon screen appears.

At installation, the property is set to an Oracle logo GIF file.

Type: String

Optionality: Optional

Allowed: A valid network path and filename.

Default: None

Notes:

Example: `<property name="jnlp.sms.logo" value="SMS/images/oracle.gif" />`

`jnlp.acs.MAX_CONTROL_PLANS_DISPLAYED`

Syntax: `<property name="jnlp.acs.MAX_CONTROL_PLANS_DISPLAYED" value="num" />`

Description: Specifies the maximum number of control plans that can be displayed in the search results section of an ACS UI dialog box.

Type: String

Optionality: Optional

Allowed: 1 through 999

Default: 200

Notes:

Example: `<property name="jnlp.acs.MAX_CONTROL_PLANS_DISPLAYED" value="200" />`

`jnlp.acs.maximiseAcScreens`

Syntax: `<property name="jnlp.acs.maximiseAcScreens" value="value" />`

Description: Specifies whether the windows in the ACS UI are opened at maximum size or optimum size.

Type: String

Optionality: Optional

Allowed:

- True
- t(rue)
- Yes
- y(es)

- 1

All other values are considered to be false.

Default: False

Notes: If set to:

- True – The windows in the ACS UI are opened at maximum size.
- False – The windows in the ACS UI are opened at optimum size.

Example: `<property name="jnlp.acs.maximiseAcScreens" value="t" />`

`jnlp.acs.paletteStyle`

Syntax: `<property name="jnlp.acs.paletteStyle" value="value" />`

Description: Specifies the style used to display the feature palette in the Control Plan Editor window. There are two possible feature palette styles:

- The floating panel style feature palette displays feature group names in a list, and the feature nodes within a selected group in a floating panel. The floating panel style enables you to quickly locate a feature node in the palette by using the Search Palette feature to filter the available feature nodes.
- The static panel style feature palette displays an expandable list of feature node groups from which you select individual feature nodes in a static panel. The Search Palette feature is not available with this style.

Type: String

Optionality: Optional

Allowed:

- old – Sets the feature palette to the static panel style.
- Not set – Sets the feature palette to the floating panel style.

Default: Floating panel style

Notes: To enable the `jnlp.acs.paletteStyle` property, clear the Java cache and the client browser cache before restarting the Control Plan Editor.

Example: `<property name="jnlp.acs.paletteStyle" value="old" />`

`jnlp.sms.port`

Syntax: `<property name="jnlp.sms.port" value="num" />`

Description: Specifies the SQL*Net port for connecting to the SMS host machine.

Type: Integer

Optionality: Optional (default used if not set)

Allowed:

Default: 1521

Notes: Set at installation

Example: `<property name="jnlp.sms.port" value="1521" />`

`jnlp.acs.ProfileN`

Syntax: `<property name="jnlp.acs.ProfileNumber" value="new_name"/>`

Description: Specifies to suppress or change the name of any of the 20 profile blocks.

Type: String

Optionality: Optional

Allowed: $1 \leq number \leq 20$

new_name is one of the following:

- – (dash): The profile block is not displayed in screens.
- String comprising any printable characters.

Default:

The following table lists default profile block names in the order in which they appear in feature node drop-down lists.

Profile1	VPN Network Profile
Profile2	VPN Station Profile
Profile3	Customer Profile
Profile4	Control Plan Profile
Profile5	Global Profile
Profile6	CLI Subscriber Profile
Profile7	Service Number Profile
Profile8	App Specific 1
Profile9	App Specific 2
Profile10	App Specific 3
Profile11	App Specific 4
Profile12	App Specific 5
Profile13	App Specific 6
Profile14	App Specific 7
Profile15	App Specific 8
Profile16	Any Valid Profile
Profile17	Temporary Storage
Profile18	Call Context
Profile19	Outgoing Extensions
Profile20	Incoming Extensions

Notes:

- If VPN is not installed, Profile1 and Profile2 are suppressed by default.
- If Charging Control Services is installed, profile block names associated with Profile8 through Profile15 are changed automatically. For more information, see *CCS Technical Guide*.
- If RCA is not installed, Profile19 and Profile20 are suppressed by default. You can make them available by installing RCA or by appending them to the `sms.jnlp` file.
- Feature nodes with writable fields cannot write into Profile16.

Examples:

```
<property name="Profile1" value="-" />
<property name="Profile6" value="Originating CLI" />
```

```
jnlp.acs.requireCustomerReference
```

Syntax:

```
<property name="jnlp.acs.requireCustomerReference"
value="value" />
```

Description:

Specifies whether a customer reference number is mandatory for each ACS customer that is created.

Type:	String
Optionality:	Optional
Allowed:	<ul style="list-style-type: none"> • True • t(rue) • Yes • y(es) • 1 <p>All other values are considered to be false.</p>
Default:	True
Notes:	<p>If set to:</p> <ul style="list-style-type: none"> • True – Customer reference numbers are mandatory for newly created ACS customers. • False – Customer reference numbers are optional for newly created ACS customers.

Example:

```
<property name="jnlp.acs.requireCustomerReference" value="f" />
```

`jnlp.acs.scfs`

Syntax:	<pre><property name="jnlp.acs.scfs" value="scfn" /></pre>
Description:	<p>Lists the network entities that are available for handover.</p> <p>The names listed in this section are used by the following feature nodes:</p> <ul style="list-style-type: none"> • TCAP Handover (as the SCP Name list) • RIMS MAP Query and IS41 Query (as the Return Address for mapping the SCCP Calling Party Address)

Type:	String
Optionality:	Optional. However, the TCAP Handover feature node must have at least one scf to work.
Allowed:	Any scf name configured in the <code>acs.conf</code> file. See <i>acsChassis SSF Configuration (SLC)</i> (on page 138).
Default:	None
Notes:	For every <code>jnlp.acs.scfs</code> property in the JNLP file, you must create a matching <code>scf</code> entry in the <code>acs.conf</code> file on each SLC defining the address associated with this entry.
Example:	<pre><property name="jnlp.acs.scfs" value="SCF_Name1,SCF_Name2" /></pre>

`jnlp.acs.SDRfastTimeoutDefault`

Syntax:	<pre><property name="jnlp.acs.SDRfastTimeoutDefault" value="secs" /></pre>
Description:	Specifies the default fast timeout period, in seconds, for the Selection Dependent Routing feature node. If the specified timeout period expires before a customer enters a digit on their telephone keypad, the feature node exits. You can use this feature, for example, to connect calls directly to the operator after timing out.
Type:	Integer
Optionality:	Optional (default used if not set)
Allowed:	Any positive integer
Default:	10
Notes:	
Example:	<pre><property name="jnlp.acs.SDRfastTimeoutDefault" value="5" /></pre>

`jnlp.sms.secureConnectionDatabaseHost`

Syntax: `<property name="jnlp.sms.secureConnectionDatabaseHost" value = "(DESCRIPTION=(ADDRESS_LIST=(ADDRESS=(PROTOCOL=type) (HOST=IPaddress) (PORT=port))) (CONNECT_DATA=(SERVICE_NAME=servicename)))" />`

Description: Specifies the connection string (including host address and port) for encrypted SSL connections to the SMF database on a non-clustered system.

To use SSL connections to the database, set *port* to 2484 and set the `jnlp.sms.EncryptedSSLConnection` property to true.

Type: String

Optionality: Optional (default used if not set)

Allowed:

Default:

Notes: If present, this property is used instead of the `jnlp.sms.databaseID` property.

Example: `<property name="jnlp.sms.secureConnectionDatabaseHost" value = "(DESCRIPTION=(ADDRESS_LIST=(ADDRESS=(PROTOCOL=TCPS) (HOST=192.0.1.1) (PORT=2484))) (CONNECT_DATA=(SERVICE_NAME=SMF)))" />`

`jnlp.sms.secureConnectionClusterDatabaseHost`

Syntax: `<property name="jnlp.sms.secureConnectionClusterDatabaseHost" value = "(DESCRIPTION=(ADDRESS_LIST=(ADDRESS=(PROTOCOL=type) (HOST=IPaddress) (PORT=port)) (ADDRESS=(PROTOCOL=type) (HOST=IPaddress) (PORT=port))) (CONNECT_DATA=(SERVICE_NAME=servicename)))" />`

Description: Specifies the connection string (including host address and port) for encrypted SSL connections to the SMF database on a clustered system.

To enable secure SSL connections to the database, set *port* to 2484 and set the `jnlp.sms.EncryptedSSLConnection` property to true.

Type: String

Optionality: Optional (default used if not set)

Allowed:

Default:

Notes: If present, this property is used instead of the `jnlp.sms.secureConnectionDatabaseHost` property.

Example: `<property name="jnlp.sms.secureConnectionClusterDatabaseHost" value = "(DESCRIPTION=(ADDRESS_LIST=(ADDRESS=(PROTOCOL=TCPS) (HOST=192.0.1.1) (PORT=2484)) (ADDRESS=(PROTOCOL=TCP) (HOST=192.0.2.1) (PORT=2484))) (CONNECT_DATA=(SERVICE_NAME=SMF)))" />`

`jnlp.acs.showAnnouncementSource`

Syntax: `<property name="jnlp.acs.showAnnouncementSource" value="value" />`

Description: Specifies whether announcement sources (i.e., the resource name and resource ID) are displayed next to announcement names in ACS UI windows.

Type: String
Optionality: Optional
Allowed:

- TRUE
- true
- YES
- yes
- Y
- y

All other values are considered to be false.

Default: True
Notes: If set to:

- True – Announcement sources are displayed.
- False – Announcement sources are not displayed.

Example: `<property name="jnlp.acs.showAnnouncementSource" value="f" />`

`jnlp.acs.showCallPlanCopy`

Syntax: `<property name="jnlp.acs.showCallPlanCopy" value="value" />`
Description: Specifies whether the **Copy** button is enabled on the ACS Numbers screen.
Type: String
Optionality: Optional
Allowed:

- True
- t(rue)
- Yes
- y(es)
- 1

All other values are considered to be false.

Default: True
Notes: If set to:

- True – The **Copy** button is enabled.
- False – The **Copy** button is disabled.

Example: `<property name="jnlp.acs.showCallPlanCopy" value="f" />`

`jnlp.acs.showNetwork`

Syntax: `<property name="jnlp.acs.showNetwork" value="value" />`
Description: Specifies whether the **Network** field is displayed in the ACS New Customer dialog box.
Type: String
Optionality: Optional
Allowed:

- True
- t(rue)
- Yes
- y(es)
- 1

All other values are considered to be false.

Default: True

- Notes:** If set to:
- True – The **Network** field is displayed.
 - False – The **Network** field is not displayed.
- Example:** `<property name="jnlp.acs.showNetwork" value="f" />`
- `jnlp.acs.ssfs`
- Syntax:** `<property name="jnlp.acs.ssfs" value="ssf1,ssf2,...,ssfn" />`
- Description:** Lists the switches that are available in the IN network.
The switches listed in this section are used by the Call Initiation feature node (as the switch name list).
- Type:** String
- Optionality:** Optional. However, the Call Initiation feature node must have at least one scf to work.
- Allowed:** Any ssf name configured in the `acs.conf` file. See *acsChassis SSF Configuration (SLC)* (on page 138).
- Default:** None
- Notes:**
- Example:** `<property name="jnlp.acs.ssfs" value="SSF_Name1,SSF_Name2" />`
- `jnlp.sms.sslCipherSuites`
- Syntax:** `<property name = "jnlp.sms.sslCipherSuites" value="(TLS_RSA_WITH_AES_128_CBC_SHA)" />`
- Description:** Specifies the cipher suites to use for SSL encryption. You must set this property if you are using encrypted SSL for connecting to the SMS database.
- Type:** String
- Optionality:** Optional (default used if not set)
- Allowed:** (TLS_RSA_WITH_AES_128_CBC_SHA)
- Default:** (TLS_RSA_WITH_AES_128_CBC_SHA)
- Notes:** You must also set the SSL_CIPHER_SUITES property to (TLS_RSA_WITH_AES_128_CBC_SHA) in the `listener.ora` and `sqlnet.ora` files.
- Example:** `<property name = "jnlp.sms.sslCipherSuites" value="(TLS_RSA_WITH_AES_128_CBC_SHA)" />`
- `jnlp.acs.suppressedSDRDigits`
- Syntax:** `<property name="jnlp.acs.suppressedSDRDigits" value="digits" />`
- Description:** The Selection Dependent Routing feature node allows you to route calls based on the number, letter, or special character entered on the caller's telephone keypad.
You use the `jnlp.acs.suppressedSDRDigits` property to prevent users from assigning specified digits to a calling route and to exclude those digits from the Configure Selection Dependent Routing dialog box of the ACS Control Plan Editor.
- Type:** String
- Optionality:** Optional
- Allowed:**
- Numbers ranging from 0 (zero) through 9
 - Letters ranging from A through F
 - Special characters * and #

Default: None

Notes:

Example: `<property name="jnlp.acs.suppressedSDRDigits" value="12ab" />`

`jnlp.acs.SuppressTagID`

Syntax: `<property name="jnlp.acs.SuppressTagID" value="value" />`

Description: Specifies to not include the profile tag value when displaying a profile field name in the ACS Control Plan Editor.

For example, when `jnlp.acs.SuppressTagID` is set to:

- `true` – The profile tag 196613 displays the name "PIN Prefix"
- `false` – The profile tag 196613 displays the name "PIN Prefix (196613)"

Type: Boolean

Optionality: Optional

- Allowed:**
- `True`
 - `t(rue)`
 - `Yes`
 - `y(es)`
 - `1`

All other values are considered to be `false`

Default: `True`

Notes: If set to:

- `True` – Only the profile field name is displayed.
- `False` – Both the profile field name and the profile field value is displayed.

Example: `<property name="jnlp.acs.SuppressTagID" value="True" />`

`jnlp.trace`

Syntax: `<property name="jnlp.trace" value="value" />`

Description: Specifies whether to enable tracing for the Control Plan Editor. The output is displayed in the Java Console.

Type: Boolean

Optionality: Optional (default used if not set)

Allowed: `on` | `off`, `true` | `false`, `yes` | `no`, `1` | `0`, `enabled` | `disabled`

Default: `Off`

Notes:

Example: `<property name="jnlp.trace" value="on" />`

`jnlp.sms.TZ`

Syntax: `<property name="jnlp.sms.TZ" value="timezone" />`

Description: Specifies the time zone used for all time and date values displayed in Convergent Charging Controller UI windows.

Type: String

Optionality: Optional (default used if not set)

Allowed: Any Java supported time zone.

Default: `GMT`

Notes: For a full list of Java supported time zones, see *Time Zones* (on page 205).

Example: `<property name="jnlp.sms.TZ" value="GMT" />`

`jnlp.acs.updateCPReferences`

Syntax:	<code><property name="jnlp.acs.updateCPReferences" value="value" /></code>
Description:	When you update a control plan, the Control Plan Editor creates a new version of the control plan. If any customers are scheduled to use the older version of the control plan, the customers' service numbers or CLIs remain attached to the older version by default. This property specifies whether you can attach customers' service numbers or CLIs to the new control plan version.
Type:	String
Optionality:	Optional
Allowed:	<ul style="list-style-type: none"> • True • t(rue) • Yes • y(es) • 1 <p>All other values are considered to be false.</p>
Default:	None
Notes:	<p>If set to:</p> <ul style="list-style-type: none"> • True – After an updated control plan compiles successfully, the Control Plan Editor prompts you to select the service numbers or CLIs to attach to the new control plan version. • False – The existing service numbers or CLIs remain attached to the older version of the content plan.
Example:	<code><property name="jnlp.acs.updateCPReferences" value="t" /></code>

`jnlp.ccs.UseAnnouncements`

Syntax:	<code><property name="jnlp.ccs.UseAnnouncements" value="value" /></code>
Description:	Specifies whether to play announcements.
Type:	String
Optionality:	Optional
Allowed:	<ul style="list-style-type: none"> • True • t(rue) • Yes • y(es) • 1 <p>All other values are considered to be false.</p>
Default:	False
Notes:	
Example:	<code><property name="jnlp.ccs.UseAnnouncements" value="Yes" /></code>

`jnlp.acs.useTNForNodeName`

Syntax:	<code><property name="jnlp.acs.useTNForNodeName" value="value" /></code>
Description:	<p>Specifies whether the feature node name displayed in the Control Plan Editor window is the Termination Number (TN). This applies to the following feature nodes only:</p> <ul style="list-style-type: none"> • Attempt Termination (AT) • Unconditional Termination (UT) <p>The TN is displayed for any UT or AT feature node in the CPE window, without requiring you to save each feature node to update the stored control plan data.</p>
Type:	Boolean
Optionality:	Optional (default used if not set)
Allowed:	<ul style="list-style-type: none"> • True • t(rue) • Yes • y(es) • 1 <p>All other values are considered to be false.</p>
Default:	False
Notes:	<p>If set to:</p> <ul style="list-style-type: none"> • True – The feature node name is displayed as the TN in the CPE window. • False – The feature node name is displayed as the stored feature node name in the CPE window. <p>You can update the TN for these feature nodes in a control plan by using the ACS Numbers screen. See the discussion about Editing Termination Numbers in <i>ACS User's Guide</i> for more information.</p>
Example:	<code><property name="jnlp.acs.useTNForNodeName" value="true" /></code>

`jnlp.acs.warnAboutUnfilledExits`

Syntax:	<code><property name="jnlp.acs.warnAboutUnfilledExits" value="True" /></code>
Description:	<p>Specifies whether a control plan passes validation if any of its feature nodes are missing exits.</p> <p>This property has a dependency on the <code>endUnlinkedExits</code> parameter. For more information, see <i>endUnlinkedExits</i> (on page 84).</p>
Type:	String
Optionality:	Optional
Allowed:	<ul style="list-style-type: none"> • True • t(rue) • Yes • y(es) • 1 <p>All other values are considered to be false.</p>
Default:	False
Notes:	<p>If set to:</p> <ul style="list-style-type: none"> • True – Control plans that are missing feature node exits will pass validation. To work, you must also set the <code>endUnlinkedExits</code> parameter to 1. • False – Control plans that are missing node exits will fail during validation.
Example:	<code><property name="jnlp.acs.warnAboutUnfilledExits" value="True" /></code>

Example JNLP Application Properties

Here is an example `acs.jnlp` file showing the application property settings at installation.

```
<jnlp spec="1.0+"
  codebase="http://HOST_IP_ADDR/"
  href="acs.jnlp" >
  .
  .
  .
  <resources>
    <j2se version="1.8.0+" href="http://java.sun.com/products/autodl/j2se" />
    <property name="jnlp.packEnabled" value="true"/>
    <jar href="sms.sig.jar" />
    <jar href="acs.sig.jar" main="true" />
    <jar href="common.sig.jar" />
    <jar href="ojdbc7.sig.jar" />
    <jar href="oraclepki.sig.jar" />
    <jar href="ohj.sig.jar" />
    <jar href="help-share.sig.jar" />
    <jar href="oracle_ice.sig.jar" />
    <jar href="jwt.sig.jar" />
    <jar href="share.sig.jar" />
    <jar href="osd.sig.jar" />
    <jar href="rims.sig.jar" />
    <jar href="xms.sig.jar" />
    <jar href="ses.sig.jar" />
    <property name="java.util.Arrays.useLegacyMergeSort" value="true" />
    <property name="jnlp.sms.TZ" value="GMT" />
    <property name="jnlp.sms.host" value="HOST_IP_ADDR" />
    <property name="jnlp.sms.port" value="1521" />
    <property name="jnlp.sms.database" value="SMF" />
    <property name="jnlp.sms.secureConnectionDatabaseHost" value="(DESCRIPTION=
    (ADDRESS_LIST= (ADDRESS=(PROTOCOL=TCPS) (HOST=HOST_IP_ADDR) (PORT=2484)))
    (CONNECT_DATA= (SERVICE_NAME=SMF)))" />
    <property name="jnlp.sms.EncryptedSSLConnection" value="true" />
    <property name="jnlp.sms.sslCipherSuites"
    value="(TLS_RSA_WITH_AES_128_CBC_SHA)" />
    <property name="jnlp.acs.SuppressTagID" value="TRUE" />
    <property name="jnlp.acs.Profile8" value="Account Reference Profile" />
    <property name="jnlp.acs.Profile9" value="Product Type Profile" />
    <property name="jnlp.acs.Profile10" value="Control Plan Profile (App 3)" />
    <property name="jnlp.acs.Profile12" value="CCS Global Profile" />
    <property name="jnlp.acs.Profile13" value="CCS Temporary Profile (App 6)" />
    <property name="jnlp.acs.Profile14" value="CCS Temporary Profile (App 7)" />
    <property name="jnlp.acs.Profile15" value="CCS Temporary Profile (App 8)" />
    <property name="jnlp.acs.ACSDefaultCustomerIsPrepaid" value="false" />
  </resources>

  <application-desc main-class="com.g8labs.acs.coreScreens.Application" />
</jnlp>
```

Configuring the `eserv.config`

Overview

Introduction

This chapter explains how to configure the ACS section of the `eserv.config`.

In this chapter

This chapter contains the following topics.

<code>eserv.config</code> Configuration.....	45
ACS Configuration in the <code>eserv.config</code> File.....	46
MRC Configuration	70

`eserv.config` Configuration

Introduction

The `eserv.config` file is a shared configuration file, from which many Oracle Communications Convergent Charging Controller applications read their configuration. Each Convergent Charging Controller machine (SMS, SLC, and VWS) has its own version of this configuration file, containing configuration relevant to that machine. The `eserv.config` file contains different sections; each application reads the sections of the file that contains data relevant to it.

The `eserv.config` file is located in the `/IN/service_packages/` directory.

The `eserv.config` file format uses hierarchical groupings, and most applications make use of this to divide the options into logical groupings.

Configuration File Format

To organize the configuration data within the `eserv.config` file, some sections are nested within other sections. Configuration details are opened and closed using either `{ }` or `[]`.

- Groups of parameters are enclosed with curly brackets – `{ }`
- An array of parameters is enclosed in square brackets – `[]`
- Comments are prefaced with a `#` at the beginning of the line

To list things within a group or an array, elements must be separated by at least one comma or at least one line break. Any of the following formats can be used, as in this example:

```
{ name="route6", id = 3, prefixes = [ "00000148", "0000473" ] }
{ name="route7", id = 4, prefixes = [ "000001049" ] }
```

or

```
{ name="route6"
  id = 3
  prefixes = [
    "00000148"
    "0000473"
  ]
}
```

```
}
{ name="route7"
  id = 4
  prefixes = [
    "000001049"
  ]
}
```

or

```
{ name="route6"
  id = 3
  prefixes = [ "00000148", "0000473" ]
}
{ name="route7", id = 4
  prefixes = [ "000001049" ]
}
```

Editing the File

Open the configuration file on your system using a standard text editor. Do not use text editors, such as Microsoft Word, that attach control characters. These can be, for example, Microsoft DOS or Windows line termination characters (for example, ^M), which are not visible to the user, at the end of each row. This causes file errors when the application tries to read the configuration file.

Always keep a backup of your file before making any changes to it. This ensures you have a working copy to which you can return.

eserv.config Files Delivered

Most applications come with an example `eserv.config` configuration in a file called `eserv.config.example` in the root of the application directory, for example, `/IN/service_packages/eserv.config.example`.

ACS Configuration in the `eserv.config` File

ACS Section in `eserv.config`

The ACS section is part of the `eserv.config` file. See Example ACS configuration in `eserv.config` for a detailed example of the parameters.

Reread the configuration by sending a SIGHUP to `slee_acs`.

Here is the high-level structure of the section.

```
ACS = {
  countryCodes = [codes]

  macroNodes = {
    macronodes_parameters
  }

  tracing = {
    tracing_parameters
  }

  acsChassisActions = {
    acsChassisActions_parameters
  }

  SessionTimeInformation = {
    SessionTimeInformation_parameters
  }

  ServiceEntries = [
```

```

    {
        ServiceEntries_parameters
    }
]

acsTriggerIF = {
    acsTriggerIF_parameters
}

AdditionalCheckMOLIPrefix = {
    checkMOLIPrefixes_parameters
}

FCI = {
    FCI_parameters
}

NP = {
    NP_parameters
}
}

```

countryCodes

Syntax: `countryCodes = [codes]`

Description: The list of country codes supported for location number normalization.

Type: Array

Optionality: Optional (default used if not set)

Allowed: International country codes

Default:

Notes: This is used when roaming to determine the location of the caller and add country code to called number if appropriate.

Example:

```

countryCodes = [
    "61" # Australia
    "64" # New Zealand
    "65" # Singapore
    "44" # United Kingdom
    "1" # USA/Canada
]

```

macroNodes Configuration

The `macroNodes` configuration in the `ACS` section of the `eserv.config` supports configuration of ACS feature nodes.

Here is an example of the `macroNodes` section.

```

macroNodes = {
    ATPD = {
        ReleaseInApplyCharging = true
    }
}

```

ReleaseInApplyCharging

Syntax: `ReleaseInApplyCharging = true|false`

Description: Used in ATPD (Attempt Terminate to Pending TN with Duration) feature nodes to send a TCAP Disconnect(2) operation instead of a TCAP Release operation.

Type: Boolean
Optionality: Optional (default used if not set)
Allowed: true, false
Default: true
Notes:
Example: `ReleaseInApplyCharging = false`

Tracing Configuration

The ACS configuration supports the following tracing parameters.

```
tracing = {  
    enabled = true  
    origAddress = [  
        "0064212",  
        "0064213",  
        "0064214"  
    ]  
    destAddress = [  
        "0064213",  
        "0064214"  
    ]  
    traceDebugLevel = "all"  
}
```

enabled

Syntax: `enabled = true|false`
Description: Enables the tracing functionality.
Type: Boolean
Optionality: Optional, default used if not set.
Allowed: true, false
Default: false
Notes: Turning on tracing may dramatically increase system load. Only turn on in a production system if you have specified very limited tracing.
Example: `enabled = true`

origAddress

Syntax: `origAddress = ["address1","address2",...,"addressN"]`
Description: A list of Originating Addresses to trace.
Type: Array of number strings
Optionality: Optional
Allowed: The full originating address number.
Default: None
Notes: This may be an empty array list [], however to trace anything there must be at least one address in either the `origAddress` or `destAddress` parameters.
Example: `origAddress = ["0064212","0064213","0064214"]`

destAddress

Syntax: `destAddress = ["address1","address2",...,"addressN"]`
Description: A list of Destination Addresses to trace.
Type: Array of number strings

Optionality:	Optional
Allowed:	The full destination address number.
Default:	None
Notes:	This may be an empty array list [], however to trace anything there must be at least one address in either the <code>origAddress</code> or <code>destAddress</code> parameters.
Example:	<code>destAddress = ["0064213", "0064214"]</code>

`traceDebugLevel`

Syntax:	<code>traceDebugLevel = "flag1[, flag2, ...]"</code>																		
Description:	Identifies the debug level for the addresses being traced.																		
Type:	String																		
Optionality:	Required (if <code>enabled=true</code>)																		
Allowed:	Any valid flag. A useful method of finding which flags are relevant to the tracing you want to do is to: <ol style="list-style-type: none"> 1 Run your call on a model environment with <code>DEBUG=all</code> Result: Debug will report all relevant sections. 2 Check through the debug and identify which sections to report or suppress. 3 Change the debug settings. 4 Rerun the call. 																		
Default:	"all,-COMMON_escher_detail,-COMMON_escher_dump,-slee_api,-cmnTimeout,-cmnCacheDetail,-Config,-beVWARS_detail,-beSyncDetail"																		
Notes:	<code>traceDebugLevel = flag</code> turns only <code>flag</code> on. <code>traceDebugLevel=all,-flag,-flag2</code> turns all debug on, and then turns <code>flag</code> and <code>flag2</code> off. Any section can be removed from the trace by preceding with a minus sign. The output columns are also configurable, and can be turned off. By default the columns are: <code>date file line pid section message</code> Columns in output are: <table> <tr> <td>*</td> <td><code>display:name</code></td> <td>the program name registered with <code>cmnErrorSetProgram()</code>, off by default</td> </tr> <tr> <td>*</td> <td><code>display:date</code></td> <td>the date in YYYY/MM/DD HH:MM:SS format</td> </tr> <tr> <td>*</td> <td><code>display:file</code></td> <td>the source filename</td> </tr> <tr> <td>*</td> <td><code>display:line</code></td> <td>the source line number</td> </tr> <tr> <td>*</td> <td><code>display:pid</code></td> <td>the process ID</td> </tr> <tr> <td>*</td> <td><code>display:section</code></td> <td>the debug section</td> </tr> </table>	*	<code>display:name</code>	the program name registered with <code>cmnErrorSetProgram()</code> , off by default	*	<code>display:date</code>	the date in YYYY/MM/DD HH:MM:SS format	*	<code>display:file</code>	the source filename	*	<code>display:line</code>	the source line number	*	<code>display:pid</code>	the process ID	*	<code>display:section</code>	the debug section
*	<code>display:name</code>	the program name registered with <code>cmnErrorSetProgram()</code> , off by default																	
*	<code>display:date</code>	the date in YYYY/MM/DD HH:MM:SS format																	
*	<code>display:file</code>	the source filename																	
*	<code>display:line</code>	the source line number																	
*	<code>display:pid</code>	the process ID																	
*	<code>display:section</code>	the debug section																	
Examples:	The parameter string value must be enclosed in quotes. <code>traceDebugLevel="all"</code> Traces everything for the original and or destination addresses. <code>traceDebugLevel="cmnConfig,slee_api"</code> Traces <code>cmnConfig</code> and <code>slee_api</code> sections for the original and or destination addresses. <code>traceDebugLevel="all,-cmnEscher"</code> Traces everything except <code>cmnEscher</code> section for the original and or destination addresses. <code>traceDebugLevel="all,-cmnEscher,-display:file"</code> Traces everything except <code>cmnEscher</code> section for the original and or destination addresses, and removes the file column from the output.																		

acsChassisActions Configuration

Here is an example of the `acsChassisActions` configuration of the ACS section of the `eserv.config`.

```
acsChassisActions = {
    mscAddressForEdr = [
        {
            mscAddress = "123456789"
            encoding = "BCD"
        },
        {
            mscAddress = "987654321"
            encoding = "ASCII"
        }
    ]
}
```

encoding

Syntax:	<code>encoding = "code"</code>
Description:	The encoding of the MSC address
Type:	String
Optionality:	Optional
Allowed:	Values: <ul style="list-style-type: none"> • "BCD" (Binary Coded Decimal) • "ASCII"
Default:	BCD
Notes:	Member of <code>mscAddressForEdr</code> (on page 50) array
Example:	<code>encoding = "BCD"</code>

mscAddress

Syntax:	<code>mscAddress = "addr"</code>
Description:	The MSC address (in the <code>CallReferenceNumber</code>)
Type:	String
Optionality:	Optional
Allowed:	
Default:	
Notes:	Member of <code>mscAddressForEdr</code> (on page 50) array
Example:	<code>mscAddress = "123456789"</code>

mscAddressForEdr

Syntax:	<code>mscAddressForEdr = [addr_parameters]</code>
Description:	Array of MSC addresses and their encoding. This is used by the Add EDR Field chassis action.
Type:	Array
Optionality:	Optional (default used if not set).
Allowed:	
Default:	All <code>mscAddresses</code> are encoded as BCD.
Notes:	

```

Example:      mscAddressForEdr = [
                {
                    mscAddress = "123456789"
                    encoding = "BCD"
                }
            ]

```

SessionTimeInformation Configuration

The `SessionTimeInformation` configuration in the `ACS` section of the `eserv.config` supports the facility for the processing of session time information for inbound interfaces such as EDR post processing control agents.

Here is an example of the section.

```

SessionTimeInformation = {
    STIServiceKey = 122
    IDPExtTypeEDRId = 901
    extractEdrId = true
    IDPExtTypeCallStartTime = 902
    extractCallStartTime = true
    callStartTimeFormat = "YYYYMMDDHH24MISS"
    IDPExtTypeCallAnswerTime = 903
    extractCallAnswerTime = true
    callAnswerTimeFormat = "YYYYMMDDHH24MISS"
    IDPExtTypeCallEndTime = 904
    extractCallEndTime = true
    callEndTimeFormat = "YYYYMMDDHH24MISS"
    IDPExtTypeEDRTimeZone = 905
    extractEdrTimeZone = true
}

```

callAnswerTimeFormat

Syntax: `callAnswerTimeFormat = "format"`
Description: Specifies the format of the call answer time string
Type: String
Optionality: Optional (default used if not set).
Allowed:
Default: "YYYYMMDDHH24MISS"
Notes:
Example: `callAnswerTimeFormat = "YYYYMMDDHH24MISS"`

callEndTimeFormat

Syntax: `callEndTimeFormat = "format"`
Description: The format of call end time time string.
Type: String
Optionality: Optional (default used if not set).
Allowed:
Default: "YYYYMMDDHH24MISS"
Notes:
Example: `callEndTimeFormat = "YYYYMMDDHH24MISS"`

callStartTimeFormat

Syntax: `callStartTimeFormat = "format"`
Description: The format of call start time time string.
Type: String
Optionality: Optional (default used if not set).
Allowed:
Default: "YYYYMMDDHH24MISS"
Notes:
Example: `callStartTimeFormat = "YYYYMMDDHH24MISS"`

extractCallAnswerTime

Syntax: `extractCallAnswerTime = true|false`
Description: Enable or disable extraction of call answer time from IDP extension.
Type: Boolean
Optionality: Optional (default used if not set).
Allowed: true, false
Default: true
Notes:
Example: `extractCallAnswerTime = true`

extractCallEndTime

Syntax: `extractCallEndTime = true|false`
Description: Enable or disable extraction of EDR ID from IDP extension
Type: Boolean
Optionality: Optional (default used if not set).
Allowed: true, false
Default: true
Notes:
Example: `extractCallEndTime = true`

extractCallStartTime

Syntax: `extractCallStartTime = true|false`
Description: Enable or disable extraction of call start time from IDP extension
Type: Boolean
Optionality: Optional (default used if not set).
Allowed: true, false
Default: true
Notes:
Example: `extractCallStartTime = true`

extractEdrId

Syntax: `extractEdrId = true|false`
Description: Enable or disable extraction of EDR ID from IDP extension.
Type: Boolean
Optionality: Optional (default used if not set).

Allowed: true, false
Default: true
Notes:
Example: `extractEdrId = true`

`extractEdrTimeZone`

Syntax: `extractEdrTimeZone = true|false`
Description: Enable or disable extraction of timezone from IDP extension
Type: Boolean
Optionality: Optional (default used if not set).
Allowed: true, false
Default: true
Notes:
Example: `extractEdrTimeZone = true`

`IDPExtTypeCallAnswerTime`

Syntax: `IDPExtTypeCallAnswerTime = id`
Description: The ID of IDP Extension in which the call answer time is passed to ACS.
Type: Integer
Optionality: Optional (default used if not set).
Allowed:
Default: 903
Notes:
Example: `IDPExtTypeCallAnswerTime = 903`

`IDPExtTypeCallEndTime`

Syntax: `IDPExtTypeCallEndTime = value`
Description: The ID of IDP Extension in which the Call end time is passed to ACS.
Type: Integer
Optionality: Optional (default used if not set).
Allowed:
Default: 904
Notes:
Example: `IDPExtTypeCallEndTime = 904`

`IDPExtTypeCallStartTime`

Syntax: `IDPExtTypeCallStartTime = id`
Description: The ID of IDP Extension in which the call start time is passed to ACS.
Type: Integer
Optionality: Optional (default used if not set).
Allowed:
Default: 901
Notes:
Example: `IDPExtTypeCallStartTime = 902`

IDPExtTypeEDRId

Syntax:	IDPExtTypeEDRId = <i>id</i>
Description:	The ID of IDP Extension in which the EDR ID is passed to ACS.
Type:	Integer
Optionality:	Optional (default used if not set).
Allowed:	
Default:	901
Notes:	
Example:	IDPExtTypeEDRId = 901

IDPExtTypeEDRTimezone

Syntax:	IDPExtTypeEDRTimezone = <i>id</i>
Description:	The ID of IDP Extension in which the timezone is passed to ACS
Type:	Integer
Optionality:	Optional (default used if not set).
Allowed:	
Default:	901
Notes:	
Example:	IDPExtTypeEDRTimezone = 905

STIServiceKey

Syntax:	STIServiceKey = <i>sk</i>
Description:	The service key on which session time based (offline) calls are to be expected.
Type:	Integer
Optionality:	Optional (default used if not set).
Allowed:	
Default:	0 - set to 0 to disable session data processing
Notes:	This must match the service key in slee.cfg that you wish to run this service for on slee_acs .
Example:	STIServiceKey = 122

ServiceEntries Configuration

You can optionally define ServiceEntries configuration in the ACS section of the **eserv.config** file to configure ACS services that will be handled by the specified service libraries. Each entry in the ServiceEntries array defines the service loaders that a particular service handle should use, and also defines how number selection should work for the service handle. This method of defining service entries has the same purpose as configuring ServiceEntry lines in the **acs.conf** configuration file, but it has the following advantages:

- The configuration is easy to read
- The configuration is very flexible because you can specify a list of service libraries for each service library function

Important: Each service entry must be configured either in **eserv.config** or in **acs.conf** but not in both. For more information about configuring service entries in **acs.conf**, see *acsChassis ServiceEntry Configuration* (on page 123).

Here is an example of the ServiceEntries configuration:

```
ServiceEntries = [
```

```

{
  ServiceName = "MyTestService"

  Methods = {
    acsChassisInitSL = [ "lib1.so", "lib2.so", "lib3.so" ]
    acsChassisLoadService = [ "lib1.so", "lib3.so" ]
    acsChassisPrePOR = [ "lib2.so", "lib1.so" ]
    acsChassisCallTerminated = [ "lib1.so" ]
    acsChassisPreCTR = [ "lib1.so" ]
    acsChassisPreETC = [ "lib1.so" ]
  }

  AddressSources = {
    NetworkCP = [
      { source = "callingPartyNumber", screening = "network" }
      { source = "callingPartyNumber", screening = "user" }
      { source = "additionalCallingPartyNumber", screening = "network" }
      { source = "additionalCallingPartyNumber", screening = "user" }
      { source = "extensionNumber", extension=4 }
      { source = "cellIDorLAI" }
      { source = "Empty" }
    ]
    LogicalCP = [
      { source = "callingPartyNumber", screening = "user" }
      { source = "callingPartyNumber", screening = "network" }
    ]
  }
}
]

```

AddressSources

Syntax:	<code>AddressSources = [AddressSources_parameters]</code>
Description:	Lists the sources used to populate various ACS buffers that may then be used by the service loader, chassis actions, or control plan. For a list of allowed values, see Allowed.
Type:	Array
Optionality:	Optional (default used if not set)
Allowed:	Use: <ul style="list-style-type: none"> • <code>NetworkCP</code> – To specify the sources for the network calling party number • <code>LogicalCP</code> – To specify the sources for the logical calling party number • <code>ConnectDRA</code> – To specify the sources for the default destination routing address to put in a Connect operation, and also the default pending termination number • <code>ConnectCLI</code> – To specify the sources for the calling party ID in a Connect operation • <code>RedirectingParty</code> – To specify the sources for the redirecting party ID in a Connect operation • <code>OriginalCP</code> – To specify the sources for the original called party ID in a Connect operation
Default:	
Notes:	

Example:

```

AddressSources = {
  NetworkCP = [
    { source = "callingPartyNumber", screening =
      "network" }
    { source = "callingPartyNumber", screening = "user" }
  ]
  LogicalCP = [
    { source = "callingPartyNumber", screening =
      "network" }
    { source = "callingPartyNumber", screening = "user" }
  ]
}

```

Methods

Syntax:

```
Methods = {Methods_parameters}
```

Description:

Array of ACS chassis functions that may be invoked by the service, and the service libraries to associate with each function.

Type:

Array

Optionality:

Required

Allowed:

You must specify the following required ACS chassis functions:

- `acsChassisInitSL()` – Invoked by ACS chassis when it loads the shared library at startup time. You use this function to initialize global variables, and read configuration tables and files.

Note: You must include the full list of libraries that will be loaded by the service in the definition for the `acsChassisInitSL()` function.

- `acsChassisLoadService()` – Invoked by ACS chassis at the beginning of a new session, call, or event, that the network starts.

You can specify one or more of the following optional ACS chassis functions:

- `acsChassisPrePOR()` – Called by ACS when a feature node within the control plan requests a specific network action or when `acsChassisLoadService()` returns a response that causes a specific network action.
- `acsChassisCallTerminated()` – Performs post-call cleanup when a call has been terminated
- `acsChassisPreCTR()` – Controls the FurnishChargingInformation (FCI) and SendChargingInformation (SCI) that is sent with outbound Connect To Resource (ETC) or ReleaseCall operations
- `acsChassisPreETC()` – Controls the FurnishChargingInformation (FCI) and SendChargingInformation (SCI) that is sent with outbound EstablishTemporaryConnect (ETC) operations

For more information about the allowed functions, see *SDK Developer's Guide*.

Notes:

The service libraries specified for a function run in list order. For example, to run the `acsChassisLoadService()` function first from `ccsSvcLibrary.so`, and then from `libmyServiceExample1.so`, specify the following configuration:

```

acsChassisLoadService = [ "ccsSvcLibrary.so",
  "libmyServiceExample1.so" ]

```

Example:

```

Methods = [
  {
    acsChassisInitSL = [ "ccsSvcLibrary.so",
      "libmyServiceExample1.so" ]
    acsChassisLoadService = [
      "ccsSvcLibrary.so", "libmyServiceExample1.so" ]
    acsChassisPrePOR = ["libmyServiceExample1.so"]
    acsChassisCallTerminated = [ "libServiceExample1.so" ]
  }
]

```

ServiceName

Syntax: `ServiceName = "str"`

Description: The name of the service that will be handled by the service libraries specified in the `Methods` section.

Type: String

Optionality: Required

Allowed:

Default:

Notes:

Example: `ServiceName = "MyTestService"`

screening

Syntax: `screening = "user|network"`

Description: Sets the screening indicator for the source number to either user provided, or network provided.

Type: Boolean

Optionality: Required

Allowed: user or network

Default:

Notes:

Example: `screening = "user"`

source

Syntax: `source = "str"`

Description: Sets the ACS buffer to use for this variable in the `AddressSources` list. For more information address sources, see *acsChassis ServiceEntry Configuration* (on page 123).

Type: String

Optionality: Required

- Allowed:** Use any of the following values:
- callingParty
 - firstRedirectingParty – This is the original called party ID from the IDP
 - lastRedirectingParty – This is the redirecting party ID from the IDP
 - additionalCallingParty
 - imsi
 - cellIDorLAI
 - locationNumber
 - mscAddress
 - locationInfoLocationNumber
 - calledParty
 - vlrNumber
 - Empty
 - extensionNumber – You configure the extension number by using the following configuration format. `source = "extensionNumber"`, `extension = int`, where `int` is a value between 0 and 9.
- Notes:** When ACS populates a buffer, ACS searches the list of number sources until it finds one that matches in the IDP. If ACS does not find a match then the buffer is left blank.
- Example:** `source = "callingPartyNumber"`

acsTriggerIF Configuration

Oracle Communications Billing and Revenue Management (BRM) is able to trigger notifications off the back of the AAA opcodes which drive the real-time charging interaction. The Convergent Charging Controller architecture takes advantage of the BRM In-Session Notifications by triggering control plans at the point they are received. See *BRM Charging Driver Technical Guide* for details on in-session notification mapping from BRM to Convergent Charging Controller.

See the *Triggers* topic in *ACS User's Guide* for control plan trigger definitions.

The ACS SLEE interface (acsTriggerIF) generates an IDP to trigger a control plan on receipt of a SLEE event containing control plan trigger details and IDP data.

Here is an example of the acsTriggerIF section.

```
acsTriggerIF = {
  # sleeInterfaceName = "acsTriggerIF"
  # sleeServiceKey = 1
  # overrideSleeServiceKey = 0
  # inapServiceKey = 1
  # statisticsEnabled = true
  # noActivitySleepTime = 10000
  # triggerTimeOutSecs = 10
  deleteTagsAfterTrigger = [
    1312070, # ISN Balance
    1312052, # ISN Credit Threshold Balance
    1312075, # ISN Failure Reason
    1312074, # ISN Lifecycle State
    1312050, # ISN Preferred Channel
    1312051, # ISN Preferred Time
    1312073, # ISN Rating Status
    1312068, # ISN Streaming Threshold
    1312066 # ISN Subscription Expiry
  ]
  numberRules = [
```

```

    { prefix="", min=0, max = 100, remove=0, prepend="", resultNoa=4 }
  ]
}

```

deleteTagsAfterTrigger

Syntax: deleteTagsAfterTrigger = [tags]

Description: List of profile tags which should be deleted after they are sent in a trigger event.

Type: Array

Optionality: Optional (default used if not set)

Allowed: Valid profile tags, matching those defined in the `bcdActionHandler.InSessionNotificationMapping` section of `eserv.config`. See *BRM Charging Driver Technical Guide*.

Default: []

Notes: Not specified means no tags will be deleted.

Example:

```

deleteTagsAfterTrigger = [
    1312070, # ISN Balance
    1312052, # ISN Credit Threshold Balance
    1312075, # ISN Failure Reason
    1312074, # ISN Lifecycle State
    1312050, # ISN Preferred Channel
    1312051, # ISN Preferred Time
    1312073, # ISN Rating Status
    1312068, # ISN Streaming Threshold
    1312066 # ISN Subscription Expiry
]

```

inapServiceKey

Syntax: inapServiceKey = int

Description: The INAP service key that `acsTriggerIF` should use for generated IDP messages if not specified by the trigger event data.

Type: Integer

Optionality: Optional (default used if not set)

Allowed:

Default: 1

Notes:

Example: inapServiceKey = 1

noActivitySleepTime

Syntax: noActivitySleepTime = usecs

Description: Period (microseconds) to sleep if no activity detected by last poll.

Type: Integer

Optionality: Optional (default used if not set)

Allowed:

Default: 10000

Notes: Zero (0) means no sleep.

Example: noActivitySleepTime = 10000

numberRules

Syntax: `numberRules = [rules]`

Description: Rules for denormalizing numbers to send to `slee_acs` in an IDP.

Type: Array

Optionality: Optional (default used if not set)

Allowed:

Default: no rules applied

Notes: The rule below assumes that all numbers in trigger events start with a country code# and should be sent in international format (NOA= 4).

Example:

```
numberRules = [
    { prefix="", min=0, max = 100, remove=0, prepend="",
      resultNoa=4 }
]
```

overrideSleeServiceKey

Syntax: `overrideSleeServiceKey = int`

Description: The SLEE service key that `acsTriggerIF` should *always* send generated IDP messages to. This overrides the `sleeServiceKey` config option and the trigger event data.

Type: Integer

Optionality: Optional (default used if not set)

Allowed:

Default: 0

Notes: Zero (0) means no override.

Example: `overrideSleeServiceKey = 0`

sleeInterfaceName

Syntax: `sleeInterfaceName = "IFName"`

Description: The SLEE interface name of the `acsTriggerIF` process.

Type: String

Optionality: Optional (default used if not set)

Allowed:

Default: "acsTriggerIF"

Notes:

Example: `sleeInterfaceName = "acsTriggerIF"`

sleeServiceKey

Syntax: `sleeServiceKey = int`

Description: The SLEE service key that `acsTriggerIF` should send generated IDP messages to if not specified by the trigger event data.

Type: Integer

Optionality: Optional (default used if not set)

Allowed:

Default: 1

Notes:

Example: `sleeServiceKey = 1`

`statisticsEnabled`

Syntax: `statisticsEnabled = true|false`
Description: Set whether `acsTriggerIF` should log statistics or not.
Type: Boolean
Optionality: Optional (default used if not set)
Allowed: `true, false`
Default: `true`
Notes:
Example: `statisticsEnabled = true`

`triggerTimeOutSecs`

Syntax: `triggerTimeOutSecs = seconds`
Description: The maximum period (in seconds) that `acsTriggerIF` should wait for a response to an IDP trigger event before giving up and closing the dialog.
Type: Integer
Optionality: Optional (default used if not set)
Allowed:
Default: `10`
Notes:
Example: `triggerTimeOutSecs = 10`

Statistics Updated by `acsTriggerIF`

The following statistic definitions have been defined for application "Acs_Service". These statistics are turned on by default. Control this behavior by setting the `acsTriggerIF` *statisticsEnabled* (on page 61) parameter. For each required extra statistic, turn the statistic on using the SMS Statistics Management screen (see *SMS User's Guide*).

Statistic	Description
TRIGGER_FAIL	The number of failed control plan triggers.
TRIGGER_SUCCESS	The number of successful control plan triggers.
TRIGGER_TIMEOUT	The number of timed out control plan triggers.

acsDbCleanup Configuration

The `acsDbCleanup` configuration in the ACS section of the `eserv.config` supports configurations for DB cleanup.

Here is an example of the `acsDbCleanup` section.

```
acsDbCleanup = {
  statsAge = 5
  compileErrorAge = 1
  commit = 100
} # acsDbCleanup
```

Chapter 4

statsAge

Syntax: `statsAge = value`

Description: The number of days after which statistics records has to be deleted from ACS_STATISTICS_COUNT table.

Type: Integer

Optionality: Optional (default used if not set)

Allowed: Any non zero, positive integer.

Default: The default value is configured in acsDbCleanup.sh file.

Notes:

Example: `statsAge = 5`

compileErrorAge

Syntax: `compileErrorAge = value`

Description: The number of days after which the compile error records has to be deleted from ACS_COMPILE_ERRORS table.

Type: Integer

Optionality: Optional (default used if not set)

Allowed: Any non zero, positive integer.

Default: The default value is configured in acsDbCleanup.sh file.

Notes:

Example: `compileErrorAge = 1`

commit

Syntax: `commit = value`

Description: The number of rows that has to committed after making the changes in AC_STATISTICS_COUNT and ACS_COMPILE_ERRORS tables.

Type: Integer

Optionality: Optional (default used if not set)

Allowed: Any non zero, positive integer.

Default: The default value is configured in acsDbCleanup.sh file.

Notes:

Example: `commit = 100`

AdditionalCheckMOLIPrefix Configuration

The MoLI (Mobile origin Location Information) standard is used by Australian Telecommunications companies to identify the location of mobile callers.

The `checkMOLIPrefix` parameter, which you configure in the `acs.conf` file, enables you to specify only a single prefix on a dialed number that identifies the prefix as containing a MoLI code. If the dialed number has the prefix specified, then ACS removes the prefix and applies MoLI decoding rules in order to place the three digit MoLI code from the number into the calling network address field.

You can configure up to 19 additional MoLI prefixes in the ACS, AdditionalCheckMOLIPrefix section in the `eserv.config` configuration file on the SLC. You configure the additional MoLI prefixes by using the following syntax:

```
ACS = {
    AdditionalCheckMOLIPrefix = {
        checkMOLIPrefixes = [
            "int",
```

```

        "int",
        ..
    ]
}

```

The `checkMOLIPrefixes` array has the following characteristics:

`checkMOLIPrefixes`

Syntax:

```

checkMOLIPrefixes = [
    "int",
    "int",
    ..
]

```

Description: The `checkMOLIPrefixes` array is a comma separated list of the additional MoLI prefixes to check, where *int* is a MoLI prefix.

Type: Array

Optionality: Optional

Allowed: Up to 19 additional MoLI prefixes

Notes: You must also configure the single MoLI prefix in the `CheckMOLIPrefix` (on page 93) parameter in **acs.conf** for the MoLI functionality to be available.

Example:

```

checkMOLIPrefixes = [
    "121",
    "122",
    "123",
    "124",
    "125",
    "126"
]

```

FCI Configuration

For correct operation with a Siemens INAP (SINAP 5) switch, Convergent Charging Controller sends a Furnish Charging Information (FCI) operation before every Connect, Continue, ReleaseCall, EstablishTemporaryConnection, and ConnectToResource operation. Convergent Charging Controller extracts the FCI content to send from the appropriate profile block and tags.

An FCI operation can contain between one and five billing items. If the extracted FCI content contains more than five billing items, `slee_acs` can send a second FCI operation that contains up to five additional billing items. A maximum of 10 billing items can be sent. Examples of billing items sent in FCI operations are "calling number", "called number", and "prepaid/postpaid flag".

In addition to billing items, the FCI contents can include the following information:

- Service number (from the original called party buffer or another buffer)
- Auto-incrementing counter ("A" for first FCI, "B" for second, and so on)
- Mobile location indicator from the calling party network address buffer or another buffer
- Country code from the service number profile
- Service code from the service number profile
- Profile tags populated by the FCI fields in the Edit Service Numbers dialog box
- Profile tags: FCI On (70), FCI Service Code (71), FCI Country Code (72)

The FCI operation for a Siemens INAP requires the following shared library, which is installed with Convergent Charging Controller:

```

/IN/service_packages/AAPT/lib/libfciService.so

```

Here is an example of the FCI configuration section:

```

FCI = {

```

Chapter 4

```
    serviceKeys = [  
        9810, "91900001", "0xff1911100" etc.  
    ]  
}
```

serviceKeys

Syntax: `serviceKeys = [key1, ...]`
Description: Specifies which INAP service keys receive FCI data
Type: Integer, String
Optionality: Required
Allowed: Integer, String, and String with Hex ("0x...") formats are supported.
Default: []
Example: `serviceKeys = [9810, "91900001", "0xff1911100"]`

fciFlagProfileTag

Syntax: `fciFlagProfileTag = tag`
Description: If the profile tag used for the FCI flag is not standard, specifies the profile tag to use for the FCI flag
Type: Integer
Optionality: Optional
Allowed:
Default: None
Example: `fciFlagProfileTag = 70`

serviceIndicatorProfileTag

Syntax: `serviceIndicatorProfileTag = tag`
Description: If the profile tag used for the service indicator flag is not standard, specifies the profile tag to use for the service indicator flag.
Type: Integer
Optionality: Optional
Allowed:
Default: None
Example: `serviceIndicatorProfileTag = 71`

countryCodeProfileTag

Syntax: `countryCodeProfileTag = tag`
Description: If the profile tag used for the country code is not standard, specifies the profile tag to use for the country code.
Type: Integer
Optionality: Optional
Allowed:
Default: None
Example: `countryCodeProfileTag = 72`

NP Configuration

The following number portability (NP) shared library replaces the destination routing address in the Connect operation if the number has been ported to another operator:

`/IN/service_packages/AAPT/lib/libnpService.so`

For example, it might replace "02 1111 2222" with "1456 43 02 1111 2222".

The shared library queries the NP tables directly.

Here is an example of the NP configuration section:

```
NP = {
    enableService = true
    mode = "whitelist"
    serviceKeys = [
        10,    # Toll Free EWSD Private Plane
        30    # Toll Free Genband National Plane
    ]

    ignoredTermNumberPrefixes = [
        "14"
    ]

    additionalPrefix = "AA"

    additionalPrefixServiceKeys = [
        30    # Toll Free Genband National Plane
    ]
}
```

`enableService`

Syntax: `enableService = true | false`

Description: Specifies whether to execute the NP service logic (`libnpService.so`).

Type: Boolean

Optionality: Optional (default used if not set)

Allowed: true, false

Default: true

Example: `enableService = true`

`mode`

Syntax: `mode = "whitelist" | "blacklist"`

Description: Specifies how to treat the configured service keys.

- "whitelist" means INAP connect operations associated with the service keys (`serviceKeys`) will trigger an NP lookup or translation.
- "blacklist" means INAP connect operations associated with the service keys (`serviceKeys`) will *not* trigger an NP lookup or translation.

Type: String

Optionality: Optional (default used if not set)

Allowed: "whitelist" or "blacklist"

Default: "whitelist"

Example: `mode = "whitelist"`

Chapter 4

serviceKeys

Syntax: `serviceKeys = [key1, ...]`
Description: Specifies the service keys that trigger (whitelist) or do not trigger (blacklist) an NP lookup.
Type: Array
Optionality: Optional (default used if not set)
Allowed:
Default: `[]`
Example:

```
serviceKeys = [10,    # Toll Free EWSD Private Plane
                30    # Toll Free Genband National Plane
                ]
```

ignoredTermNumberPrefixes

Syntax: `ignoredTermNumberPrefixes = ["prefix", ...]`
Description: For a call that terminates to a DRA and matches a prefix in this list, specifies that it does not trigger an NP lookup regardless of its service key.
Type: Array
Optionality: Optional (default used if not set)
Allowed:
Default: `[]`
Example: `ignoredTermNumberPrefixes = ["14"]`

additionalPrefix

Syntax: `additionalPrefix = "pre"`
Description: An additional prefix that is added to the DRA for calls that trigger an NP lookup and match one of the service keys specified by `additionalPrefixServiceKeys`
Type: String
Optionality: Optional (default used if not set)
Allowed:
Default: `""`
Example: `additonalPrefix = "AA"`

additionalPrefixServiceKeys

Syntax: `additionalPrefixServiceKeys = [key1, ...]`
Description: A list of service keys against which calls that trigger an NP lookup are matched. If the service key matches a service key in the list, adds the `additionalPrefix` prefix to the DRA after NP translation. Adds the prefix regardless of whether the NP lookup finds a PQYZ entry.
Type: Array
Optionality: Optional (default used if not set)
Allowed:
Default: `[]`
Example:

```
additionalPrefixServiceKeys = [
    30    # Toll Free Genband National Plane
    ]
```

ACS_Prefix Service Entry for FCI and NP Configurations

The FCI and NP configurations require the following service entry for the ACS_Prefix service name. See *ServiceEntries Configuration* (on page 54) for descriptions of the parameters.

There is only one ServiceEntries section so these service entry parameters for ACS_Prefix should be added to any existing sections for other service names.

Note: The service name and the method order are important. You potentially might want to define the same entries for the service "ACS".

```
ServiceEntries = [
  {
    ...
    AddressSources = {}
    MinSleeEventSize = 1024
    ServiceName = "ACS_Prefix"
    Methods = {
      acsChassisLoadService = [ "libnpService.so", "libacsService.so",
"libfciService.so" ]
      acsChassisPreETC = ["libacsService.so", "libfciService.so" ]
      acsChassisPreCTR = ["libacsService.so", "libfciService.so" ]
      acsChassisPrePOR = ["libnpService.so", "libacsService.so",
"libfciService.so" ]
      acsChassisStoreProfile = ["libacsService.so" ]
      acsChassisReLoadProfiles = ["libacsService.so" ]
      acsChassisLoadProfiles = ["libacsService.so" ]
      acsChassisProcessCall = ["libacsService.so" ]
      acsChassisCallTerminated = ["libacsService.so" ]
      acsChassisInitSL = ["libnpService.so", "libacsService.so" ,
"libfciService.so" ]
      acsChassisGetCDRContent = ["libacsService.so" ]
    }
  }
]
```

Example ACS Configuration in eserv.config

This is an example of the ACS section of the `eserv.config` file.

```
ACS = {
  countryCodes = [
    "97"
    "64"
    "65"
    "44"
    "1"
  ]

  macroNodes = {
    ATPD = {
      ReleaseInApplyCharging = true
    }
  }

  tracing = {
    enabled = true
    origAddress = [
      "0064212",
      "0064213",
      "0064214"
    ]
    destAddress = [
```

```

        "0064213",
        "0064214"
    ]
    traceDebugLevel = "all"
}

acsChassisActions = {

    mscAddressForEdr = [
        {
            mscAddress = "123456789"
            encoding = "BCD"
        },
        {
            mscAddress = "987654321"
            encoding = "ASCII"
        }
    ]

}

SessionTimeInformation = {

    STIServiceKey = 122
    IDPExtTypeEDRId = 901
    extractEdrId = true
    IDPExtTypeCallStartTime = 902
    extractCallStartTime = true
    callStartTimeFormat = "YYYYMMDDHH24MISS"
    IDPExtTypeCallAnswerTime = 903
    extractCallAnswerTime = true
    callAnswerTimeFormat = "YYYYMMDDHH24MISS"
    IDPExtTypeCallEndTime = 904
    extractCallEndTime = true
    callEndTimeFormat = "YYYYMMDDHH24MISS"
    IDPExtTypeEDRTimeZone = 905
    extractEdrTimeZone = true

}

ServiceEntries = [
{
    ServiceName = "MyTestService"

    Methods = {
        acsChassisInitSL = [ "lib1.so", "lib2.so", "lib3.so" ]
        acsChassisLoadService = [ "lib1.so", "lib3.so" ]
        acsChassisPrePOR = [ "lib2.so", "lib1.so" ]
        acsChassisCallTerminated = [ "lib1.so" ]
        acsChassisPreCTR = [ "lib1.so" ]
        acsChassisPreETC = [ "lib1.so" ]
    }

    AddressSources = {
        NetworkCP = [
            { source = "callingPartyNumber", screening = "network" }
            { source = "callingPartyNumber", screening = "user" }
            { source = "additionalCallingPartyNumber", screening = "network" }
            { source = "additionalCallingPartyNumber", screening = "user" }
            { source = "extensionNumber", extension=4 }
            { source = "cellIDorLAI" }
            { source = "Empty" }
        ]
        LogicalCP = [
            { source = "callingPartyNumber", screening = "user" }

```

```

        { source = "callingPartyNumber", screening = "network" }
    ]
}

MinSleeEventSize = 1024
ServiceName = "ACS_Prefix"
Methods = {
    acsChassisLoadService = [ "libnpService.so", "libacsService.so",
        "libfciService.so" ]
    acsChassisPreETC = [ "libacsService.so", "libfciService.so" ]
    acsChassisPreCTR = [ "libacsService.so", "libfciService.so" ]
    acsChassisPrePOR = [ "libnpService.so", "libacsService.so",
        "libfciService.so" ]
    acsChassisStoreProfile = [ "libacsService.so" ]
    acsChassisReLoadProfiles = [ "libacsService.so" ]
    acsChassisLoadProfiles = [ "libacsService.so" ]
    acsChassisProcessCall = [ "libacsService.so" ]
    acsChassisCallTerminated = [ "libacsService.so" ]
    acsChassisInitSL = [ "libnpService.so", "libacsService.so" ,
        "libfciService.so" ]
    acsChassisGetCDRContent = [ "libacsService.so" ]
}
}
]

acsTriggerIF = {
    # sleeInterfaceName = "acsTriggerIF"
    # sleeServiceKey = 1
    # overrideSleeServiceKey = 0
    # inapServiceKey = 1
    # statisticsEnabled = true
    # noActivitySleepTime = 10000
    # triggerTimeOutSecs = 10
    deleteTagsAfterTrigger = [
        1312070, # ISN Balance
        1312052, # ISN Credit Threshold Balance
        1312075, # ISN Failure Reason
        1312074, # ISN Lifecycle State
        1312050, # ISN Preferred Channel
        1312051, # ISN Preferred Time
        1312073, # ISN Rating Status
        1312068, # ISN Streaming Threshold
        1312066 # ISN Subscription Expiry
    ]
    numberRules = [
        { prefix="", min=0, max = 100, remove=0, prepend="", resultNoa=4 }
    ]
}

AdditionalCheckMOLIPrefix = {
    checkMOLIPrefixes = [
        "121",
        "122",
        "123",
        "124",
        "125",
        "126"
    ]
}

FCI = {

    serviceKeys = [

```

```

        9810, "91900001", "0xff1911100" etc.
    ]
}

NP = {

    enableService = true
    mode = "whitelist"
    serviceKeys = [
        10, # Toll Free EWSD Private Plane
        30  # Toll Free Genband National Plane
    ]

    ignoredTermNumberPrefixes = [
        "14"
    ]

    additionalPrefix = "AA"

    additionalPrefixServiceKeys = [
        30  # Toll Free Genband National Plane
    ]
}
}

```

MRC Configuration

locationInfoRetrieval Configuration

In order to make `slee_acs` send `AnyTimeInterrogation`, so that it can do mid-call tariff changes if the subscriber moves, you need to configure the `locationInfoRetrieval` parameters in the MRC section of `eserv.config`.

```

MRC = {
    locationInfoRetrieval = {
        LocationInfoPollEnabled = true
        LocationInfoTcapInterfaceName = "m3ua_if"
        LocationInfoGSMScfAddress = "12345678"
        LocationInfoGSMScfMapNoa = 1
        LocationInfoOriginatingSubsystemNumber = 147
        LocationInfoDestinationSubsystemNumber = 6 # HLR
        LocationInfoRequestTimeout = 5
    }
}

```

The `locationInfoRetrieval` parameter is optional. However, if the parameter is present, to configure the parameter to send `AnyTimeInterrogation`, the following parameters must be set to a valid value other than their default:

- `LocationInfoGSMScfAddress`
- `LocationInfoPollEnabled`
- `LocationInfoTcapInterfaceName`

The following parameters specify parts of the GSM SCF address parameter of `AnyTimeInterrogation`. They are also used for the SCCP originating address of the message containing the `AnyTimeInterrogation`:

- `LocationInfoGSMScfAddress`
- `LocationInfoGSMScfMapNoa`
- `LocationInfoOriginatingSubsystemNumber`
- `LocationInfoDestinationSubsystemNumber`

- LocationInfoRequestTimeout

LocationInfoDestinationSubsystemNumber

Syntax: LocationInfoDestinationSubsystemNumber = *num*
Description: The SCCP subsystem number to put in the destination address.
Type: Integer
Optionality: Required if locationInfoRetrieval is present
Allowed:
Default: 0
Notes:
Example: LocationInfoDestinationSubsystemNumber = 6

LocationInfoGSMScfAddress

Syntax: LocationInfoGSMScfAddress = "*address*"
Description: The digits of the GSM SCF address and Global Title.
Type: String
Optionality: Required if locationInfoRetrieval is present
Allowed:
Default: ""
Notes: The default setting will turn off the function.
Example: LocationInfoGSMScfAddress = "12345678"

LocationInfoGSMScfMapNoa

Syntax: LocationInfoGSMScfMapNoa = *NoA*
Description: The nature of address of the GSM SCF address.
Type: Integer
Optionality: Optional (default used if not set).
Allowed:
Default: 1 (International)
Notes: The SCCP Global Title NOA is hard-coded to 4 = international.
Example: LocationInfoGSMScfMapNoa = 1

locationInfoOriginatingSubsystemNumber

Syntax: locationInfoOriginatingSubsystemNumber = *num*
Description: The SCCP subsystem number to put in the originating address.
Type: Integer
Optionality: Required if locationInfoRetrieval is present
Allowed:
Default: 0
Notes:
Example: locationInfoOriginatingSubsystemNumber = 147

locationInfoPollEnabled

Syntax: locationInfoPollEnabled = *true|false*
Description: Send AnyTimeInterrogation

Type: Boolean
Optionality: Required if `locationInfoRetrieval` is present
Allowed: true, false
Default: false
Notes: The default setting will turn off the function
Example: `locationInfoPollEnabled = true`

`LocationInfoRequestTimeout`

Syntax: `LocationInfoRequestTimeout = seconds`
Description: The minimum number of seconds to wait before giving up waiting for a response to `AnyTimeInterrogation`.
Type: Integer
Optionality: Optional (default used if not set).
Allowed:
Default: 5
Notes:
Example: `LocationInfoRequestTimeout = 5`

`locationInfoTcapInterfaceName`

Syntax: `locationInfoTcapInterfaceName = "name"`
Description: The name of the TCAP interface to use to send MAP2 `AnyTimeInterrogation`.
Type: String
Optionality: Required if `locationInfoRetrieval` is present
Allowed:
Default: ""
Notes: The default setting will turn off the function.
Example: `LocationInfoTcapInterfaceName = "m3ua_if"`

Example MRC Configuration in `eserv.config`

This is an example of the MRC section of the `eserv.config` file.

```
MRC = {  
  locationInfoRetrieval = {  
    LocationInfoPollEnabled = true  
    LocationInfoTcapInterfaceName = "m3ua_if"  
    LocationInfoGSMScfAddress = "12345678"  
    LocationInfoGSMScfMapNoa = 1  
    LocationInfoOriginatingSubsystemNumber = 147  
    LocationInfoDestinationSubsystemNumber = 6 # HLR  
    LocationInfoRequestTimeout = 5  
  }  
}
```

Configuring the `acs.conf`

Overview

Introduction

This chapter explains how to configure `acs.conf`.

In this chapter

This chapter contains the following topics.

<code>acs.conf</code>	73
<code>acsChassis</code> Plug-ins	75
<code>acsStatisticsDBInserter</code> (SMS)	78
<code>acsCompilerDaemon</code> (SMS)	81
<code>acsProfileCompiler</code>	84
<code>acsStatsMaster</code> (SLC)	85
<code>acsChassis</code> Single Instance Parameters (SLC)	87
<code>acsStatsLocal</code> (SLC)	113
<code>acsChassis</code> Emergency Numbers (SLC)	113
<code>acsChassis</code> INAP Extension Parameters	114
<code>acsChassis</code> Normalization Parameters (SLC)	117
<code>acsChassis</code> SLEE Event Size Parameter (SLC)	123
<code>acsChassis</code> ServiceEntry Configuration (SLC)	123
<code>acsChassis</code> SRF Configuration (SLC)	131
<code>acsChassis</code> SCF Configuration (SLC)	134
<code>acsChassis</code> SSF Configuration (SLC)	138
<code>acsChassis</code> EDR Configuration (SLC)	143
<code>acsChassis</code> Service Library Configuration (SLC)	152
<code>acsChassis</code> Service Normalisation Parameters (SLC)	153
<code>acsChassis</code> AWOL Configuration	153
Get Hunting Number Node Configuration	156
Number Matching Node Configuration	156
Play Variable Part Announcement Node Configuration	157
Profile Date Compare Node Configuration	158
<code>acs.conf</code> Example	158

`acs.conf`

Introduction

The Advanced Control Services (ACS) tools and processes depend on the ACS configuration file, `acs.conf` (located in `/IN/service_packages/ACS/etc/`). There is an `acs.conf` file on the SMS and each SLC. The configuration options on the SMS are different to the configuration options on the SLC.

When ACS is fully installed there may be other configuration options that are added to `acs.conf` which are not explained in this section. Any configuration options not described in this section are required by the application and should not be changed by the user.

The configuration file consists of several sections named for the executable they control. Each section contains a parameter representing a single configuration option. Leading '#' characters represent comments and are ignored by the system. Each section must be terminated by a ':' character. All configuration options (except those for section headers such as 'acsChassis') must be indented or they will be ignored.

Note: The `acsChassis` section is much larger than the other executables. Consequently the section has been subdivided within this document.

Example Configuration Sections

Here are examples of configuration sections.

Example 1

Here is an example of a configuration section for the `acsStatsMaster` executable.

```
acsStatsMaster
port 1490
shmKey 17170588
semKey 17170589
masterStatsServer tcpprodscp:
```

Example 2

Here is an example of a configuration section for the `ACS_outgoing` service.

```
ACS_outgoing
NormalUseHex 1
NormalisationRule (2,-,0,32)
NormalisationRule (2,0,1,32)
NormalisationRule (2,00,2,32)
DenormalisationRule (2,2,1,-)
DenormalisationRule (3,3,1,-)
DenormalisationRule (4,4,1,-):
```

Implementing Parameter Changes

If `acs.conf` is changed by the operator the service needs to be restarted, so that the configuration file is reread and the changes take effect. For more information about restarting the service see [Managing Processes](#).

Parameter Types

There are three types of parameters listed within the following topics:

- 1 Parameters that are a standard part of `acs.conf` and must be configured with the correct setting
- 2 Parameters that are a standard part of `acs.conf` with default settings and do not require configuring except in the case of custom settings for a specific site
- 3 Parameters that must be *added* to `acs.conf` with the correct setting

Note: Some parameters appear only once within the following topics (for example, `port`). Other parameters may appear multiple times (for example, `ServiceEntry`).

Before You Begin

Most values in `acs.conf` are set to sensible defaults. Be sure to read the relevant information in the following sections before modifying these values.

It is recommended that you make a backup copy of `acs.conf` before altering the service settings.

Editing the acs.conf File

Edit the `acs.conf` file with any UNIX text editor.

Example command. `vi acs.conf`

acsChassis Plug-ins

acsChassis

The `acsChassis` section defines how to handle traffic coming in to `slee_acs`. It defines the traffic processed by a specified service and service loader plug-in library combination. It also defines how `slee_acs` processes the traffic to each service.

The available parameters are:

`ChassisPlugin`

Syntax:

Description: Chassis plug-ins provide the ACS Control Plan Editor with an expanded interface to its environment.

The `ChassisPlugin` lines are required to define which chassis action libraries will be available to `slee_acs`. The CCS chassis action library (`ccsActions`) must be included here.

Type:

Optionality: Required (must be set to include the required CCS library)

Allowed:

Default:

Notes: The interface between the CPE and the Voucher and Wallet Server is implemented using chassis plug-ins. Other uses include external database operations or network access.

One shared library may implement more than one chassis action.

No further configuration is needed to allow the Chassis to load the plug-ins at startup. However, individual plug-ins may have configuration requirements of their own.

For more information about the `slee_acs`, see *ACS Technical Guide*.

Example:

```
acsChassis
  ChassisPlugin ccsActions.so
```

`MacroNodePluginFile`

Syntax: `MacroNodePluginFile libraryname`

Description: The `MacroNodePluginFile` lines are required to define which feature node libraries will be available in the control plans used by `slee_acs`. The CCS feature node library (`ccsMacroNodes`) must be included here.

Type:

Optionality: Required (must be set to include the required CCS library)

Allowed:

Default:

Notes: Some plug-in-based feature nodes distributed with CCS are:

- Attempt Termination with Billing node
- Language Select node

- Voucher Recharge node

Example: MacroNodePluginFile ccsMacroNodes.so

ServiceEntry

Syntax: ServiceEntry (*service, service_library*)

Description: The ServiceEntry lines are needed to define which services defined in the **SLEE.cfg** are handled by the CCS service loader library (ccsSvcLibrary).

Optionality: Required (must be set to include the required CCS library)

Allowed: For more information about the structure of this configuration option, see *acsChassis ServiceEntry Configuration (SLC)* (on page 123). For more information about the values which can be used in the service element of this configuration, see the technical guide for the relevant service.

Notes: Any service defined in **SLEE.cfg** must have a corresponding ServiceEntry line configured in **acs.conf**.

Example: ServiceEntry (CCS, ccsSvcLibrary.so)
ServiceEntry (EAX_MO, libeaxSvcLibrary.so)

setCcetOnDisconnectCall

Syntax: setCcetOnDisconnectCall = *int*

Description: Controls how ACS calculates the CCET time when there are problems communicating with the billing engine.

Type: Integer

Optionality: Optional (default used if not set)

Allowed:

- 0 – ACS calculates the CCET by including only reserved times from successful BE responses.
- 1 – ACS attempts to recalculate the CCET. CCET then reflects the total connected time rather than just the reserved time. That is, CCET is the reserved time plus the time waiting for BE responses.

Default: 0

Notes:

Example: setCcetOnDisconnectCall = 1

srf

Syntax: srf (*srfName, UseETC=Y|N, Address=IP|nothing, NOA=0|1|2|3|4*
typeOfSrf=NAP|other)

Description: The name and number of the Specialized Resource Function (or Intelligent Peripheral) is required for each IP on the network.

Notes: Parsing should continue until no new IPs can be found in the configuration file. This will eliminate the need for a count to be specified in the configuration file for the number of resources available.

Example: srf (nap1, UseETC=N, Address=, NOA=3)

tfnListSize

Syntax: tfnListSize *size*

Description: The maximum length, in characters, of the track feature nodes (TFN) EDR field.

Type: Integer

Optionality: Optional

Allowed:

Default: 2048
Notes: If the maximum character length of `tfnListSize` is exceeded, feature nodes will be trimmed from the front of the list.
Example: `tfnListSize 2048`

acsChassis Plug-in Libraries

Both parts of `slee_acs` (the `acsChassis` and the `acsEngine`) can be extended to do new tasks by installing plug-in libraries (independent pieces of program code that are loaded into the system at runtime).

Plug-ins are distributed as shared libraries with the file extension of `.so`.

`slee_acs` must be informed of the location of these shared libraries, so that their functionality can be made available to the running system.

Plug-in shared libraries may be stored anywhere in the file system. However, the recommended location for plug-ins is `/IN/service_packages/package_name/lib`.

Note: If plug-ins are not specified in `acs.conf` as an absolute path to the shared library, shared libraries are searched for in the path read from the environment variable `LD_LIBRARY_PATH`. The location recommended above is listed in the search path by default after installation.

Initialization

The ACS ChassisEngine program will always load Engine plug-ins after fully loading and initializing all Chassis plug-ins, regardless of the order of configuration lines in `acs.conf`.

This is done to ensure that plug-in-based chassis actions are always available to plug-in-based engine nodes as they load and initialize themselves.

Note: All configured Chassis and Engine plug-ins are loaded and initialized in order of appearance in `acs.conf` within their own class of plug-in.

Plug-in list

The following plug-ins are required by the `acsChassis`:

MacroNodePluginFile

Syntax: `MacroNodePluginFile = lib`
Description: These lines configure which feature node libraries are available to `slee_acs`. This may be as simple as just the ACS feature node library (`libacsMacroNodes` (on page 174)) which provides the base ACS feature nodes, but may also include other libraries provided by other components.
Type: String
Optionality: Optional (no libraries loaded if not set).
Allowed:
Default: None
Notes: Individual plug-ins may have additional configuration requirements of their own, not detailed here.
 One shared library may implement more than one feature node.
 Engine plug-ins must be configured with entries in the following database tables:

- 1 ACS_FN_TYPE
- 2 ACS_FN_STRUCT_DEF
- 3 ACS_FN_DATA_DEF

The database is configured appropriately on installation, and should not need updating.

Example: `MacroNodePluginFile = libacsMacroNodes`

ChassisPlugin

Syntax: `ChassisPlugin = lib`

Description: Pluggable Action - base ACS actions.

These lines configure which chassis action libraries are available to `slee_acs`. This may be as simple as just the ACS chassis action library (*libacsChassisActions* (on page 174)), but may also include other libraries provided by other components.

Type: String

Optionality: Optional (no libraries loaded if not set).

Allowed:

Default: None

Notes: Individual plug-ins may have additional configuration requirements of their own, not detailed here.

One shared library may implement more than one feature node.

Example: `ChassisPlugin = libacsChassisActions`

srf

Syntax: For a full syntax, see *acsChassis SRF Configuration (SLC)* (on page 131).

Description: Specialized Resource Function mappings for the SLEE.

Type: String

Optionality: Optional (default used if not set).

Allowed:

Default: (NAP1, UseETC=N, Address=, NOA=3)

Notes:

Example:

acsStatisticsDBInserter (SMS)

Introduction

The `acsStatisticsDBInserter` must know the name and port number of the `acsStatsMaster`. Because this process also inserts data into the database it is also possible to change the default username and password in the `acs.conf` file.

Therefore the `acsStatisticsDBInserter` section within `acs.conf` on the SMS must be populated to specify the name of the machine and the port number used by the `acsStatsMaster`.

About database connections

`acsStatisticsDBInserter` connects to the database on a local or a remote SMS node by using the user credentials specified in the `oracleusername`, the `oraclepassword`, and the `oracledatabase` parameters in the `acsStatisticsDBInserter` section of `acs.conf`.

For connections to a:

- Local database specify the user and password in the `oracleusername` and `oraclepassword` parameters. For passwordless connections to a local database by using the default value of `"/`, do not specify the `oracleusername`, the `oraclepassword`, or the `oracledatabase` parameters.
- Remote database specify the user and password in the `oracleusername` and `oraclepassword` parameters, and specify the SID of the remote database in the `oracledatabase` parameter. When you specify the `oracleusername`, the `oraclepassword`, and the `oracledatabase` parameters, the `oracledatabase` value is used for the USING clause of CONNECT.
- Local or a remote database by using the Oracle wallet secure external password store specify only the TNS connection string in the `oracledatabase` parameter, where the connection string is the alias defined for the username and password credentials in the external password store. This alias can be either a TNS name or a service name from `tnsnames.ora`.

Parameters

The parameters below must be configured with the correct value.

`oracleusername`

Syntax: `oracleusername user`
Description: The user name `acsStatisticsDBInserter` will use to connect to Oracle.
Type: String
Optionality: Optional (default used if not set)
Default: null
Notes: If no `oracleusername` and `oraclepassword` are specified, the string used to connect to Oracle is `"/`. This is the recommended way to connect to Oracle. For more information, see *Oracle usr/pwd String* (on page 22).

`oraclepassword`

Syntax: `oraclepassword password`
Description: The password `acsStatisticsDBInserter` should use to connect to Oracle.
Type: String
Optionality: Optional (default used if not set)
Allowed:
Default: null
Notes: If the default is used, the actual string used to connect to Oracle will use the password for the account which is running `acsStatisticsDBInserter`. This should be the `acs_oper` account's password.

Example:

`oracledatabase`

Syntax: `oracledatabase @db_name|@connection_string`
Description: The name of the remote database or the TNS connection string for connecting to the database using SQLnet. To connect to a remote database through the Oracle wallet external password store, specify the alias defined for the username and password credentials in the external password store. This alias can be either a TNS name or a service name from `tnsnames.ora`.
Type: String
Optionality: Optional
Default: `@SMF`
Notes: If you specify the `oracleusername`, the `oraclepassword`, and the

`oracledatabase` parameters, the `oracledatabase` value is used for the USING clause of CONNECT.

To connect to the remote database by using the TNS connection string, specify only the TNS connection string in the `oracledatabase` parameter.

Example: `oracledatabase @SMF`

MasterServerPort

Syntax: `MasterServerPort port`
Description: The port on which the master statistics server is listening for requests.
Type: Integer
Optionality: Optional (default used if not set)
Allowed: Any integer representing a valid port address
Default: null
Notes:
Example:

Retries

Syntax: `Retries int`
Description: The number of attempts to make to communicate with the statistics master server before failing.
Type: Integer
Optionality: Optional (default used if not set)
Allowed: Any non zero, positive integer.
Default: 3
Notes:
Example:

Period

Syntax: `Period seconds`
Description: The number of seconds between queries of the statistics master server.
Type: Integer
Optionality: Optional (default used if not set)
Allowed: Any non zero, positive integer.
Default: 30
Notes:
Example:

MasterServerLocation

Syntax: `MasterServerLocation name`
Description: The system name of the master statistics server.
Type: String
Optionality: Optional (default used if not set)
Allowed:
Default: SCP1
Notes: Any string representing the system name required.
Example:

acsCompilerDaemon (SMS)

Introduction

The acsCompilerDaemon process is responsible for converting a control plan into the binary format used by the ACS service logic to process calls.

About database connections

acsCompilerDaemon connects to the database on a local or a remote SMS node by using the user credentials specified in the `oracleusername`, the `oraclepassword`, and the `oracledatabase` parameters in the acsCompilerDaemon section of `acs.conf`.

For connections to a:

- Local database specify the user and password in the `oracleusername` and `oraclepassword` parameters. For passwordless connections to a local database by using the default value of `"/`, do not specify the `oracleusername`, the `oraclepassword`, or the `oracledatabase` parameters.
- Remote database specify the user and password in the `oracleusername` and `oraclepassword` parameters, and specify the SID of the remote database in the `oracledatabase` parameter. When you specify the `oracleusername`, the `oraclepassword`, and the `oracledatabase` parameters, the `oracledatabase` value is used for the USING clause of CONNECT.
- Local or a remote database by using the Oracle wallet secure external password store specify only the TNS connection string in the `oracledatabase` parameter, where the connection string is the alias defined for the username and password credentials in the external password store. This alias can be either a TNS name or a service name from `tnsnames.ora`.

Parameters

The parameters in this list assume the default values if they are not configured. Only one entry per parameter is allowed.

`oracleusername`

Syntax:	<code>oracleusername user</code>
Description:	The user name acsCompilerDaemon should use to connect to Oracle.
Type:	String
Optionality:	Optional (default used if not set)
Default:	null
Notes:	If the default is used, the actual string used to connect to Oracle will use the account which is running acsCompilerDaemon. This should be <code>acs_oper</code> account.

`oraclepassword`

Syntax:	<code>oraclepassword password</code>
Description:	The password acsCompilerDaemon should use to connect to Oracle.
Type:	String
Optionality:	Optional (default used if not set)
Default:	null
Notes:	If the default is used, the actual string used to connect to Oracle will use the password for the account which is running acsCompilerDaemon. This should be the <code>acs_oper</code> account's password.

oracledatabase

Syntax:	<code>oracledatabase @db_name @connection_string</code>
Description:	The name of the remote database or the TNS connection string for connecting to the database using SQLnet. To connect to a remote database through the Oracle wallet external password store, specify the alias defined for the username and password credentials in the external password store. This alias can be either a TNS name or a service name from <code>tnsnames.ora</code> .
Type:	String
Optionality:	Optional
Default:	@SMF
Notes:	If you specify the <code>oracleusername</code> , the <code>oraclepassword</code> , and the <code>oracledatabase</code> parameters, the <code>oracledatabase</code> value is used for the USING clause of CONNECT. To connect to the remote database by using the TNS connection string, specify only the TNS connection string in the <code>oracledatabase</code> parameter.
Example:	<code>oracledatabase @SMF</code>

alertTimeout

Syntax:	<code>alertTimeout seconds</code>
Description:	The number of seconds to remain blocked waiting for the alert to occur before checking for signals.
Type:	Integer
Optionality:	Optional (default used if not set).
Allowed:	Any non zero, positive integer.
Default:	3
Notes:	Since signals are blocked for this period of time, it is recommended that this number is not increased beyond 5 because it may cause the process to not terminate correctly on system shutdown.
Example:	<code>alertTimeout 3</code>

maxBranches

Syntax:	<code>maxBranches int</code>
Description:	The maximum number of branches any feature node in a control plan may have.
Type:	Integer
Optionality:	Optional (default used if not set)
Allowed:	Any non zero integer.
Default:	99
Notes:	If this is set to lower than 99, users must ensure they do not set any of the feature nodes in their control plans to more than <code>maxBranches</code> . If they do, their control plan will not compile.
Example:	<code>maxBranches 99</code>

maxNodes

Syntax:	<code>maxNodes int</code>
Description:	The maximum number of nodes any control plan may have.
Type:	Integer
Optionality:	Optional (default used if not set).
Allowed:	Any non zero, positive integer.

Default: 2000
Notes: To determine the number of nodes in a control plan, the control plan must be opened in the CPE. The properties for the control plan will give the number of nodes used.
Example: `maxNodes 200`

`maxCompiledKb`

Syntax: `maxCompiledKb int`
Description: Sets the maximum size of the binary produced when a control plan is compiled.
Type: Integer
Optionality: Optional (default used if not set).
Allowed: Any integers in range 1 - 1024
Default: 1024
Notes: Setting above the default value may not be supported by replication, please check with support before increasing this limit.
Example: `maxCompiledKb 1024`

`compressAtKb`

Syntax: `compressAtKb Kb`
Description: The maximum size in Kilobytes of a control plan, before `acsCompilerDaemon` will compress it when it compiles it.
`acsCompilerDaemon` compresses control plans before checking whether they exceed `maxCompiledKb`.
Type: Integer
Optionality: Optional (default used if not set).
Allowed: Any non zero, positive integer.
Default: 128
Notes: To be effective, this parameter should be set lower than `maxCompiledKb` (on page 83), any changes require the `acsCompilerDaemon` to be restarted for any changes to take effect.
Example: `compressAtKb 128`

`compressLevel`

Syntax: `compressLevel int`
Description: The level of compression used in control plan compression if `compressAtKb` (on page 83) is exceeded.
Type: Integer
Optionality: Optional (default used if not set).
Allowed: 0 No compression.
1-9 Compression level, where 1 is low and 9 is high.
Default: 1
Notes: Any changes require the `acsCompilerDaemon` to be restarted for any changes to take effect.
Example: `compressLevel 1`

endUnlinkedExits

Syntax:	<code>endUnlinkedExits 0 1</code>
Description:	Allow unconnected exits from a feature node in a control plan. The control plan must contain at least one End feature node.
Type:	Boolean
Optionality:	Optional (default used if not set)
Allowed:	0 – Do not allow unconnected feature node exits. 1 – Connect all unconnected exits to the first End feature node in the control plan when the control plan is saved.
Default:	0
Example:	<code>endUnlinkedExits 1</code>

AuditChallenge

Description:	Because <code>acsCompilerDaemon</code> runs on the SMS, <code>AuditChallenge</code> should be set to 1 for <code>acsCompilerDaemon</code> . This parameter should be disabled for processes that run on the VWS, or SLC.
Default:	1
Allowed:	0 (disabled), 1 (enabled)
Example:	<code>AuditChallenge 1</code>

acsProfileCompiler

Introduction

`acsProfileCompiler` processes configuration changes to timezone and termination number ranges by performing changes in the global profile, and in customer profiles, for customers who have non-default termination ranges defined.

About database connections

`acsProfileCompiler` connects to the database on a local or a remote SMS node by using the user credentials specified in the `oracleusername`, the `oraclepassword`, and the `oracledatabase` parameters in the `acsProfileCompiler` section of `acs.conf`.

For connections to a:

- Local database specify the user and password in the `oracleusername` and `oraclepassword` parameters. For passwordless connections to a local database by using the default value of `"/`, do not specify the `oracleusername`, the `oraclepassword`, or the `oracledatabase` parameters.
- Remote database specify the user and password in the `oracleusername` and `oraclepassword` parameters, and specify the SID of the remote database in the `oracledatabase` parameter. When you specify the `oracleusername`, the `oraclepassword`, and the `oracledatabase` parameters, the `oracledatabase` value is used for the USING clause of CONNECT.
- Local or a remote database by using the Oracle wallet secure external password store specify only the TNS connection string in the `oracledatabase` parameter, where the connection string is the alias defined for the username and password credentials in the external password store. This alias can be either a TNS name or a service name from `tnsnames.ora`.

Parameters

The parameters in this list assume the default values if they are not configured. Only one entry per parameter is allowed.

`oracleusername`

Syntax: `oracleusername user`
Description: The user name `acsProfileCompiler` uses to connect to Oracle.
Type: String
Optionality: Optional (default used if not set)
Default: null
Notes: If the default is used, the actual string used to connect to Oracle will use the account which is running `acsProfileCompiler`, such as the `acs_oper` account.

`oraclepassword`

Syntax: `oraclepassword password`
Description: The password `acsProfileCompiler` uses to connect to Oracle.
Type: String
Optionality: Optional (default used if not set)
Default: null
Notes: If the default is used, the actual string used to connect to Oracle uses the password for the account which is running `acsProfileCompiler`, such as the password for the `acs_oper` user.

`oracledatabase`

Syntax: `oracledatabase @db_name|@connection_string`
Description: The name of the remote database or the TNS connection string for connecting to the database using SQLnet. To connect to a remote database through the Oracle wallet external password store, specify the alias defined for the username and password credentials in the external password store. This alias can be either a TNS name or a service name from `tnsnames.ora`.
Type: String
Optionality: Optional
Default: @SMF
Notes: If you specify the `oracleusername`, the `oraclepassword`, and the `oracledatabase` parameters, the `oracledatabase` value is used for the USING clause of CONNECT.
 To connect to the remote database by using the TNS connection string, specify only the TNS connection string in the `oracledatabase` parameter.
Example: `oracledatabase @SMF`

acsStatsMaster (SLC)

Introduction

This process is the single point of statistics access for other systems in the network. It processes requests for other SLCs as well as the SMS.

Parameters

The following parameters must be configured with the correct value.

`oracleusername`

Syntax:	<code>oracleusername user</code>
Description:	The user name acsStatsMaster should use to connect to Oracle.
Type:	String
Optionality:	Optional (default used if not set)
Default:	null
Notes:	If the default is used, the actual string used to connect to Oracle will use the account which is running acsStatsMaster. This should be acs_oper account.

`oraclepassword`

Syntax:	<code>oraclepassword password</code>
Description:	The password acsStatsMaster should use to connect to Oracle.
Type:	String
Optionality:	Optional (default used if not set)
Default:	null
Notes:	If the default is used, the actual string used to connect to Oracle will use the password for the account which is running acsStatsMaster. This should be the acs_oper account's password.

`masterStatsServer`

Description:	Host name of the machine running the master stats server.
Default:	No default
Allowed:	Any string representing a valid host name.

`port`

Description:	Port on which the stats master listens for connection attempts.
Default:	1490
Allowed:	Any integer that represents a valid port address.

`shmKey`

Description:	Shared Memory key for the acsStatsMaster.
Default:	17170588
Allowed:	acsChassis shmKey value.
Notes:	This must be the same as the entry for the acsChassis <code>shmKey</code> . It is recommended that the user does not change this value unless there is a collision. It is up to the installer to ensure that there are no collisions.

`semKey`

Description:	Semaphore Key for acsStatsMaster.
Default:	17170589
Allowed:	acsChassis semKey value.
Notes:	This must be the same as the entry for the acsChassis <code>semKey</code> . It is recommended that the user does not change this value unless there is a collision. It is up to the installer to ensure that there are no collisions.

acsChassis Single Instance Parameters (SLC)

Parameters

The following parameters must be configured with the correct value.

masterStatsServer

Description: Host name of the machine running the master stats server.
Default: No default
Allowed: Any string representing a host name, but must be the same as the `masterStatsServer` of the `acsStatsLocal` section. For example `scp1.telconame.com`

port

Description: Port on which the stats master listens for connection attempts.
Default: 1490
Allowed: Any valid integer representing a port address.

shmKey

Description: Shared Memory key for the `acsStatsMaster`.
Default: 17170588
Allowed: Must be the same as `acsStatsMaster shmKey`.

semKey

Description: Semaphore Key for `acsStatsMaster`.
Default: 17170589
Allowed: Must be the same as the `acsStatsMaster semKey`.

addChargingInfoToCTR

Description: Perform FCI/SCI for CTR
Default: 0 (false)
Allowed: 0 or 1 (true)

addChargingInfoToETC

Description: Perform FCI/SCI for ETC
Default: 0
Allowed: 0 (false) or 1 (true)

addChargingInfoToPA

Syntax: `addChargingInfoToPA 0|1`
Description: Perform FCI/SCI for PA and PACUI.
Type: Boolean
Optionality: Optional (default used if not set).

Chapter 5

Allowed:

- 0 (false), do not perform FCI/SCI
- 1 (true), do perform FCI/SCI

Default: 0

Notes:

Example: `addChargingInfoToPA 1`

DigitsInAnnouncementList

Syntax: `DigitsInAnnouncementList 0|1`

Description: If set to true, records the details of any interaction between the caller and the control plan in the AIDL EDR tag.

Type: Boolean

Optionality: Optional (Default is used if omitted)

Allowed: 0 (off), 1 (on)

Default: 0

Notes: Refer to AIDL for a description of changes to the AIDL information.

Example: `DigitsInAnnouncementList 1`

AddMOLIPrefix

Description: Specifies a numeric prefix to the three character MOLI code that is placed into the calling network address field (see `CheckMOLIPrefix` (on page 93)).

Optionality: Optional, and does not need to be provided whenever a `CheckMOLIPrefix` parameter is included in the `acs.conf` file.

Default: 222

Allowed: 1 to 20 numeric characters can be specified.

Notes: See Section 6.2 of the ACIF document G532 for more details on the MOLI standard.

alwaysIncludePartyToCharge

Syntax: `alwaysIncludePartyToCharge value`

Description: Whether to set the `partyToCharge` parameter in ACS to the leg1 party or not.

Type: Integer

Optionality: Optional (default used if not set).

Allowed: Any integer value. However any value other than 1 is treated as 0.

Default: 0

Notes: 0 – The `partyToCharge` parameter is not set.
1 – The `partyToCharge` parameter is set.

Example: `alwaysIncludePartyToCharge 1`

alternativeCallPlanNamePostfix

Syntax: `alternativeCallPlanNamePostfix _name`

Description: This string is appended to the end of a control plan name to create an alternative control plan.

You can activate or deactivate alternative control plans from the ACS screens:

Services -> ACS Service -> Customer -> Control Plan Change tab

Type: String

Optionality: Optional (default used if not set).
Allowed:
Default: `_alt`
Notes: To override an existing control plan, the alternative control plan name must follow this syntax:
`<ServiceNumber><alternativeCallPlanNamePostfix>`
 For example, if service number 0800123456 uses control plan "ABC", the alternative control plan for this service number must be named 0800123456_alt.
Example: `alternativeCallPlanNamePostfix _emergency`

`armDisconnectAt`

Syntax: `armDisconnectAt 0|1`
Description: Forces the AT feature node to arm for oDisconnect in the associated BCSM Event when set to true.
Type: Boolean
Optionality: Optional (default used if not set).
Allowed:

- 0 (false), do not arm for oDisconnect
- 1 (true), arm for oDisconnect

Default: 0
Notes:
Example: `armDisconnectAt 1`

`armDisconnectAtp`

Syntax: `armDisconnectAtp 0|1`
Description: Forces the ATP feature node to arm for oDisconnect in the BCSM Event when set to true.
Type: Boolean
Optionality: Optional (default used if not set).
Allowed:

- 0 (false), do not arm for oDisconnect
- 1 (true), arm for oDisconnect

Default: 0 - false
Notes:
Example: `armDisconnectAtp 1`

`armDisconnectLeg1`

Description: On disconnect requests, do we include Leg1 disconnects.
Default: 1
Allowed: 0 (false), 1 (true)

`armDisconnectLeg2`

Description: On disconnect requests, do we include Leg2 disconnects.
Default: 1
Allowed: 0 (false), 1 (true)

Chapter 5

armLegsSeparately

Description: Produces two BCSM Event Reports; one for Leg1 and one for Leg2.
Default: 1
Allowed: 0 (disabled), 1 (enabled)

ArmTerminateTriggers

Default: 0
Allowed: 0 = Only use originating ('o') type EDPs
1 = Enable arming of originating ('o') and terminating ('t') type EDPs

AssumePreArrangedEnd

Description: Enables the logic in `slee_acs` that handles prearranged TCAP ends. This ensures the clean shut down of the call dialog and all related events.
Default: 0
Allowed: 0 (disabled), 1 (enabled)
Notes: This may be useful in cases where dialogs and events are leaking, yet the system appears to be operating normally.

atDisconnectMM_Leg1Interrupt

Description: Should arm disconnect on Leg1 as
Default: 0
Allowed: 0 (notify), 1 (interrupt)

atDisconnectMM_Leg2Interrupt

Description: Should arm disconnect on Leg2 as
Default: 1
Allowed: 0 (notify), 1 (interrupt)

AuditChallenge

Description: This should not be required to be set in an operational environment. Set this parameter to 0 (zero) unless running on an SMS.
Default: 0
Allowed: 0 (disabled), 1 (enabled)
Example: AuditChallenge 0

CallInitiationExtensionForIdp

Syntax: `CallInitiationExtensionForIdp = int`
Description: Determines whether the call initiation node should place the SLEE call ID in the configured extension.
Type: Integer
Optionality: Optional
Allowed:
Default:
Notes: The `CallInitiationExtensionForIdp` and `extensionNumber` (on page 116) configuration parameters in `acs.conf` can be used to correlate EDRs generated from two calls that involve the Call Initiation node.

Example: `CallInitiationExtensionForIdp = 123`

`CallInitiationTimeoutToleranceSeconds`

Description: This parameter is for use with the Call Initiation node (CIN).
Default: 10
Allowed: Maximum 0xFFFF (18 hours)
Notes: This value is added to the No Answer timeout value in the CIN to set an overall tolerance timer in the outgoing TCAP interface. When the sum of these two values is reached the TCAP interface will send a TCAP_CANCEL back to ACS to defend against the event of lost responses from the SSF.

`CallInitiationUseContextInd`

Syntax: `CallInitiationUseContextInd value`
Description: Defines whether the indicator values are obtained from the call context buffer (so can be set through the Set Indicator node or denormalization rules) or are fixed.
Type: Integer
Optionality: Optional (default used if not set).
Allowed: 0, 1, 2, 3
Default: 0
Notes:

- 0** - All indicator values, including NoA, set to the original values (NoA = 4, ScrnInd = 3, PresInd = 0, NumIncomplete = 0).
- 1** - All indicator values, except NoA, set to original values. The NoA value would come from the context and could be altered using denormalization rules.
- 2** - NoA set to original value. Other indicator values come from context and could be altered through Set Indicator nodes in the control plan.
- 3** - All indicator values would come from the context. The NoA value could be altered through denormalization rules and the other indicator values could be altered through Set Indicator nodes in the call plan.

 In all cases the NumberPlan will be set to 1.

Example: `CallInitiationUseContextInd 2`

`CalledPartyBcdToNoaMap`

Syntax: `CalledPartyBcdToNoaMap = "0, 1, 2, 3, 4, 5, 6, 7"`
Description: Used to convert MAP nature of address (NOA) indicators, such as CAMEL BCD, to the ISUP standard used by ACS for internal NOA values.
Type: Array
Optionality: Optional (default used if not set).
Allowed: This array uses the position in the array (starting at 0) to determine the MAP NOA to match, and the value to determine the ISUP NOA to translate to.

Default: 2,4,3,5,1,0,0,0

That is, change MAP to ISUP as follows:

MAP NOA	ISUP NOA
0 (unknown)	2 (unknown)
1 (international)	4 (international)
2 (national)	3 (national)
3 (network-specific)	5 (network-specific)
4 (subscriber)	1 (subscriber)
5, 6, 7	0 (unknown)

Notes:

Example: `CalledPartyBcdToNoaMap = "2,4,2,5,1,0,0,0"`

`callProcessingAllowedAfterAPartyDisconnect`

Syntax: `callProcessingAllowedAfterAPartyDisconnect 0|1`

Description: Whether or not to allow call processing after the A party has hung up.

Type: Boolean

Optionality: Optional (default used if not set).

Allowed: 0, 1

Default: 0 (not allowed)

Notes: Setting this parameter to 1 leaves call processing set to true on receipt of `TC_CONTINUE(ERBCSM(oDisconnect,Leg1,Interrupted))`

Example: `callProcessingAllowedAfterAPartyDisconnect 1`

`CancelChar`

Description: The character used by the user to cancel the previously entered digits.

Default: B (Hex value)

Allowed: Entry char and cancel char may be specified as hex digits or * or #. However, # must be entered as \# to stop it being interpreted as a comment.

`CarrierCodeDisposal`

Syntax: `CarrierCodeDisposal 0|1`

Description: How the carrier code call context variable is handled in outgoing connect operations.

Type: Boolean

Optionality: Optional, default used if not set.

Allowed: 0 The carrier code is prefixed to the termination number.
1 The termination number is not modified. This effectively nullifies the function of any Set Carrier Code feature node.

Default: 0

Notes:

Example: `CarrierCodeDisposal 0`

`ChainCountLimit`

Description: This limits the number of times the control plan is allowed to chain to other ACS services during a single call.

Default: 8

Allowed: Any non-zero positive integer.

Notes: The digit entered indicates the number of ServiceHandovers possible in a single call.
This is most important in VPN, where it stops station-forwarding loops.

`CheckMOLIPrefix`

Description: This specifies the prefix on a dialed number that identifies it as containing MOLI (Mobile Location Indicator) information.

Default: 029

Allowed: Only a single prefix is supported, with a length of 1 to 20 characters.

Notes: If a called number has the prefix specified, the ACS chassis will remove the prefix and apply MOLI decoding rules. This places the three digit MOLI code from the number into the calling network address field.

`CollectInfoReturnsAll`

Description: When sending an RRB+CI, (Request Report BCSMEvent and Collect Information) though the service asks for 1 digit at a time, the SSP will always send 'previously sent DN+the extra digit'.

Default: 0

Allowed: 0 (false), 1 (true)

Notes: The ETSI INAP specification is unclear as to whether the return result should be all the digits collected thus far, or just the most recent digit.
This configuration option enables you to specify what behavior to expect.

`CopySpareBits`

Description:3 `slee_acs` copies the following data from the indicated source:

- Presentation restricted and screening indicators from called party number
- INN and screening indicator from original called party number

Default: 0

Allowed: 0 (copies the data from the relevant parameter in the Initial DP on the grounds that they are defined as spare in the ETSI standards)
1 (copies from elsewhere)

`dfcOnIpAbort`

Description: Should we Dfc to the SSP when the IP dialog is doored.

Default: 0

Allowed: 0 (no), 1 (yes)

`DialledHashEncoding`

Description: Enter the network encoding for # in BCD.

Default: C (Hex value)

Allowed:

DialledStarEncoding

Description: Enter the network encoding for * in BCD.

Default: B (Hex value)

Allowed:

dialogTickInterval

Syntax: `dialogTickInterval interval`

Description: The time during which dialog timers are checked.

Type: Integer

Units: Seconds

Optionality: Optional

Allowed: $interval \geq 0$

Default: The `dialogTickInterval` parameter is omitted.

- Notes:**
- If the `dialogTickInterval` parameter is omitted, the SLEE sets to 10 the time during which dialog timers are checked.
 - If $interval = 0$, the SLEE sets to 10 the time during which dialog timers are checked.
 - If $interval > 0$, $interval$ is the time during which dialog timers are checked.

Example: `dialogTickInterval 15`

disarmEDPs

Description: How to handle EDPs which may still be armed on the SSP.

Default: 1

Allowed: 0 - Never disarm oAbandon (assume switch always disarms)
1 - Always explicitly dis-arm and re-arm for a subsequent connect.
2 - If oAbandon is still armed, and a subsequent connect wants it armed, then do nothing. If the subsequent connect does not want it armed, then explicitly clear it.

DisconnectMidCallJumpBack

Description: Should a Disconnect node instead generate a MidCallJump if there is a MidCallMark pending?

Default: 1

Allowed: 0 (no), 1 (yes)

edpArmAbandoned

Description: When an Attempt Terminate is performed in ETSI, there are a number of cases for which the switch may test, as not all switches support all cases.

Default: 0

Allowed: 0 This exit branch will never be followed from the Attempt Terminate or Follow Me nodes.
1 This exit branch will be followed.

`edpArmAnswer`

Description: When an Attempt Terminate is performed in ETSI, there are a number of cases for which the switch may test, as not all switches support all cases.

Default: 0

Allowed: 0 This exit branch will never be followed from the Attempt Terminate or Follow Me nodes.
1 This exit branch will be followed.

`edpArmBusy`

Description: When an Attempt Terminate is performed in ETSI, there are a number of cases for which the switch may test, as not all switches support all cases.

Default: 0

Allowed: 0 This exit branch will never be followed from the Attempt Terminate or Follow Me nodes.
1 This exit branch will be followed.

`edpArmNoAnswer`

Description: When an Attempt Terminate is performed in ETSI, there are a number of cases for which the switch may test, as not all switches support all cases.

Default: 0

Allowed: 0 This exit branch will never be followed from the Attempt Terminate or Follow Me nodes.
1 This exit branch will be followed.

`edpArmRouteSelectFailure`

Description: When an Attempt Terminate is performed in ETSI, there are a number of cases for which the switch may test, as not all switches support all cases.

Default: 0

Allowed: 0 This exit branch will never be followed from the Attempt Terminate or Follow Me nodes.
1 This exit branch will be followed.

`edpSetNoAnswerTimer`

Description: Options for handling no answer.

Default: always

Allowed:

- never - Never set the applicationTimer
- always - Always set the applicationTimer to the requested value
- nonzero - Override only nonzero requested values to the NoAnswerTimeout value
- override - Always override the requested value to the NoAnswerTimeout value
- overridezero - Override the requested value to the NoAnswerTimeout value if the requested value is zero

`edpUseNoAnswerTimer`

Description: This flag is used to set a default value for `edpSetNoAnswerTimer` (on page 95) when the provided entry is invalid.

Default: 1

- Allowed:**
- 0 - Set the `edpSetNoAnswerTimer` (on page 95) as `overridezero` if the provided entry is invalid.
 - 1 - Set the `edpSetNoAnswerTimer` (on page 95) as `always`, if the provided entry is invalid.

`emptyDraIsError`

- Syntax:** `emptyDraIsError = 1|0`
- Description:** Determines whether to retain the original behavior of reporting an error if the normalized DRA is empty or suppress this error.
- Type:** Boolean
- Optionality:** Optional (default used if not set).
- Allowed:**
- 1 true
 - 0 false. This error will not be reported and the processing of the call will proceed as normal.
- Default:** 1
- Notes:**
- Example:** `emptyDraIsError = 1`

`enableTermAttemptAuthorizedConnect`

- Syntax:** `enableTermAttemptAuthorizedConnect 0|1`
- Description:** Setting this parameter to 0 means a Continue is sent instead of a connect, when an IDP has been triggered from an `TermAttemptAuthorized` DP, and the pending termination number is identical to the service number (i.e. the pending termination number has not been changed by the service loader or Control Plan logic). This allows CCS to bill one number, but connect to another.
- Type:**
- Optionality:**
- Allowed:**
- 0 = Always send Continue, see notes for *UseContinueOperation* (on page 107).
 - 1 = Send Connect or attempt to send Continue as directed by the *UseContinueOperation* (on page 107) parameter.
- Default:** 1
- Notes:**
- Example:** `enableTermAttemptAuthorizedConnect 1`

`EntryChar`

- Description:** The character used to indicate the end of input.
- Default:** C (Hex value)
- Allowed:** Entry char and cancel char may be specified as hex digits or * or #. However, # must be entered as `\#` to stop it being interpreted as a comment.

`ETC_CorrelationIdInIPAddr`

- Description:**
- If on, appends the SRF correlation ID to the IP's address.
 - If off, uses the proper field in an ETC message for containing the SRF correlation ID.
- Default:**
- Allowed:** 0 (off), 1 (on)

`ETC_MinCorrelationDigits`

Description: The SRF correlation ID digits (used above) out to a fixed number of digits.

Default:

Allowed:

`ETC_SCF_ID`

Description: Contains the SCF ID.

If the `ETC_CorrelationIdInIPAddr` is 1, then the IP prefix set is appended with the correlation ID and then appended with the value of `ETC_SCF_ID`, if it is set in the `acs.conf` file.

If `ETC_SCF_ID` is not set in the `acs.conf` file, the SCF ID is not appended. If `ETC_CorrelationIdInIPAddr` is 0, then the SCF ID and correlation ID are sent as separate parameters in the ETC message.

Default:

Allowed: The SCF ID

`extraStats`

Description: Should we record extra statistics. See *Extra statistics* (on page 112) for the list.

Default: 0

Allowed: 0 (no), 1 (yes)

`fakeAcrCallReleaseAtMaxDuration`

Syntax: `fakeAcrCallReleaseAtMaxDuration 0|1`

Description: If this flag is set, then ACS assumes that a CAMEL phase 2 call is released with the call duration greater or equal to the maximum call duration period, and the call is treated like a CAMEL phase 3 call with the `callReleasedAtTcpExpiry` present.

Type: Boolean

Optionality: Optional (default used if not set).

Allowed: 1 (true), 0 (false)

Default: 0

Notes:

Example: `fakeAcrCallReleaseAtMaxDuration 0`

`FakeAcrCallReleaseAtTcpExpiry`

Description: Using CAP2, when you receive and process an Apply Charging Report it is unclear if you should expect a subsequent `EventReportBCSM` (caller/called hang-up case) or not (switch force disconnect case).

Default: 0

Allowed: 0 (not set), 1 (set)

Notes: CAP3 includes the callReleaseAtTcpExpiry flag to CAP3's ACR to clarify this processing.

To enable processing to be clear while using CAP2, ACS attempts to detect the case by sniffing the primitive that contained the ACR to see if it also contains an ERBCSM.

If it does not contain an ERBCSM, it can be assumed that none is coming. To provide the ACR functions with the necessary data, we will set the callReleaseAtTcpExpiry flag on the ACR.

Example: FakeAcrCallReleaseAtTcpExpiry 0

fakeMissingAcrAtDisconnection

Syntax: fakeMissingAcrAtDisconnection 0|1

Description: When the B party hangs up and oDisconnect leg 2 is armed as interrupted, Convergent Charging Controller expects an Apply Charging Report followed by an Event Report BCSM to be returned by the SSP.

Some SSPs only return an Event Report BCSM. In this case setting fakeMissingAcrAtDisconnection to 1 will replicate the anticipated behavior.

Type: Boolean

Optionality: Optional (default used if not set)

Allowed: 0 (false), 1 (true)

Default: 0

Notes: In some cases, the Event Report BCSM is sent before the Apply Charging Report. This is non CAP standard behavior. In this case the parameter should be set to 0.

Example: fakeMissingAcrAtDisconnection 0

fciInSeparateMessageAllOperations

Syntax: fciInSeparateMessageAllOperations 0|1

Description: Whether or not to send the FurnishChargeInformation in a separate TCAP message, before the TCAP message is sent.

Type: Boolean

Optionality: Optional (default used if not set).

Allowed: 0, 1

Default: 0 (do not send)

Notes: This applies to all operations, not just a Connect.

Example: fciInSeparateMessageAllOperations 1

fciInSeparateMessage

Syntax: fciInSeparateMessage 0|1

Description: Whether or not to send the FurnishChargeInformation in a separate TCAP message, before the TCAP message is sent.

Type: Boolean

Optionality: Optional (default used if not set).

Allowed: 0, 1

Default: 0 (do not send)

Notes: This only applies to a Connect operation.

Example: fciInSeparateMessage 1

`fciMaximumLength`

Description: Maximum length of FCI binary data record generated by concatenating FCI tariff codes.

Default: 200

Allowed: Integer, in the range 1-200.

`fciSeparator`

Description: Optional separator between concatenated FCI tariff codes.

Default: ""

Allowed:

`FirstDigitTimeout`

Description: This indicates the time to wait in seconds for the first digit to be entered.

Default: 4

Allowed: Any non zero, positive integer.

`GlobalProfileMaxAge`

Description: The maximum age, in seconds, that the global profile and global control plan is allowed to reach before it is reloaded from the database.

Default: 300

Allowed: Integer

Notes: The global profile and global control plan age is checked at the start of a call.

`ignoreNumberPlanForConnectToContinue`

Syntax: `ignoreNumberPlanForConnectToContinue 1|0`

Description: Determines whether to ignore the number plan indicator when comparing the DRA and the triggered called number while checking if a connect or continue message should be sent.

Type: Boolean

Optionality: Optional (default used if not set).

Allowed: 1 (ignore), 0 (do not ignore)

Default: 0

Notes:

Example: `ignoreNumberPlanForConnectToContinue 0`

`InterDigitTimeout`

Description: This indicates the time, in seconds, to wait for the next digit to be entered.

Default: 4

Allowed: Integer

`InternalErrorAction`

Description: This indicates the required action if there is an unexpected internal error.

Default: disconnect

Allowed: disconnect, continue

Chapter 5

IPProtocolInfo

Description: Use INAP to talk to intelligent peripherals.
Default: 1
Allowed: No other values are currently supported.

maxAnnouncementTextBytes

Syntax: `maxAnnouncementTextBytes value`
Description: Maximum number of bytes allowed in the text field of a PlayAnnouncement or PromptAndCollectUserInformation operation.
Type: Integer
Optionality: Optional
Allowed: Positive integer
Default: 80
Notes:
Example: `maxAnnouncementTextBytes 80`

MaxPromptDigits

Description: Indicates the maximum number of digits to be entered.
Default: 255
Allowed:

MinZeroTimeRemainingPeriod

Description: Sets the amount of time (in seconds) for handling duplicate ACR on race condition during hang-up of secondary reservation time.
Default: 5
Allowed:

NoAnswerTimeout

Description: Time (in seconds) before a call returns No Answer.
Default: 10
Allowed: Integer

NoCallPlanAction

Description: This parameter indicates the required action if there is no control plan.
Default: continue
Allowed:

NoCallPlanCause

Description: Release cause to return to SSP if no control plan exists and if NoCallPlanAction is "disconnect".
Default: 1
Allowed: 0 (No cause reported), 1 (Unallocated Number)
Notes: Refer to Q.850.

`NoCallPlanError`

Description: This indicates the severity level of the error generated.

Default: NOTICE

Allowed:

- NOTICE
- WARNING
- ERROR
- CRITICAL

Notes: Errors are logged in two places:

- SMS alarm system
- `/var/adm/messages`

`NoDatabaseConnectAction`

Description: There is no connection to the database.

Default:

Allowed:

`NoServiceAction`

Description: This indicates the required action if there is no `ServiceEntry` in `acs.conf` for this service name.

Default: disconnect

Allowed: disconnect, continue

`NoServiceError`

Description: This indicates the severity level of the error generated.

Default: WARNING

Allowed:

- NOTICE
- WARNING
- ERROR
- CRITICAL

Notes: Errors are logged in two places:

- SMS alarm system
- `/var/adm/messages`

`OverrideDefaultIPDigitTimeout`

Description: This indicates whether to override the default IP settings with those listed below when waiting for digits to be entered.

Type: Boolean

Optionality: Optional (default used if not set).

Allowed: 0 (Disabled), 1 (Enabled)

Default: 0

Notes:

Example:

Chapter 5

overwriteFci

Syntax:	<code>overwriteFci 0 1</code>
Description:	Flag to control when a new FCI is appended to an existing FCI or overwrites an existing FCI.
Type:	Boolean
Optionality:	Optional (default used if not set).
Allowed:	0 (append to existing), 1 (overwrite existing)
Default:	0
Notes:	
Example:	<code>overwriteFci 1</code>

PersistentAuthorisationInfo

Description:	Should the last used PIN Number and A/C Numbers be copied across during a ServiceHandover.
Default:	1
Allowed:	0 (no), 1 (yes)

postAnswerBeepTimer

Description:	The number of milliseconds to delay the notification announcement to be sent from the switch.
Default:	1000
Allowed:	Integer

recordSmpStatistics

Description:	Whether to record SMS statistics. See <i>Statistics Captured</i> (on page 110) for the list of SMS stats.
Default:	1
Allowed:	0 (no), 1 (yes)

rrbcsmPrefix

Description:	Optional prefix digits to send on Connect messages arming ERBCSMS.
Default:	" "
Allowed:	

sciMaximumLength

Description:	Truncation (by FCS) for SCI data payload.
Default:	200
Allowed:	Integer in the range 1-200.

roundDownACRCallDuration

Syntax:	<code>roundDownACRCallDuration 0 1</code>
Description:	Option to round down ACR call duration when converting from deciseconds to seconds
Type:	Boolean
Optionality:	Optional (default used if not set).
Allowed:	0 (off), 1 (on)

Default: 0 (round up)
Notes:
Example: `roundDownACRCallDuration 0`

`sendFciWithReleaseCall`

Syntax: `sendFciWithReleaseCall = 0|1`
Description: Specifies whether ACS sends an FCI operation in a TCAP message, when the call:

- Has been through a Set Tariff Code macro node
- Is passing through a Point of Return and returning a releaseCall operation

Type: Boolean
Allowed:

- 0 – ACS sends FCI operations in TCAP messages.
- 1 – ACS does not send FCI operations in TCAP messages.

Default: 0 (ACS does not send FCI operations in TCAP messages)
Notes: You must set this parameter to 1, even if the FCI flag is set from the service loader.
Example: `sendFciWithReleaseCall = 1`

`sendIdenticalCliInConnect`

Syntax: `sendIdenticalCliInConnect 0|1`
Description: Whether to send callingPartyNumber in Connect, even if it is the same as in IDP.
Type: Boolean
Optionality: Optional (default used if not set).
Allowed:

1	True. acsChassis will set the CallingPartyNumber in the Connect, even if it is identical to the one in the IDP
0	False.

Default: 0
Notes:
Example: `sendIdenticalCliInConnect 1`

`setCallerNetworkTZFromIncomingGmtOffset`

Syntax: `setCallerNetworkTZFromIncomingGmtOffset = Integer`
Description: Specifies the subscriber's caller network time zone.
Type: Integer
Optionality: Optional (default used if not set)
Allowed: 0 and 1
Default: 0
Notes: Every subscriber has an associated ACS geography set.
 If set to 0, the subscriber caller network time zone is determined from the ACS time zone geography set.
 If set to 1, the subscriber caller network time zone is determined from the GMT by an incoming Initial Detection Point (IDP) message.
Example: `setCallerNetworkTZFromIncomingGmtOffset = 0`

Chapter 5

setCallerLogicalTZFromIncomingGmtOffset

Syntax: `setCallerLogicalTZFromIncomingGmtOffset = Integer`

Description: Specifies the subscriber's caller logical time zone.

Type: Integer

Optionality: Optional (default used if not set)

Allowed: 0 and 1

Default: 0

Notes: Every subscriber has an associated ACS geography set.

If set to 0, the subscriber logical time zone is determined from the ACS time zone geography set.

If set to 1, caller's logical time zone is set from the GMT by an incoming IDP message.

Example: `setCallerLogicalTZFromIncomingGmtOffset = Integer`

smsStatsPeriodCheck

Description: This specifies how often ACS should check the SMS stats shared memory is valid.

Default: -1

Allowed: -1 no checking
any non zero, positive integer.

sourceSelectionOnHandover

Syntax: `sourceSelectionOnHandover int`

Description: Set to 1 (one) to enable reload source selection on service handover, for example; this enables profile tag values to be reloaded from source when a control plan hands over to a another service.

Type: Boolean

Optionality: Optional (default used if not set).

Allowed: 1 – Enables source selection reload.

Not set.

Default: Source selection reload disabled.

Notes: On service handover, reloading source selection will overwrite profile tag values that are set in the control plan.

For example, a control plan that is triggered by CCS captures the subscriber ID. The control plan hands back to CCS on completion. On handover, source selection is reloaded and the subscriber ID, captured in the control plan, is overwritten with the originating number.

Example: `sourceSelectionOnHandover 1`

statsReportingLevel

Description: Sets the level of detail for statistics reporting.

Default: 0

Allowed: 0 Empty

1 service name

2 INAP service key

3 service name, INAP service key

4 control plan name

5 service name, control plan name

- 6 INAP service key, control plan name
- 7 service name, INAP service key, control plan name

syslogLevel

Description: This option defines, in a bit field, the behavior of certain syslog commands in ACS. It defines whether or not the message is printed out. Currently this configuration parameter covers two areas of system log messages.

- The warning printed on the receive of a TC_U_ERROR
- The error printed on the receive of a TC_REJECT

Format: The format may be any of the following:

- 1) A plain decimal number, of the form:
`syslogLevel 4294967295`
- 2) A hex number, of the form (case insensitive):
`syslogLevel 0xffffffff`
- 3) A octal number, of the form:
`syslogLevel 012345670`

Each bit in the field is either 0 or 1. If 0, syslog messages for that error will not be printed. If 1, the error will be printed.

Only the least two bits (the last two bits on sun and hpux hardware) in the number currently define any behavior:

- LSB 1. Defines whether or not the warning messages for TC_U_ERROR are printed.
- LSB 2. Defines whether or not the warning messages for TC_REJECT are printed.

Default: 0xffffffff

Allowed: 0xffffffff = all possible syslog messages are printed.

Notes: '0' is required as the first character.

To turn off syslog warnings for the receive of TC_U_ERROR messages, set the configuration option as one of the following formats:

```
syslogLevel 0xffffffffe
syslogLevel 0x2
```

(as only bits 1 and 2 control any output currently, the rest of the number is unneeded).

To turn off errors in the syslog on the receive of TC_REJECT messages, use the configuration option: `syslogLevel 0x1`

To turn off both: `syslogLevel 0x0`

syslogLevel

Description: This option defines, in a bit field, the behavior of certain syslog commands in ACS. It defines whether or not the message is printed out. Currently this configuration parameter covers two areas of system log messages.

- The warning printed on the receive of a TC_U_ERROR
- The error printed on the receive of a TC_REJECT

Format: The format may be any of the following:

- 1) A plain decimal number, of the form:
`syslogLevel 4294967295`
- 2) A hex number, of the form (case insensitive):
`syslogLevel 0xffffffff`

3) A octal number, of the form:

```
syslogLevel 012345670
```

Each bit in the field is either 0 or 1. If 0, syslog messages for that error will not be printed. If 1, the error will be printed.

Only the least two bits (the last two bits on sun hardware) in the number currently define any behavior:

- LSB 1. Defines whether or not the warning messages for TC_U_ERROR are printed.
- LSB 2. Defines whether or not the warning messages for TC_REJECT are printed.

Default: 0xffffffff

Allowed: 0xffffffff = all possible syslog messages are printed.

Notes: '0' is required as the first character.

To turn off syslog warnings for the receive of TC_U_ERROR messages, set the configuration option as one of the following formats:

```
syslogLevel 0xffffffffe
syslogLevel 0x2
```

(as only bits 1 and 2 control any output currently, the rest of the number is unneeded).

To turn off errors in the syslog on the receive of TC_REJECT messages, use the configuration option: `syslogLevel 0x1`

To turn off both: `syslogLevel 0x0`

TcAbortOnPreArrangedEnd

Description: If the `AssumePreArrangedEnd` parameter is not enabled, this parameter will send an abort to kill the dialog.

Default: 0

Allowed: 0 (Disabled), 1 (Enabled)

TrimFStop

Description: This is used to trim the trailing 'F' on the Called Party and/or Calling Party number.

Default: 0

Allowed: 0 (Do not trim), 1 (Trim)

tzDefault

Syntax: `tzDefault timezone`

Description: Where no match is found in a geography set, this parameter sets the default time zone to use.

Type: String

Optionality: Optional (default used if not set).

Allowed: Any Java supported time zone. For a full list a Java supported time zones, see *Time Zones* (on page 205).

Default: ""

Notes:

Example: `tzDefault Europe/Amsterdam`

UseContinueOperation

- Syntax:** UseContinueOperation 0|1
- Description:** Determines whether to send an INAP Continue operation, rather than a Connect operation.
- Type:**
- Optionality:**
- Allowed:** 0 Send Connect
1 Attempt to send INAP Continue
- Default:** 0
- Notes:** A Continue is sent instead of a Connect if and only if:
- 1 The InitialDP operation has been triggered from the TermAttemptAuthorized detection point and the pending termination number is identical to the service number (that is, the pending termination number has not been changed by the service loader or control plan logic.), and enableTermAttemptAuthorizedConnect is 0.
OR:
 - 2 UseContinueOperation is 1 and all of the following statements are true:
 - The cut and paste parameter has not been requested. (for example, by the Cut and Paste node.)
 - No digits are to be cut from the calling number. (Specified, for example, by the cut calling number node)
 - The number to be terminated to is exactly the same as the Called Party Number received in the InitialDP.
 - Calling Party Number has been specified for the Connect or the Calling Party Number to go in the connect is exactly the same as the Calling Party Number received in the InitialDP.
 - No Original Called Party ID has been specified for the Connect or the Original Called Party ID to go in the connect is exactly the same as the Original Called Party ID received in the InitialDP.
 - No Redirecting Party ID has been specified for the Connect or the Redirecting Party ID to go in the connect is exactly the same as the Redirecting Party ID received in the InitialDP.
 - No extensions are to be sent in the Connect.
 - The oMidCall event detection point has not been armed.
 - The InitialDP operation has been triggered from the AnalyzedInformation detection point or from the TermAttemptAuthorized detection point or from a collectedInfo detection point.
 - No redirection information is to be sent in the Connect
 - suppressionOfAnnouncement is to be sent in the Connect
 - oCSIApplicable is to be sent in the Connect

Example: UseContinueOperation 0

UseLanguageExtensions

- Description:** This indicates whether or not the language features of the SRF are used to set the language in which the SRF plays the announcement.
- Default:** 0
- Allowed:** 0 (Disabled), 1 (Enabled)

UseReplication

- Description:** This determines whether ACS should use the replication system to update the database, or should write directly to the database.
- Default:** 1
- Allowed:** 0 If the SMF has been installed on the same machine as the SCP and if they share the same database installation
1 If the SCP is a separate machine from the SMF

PIN Logging Parameters

The following parameters are optional and may be added when required.

PINLogEnable

- Description:** If enabled, `slee_acs` will log the PIN to a separate PIN file - `/IN/service_packages/SMS/cdr/current/PIN_yyyymmddhhmmss_pid.txt`
Where:
- `yyymmddhhmmss` is the date and time the file was opened
 - `pid` is the process id for the `slee_acs` process which is writing to the file
- This file is periodically moved to `/IN/service_packages/SMS/cdr/closed/`.
If disabled, no PIN logging is done and other PINLog entries in the `acs.conf` file are ignored.
- Type:** Boolean
- Default:** 1
- Allowed:** 0 (Disabled), 1 (Enabled)

PINLogFail

- Description:** If enabled, `slee_acs` will log all unsuccessful PIN attempts to the PIN file.
- Default:** 1
- Allowed:** 0 (Disabled), 1 (Enabled)

PINLogMaxAge

- Description:** The time (in seconds) before `slee_acs` will close the file and move it to `/IN/service_packages/SMS/cdr/closed/`.
- Default:** 3600
- Allowed:** Any non zero, positive integer.

PINLogMaxSize

- Description:** The size (in KB) before `slee_acs` will close the file and move it to `/IN/service_packages/SMS/cdr/closed/`.
- Default:** 8
- Allowed:** Any non zero positive integer.

PINLogSuccess

- Description:** If enabled, `slee_acs` will log all successful PIN attempts to the PIN file.
- Default:** 0
- Allowed:** 0 (Disabled), 1 (Enabled)

Call Dump Parameters

The following parameters are optional and may be added when required.

CallDumpEnabled

Description: Is call dumping enabled?
Default: 0
Allowed: 0 (no), 1 (yes)

CallDumpSeconds

Description: Minimum number of seconds between generating call dumps.
Default: 60 (means no limit)
Allowed:

CallDumpDir

Description: Output directory for call dump files.
Default: "/tmp"
Allowed: Any valid directory.

CallDumpSeverity

Description: Error level threshold to reach in generated syslog message to trigger call dump.
Default: ERROR
Allowed:

- Notice
- Warning
- Error
- Critical

Notes: Not currently used for this purpose. If set to ERROR or below, then call dumps will be generated by the "handleInternalError" function in the SLEE chassis.

CallDumpMessage

Description: Sub-string to match in generated syslog message to trigger call dump. Not currently implemented. Reserved for future use.
Default: ""
Allowed:

Call Information Report Parameters

The following parameters are optional and may be added when required.

SendCIR

Description: This is the primary flag for controlling the sending of the Call Information Report.
Default: 0
Allowed:

- 0 No logging will be done.
- 1 Chassis data that is produced during execution of a control plan will be logged and placed in the EDR.

Notes: The format for the logging is customer-specific and is set up at installation.

Chapter 5

AskCirAttemptElapsedTime

Description: This indicates report inclusion of how long is spent attempting to connect (that is, ringing).
Default: 1
Allowed: 0 (Not included), 1 (Included)

AskCirStopTime

Description: This indicates report inclusion of a call finish time.
Default: 1
Allowed: 0 (Not included), 1 (Included)

AskCirConnectElapsedTime

Description: This indicates report inclusion of the elapsed time of a call.
Default: 1
Allowed: 0 (Not included), 1 (Included)

AskCirCallAddress

Description: This indicates report inclusion of the called number.
Default: 1
Allowed: 0 (Not included), 1 (Included)

AskCirReleaseCause

Description: This indicates report inclusion of the cause of the release.
Default: 1
Allowed: 0 (Not included), 1 (Included)

NokiaCIR

Description: If enabled, ACS will use Nokia CIR sending rules.
Default: 0
Allowed: 0 (disabled), 1 (enabled)

usePendingTnForCaInCdr

Syntax: usePendingTnForCaInCdr 0|1
Description: Sets whether or not to use the pending TN value in the CA field in the ACS CDR.
Type: Boolean
Optionality: Optional (default used if not set)
Allowed: 0 – Do not use the pending TN value to set the CA field in the ACS CDR.
1 – When AskCirCallAddress is set to false, use the pending TN value to set the CA field in the ACS CDR.
Default: 0
Example: usePendingTnForCaInCdr 0

Statistics Captured

A range of statistics are gathered automatically by the ACS service. These statistics are gathered by the ACS service logic and stored in the SMS database through the SMS statistics mechanism.

To gather any of these statistics, the `acs.conf` configuration parameter `recordSmpStatistics` (on page 102) must be set to 1.

Statistic	Description
CALLS_INITIATED	<p>This statistic counts the number of calls that successfully encountered by the ACS service loader. It is incremented by one for each call that is loaded by the ACS service loader, and incremented before any service logic (such as loading a control plan) is done.</p> <p>This statistic is only incremented when the ACS service library is involved in the call.</p>
CALLS_UNMATCHED_CLI	<p>This statistic counts the number of calls whose CLI cannot be matched to a control plan. If the service initiated is 'ACS_Outgoing', and a control plan cannot be found in the DB that links successfully to the CLI of the IDP of the call, this statistic is incremented by one.</p> <p>A successful link between CLI and control plan requires the CLI to be linked to a control plan, the control plan to be scheduled to be available at the time of the call, and the control plan to be successfully compiled.</p> <p>This statistic is only incremented when the ACS service library is involved in the call.</p>
CALLS_MATCHED_CLI	<p>This statistic counts the number of calls whose CLI successfully matches a control plan and where the control plan is loaded successfully. This statistic is incremented by one for each call which is passed onto the control plan engine for call processing.</p> <p>This statistic is only incremented when the ACS service library is involved in the call.</p>
CALLS_UNMATCHED_SN	<p>This statistic counts the number of calls whose service number (SN) cannot be matched to a control plan. If the service initiated is 'ACS' or 'ACS_Management', and a control plan cannot be found in the DB that links successfully to the SN of the IDP of the call, this statistic is incremented. by one.</p> <p>A successful link between SN and control plan requires the SN to be linked to a control plan, the control plan to be scheduled to be available at the time of the call, and the control plan to be successfully compiled.</p> <p>This statistic is only incremented when the ACS service library is involved in the call.</p>
CALLS_MATCHED_SN	<p>This statistic counts the number of calls whose SN successfully matches a control plan and where the control plan is loaded successfully. This statistic is incremented by one for each call which is passed onto the control plan engine for call processing.</p> <p>This statistic is only incremented when the ACS service library is involved in the call.</p>
CALLS_UNMATCHED_NAMED_CALLPLAN	<p>This statistic counts the number of times a call is made to a service (as defined as a service in the ACS configuration file) which is not one of 'ACS', 'ACS_Outgoing' or 'ACS_Management' but which does not have a control plan associated with the service.</p> <p>The service name should match the name of the control plan exactly, otherwise the control plan will not be found.</p> <p>This statistic is only incremented when the ACS service library is involved in the call.</p>
CALLS_MATCHED_NAMED_CALLPLAN	<p>This statistic counts the number of times a call is made to a service (as defined as a service in the ACS configuration file) which is not one of 'ACS', 'ACS_Outgoing' or 'ACS_Management' and for which a control plan is successfully found in the ACS database.</p> <p>The service name should match the name of the control plan exactly, otherwise the control plan will not be found.</p>

Statistic	Description
	This statistic is only incremented when the ACS service library is involved in the call.
CALLS_INVOKING_CALLPLAN	This statistic is incremented by one each time a control plan is successfully loaded for call processing by the ACS service loader. The sum of CALLS_MATCHED_SN, CALLS_MATCHED_CLI and CALLS_MATCHED_NAMED_CALLPLAN should equal the value of this statistic. This statistic is only incremented when the ACS service library is involved in the call.
CALLS_DISCONNECTED	This statistic is incremented each time a call is ended by sending a CS1ReleaseCall message to the SSP to disconnect the call.
CALLS_UT	This statistic is incremented each time a call is ended by sending a CS1Connect message to the SSP without an event report requested. It is incremented for each unconditional terminate done by the ACS service logic. Note that for a call, the CALLS_AT and CALLS_UT statistic can both be incremented as an unconditional terminate can occur after an attempt terminate.
CALLS_AT	This statistic is incremented each time a call is ended by sending a CS1Connect message to the SSP with an event report requested. It is incremented for each terminate attempt done by the ACS service logic. Note that for a call, the CALLS_AT and CALLS_UT statistic can both be incremented as an unconditional terminate can occur after an attempt terminate. In the same manner, one call can increment this statistic multiple times.
ANNOUNCEMENTS_PLAYED	This statistic increments each time a CS1 PlayAnnouncement or PromptAndCollect message is sent to the SSP. This statistic is only incremented once per message, not once per actual announcement played. This statistic is also incremented when mid-call announcements are played.

Extra Statistics

The following extra statistic definitions have been defined for application "Acs_Service". These statistics are turned off by default. Turn them on by setting the acsChassis parameter `extraStats` (on page 97) to 1. For each required extra statistic, turn the statistic on using the SMS Statistics Management screen (see *SMS User's Guide*).

Statistic	Description
CALLS_AT_ABORT	Number of Attempt Termination Actions performed by ACS that were aborted.
CALLS_AT_ANSWER	Number of Attempt Termination Actions performed by ACS that were answered.
CALLS_AT_BUSY	Number of Attempt Termination Actions with a busy response.
CALLS_AT_NO_ANSWER	Number of Attempt Termination Actions performed by ACS that were not answered.
CALLS_AT_RSF	Number of Attempt Termination Actions with a route selection failure response.
CALLS_CHG_ABORT	Number of Termination and Charging actions performed by ACS that were aborted.
CALLS_CHG_ANSWER	Number of Termination and Charging actions performed by ACS that were answered.
CALLS_CHG_BUSY	Number of Termination and Charging actions with a busy response.
CALLS_CHG_COUNT	Number of Termination and Charging actions performed by ACS Chassis.
CALLS_CHG_HOLD_TIME	Total charged time of Termination and Charging actions performed by ACS

Statistic	Description
	Chassis.
CALLS_CHG_NO_ANSWER	Number of ACS Termination and Charging actions that were not answered.
CALLS_CHG_RSF	Number of Termination and Charging actions with route select failure response.
CALLS_ETC_COUNT	Number of temporary connections established (for example, for announcements).
CALLS_ETC_HOLD_TIME	Total duration of established temporary connections.
PROMPT_AND_COLLECT	Total number of Play Announcement and Collect User Input operations performed.

acsStatsLocal (SLC)

Introduction

The `acsStatsLocal` takes a request from the chassis and passes it on to the `acsStatsMaster`, so that the chassis is able to continue processing calls. Once a reply has been received, the `acsStatsLocal` informs the chassis that it has a result.

Parameters

The following parameters must be configured with the correct value.

`masterStatsServer`

Description: Host name of the machine running the master stats server.
Default: No default
Allowed: Any string representing a host name, but must be the same as the `masterStatsServer` (on page 86) of the `acsStatsMaster` section. For example, `scp1.telconame.com`

`port`

Description: Port on which the stats master listens for connection attempts.
Default: 1490
Allowed: Must be the same as the `port` (on page 86) of the `acsStatsMaster` section.

acsChassis Emergency Numbers (SLC)

Parameters

This parameter will assume the default value if it is not configured. This parameter may have multiple entries.

`EmergencyNumber`

Syntax: `EmergencyNumber string`
Description: Enter the emergency numbers for the network. The emergency number parameters are loaded by the ACS Chassis for use by the service libraries.
Default:
Allowed: There is no checking on the values. However, non-numeric strings as values

should have no effect on the processing of the service.

Notes: Emergency numbers represent destination numbers that the service libraries should not intercept on originating calls. If a service library (ACS/VPN/ABS) receives a line-based call-origination trigger with a destination in the list of emergency numbers, the service library will inform the Chassis that it is to send a Continue back to the SSP.

Example: There can be multiple entries.
`EmergencyNumber 911`
`EmergencyNumber 111`
`EmergencyNumber 0, ...`

acsChassis INAP Extension Parameters

Introduction

Extension numbers are defined in INAP. A network operator or switch manufacturer may specify arbitrary pieces of extra information to appear in the InitialDP, each identified by an integer type.

Parameters

Use in the following format:

Usage:

```
extensionNumber Number ID [sequence] Type Subfield,Subfield,... [Context Tag]
```

Notes:

The INAP number is a telephone number format, as defined in the ISUP ITU-T recommendations.

The INAP address string is a telephone number format, as defined in the MAP ITU-T recommendations.

Number

Description: The number of the `extensionNumber`. This limit is hard coded into the source. It is simply to separate each `extensionNumber` so they can be chosen in the CPE.

Default: No default

Allowed: 0 to 9 inclusive

ID

Description: The identification number of the `extensionNumber`. This is used to identify extensions between clients and servers.

Default: No default

Allowed: The range is imposed by the TC_PROTOS implementation and each must be unique within the configuration file.

Sequence

Description: If the keyword 'sequence' is added before the type, `slee_acs` expects the `extensionNumber` it wants wrapped in a sequence tag (as defined in the ITU ASN.1 standard, X.209). In such cases, the context tag to expect must be given.

Default: No default

Allowed: 'sequence', or nothing

Type

Description: The type of `extensionNumber`. This indicates what sort of information is expected.

Default: No default

Allowed:

- `inapnumber`
- `inapaddressstring`
- `inaptbcdstring`
- `asn1integer`
- `asn1enumerated`
- `asn1boolean`
- `asn1octetstring`
- `octets`
- `inapgenericnumber`
- `mapsmssubmit`

Notes: See `Subfield - Type` table for meanings.

Subfield

Description: The sub field is particular to the type of `extensionNumber`. This sub field data indicates what data is expected when the `extensionNumber` is used. At least one sub field must be specified and if several sub fields are specified then separate each subfield with a comma.

Default: No default

Allowed: See table.

Notes: For those that have no sub fields defined in the standard a placeholder is used. The word 'value' needs to be used as a sub field.

This table lists full details of all the options:

Type	Sub field	# of Digits	Meaning
<code>inapNumber</code>	<code>digits</code>	<code>n</code>	The actual digits
	<code>nqi</code>	1	Number qualifier indicator
	<code>nature</code>	2	Nature of address
	<code>innOrNi</code>	1	emergency network number or number incomplete indicator
	<code>plan</code>	1	Numbering plan
	<code>present</code>	1	presentation restricted indicator
	<code>screening</code>	1	screening indicator
<code>inapAddressString</code>	<code>digits</code>	<code>n</code>	The actual digits
	<code>extension</code>	1	Extension
	<code>nature</code>	1	Nature of address
	<code>plan</code>	1	Numbering plan
<code>inaptbcdstring</code>			
<code>asn1Integer</code>	<code>value</code>	2*	Hex representation of the integer

Type	Sub field	# of Digits	Meaning
		sizeof(int) (usually 8)	for example, "0000002E" for 2E hex
asn1Enumerated	value	2 * sizeof(int) (usually 8)	Hex representation of the integer for example, "0000002E" for 2E hex
asn1Boolean	value	1	1 for true, 0 for false
asn1Octet String	value	n	Hex representation of the octet string
octets	value	n	Octet string raw data
mapsmssubmit	plan	1	Numbering plan
	digits	n	The actual digits
inapGenericNumber	digits	n	The actual digits
	nqi	1	Number qualifier indicator
	nature	2	Nature of address
	innOrNi	1	emergency network number or number incomplete indicator
	plan	1	Numbering plan
	present	1	presentation restricted indicator
	screening	1	screening indicator

Context Tag

Description:	This context tag can be specified to override the universal default tag.
Optionality:	Optional
Default:	No default
Allowed:	The context tag is defined as a hex number. For example, 55 is the hex number 0x55, rather than the decimal number 55.
Notes:	Usually, the <code>extensionNumber</code> is identified by a universal tag, which depends on the type of extension it is. Sometimes though a site will wish to define a unique special tag, and create a context specific tag for an extension. If this is the case, <code>slee_acs</code> must know about this and it can be specified by adding the context specific tag to the end of the extension line.

Extension Numbers Example

Nokia uses the following extension digits:

- IMSI type 26
- MSRN type 28
- `tp_da` field type 47

Example 1

```
extensionNumber 0 26 inapaddressstring digits
```

This entry in the `acs.conf` instructs the system to copy the digits out of extension type 26 into extension slot 0. (The number matching node can then route on these digits, by selecting extension slot 0 in the pull down list.)

Example 2

```
extensionNumber 1 28 inapaddressstring extension,nature,plan,digits
```

The following MSRN digits are copied into extension slot 1:

1 digit representing extension, 1 digit representing nature, 1 digit representing numbering plan + the actual digits.

Example 3

```
extensionNumber 0 47 mapsmsssubmit type,plan,digits
```

The extension type "mapsmsssubmit" allows a parameter of this type, and specifically the "tp_da" field, to be picked from extension digits in the IDP for source selection purposes.

acsChassis Normalization Parameters (SLC)

NOA and Normal Rules

The NOA (nature of address) is a classification to determine in what realm (Local, National, or International) a given phone number resides, for the purposes of routing and billing.

Note: Details vary between different implementations of phone systems, but the following table is representative.

Dialed Digits	NOA (aka NOC, NON)	Definition
477 9425	1 ==> Subscriber	Number within Local Telephone Exchange
4 477 9425	3 ==> National	Number within Country Telephone Exchange
64 4 477 9425	4 ==> International	Number within World Telephone Exchange
477 9425	2 ==> UNKNOWN	Numbering Scheme rule ==> Subscriber
0 4 477 9425	2 ==> UNKNOWN	Numbering Scheme rule ==> National
00 64 4 477 9425	2 ==> UNKNOWN	Numbering Scheme rule ==> International

In essence, the subscriber's telephone system *may* try to ascertain the NOA by examining the dialed digits. If they are understood by "built-in" mechanisms, the NOA can unambiguously be a Subscriber, National, International, or finer classification determined by the protocol variant.

Otherwise, the NOA is unknown and the dialed digits must be made unambiguous by a set of rules specified by a numbering scheme.

Leading zeros are often ignored, but the leading characters could be any arbitrary sequence that the numbering scheme could specify.

Ultimately, the usage of NOA is determined by the phone network itself, which may classify and possibly modify a phone number while it is being transmitted between the service logic and the switch.

Number Normalization and Denormalization

People deal with, and a database usually stores, telephone numbers in their normalized form. However, the network gives and receives numbers in a denormalized form where the NOA is known explicitly.

Example:

Normalized number:	00441918666223	
De-Normalized number:	Nature of Address:	International
	Digits:	441918666223

Possible Natures of Addresses:

Subscriber (local)	(is 1 with ITU/ETSI CS-1)
Unknown	(is 2 with ITU/ETSI CS-1)
National	(is 3 with ITU/ETSI CS-1)
International	(is 4 with ITU/ETSI CS-1)

Global and Service Specific Normalization

You can define how the ACS framework normalizes and denormalizes numbers at a global level and at the service level. Global rules are defined within the `acsChassis` section, while specific service rules are defined in separate service sections in the `acs.conf` file (that is, defined by the `ServiceEntry` parameters).

Global normalization rules supersede rules for specific services.

Normalization Parameters

Normalization and denormalization rules are defined in the `acs.conf` file by using the following parameters:

`NormalUnknownNOA`

- Syntax:** `NormalUnknownNOA num`
- Description:** Specifies the NOA to use for phone numbers when the NOA is unknown.
- Type:** Integer
- Optionality:** Optional (default used if not set)
- Allowed:**
 - 1 – Subscriber
 - 2 – Unknown
 - 3 – National
 - 4 – International
- Default:** No default
- Notes:** The rules to normalize and denormalize numbers is set up separately. There is no single configuration option to do both.
- Example:** `NormalUnknownNOA 2`

`NormalUseHex`

- Syntax:** `NormalUseHex num`
- Description:** Specifies whether the converted number is a hexadecimal value or a decimal value.
- Type:** Integer
- Optionality:** Optional (default used if not set)
- Allowed:**
 - 0 – Decimal value
 - 1 – Hexadecimal value
- Default:** 0
- Notes:**
- Example:** `NormalUseHex 1`

NormalisationRule

Syntax:	NormalisationRule (<i>inNOA</i> , <i>inPrefix</i> , <i>noOfDigitsToRemove</i> , <i>outPrefix</i> [, <i>minLength</i> , <i>maxLength</i> , <i>prefixSource</i>])
Description:	<p>Defines a rule for converting incoming (denormalized) numbers to normalized numbers.</p> <p>Normalization rules are applied to incoming numbers that match the following array parameters:</p> <ul style="list-style-type: none"> • <i>inNOA</i> – Specifies the required realm for incoming numbers to trigger normalization. Allowed values are 1 (Subscriber), 2 (Unknown), 3 (National), and 4 (International). This array parameter is mandatory. • <i>inPrefix</i> – Specifies the required prefix for incoming phone numbers. Allowed values include integers 0 through 9, letters A through F, and special characters hashtag (#), asterisk (*), and dash (-). A value of dash (-) specifies to match any prefix. This array parameter is mandatory. • <i>minLength</i> – Specifies the minimum length for incoming phone numbers. This array parameter is optional. The default is 1. If you add this array parameter, you must also add the <i>maxLength</i> array parameter. • <i>maxLength</i> – Specifies the maximum length for incoming phone numbers. This array parameter is optional. The default is 32. If you add this array parameter, you must also add the <i>minLength</i> array parameter. • <i>prefixSource</i> – Specifies a single character that represents the buffer from which to grab the prefix that is added to the normalized number. It uses standard source selection rules (but only allows a single character, rather than string of characters). The value is one of the following digits: aAcCfFlliLnMmNdDgGoOvV0-9. See <i>acsChassis ServiceEntry Configuration (SCP)</i> (on page 123) for a definition of each character. If you add this array parameter, you must also add the <i>minLength</i> and <i>maxLength</i> array parameters. <p>The rules to apply to the incoming phone number are specified in the following array parameters:</p> <ul style="list-style-type: none"> • <i>noOfDigitsToRemove</i> – Specifies the number of digits to remove from the beginning of the phone number. This array parameter is mandatory. • <i>outPrefix</i> – Specifies the digits to add to the beginning of the phone number. This operation is performed after the digits are removed for <i>noOfDigitsToRemove</i>. Allowed values include integers 0 through 9, letters A through F, and special characters hashtag (#), asterisk (*), and dash (-). This array parameter is mandatory.
Allowed:	Valid list of parameters
Type:	Array of parameters
Optionality:	Optional
Default:	No default
Notes:	Normalization rules are applied based on the best match for the number and NoA, and the value of <i>inPrefix</i> . The rule with the longest matching <i>inPrefix</i> value is applied. If more than one rule matches the same <i>inPrefix</i> value, the last rule in the list of matching rules is applied.
Example:	NormalisationRule (4,0,0,000)

DenormalisationRule

Syntax:	<pre>DenormalisationRule (inPrefix, outNOA, noOfDigitsToRemove, outPrefix[, MinLength, MaxLength, prefixSource]) DenormalisationRule (noa, inNOA, inPrefix, outNOA, noOfDigitsToRemove, outPrefix[, MinLength, MaxLength, prefixSource])</pre>
Description:	<p>Defines a rule for converting normalized (internal) numbers to (outgoing) denormalized numbers.</p> <p>Denormalization rules are applied to outgoing numbers that match the following array parameters:</p> <ul style="list-style-type: none"> • <i>noa</i> – Enter the literal string "noa" in lower-case characters. • <i>inNOA</i> – Specifies the required realm for numbers to trigger denormalization. Allowed values are 1 (Subscriber), 2 (Unknown), 3 (National), and 4 (International). This array parameter is mandatory. • <i>inPrefix</i> – Specifies the required prefix for numbers to trigger denormalization. Allowed values include integers 0 through 9, letters A through F, and special characters hashtag (#), asterisk (*), and dash (-). A dash (-) means that all number prefixes can trigger denormalization. This array parameter is mandatory. • <i>minLength</i> – Specifies the minimum phone number length that triggers denormalization. This array parameter is optional. The default is 1. If you add this array parameter, you must also add the <i>maxLength</i> array parameter. • <i>maxLength</i> – Specifies the maximum phone number length that triggers denormalization. This array parameter is optional. The default is 32. If you add this array parameter, you must also add the <i>minLength</i> array parameter. <p>The rules to apply to the incoming phone number are specified in the following array parameters:</p> <ul style="list-style-type: none"> • <i>outNOA</i> – Sets the realm for outgoing denormalized numbers. Allowed values are 1 (Subscriber), 2 (Unknown), 3 (National), and 4 (International). This array parameter is mandatory. • <i>noOfDigitsToRemove</i> – Specifies the number of digits to remove from the beginning of the phone number. This array parameter is mandatory. • <i>outPrefix</i> – Specifies the digits to add to the beginning of the phone number. This operation is performed after the digits are removed for <i>noOfDigitsToRemove</i>. Allowed values include integers 0 through 9, letters A through F, and special characters hashtag (#), asterisk (*), and dash (-). This array parameter is mandatory. • <i>prefixSource</i> – Specifies a single character that represents the buffer from which to grab the prefix that is added to the denormalized number. It uses standard source selection rules (but only allows a single character, rather than string of characters). The value is one of the following digits: aAcCfFlllLnMmNdDgGoOvV0-9. See <i>acsChassis ServiceEntry Configuration (SCP)</i> (on page 123) for a definition of each character. If you add this array parameter, you must also add the <i>minLength</i> and <i>maxLength</i> array parameters.
Default:	No denormalization
Type:	Array of parameters
Optionality:	Optional
Allowed:	Valid list of parameters following either the first or second format.

Notes: There are NO spaces within either rule format.
Example: `DenormalisationRule (800,3,0,-,7,9)`
`DenormalisationRule (noa,3,E,4,0,999)`

`normaliseTerminationNumber`

Syntax: `normaliseTerminationNumber num`
Description: Set the engine's terminationNumber, which is printed as TN in the EDR.
Type: Integer
Allowed:

- 0 – The digits sent over the network in the connect.
- 1 – The normalized number sent to the service loader.

Optionality: Optional (default used if not set)
Default: 0
Notes: This parameter is specified at the global level only.
Example: `normaliseTerminationNumber 1`

`normaliseServiceNumber`

Syntax: `normaliseServiceNumber num`
Description: Specifies the EDR service number, which is printed as SN in the EDR.
Type: Integer
Allowed:

- 0 – The digits received over the network in the IDP.
- 1 – The normalized number received from the service loader.

Optionality: Optional (default used if not set)
Default: 0
Notes: This parameter is specified at the global level only.
Example: `normaliseServiceNumber 1`

Play Variable Part Announcement Feature Node Denormalization Rules

If you configure the Play Variable Part Announcement feature node to denormalize numbers, it denormalizes numbers according to the rules specified in the following area of the `acs.conf` file. The node uses the sections in the priority shown below.

- 1 The `NumberRulesSection` parameter in the `acsPlayVariablePartAnnouncement` section
- 2 The `NumberRulesInteraction` section

For example:

```
acsPlayVariablePartAnnouncement
  NumberRulesSection NumberRulesPNAN
  :
NumberRulesPNAN
  DenormalisationRule (62,2,2,-)
  DenormalisationRule (-,2,0,00)
  :
```

If no denormalization rule matches, the number is played in its normalized form.

Example 1

The following shows an example normalization rule.

```
NormalisationRule (4,-,2,10,7,14)
```

This normalization rule specifies to apply the rule to incoming numbers with:

- An NOA of 4 (International)
- Any prefix
- A minimum of 7 digits
- A maximum of 14 digits

When a number matches the criteria, the ACS framework removes the first two digits from the number and then prefixes the number with 10. For example, the incoming number [International, "006449391234"] is normalized to "106449391234".

Example 2

The following shows an example normalization rule.

```
NormalisationRule (3,-,2,-,10,14,m)
```

This normalization rule specifies to apply the rule to incoming numbers with:

- An NOA of 3 (National)
- A minimum of 10 digits
- A maximum of 14 digits
- An MSC address with a prefix in the `countryCodes` list (see *countryCodes* (on page 47))

When a number matches the criteria, the ACS framework removes the first two digits from the number and then prefixes the number with the country code prefix from the MSC address. For example, the incoming number [National, "006475551212"] is normalized to "656475551212".

Note: For this example to work, you must have also configured the `countryCodes` parameter in the SLC's `eserv.config` file.

Example 3

The following shows an example denormalization rule.

```
DenormalisationRule (0,3,1,-,7,14)
```

This denormalization rule specifies to apply the rule to outgoing numbers with:

- A prefix of 0
- A minimum of 7 digits
- A maximum of 14 digits

When a number matches the criteria, the ACS framework removes the first digit from the number and sets the NOA to 3 (National). For example, the number "049391234" is denormalized to [National, "49391234"].

Example 4

The following shows an example denormalization rule.

```
DenormalisationRule (noa,3,-,4,0,999)
```

This denormalization rule specifies to apply the rule to outgoing numbers with:

- An NOA of 3 (National)
- Any prefix

When a number matches the criteria, the ACS framework removes the first four digits from the number, sets the NOA to 4 (International), and adds 999 to the beginning of the number. For example, the number [National, "1837504857"] is denormalized to [International, "999504857"].

acsChassis SLEE Event Size Parameter (SLC)

Introduction

The `minimumSizeOfConnectSleeEvent` parameter defines the minimum size for SLEE events containing connect operations from ACS.

You define the `minimumSizeOfConnectSleeEvent` parameter globally in the `acsChassis` section of `acs.conf`. You can also override the global value on a per service basis by defining an override value for the parameter in the service configuration.

For more information, see *Configuring minimumSizeOfConnectSleeEvent Per Service* (on page 130).

Important: For this configuration to work, you must also define `MAXEVENTS` in `SLEE.cfg` of at least the sizes specified for `minimumSizeOfConnectSleeEvent`.

`minimumSizeOfConnectSleeEvent`

Syntax:	<code>minimumSizeOfConnectSleeEvent event_size</code>
Description:	Sets the minimum size in bytes for SLEE events containing connect operations. You can override the global definition for the minimum size for a service by including a definition for this parameter in the service configuration.
Type:	Integer
Optionality:	Optional (default used if not set).
Allowed:	A valid integer
Default:	1024
Notes:	You must also configure <code>MAXEVENTS</code> in the <code>SLEE.cfg</code> file for each <code>minimumSizeOfConnectSleeEvent</code> definition, using the same value or a higher value.
Example:	<code>minimumSizeOfConnectSleeEvent 16384</code>

acsChassis ServiceEntry Configuration (SLC)

Introduction

A service entry is a line in `acs.conf` telling `slee_acs` how to handle new calls arriving from the SLEE. A service entry specifies:

- Which service loader should handle calls from which SLEE service handle
- How the InitialDP parameters are translated into the call context and outgoing Connect variables

Service loaders:

- Load control plans, profiles, etc
- Copy InitialDP parameters to ACS call context variables
- Construct outgoing Connects

Note: The SLEE service handle is derived from the `SLEE.cfg` file. They are based on the:

- INAP service key in the InitialDP
- Originating SCCP sub-system number of the message containing the InitialDP

For more information about `SLEE.cfg` service handles, see *SLEE Technical Guide*.

Syntax

In `acs.conf`, `ServiceEntry` lines may take one of the following forms.

First form

```
ServiceEntry (ServiceName, libname)
```

Second form

```
ServiceEntry (ServiceName, CallType, libname)
```

Third form

```
ServiceEntry (ServiceName, NetworkCPSource, LogicalCPSource, libname)
```

Fourth form

```
ServiceEntry (ServiceName, NetworkCPSource, LogicalCPSource, ConnectCLISource, libname)
```

Fifth form

```
ServiceEntry (ServiceName, NetworkCPSource, LogicalCPSource, PendingTNSource, ConnectCLISource, libname)
```

Sixth form

```
ServiceEntry (ServiceName, NetworkCPSource, LogicalCPSource, PendingTNSource, ConnectCLISource, RedirectingPartyID, libname)
```

Seventh form

```
ServiceEntry (ServiceName, NetworkCPSource, LogicalCPSource, PendingTNSource, ConnectCLISource, RedirectingPartyID, OriginalCalledPartyID, libname)
```

Parameters

Here are the definitions for each parameter.

ServiceName

Syntax:	See Allowed.
Description:	This is the name of the service this entry defines. This parameter is used to identify the control plan to use.
Type:	String
Optionality:	Required
Allowed:	<p>ACS <code>slee_acs</code> uses the service number (usually derived from the called party number) in the <code>ACS_SN_CALL_PLAN_ACTIVATION</code> table.</p> <p>a string containing <code>ACS_Outgoing</code> <code>slee_acs</code> uses the logical calling party number in the <code>ACS_CLI_CALL_PLAN_ACTIVATION</code> table.</p> <p>Note: Must match the service handle name in the SLEE configuration file (<code>slee.cfg</code>) for this application.</p>
Default:	None
Notes:	
Example:	<code>MO_ACS_Outgoing</code>

CallType

Syntax:	<i>Type</i>
Description:	The type of the call. This parameter is used to identify the control plan to use.
Type:	String
Optionality:	If using the second <code>ServiceEntry</code> form, this parameter is required. This parameter cannot be set in any other form.

Allowed:	ACS	If the service handle is "ACS", <code>slee_acs</code> uses the service number (usually derived from the called party number) in the <code>ACS_SN_CALL_PLAN_ACTIVATION</code> table.
	ACS_Outgoing	If the service handle contains "ACS_Outgoing", <code>slee_acs</code> uses the logical calling party number in the <code>ACS_CLI_CALL_PLAN_ACTIVATION</code> table.
	<i>FixedControlPlanName</i>	A string which corresponds to a control plan name.
Default:	None	
Notes:	Usage 2 form is deprecated. If used, the <code>callType</code> parameter is ignored, and an alarm is produced: <code>acsParseServiceLine. acs.conf</code> contains old <code>ServiceEntry</code> <code>fmt - field2</code> ignored.	
Example:	<code>MO_ACS_Outgoing</code>	

NetworkCPSource

Description:	Sets the CC Calling Network Address call context variable.
Type:	String
Optionality:	If using the third, fourth, fifth, sixth and seventh <code>ServiceEntry</code> forms, this parameter is required. This parameter cannot be set in any other form.
Allowed:	See <i>Extraction Sources in IDP</i> (on page 127).
Default:	CANLcanl
Notes:	CC Calling Network Address can be selected in CPE feature node configuration screens. It describes the location of the calling party relative to the network. This parameter defines where the subscriber is. This is used in the Geographical Routing feature node. It can also be used in other services (for example, for CLIXDN tables in CCS, to calculate how much the call will cost). <code>NetworkCPSource</code> and <code>LogicalCPSource</code> can be the same. They will be different when the calling party has call-forwarded or is roaming internationally.
Example:	LCANlcan

LogicalCPSource

Description:	Sets the CC Calling Logical Number call context variable.
Type:	String
Optionality:	If using the third, fourth, fifth, sixth and seventh <code>ServiceEntry</code> forms, this parameter is required. This parameter cannot be set in any other form.
Allowed:	See <i>Extraction Sources in IDP</i> (on page 127).
Default:	ILcCaAnN
Notes:	CC Calling Logical Number can be selected in CPE feature node configuration screens. It describes the identity of the calling party. This parameter defines who the subscriber is and, for billing purposes, who will pay. This is used in the Call Filtering feature node. <code>NetworkCPSource</code> and <code>LogicalCPSource</code> can be the same. They will be different when the calling party has call-forwarded or is roaming internationally.

Example: cClLaAnN

PendingTNSource

Description: Sets the CC Pending Termination Number call context variable.
Type: String
Optionality: If using the fifth, sixth and seventh `ServiceEntry` forms, this parameter is required.
This parameter cannot be set in any other form.
Allowed: See *Extraction Sources in IDP* (on page 127).
Default: dD
Notes: CC Pending Termination Number can be selected in CPE feature node configuration screens. If it is not changed during a control plan, it is used to populate the `destinationRoutingAddress` (DRA) parameter in Connect operations sent to the SSP.
Example: fFdD

ConnectCLISource

Description: Sets the `callingPartyNumber` in Connect operations which are sent to the SSP.
Type: String
Optionality: If using the fourth, fifth, sixth and seventh `ServiceEntry` forms, this parameter is required.
This parameter cannot be set in any other form.
Allowed: See *Extraction Sources in IDP* (on page 127).
Default: E
Example: cC

RedirectingPartyID

Description: Populates the `redirectingPartyID` parameter in Connect operations which are sent to the SSP.
Type: String
Optionality: If using the sixth and seventh `ServiceEntry` forms, this parameter is required.
This parameter cannot be set in any other form.
Allowed: See *Extraction Sources in IDP* (on page 127).
Default: ILE
Example: cC

OriginalCalledPartyID

Description: Populates the `originalCalledPartyID` parameter in Connect operations which are sent to the SSP.
Type: String
Optionality: If using the seventh `ServiceEntry` form, this parameter is required.
This parameter cannot be set in any other form.
Allowed: See *Extraction Sources in IDP* (on page 127).
Default: fFE
Example: fFdD

libname

Syntax: *name*

Description: The name of the `slee_acs` service loader plug-in library to use for this service.

Type: String

Optionality: Required

Allowed:

Default: None

Notes: `slee_acs` will look for the library in all locations specified in the `LD_LIBRARY` environmental variable. This is usually set up in the `.profile` of `acs_oper`.

The service loader library required to run a service application will be installed by the application's packages.

Example: `libacsService.so`

Extraction Sources in IDP

Extraction source settings define where `slee_acs` extracts data to populate the call context and outgoing Connects from. Each letter corresponds to a parameter in the InitialDP. `slee_acs` takes the first valid value, checking each InitialDP parameter in the order the letters appear. This can be used to:

- Set up roaming calls so the called and calling parties are swapped so they can be billed correctly
- Ensure a call context or outgoing Connect variable is present by using more than one source value (for example, using `redirectingPartyID` and `callingPartyNumber` to populate the CC Calling Party Number call context variable)
- Ensure a call context or outgoing Connect is empty

Note: The settings can only be used for these `ServiceEntry` parameters:

- `NetworkCPSource`
- `LogicalCPSource`
- `PendingTNSource`
- `ConnectCLISource`
- `RedirectingPartyID`
- `OriginalCalledPartyID`

Extraction Value Construction

When `slee_acs` constructs the call context or outgoing Connect parameter values from the source InitialDP parameter values, some values are changed. The rules are described in the following table.

Source	InitialDP (IDP) source fields	Digits	Screen	NOA	NII	PRI	NP
a or A *	<code>additionalCallingPartyNumber</code>			See NOA ISUP type			
c or C *	<code>callingPartyNumber</code>			See NOA ISUP type			
d or D *	<code>calledPartyNumber</code>			See NOA ISUP type			
E	Empty	""	0	0	0	0	0
f or F *	<code>originalCalledPartyID</code>			See NOA ISUP type			
g or G	<code>cellIDorLAI</code> (from the Location	See G	0	0	0	0	1

Source	InitialDP (IDP) source fields	Digits	Screen	NOA	NII	PRI	NP
	Information parameter)	digits					
i or I	IMSI		0	2	0	2	1
l or L	redirectingPartyID			See NOA ISUP type			
m or M	mscAddress		0	See NOA MAP type	0	2	
n or N *	locationNumber			See NOA ISUP type			
o or O	Location Number (from the Location Information parameter)			See NOA ISUP type			
v or V	Visitor Location Register (VLR) number (from the Location Information parameter.		0	See NOA MAP type	0	0	
0-9	extensionNumber (for more information on extension numbers, see <i>acsChassis INAP Extension Parameters</i> (on page 114)).	2nd to last digit	0	1st digit	0	0	1

Notes:

An empty cell indicates the source value is copied with no changes.

The sources marked "*" indicate the following:

- lower case - screening indicator provided by user.
- upper case - screening indicator provided by network.

G Digits

The digits sourced from gG are reconstructed into the following format:

MccMncLac[CellID]

Rules are applied as follows:

Digits	Value
1 to 3	MCC (Mobile country code) If country code < 3 digits long, pad to the left of country code with Fs to 3 digits.
4 to 6	MNC (Mobile network code) If network code < 3 digits long, pad to the left of country code with Fs to 3 digits.
7 to 10	LAC - Hex digits of Location Area Code. If LAC is < 4 digits long, pad to the left of LAC with 0s to 4 digits.
11 to 14	CellID - Hex digits of cell ID (if present). If CellID is not present, total length will only be 10 digits.

Examples:

If MCC = 21, MNC=183, LAC=42, and CellID is unset, reconstructed value for gG will be F21183002A.

If MCC = 221, MNC=83, LAC=42, and CellID=10, reconstructed value for gG will be 221F83002A000A.

NOA-MAP Type

The NOA for all the extracted numbers use the ISUP value definitions (see NOA_ISUP type table), however the MAP protocol NOA value is copied with no changes.

Warning: When comparing the MAP and ISUP tables, the incoming MAP NOA type has a different meaning than the NOA ISUP type for the number extracted.

For example, incoming MAP NOA = 1 (international number), outgoing ISUP NOA = 1 (subscriber number (national use)).

Therefore the extracted NOA may cause unpredictable effects if the extracted number is further processed.

This NOA is in the MAP protocol format and will be one of the following values:

NOA	MAP Protocol Type Number Description
0	unknown
1	international number
2	national significant number
3	network specific number
4	subscriber number
5	reserved
6	abbreviated number
7	reserved for extension

Note: These NOA values are used by the v, V, m or M source letters only.

NOA-ISUP Type

This NOA is in the ISUP protocol format and will be one of the following values:

NOA	ISUP Protocol Type Number Description
0	spare
1	subscriber number (national use)
2	unknown (national use)
3	national (significant) number
4	international number
5	network-specific number (national use)

Note: These NOA values are used by the a, A, c, C, d, D, f, F, l, L, n, N, o or O source letters only.

Overriding AWOL Configuration Per Service

It is possible to override the values of three AWOL parameters defined in the acsChassis AWOL configuration section by specifying different values in the service configuration for each service. These parameters are:

- `awolTimeout` (on page 154)
- `awolReportOnly`
- `awolReportPeriod` (on page 156)

Example

Here is an example of the **acs.conf** with AWOL parameters defined globally and the values of three parameters changed at per service level:

```
acsChassis
...
ServiceEntry (CCS_CS,ccsSvcLibrary.so)
ServiceEntry (CCS_SM_MO,nN,cC,dD,dD,ccsSvcLibrary.so)
...
# global AWOL params
checkAWOL 1
checkAWOLMarginAC 90

# global serviceEntry settings that can be overridden on a per serviceEntry basis
awolTimeout 300
awolReportOnly 1
awolReportPeriod 600:

CCS_CS
awolTimeout 400
awolReportOnly 1
awolReportPeriod 900:

CCS_SM_MO
awolTimeout 900
awolReportOnly 1
awolReportPeriod 1800:
```

Configuring minimumSizeOfConnectSleeEvent Per Service

Configure `minimumSizeOfConnectSleeEvent` on a per service basis to override the global configuration defined for it in the `acsChassis` section of **acs.conf**.

For more information on `minimumSizeOfConnectSleeEvent` parameter, see *acsChassis SLEE Event Size Parameter (SLC)* (on page 123).

Example

This example configuration defines a global value for the `minimumSizeOfConnectSleeEvent` parameter in the `acsChassis` section of **acs.conf**, and a service specific entry to override the global value for the `CCS_BPL` service.

In the example, all SLEE events that contain connect operations will be at least 16384 bytes in size. However, if the service is `CCS_BPL`, then these events will be at least 163840 bytes in size because the service specific entry will override the `acsChassis` entry.

```
acsChassis
...
ServiceEntry (CCS_BPL,ccsSvcLibrary.so)
...
# global minimumSizeOfConnectSleeEvent setting that can be overridden on a per
serviceEntry basis
minimumSizeOfConnectSleeEvent 16384

CCS_BPL
# Defines parameters that are specific to the CCS_BPL service
...
minimumSizeOfConnectSleeEvent 163840
```

acsChassis SRF Configuration (SLC)

Introduction

The `srf` parameter defines an SRF (Specialized Resource Function) name which may be referenced in the ACS announcement configuration screens.

srf Parameter Configuration

You configure the `srf` parameter by using the following syntax:

```
srf (srfName,UseETC=Y|N,Address=address_of_IP,NOA=0-4[,TypeOfSrf=string] [,TypeOfIVR=string] [,tcapPreEnd=Y|N])
```

For example:

```
srf (SRF,UseETC=N,Address=123,NOA=4,TypeOfSRF=NAP,TypeOfIVR=CAMEL,tcapPreEnd=Y)
```

`srfName`

Syntax:	<code>srfName</code>
Description:	Unique name for this SRF entry
Type:	String
Optionality:	Required
Allowed:	
Default:	No default
Notes:	Resource Name on the New and Edit Announcement Entry screens must match this entry. For more information about setting up announcements using the ACS screens, see <i>ACS User's Guide</i> .
Example:	NAP1

`UseETC`

Description:	Whether or not to establish a temporary connection directly to an external intelligent peripheral.
Type:	Boolean
Optionality:	Required
Allowed:	Y An external IP is contacted directly from the SLC. This establishes a temporary connection to that IP. N
Default:	N
Notes:	
Example:	UseETC=Y

`Address`

Syntax:	<code>Address=host ip_addr</code>
Description:	This is the hostname or address of an external intelligent peripheral.
Type:	Hostname or IP address
Optionality:	Required You do not need to set a value if the IP is internal to the switch.
Allowed:	

Chapter 5

Default: No default
Notes: Required if `UseETC` is set to `Y`.
If the IP is internal, do not specify any value.
Example: `Address=C400102`

NOA

Syntax: `NOA=value`
Description: The Nature of Address indicator.
Type: Integer
Optionality:
Allowed:

0	spare
1	subscriber number
2	unknown
3	national significant number
4	international significant number

Default: 0
Notes:
Example: `NOA=3`

TypeOfSrf

Syntax: `TypeOfSrf=string`
Description: What type of intelligent peripheral this SRF entry refers to.
Type: String
Optionality:
Allowed:

NAP	
NOKIA	
Nortel	Only required on older Nortel internal SRF implementations.
Other	No SRF-type-specific extensions will be activated.
ZTE	

Default: If `UseLanguageExtensions = Y` and the SRF is a Unisys speaking NAP, `TypeOfSrf` will default to `NAP`.
Otherwise `TypeOfSrf` will default to `Other`.
Notes: Must equal `NAP` to have the language ID sent in the `playAnnouncement` or `PACUI` message.
Example: `TypeOfSrf=NAP`

TypeOfIVR

Syntax: `TypeOfIVR=string`
Description: Set `TypeOfIVR` to `CAMEL` to enable the Play Variable Announcement feature node to play dates in variable part announcements that comply with the 3GPP CAMEL specification: *3GPP TS 29.078*.
When you set `TypeOfIVR` to `CAMEL`, dates sent over the network with a size of four octets, and that are formatted as `YYYYMMDD`, will be played in announcements. The default behavior (INAP support) is used when you specify any other value for the `TypeOfIVR` parameter, or when you leave it unset. The default behavior sends dates over the network with a size of three octets, formatted as `YYMMDD`.
Type: String

Optionality: Optional (default used if not set)
Allowed:

- CAMEL
- Any other value

Default: (INAP support) Send dates over the network with a size of three octets, formatted as YYMMDD.

Example: `TypeOfIVR=CAMEL`

`tcapPreEnd`

Syntax: `tcapPreEnd=Y|N`
Description: Use prearranged End to TCAP dialogs.
Type: Boolean
Optionality: Optional
Allowed: Y, N
Default: Y
Notes:
Example: `UseETC=Y`

How the SRF Configuration Works

There are three ways in which this configuration works, depending on the parameters set:

- 1 The SLC communicates with the SSP through CTR (Connect to Resource) and using an internal IP. No IP address is required for this option. UseETC is not required (select N). The IP name is required. NOA is required (but ignored).

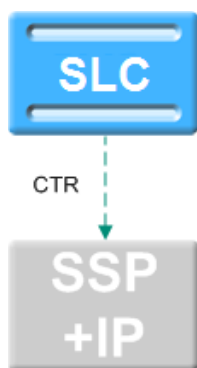

- 2 The SLC communicates with the SSP through the CTR and IP address. The SSP then uses the IP address to communicate with an external IP. The IP address is required for this option. UseETC is not required (select N). The IP name is required. NOA is required.

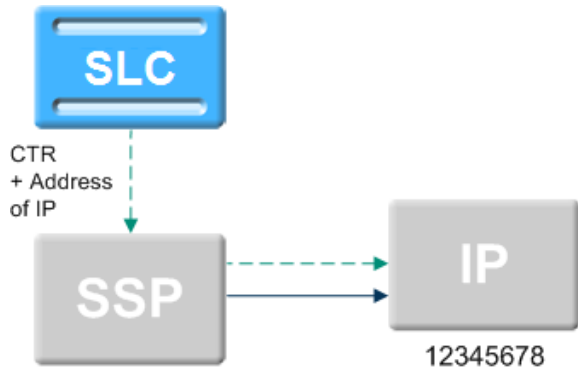

- 3 The SLC communicates with the SSP through the ETC operation (EstablishTemporaryConnection) and IP address. The SSP then uses the IP address to communicate with an external IP. The IP address is required for this option. The IP also communicates directly with the SLC, using an ARI (AssistRequestInstructions). UseETC is required (select γ). The IP name is required. NOA is required.

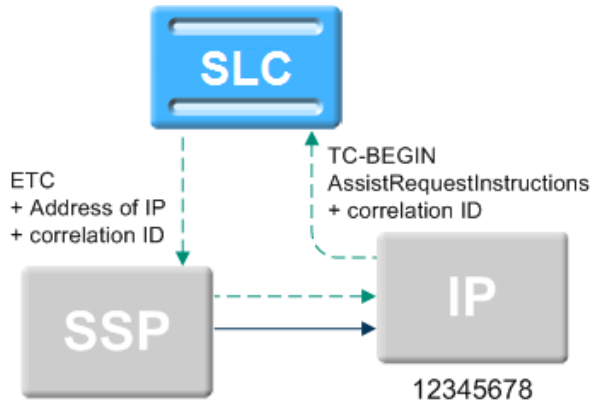

acsChassis SCF Configuration (SLC)

Introduction

The `scf` parameter defines an SCF (Service Control Function) name and SCCP Address that can be used by the TCAP Handover feature node as a destination for the handed over TCAP primitive.

For more information about the TCAP Handover feature node, see *CPE User's Guide*.

Parameter

Usage:

```
scf (scfName,NOA=0-4,Address=SCF_addr,TT=translation_type,NPI=number_plan_ind,PC=point_code,SSN=subsystem_number,RI=routing_ind,NI=national_ind,appContext=context)
```

To specify a location, point code or global title addressing may be used.

Valid combinations are:

- PC+SSN
- Address+NOA

- Address+TT
- Address+TT+NPI
- Address+NOA+TT+NPI

You can also cause an originating address to be set in the outgoing ICA request by `slee_acs` instead of your TCAP IF using:

```
scf (LocationAddress,NOA=0-4,Address=SCF_addr)
```

Note: Consult standard Q713 for full parameter definitions.

`scfName`

Syntax:

Description: The SCF name to deliver the TCAP primitive to.

Type: String

Optionality: Required if TCAP Handover is used.

Allowed: Must match the name from the TCAP Handover feature node configuration in the control plan.

Default: none

Notes: If you set `LocationAddress` in this position in the `scf`, `slee_acs` will set an originating address in the outgoing ICA request (otherwise it is set by TCAP IF).

Example: For an example of how to use this configuration in context, see *Example SCF Configuration* (on page 137) SCF configuration.

`Address`

Syntax: `SCF_addr`

Description: The address of IP if an external IP is used.

Type:

Optionality:

Allowed: Address of IP or nothing if internal IP

Default: none

Notes:

Example: For an example of how to use this configuration in context, see *Example SCF Configuration* (on page 137) SCF configuration.

`NOA`

Syntax: `noa`

Description: The nature of address indicator.

Type:

Optionality: Optional (default used if not set)

Allowed:

0	spare
1	subscriber number
2	unknown
3	national significant number
4	international significant number

Default: 0

Notes:

Example: For an example of how to use this configuration in context, see *Example SCF Configuration* (on page 137).

Chapter 5

TT

Syntax: *translation_type*
Description: The translation type.
Type:
Optionality:
Allowed:
Default: none
Notes:
Example: For an example of how to use this configuration in context, see *Example SCF Configuration* (on page 137) SCF configuration.

NPI

Syntax: *number_plan_ind*
Description: The number plan indicator.
Type:
Optionality:
Allowed:
Default: none
Notes:
Example: For an example of how to use this configuration in context, see *Example SCF Configuration* (on page 137) SCF configuration.

PC

Syntax: *point_code*
Description: The point code.
Type:
Optionality:
Allowed:
Default: none
Notes:
Example: For an example of how to use this configuration in context, see *Example SCF Configuration* (on page 137) SCF configuration.

SSN

Syntax: *subsystem_number*
Description: The subsystem number.
Type:
Optionality:
Allowed:
Default: none
Notes:
Example: For an example of how to use this configuration in context, see *Example SCF Configuration* (on page 137) SCF configuration.

RI

Syntax: `routing_ind`
Description: The routing indicator.
Type:
Optionality:
Allowed:
Default: none
Notes:
Example: For an example of how to use this configuration in context, see *Example SCF Configuration* (on page 137) SCF configuration.

NI

Syntax: `national_ind`
Description: The national indicator.
Type:
Optionality:
Allowed:
Default: none
Notes:
Example: For an example of how to use this configuration in context, see *Example SCF Configuration* (on page 137) SCF configuration.

appContext

Syntax: `appContext=context`
Description: The application context for this SCF.
Type: String
Optionality: Optional
Allowed: Any valid context:

- Nokia_IDP
- CAPv2_IDP
- CAPv3_IDP
- CAPv3_SMS
- *n.m.p* - Where n, m and p are integer numbers that form an object identifier, defining the protocol to use.

Default: None
Notes: Required if the TCAP Handover node is expected to pass on the application context.
Example: `appContext=CAPv2_IDP`

Example SCF Configuration

The following are examples of valid SCF definitions:

```
scf (SCF_Name1,PC=0xADB,SSN=11)
scf (SCF_Name2,NOA=4,Address=01224)
scf (LocationAddress,NOA=4,Address=01234)
scf (LocalAddress,PC=0xADB,SSN=11,address=22224444,NOA=4,RI=0)
```

About Defining scfs in acs.jnlp and sms.jnlp

The values used for SCP names in the `scf` section of the `acs.conf` configuration file must match the `scfs` application property definition in both the `acs.jnlp` and the `sms.jnlp` files.

Example: If `acs.conf` contains the following two lines:

```
scf (SCP_Name1,PC=0xADB,SSN=11)
scf (SCP_Name2,NOA=4,Address=01224)
```

The application property section of the `acs.jnlp` and `sms.jnlp` files must contain a corresponding entry for the `scfs` application property:

```
<property name="scfs" value="SCP_Name1,SCP_Name2" />
```

For more information about configuring application properties in `acs.jnlp` and `sms.jnlp`, see *Setting up the Screens* (on page 25).

acsChassis SSF Configuration (SLC)

Introduction

In `acs.conf`, the `ssf` line defines a service switching function (SSF) that can be used by the Call Initiation feature node as a destination for the initiate call attempt.

Parameters

An `ssf` parameter line in `acs.conf` must contain at least:

- 1 The `ssf_name` parameter
- 2 The `interface=handle` parameter
- 3 An address specified by one of the following:
 - GT
 - PC and SSN

`acsChassis` uses the address specification to construct address and address indicator numbers that comply with the ITU-T SS7 standard.

GT can be specified in four different ways, each defined in terms of ITU-T SS7's global titles.

- 1 `GT1. [Address=GlobalTitleAddress, NOA=noa]`
- 2 `GT2. [Address=GlobalTitleAddress, TT=TranslationType]`
- 3 `GT3. [Address=GlobalTitleAddress, TT=TranslationType, NPI=NumberingPlanIndicator]`
- 4 `GT4. [Address=GlobalTitleAddress, TT=TranslationType, NPI=NumberingPlanIndicator, NOA=noa]`

The address indicator number is made up of the `PC=<pc>`, `SSN=<ssn>`, `RI=<RI>` parameters.

Usage: The full syntax of an `ssf` line in `acs.conf` is:

```
ssf (ssf_name[, Address=GlobalTitleAddress[, NOA=noa][, TT=TranslationType[,
NPI=NumberingPlanIndicator[, NOA=noa]]][, PC=pc, SSN=ssn][, RI=RI],
interface=handle[, appContext=objectIdentifier])
```

Definitions for individual parameters follow.

For more information about the address and address indicator parameters, refer to ITU-T Recommendation Q.713 *Signalling Connection Control Part formats and codes*.

ssf_name

Syntax: *ssf_name*

Description: The name of the switch that appears in the configuration screen of the Call Initiation feature node.

Type: String

Optionality: Required

Allowed:

Default:

Notes: For more information about the Call Initiation feature node, see *Feature Nodes Reference Guide*

Example: *Switch_Name1*

Address

Syntax: *Address=GlobalTitleAddress*

Description: The global title address

Type: Integer

Optionality: Optional (required if PC and SSN are not used)

Allowed:

Default:

Notes:

Example: *Address=40053*

NOA

Syntax: *NOA = NatureOfAddress*

Description: The nature of address indicator.

Type: Integer

Optionality: NOA

Allowed:

Nature Of Address for number of address signals		Type of number
Even	Odd	
0	128	Unknown
1	129	Subscriber
2	130	Reserved for national use.
3	131	National significant.
4	132	International.

Example: *NOA=1*

TT

Syntax: *TT = TranslationType*

Description: Directs messages to the appropriate translator. The value depends on the GT chosen under *Parameters* (on page 138).

Type: Integer

Optionality: Optional

- Allowed:** **GT₁.** not used.
GT₂. 0 to 255
GT₃. The ITU have not defined a translation type for this global title.
GT₄. 1 to 254. For GT₄, values for *TranslationType* are defined in the table.

Translation Type for GT ₄	Type
1 through 63	International
64 through 127	Spare
128 through 254	National

- Notes:** **GT₂:**
- Set *TranslationType* to 0 if the TT parameter is not to be used.
 - Translation types for internetwork services are assigned in ascending order, starting with 1.
 - Translation types for network-specific services are assigned in descending order, starting with 254.

TranslationType type may also imply the scheme used to encode address information and a numbering plan.

NPI

- Syntax:** NPI = *NPI*
Description: Defines the numbering plan.
Type: Integer
Optionality: Optional
Allowed: 1 to 14.
Notes: This table describes the meanings of the different NPis.

NPI	Numbering Plan
1	ISDN and telephony
2	Generic
3	Data
4	Telex
5	Maritime mobile
6	Land mobile
7	ISDN and mobile
8 through 13	Spare
14	Private network

PC

- Syntax:** PC = *pc*
Description: Defines the signaling point code.
Type: Integer; hexadecimal, decimal or octal
Optionality: Optional (required if SSN is set)
Allowed: 0 to 16383 For decimal
0 to 0x3FFF For hexadecimal
0 to 037777 For octal

- Notes:**
- A decimal number must not begin with a 0.
 - A hexadecimal number must begin with 0x. For example, if the signaling point code is 2780, the parameter would be `PC=0xADC`.
 - An octal number must begin with 0. For example, if the signaling point code is 2780, the parameter would be `PC=05334`.

SSN

- Syntax:** `SSN = SSN`
- Description:** Identifies an SCCP user function.
- Type:** Integer
- Optionality:** Optional (required if `PC` is set)
- Allowed:** 0 – 255
- Default:**
- Notes:** This table describes the values.

SSN	SCCP user function
0	SSN not known or not used
1	SCCP management
2	Reserved for ITU-T allocation
3	ISDN user part
4	Operation, Maintenance and Administration part
5	Mobile application part

- Example:** `SSN = 12`

RI

- Syntax:** `RI = RI`
- Description:** The routing indicator. It identifies the address element to use for routing.
- Type:** Integer
- Optionality:** Optional
- Allowed:**
- | | |
|---|--------------|
| 0 | Route on SSN |
| 1 | Route on GT |
- Default:**
- Notes:**
- Example:** `RI = 1`

interface

- Syntax:** `interface = handle`
- Description:** The handle for the SLEE interface that sends ICA messages to the SSF.
- Type:** String
- Optionality:** Required
- Allowed:**
- Default:**
- Notes:** Must match the handle in the `SLEE.cfg` file. For more information, see *SLEE Technical Guide*.
- Example:** `interface = sua_if`

appContext

Syntax: appContext=*string*

Description: The transaction capability (TC) object.

Type: String

Optionality: Optional

Allowed: Nokia_IDP
CAPv2_IDP
CAPv3_IDP
CAPv3_SMS
CAPv4_IDP
n.m.p Where n, m and p are integer numbers that form an object identifier, defining the protocol to use.

Default:

Notes: When the ICA node uses an ssf with appContext set, appContext enables you to specify the application context to pass back up to ACS in the generated IDP. Set appContext to CAPv4_IDP to enable the ssf to use the correct message sequence in CAP4 InitiateCallAttempt operations. When you set appContext to CAPv4_IDP in the ssf line, you must also configure an scf line for an scf named *LocalAddress* that includes a global title. The scf will be used in the smScfAddress mandatory parameter of the CAP4 InitiateCallAttempt operation.

Examples: appContext=Nokia_IDP
appContext=15.36.5

useLeg3ForICA

Syntax: useLeg3ForICA

Description: Sets the leg ID to 3 for all subsequent operations for that leg. Specify the useLeg3ForICA parameter in the ssf line if the leg ID for InitiateCallAttempt message sequences for the SSF must be 3 or higher.

Type: String

Optionality: Optional

Allowed:

Default:

Notes:

Example: useLeg3ForICA

Example SSF Configuration

The following are examples of valid ssf definitions:

```
ssf (SSF_Name1,PC=0xADC,SSN=11,interface=hssScIf)
ssf (SSF_Name2,NOA=1,Address=01234,interface=hssScIf)
ssf (Company,NOA=1,Address=01234,interface=VSSP,
    appContext=CAPv2_IDP)
ssf (ssf2,NOA=4,address=1234,interface=sua_if_sms,appContext=CAPv4_IDP,useLeg
3ForIca)
```

About Defining ssfs in acs.jnlp and sms.jnlp

The value used for `ssf_name` (the switch name) in the `ssf` section of the `acs.conf` configuration file must match the `ssfs` application property entry in the `acs.jnlp` and `sms.jnlp` files.

Example: If the `acs.conf` file contains the following two lines:

```
ssf (SwitchName1,PC=0xADC,SSN=11,interface=hssScIf)
ssf (SwitchName2,NOA=1,Address=01234,interface=hssScIf)
```

The application property section of the `acs.jnlp` and `sms.jnlp` files must contain a corresponding entry for the `ssfs` application property:

```
<PROPERTY NAME="ssfs" VALUE="SwitchName1,SwitchName2" />.
```

For more information about defining application properties in the `acs.jnlp` and `sms.jnlp` files, see *Setting up the Screens* (on page 25).

acsChassis EDR Configuration (SLC)

Logging EDRs

The parameters listed below in this topic affect the way EDRs are logged.

Note: For EDRs to be logged at all, the `acsChassis` section of the `acs.conf` file must contain the line `CdrFile 1`.

TCP Network Loading

EDR files are collated on each SLC and uploaded at regular intervals to the SMS.

Files are transferred using the proprietary program `cmnPushFiles`. Refer to the *main component diagram* (on page 3).

EDR files contain a base content that has a size of approximately 350 bytes per call attempt or call disconnect. The total data size to be transferred can be computed from the call rate combined with assumptions about the complexity of the control plan.

A control plan that attempts to terminate and then terminates to a second number will generate two EDRs.

The total data will be typically distributed over a number of files.

A new EDR file is created when the old file reaches a specified age or size as defined by the `CdrFileMaxAge` (on page 147) and `CdrFileMaxSize` (on page 147) parameters.

Note: `slee_acs` compares the current EDR file against the `CdrFileMaxAge` (on page 147) and `CdrFileMaxSize` (on page 147) parameters at the end of the call. Thus, when a single call is run, the EDR file is closed only when more calls are run or `slee_acs` is gracefully restarted.

The `CdrExtraFields` and `SendCIR` parameters cause additional content to be written to each EDR line. This raises the average data flow above the base 350 bytes per EDR line. The size of the additional content depends on the nature of the control plan. Experimentation with individual control plans is required to determine the size of extended EDRs.

Parameters

The following parameters are optional and may be added when required. Only one entry per parameter is allowed.

callReferenceIDAsHex

Syntax: `callReferenceIDAsHex 0|1`
Description: Indicates the Call Reference ID (an Octet string) in an IDP is a BCD number ASCII string or not.
Type: Boolean
Optionality: Optional (default used if not set).
Allowed: 0 (false), 1 (true)
Default: 0
Notes: If the Call Reference ID (an Octet string) in an IDP is a BCD number other than an ASCII string, for instance 0x28 0x81 0x1F 0xE3 0x29, then we need to set this option to true in order to be able to read the hex values "28811FE329" in EDR other than see unreadable characters.
Example: `callReferenceIDAsHex 1`

CdrCacheMaxSize

Syntax: `CdrCacheMaxSize int`
Description: The maximum size in kilobytes of the internal CDR cache. When the limit is reached, the CDR cache is written to file and then cleared.
Type: Integer
Optionality: Optional (default used if not set)
Allowed: A value in the range 4 to 64
Default: 32
Notes:
Example: `CdrCacheMaxSize 32`

CdrClosedDirectory

Syntax: `CdrClosedDirectory "path"`
Description: The path to move the EDR file to when it is flushed due to one of `CdrFileMaxAge` (on page 147) or `CdrFileMaxSize` (on page 147) being exceeded.
Type: String
Optionality: Optional (default used if not set).
Allowed:
Default: `/IN/service_packages/SMS/cdr/closed`
Warning: This parameter only changes the output of the EDR file. If this parameter is changed all other relevant parts of the platform must also be updated.
Example: `CdrClosedDirectory "/var/EDRs/closed"`

CdrCompressCall

Syntax: `CdrCompressCall 0|1`
Description: Whether or not to log multiple connect attempts as one EDR.
Type: Boolean
Optionality: Optional (default used if not set).
Allowed:
0 a separate EDR will be created for each connection attempt, abort, or disconnect individually.
1 calls with multiple connect attempts are logged as one EDR. A single EDR will be generated at the end of every call, at the point where it is torn down, regardless of how the call finishes.

Default: 0

Notes: If `CdrCompressCall` is 0, the `CdrOnAbort` (on page 150) and `CdrOnDisconnect` (on page 150) parameters determine if abort and/or disconnect events generate EDRs.

Example: `CdrCompressCall 0`

`CdrCurrentDirectory`

Syntax: `CdrCurrentDirectory "path"`

Description: The path to write the EDR file to.

Type: String

Optionality: Optional (default used if not set).

Allowed:

Default: `/IN/service_packages/SMS/cdr/current`

Warning: This parameter only changes the output of the EDR file. If this parameter is changed all other relevant parts of the platform must also be updated.

Example: `CdrCurrentDirectory "/var/EDRs/current"`

`CdrFile`

Syntax: `CdrFile 0|1`

Description: Whether or not to log EDRs to a file.

Type: Boolean

Optionality: Optional (default used if not set).

Allowed: 0 (no), 1 (yes)

Default: 0

Notes:

Example: `CdrFile 0`

`CdrExtraFields`

Syntax: `CdrExtraFields 0|1|2`

Description: EngineNodes that are traversed during execution of a control plan will be logged and placed in the EDR (TFN tag)

Type: Integer

Optionality: Optional (default used if not set).

Allowed:

0	No logging will be done
1	Track traversed feature nodes and played announcements, and record in EDR. The format is: <code><node fast key>-<node number>.</code>
2	In addition to 1, track feature node sub-states, showing all the states the node is going through. The format is: <code><node fast key>-<node number>.<state><state>...<state></code>

Default: 1

Notes: You can customize the maximum length in characters of the TFN data by using the `acsChassis.tfnListSize` parameter.

There are no separators between the `<state>` fields which are all single characters as defined in *Node States* (on page 146) below.

Example: CdrExtraFields 1

Node States

State Number	Node State	State Number	Node State
0	0	26	J
1	1	27	K
2	2	28	L
3	3	29	M
4	4	30	N
5	5	31	O
6	6	32	P
7	7	33	Q
8	8	34	R
9	9	35	S
10	:	36	T
11	;	37	U
12	<	38	V
13	=	39	W
14	>	40	X
15	?	41	Y
16	@	42	Z
17	A	43	[
18	B	44	\
19	C	45]
20	D	46	^
21	E	47	_
22	F	48	'
23	G	49	a
24	H	50	b
25	I		

CdrFileAppendCloseTime

Syntax: CdrFileAppendCloseTime 0|1
Description: Whether or not to append the time that the file was closed to the EDR file name.
Type: Boolean
Optionality: Optional (default used if not set).
Allowed: 0 (no), 1 (yes)
Default: 0

Example: `CdrFileAppendCloseTime 0`

CdrFileAppendPid

Syntax: `CdrFileAppendPid 0|1`

Description: Whether or not to append the PID of the logging process to the EDR file name.

Type: Boolean

Optionality: Optional (default used if not set).

Allowed: 0 (no), 1 (yes)

Default: 1

Example: `CdrFileAppendPid 1`

CdrFileMaxAge

Syntax: `CdrFileMaxAge seconds`

Description: Set the maximum age of the EDR file. After this period expires the file is purged.

Type: Integer

Optionality: Optional (default used if not set).

Allowed: Any integer

Default: 600

Notes: Value is in seconds

Example: `CdrFileMaxAge 600`

CdrFileMaxSize

Syntax: `CdrFileMaxSize KB`

Description: Set the maximum size of the EDR file. When this file size is exceeded, the file is purged.

Type: Integer

Optionality: Optional (default used if not set).

Default: 8

Example: `CdrFileMaxSize 8`

CdrFileUseGMT

Syntax: `CdrFileUseGMT 0|1`

Description: Whether or not to add a start timestamp in GMT to the EDR filename.

Type: Boolean

Optionality: Optional (default used if not set).

Allowed: 0 – Do not add a GMT timestamp to the EDR filename.

1 – Add a GMT timestamp to the EDR filename.

Default: 0

Notes: If set to 1, the EDR filename uses this format:

application_gmtZ_start_time.cdr

If set to 0, the EDR filename uses this format:

application_start_time.cdr

Where:

- *application* is the name of the application that triggered the EDR.
- *gmtZ_start_time* is the EDR start time in GMT.
- *start_time* is the EDR start time in local time.

The format used for start time is: *yyyymmddhh24missff1*, where *ff1* is the decisecond portion of the timestamp.

Example: `CdrFileUseGMT 1`

CdrFileUseLocalTime

Syntax: `CdrFileUseLocalTime 0|1`

Description: What timezone to use for the start and end timestamps in the EDR filename.

Type: Boolean

Optionality: Optional (default used if not set).

Allowed: 0 – Use GMT.
1 – Use local time.

Default: 0

Notes: This parameter does not affect the timestamp added if `CdrFileUseGMT` is set to 1 (adds GMT timestamp to EDR filename).

Example: `CdrFileUseLocalTime 1`

CdrRemoveFields

Syntax: `CdrRemoveFields 0|hex_value`

Description: Mask that specifies the fields to remove from an EDR. To set the mask, sum the values used to identify each field that you want to remove, and convert to hexadecimal.

Type: Hexadecimal Integer

Optionality: Optional (default used if not set).

Allowed: Hexadecimal number that is the sum of the values for the fields you want to remove. For a list of valid values, see EDR field values table below.

Default: 0 - Do not remove any fields.

Notes: For more information about the EDR fields, see *Event Detail Record Reference Guide*.

Example: `CdrRemoveFields 2001000000`
Turns off release cause and sleet call ID ($2^{24} + 2^{37} = \text{hex } 2001000000$).

The following table lists the EDR field values you can use and their corresponding field codes and field names. The EDR field values have the following format. 2^x , which means 2 to the power of x .

EDR Field Value	EDR Field Code	Field Name
2^0	OA	Originating Address (IP/PC)
2^1	OTI	Originating Transaction ID
2^2	CUST	Customer ID
2^3	SN	Service (Original Called) Number

EDR Field Value	EDR Field Code	Field Name
2^4	TN	Termination Number
2^5	CGN	Calling Network Number
2^6	CLI	Calling Line Identifier
2^7	SK	Service Key
2^8	TCS	Time Call Start
2^9	TCE	Time Call End (ETSI only)
2^10	LPN	Last PIN Number Entered
2^11	LAC	Last Account Code Entered
2^12	CS	Connect Status
2^13	CPC	Calling Party Category
2^14	CC	Carrier Code
2^15	CPNI	Calling Private Network ID
2^16	PCNA	Calling Private Network Address
2^17	PTNA	Called Private Network Address
2^18	CGNA	Calling Global Network Address (for example, GVNS number)
2^19	TFN	Track Feature Nodes
2^20	CPN	Call Plan Name
2^21	CAET	Call Attempt Elapsed Time (CallInfoRequest)
2^22	CCET	Call Connect Elapsed Time (CallInfoRequest)
2^23	CA	Called Address (CallInfoRequest)
2^24	RELC	Release Cause (CallInfoRequest)
2^25	OCPI	Original Called Party ID
2^26	CPNN	Called Party Nature of Number (Address)
2^27	NOAT	Number of Attempt Terminations
2^28	LGID	Language ID
2^29	CBAT	Connect by Attempt Termination
2^30	FATS	First Announcement Timestamp
2^31	HTS	Hunting Timestamp
2^32	CCTS	Call Connect Timestamp
2^33	AIDL	Announcement ID List
2^34	TPNI	Terminating Private Network ID
2^35	CGNN	CallingPartyID Nature of Number
2^36	CPPI	CallingPartyID Presentation Restriction Indicator
2^37	CID	Slee Call ID
2^38	TGNA	Terminating Global Network Address (for example, GVNS number)
2^39	SL_CONTENT	All service library supplied fields (may be zero, one, or more fields)
2^40	EXT(0-9)	Any extension digits fields

Chapter 5

CdrLogPIN

Syntax:	<code>CdrLogPIN 0 1</code>
Description:	Whether or not to log the PIN.
Type:	Boolean
Optionality:	Optional (default used if not set).
Allowed:	1 the LPN field which records the PIN is written to the EDR log files as part of EDR creation. 0 this action is suppressed. The EDRs will be created normally but the LPN field will be missing.
Default:	1
Notes:	For more information about PIN logging configuration, see <i>PIN logging parameters</i> (on page 108).
Example:	<code>CdrLogPIN 1</code>

CdrOnAbort

Syntax:	<code>CdrOnAbort 0 1</code>
Description:	Whether or not to create EDRs when one of the following occurs: <ul style="list-style-type: none">• A TCAP abort is received• A TCAP reject is received and a TCAP abort is sent in response
Type:	Boolean
Optionality:	Optional (default used if not set).
Allowed:	0 Abort logging is disabled 1 Aborted calls are logged
Default:	1
Example:	<code>CdrOnAbort 1</code>

CdrOnCallCompletion

Syntax:	<code>CdrOnCallCompletion 0 1</code>
Description:	Whether or not to log EDR on call completion when <code>CdrCompressCall</code> (on page 144) is set as 0.
Type:	Boolean
Optionality:	Optional (default used if not set)
Allowed:	0 - EDR will not be written on call completion. 1 - EDR will be written on call completion if <code>CdrCompressCall</code> (on page 144) is set as 0, regardless of how call finishes.
Default:	0
Notes:	
Example:	<code>CdrOnCallCompletion 0</code>

CdrOnDisconnect

Syntax:	<code>CdrOnDisconnect 0 1</code>
Description:	Whether or not to create EDRs when a call is deliberately disconnected (for example, by a disconnect call node).
Type:	Boolean
Optionality:	Optional (default used if not set).
Allowed:	0 (no), 1 (yes)
Default:	1

Example: `CdrOnDisconnect 1`

`cdrOnForcedDisc`

Syntax: `cdrOnForcedDisc 0|1`

Description: When set to true, forces ACS to write an EDR in the event of a forced disconnect.

Type: Boolean

Optionality: Optional (default used if not set).

Allowed:

- 0 (false), do not write EDR
- 1 (true), write EDR

Default: 0

Notes:

Example: `cdrOnForceDisc 1`

`CdrOnHandover`

Syntax: `CdrOnHandover 0|1`

Description: When set to true, forces ACS to write an EDR on service handover, providing the `CdrCompressCall` (on page 144) parameter is set to zero (0).

Type: Boolean

Optionality: Optional (default used if not set).

Allowed:

- 0 (false), do not write EDR on service handover
- 1 (true), write EDR on service handover

Default: 0

Notes:

Example: `CdrOnHandover 0`

`CdrResetOnWriteRELC`

Syntax: `CdrResetOnWriteRELC 0|1`

Description: When set to true, forces ACS to reset the call release cause to zero after it has been written to an EDR, providing the `CdrCompressCall` (on page 144) parameter is set to zero (0).

Type: Boolean

Optionality: Optional (default used if not set).

Allowed:

- 0 (false), do not reset release cause to zero
- 1 (true), reset release cause to zero

Default: 0

Notes:

Example: `CdrResetOnWriteRELC 1`

`CdrUseCDigits`

Syntax: `CdrUseCDigits n`

Description: The number of digits to use as a fractional second extension to the start time and closing time, to ensure a unique CDR filename. The fractional part has a resolution of $1/10^n$ seconds, where n is the number of digits (in the range 1 to 6) that are added to the filename.

Type: Integer

Optionality: Optional (default used if not set)

Allowed: 1, 2, 3, 4, 5, or 6
Default: 1
Notes: For example, if the timestamp is 23/01/2014 22:34:48.567 and `CdrUsecDigits` is set to 3, then `acsChassis` creates a file named: **ACS_20140123223448567.cdr**. If `CdrUsecDigits` is set to 1, then `acsChassis` omits the last two digits from the timestamp to create a file named: **ACS_201401232234485.cdr**.
Example: `CdrUsecDigits 1`

`elapsedTimesFromApplyChargingReport`

Syntax: `elapsedTimesFromApplyChargingReport 0|1`
Description: Whether or not to calculate CAET and CCET using the `ApplyChargingReport`.
Type: Boolean
Optionality: Optional (default used if not set).
Allowed: 0 (no), 1 (yes)
Default: 0
Notes: This is an option to use when a call has been released, in which there is no `CallInformationReport`.
Example: `elapsedTimesFromApplyChargingReport 1`

`zeroElapsedTimesInCdr`

Syntax: `zeroElapsedTimesInCdr 0|1`
Description: Whether or not to include TCS, CCET and CAET in the EDR, even in the case where call duration is zero.
Type: Boolean
Optionality: Optional (default used if not set).
Allowed: 0 (no), 1 (yes)
Default: 0
Notes:
Example: `zeroElapsedTimesInCdr 1`

acsChassis Service Library Configuration (SLC)

Parameter

The entries in the `acsServiceLibrary` topic determine configuration parameters for the `acsServiceLibrary`.

`ProfileOrder`

Syntax: `ProfileOrder (key, pro1, pro2, pro3)`
Description: Defines the order of the profiles for loading and searching for traffic with a specific service key.
Type: Array
Optionality: Optional (default used if not set).
Allowed: Each `pro1-3` is one of:

- CUSTOMER
- CALL_PLAN
- SERVICE_NUMBER

Default: ProfileOrder (110,CUSTOMER,CALL_PLAN,SERVICE_NUMBER)
Notes: All three profiles must specified for each parameter.
Examples: ProfileOrder (10,CUSTOMER,CALL_PLAN,SERVICE_NUMBER)
ProfileOrder (11,CALL_PLAN,SERVICE_NUMBER,CUSTOMER)
ProfileOrder (12,CUSTOMER,SERVICE_NUMBER,CALL_PLAN)

acsChassis Service Normalisation Parameters (SLC)

Introduction

Each service for which a `ServiceEntry` exists in the `acs.conf` can have a specific config section where you define configuration parameters specific for that service. The name for the service section must be the same name specified in the corresponding *acsChassis ServiceEntry Configuration (SLC)* (on page 123), that is, ACS_Outgoing, CCS, VPN_Originating...

Service Specific Normalization Parameters

The service specific normalization parameters are used to define conversion rules specific to each available service. These parameters are equivalent to those with the same name described in the acsChassis Normalization Parameters section. For a description of each, refer to *Normalization Parameters* (on page 118).

When a service section is found in the `acs.conf`, the global normalization rules are ignored for that particular service and the specific rules (if any) are used instead. In this sense, a service will only use the global configuration when no specific section is defined for it in the `acs.conf`. Also, in no case global and specific normalization rules will be used simultaneously within the same service.

acsChassis AWOL Configuration

AWOL Processing

The ACS service supports many different call scenarios, including scenarios where the SLC is involved in the call right up to when the A or B party disconnects at the end of a conversation.

The number of entities involved in the call and managing the connection between the SSP and SLC software can lead to many complex interactions. Occasionally these interactions may not follow the INAP CS1 call model due to situations beyond the direct control of the ACS service.

In particular, ACS can be used for billable call control by using the `ApplyCharging` and `ApplyChargingReport` INAP messages. When ACS sends an `ApplyCharging` request to a SSP, it will expect a response within a certain time frame due to the request defining a limit on the time the call can proceed for.

Certain circumstances can occur in production networks that can cause the `ApplyChargingReport` to be never returned. This would in general cause the call to be left 'hanging' in the ACS service, using system and service resources that would never, usually, be freed.

To alleviate this situation, AWOL checking has been developed in the ACS service. The basic premise is that the ACS service should abort any call for which an expected `ApplyChargingReport` is late.

Calls that are considered as AWOL, are aborted. This will clean up all call resources within the ACS service and the SLEE.

The ACS Service will continue to process the control plan for the call according to the service limitations.

Defining acsChassis AWOL configuration

The `acsChassis` AWOL configuration section defines six AWOL parameters, two of which are global and should only be defined in the `acsChassis` section of `acs.conf`:

- `checkAWOL`
- `checkAWOLMarginAC`

The other parameters are defined globally in the `acsChassis` section; but they can also be defined in the service configuration, per service, which will override the global values. These parameters are:

- `awolTimeout`
- `awolReportOnly`
- `awolReportPeriod`
- `awolOverrideACRTimeout`

For more information, see *overriding AWOL configuration per service* (on page 129).

Parameters

The following configuration parameters are provided to control AWOL checking:

`checkAWOL`

Syntax:	<code>checkAWOL 0 1</code>
Description:	Whether or not the ACS service should check for calls with later ApplyChargingReport messages.
Type:	Boolean
Optionality:	Optional (uses default if not set)
Allowed:	0 – No AWOL checking is done and if the ACR is never received, the call will never be torn down. 1 – AWOL checking is done as defined by the other AWOL parameters.
Default:	0
Example:	<code>checkAWOL 1</code>

`checkAWOLMarginAC`

Syntax:	<code>checkAWOLMarginAC int</code>
Description:	Tolerance, in seconds, added to the apply charging timeout.
Type:	Integer
Optionality:	Optional
Allowed:	Positive integer
Default:	30
Notes:	Apply Charging operations use this parameter and not the <code>awolTimeout</code> parameter. If an ApplyCharging report was sent for a call with a talk time of 60 seconds, using the <code>checkAWOLMarginAC</code> parameter, it would be 90 seconds after this message was sent before the call was considered AWOL and aborted by the ACS service.
Example:	<code>checkAWOLMarginAC 30</code>

`awolTimeout`

Syntax:	<code>awolTimeout duration</code>
Description:	The time a call must be in progress before it becomes eligible for termination.

Type: Integer
Units: Seconds
Optionality: Optional
Allowed: $duration \geq 0$
Default: If the `awolTimeout` parameter is omitted, $duration = 0$ is assumed.
Notes:

- May be specified for service instance section which will override the value specified globally.
- If $duration$ is set to zero, no timer is configured and calls are never placed in a 'close' queue.
- If $duration > 0$, at the end of $duration$, a SLEE event is triggered notifying that the call should be placed in a 'close' queue.
- The `awolTimeout` parameter can be specified in the in the `acs.conf` file as a specific service entry. See *acsChassis ServiceEntry Configuration (SCP)* (on page 123).
- This parameter is not used by any Apply Charging operations.

Example: `awolTimeout 1800`

`awolReportOnly`

Syntax: `awolReportOnly 0|1`
Description: Specifies the type of AWOL message printed to the system log.
Type: Boolean
Optionality: Optional
Allowed: 0 – For every timed out message, report:

- The time overdue
- The message type last sent
- The transaction and call ID (including the service handle, where applicable)

1 – For every timed out message, print only a summary report.
Default: 1
Notes:

- When specified in the service instance section, it overrides the global value.
- The following shows sample messages that are printed to the system log when `awolReportOnly` is set to 0:

```
WARNING. Ending Call 268413469. TID L.0x0 R.0x0 Sent operation(s)
TCAP_INVOKE. CS1_CallInformationRequest, TCAP_INVOKE. CS1_Continue.
Received
timeout 0s ago. Service Handle CCS_ROAM. Origin Address - GT. 60181000010
SSN. 146
```

```
WARNING. Ending Call 271216901. TID L.0x0 R.0x0 Sent operation(s)
TCAP_INVOKE:
CS1_ApplyCharging, TCAP_INVOKE. CS1_ApplyCharging, TCAP_INVOKE:
CS1_ApplyCharging, TCAP_INVOKE. CS1_ApplyCharging, TCAP_INVOKE:
CS1_ApplyCharging, TCAP_INVOKE. CS1_ApplyCharging, TCAP_INVOKE:
CS1_ApplyCharging, TCAP_INVOKE. CS1_ApplyCharging, TCAP_INVOKE:
CS1_ApplyCharging, TCAP_INVOKE. CS1_ApplyCharging, TCAP_INVOKE:
CS1_ApplyCharging, TCAP_INVOKE. CS1_ApplyCharging. Received timeout 0s
ago.
Service Handle CCS. Origin Address - GT. 60197030004 SSN. 146
```

Example: `awolReportOnly 0`

awolReportPeriod

Syntax:	<code>awolReportPeriod seconds</code>
Description:	How often, in seconds, to provide AWOL reporting.
Type:	Integer
Optionality:	Optional
Allowed:	<ul style="list-style-type: none">• 0 – Specifies to not generate AWOL reports.• Any Positive integer – Specifies the number of seconds between AWOL reports.
Default:	0
Notes:	When specified in the service instance section, it overrides the global value.
Example:	<code>awolReportPeriod 900</code>

awolOverrideACRTimeout

Syntax:	<code>awolOverrideACRTimeout value</code>
Description:	Specifies the period of time, in seconds, between Apply Charging Reports (ACRs). If the ACR is not received during this time, the call is cleaned up. It is anticipated that this value will be used in data session scenarios where the return time of the ACR cannot be predicted based on the Apply Charging request.
Type:	Integer
Optionality:	Optional. Configurable on a per-service basis only.
Allowed:	<ul style="list-style-type: none">• 0 – Specifies to not override the timeout from ACR.• Any positive integer – Specifies the number of seconds between ACRs.
Default:	0
Notes:	If set, the value in <code>checkAWOLMarginAC</code> is ignored.
Example:	<code>awolOverrideACRTimeout 1800</code>

Get Hunting Number Node Configuration

Parameters

The following configuration parameter is provided to control the Get Hunting Number node.

setCallData

Description:	If non zero, use the VPN Set Call Data chassis action to set the RedirectingPartyID and OriginalCalledPartyID.
Type:	Boolean
Allowed:	0, 1
Default:	0
Notes:	Set to 1 if you have VPN installed.

Number Matching Node Configuration

Parameters

The following configuration parameters are provided to control the Number Matching node.

RegMapFlushPeriod

Syntax:	<code>RegMapFlushPeriod seconds</code>
Description:	The number of seconds between attempts to flush the compiled regular expression map. Entries are flushed if they are older than the time specified by the <code>RegMapMaxAge</code> parameter. A value of 0 or less disables the flushing mechanism.
Type:	Integer
Optionality:	Optional
Default:	600
Notes:	To disable the flushing mechanism for the regular expression map, set the value to 0 (zero).
Example:	<code>RegMapFlushPeriod 600</code>

RegMapMaxAge

Syntax:	<code>RegMapMaxAge seconds</code>
Description:	The maximum number of seconds a compiled regex may remain in the map unused.
Type:	Integer
Optionality:	Optional (default used if not set).
Allowed:	
Default:	43200 (12 hours)
Notes:	
Example:	<code>RegMapMaxAge 43200</code>

Play Variable Part Announcement Node Configuration

Parameters

The following configuration parameters are provided to control the Play Variable Part Announcement node:

NumberRulesSection

Syntax:	<code>NumberRulesSection section_name:</code>
Description:	Defines where to find custom denormalization rules when the Denormalize check box is selected in the Play Variable Part Announcement node.
Type:	String
Optionality:	Optional
Allowed:	Any section name defined in the <code>acsPlayVariablePartAnnouncement</code> section of acs.conf
Default:	None
Notes:	The colon at the end is essential.
Example:	<code>NumberRulesSection examplePVP:</code>

DenormalisationRule

Syntax:	<code>DenormalisationRule (parameters):</code>
Description:	Defines the denormalization rule to check for.

Type:	Parameter list
Optionality:	Required
Allowed:	
Default:	None
Notes:	There may be as many DenormalisationRule lines configured as needed. The colon at the end is essential.
Example:	DenormalisationRule (0064,2,4,0,12):

Profile Date Compare Node Configuration

Parameters

The following configuration parameters are provided to control the Profile Date Compare node:

useTzDefault

Syntax:	useTzDefault 0 1
Description:	Specifies the time zone that is applied to the stored profile date. The Profile Date Compare node compares the stored profile date in the specified time zone to the current system time.
Type:	Boolean
Optionality:	Optional (default used if not set)
Allowed:	<ul style="list-style-type: none"> • 0 – Leaves the time zone of the stored profile date as GMT. • 1 – Converts the time zone of the stored profile date to the time zone set in the <code>tzDefault</code> parameter. (See <i>tzDefault</i> (on page 106) for more information.) If <code>tzDefault</code> is not set, the Profile Date Compare node applies the default system time zone to the stored profile date.
Default:	0
Notes:	
Example:	useTzDefault 1

acs.conf Example

Example acs.conf

Here is an example `acs.conf` file. Note that not all available parameters appear in the example.

```
# The following programs or groups of programs get their configuration
# from this configuration file.
#
#   acsStatisticsDBInserter
#   acsStatsMaster
#   acsStatsLocal
#   acsCompilerDaemon
#   acsProfileCompiler
#   acsChassis
#
# This file is parsed according to the following rules:
# - Indenting beyond the first white space is ignored by the parser, it is done
#   only for clarity for human readers.
#
# - Lines without at least a single leading white space or comment character are
#   section names.
```

```

#
# - The file is parsed until a line containing only the indicated section
#   name is matched.
#
# - Following lines are considered part of the section, until either the
#   end of file, or a line terminated with a ':' is reached.
#
# - Parameter lines are in the form '<key> <value>'
#
# - All key strings are case-sensitive. The specific keys recognised by
#   an application are specific to that application.
#
# - To add service specific Chassis configuration. specify the service name, such
#   as 'ACS_Outgoing'
#   and then set the configuration parameters as required. See example at the end
#   of this file.
#

acsStatisticsDBInserter
# oracleusername <sms_user>
# oraclepassword <sms_passwd>
# oracledatabase @SMF
  Retries 3
  Period 30
  MasterServerLocation STATSMASTERNODE
  MasterServerPort 1490:

acsStatsMaster
  port 1490
  shmKey 17170588
  semKey 17170589
  masterStatsServer STATSMASTERNODE:

acsStatsLocal
  port 1490
  masterStatsServer STATSMASTERNODE:

acsCompilerDaemon
# oracleusername SMF
# oraclepassword SMF
# oracledatabase @SMF
  alertTimeout 3
  maxBranches 99
  maxNodes 2000
  maxCompiledKb 1024
  compressAtKb 128
  compressLevel 1
  AuditChallenge 1:

acsProfileCompiler
# oracleusername SMF
# oraclepassword SMF
# oracledatabase @SMF

acsChassis
# oracleusername SMF
# oraclepassword SMF
#
  ServiceEntry (ACS,libacsService.so)
  ServiceEntry (ACS_Outgoing,libacsService.so)
  setCcetOnDisconnectCall 1

# Macro Node library - base ACS macro nodes.

```

Chapter 5

```
#
MacroNodePluginFile libacsMacroNodes.so

#
# Pluggable Action - base ACS actions.
#
ChassisPlugin libacsChassisActions.so

#tfnListSize 2048

#
# Special Resource Function mappings for the SLEE
#
srf (NAP1,UseETC=N,Address=,NOA=3)
srf (nap1,UseETC=N,Address=,NOA=3)

# Example of the ssf/scf definitions:
# ssf (SSF_Name1,PC=0xADC,SSN=11,interface=hssScIf)
# ssf (SSF_Name2,NOA=1,Address=01234,interface=hssScIf)
# scf (SCP_Name1,PC=0xADB,SSN=11)

# Example entry for the ICA originating address
# Setting this will cause an originating address to be set
# in the out going ICA request by slee_acs instead of your tcap IF
# scf (LocalAddress,NOA=4,Address=01224)

#
# Extension Numbers
#
# *** Unique to each site ***
#
# Examples:
# extensionNumber 0 26 inapaddressstring digits
# extensionNumber 1 28 inapaddressstring extension,nature,plan,digits
# extensionNumber 2 1 InapNumber digits

#
# Here are the rest of the Chassis parameters.
#
port 1490
shmKey 17170588
semKey 17170589
NoServiceAction disconnect
NoServiceError WARNING
NoCallPlanAction continue
NoCallPlanError
InternalErrorAction continue
ChainCountLimit 8
DialledStarEncoding B
DialledHashEncoding C
EntryChar C
EmergencyNumber 111

# If the Call Reference ID (an Octet string) in an IDP is a BCD number other than
an Ascii string,
# for instance 0x28 0x81 0x1F 0xE3 0x29, then we need to set this option to true
# in order to be able to read the hex values "28811FE329" in EDR other than see
unreadable characters.
# Defaults to false
callReferenceIDAsHex 1

# For use with the CIN
CallInitiationTimeoutToleranceSeconds 10
```



```

#
# CallInitiationUseContextInd
#
# CDR file configuration, disabled by default.
#
# Valid values for CallInitiationUseContextInd are:
#
# 0. All indicator values, including NoA, set to the
#    original values:
#
#    (NoA = 4, ScrnInd = 3, PresInd = 0, NumIncomplete = 0)
#    (Default = 0)
#
# 1. All indicator values, except NoA, set to original
#    values. The NoA value would come from the context and
#    could be altered via denormalisation rules.
#
# 2. NoA set to original value. Other indicator values come
#    from context and could be altered via Set Indicator
#    nodes in the call plan.
#
# 3. All indicator values would come from the context.
#    The NoA value could be altered via denormalisation rules
#    and the other indicator values could be altered via Set
#    Indicator nodes in the call plan. In all cases the
#    NumberPlan will be set to 1, as in the original version.
#
# CallInitiationUseContextInd 0

#
# CDR file configuration, disabled by default.
#
CdrFile 0
CdrFileMaxAge 600
CdrFileMaxSize 8
CdrExtraFields 1
CdrOnDisconnect 1
CdrOnAbort 1
CdrOnCallCompletion 0
CdrCompressCall 0
CdrLogPIN 1
CdrCacheMaxSize 32
CdrUsecDigits 1

# Append PID of logging process to filename (enabled by default)
CdrFileAppendPid 1

# Append time that file was closed to filename (disabled by default)
CdrFileAppendCloseTime 0

CdrFileUseLocalTime 0
CdrFileUseGMT

PINLogEnable 1
PINLogMaxAge 3600
PINLogMaxSize 1024
PINLogSuccess 0
PINLogFail 1

OverrideDefaultIPDigitTimeout 0
FirstDigitTimeout 4
InterDigitTimeout 4
MaxPromptDigits 21

```

Chapter 5

```
# Maximum number of bytes allowed in the text field of a
# PlayAnnouncement or PromptAndCollectUserInformation operation.
maxAnnouncementTextBytes 80

#
# Call Dump configuration, disabled by default.
#
CallDumpEnabled 0
CallDumpSeconds 120
CallDumpDir /tmp
CallDumpSeverity ERROR
CallDumpMessage

edpArmAnswer 1
edpArmNoAnswer 1
edpArmBusy 1
edpArmRouteSelectFailure 1
edpArmAbandoned 1
edpUseNoAnswerTimer 1
NokiaCIR 0
CarrierCodeDisposal 0
UseReplication 0
AuditChallenge 0
ArmTerminateTriggers 0
UseContinueOperation 0
enableTermAttemptAuthorizedConnect 1
masterStatsServer STATSMASTERNODE

SendCIR 0
AskCIRAttemptElapsedTime 1
AskCIRStopTime 1
AskCIRConnectElapsedTime 1
AskCIRCallAddress 1
usePendingTnForCaInCdr 0
AskCIRReleaseCause 1
recordSmpStatistics 1
disarmEDPs 0
tzDefault Europe/Prague

# set the engine's terminationNumber, which
# is printed as TN in the CDR, to:
# 0 - the digits sent over the network in the connect
# 1 - the normalised number sent to the service loader
normaliseTerminationNumber 0

# Normalise the SN (Service Number) in the CDR and set CPNN
# (Called Party Nature of Number) to match:
# 0. SN = the digits received over the network in the IDP
#   CPNN = the Nature of Address received over the network in the IDP
# 1. SN = the normalised number received from the service loader
#   CPNN = 0, a normalised number does not have a Nature of Address
normaliseServiceNumber 0

# Normalisation rules
# These translate numbers from the network, which have NOA and digits, into a
standard form for use within ACS.
# They can either be in the acsChassis section or in a service entry specific
section, which has
# the same name as the service name in the ServiceEntry line.
#
# NormalisationRule
(<inNOA>,<inPrefix>,<stripDigits>,<outPrefix>[,<minLength>[,<maxLength>]]
#
```

```

#   inNOA . This rule will only match numbers with this NOA
#   inPrefix . This rule will only match numbers with this prefix
#   stripDigits . Strip this many digits from the front of the number
#   outPrefix . Then, add this many digits to the front of the number
#   minLength,maxLength . The rule will only match numbers of this length

# NormalisationRule (3,-,0,-,10,13,m)
#   This says normalise nationally significant (NOA 3) numbers where the MSC
address
#   (m) has a prefix in the countryCodes list (longest match), the matched number
is
#   between 10 and 13 characters long and the result is the matched number
prefixed
#   with the country code prefix from the MSC address.

# Denormalisation rules
# These translate numbers stored inside ACS as just digits to digits and NOA to be
sent out to the network.
# They can either be in the acsChassis section or in a service entry specific
section, which has
# the same name as the service name in the ServiceEntry line.
#
# DenormalisationRule
(<inPrefix>,<outNOA>,<noOfDigitsToRemove>,<outPrefix>[,<minLength>[,<maxLength>]])
#
#   inPrefix . This rule will only match numbers with this prefix
#   outNOA . Use this NOA in the number sent out
#   noOfDigitsToRemove . Strip this many digits from the front of the number
#   outPrefix . Then, add this many digits to the front of the number
#   minLength,maxLength . The rule will only match numbers of this length
#
# There is a second form of DenormalizationRule which takes an NOA
#
# DenormalisationRule
(noa,<NOA>,<inPrefix>,<outNOA>,<noOfDigitsToRemove>,DigitsToAdd)
#
#   Where the first noa is the literal, lowercase text "noa".
#
# Example:
# DenormalisationRule (noa,3,E,4,0,999)
#
# This rule will convert the NoA to 4 and add "999" to any ICA outgoing number
# with an NoA of 3.

# The interval in seconds to be used for checking dialog timers.
# Note that this effectively deprecates the RIMS Chassis Action approach to doing
this.
# Setting to 0 will disable this explicit setting (in which case 10 will be used).
# Defaults to 0 if not specified for backwards compatibility.
# dialogTickInterval 10

#
# alwaysIncludePartyToCharge
#
#   If set, we set partyToCharge parameter in ACs
#   to the leg1 party.
#
# Defaults to 0 - partyToCharge is not set.
#
# alwaysIncludePartyToCharge 1

#
# alternativeCallPlanNamePostfix

```

Chapter 5

```
#
# This string is appended to the end of the Control Plan name
# and this new control plan is the replacement control plan when
# alternative control plan replacement is activated from the
# ACS Screens. Services -> ACS Service -> Customer
#       -> Control Plan Change Tab
#
# Defaults to _alt
#
# Example:
#   alternativeCallPlanNamePostfix _emergency
#
alternativeCallPlanNamePostfix _alt

#
# minimumSizeOfConnectSleeEvent configures the minimum size of a SLEE event used
# to return the Connect message. This defaults to 1024.
# A service specific configuration may be added if required to reduce the amount of
# memory required for 'normal' services.
#
minimumSizeOfConnectSleeEvent 1024

#
# Checking for AWOL calls, disabled by default.
#
# Note that Apply Charging operations do not use awolTimeout (see below).
#
# checkAWOL 0 - disable
#           1 - enable
#
# awolTimeout - the timeout period (in seconds) for events that are not the
#               last events. May be specified for service instance section.
#
# awolReportOnly 0 - always raise warning alarm when cleaning up each AWOL call
#                 1 - only raise warning alarm which summarizes changes
#                 May be specified for service instance section.
#
# awolReportPeriod - how often (in seconds) to provide summary report.
#                   May be specified for service instance section.
#
# checkAWOLMarginAC - configurable tolerance added to Apply Charging timeout.
#                   Replaces old checkAWOLMargin setting (now deprecated).
#
# awolOverrideACRTimeout - Configurable on a per-service basis only.
#                         Specifies the period of time (seconds) within which we
#                         expect to have received an Apply Charging Report. If
#                         the ACR is not received during this time then the call
#                         is cleaned up. It is anticipated that this value will
#                         be used in data session scenarios where the return
#                         time of the ACR cannot be predicted based on the
#                         Apply Charging request.
#                         Note. if set, then the value in checkAWOLMarginAC is
ignored.
#
#                         Note. value of zero means do not override timeout from
ACR.
#
#
checkAWOL 0
awolTimeout 1800
awolReportOnly 0
awolReportPeriod 900
awolOverrideACRTimeout 0
checkAWOLMarginAC 30:

# end of acsChassis configuration
```

```

# =====
# Apply the timezone specified by parameter tzDefault
# to the stored profile date. If tzDefault is not set, the
# default system timezone will be used.

ProfileDateCompare
  useTzDefault 1

# =====
# configuration for Get Hunting Number node

acsGetHuntingNumber

  # setCallData {0|1}
  # if non zero use the VPN Set Call Data chassis action
  # to set the RedirectingPartyID and OriginalCalledPartyID
  # set to 1 if you have VPN installed.
  # defaults to 0
  setCallData 0:

# =====
# configuration for Play Variable Part Announcement node
#
# This is necessary if the Denormalise check box is used in the
# Play Variable Part node. By default, the Play Variable Part Announcement
# node looks in a section called NumberRulesInteraction.
# An alternative section name can be given in the
# acsPlayVariablePartAnnouncement section

# Uncomment this to use the examplePVP section for denormalisation rules
# for the Play Variable Part Announcement node.
#
#acsPlayVariablePartAnnouncement
# NumberRulesSection examplePVP:
#
#examplePVP
# # Denormalisation Rules (Prefix, NOAToAdd, NumberOfDigitsToRemove, DigitsToAdd,
# MinLength)
# DenormalisationRule (0064,2,4,0,12):

# Uncomment this to use the default section name for denormalisation rules
# for the Play Variable Part Announcement node.
#
#NumberRulesInteraction
# # Denormalisation Rules (Prefix, NOAToAdd, NumberOfDigitsToRemove, DigitsToAdd,
# MinLength)
# DenormalisationRule (0064,2,4,0,12):

# service specific configuration for ACS_Outgoing (overrides standard acsChassis
# configuration)
ACS_Outgoing
  minimumSizeOfConnectSleeEvent 2048:

# end of file

```

Background Processes

Overview

Introduction

This chapter explains how to manage the Advanced Control Services (ACS) processes.

Purpose

The chapter lists the ACS processes which execute on an installed ACS platform. These processes are a combination of inittab processes, and cron processes.

Important: It is a prerequisite for managing these core service functions that the operator is familiar with the basics of Unix process scheduling and management. Specifically, the following Unix commands:

- init (and inittab)
- cron (and crontab)
- ps
- kill

In this chapter

This chapter contains the following topics.

Automated ACS Processes (SMS Machine)	167
acsCompilerDaemon	168
acsSnCpActAlarms.....	169
acsDbCleanup.sh	171
acsProfileCompiler	171
acsStatisticsDBInserter	172
Automated ACS Processes (SLC Machine).....	173
acsStatsMaster	173
libacsChassisActions	174
libacsMacroNodes	174
libacsService	175

Automated ACS Processes (SMS Machine)

Introduction

The acsSmp package installs three tasks into the `/etc/inittab`. These tasks should be running at all times. The tasks are:

- acsCompilerDaemon
- acsStatisticsDBInserter
- acsProfileCompiler

These three binaries are run from `/IN/service_packages/ACS/bin`, through start shell scripts also in that directory.

The acsSmp packages also install the acsDbCleanup.sh task into the crontab for user acs_oper.

acsCompilerDaemon

Purpose

The acsCompilerDaemon runs continuously, polling the database to look for newly written control plans and control plan structures (for example, indicated by database field ACS_CALLPLAN.BUILD = B).

The control plan compiler generates the fast-lookup binary compiled control plan data which is actually used at execution time.

The compiler can use plug-ins for additional, specialized functions.

Plug-ins

The compiler uses the plug-ins after the standard compilation has completed, and in the order the plug-ins are listed in **acs.conf**.

This table describes the function of each acsCompilerDaemon plug-in.

Plug-in	Description
libwsdlGenerator.so	<p>This plug-in produces the WSDL code for the operation used by the control plan.</p> <p>If this is the first operation, the complete WSDL operation set file is produced and this operation inserted.</p> <p>For all other operations for the same operation set, the code is inserted after the previous operation code.</p> <p>For further information on operations and operation sets, see <i>OSD User's and Technical Guide</i>.</p>

Startup

This task is started by entry acs0 in the inittab, through the `/IN/service_packages/ACS/bin/acsCompilerDaemonStartup.sh` shell script.

Location

This binary is located on the SMS node.

Parameters

The acsCompilerDaemon does not support any command line parameters; it is completely configured through the **acs.conf** file. For more information, see *Configuring the acs.conf* (on page 73).

Failure

If the acsCompilerDaemon has failed, then control plans will not be compiled. This can be detected by executing the following SQL statement on the SMF database instance:

```
SELECT ID from ACS_CALL_PLAN where BUILD='B';
```

Under normal operation, control plans will only remain in the B state for a few seconds at most.

Output

The `acsCompilerDaemon` writes error messages to the system messages file, and also writes additional output to `/IN/service_packages/ACS/tmp/acsCompilerDaemon.log`.

acsSnCpActAlarms

Purpose

`acsSnCpActAlarms` queries the `ACS_SN_CALL_PLAN_ACTIVATION` database table and generates alarms when it finds any scheduled control plans that have been temporarily disabled by Emergency Control Plan Activation.

Location

This binary is located on the SMS node.

Startup

This task is run in the crontab for `acs_oper`.

`/IN/service_packages/ACS/bin/acsSnCpActAlarms`

Note: You may optionally write a shell script (to manually start) if you wish to change defaults.

Parameters

The `acsSnCpActAlarms` does not support any command line parameters. It is configured through the `eserv.config` file.

acsSnCpActAlarms Parameters in `eserv.config`

Here is an example of the `acsSnCpActAlarms` section in the `eserv.config` file.

```
acsSnCpActAlarms = {
  oracleUserIdPassword = "/"
  alarmCheckInterval = 60
  repeatAlarm = false
  serviceNumberTerm = "Service Number"
  alarmReason = "by Alternative Control Plan Activation"
}
```

`oracleUserIdPassword`

Syntax:	<code>oracleUserIdPassword = "user/pw"</code>
Description:	The Oracle user ID and password that <code>acsSnCpActAlarms</code> uses to log into the database.
Type:	String
Optionality:	Optional (default used if not set).
Allowed:	
Default:	<code>"/"</code>
Notes:	
Example:	<code>oracleUserIdPassword = "/"</code>

alarmCheckInterval

Syntax: `alarmCheckInterval = mins`
Description: Alarms will be generated if the difference between the current time and the control plan's effective date (being in the past) is less than the value specified by this parameter.
Type: Integer
Optionality: Optional (default used if not set).
Allowed:
Default: 60
Notes: Set this value to a similar/compatible value when running `acsSnCpActAlarms` from crontab. For example, if crontab is set up to run this process every hour, set this value to 60 minutes.

Warning: Running this process too frequently from crontab may adversely affect system performance. The recommended crontab configuration is to run this process every hour or at a greater interval.

Example: `alarmCheckInterval = 60`

repeatAlarm

Syntax: `repeatAlarm = true|false`
Description: If set to true, relevant alarm(s) will be repeated every `alarmCheckInterval` minutes until alternative control plan replacement is deactivated.
Type: Boolean
Optionality: Optional (default used if not set).
Allowed:
Default: false
Notes:
Example: `repeatAlarm = false`

serviceNumberTerm

Syntax: `serviceNumberTerm = "snterm"`
Description: The preferred term used to describe a Service Number.
Type: String
Optionality: Optional (default used if not set).
Allowed:
Default: "Service Number"
Notes:
Example: `serviceNumberTerm = "Freephone Number"`

alarmReason

Syntax: `alarmReason = "reason"`
Description: The reason the alarm is generated. This text is used in the alarm description.
Type: String
Optionality: Optional (default used if not set).
Default: "by Alternative Control Plan Activation"

Notes: Example alarm:
 If serviceNumberTerm = "Freephone Number" and alarmReason = "by Emergency Control Plan Activation", then the alarm description would be:
 "WARNING. Scheduled Control Plan(Name) for Customer(Name), Freephone Number(123) has been temporary disabled by Emergency Control Plan Activation"

Example: `alarmReason = "by Alternative Control Plan Activation"`

acsDbCleanup.sh

Purpose

This task executes SQL statements to delete old data from the ACS Event Counter table ACS_STATISTICS_COUNT, and also to delete old compiler output from the ACS_COMPILE_ERRORS table.

Startup

This task is run in the crontab for acs_oper, by default at 02:00 local system time. It is a shell script, specifically `//IN/service_packages/ACS/bin/acsDbCleanup.sh`.

Location

This binary is located on the SMS node.

Parameters

The purge-age in days is defined inside the shell script itself, and can be adjusted, subject to limitations of table space in the database.

Failure

If this process is not running, old entries in the specified tables will not be purged.

Output

The `acsDbCleanup.sh` script writes output to `//IN/service_packages/ACS/tmp/acsDbCleanup.sh.log`.

acsProfileCompiler

Purpose

The `acsProfileCompiler` polls for changes in the timezone and/or termination number ranges configured in the database. It then performs changes in the global profile, and in customer profiles for customers who have non-default termination ranges defined.

Startup

This task is started by entry `acs2` in the `inittab`, through the `//IN/service_packages/ACS/bin/acsProfileCompilerStartup.sh` shell script.

Location

This binary is located on the SMS node.

Parameters

The `acsProfileCompiler` does not support any command line parameters, it is completely configured through the `acs.conf` file. For more information, see *Configuring the acs.conf* (on page 73).

Failure

If the process fails, then changes to the ACS timezone geography set will not be reflected on the SLC call-processing. Similarly, changes to the self-management control plan.

Note: The termination number constraints for ACS GUI changes will continue to operate as expected.

Output

The `acsProfileCompiler` writes error messages to the system messages file, and also writes additional output to `/IN/service_packages/ACS/tmp/acsProfileCompiler.log`.

acsStatisticsDBInserter

Purpose

The `acsStatisticsDBInserter` communicates with the `acsStatsMaster` process (see below), and polls for changes to ACS event counters.

Note: This process is not the same as the `smsStatsDaemon`, although the names are similar.

Startup

This task is started by entry `acs1` in the `inittab`, through the `/IN/service_packages/ACS/bin/acsStatisticsDBInserterStartup.sh` shell script.

Location

This binary is located on the SMS node.

Parameters

The `acsStatisticsDBInserter` supports the following command-line options:

Usage:

```
acsStatisticsDBInserter -h hostname -p port -s sleep
```

These options can be used for testing to override the values specified in the `acsStatisticsDBInserter` section of the `acs.conf`, however they should not be required on an operational platform.

Parameter	Description
<code>-h <i>hostname</i></code>	host name
<code>-p <i>port</i></code>	port
<code>-s <i>sleep</i></code>	sleep

Failure

This process will periodically write updated event counts to the ACS database, into the table `ACS_STATISTICS_COUNT`. If there are no event counts being modified by active control plans, the this process may appear to be inactive.

Failure of this process will result in no updates to the `ACS_STATISTICS_COUNT` table, even when `EventCounting` nodes are encountered in active control plans.

Output

The `acsStatisticsDBInserter` writes error messages to the system messages file, and also writes additional output to `/IN/service_packages/ACS/tmp/acsStatisticsDBInserter.log`.

Automated ACS Processes (SLC Machine)

Introduction

The `acsScp` package installs one task into the `/etc/inittab` for one of the SLC machines in an SLC grouping. This task should be running on that one machine at all times. The task is:

- `acsStatsMaster`

This binary is run from `/IN/service_packages/ACS/bin`, through start-up shell script contained within that same directory.

acsStatsMaster

Purpose

The `acsStatsMaster` runs only on one SLC machine, typically `SCP1`. All other SLC nodes communicate with the master through TCP/IP to correlate their ACS event counter values.

Startup

This task is started by entry `acs3` in the `inittab`, through the `/IN/service_packages/ACS/bin/acsStatsMasterStartup.sh` shell script.

Location

This binary is located on SLCs.

Parameters

The `acsStatsMaster` does not support any command line parameters, it is completely configured through the `acs.conf` file. For more information, see *Configuring the acs.conf* (on page 73).

Failure

If the `acsStatsMaster` is not running, then individual nodes will not be able to correlate their event counter values. This will mean that control plans may perform incorrect branching. Additionally, the `acsStatisticsDBInserter` process will not be able to track changes to ACS event counter values, and there will be no updates to the corresponding table in the database.

Output

The `acsStatsMaster` writes error messages to the system messages file, and also writes additional output to `/IN/service_packages/ACS/tmp/acsStatsMaster.log`.

libacsChassisActions

Purpose

`libacsChassisActions` provides the functions which enable the ACS feature nodes to interact with other elements in the system, including:

- SLEE interfaces (such as TCAP IF)
- Other elements on the network (such as the VPU)

Startup

If `libacsChassisActions` is included in the `acs.conf`, `libacsChassisActions` will be available to `slee_acs` when the SLEE is started.

For more information about how this is included in `acs.conf`, see *ChassisPlugin* (on page 78).

Configuration

`libacsChassisActions` is configured by parameters in the `acsChassis` section of `acs.conf`. For more information, see *Configuring the acs.conf* (on page 73).

libacsMacroNodes

Purpose

This `slee_acs` plug-in library provides the base ACS feature nodes. For more information about the feature nodes provided by this library, see *CPE User's Guide*.

Startup

If `libacsMacroNodes` is included in the `acs.conf`, `libacsMacroNodes` will be available to `slee_acs` when the SLEE is started.

For more information about how this is included in `acs.conf`, see *MacroNodePluginFile* (on page 77).

Configuration

`libacsMacroNodes` accepts the parameters from `acs.conf`. For more information about the available configuration, see:

- *Get Hunting Number Node Configuration* (on page 156)
- *Play Variable Part Announcement Node Configuration* (on page 157)

libacsService

Purpose

libacsService is the ACS service library plug-in for `slee_acs` which handles initial set up of control plans. Based on the incoming call details, it loads up the relevant control plan and feature nodes.

Note: If other applications are installed, they may provide their own service libraries which will be used instead of libacsService.

Startup

If libacsService is configured in `acs.conf`, it is made available to `slee_acs` when `slee_acs` is initialized. It is included in the `acsChassis` section of `acs.conf` in a `ServiceEntry` parameter.

```
acsChassis
  ServiceEntry (ACS,libacsService.so)
```

For more information about this configuration, see *acsChassis ServiceEntry Configuration (SLC)* (on page 123).

Configuration

libacsService supports parameters from `acs.conf`. For more information, see *Configuring the acs.conf* (on page 73).

Tools and Utilities

Overview

Introduction

This chapter explains the tools and utilities available in Advanced Control Services (ACS).

In this chapter

This chapter contains the following topics.

acsAddCallPlan	177
acsAddCustomer	179
acsAddGeography	180
acsAddServiceNumber	181
acsDecompile	182
acsDumpControlPlan	183
acsMonitorCompiler	184
acsProfile	184
acsScheduleCallPlan	187
acsSetupAnnouncement	187
numberDataImport	188

acsAddCallPlan

Purpose

Use the `acsAddCallPlan` tool to import a control plan, defined in a `.cpl` text file, into the SMF database either on the same platform or on a different platform. For example, you can export a control plan from one platform by using `acsDumpControlPlan` (on page 183) and then import the control plan into a different platform by using `acsAddCallPlan`.

The java shell script for `acsAddCallPlan` is located on SMS nodes. It launches a Java command line class that reuses the CPE code to achieve its requirements.

About connecting to the database

`acsAddCallPlan` and `acsDumpCallPlan` connect to the database on a local or a remote SMS node based on the values specified for the `-u`, `-j`, and `-b` command line options.

You can connect to the database by specifying the following:

- `-u username/password` (for local connections)
- `-u username/password -j remote_hostname [-b port:db_SID]` (for remote connections)
- `-u /@wallet_user` (for local or remote connections through the Oracle wallet secure external password store)

where:

- `username` and `password` are user credentials for a screens user or for the SMF database user.

- *remote_hostname* is the host name of the machine running the remote database.
- *port* and *db_SID* are the port number and database SID of the remote database. If not specified, defaults to 1521:SMF
- *wallet_user* is the alias defined for the username and password credentials in the Oracle wallet secure external password store. For remote connections, this alias can be either a TNS name or a service name from **tnsnames.ora**.

Configuration

acsAddCallPlan accepts the following parameters.

Usage:

```
acsAddCallPlan [-u {usr/pwd|/@wallet_user}] [-j host] [-b port:db_id] [-v] [-D
directory [-O directory] -C acs_customer]
```

The available parameters are:

Parameter	Default	Description
-u <i>usr/pwd</i> -u /@ <i>wallet_user</i>		Specify one of: <ul style="list-style-type: none"> • The username and password credentials for connecting to the database. Username must be a screens user credentials or SMF database user. • The <i>wallet_user</i> alias for the database credentials from the oracle wallet external password store. For remote connections to the database, the alias can be either a TNS name or a service name from tnsnames.ora.
-j <i>host</i>	localhost	The host name of the machine running the SMF database.
-b <i>port.db_id</i>	1521:SMF	The port number and database ID of the SMF database.
-v	off	Verbose (optional)
-D <i>directory</i>	ignored	Specify the directory containing the .cpl files to import (optional).
-O <i>directory</i>	ignored	Specify the directory to move successfully imported files to (optional, only relevant with -D). Any files that fail to import will not be moved.
-C <i>acs_customer</i>	ignored	Specify the ACS customer that will own the imported control plans (required if -D is used).

When -D option is *absent*, records are added by stdin lines in the following format:

```
-c name -f file [-s name][[-t name] [-d name] [-m ID] [-p]
```

Where the record content is:

Field	Description
-c <i>name</i>	Customer name.
-f <i>file</i>	Exported control plan file name.
-s <i>name</i>	New template name (optional). Tip: This is used when there is no existing template.
-t <i>name</i>	Existing template name (optional).
-d <i>name</i>	New control plan name (optional).
-m <i>ID</i>	MF Identifier for the control plan (optional).
-p	Make inserted control plan public (optional).

When -D option is *present*, records are added in the following format for each **.cpl** file:

```
-c cust_name -f cpl_file -s cpl_name -d cpl_name
```

Where the record content is:

Field	Description
-c <i>cust_name</i>	Customer name is taken from the -C option argument.
-f <i>cpl_file</i>	Is the filename of each .cpl file in the directory from the -D argument.
-s <i>cpl_name</i>	Is the cpl file basename with the .cpl extension removed.
-d <i>cpl_name</i>	Is the cpl file basename with the .cpl extension removed.

The control plan text file format is the same as that used for an exported control plan.

Imported control plans will be set private and mf_identifier will be set NULL.

acsAddCustomer

Purpose

Inserts a customer record into the SMF database.

Location

This binary is located on the SMS node.

Configuration

acsAddCustomer accepts the following parameters.

Usage:

```
acsAddCallPlan -u usr/pwd [-v]
```

The available parameters are:

Parameter	Default	Description
-u <i>usr/pwd</i>		username/password. Username must be acs_admin.
[-v]	off	Verbose

Records are added by stdin lines in the following format:

```
-c name [-f set] [-y set] [-g set] [-n set] [-m] [-r ref] [-d desc] [-l usr] [-o val=options] [-t policy]
```

Where the record content is:

Field	Default	Description
-c <i>name</i>		Customer name (mandatory).
-f <i>set</i>		Feature node set name (optional).
-y <i>set</i>		Holiday set name (optional).
-g <i>set</i>		Geography set name (optional).
-n <i>set</i>		Announcement set name (optional).
-m		Customer is Telco managed (optional).

Field	Default	Description
<code>-r ref</code>		Customer reference (optional).
<code>-d desc</code>		Customer description (optional).
<code>-l usr</code>		User name to be added for this customer (optional).
<code>-o val=options</code>		Resource limits for customer (optional). Options are: <ul style="list-style-type: none"> • eventlogs • statscounters • nodesinplan • callplans • callplanstructures • announcementsets • announcemententries • holidaysets • holidayentries • geographysets • geographyentries • users
<code>-t policy</code>	global	Termination number range rules (optional). Options are: <ul style="list-style-type: none"> • private (own range) • global (default checking) • any (no checking)

acsAddGeography

Purpose

Inserts Geography Set(s) into the SMF database from a text file.

Location

This binary is located on the SMS node.

Configuration

acsAddGeography accepts the following parameters.

Usage:

```
acsAddGeography -u usr/pwd [-c customer | -p] [-r int] [-g] filenames
```

The available parameters are:

Parameter	Default	Description
<code>-u <i>usr/pwd</i></code>		Oracle username/ password.
<code>-c <i>name</i></code>		Customer to own created geography sets. The <code>-c</code> and <code>-p</code> parameters are mutually exclusive.

Parameter	Default	Description
-p		Public set.
-r <i>int</i>		Number of records before a commit (optional).
-g		Global number prefix (optional).
<i>filenames</i>		Input filename.

Input file structure

Geography set input files use the following format, where the indentation indicates what the data is, and hence is very important:

```

Geography set name
  area = 1
  another area
    sub area = 21
    another sub area = 22
# blank lines or comments (# = comment line) are allowed.

```

```

Another geography set
  newlands = 343

```

acsAddServiceNumber

Purpose

Inserts a service number record into the SMF database.

Location

This binary is located on the SMS node.

Configuration

acsAddServiceNumber accepts the following parameters.

Usage:

```
acsAddServiceNumber -u usr/pwd [-v]
```

The available parameters are:

Parameter	Default	Description
-u <i>usr/pwd</i>		Oracle username/ password.
[-v]	off	Verbose

Records are added by stdin lines in the following format:

```
-c customer -s sn [-r desc] [-b] [-p pin] [-f number] [-a options] [-t 1|2] [-i 0|1]
[-d list]
```

Where the record content is:

Field	Description
-c <i>name</i>	Customer Name.
-s <i>sn</i>	Service Number.

Field	Description
-r <i>desc</i>	Description (optional).
-b	Use Toll Free beeps (optional).
-p <i>pin</i>	PIN (optional).
-f <i>number</i>	Follow me number (optional).
-a <i>options</i>	Policy, Min/Max, Account Codes (optional).
-t 1 2	Barred list type (optional). <ul style="list-style-type: none"> • 1=barred, numbers are barred only if they occur in the list. If the list is empty then no numbers are barred – everything is allowed. • 2=allowed, numbers are allowed only if they occur in the list. If the list is empty then no numbers are allowed – everything is barred.
-i 0 1	Barred list ignore (optional). <ul style="list-style-type: none"> • 0=ignore list contents • 1=use the list contents
-d <i>list</i>	List of barred/ allowed numbers (optional).

acsDecompile

Purpose

Takes a compiled control plan and decodes it into the control plan text file format.

Location

This binary is located on both SLCs and SMSs.

Configuration

acsDecompile accepts the following parameters.

Usage:

```
acsDecompile [-u usr/pwd] [-d dataID|-s structureID] [-r|-n]
```

The available parameters are:

Parameter	Description
-u <i>usr/pwd</i>	Oracle username/password.
-d <i>dataID</i>	Control plan Data ID to decompile.
-s <i>structureID</i>	Control plan structure ID to decompile.
-r	Dump raw content only.
-n	Attempt to decompile node data.

acsDumpControlPlan

Purpose

Use the `acsDumpControlPlan` tool to export one or more control plans from the SMF database to text files (one file per control plan). You can import the control plan text files to either the same platform or a different platform, by using `acsAddCallPlan` (on page 177).

The java shell script for `acsDumpControlPlan` is located on SMS nodes. It launches a Java command line class that reuses the CPE code to achieve its requirements.

About connecting to the database

`acsAddCallPlan` and `acsDumpCallPlan` connect to the database on a local or a remote SMS node based on the values specified for the `-u`, `-j`, and `-b` command line options.

You can connect to the database by specifying the following:

- `-u username/password` (for local connections)
- `-u username/password -j remote_hostname [-b port:db_SID]` (for remote connections)
- `-u /@wallet_user` (for local or remote connections through the Oracle wallet secure external password store)

where:

- `username` and `password` are user credentials for a screens user or for the SMF database user.
- `remote_hostname` is the host name of the machine running the remote database.
- `port` and `db_SID` are the port number and database SID of the remote database. If not specified, defaults to 1521:SMF
- `wallet_user` is the alias defined for the username and password credentials in the Oracle wallet secure external password store. For remote connections, this alias can be either a TNS name or a service name from `tnsnames.ora`.

Configuration

Usage:

```
acsDumpControlPlan -d out_dir [-u {user/password|@wallet_user}][-j host] [-b
port:db_id] [-c customer] [-p control_plan] [-i id] | -S [-v]
```

The available parameters are:

Parameter	Default	Description
<code>-d out_dir</code>		Directory where exported control plan will be written.
<code>-u user/password</code> <code>-u @wallet_user</code>		Specify one of: <ul style="list-style-type: none"> • The username and password credentials for connecting to the database. Username must be a screens user credentials or SMF database user. • The <code>wallet_user</code> alias for the database credentials from the oracle wallet external password store. For remote connections to the database, the alias can be either a TNS name or a service name from <code>tnsnames.ora</code>.
<code>-j host</code>	localhost	The host name of the machine running the SMF database.

Parameter	Default	Description
-b <i>port.db_id</i>	1521:SMF	The port number and database ID for the SMF database.
-c <i>customer</i>	ignored	Name of the customer who owns the control plan (optional).
-p	ignored	Name of the control plan. May contain % and wildcard characters (optional).
-i <i>id</i>	ignored	The control plan ID in the ACS call plan table. If specified, ignores -c and -p. (optional)
-v	off	Verbose mode (optional).
-S	ignored	If set, create all files in the same directory as <i>out_dir/customer_name_version.cpl</i> . Otherwise, create files in subdirectories as <i>out_dir/customer/name/version.cpl</i> . (optional)

The control plan text file format is the same as that used for an exported control plan using the CPE.

acsMonitorCompiler

Purpose

Checks the number of control plans waiting to be compiled.

acsMonitorCompiler is designed to be run after a large number of control plans have been entered.

Note: No further control plans should be entered once acsMonitorCompiler has been started.

Location

This binary is located on the SMS node.

Configuration

acsMonitorCompiler accepts the following parameters.

Usage:

```
acsMonitorCompiler -u usr/pwd -s secs [-w] [-e]
```

The available parameters are:

Parameter	Default	Description
-u <i>usr/pwd</i>	smf/smf	Oracle username/password.
-s <i>secs</i>		Seconds between database checks.
-w		Display warnings and above (optional).
-e		Display errors and above (optional).

acsProfile

Purpose

Decodes, displays or changes the value of profile tags.

Location

This binary is located on the SMS node.

Configuration

Usage:

```
acsProfile [-u [/@SMF] | [/@SCP]]
           -[U]
           -[Nn|Ss|Cc|Pp|Gg|Ii|Yy|Zz|Ee|Ff] <IntKey>
           -[Nn|Ss|Cc|Pp|Gg|Ii|Yy|Zz|Ee|Ff] <StrKey>
           -[j] -
           -[j] <filename>
           -[D]
           -[W] <tag> -[A|H|L|B] <data>
           -[R] <tag>
           -[K] <tag1>[.<subtag1>],<tag2>[.<subtag2>]
           -[V] <tag1>[.<subtag1>],<tag2>[.<subtag2>]
           -[T] <tag> -[t] [h|P|d|a|p|m|n|l|v|V|A|B|D|i|H|I|U|W|N|S|O|M]
           -[X] <tag>
           -[Q]
```

The available parameters are:

Parameter	Description
[-u [/@SMF] [/@SCP]]	Specify the SID of the remote database to connect: <ul style="list-style-type: none"> • /@SMF for SMS • /@SCP for SLC
-U	Specify to enable SMF_SECURITY validation.
-targetProfile keyID 'str'	Specify the profile block that contains the target profile tags followed by the key as a string or an integer. You can specify one of the following values for <i>targetProfile</i> : <ul style="list-style-type: none"> • N n = VPN_NETWORK.PROFILE where <i>keyID</i> is an integer or the name of the VPN network profile • S s = VPN.STATION.PROFILE where <i>keyID</i> is an integer or the name of the VPN station profile • C c = ACS_CUSTOMER.PROFILE where <i>keyID</i> is an integer or the name of the ACS customer profile • P = ACS_CALL_PLAN_PROFILE.PROFILE where <i>keyID</i> is an integer of the ACS call plan profile • G = ACS_GLOBAL_PROFILE.PROFILE where <i>keyID</i> is an integer of the ACS global profile • I i = ACS_CUSTOMER_CLI.PROFILE where <i>keyID</i> is an integer or command-line interface (CLI) of the ACS customer CLI profile • Y y = ACS_CUSTOMER_SN.PROFILE where <i>keyID</i> is an integer or service number (SN) of the ACS customer SN profile • Z z = CCS_ACCT_REFERENCE.PROFILE where <i>keyID</i> is an integer or command-line interface (CLI) of the CCS account reference profile • E = CCS_GLOBAL_CONFIG.PROFILE where <i>keyID</i> is an integer of the CCS global configuration profile • F = CCS_ACCOUNT_TYPE.PROFILE where <i>keyID</i> is an integer of the CCS account type profile

Parameter	Description
	Note: Specify lowercase to force acsProfile to accept a string <i>keyID</i> value.
-j <i>-filename</i>	Specify to use the stdin/stdout pipeline or a specified file for the target profile. To use: <ul style="list-style-type: none"> Stdin/stdout, specify: -j - A specified file, specify: -j <i>filename</i>, where <i>filename</i> is the name of the file.
-D	Defaults to dump profile
-W <i>tag</i> <i>-[A H L B] data</i>	Specify to update, insert, or write a tag with the specified data
-R <i>tag</i>	Specify to remove a tag
-K <i>tag1[.subtag1],tag2[.subtag2]</i>	Specify to copy the data in <i>tag1</i> to <i>tag2</i>
-V <i>tag1[.subtag1],tag2[.subtag2]</i>	Specify to move the data in <i>tag1</i> to <i>tag2</i>
-T <i>tag</i> <i>[-t tagType]</i>	Decodes one tag, specified in <i>tag</i> , as the chosen type, where type is one of the following: h = ASCII Hex P = embedded profile, all of whose tags are hex d = tree of digit strings a = Announcement Map p = prefix tree of digits and strings m = Miscellaneous n = Number Lists l = Long triples; such as TimeOfWeek v = Variable Announcement Rule Set (VARS) table V = VARS Mapping table A = Array B = Boolean D = Date i = Discount H = HuntingConfig I = Integer U = UnsignedInteger W = UnsignedInteger64 N = NumericString S = String O = OrderedPrefixTree M = NumberMatchingPatterns Example: -T <i>Date_1</i> -t D Where <i>Date_1</i> is the profile tag and D is the decoded tag type
-X <i>tag</i>	Cross checks the chosen tag in this profile. For example, for multi-lingual announcements in the global profiles, cross-check announcement language mappings and delete stray ones. Note: Write and remove actions also produce a post-change profile dump.
-Q	Indexes the new array type introduced by DAP and OSD. Setting this flag will allow indexing from zero.

acsScheduleCallPlan

Purpose

Inserts a control plan schedule record into the SMF database.

Location

This binary is located on the SMS node.

Configuration

acsScheduleCallPlan accepts the following

Usage:

```
acsScheduleCallPlan -u usr/pwd [-v]
```

The available parameters are:

Parameter	Default	Description
-u <i>usr/pwd</i>		Oracle username/ password.
[-v]	off	Verbose

Records are added by stdin lines in the following format:

```
-c name -s sn -p name -d YYYYMMDD24MMSS [-a]
```

Where the record content is:

Field	Description
-c <i>name</i>	Customer name
-s <i>sn</i>	Service number
-p <i>name</i>	Control plan name
-d <i>list</i>	Schedule time
-a	Activate against CLI not SN (optional).

acsSetupAnnouncement

Purpose

Inserts an announcement record into the SMF database.

Location

This binary is located on the SMS node.

Configuration

acsSetupAnnouncement accepts the following parameters.

Usage:

```
acsSetupAnnouncement [-u usr/pwd] [-l lang] -s set -e entry -r srf -i id [-c name]
[-v] [-n] [-g time] [-d desc]
```

The available parameters are:

Parameter	Description
-u <i>usr/pwd</i>	Oracle username/password (optional)
-l <i>lang</i>	Language name (optional)
-s <i>set</i>	Set name
-e <i>entry</i>	Entry name
-r <i>srf</i>	srf name
-i <i>id</i>	Numeric announcement ID
-c <i>name</i>	Customer name (optional). If not set, the announcement set will be public.
-v	Verbose (optional)
-n	No SMS security challenge (optional)
-g <i>time</i>	Generate script to run this tool to create same mappings (optional)
-d <i>desc</i>	Announcement description (optional)

numberDataImport

Purpose

The numberDataImport tool enables you to create and update table lookup datasets from a comma separated value (CSV) file.

You can create any number of table lookup datasets. Each table lookup dataset contains a group of related codes and prefix mappings. For example, you can create a table lookup dataset for a specific geographic area or suburb.

A table lookup dataset can be public or private. A private table lookup dataset belongs to a specific customer. It is only available to that customer and the parent customers linked to that customer in the customer hierarchy. A public table lookup dataset is available to all customers.

The numberDataImport tool is located at `/IN/service_packages/ACS/bin`.

Before running numberDataImport, you must do the following:

- Configure the numberDataImport tool in the `eserv.config` file. See *Configuring the numberDataImport Tool* (on page 189).
- Create the CSV input file for the numberDataImport tool. See *Creating the Dataset Input File* (on page 189).

When you run numberDataImport, you can use the `-u` (username and password) command-line option to specify the user credentials for connecting to the database on the SMS. You can use the `-u` option to specify only the user, or the user and the password.

- If you specify only the user, then numberDataImport prompts you for the user's password at run-time.
- If you omit the `-u` option, then numberDataImport connects to the database by using the default login value `'/`.

If, for security reasons, you want to prevent users from specifying the password in the `-u` command-line option when they run `numberDataImport`, disable the password field. To disable the password field, add the following lines to the `etc/profile` file on the SMS node:

```
NUMBER_IMPORT_NO_COMMAND_LINE_PASSWORD=str
export NUMBER_IMPORT_NO_COMMAND_LINE_PASSWORD
```

where *str* is any string value.

To run `numberDataImport`, see *Creating and Updating Table Lookup Datasets* (on page 190).

After creating table lookup datasets, you can use them in the Table Lookup feature node configurations. For information about configuring the Table Lookup feature node, see *Feature Nodes Reference Guide*.

You can search table lookup datasets for a prefix number or a mapping code using the ACS UI. For more information, see the discussion on configuring ACS in *ACS User's Guide*.

Configuring the numberDataImport Tool

You configure `numberDataImport` in the `NumberMappingImport` section of the `eserv.config` configuration file on the SMS. The following example shows the `NumberMappingImport` section:

```
NumberMappingImport = {
  closedDirectory = "closed_dir"
  errorDirectory = "error_dir"
  dbCommitBatchSize = size
  progressDotInterval = int
}
```

Where:

- *closed_dir* is the directory to which `numberDataImport` copies successful import files. Defaults to `/IN/service_packages/ACS/mappingData/closed` if not specified.
- *error_dir* is the directory to which `numberDataImport` writes import error files. Defaults to `/IN/service_packages/ACS/mappingData/error` if not specified.
- *size* sets the number of insert or update operations to perform before committing the data to the database. There is a 10 second pause at each interval to help throttle replication. Defaults to 5000 if not specified.
- *int* defines the number of insert or update operations to perform before displaying a progress dot (a dot that is displayed on the console for every *x* number of updates). Defaults to 100 if not specified.

Creating the Dataset Input File

You import entries into a table lookup dataset from a comma-separated value (CSV) file that you create. You specify this file as input to the `numberDataImport` tool when you run the tool from a command line.

Follow these steps to create the dataset CSV file.

Step	Action
1	Open a new file in a text editor.

Step	Action
2	<p>Add dataset entries to the file by using the following syntax for each entry. Add each entry on a new line:</p> <pre>a A d D,lookup_code,lookup_prefix</pre> <p>Where:</p> <ul style="list-style-type: none"> • a or A specifies to add the dataset entry. If the dataset entry already exists, it is updated. • d or D specifies to delete the dataset entry. If the dataset entry does not exist, this file entry is ignored. • <i>lookup_code</i> is the code that maps to the prefix in <i>lookup_prefix</i>. • <i>lookup_prefix</i> is a prefix number or CLI.
3	Save the file, giving it the file extension .csv .

Example CSV file entries:

```
a,3333,32014733
a,4444,32014744
d,5555,320147355
d,6666,320147366
```

Creating and Updating Table Lookup Datasets

Follow these steps to run the numberDataImport tool.

Step	Action
1	Open a command shell and log in to the SMS as the <code>acs_oper</code> user.
2	Navigate to the <code>/IN/service_packages/ACS/bin</code> directory.

Step	Action
------	--------

3 Run the numberDataImport tool by using the following syntax:
`./numberDataImport [-u user|user/password] [-F|D] [-s dataset] -i filename [-a acs_customer]`

Where:

- *user* and *user/password* – (Optional) is the user, or the user and password for an ACS user with the required user privilege level. The user must be a Screens user who has the `AcsNumberMappingImport` permission. For information on setting user privileges, see *SMS User's Guide*.
If you specify only the user, then `numberDataImport` prompts you for the user's password at run-time.
If you omit the `-u` option, then `numberDataImport` connects to the database by using the default login value `'/`.
- `F` and `D` – (Optional) indicates whether to create or update the dataset. Specify:
 - `F` to create the dataset. If the dataset already exists then you see a warning message asking if you want to continue. If you want to overwrite the existing dataset entries, then answer `Y`, otherwise answer `N`.
 - `D` to update the specified dataset.
 If you do not specify `F` or `D` and the dataset does not already exist, then `numberDataImport` creates a new dataset. If the dataset does exist, then it is updated.
- *dataset* – (Optional) is the name of the dataset that you want to create or update. If you do not specify *dataset*, then the dataset name defaults to "Default".
- *filename* – (Required) is the name of the CSV file that contains the dataset entries. The CSV file must have the `.csv` suffix.
- *acs_customer* – (Optional) defines the name of the ACS customer that the dataset belongs to. If you do not specify *acs_customer*, then the dataset will be public and therefore available to all customers.

Note: Values for the `-a`, `-s`, and `-i` parameters can be quoted or unquoted. However, you must enclose a value in quotes if it contains spaces.

For example, you could create `Dataset1` for customer `ABC` from the entries in `Dataset1.csv` by running the following command:

```
./numberDataImport -u user/password -F -s Dataset1 -i Dataset1.csv -a ABC
```

After successfully importing a dataset from a CSV file, the CSV file is moved to `/IN/service_packages/ACS/mappingData/closed` by default.

If the `numberDataImport` tool fails to import any entries, then these failed entries are written to the error file `/IN/service_packages/ACS/mappingData/error/filename.error` by default.

Where *filename* is the name of the CSV input file.

For information about the location of the `numberDataImport` output files, see *Configuring the numberDataImport Tool* (on page 189).

Pre-installation

Overview

Introduction

This chapter explains the pre-installation configuration requirements of the application.

In this chapter

This chapter contains the following topics.

ACS Client Specifications.....	193
Preparing the System	194

ACS Client Specifications

Specifications

This topic provides the specifications of Advanced Control Services (ACS).

Network

The minimum requirements of network bandwidth for acceptable normal response times are as follows:

Number of Users	Minimum Requirements
1-5	512 KB
6-15	1 MB
16 +	LAN connection (at least 25% available resource of 10 MB)

Memory

This table shows the minimum client resources required.

RAM	CPU
256 MB	800 MHz

This table shows the recommended client resources required.

RAM	CPU
512 MB	1.2 GHz

Response Times

This table shows typical response time.

GUI Action	Response Time
Startup to Login dialog	30 seconds maximum
Login to SMS main screen	20 seconds maximum
SMS main screen to ACS	5 seconds maximum
ACS main screen to CPE	15 seconds maximum

Screen

Here is the required screen specification.

Pixel
800 x 600 pixel resolution

Preparing the System

Introduction

It is recommended that you check the kernel parameters on the system to ensure the system is optimally configured.

The following parameters are described in their respective technical guides. However, they are collated here for reference.

Note: Actual kernel parameters may be greater than those listed here.

Checking Kernel Parameters

Follow these steps to check the Kernel parameters for Solaris.

Step	Action
1	Log in as root.
2	Enter <code>cat /etc/system</code>
3	Check the parameters are set to at least the minimum values.
4	Change the parameters as required using the following command from <code>/etc/system</code> .

Parameters

Here is a list of the Kernel parameters.

`msgtql`

Description: Maximum number of messages (system wide).

Allowed: Positive integer

Default: 600

msgmnb

Description: Maximum number of bytes per message queue.
Allowed: Positive integer
Default: 64000

semnmi

Description: Number of semaphore identifiers.
Allowed: Positive integer
Default: 100

semmsl

Description: Maximum number of semaphores per unique ID.
Allowed: Positive integer
Default: 250

semms

Description: Maximum number of semaphores.
Allowed: Positive integer
Default: 1024

shmmax

Description: Maximum shared Mem segment (bytes).
Allowed: Positive integer
Default: 4294967295 (Hex 40000000)

shmmi

Description: Minimum shared Mem segment (bytes).
Allowed: Positive integer
Default: 1

shmmni

Description: Number of shared memory identifiers.
Allowed: Positive integer
Default: 100

shmseg

Description: Number of shared memory segments allowed per process.
Allowed: Positive integer
Default: 10

Chapter 8

semopm

Description: Maximum number of semaphore operations that can be executed per semop system call.

Allowed: Positive integer

Default: 100

semvmx

Description: Maximum semaphore value.

Allowed: Positive integer

Default: 65535

About Installation and Removal

Overview

Introduction

This chapter provides information about the installed components for the Oracle Communications Convergent Charging Controller application described in this guide. It also lists the files installed by the application that you can check for, to ensure that the application installed successfully.

In this Chapter

This chapter contains the following topics.

Installation and Removal Overview	197
Installing acsSms Packages on a Clustered SMS	197
Checking the Installation	199
System Manifest	201

Installation and Removal Overview

Introduction

For information about the following requirements and tasks, see *Installation Guide*:

- Convergent Charging Controller system requirements
- Pre-installation tasks
- Installing and removing Convergent Charging Controller packages

ACS Packages

An installation of ACS includes the following packages, on the:

- SMS:
 - acsSms
 - acsCluster (for clustered SMS)
- SLC:
 - acsScp
- VWS:
 - acsBe

Installing acsSms Packages on a Clustered SMS

Raw Devices

ACS can allocate tablespace storage based on raw (without a file system) partitions. This enhances the performance of ACS on the SMS.

If you are using the raw devices option, you must create the raw partitions before installing the database using tools such as the system's format command.

The raw devices file (which you will be prompted to complete during the installation) must contain the full paths of the device files for the appropriate partitions.

The partitions must be at least as big as the required datafile sizes listed in the sizing file used by the installation.

Raw Devices Configuration

Follow these steps to configure raw devices.

Note: This is required only if the installation uses raw devices in place of datafiles.

Step	Action
1	<p>If your database sizing was set to large, create disk partitions of the following sizes:</p> <ul style="list-style-type: none"> 1 2501 MB 2 1501 MB 3 1501 MB <p>For more information about the format command, see man format.</p> <p>If your database sizing was set to medium, create disk partitions of the following sizes:</p> <ul style="list-style-type: none"> 1 7002 MB 2 5002 MB 3 4002 MB 4 201 MB 5 101 MB 6 2 MB <p>For more information about the format command, see man format.</p>
2	Edit the <code>acs_devices.sh</code> file specified above.
3	<p>Change the line:</p> <pre>ACS_DATA_DATAFILE=</pre> <p>to</p> <pre>ACS_DATA_DATAFILE=/dev/did/rdsk/<i>partition</i></pre> <p>Where: <i>partition</i> is the name of the partition (for example. d8s0)</p>
4	<p>Change the line:</p> <pre>ACS_INDEX_DATAFILE1=</pre> <p>to</p> <pre>ACS_INDEX_DATAFILE1=/dev/rdsk/<i>partition</i></pre> <p>Where: <i>partition</i> is the name of the partition (for example. d8s1)</p>
5	<p>Change the line:</p> <pre>ACS_INDEX_DATAFILE2=</pre> <p>to</p> <pre>ACS_INDEX_DATAFILE2=/dev/rdsk/<i>partition</i></pre> <p>Where: <i>partition</i> is the name of the partition (for example. d8s2)</p>
6	<p>Check the device files for the new partitions are readable and writable by the oracle user prior to commencing/continuing the installation.</p> <p>Example command: <code>chmod ugo+rw /dev/rdsk/d8s*</code></p>

Example acs_devices.sh file

This is an example acs_devices.sh file.

```
#!/bin/sh
#
#####
# The following file is the structure required for knowledge of
# raw device utilisation.
#####

#####
# Raw device specification for datafile paths.
#####
ACS_DATA_DATAFILE=/dev/did/rdsk/d14s0
ACS_INDEX_DATAFILE1=/dev/did/rdsk/d14s1
ACS_INDEX_DATAFILE2=/dev/did/rdsk/d14s2

export ACS_DATA_DATAFILE ACS_INDEX_DATAFILE1 ACS_INDEX_DATAFILE2
#####
```

Checking the Installation

Introduction

Refer to these checklists to ensure that ACS has installed correctly.

The end of the package installation process specifies a script designed to check the installation just performed. They must be run from the command line.

Checklist for SMS

Follow the steps in this checklist to ensure ACS has been installed on an SMS machine correctly.

Step	Action
1	Log in to SMS machine as root.
2	Check the following directory structure exists with subdirectories: <ul style="list-style-type: none"> • /IN/service_packages/ACS • /IN/html/Acs_Service
3	Check that directories contain subdirectories and that all are owned by: acs_oper user (group oracle)
4	Log into the system as acs_oper. Note: This step is to check that the acs_oper user is valid.
5	Enter <code>sqlplus /</code> No password is required. Note: This step is to check that the acs_oper user has valid access to the database.
6	Check the entries of the /etc/inittab file. Inittab Entries Reserved for ACS on SMS: <ol style="list-style-type: none"> acs0 /IN/service_packages/ACS/bin/acsCompilerDaemonStartup.sh (runs acsCompilerDaemon) acs1

Step	Action
	<code>/IN/service_packages/ACS/bin/acsStatisticsDBInserterStartup.sh</code> (runs <code>acsStatisticsDBInserter</code>)
c.	<code>acs2</code> <code>/IN/service_packages/ACS/bin/acsProfileCompilerStartup.sh</code> (runs <code>acsProfileCompiler</code>)
7	Check that the processes listed in the process lists are running on the relevant machine. For a list of the processes which should be running, see <i>Process list for SMS</i> (on page 200).

Checklist for SLC

Follow the steps in this checklist to ensure ACS has been installed on an SLC machine correctly.

Step	Action
1	Log in to SLC machine as root.
2	Check the following directory structure exists with subdirectories: <ul style="list-style-type: none"> <code>/IN/service_packages/ACS</code>
3	Check the directory contains subdirectories and that all are owned by: <code>acs_oper</code> user (group <code>oracle</code>)
4	Log into the system as <code>acs_oper</code> . Note: This step is to check that the <code>acs_oper</code> user is valid.
5	Enter <code>sqlplus /</code> No password is required. Note: This step is to check that the <code>acs_oper</code> user has valid access to the database.
6	Check the entries of the <code>/etc/inittab</code> file. Inittab Entries Reserved for ACS on SLC: 1 <code>acs3 /IN/service_packages/ACS/bin/acsStatsMasterStartup.sh</code> (runs <code>acsStatsMaster</code>)
7	Check that the processes listed in the process lists are running on the relevant machine. For a list of the processes which should be running, see <i>Process list for SLC</i> (on page 200).

Process list for SMS

If the application is running correctly, the following processes should be running on each SMS:

- Started from the inittab:
 - `acsCompilerDaemon`
 - `acsStatisticsDBInserter`
 - `acsProfileCompiler`

Process list for SLC

If the application is running correctly, the following processes should be running on each SLC:

- Started from the inittab:
 - `acsStatsMaster`
- Started during SLEE startup:

- slee_acs

System Manifest

Introduction

Advanced Control Services (ACS) consists of several software executables and directories.

SMS Packages

The ACS application on the SMS contains the following directory structure in the directory `/IN/service_packages/ACS`.

Directory	File	Description
/bin	This directory contains run-time service executables and shell scripts.	
	acsCompilerDaemonStartup.sh	Start up script.
	acsStatisticsDBInserterStartup.sh	Start up script.
	acsProfileCompilerStartup.sh	Start up script.
	acsLogCleanerStartup.sh	Start up script.
	acsDbCleanup.sh	Start up script.
	acsAddCallPlan	
	acsAddCustomer	
	acsAddGeography	
	acsAddServiceNumber	
	acsDecompile	
	acsMonitorCompiler	
	acsProfile	
	acsScheduleCallPlan	
	acsSetupAnnouncement	
/db	This directory contains install-time database scripts.	
/etc	This directory contains run-time configuration files.	
/etc/inittab	This directory contains background processes.	
	acsCompilerDaemon	Background process.
	acsStatisticsDBInserter	Background process.
	acsProfileCompiler	Background process.
/lib	This directory contains run-time shared libraries and install-time shell scripts.	
/tmp	This directory contains run-time and install-time log files.	
	acsCompilerDaemon.log	Error log file.
	acsStatisticsDBInserter.log	Error log file.
	acsProfileCompiler.log	Error log file.
	acsLogCleaner.log	Error log file.
	acsDbCleanup.sh.log	Error log file.
/tmp/archive	This directory contains archived log files.	

SLC Packages

The ACS application on the SLC will have the following directory structure in the directory `/IN/service_packages/ACS`.

Directory	Directory	Files	Description
/bin	This directory contains run-time service executables and shell scripts.		
		<code>acsStatsMasterStartup.sh</code>	Start up script.
		<code>acsDecompile</code>	
		<code>acsLogCleanerStartup.sh</code>	
		<code>acsProfile</code>	
		<code>acsStatsLocalSLEE</code>	
		<code>acsSLSStartup.sh</code>	
		<code>cmnPushFilesStartup.sh</code>	
		<code>pinLogFileCleanup.sh</code>	
		<code>acsTriggerIF</code>	
	<code>acsTriggerIF.sh</code>		
/db	This directory contains install-time database scripts.		
/etc	This directory contains run-time configuration files.		
/etc/inittab	This directory contains background processes.		
		<code>acsStatsMaster</code>	Background process.
/install	This directory contains install-time scripts for optional SLEE rc.d auto-start.		
/lib	This directory contains run-time shared libraries and install-time shell scripts.		
/tmp	This directory contains run-time and install-time log files.		
		<code>acsStatsMaster.log</code>	Error log file.
/tmp/archive	This directory contains archived log files.		

Post-Installation Procedures

Overview

Purpose

This chapter provides the operating procedures for the Advanced Control Services (ACS) application. These procedures are normally performed once, after the installation and configuration of the system.

In this chapter

This chapter contains the following topics.

Using Announcements	203
ACS Global Control Plans	204

Using Announcements

Introduction

When ACS is installed, the announcements required by the ACS Management control plan are inserted into the database. These announcements have been assigned a Virtual Announcement ID, but do not have an actual Resource Name and ID assigned to them.

To use the ACS Management control plan the system administrator must arrange to have the required announcements recorded on the IP that is to be used, and then enter into the system the language that the announcement was recorded in and the resource name and ID of the location of each announcement.

Each Announcement may be recorded in several languages, it is important that the Virtual Announcement ID is the same for each recording of the announcement, and the system entries differ only by the language, resource name and resource ID.

Note

These announcement mappings are not installed automatically because in most cases, the required values are customer specific.

If you wish to configure these values you can enter them manually with the ACS announcement screens or you may run the provided `/IN/service_packages/ACS/db/install/install_acs/acs_language_mappings.sh` configuration script as `acs_oper`.

Originating Announcements

Here is a list of announcements used by the ACS Management control plan.

- activate date prompt
- activate date reprompt
- Control Plan activation failed
- collect Control Plan ID prompt

- collect Control Plan ID reprompt
- collect CLI prompt
- collect CLI reprompt
- collect follow me number prompt
- collect follow me number reprompt
- collect SN prompt
- collect SN reprompt
- collect switch node exit number prompt
- collect switch node exit number reprompt
- collect switch node number prompt
- collect switch node number reprompt
- collected play customer message ID not allowed
- follow me number not cancelled
- follow me number not updated
- load profile failed
- load profile prompt
- load profile reprompt
- main menu announcement
- New PIN Prompt
- New PIN reprompt
- PIN entry failed
- PIN entry prompt
- PIN entry reprompt
- PIN not updated
- record customer message prompt
- record customer message reprompt
- recorded customer message not updated
- switch node CLI branch 1
- switch node CLI branch 2
- switch node not updated
- switch node SN branch 1
- switch node SN branch 2

ACS Global Control Plans

About Global Control Plans

Global control plans are an optional feature that enable the telco to apply global call-screening to calls for all customers before the customer's control plans are applied. Global control plans are automatically assigned to the default customer, and therefore they are always owned by the telco.

Global control plans are associated with a specific service entry, so that they apply only to control plans of a selected type. Service entries are defined in the `acs.conf` configuration file for the Oracle Communications Convergent Charging Controller application. You specify whether a control plan is global when you save the control plan by giving it a name that corresponds to the service to which it applies.

For more information on using global control plans, see *CPE User's Guide*.

Time Zones

Introduction

The screens in the Oracle Communications Convergent Charging Controller user interface (UI) show time values in the local time zone. You specify the time zone in the TZ application property in the **sms.jnlp** file, located in the **/IN/html** directory. For remote SMS users in other time zones, it is possible to have separate **sms.jnlp** files to specify their time zones.

For users who access ACS directly it is possible to add the TZ application property to the **acs.jnlp** file located in the **/IN/html** directory, and thus display time values in the ACS UI in the desired time zone.

Description

A list of time zones supported by Java is shown in the following table.

Offset :	Timezone ID :	Offset in ms	Daylight Time?
GMT-11:00	Pacific/Niue	-39600000	false
GMT-11:00	Pacific/Apia	-39600000	false
GMT-11:00	MIT	-39600000	false
GMT-11:00	Pacific/Pago_Pago	-39600000	false
GMT-10:00	Pacific/Tahiti	-36000000	false
GMT-10:00	Pacific/Fakaofu	-36000000	false
HST	Pacific/Honolulu	-36000000	false
HST	HST	-36000000	false
GMT-10:00	America/Adak	-36000000	true
GMT-10:00	Pacific/Rarotonga	-36000000	false
GMT-09:30	Pacific/Marquesas	-34200000	false
GMT-09:00	Pacific/Gambier	-32400000	false
AKST	America/Anchorage	-32400000	true
AKST	AST	-32400000	true
GMT-08:00	Pacific/Pitcairn	-28800000	false
GMT-08:00	America/Vancouver	-28800000	true
GMT-08:00	America/Tijuana	-28800000	true
PST	America/Los_Angeles	-28800000	true
PST	PST	-28800000	true
GMT-07:00	America/Dawson_Creek	-25200000	false
MST	America/Phoenix	-25200000	false
MST	PNT	-25200000	false
GMT-07:00	America/Edmonton	-25200000	true
GMT-07:00	America/Mazatlan	-25200000	true
MST	America/Denver	-25200000	true
MST	MST	-25200000	true
GMT-06:00	America/Belize	-21600000	false

Offset :	Timezone ID :	Offset in ms	Daylight Time?
GMT-06:00	America/Regina	-21600000	false
GMT-06:00	Pacific/Galapagos	-21600000	false
GMT-06:00	America/Guatemala	-21600000	false
GMT-06:00	America/Tegucigalpa	-21600000	false
GMT-06:00	America/El_Salvador	-21600000	false
GMT-06:00	America/Costa_Rica	-21600000	false
GMT-06:00	America/Winnipeg	-21600000	true
GMT-06:00	Pacific/Easter	-21600000	true
GMT-06:00	America/Mexico_City	-21600000	true
CST	America/Chicago	-21600000	true
CST	CST	-21600000	true
GMT-05:00	America/Porto_Acre	-18000000	false
GMT-05:00	America/Bogota	-18000000	false
GMT-05:00	America/Guayaquil	-18000000	false
GMT-05:00	America/Jamaica	-18000000	false
GMT-05:00	America/Cayman	-18000000	false
GMT-06:00	America/Managua	-21600000	false
GMT-05:00	America/Panama	-18000000	false
GMT-05:00	America/Lima	-18000000	false
EST	America/Indianapolis	-18000000	false
EST	IET	-18000000	false
GMT-05:00	America/Nassau	-18000000	true
GMT-05:00	America/Montreal	-18000000	true
GMT-05:00	America/Havana	-18000000	true
GMT-05:00	America/Port-au-Prince	-18000000	false
GMT-05:00	America/Grand_Turk	-18000000	true
EST	America/New_York	-18000000	true
EST	EST	-18000000	true
GMT-04:00	America/Antigua	-14400000	false
GMT-04:00	America/Anguilla	-14400000	false
GMT-04:00	America/Curacao	-14400000	false
GMT-04:00	America/Aruba	-14400000	false
GMT-04:00	America/Barbados	-14400000	false
GMT-04:00	America/La_Paz	-14400000	false
GMT-04:00	America/Manaus	-14400000	false
GMT-04:00	America/Dominica	-14400000	false
GMT-04:00	America/Santo_Domingo	-14400000	false
GMT-04:00	America/Grenada	-14400000	false
GMT-04:00	America/Guadeloupe	-14400000	false
GMT-04:00	America/Guyana	-14400000	false
GMT-04:00	America/St_Kitts	-14400000	false
GMT-04:00	America/St_Lucia	-14400000	false
GMT-04:00	America/Martinique	-14400000	false

Offset :	Timezone ID :	Offset in ms	Daylight Time?
GMT-04:00	America/Montserrat	-14400000	false
GMT-04:00	America/Puerto_Rico	-14400000	false
GMT-04:00	PRT	-14400000	false
GMT-04:00	America/Port_of_Spain	-14400000	false
GMT-04:00	America/St_Vincent	-14400000	false
GMT-04:00	America/Tortola	-14400000	false
GMT-04:00	America/St_Thomas	-14400000	false
GMT-04:00	America/Caracas	-14400000	false
GMT-04:00	Antarctica/Palmer	-14400000	true
GMT-04:00	Atlantic/Bermuda	-14400000	true
GMT-04:00	America/Cuiaba	-14400000	true
AST	America/Halifax	-14400000	true
GMT-04:00	Atlantic/Stanley	-14400000	true
GMT-04:00	America/Thule	-14400000	true
GMT-04:00	America/Asuncion	-14400000	true
GMT-04:00	America/Santiago	-14400000	true
NST	America/St_Johns	-12600000	true
NST	CNT	-12600000	true
GMT-03:00	America/Fortaleza	-10800000	true
GMT-03:00	America/Cayenne	-10800000	false
GMT-03:00	America/Paramaribo	-10800000	false
GMT-03:00	America/Montevideo	-10800000	false
GMT-03:00	America/Buenos_Aires	-10800000	false
GMT-03:00	AGT	-10800000	false
GMT-03:00	America/Godthab	-10800000	true
GMT-03:00	America/Miquelon	-10800000	true
GMT-03:00	America/Sao_Paulo	-10800000	true
GMT-03:00	BET	-10800000	true
GMT-02:00	America/Noronha	-7200000	false
GMT-02:00	Atlantic/South_Georgia	-7200000	false
GMT-01:00	Atlantic/Jan_Mayen	-3600000	false
GMT-01:00	Atlantic/Cape_Verde	-3600000	false
GMT-01:00	America/Scoresbysund	-3600000	true
GMT-01:00	Atlantic/Azores	-3600000	true
GMT+00:00	Africa/Ouagadougou	0	false
GMT+00:00	Africa/Abidjan	0	false
GMT+00:00	Africa/Accra	0	false
GMT+00:00	Africa/Banjul	0	false
GMT+00:00	Africa/Conakry	0	false
GMT+00:00	Africa/Bissau	0	false
GMT+00:00	Atlantic/Reykjavik	0	false
GMT+00:00	Africa/Monrovia	0	false
GMT	Africa/Casablanca	0	false

Offset :	Timezone ID :	Offset in ms	Daylight Time?
GMT+00:00	Africa/Timbuktu	0	false
GMT+00:00	Africa/Nouakchott	0	false
GMT+00:00	Atlantic/St_Helena	0	false
GMT+00:00	Africa/Freetown	0	false
GMT+00:00	Africa/Dakar	0	false
GMT+00:00	Africa/Sao_Tome	0	false
GMT+00:00	Africa/Lome	0	false
GMT	GMT	0	false
GMT+00:00	UTC	0	false
GMT+00:00	Atlantic/Faeroe	0	true
GMT+00:00	Atlantic/Canary	0	true
GMT+00:00	Europe/Dublin	0	true
GMT+00:00	Europe/Lisbon	0	true
GMT+00:00	Europe/London	0	true
GMT+00:00	WET	0	true
GMT+01:00	Africa/Luanda	3600000	false
GMT+01:00	Africa/Porto-Novo	3600000	false
GMT+01:00	Africa/Bangui	3600000	false
GMT+01:00	Africa/Kinshasa	3600000	false
GMT+01:00	Africa/Douala	3600000	false
GMT+01:00	Africa/Libreville	3600000	false
GMT+01:00	Africa/Malabo	3600000	false
GMT+01:00	Africa/Niamey	3600000	false
GMT+01:00	Africa/Lagos	3600000	false
GMT+01:00	Africa/Ndjamena	3600000	false
GMT+01:00	Africa/Tunis	3600000	false
GMT+01:00	Africa/Algiers	3600000	false
GMT+01:00	Europe/Andorra	3600000	true
GMT+01:00	Europe/Tirane	3600000	true
GMT+01:00	Europe/Vienna	3600000	true
GMT+01:00	Europe/Brussels	3600000	true
GMT+01:00	Europe/Zurich	3600000	true
GMT+01:00	Europe/Prague	3600000	true
GMT+01:00	Europe/Berlin	3600000	true
GMT+01:00	Europe/Copenhagen	3600000	true
GMT+01:00	Europe/Madrid	3600000	true
GMT+01:00	Europe/Gibraltar	3600000	true
GMT+01:00	Europe/Budapest	3600000	true
GMT+01:00	Europe/Rome	3600000	true
GMT+01:00	Europe/Vaduz	3600000	true
GMT+01:00	Europe/Luxembourg	3600000	true
GMT+02:00	Africa/Tripoli	7200000	false
GMT+01:00	Europe/Monaco	3600000	true

Offset :	Timezone ID :	Offset in ms	Daylight Time?
GMT+01:00	Europe/Malta	3600000	true
GMT+01:00	Africa/Windhoek	3600000	true
GMT+01:00	Europe/Amsterdam	3600000	true
GMT+01:00	Europe/Oslo	3600000	true
GMT+01:00	Europe/Warsaw	3600000	true
GMT+01:00	Europe/Stockholm	3600000	true
GMT+01:00	Europe/Belgrade	3600000	true
CET	Europe/Paris	3600000	true
CET	ECT	3600000	true
GMT+02:00	Africa/Bujumbura	7200000	false
GMT+02:00	Africa/Gaborone	7200000	false
GMT+02:00	Africa/Lubumbashi	7200000	false
GMT+02:00	Africa/Maseru	7200000	false
GMT+02:00	Africa/Blantyre	7200000	false
GMT+02:00	Africa/Maputo	7200000	false
GMT+02:00	Africa/Kigali	7200000	false
GMT+03:00	Africa/Khartoum	10800000	false
GMT+02:00	Africa/Mbabane	7200000	false
GMT+02:00	Africa/Lusaka	7200000	false
GMT+02:00	Africa/Harare	7200000	false
GMT+02:00	CAT	7200000	false
GMT+02:00	Africa/Johannesburg	7200000	false
GMT+02:00	Europe/Sofia	7200000	true
GMT+02:00	Europe/Minsk	7200000	true
GMT+02:00	Asia/Nicosia	7200000	true
GMT+02:00	Europe/Tallinn	7200000	false
GMT+02:00	Africa/Cairo	7200000	true
GMT+02:00	ART	7200000	true
GMT+02:00	Europe/Helsinki	7200000	true
GMT+02:00	Europe/Athens	7200000	true
IST	Asia/Jerusalem	7200000	true
GMT+02:00	Asia/Amman	7200000	true
GMT+02:00	Asia/Beirut	7200000	true
GMT+02:00	Europe/Vilnius	7200000	true
GMT+02:00	Europe/Riga	7200000	false
GMT+02:00	Europe/Chisinau	7200000	true
EET	Europe/Bucharest	7200000	true
GMT+02:00	Europe/Kaliningrad	7200000	true
GMT+02:00	Asia/Damascus	7200000	true
GMT+02:00	Europe/Kiev	7200000	true
GMT+02:00	Europe/Istanbul	7200000	true
GMT+02:00	EET	7200000	true
GMT+03:00	Asia/Bahrain	10800000	false

Offset :	Timezone ID :	Offset in ms	Daylight Time?
GMT+03:00	Africa/Djibouti	10800000	false
GMT+03:00	Africa/Asmera	10800000	false
GMT+03:00	Africa/Addis_Ababa	10800000	false
GMT+03:00	EAT	10800000	false
GMT+03:00	Africa/Nairobi	10800000	false
GMT+03:00	Indian/Comoro	10800000	false
GMT+03:00	Asia/Kuwait	10800000	false
GMT+03:00	Indian/Antananarivo	10800000	false
GMT+03:00	Asia/Qatar	10800000	false
GMT+03:00	Africa/Mogadishu	10800000	false
GMT+03:00	Africa/Dar_es_Salaam	10800000	false
GMT+03:00	Africa/Kampala	10800000	false
GMT+03:00	Asia/Aden	10800000	false
GMT+03:00	Indian/Mayotte	10800000	false
GMT+03:00	Asia/Riyadh	10800000	false
GMT+03:00	Asia/Baghdad	10800000	true
GMT+02:00	Europe/Simferopol	7200000	true
GMT+03:00	Europe/Moscow	10800000	true
GMT+03:30	Asia/Tehran	12600000	true
GMT+03:30	MET	12600000	true
GMT+04:00	Asia/Dubai	14400000	false
GMT+04:00	Indian/Mauritius	14400000	false
GMT+04:00	Asia/Muscat	14400000	false
GMT+04:00	Indian/Reunion	14400000	false
GMT+04:00	Indian/Mahe	14400000	false
GMT+04:00	Asia/Yerevan	14400000	true
GMT+04:00	NET	14400000	true
GMT+04:00	Asia/Baku	14400000	true
GMT+04:00	Asia/Aqtau	14400000	true
GMT+04:00	Europe/Samara	14400000	true
GMT+04:30	Asia/Kabul	16200000	false
GMT+05:00	Indian/Kerguelen	18000000	false
GMT+04:00	Asia/Tbilisi	14400000	true
GMT+05:00	Indian/Chagos	18000000	false
GMT+05:00	Indian/Maldives	18000000	false
GMT+05:00	Asia/Dushanbe	18000000	false
GMT+05:00	Asia/Ashkhabad	18000000	false
GMT+05:00	Asia/Tashkent	18000000	false
GMT+05:00	Asia/Karachi	18000000	false
GMT+05:00	PLT	18000000	false
GMT+05:00	Asia/Bishkek	18000000	true
GMT+05:00	Asia/Aqtobe	18000000	true
GMT+05:00	Asia/Yekaterinburg	18000000	true

Offset :	Timezone ID :	Offset in ms	Daylight Time?
GMT+05:30	Asia/Calcutta	19800000	false
GMT+05:30	IST	19800000	false
GMT+05:45	Asia/Katmandu	20700000	false
GMT+06:00	Antarctica/Mawson	21600000	false
GMT+06:00	Asia/Thimbu	21600000	false
GMT+06:00	Asia/Colombo	21600000	false
GMT+06:00	Asia/Dacca	21600000	false
GMT+06:00	BST	21600000	false
GMT+06:00	Asia/Almaty	21600000	true
GMT+06:00	Asia/Novosibirsk	21600000	true
GMT+06:30	Indian/Cocos	23400000	false
GMT+06:30	Asia/Rangoon	23400000	false
GMT+07:00	Indian/Christmas	25200000	false
GMT+07:00	Asia/Jakarta	25200000	false
GMT+07:00	Asia/Phnom_Penh	25200000	false
GMT+07:00	Asia/Vientiane	25200000	false
GMT+07:00	Asia/Saigon	25200000	false
GMT+07:00	VST	25200000	false
GMT+07:00	Asia/Bangkok	25200000	false
GMT+07:00	Asia/Krasnoyarsk	25200000	true
GMT+08:00	Antarctica/Casey	28800000	false
GMT+08:00	Australia/Perth	28800000	false
GMT+08:00	Asia/Brunei	28800000	false
GMT+08:00	Asia/Hong_Kong	28800000	false
GMT+08:00	Asia/Ujung_Pandang	28800000	false
GMT+08:00	Asia/Macao	28800000	false
GMT+08:00	Asia/Kuala_Lumpur	28800000	false
GMT+08:00	Asia/Manila	28800000	false
GMT+08:00	Asia/Singapore	28800000	false
GMT+08:00	Asia/Taipei	28800000	false
CST	Asia/Shanghai	28800000	false
CST	CTT	28800000	false
GMT+08:00	Asia/Ulan_Bator	28800000	true
GMT+08:00	Asia/Irkutsk	28800000	true
GMT+09:00	Asia/Jayapura	32400000	false
GMT+09:00	Asia/Pyongyang	32400000	false
GMT+09:00	Asia/Seoul	32400000	false
GMT+09:00	Pacific/Palau	32400000	false
JST	Asia/Tokyo	32400000	false
JST	JST	32400000	false
GMT+09:00	Asia/Yakutsk	32400000	true
GMT+09:30	Australia/Darwin	34200000	false
GMT+09:30	ACT	34200000	false

Offset :	Timezone ID :	Offset in ms	Daylight Time?
GMT+09:30	Australia/Adelaide	34200000	true
GMT+09:30	Australia/Broken_Hill	34200000	true
GMT+10:00	Australia/Hobart	36000000	true
GMT+10:00	Antarctica/DumontDUrville?	36000000	false
GMT+10:00	Pacific/Truk	36000000	false
GMT+10:00	Pacific/Guam	36000000	false
GMT+10:00	Pacific/Saipan	36000000	false
GMT+10:00	Pacific/Port_Moresby	36000000	false
GMT+10:00	Australia/Brisbane	36000000	false
GMT+10:00	Asia/Vladivostok	36000000	true
GMT+10:00	Australia/Sydney	36000000	true
GMT+10:00	AET	36000000	true
GMT+10:30	Australia/Lord_Howe	37800000	true
GMT+11:00	Pacific/Ponape	39600000	false
GMT+11:00	Pacific/Efate	39600000	false
GMT+11:00	Pacific/Guadalcanal	39600000	false
GMT+11:00	SST	39600000	false
GMT+11:00	Pacific/Noumea	39600000	false
GMT+11:00	Asia/Magadan	39600000	true
GMT+11:30	Pacific/Norfolk	41400000	false
GMT+11:00	Pacific/Kosrae	39600000	false
GMT+12:00	Pacific/Tarawa	43200000	false
GMT+12:00	Pacific/Majuro	43200000	false
GMT+12:00	Pacific/Nauru	43200000	false
GMT+12:00	Pacific/Funafuti	43200000	false
GMT+12:00	Pacific/Wake	43200000	false
GMT+12:00	Pacific/Wallis	43200000	false
GMT+12:00	Pacific/Fiji	43200000	true
GMT+12:00	Antarctica/McMurdo?	43200000	true
GMT+12:00	Asia/Kamchatka	43200000	true
GMT+12:00	Pacific/Auckland	43200000	true
GMT+12:00	NST	43200000	true
GMT+12:45	Pacific/Chatham	45900000	true
GMT+13:00	Pacific/Enderbury	46800000	false
GMT+13:00	Pacific/Tongatapu	46800000	true
GMT+12:00	Asia/Anadyr	43200000	true
GMT+14:00	Pacific/Kiritimati	50400000	false

ASCII Codes

Description

This table shows the ASCII code values.

Decimal	Octal	Hex	Binary	Value	
000	000	00	00000000	NUL	(Null char.)
001	001	01	00000001	SOH	(Start of Header)
002	002	02	00000010	STX	(Start of Text)
003	003	03	00000011	ETX	(End of Text)
004	004	04	00000100	EOT	(End of Transmission)
005	005	05	00000101	ENQ	(Enquiry)
006	006	06	00000110	ACK	(Acknowledgment)
007	007	07	00000111	BEL	(Bell)
008	010	08	00001000	BS	(Backspace)
009	011	09	00001001	HT	(Horizontal Tab)
010	012	0A	00001010	LF	(Line Feed)
011	013	0B	00001011	VT	(Vertical Tab)
012	014	0C	00001100	FF	(Form Feed)
013	015	0D	00001101	CR	(Carriage Return)
014	016	0E	00001110	SO	(Shift Out)
015	017	0F	00001111	SI	(Shift In)
016	020	10	00010000	DLE	(Data Link Escape)
017	021	11	00010001	DC1	(XON) (Device Control 1)
018	022	12	00010010	DC2	(Device Control 2)
019	023	13	00010011	DC3	(XOFF)(Device Control 3)
020	024	14	00010100	DC4	(Device Control 4)
021	025	15	00010101	NAK	(Negative Acknowledgment)
022	026	16	00010110	SYN	(Synchronous Idle)
023	027	17	00010111	ETB	(End of Trans. Block)
024	030	18	00011000	CAN	(Cancel)
025	031	19	00011001	EM	(End of Medium)
026	032	1A	00011010	SUB	(Substitute)
027	033	1B	00011011	ESC	(Escape)
028	034	1C	00011100	FS	(File Separator)
029	035	1D	00011101	GS	(Group Separator)
030	036	1E	00011110	RS	(Request to Send) (Record Separator)
031	037	1F	00011111	US	(Unit Separator)
032	040	20	00100000	SP	(Space)

Decimal	Octal	Hex	Binary	Value	
000	000	00	00000000	NUL	(Null char.)
033	041	21	00100001	!	
034	042	22	00100010	"	
035	043	23	00100011	#	
036	044	24	00100100	\$	
037	045	25	00100101	%	
038	046	26	00100110	&	
039	047	27	00100111	'	
040	050	28	00101000	(
041	051	29	00101001)	
042	052	2A	00101010	*	
043	053	2B	00101011	+	
044	054	2C	00101100	,	
045	055	2D	00101101	-	
046	056	2E	00101110	.	
047	057	2F	00101111	/	
048	060	30	00110000	0	
049	061	31	00110001	1	
050	062	32	00110010	2	
051	063	33	00110011	3	
052	064	34	00110100	4	
053	065	35	00110101	5	
054	066	36	00110110	6	
055	067	37	00110111	7	
056	070	38	00111000	8	
057	071	39	00111001	9	
058	072	3A	00111010	:	
059	073	3B	00111011	;	
060	074	3C	00111100	<	
061	075	3D	00111101	=	
062	076	3E	00111110	>	
063	077	3F	00111111	?	
064	100	40	01000000	@	
065	101	41	01000001	A	
066	102	42	01000010	B	
067	103	43	01000011	C	
068	104	44	01000100	D	
069	105	45	01000101	E	
070	106	46	01000110	F	
071	107	47	01000111	G	
072	110	48	01001000	H	
073	111	49	01001001	I	

Decimal	Octal	Hex	Binary	Value	
000	000	00	00000000	NUL	(Null char.)
074	112	4A	01001010	J	
075	113	4B	01001011	K	
076	114	4C	01001100	L	
077	115	4D	01001101	M	
078	116	4E	01001110	N	
079	117	4F	01001111	O	
080	120	50	01010000	P	
081	121	51	01010001	Q	
082	122	52	01010010	R	
083	123	53	01010011	S	
084	124	54	01010100	T	
085	125	55	01010101	U	
086	126	56	01010110	V	
087	127	57	01010111	W	
088	130	58	01011000	X	
089	131	59	01011001	Y	
090	132	5A	01011010	Z	
091	133	5B	01011011	[
092	134	5C	01011100	\	
093	135	5D	01011101]	
094	136	5E	01011110	^	
095	137	5F	01011111	_	
096	140	60	01100000	`	
097	141	61	01100001	a	
098	142	62	01100010	b	
099	143	63	01100011	c	
100	144	64	01100100	d	
101	145	65	01100101	e	
102	146	66	01100110	f	
103	147	67	01100111	g	
104	150	68	01101000	h	
105	151	69	01101001	i	
106	152	6A	01101010	j	
107	153	6B	01101011	k	
108	154	6C	01101100	l	
109	155	6D	01101101	m	
110	156	6E	01101110	n	
111	157	6F	01101111	o	
112	160	70	01110000	p	
113	161	71	01110001	q	
114	162	72	01110010	r	

Decimal	Octal	Hex	Binary	Value	
000	000	00	00000000	NUL	(Null char.)
115	163	73	01110011	s	
116	164	74	01110100	t	
117	165	75	01110101	u	
118	166	76	01110110	v	
119	167	77	01110111	w	
120	170	78	01111000	x	
121	171	79	01111001	y	
122	172	7A	01111010	z	
123	173	7B	01111011	{	
124	174	7C	01111100		
125	175	7D	01111101	}	
126	176	7E	01111110	~	
127	177	7F	01111111	DEL	

Glossary of Terms

AAA

Authentication, Authorization, and Accounting. Specified in Diameter RFC 3588.

AC

Application Context. A parameter in a TCAP message which indicates what protocol is conveyed. May indicate, for example, MAP, CAMEL, or INAP. Also usually specifies the particular version of the conveyed protocol, for example, which CAMEL Phase.

ACS

Advanced Control Services configuration platform.

ANI

Automatic Number Identification - Term used in the USA by long-distance carriers for CLI.

ASN.1

Abstract Syntax Notation One - a formal notation used for describing data transmitted by telecommunications protocols. ASN.1 is a joint ISO/IEC and ITU-T standard.

BCSM

Basic Call State Model - describes the basic processing steps that must be performed by a switch in order to establish and tear down a call.

C7

See SS7.

CAMEL

Customized Applications for Mobile network Enhanced Logic

This is a 3GPP (Third Generation Partnership Project) initiative to extend traditional IN services found in fixed networks into mobile networks. The architecture is similar to that of traditional IN, in that the control functions and switching functions are remote. Unlike the fixed IN environment, in mobile networks the subscriber may roam into another PLMN (Public Land Mobile Network), consequently the controlling function must interact with a switching function in a foreign network. CAMEL specifies the agreed information flows that may be passed between these networks.

CAP

CAMEL Application Part

CC

Country Code. Prefix identifying the country for a numeric international address.

CCR

Credit-Control-Request, used in Diameter by the credit-control client to request credit authorization from the credit-control server.

CCS

- 1) Charging Control Services component.
- 2) Common Channel Signalling. A signalling system used in telephone networks that separates signalling information from user data.

CDR

Call Data Record

Note: The industry standard for CDR is EDR (Event Detail Record).

CID

Call Instance Data

CLI

Calling Line Identification - the telephone number of the caller. Also referred to as ANI.

Connection

Transport level link between two peers, providing for multiple sessions.

Convergent

Also “convergent billing”. Describes the scenario where post-paid and pre-paid calls are handed by the same service platform and the same billing system. Under strict converged billing, post-paid subscribers are essentially treated as “limited credit pre-paid”.

CPE

Control Plan Editor (previously Call Plan Editor) - software used to define the logic and data associated with a call -for example, "if the subscriber calls 0800 *nnnnn* from a phone at location *xxx* then put the call through to *bb bbb bbbb*".

CPU

Central Processing Unit

cron

Unix utility for scheduling tasks.

crontab

File used by cron.

CS1

ETSI INAP Capability Set 1. An ITU standard.

CSV

A Comma-Separated Values file contains the values in a table as a series of ASCII text lines organized so that each column value is separated by a comma from the next column's value and each row starts a new line, for example:

```
Doe, John, 944-7077
Johnson, Mary, 370-3920
Smith, Abigail, 299-3958
(etc.)
```

A CSV file is a way to collect the data from any table so that it can be conveyed as input to another table-oriented application such as a relational database application. Microsoft Excel can read CSV files. A CSV file is sometimes referred to as a flat file.

DAP

Data Access Pack. An extension module for ACS which allows control plans to make asynchronous requests to external systems over various protocols including XML and LDAP.

DB

Database

Diameter

A feature rich AAA protocol. Utilises SCTP and TCP transports.

DLE

Destination Local Exchange

DP

Detection Point

DRA

Destination Routing Address. The parameter in the INAP Connect operation, sent from ACS to the SSP. This is the number the SSP is instructed to connect to.

DTMF

Dual Tone Multi-Frequency - system used by touch tone telephones where one high and one low frequency, or tone, is assigned to each touch tone button on the phone.

ETSI

European Telecommunications Standards Institute

FCI

Furnish Charging Information. An INAP operation sent from ACS to the SSP to control the contents of EDRs produced by the SSP.

FDA

First Delivery Attempt - the delivery of a short message directly to the SME rather than relaying it through the MC.

GPRS

General Packet Radio Service - employed to connect mobile cellular users to PDN (Public Data Network- for example the Internet).

GSM

Global System for Mobile communication.

It is a second generation cellular telecommunication system. Unlike first generation systems, GSM is digital and thus introduced greater enhancements such as security, capacity, quality and the ability to support integrated services.

GT

Global Title.

The GT may be defined in any of the following formats:

- Type 1: String in the form "1,<noa>,<BCD address digits>"
- Type 2: String in the form "2,<trans type><BCD address digits>"
- Type 3: String in the form "3,<trans type>,<num plan>,<BCD address digits>"
- Type 4: String in the form "4,<trans type>,<num plan>,<noa>,<BCD address digits>"

The contents of the Global Title are defined in the Q713 specification, please refer to section 3.4.2.3 for further details on defining Global Title.

GUI

Graphical User Interface

GVNS

Global Virtual Numbering Scheme - When multiple VPNs are in use by a customer, the capability to route calls between these VPNs requires a numbering scheme that uses destination addresses based on a customer id and extension number. These GVNS addresses can then be interpreted to provide inter VPN operation.

HLR

The Home Location Register is a database within the HPLMN (Home Public Land Mobile Network). It provides routing information for MT calls and SMS. It is also responsible for the maintenance of user subscription information. This is distributed to the relevant VLR, or SGSN (Serving GPRS Support Node) through the attach process and mobility management procedures such as Location Area and Routing Area updates.

HPLMN

Home PLMN

HTML

HyperText Markup Language, a small application of SGML used on the World Wide Web.

It defines a very simple class of report-style documents, with section headings, paragraphs, lists, tables, and illustrations, with a few informational and presentational items, and some hypertext and multimedia.

Hunting

A terminating call feature where a subscriber may request a list of alternate destination addresses. If their mobile station is not attached, or does not answer a call, then the service logic should attempt to reach the supplied alternate destinations in sequence.

ICA

InitiateCallAttempt. A CAMEL/INAP operation sent by the SLC to an SSP request that a voice call is started.

IDP

INAP message: Initial DP (Initial Detection Point)

IMSI

International Mobile Subscriber Identifier. A unique identifier allocated to each mobile subscriber in a GSM and UMTS network. It consists of a MCC (Mobile Country Code), a MNC (Mobile Network Code) and a MSIN (Mobile Station Identification Number).

The IMSI is returned by the HLR query (SRI-SM) when doing FDA. This tells the MSC exactly who the subscriber is that the message is to be sent to.

IN

Intelligent Network

INAP

Intelligent Network Application Part - a protocol offering real time communication between IN elements.

Initial DP

Initial Detection Point - INAP Operation. This is the operation that is sent when the switch reaches a trigger detection point.

IP

- 1) Internet Protocol
- 2) Intelligent Peripheral - This is a node in an Intelligent Network containing a Specialized Resource Function (SRF).

IP address

Internet Protocol Address - network address of a card on a computer.

ISDN

Integrated Services Digital Network - set of protocols for connecting ISDN stations.

ISUP

ISDN User Part - part of the SS7 protocol layer and used in the setting up, management, and release of trunks that carry voice and data between calling and called parties.

ITU

International Telecommunication Union

IVR

Interactive Voice Response - systems that provide information in the form of recorded messages over telephone lines in response to user input in the form of spoken words or, more commonly, DTMF signalling.

LAC

Location Area Code. This is an integer value specified as the third level of detail in the location area information. One LAC contains multiple Cell IDs or SAs.

MAP

Mobile Application Part - a protocol which enables real time communication between nodes in a mobile cellular network. A typical usage of the protocol would be for the transfer of location information from the VLR to the HLR.

MC

Message Centre. Also known as SMSC.

MCC

Mobile Country Code. In the location information context, this is padded to three digits with leading zeros. Refer to ITU E.212 ("Land Mobile Numbering Plan") documentation for a list of codes.

Messaging Manager

The Messaging Manager service and the Short Message Service components of Oracle Communications Convergent Charging Controller product. Component acronym is MM (formerly MMX).

MM

Messaging Manager. Formerly MMX, see also *XMS* (on page 227) and *Messaging Manager* (on page 222).

MNC

Mobile Network Code. The part of an international address following the mobile country code (MCC), or at the start of a national format address. This specifies the mobile network code, that is, the operator owning the address. In the location information context, this is padded to two digits with a leading zero. Refer to ITU E.212 ("Land Mobile Numbering Plan") documentation for a list of codes.

MO

Mobile Originated

MS

Mobile Station

MSC

Mobile Switching Centre. Also known as a switch.

MSIN

Mobile Station Identification Number.

MSRN

Mobile Station Roaming Number

MT

Mobile Terminated

MTP

Message Transfer Part (part of the SS7 protocol stack).

NOA

Nature Of Address - a classification to determine in what realm (Local, National or International) a given phone number resides, for the purposes of routing and billing.

NP

Number Portability

NPI

Number Plan Indicator

Octet

Byte - 8 bits.

PACUI

Play Announcement and Collect User Information

PC

Point Code. The Point Code is the address of a switching point.

PIN

Personal Identification Number

PLMN

Public Land Mobile Network

RIMS

Routing Information for Mobile Services. Used to cache HLR lookup information.

Note: Now known as "Messaging Manager Navigator".

SCCP

Signalling Connection Control Part (part of the SS7 protocol stack).

SCCP Address

Is made up of PC + SSN + GT; or PC +SSN; or GT; or GT + PC.

SCF

Service Control Function - this is the application of service logic to control functional entities in providing Intelligent Network services.

SCI

Send Charging Information. An INAP operation sent from ACS to the SSP to control real time charging by the SSP.

SCP

Service Control Point. Also known as SLC.

SCTP

Stream Control Transmission Protocol. A transport-layer protocol analogous to the TCP or User Datagram Protocol (UDP). SCTP provides some similar services as TCP (reliable, in-sequence transport of messages with congestion control) but adds high availability.

Session

Diameter exchange relating to a particular user or subscriber access to a provided service (for example, a telephone call).

SGML

Standard Generalized Markup Language. The international standard for defining descriptions of the structure of different types of electronic document.

SGSN

Serving GPRS Support Node

SK

Service Key

SLC

Service Logic Controller (formerly UAS).

SLEE

Service Logic Execution Environment

SME

Short Message Entity - This is an entity which may send or receive short messages. It may be located in a fixed network, a mobile, or an SMSC.

SMS

Depending on context, can be:

- Service Management System hardware platform
- Short Message Service
- Service Management System platform
- Convergent Charging Controller Service Management System application

SN

Service Number

SQL

Structured Query Language is a database query language.

SRF

Specialized Resource Function – This is a node on an IN which can connect to both the SSP and the SLC and delivers additional special resources into the call, mostly related to voice data, for example play voice announcements or collect DTMF tones from the user. Can be present on an SSP or an Intelligent Peripheral (IP).

SRI

Send Routing Information - This process is used on a GSM network to interrogate the HLR for subscriber routing information.

SS7

A Common Channel Signalling system is used in many modern telecoms networks that provides a suite of protocols which enables circuit and non-circuit related information to be routed about and between networks. The main protocols include MTP, SCCP and ISUP.

SSF

Sub Service Field.

SSL

Secure Sockets Layer protocol

SSN

Subsystem Number. An integer identifying applications on the SCCP layer.

For values, refer to *3GPP TS 23.003*.

SSP

Service Switching Point

Switching Point

Anything that can send and receive C7 messages.

TCAP

Transaction Capabilities Application Part – layer in protocol stack, message protocol.

TCP

Transmission Control Protocol. This is a reliable octet streaming protocol used by the majority of applications on the Internet. It provides a connection-oriented, full-duplex, point to point service between hosts.

Telco

Telecommunications Provider. This is the company that provides the telephone service to customers.

Telecommunications Provider

See Telco.

Termination Number

The final number that a call terminates to. Can be set in control plan nodes such as Attempt Termination and Unconditional Termination for re-routing numbers such as Toll Free or Follow Me numbers.

TLS

Transport Layer Security. Cryptographic protocol used to provide secure communications. Evolved from SSL.

URL

Uniform Resource Locator. A standard way of specifying the location of an object, typically a web page, on the Internet.

VLR

Visitor Location Register - contains all subscriber data required for call handling and mobility management for mobile subscribers currently located in the area controlled by the VLR.

VPN

The Virtual Private Network product is an enhanced services capability enabling private network facilities across a public telephony network.

VWS

Oracle Voucher and Wallet Server (formerly UBE).

WSDL

Web Services Description Language.

XML

eXtensible Markup Language. It is designed to improve the functionality of the Web by providing more flexible and adaptable information identification.

It is called extensible because it is not a fixed format like HTML. XML is a `metalanguage' — a language for describing other languages—which lets you design your own customized markup languages for limitless different types of documents. XML can do this because it's written in SGML.

XMS

Three letter code used to designate some components and path locations used by the Oracle Communications Convergent Charging Controller *Messaging Manager* (on page 222) service and the Short Message Service. The published code is *MM* (on page 222) (formerly *MMX*).

Index

A

- AAA • 217
- About connecting to the database • 177, 183
- About Customizing the ACS UI • 25
- About database connections • 78, 81, 84
- About Defining scfs in acs.jnlp and sms.jnlp • 138
- About Defining ssfs in acs.jnlp and sms.jnlp • 143
- About Global Control Plans • 204
- About Installation and Removal • 197
- About Secure SSL Connection to the Database • 9
- About This Document • vii
- AC • 217
- Accessing ACS • 25
- Accessing ACS directly • 10
- Accessing ACS through SMS • 10
- ACS • 217
- ACS CDR/EDR • 7
- ACS Client Specifications • 193
- ACS Configuration in the eserv.config File • 46
- ACS Global Control Plans • 204
- ACS Packages • 197
- ACS Primary Tags • 5
- ACS Section in eserv.config • 46
- ACS User Privilege Levels • 12
- acs.conf • 73
- acs.conf Example • 158
- ACS_Prefix Service Entry for FCI and NP Configurations • 66
- ACS_ROOT • 22
- acsAddCallPlan • 177, 183
- acsAddCustomer • 179
- acsAddGeography • 180
- acsAddServiceNumber • 181
- acsChassis • 75
- acsChassis AWOL Configuration • 153
- acsChassis EDR Configuration (SLC) • 143
- acsChassis Emergency Numbers (SLC) • 113
- acsChassis INAP Extension Parameters • 114, 128
- acsChassis Normalization Parameters (SLC) • 117
- acsChassis Plug-in Libraries • 77
- acsChassis Plug-ins • 75
- acsChassis SCF Configuration (SLC) • 134
- acsChassis Service Library Configuration (SLC) • 152
- acsChassis Service Normalisation Parameters (SLC) • 153
- acsChassis ServiceEntry Configuration (SLC) • 54, 57, 76, 119, 120, 123, 153, 155, 175
- acsChassis Single Instance Parameters (SLC) • 87
- acsChassis SLEE Event Size Parameter (SLC) • 123, 130
- acsChassis SRF Configuration (SLC) • 78, 131
- acsChassis SSF Configuration (SLC) • 36, 39, 138
- acsChassisActions Configuration • 50
- acsCompilerDaemon • 168
- acsCompilerDaemon (SMS) • 81
- acsDbCleanup Configuration • 61
- acsDbCleanup.sh • 171
- acsDecompile • 182
- acsDumpControlPlan • 177, 183
- acsMonitorCompiler • 184
- acsProfile • 184
- acsProfileCompiler • 84, 171
- acsScheduleCallPlan • 187
- acsSetupAnnouncement • 187
- acsSnCpActAlarms • 169
- acsSnCpActAlarms Parameters in eserv.config • 169
- acsStatisticsDBInserter • 172
- acsStatisticsDBInserter (SMS) • 78
- acsStatsLocal (SLC) • 113
- acsStatsMaster • 173
- acsStatsMaster (SLC) • 85
- acsTriggerIF Configuration • 58
- addChargingInfoToCTR • 87
- addChargingInfoToETC • 87
- addChargingInfoToPA • 87
- AdditionalCheckMOLIPrefix Configuration • 62
- additionalPrefix • 66
- additionalPrefixServiceKeys • 66
- AddMOLIPrefix • 88
- Address • 131, 135, 139
- AddressSources • 55
- alarmCheckInterval • 170
- alarmReason • 170
- alertTimeout • 82
- alternativeCallPlanNamePostfix • 88
- alwaysIncludePartyToCharge • 88
- ANI • 217
- appContext • 137, 142
- armDisconnectAt • 89
- armDisconnectAtp • 89
- armDisconnectLeg1 • 89
- armDisconnectLeg2 • 89
- armLegsSeparately • 90
- ArmTerminateTriggers • 90
- ASCII Codes • 213
- AskCirAttemptElapsedTime • 110
- AskCirCallAddress • 110
- AskCirConnectElapsedTime • 110
- AskCirReleaseCause • 110
- AskCirStopTime • 110
- ASN.1 • 217

- AssumePreArrangedEnd • 90
- atDisconnectMM_Leg1Interrupt • 90
- atDisconnectMM_Leg2Interrupt • 90
- Audience • vii
- AuditChallenge • 84, 90
- Automated ACS Processes (SLC Machine) • 173
- Automated ACS Processes (SMS Machine) • 167
- AWOL Processing • 153
- awolOverrideACRTimeout • 156
- awolReportOnly • 155
- awolReportPeriod • 129, 156
- awolTimeout • 129, 154

B

- Background Processes • 167
- BCSM • 217
- Before You Begin • 74

C

- C7 • 217
- Call Dump Parameters • 109
- Call Information Report Parameters • 109
- Call Processing and Features • 1
- Call Routing Services • 2
- callAnswerTimeFormat • 51
- CallDumpDir • 109
- CallDumpEnabled • 109
- CallDumpMessage • 109
- CallDumpSeconds • 109
- CallDumpSeverity • 109
- CalledPartyBcdToNoaMap • 91
- callEndTimeFormat • 51
- CallInitiationExtensionForIdp • 90
- CallInitiationTimeoutToleranceSeconds • 91
- CallInitiationUseContextInd • 91
- callProcessingAllowedAfterAPartyDisconnect • 92
- callReferenceIDAsHex • 144
- callStartTimeFormat • 52
- CallType • 124
- CAMEL • 217
- CancelChar • 92
- CAP • 217
- CarrierCodeDisposal • 92
- CC • 217
- CCR • 218
- CCS • 218
- CDR • 218
- CdrCacheMaxSize • 144
- CdrClosedDirectory • 144
- CdrCompressCall • 144, 150, 151
- CdrCurrentDirectory • 145
- CdrExtraFields • 145
- CdrFile • 145
- CdrFileAppendCloseTime • 146

- CdrFileAppendPid • 147
- CdrFileMaxAge • 143, 144, 147
- CdrFileMaxSize • 143, 144, 147
- CdrFileUseGMT • 147
- CdrFileUseLocalTime • 148
- CdrLogPIN • 150
- CdrOnAbort • 145, 150
- CdrOnCallCompletion • 150
- CdrOnDisconnect • 145, 150
- cdrOnForcedDisc • 151
- CdrOnHandover • 151
- CdrRemoveFields • 148
- CdrResetOnWriteRELC • 151
- CdrUsecDigits • 151
- ChainCountLimit • 93
- ChassisPlugin • 75, 78, 174
- checkAWOL • 154
- checkAWOLMarginAC • 154
- Checking Kernel Parameters • 194
- Checking the Installation • 199
- Checklist for SLC • 200
- Checklist for SMS • 199
- CheckMOLIPrefix • 63, 88, 93
- checkMOLIPrefixes • 63
- CID • 218
- CLI • 218
- CollectInfoReturnsAll • 93
- commit • 62
- compileErrorAge • 62
- compressAtKb • 83
- compressLevel • 83
- Configuration • 174, 175, 178, 179, 180, 181, 182, 183, 184, 185, 187
- Configuration File Format • 45
- Configuration Files • 22
- Configuring minimumSizeOfConnectSleeEvent Per Service • 123, 130
- Configuring the acs.conf • 22, 73, 168, 172, 173, 174, 175
- Configuring the Environment • 21
- Configuring the eserv.config • 45
- Configuring the numberDataImport Tool • 188, 189, 191
- ConnectCLISource • 126
- Connection • 218
- Context Tag • 116
- Convergent • 218
- Copyright • ii
- CopySpareBits • 93
- countryCodeProfileTag • 64
- countryCodes • 47, 122
- CPE • 218
- CPU • 218
- Creating and Updating Table Lookup Datasets • 189, 190
- Creating the Dataset Input File • 188, 189
- cron • 218

crontab • 218
CS1 • 218
CSV • 219

D

DAP • 219
DB • 219
Default.lang • 23
Default_Acs_Service.hs • 24
Defining acsChassis AWOL configuration • 154
Defining the Help Screen Language • 22, 24
Defining the Screen Language • 22
Defining the Security Levels • 11
deleteTagsAfterTrigger • 58
DenormalisationRule • 120, 157
Description • 1, 205, 213
destAddress • 48
dfcOnIpAbort • 93
Diagram of main components • 3, 143
DialledHashEncoding • 93
DialledStarEncoding • 94
dialogTickInterval • 94
Diameter • 219
DigitsInAnnouncementList • 88
disarmEDPs • 94
DisconnectMidCallJumpBack • 94
DLE • 219
Document Conventions • viii
DP • 219
DRA • 219
DTMF • 219

E

Editing the acs.conf File • 75
Editing the File • 46
edpArmAbandoned • 94
edpArmAnswer • 95
edpArmBusy • 95
edpArmNoAnswer • 95
edpArmRouteSelectFailure • 95
edpSetNoAnswerTimer • 95, 96
edpUseNoAnswerTimer • 95
elapsedTimesFromApplyChargingReport • 152
EmergencyNumber • 113
emptyDralsError • 96
enabled • 48
enableService • 65
enableTermAttemptAuthorizedConnect • 96
Enabling Secure SSL Connection to the Database • 9
Enabling SSL for ACS • 9
encoding • 50
endUnlinkedExits • 42, 84
EntryChar • 96
eserv.config Configuration • 22, 45
eserv.config Files Delivered • 46
ETC_CorrelationIdInIPAddr • 96

ETC_MinCorrelationDigits • 97
ETC_SCF_ID • 97
ETSI • 219
Example • 130
Example 1 • 74, 121
Example 2 • 74, 122
Example 3 • 122
Example 4 • 122
Example ACS Configuration in eserv.config • 67
Example acs.conf • 158
Example acs_devices.sh file • 199
Example Configuration Sections • 74
Example Helpset Language • 24
Example JNLP Application Properties • 42
Example MRC Configuration in eserv.config • 72
Example SCF Configuration • 135, 136, 137
Example Screen Language • 23
Example SSF Configuration • 142
Extension Numbers Example • 90, 116
Extra Statistics • 97, 112
extractCallAnswerTime • 52
extractCallEndTime • 52
extractCallStartTime • 52
extractEdrId • 52
extractEdrTimeZone • 53
Extraction Sources in IDP • 125, 126, 127
Extraction Value Construction • 127
extraStats • 97, 112

F

Failure • 168, 171, 172, 173
fakeAcrCallReleaseAtMaxDuration • 97
FakeAcrCallReleaseAtTcpExpiry • 97
fakeMissingAcrAtDisconnection • 98
FCI • 219
FCI Configuration • 63
fciFlagProfileTag • 64
fciInSeparateMessage • 98
fciInSeparateMessageAllOperations • 98
fciMaximumLength • 99
fciSeparator • 99
FDA • 219
FirstDigitTimeout • 99

G

G Digits • 128
Get Hunting Number Node Configuration • 156, 174
Global and Service Specific Normalization • 118
GlobalProfileMaxAge • 99
GPRS • 220
GSM • 220
GT • 220
GUI • 220
GVNS • 220

H

HLR • 220
How the SRF Configuration Works • 133
HPLMN • 220
HTML • 220
Hunting • 221

I

ICA • 221
ID • 114
IDP • 221
IDPExtTypeCallAnswerTime • 53
IDPExtTypeCallEndTime • 53
IDPExtTypeCallStartTime • 53
IDPExtTypeEDRId • 54
IDPExtTypeEDRTIMEZONE • 54
ignoredTermNumberPrefixes • 66
ignoreNumberPlanForConnectToContinue • 99
Implementing Parameter Changes • 74
IMSI • 221
IN • 221
INAP • 221
inapServiceKey • 59
Initial DP • 221
Installation and Removal Overview • 197
Installing acsSms Packages on a Clustered SMS • 197
InterDigitTimeout • 99
interface • 141
InternalErrorAction • 99
Introduction • 7, 10, 11, 13, 17, 22, 24, 45, 73, 78, 81, 84, 85, 113, 114, 123, 131, 134, 138, 153, 167, 173, 194, 197, 199, 201, 203, 205
IP • 221
IP address • 221
IPProtocolInfo • 100
ISDN • 221
ISUP • 221
ITU • 222
IVR • 222

J

Java Application Properties • 10, 25
jnlp.acs.ACSDefaultCustomerIsPrepaid • 25
jnlp.acs.ACSStartScreenVersion • 26
jnlp.acs.allowCallPlanSchedulingInPast • 26
jnlp.acs.allowRefInCustCombo • 27
jnlp.acs.autoCloseCompileDialog • 27
jnlp.acs.autoCloseCPE • 27
jnlp.acs.connectionsDialog • 28
jnlp.acs.cpeLineDrawingMechanism • 29
jnlp.acs.defaultTelcoManaged • 31
jnlp.acs.issuePCClockWarning • 32
jnlp.acs.MAX_CONTROL_PLANS_DISPLAYED • 33
jnlp.acs.maximiseAcScreens • 33

jnlp.acs.paletteStyle • 34
jnlp.acs.ProfileN • 34
jnlp.acs.requireCustomerReference • 35
jnlp.acs.scfs • 36
jnlp.acs.SDRfastTimeoutDefault • 36
jnlp.acs.showAnnouncementSource • 37
jnlp.acs.showCallPlanCopy • 38
jnlp.acs.showNetwork • 38
jnlp.acs.ssfs • 39
jnlp.acs.suppressedSDRDigits • 39
jnlp.acs.SuppressTagID • 40
jnlp.acs.updateCPReferences • 40
jnlp.acs.useTNForNodeName • 41
jnlp.acs.warnAboutUnfilledExits • 42
jnlp.ccs.UseAnnouncements • 41
jnlp.sms.clusterDatabaseHost • 28
jnlp.sms.database • 29
jnlp.sms.databaseHost • 30
jnlp.sms.databaseID • 30
jnlp.sms.dbPassword • 31
jnlp.sms.dbUser • 31
jnlp.sms.EncryptedSSLConnection • 32
jnlp.sms.host • 32
jnlp.sms.logo • 33
jnlp.sms.port • 34
jnlp.sms.secureConnectionClusterDatabaseHost • 37
jnlp.sms.secureConnectionDatabaseHost • 37
jnlp.sms.sslCipherSuites • 39
jnlp.sms.TZ • 40
jnlp.trace • 40

L

LAC • 222
libacsChassisActions • 78, 174
libacsMacroNodes • 77, 174
libacsService • 175
libname • 127
Location • 168, 169, 171, 172, 173, 179, 180, 181, 182, 184, 185, 187
LocationInfoDestinationSubsystemNumber • 70
LocationInfoGSMScfAddress • 71
LocationInfoGSMScfMapNoa • 71
locationInfoOriginatingSubsystemNumber • 71
locationInfoPollEnabled • 71
LocationInfoRequestTimeout • 72
locationInfoRetrieval Configuration • 70
locationInfoTcapInterfaceName • 72
Logging EDRs • 143
LogicalCPSource • 125

M

MacroNodePluginFile • 75, 77, 174
macroNodes Configuration • 47
MAP • 222
MasterServerLocation • 80
MasterServerPort • 80

masterStatsServer • 86, 87, 113
maxAnnouncementTextBytes • 100
maxBranches • 82
maxCompiledKb • 83
maxNodes • 82
MaxPromptDigits • 100
MC • 222
MCC • 222
Memory • 193
Messaging Manager • 222, 227
Methods • 56
minimumSizeOfConnectSleeEvent • 123
MinZeroTimeRemainingPeriod • 100
MM • 222, 227
MNC • 222
MO • 222
mode • 65
MRC Configuration • 70
MS • 222
MSC • 223
mscAddress • 50
mscAddressForEdr • 50
msgmb • 195
msgtql • 194
MSIN • 223
MSRN • 223
MT • 223
MTP • 223

N

Network • 193
NetworkCPSrc • 125
NI • 137
NOA • 132, 135, 139, 223
NOA and Normal Rules • 117
noActivitySleepTime • 59
NOA-ISUP Type • 129
NOA-MAP Type • 128
NoAnswerTimeout • 100
NoCallPlanAction • 100
NoCallPlanCause • 100
NoCallPlanError • 101
NoDatabaseConnectAction • 101
Node States • 145, 146
NokiaCIR • 110
NormalisationRule • 119
normaliseServiceNumber • 121
normaliseTerminationNumber • 121
Normalization Parameters • 118, 153
NormalUnknownNOA • 118
NormalUseHex • 118
NoServiceAction • 101
NoServiceError • 101
Note • 203
NP • 223
NP Configuration • 64
NPI • 136, 140, 223

Number • 114
Number Matching Node Configuration • 156
Number Normalization and Denormalization • 117
numberDataImport • 188
numberRules • 59
NumberRulesSection • 157

O

Octet • 223
Oracle usr/pwd String • 22, 79
Oracle Variables • 22
oracledatabase • 79, 82, 85
oraclepassword • 79, 81, 85, 86
oracleUserIdPassword • 169
oracleusername • 79, 81, 85, 86
origAddress • 48
OriginalCalledPartyID • 126
Originating Announcements • 203
Other Features • 1
Output • 169, 171, 172, 173, 174
OverrideDefaultIPDigitTimeout • 101
overrideSleeServiceKey • 60
Overriding AWOL Configuration Per Service • 129, 154
Overview • 1, 9, 21, 45, 73, 167, 177, 193, 197, 203
overwriteFci • 102

P

PACUI • 223
Parameter • 134, 152
Parameter Types • 74
Parameters • 79, 81, 85, 86, 87, 113, 114, 124, 138, 139, 143, 154, 156, 157, 158, 168, 169, 171, 172, 173, 194
PC • 136, 140, 223
PendingTNSrc • 126
Period • 80
Permission Levels • 12
PersistantAuthorisationInfo • 102
PIN • 223
PIN Logging Parameters • 108, 150
PINLogEnable • 108
PINLogFail • 108
PINLogMaxAge • 108
PINLogMaxSize • 108
PINLogSuccess • 108
Play Variable Part Announcement Feature
Node Denormalization Rules • 121
Play Variable Part Announcement Node
Configuration • 157, 174
PLMN • 223
Plug-in list • 77
Plug-ins • 168
port • 86, 87, 113
postAnswerBeepTimer • 102

- Post-Installation Procedures • 203
- Pre-installation • 193
- Preparing the System • 194
- Prerequisites • vii
- Procedure • 13, 18, 23, 24
- Process list for SLC • 200
- Process list for SMS • 200
- Profile Date Compare Node Configuration • 158
- ProfileOrder • 152
- Purpose • 168, 169, 171, 172, 173, 174, 175, 177, 179, 180, 181, 182, 183, 184, 187, 188

R

- Raw Devices • 197
- Raw Devices Configuration • 198
- recordSmpStatistics • 102, 111
- RedirectingPartyID • 126
- RegMapFlushPeriod • 157
- RegMapMaxAge • 157
- Related documents • vii
- ReleaseInApplyCharging • 47
- repeatAlarm • 170
- Response Times • 194
- Retries • 80
- RI • 137, 141
- RIMS • 223
- roundDownACRCallDuration • 102
- rrbcsmePrefix • 102

S

- SCCP • 224
- SCCP Address • 224
- SCF • 224
- scfName • 135
- SCI • 224
- sciMaximumLength • 102
- Scope • vii
- SCP • 224
- Screen • 194
- screening • 57
- SCTP • 224
- Security in ACS • 10
- Security Overview • 9
- semKey • 86, 87
- semmni • 195
- semmns • 195
- semmsl • 195
- semopm • 196
- semvmx • 196
- SendCIR • 109
- sendFciWithReleaseCall • 103
- sendIdenticalCliInConnect • 103
- Sequence • 114
- Service Specific Normalization Parameters • 153
- ServiceEntries Configuration • 54, 66
- ServiceEntry • 76

- serviceIndicatorProfileTag • 64
- serviceKeys • 64, 65
- ServiceName • 57, 124
- serviceNumberTerm • 170
- Session • 224
- SessionTimeInformation Configuration • 51
- setCallData • 156
- setCallerLogicalTZFromIncomingGmtOffset • 104
- setCallerNetworkTZFromIncomingGmtOffset • 103
- setCcetOnDisconnectCall • 76
- Setting the ACS Root Directory • 21
- Setting up ACS Security through SMS • 13
- Setting up ACS Security without using SMS • 17
- Setting up the Screens • 25, 138, 143
- SGML • 224
- SGSN • 224
- shmKey • 86, 87
- shmmax • 195
- shmmni • 195
- shmmni • 195
- shmseg • 195
- SK • 224
- SLC • 224
- SLC Packages • 202
- SLEE • 224
- sleeInterfaceName • 60
- sleeServiceKey • 60
- SME • 225
- SMS • 225
- SMS Packages • 201
- smsStatsPeriodCheck • 104
- SN • 225
- source • 57
- sourceSelectionOnHandover • 104
- Specifications • 193
- SQL • 225
- srf • 76, 78
- SRF • 225
- srf Parameter Configuration • 131
- srfName • 131
- SRI • 225
- SS7 • 225
- SSF • 225
- ssf_name • 139
- SSL • 225
- SSN • 136, 141, 225
- SSP • 225
- Standard Profile Block List • 3
- Startup • 168, 169, 171, 172, 173, 174, 175
- Statistics Captured • 102, 110
- Statistics Updated by acsTriggerIF • 61
- statisticsEnabled • 60, 61
- statsAge • 61
- statsReportingLevel • 104

STIServiceKey • 54
Subfield • 115
Switching Point • 226
Syntax • 124
syslogLevel • 105
System Manifest • 201
System Overview • 1

T

TcAbortOnPreArrangedEnd • 106
TCAP • 226
tcapPreEnd • 133
TCP • 226
TCP Network Loading • 143
Telco • 226
Telecommunications Provider • 226
Termination Number • 226
tfnListSize • 76
Time Zones • 40, 106, 205
TLS • 226
Tools and Utilities • 177
traceDebugLevel • 49
Tracing Configuration • 48
triggerTimeOutSecs • 61
TrimFStop • 106
TT • 136, 139
Type • 115
TypeOfIVR • 132
TypeOfSrf • 132
Typographical Conventions • viii
tzDefault • 106, 158

U

URL • 226
UseContinueOperation • 96, 107
UseETC • 131
UseLanguageExtensions • 107
useLeg3ForICA • 142
usePendingTnForCalnCdr • 110
UseReplication • 108
useTzDefault • 158
Using Announcements • 203

V

VLR • 226
VPN • 226
VWS • 226

W

What are the Functions of ACS? • 7
What are the Main Components of ACS? • 3
What is Advanced Control Services? • 1
WSDL • 226

X

XML • 227

XMS • 222, 227

Z

zeroElapsedTimesInCdr • 152