

Oracle Fusion Cloud Applications

**Getting Started with Oracle Digital
Assistant for Fusion Applications**

26B



Oracle Fusion Cloud Applications
Getting Started with Oracle Digital Assistant for Fusion Applications

26B

G51905-01

Copyright © 2011, 2026, Oracle and/or its affiliates.

Author: Subhashini.D, Rebecca Nethala

Contents

Get Help

i

1 Get Started

1

About This Guide

1

Overview

1

Before You Start

1

Where to Find Information About Product-Specific Digital Assistants

2

2 Configure Digital Assistant

5

Overview of Configuring Digital Assistant

5

How the Integration of the Application with Digital Assistant is Secured

6

Access Your Preprovisioned Digital Assistant Environment

8

Digital Assistant User Roles

9

Assign Digital Assistant User Roles

10

Get Digital Assistant URL in Oracle Cloud Console

10

Integration of the Application with Digital Assistant

11

Install Predefined Digital Assistant in ODA Instance

12

Train Digital Assistant

14

Configure Channels

14

Enable Insights in Digital Assistant

21

Test Digital Assistant

21

About Personalizing Digital Assistants

26

Upgrade Digital Assistant

27

Export and Import Digital Assistant

27

Add Custom Skills

28

About Extending Installed Skills

28

About Extending Ready to use Skills

30

Export and Import Skills

30

Set the Duration for User Session Timeout

31

FAQs for Configuration of Digital Assistant

32

Get Help

There are a number of ways to learn more about your product and interact with Oracle and other users.

Get Help in the Applications

Some application pages have help icons  to give you access to contextual help. If you don't see any help icons on your page, click your user image or name in the global header and select Show Help Icons. If the page has contextual help, help icons will appear.

Get Training

Increase your knowledge of Oracle Cloud by taking courses at [Oracle University](#).

Join Our Community

Use [Cloud Customer Connect](#) to get information from industry experts at Oracle and in the partner community. You can join forums to connect with other customers, post questions, suggest [ideas](#) for product enhancements, and watch events.

Share Your Feedback

We welcome your feedback about Oracle Applications user assistance. If you need clarification, find an error, or just want to tell us what you found helpful, we'd like to hear from you.

You can email your feedback to oracle_fusion_applications_help_ww_grp@oracle.com.

Thanks for helping us improve our user assistance!

1 Get Started

About This Guide

If you want to configure the digital assistant for Oracle Fusion Cloud Applications, this guide is for you. Use it to learn how to do general tasks, such as configure, access, set up, export, and import digital assistant for Fusion Applications.

You can also learn how to configure several channels to associate them with the digital assistant. If you're looking for information about any product-specific skills, see the product-specific guides.

Overview

Oracle Fusion Cloud Applications provides its own digital assistant (FADigitalAssistant) to enhance employee productivity and increase engagement by leveraging conversations to complete tasks and answer queries.

The AI-powered conversational UI lets users communicate with Fusion Applications using their natural language with almost zero learning effort. You can configure the digital assistant and use it.

Related Topics

- [Oracle Digital Assistant Documentation](#)

Before You Start

Consider these points before you get started with configuring the digital assistant for your users.

- Make sure you've subscribed to the services related to the digital assistant.
- Get your channels, such as Oracle Web, Microsoft Teams, or Twilio account, configured to associate them with the digital assistant. For more information on configuring channels, see [Configure Channels](#).

Here are a few URLs you must know:

Application	URL
Oracle Cloud Infrastructure Identity and Access Management	<a href="https://<Identity Domain ID>.identity.oraclecloud.com/ui/v1/adminconsole">https://<Identity Domain ID>.identity.oraclecloud.com/ui/v1/adminconsole
Oracle Fusion Cloud Applications	<a href="https://<Fusion domain>.fa.<data center>.oraclecloud.com/fscmUI/faces/FuseWelcome">https://<Fusion domain>.fa.<data center>.oraclecloud.com/fscmUI/faces/FuseWelcome For example, to access Oracle Cloud HCM, your sign in URL pattern must be: <a href="https://<Fusion domain>.fa.<data center>.oraclecloud.com/hcmUI/faces/FuseWelcome">https://<Fusion domain>.fa.<data center>.oraclecloud.com/hcmUI/faces/FuseWelcome

Related Topics

- [Enterprise Resource Planning](#)
- [Digital Assistant](#)
- [Oracle Applications Products](#)
- [Twilio](#)

Where to Find Information About Product-Specific Digital Assistants

Here are some resources to help you get going.

Service	Oracle Digital Assistant Skill	Link
Oracle Fusion Cloud HCM	<p>HcmV2: You use this skill to start manager or employee self-service transactions and to clarify your employment-related questions.</p> <p>HCM Knowledge: You use this skill to make Knowledge Management knowledge base content available to HCM HR help desk users through multiple channels.</p> <p>Hiring: You use this skill to check the status of your requisitions and candidates, and review any pending offers.</p> <p>Approvals: You use this skill to see the tasks that require your approval and the status of your approval submissions.</p> <p>Candidate Experience: You use this skill to search for jobs, check your application status, and withdraw your application.</p> <p>Internal Candidate Experience: You use this skill to search for internal jobs, check your application status, and withdraw your application.</p>	<ul style="list-style-type: none"> • Using Oracle Digital Assistant to Interact with HCM Cloud. <p>See: Oracle HCM Digital Assistant</p>
Oracle CX Sales	You use this skill to do your day-to-day sales-related tasks.	<ul style="list-style-type: none"> • Get started with Oracle Sales Assistant. <p>See: Oracle Sales Assistant</p>
Oracle Expense	You use this skill to do your day-to-day expenses-related tasks.	<ul style="list-style-type: none"> • Get started with Oracle Expense Assistant. <p>See: Overview of Expense Assistant</p> <ul style="list-style-type: none"> • Learn about setting up Oracle Expense Assistant. <p>See: Overview of Setting up Expense Assistant</p>

Service	Oracle Digital Assistant Skill	Link
Oracle Logistics Digital Assistant	You use this skill to track the status of your orders and shipments from Oracle Transportation Management (OTM) Cloud.	<ul style="list-style-type: none"> Get started with Oracle Logistics Digital Assistant. See: Logistics Digital Assistant
Oracle Project Management	<p>Project Time Entry: You use this skill to record your project-based time entries and submit time cards.</p> <p>Project Management: You use this skill to do your project management activities, such as view and update tasks, deliverables, issues, and action items. You can also check the project progress and financial status.</p>	<ul style="list-style-type: none"> Learn about the Project Time Entry Skill. See: Oracle Digital Assistant for Project Time Entry Learn about the Project Management Skill. See: Oracle Digital Assistant for Project Management
Oracle Field Service	You use the sample skills provided by Oracle Field Service for helping technicians who have started an activity and for helping technicians when they haven't been able to start the activity.	<ul style="list-style-type: none"> Learn about Oracle Digital Assistant Integration for field service. See: Oracle Field Service
Oracle Care Experience	You use this skill to set up care experience.	<ul style="list-style-type: none"> Oracle Digital Experience for Communications. See: Oracle Care Experience
Oracle B2C Service	You use this skill to quickly create your own digital assistant that handles functionality such as FAQs, Knowledge Search, Agent Handover, Check Status, and Small Talk.	<ul style="list-style-type: none"> Oracle Digital Assistant for B2C Service. See: Using B2C Service

For information about platform versions and lifecycle phases for digital assistants, see [Platform Version](#).

2 Configure Digital Assistant

Overview of Configuring Digital Assistant

Your project users access Oracle Digital Assistant (ODA) with a specific user role. So you can assign the user roles to them, such as administrator, developer, and business user.

 [Watch video](#)

You must train your digital assistant, configure channels, and associate them with your digital assistant. Once you set up your digital assistant, you can test it to check whether it's working correctly on your desktop and mobile devices.

Oracle Digital Assistant Architecture

The ODA platform supports the development of the digital assistants and individual skill chatbots. This diagram illustrates the architecture of ODA.

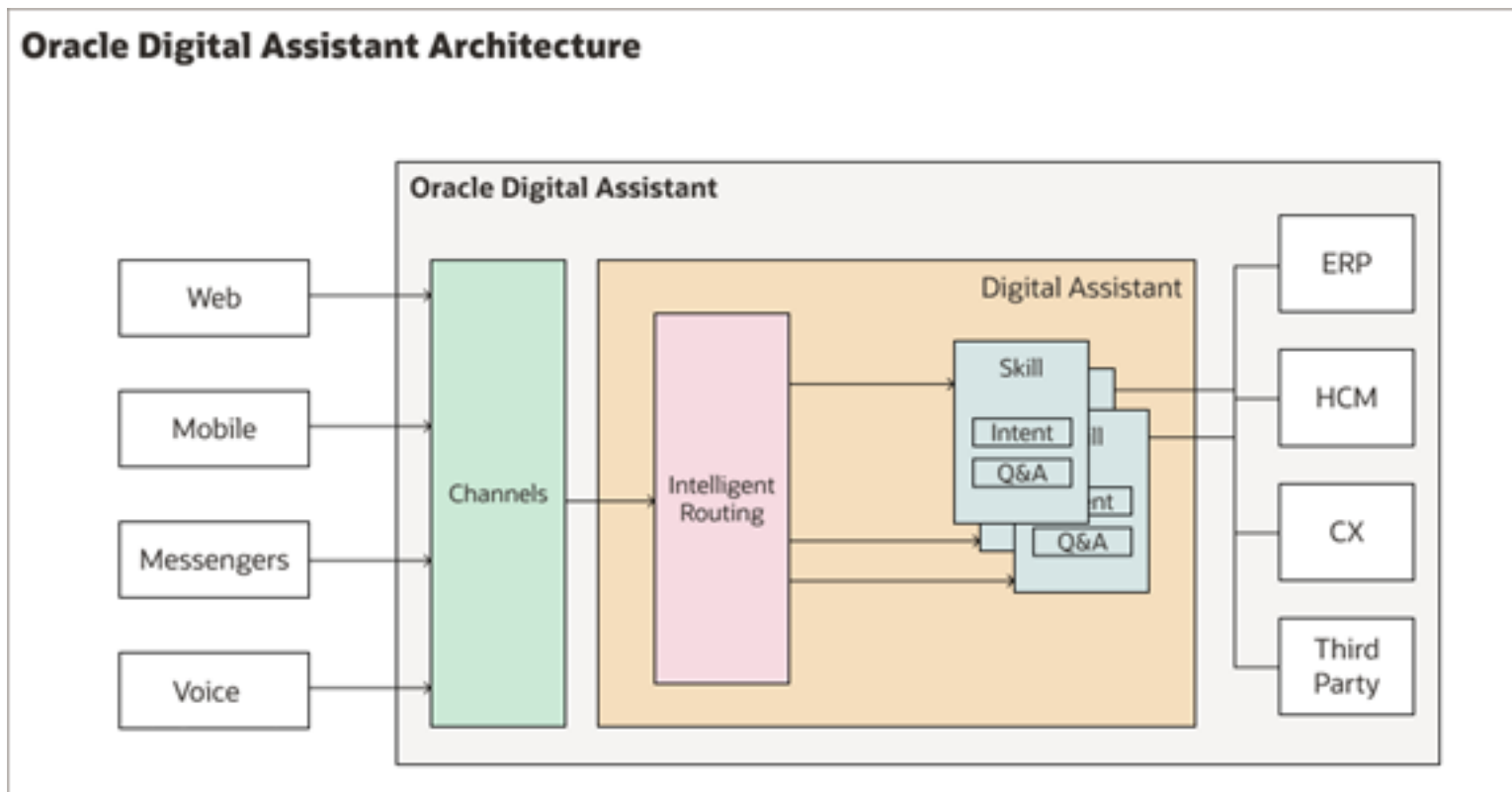

The ODA platform includes the tools to create and configure the various components involved in the architecture of ODA.

- Digital assistants, which are AI-driven interfaces (commonly known as chatbots) that help users accomplish various tasks in natural language conversations. It's the central chatbots that coordinate the user interaction with one or more skill chatbots, by using intelligent routing.
- Skill chatbots, which are individual chatbots that are focused on specific types of tasks, such as tracking inventory, submitting time cards, and creating expense reports. It uses natural language processing to resolve user intent and extract information from the message sent through conversational channels. You can add skills to the digital assistants or deploy them to a channel on their own.
- Channels, which are the connectors that bind a digital assistant or an individual skill chatbot to messaging services, such as Facebook, WeChat, mobile, or web. A single digital assistant or skill can have several channels configured for it so that it can run on different services simultaneously.
- Skill Store, which offers a range of prepackaged skills and digital assistants. Chatbot developers and administrators add prebuilt skill chatbots to their digital assistants, including SaaS service skill chatbots for ERP, CX, and HCM.

Related Topics

- [Build Your Digital Assistant](#)
- [What Are Skills?](#)
- [User Channel Routing](#)

How the Integration of the Application with Digital Assistant is Secured

Here are the key security aspects of the integration between Oracle Digital Assistant and Oracle Fusion Cloud Applications.

Security Overview

Oracle Digital Assistant is a native Oracle Cloud Infrastructure (OCI) service, which is available in both the Public Commercial and Government regions. Digital Assistant is also accredited as FedRAMP compliant. Digital Assistant uses FIP encryption everywhere, for data in transit and data at rest.

The application is integrated with the digital assistant at provisioning time. When the Fusion Applications pod is provisioned, a dedicated digital assistant service instance is provisioned for that pod. This pairing associates the application with the digital assistant.

Here are the key aspects of the pairing:

- The paired application package, which includes the authentication service for the application, is installed and configured on the Fusion Applications pod. Among other things, this configuration sets up the security groups and policies.
- In the digital assistant, an [Authentication Service](#) is set up and configured to the OCI Identity and Access Management domain of the Oracle Fusion Cloud Applications pod.

- The OCI identity domain of the Fusion Applications pod is registered as an authentication service on the digital assistant Authentication Service page.
- In the digital assistant, an Oracle Web channel is configured. You might also add other channels based on your needs.

Runtime Security

This diagram illustrates how you converse with the Fusion Applications pod, and the security features involved in the process.

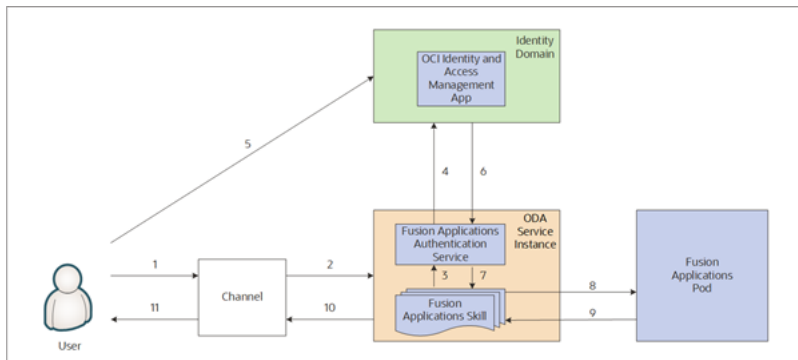

This table describes the steps illustrated in the diagram.

Callout Number	Data Flow	Description
1	User to Channel	The user starts a conversation by entering a message through an Oracle Web channel in Digital Assistant. Note: Configuration of the Web settings is a manual process in both the ODA service instance and the Fusion Applications Designer.
2	Channel to ODA Service Instance	The channel sends the encrypted message through the channel security to the ODA service instance. See Configure Client Authentication .
3	Fusion Applications Skill to Fusion Applications Authentication Service within ODA Service Instance	The message from the channel is routed to the Fusion Applications Skill in the ODA service instance, which then triggers the authentication service for the application.
4	Fusion Applications Authentication Service to OCI Identity and Access Management App	The authentication service checks if the user has been authenticated with the identity domain. If not, the authentication service sends an OAuth access token request to the identity domain server. This redirects to the OCI identity domain sign in page, prompting the user to sign in.
5	User to OCI Identity and Access Management App	The user enters the user name and password.
6	OCI Identity and Access Management App to Fusion Applications Authentication Service	After the user is successfully authenticated, the identity domain server returns both an access token and a refresh token to the

Callout Number	Data Flow	Description
		Fusion Applications Authentication Service. This process happens within the Fusion Applications skill's OAuth access token flow. The access token has a default expiration period of 8 hours, and the refresh token has an expiration period of 7 days.
7	Fusion Applications Authentication Service to Fusion Applications Skill	In the same channel, if the user sends any other requests within the 8-hour expiration window, the same access token will be used. In the same channel, if the user sends any other requests beyond the 8 hours and less than 7 days, then the authentication service will request a new access token through refresh token.
8	Fusion Applications Skill to Fusion Applications Pod	The Fusion Applications Skill sends a REST API request with the access token received in step 6. The Fusion Applications Pod proceeds to do the authentication using the OAuth access token.
9	Fusion Applications Pod back to Fusion Applications Skill	The Fusion Applications Pod returns the response to one or more Fusion Applications Skills in the ODA service instance.
10	Fusion Applications Skill to Channel	The ODA service instance returns the response to the channel.
11	Channel back to the User	The channel displays the response to the User.

Access Your Preprovisioned Digital Assistant Environment

You can set up access privileges for yourself and other users to the Oracle Digital Assistant (ODA) that has been preprovisioned for you.

As a primary cloud administrator, you get a welcome email to activate the Oracle Cloud user account and set up the cloud sign in credentials. To change the primary administrator, you must provide an authorization email from a company senior executive in a technical service request.

To access your preprovisioned digital assistant environment, use these steps:

1. Open your Oracle cloud account url in your browser. For example, <https://cloud.oracle.com/identity/domains/?tenant=icorinternal&domain=Default®ion=us-phoenix-1>. Here the tenant name is your cloud account name.
2. On the Oracle Cloud Account Sign In page, enter your cloud account user name and the password that you configured during the cloud account activation and click **Sign In**.
3. On Oracle Cloud Console, navigate to the **List of Scope** menu, and select your compartment from the **Compartment** list.
4. On the Domains page, click your domain, from the available domains.
5. On the console, from the **Identity domain** menu, click **Oracle Cloud Services** to view all the instances.
6. On the Oracle Cloud Services page, search and open your ODA application instance.

Note: By default, all the available users are synchronized in the ODA application.

Related Topics

- [How to add FA_GSI_Administrator role to a user?](#)
- [Activating Your Oracle Cloud Applications Order](#)

Digital Assistant User Roles

You must assign appropriate roles to your users so that they can administer, configure, or analyze digital assistant. Based on their roles, users can access the digital assistant, import skills, add utterances, test skills, or extend the digital assistant.

This table shows the roles you can assign to your users and what they can do.

User Roles	What They Can Do
ServiceAdministrator ODA Service Administrator Role	<ul style="list-style-type: none"> • Get complete access to the Bots instance for the draft and published skills. • Access or import skills. • Clone or extend skills. • Delete a published skill or digital assistant. • Do data management tasks, such as purging data when the instance is out of memory.
ServiceDeveloper ODA Service Developer Role	<ul style="list-style-type: none"> • Delete a draft skill but not a published one. • Get full access to build and test the digital assistant and skills. <p>Note: Users with this role can't access the data management tasks and so they can't purge data.</p>
ServiceBusinessUser ODA Service Business User Role	<ul style="list-style-type: none"> • Get access to the analytics insights. • Test the dialog flows and whether the intent and entity match. • Add sample utterances to the training corpus to retrain a skill. But a business user can't add sample utterances to the skill directly. Instead, the business user can use analytics insights to train the skill again with user patterns. <p>Note: This role is primarily specific to an analyst in the company, or someone who's in the line of business, such as expenses, and wants to see the analytics. Users with this role can only view the skills or settings but can't change them. They can't access the data management tasks to purge data.</p>

Related Topics

- [Assign Digital Assistant User Roles](#)
- [What Are Skills?](#)

Assign Digital Assistant User Roles

With the Identity Domain Administrator role, you can access your application instance on the Oracle Cloud services and assign appropriate roles to your users.

If you're using single sign-on to access Oracle Applications Cloud, make sure that your sign in credentials are automatically synchronized with OCI Identity and Access Management during hybrid provisioning.

1. Sign in to Oracle Cloud Console.
2. On the console, from the **Identity domain** menu, click **Oracle Cloud Services**.
3. On the Oracle Cloud Services page, search and open your ODA application instance provisioned on your identity domain.

Tip: You can search for **idcs-oda**.

4. On the ODA application instance, click Application Roles tab from the **Resources** menu.
5. Select a role and click the corresponding downward dropping arrow and then click the **Manage** link for **Assigned users**.
6. On the Manage user assignments dialog box click the **Show available users** link.
7. From the Available users section, search for the required user name, select it, and click **Assign**.

Get Digital Assistant URL in Oracle Cloud Console

You can find and use the digital assistant URL in Oracle Cloud Console and also share the URL with other users.

1. Sign in to Oracle Cloud Console.
2. On the console, from the **Identity domain** menu, click **Oracle Cloud Services**.
3. On the Oracle Cloud Services page, search and open your ODA application instance provisioned on your identity domain.

Tip: You can search for **idcs-oda**.

4. On the ODA application instance, click OAuth Configurations tab from the **Resources** menu.

5. In the Configure application APIs that need to be OAuth protected section, copy the URL from the **Primary Audience** field, and share it with other users as required.

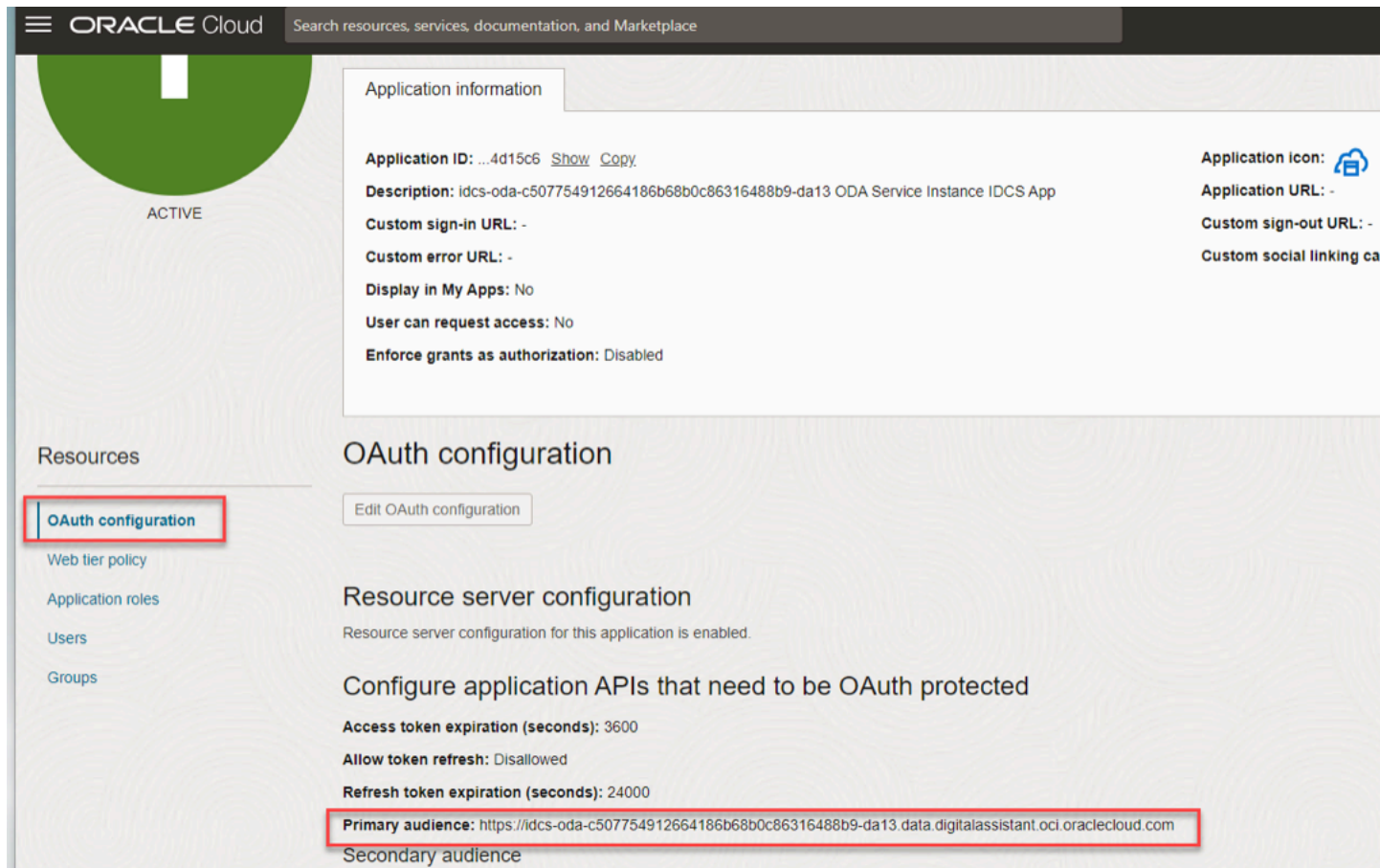

Integration of the Application with Digital Assistant

You can use Oracle Fusion Cloud Applications to open and set up the digital assistant.

You must have either of these roles to do this task.

- ODA Service Administrator
- ODA Service Developer

You can configure the Oracle Web channel to associate it with your digital assistant.

1. Sign in to Fusion Applications.
2. Click **Navigator > My Enterprise > Setup and Maintenance**.
3. In the Setup and Maintenance work area, go to the **Manage Digital Assistant** task:
 - Offering: Financials
 - Functional Area: Expenses

Your paired digital assistant opens in a separate tab.

4. In the digital assistant instance, pull FADigitalAssistant from the skill store.

Note: You can extend the predefined digital assistants and skills. This means you can create a new version of your digital assistant and skill, and change it as required. The changed version remains compatible with the original version. If you don't have the ODA Platform for SaaS subscription, you can only extend FADigitalAssistant, not the skills.

Related Topics

- [Get a Skill from the Skill Store](#)
- [Extending Digital Assistants and Skills](#)
- [Update Existing Setup Data](#)

Install Predefined Digital Assistant in ODA Instance

The administrator needs to pull FADigitalAssistant to your ODA instance to use the predefined digital assistants and skills from the skill store.

To pull FADigitalAssistant from the skill store:

1. Click **Navigator > Development > Store**.

Here's the screen shot of a skill store from where you can pull FADigitalAssistant.

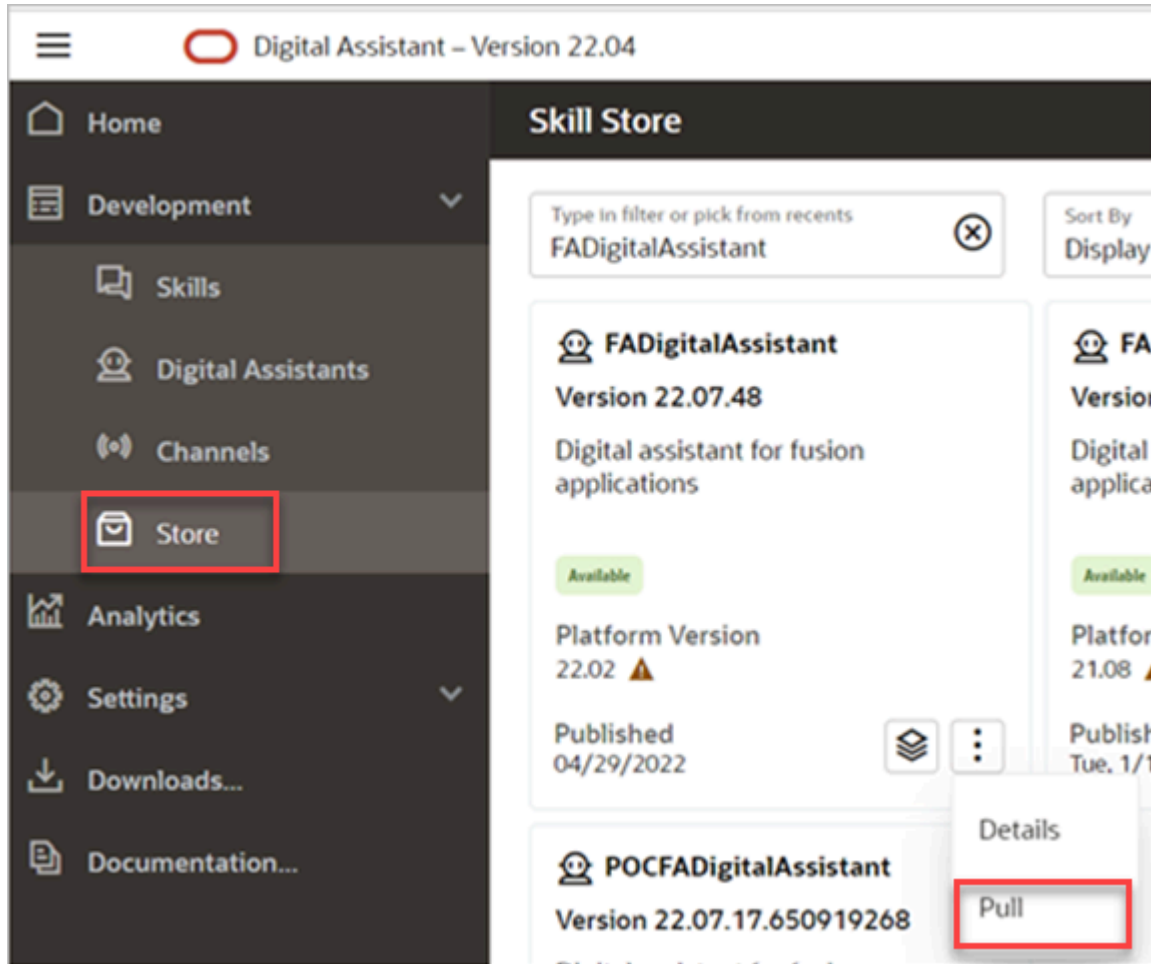

2. In **Skill Store**, search for the digital assistant or skill that corresponds to your application version, for example, FADigitalAssistant Version 22.07.48.

Note: The FADigitalAssistant tile shows the digital assistant version and the ODA platform version. The first four digits of the version number correspond to the application release and the last two digits show the FADigitalAssistant version within the release. For example, in the 22.07.48 version, 22 corresponds to the year 2022, and 07 corresponds to the quarterly release (01 = A, 04 = B, 07 = C, 10 = D) of the application version. The last two digits, 48, show the FADigitalAssistant version within the 22.07 release. The platform version is displayed in a four-digit format, the first two digits show the year, and the next two digits show the month. For example, in the 22.02 platform version, 22 corresponds to the year 2022, and 02 corresponds to February.

3. In the tile for FADigitalAssistant, click the menu icon and select **Pull**.

Note: FADigitalAssistant is pulled automatically from the skill store, but if the latest version isn't pulled, you can manually pull it again.

After you pull a skill or digital assistant from the skill store, you can do any of these tasks:

- o Use it as is.
- o Extend it, which enables you to configure it in several ways, such as answer intents and inherit tracking ID from the base skill. Later, if a new version of that skill or digital assistant is available in the skill store, you can rebase your configurations to the new version.
- o Clone it, which enables you to make special modifications like update the platform version for the latest Machine Learning (ML) models. When you clone a skill or digital assistant that you have pulled from the skill store, you can't later rebase to new versions in the absence of tracking IDs.
- o Install update, if you have a skill or digital assistant that you have pulled from the skill store and an update is available. You can update that skill or digital assistant with the newest version using the **Install Update** option.

Related Topics

- [Extend a Skill](#)

Train Digital Assistant

Before you can use the digital assistant, you need to train it.

1. Click **Navigator > Development > Digital Assistant**.
2. Open the digital assistant by clicking its tile.
3. In the navigation bar for the digital assistant, click the **Train** button.
4. In the Train dialog box, leave **Trainer Tm** as the default, click **Submit**, and wait for the training to complete.

Note:

- When you pull the digital assistant from the tile, it gets trained automatically. But, if the training process fails, you need to manually train the digital assistant.
- You can't train a published digital assistant.

Configure Channels

You can use your digital assistant in various channels, such as Oracle Web, Twilio, and Microsoft Teams. You can configure these channels to associate them with your digital assistant.

This table lists the different skills and the supported channels.

Skill	Description	Channels Supported
Expenses	You use this skill to do your day-to-day expenses-related tasks.	<ul style="list-style-type: none"> Oracle Web Microsoft Teams Twilio SMS
Project Time Entry	You use this skill to record your project-based time entries and submit time cards.	<ul style="list-style-type: none"> Microsoft Teams Twilio SMS
Project Management	You use this skill to do your project management activities, such as view and update tasks, deliverables, issues, and action items. You can also check the project progress and financial status.	<ul style="list-style-type: none"> Microsoft Teams Twilio SMS
CX Sales	You use this skill to do your day-to-day sales-related tasks.	<ul style="list-style-type: none"> Microsoft Teams
Internal Candidate Experience	You use this skill to help your employees to search for jobs, check their application status, and withdraw their application.	<ul style="list-style-type: none"> Oracle Web Microsoft Teams Twilio SMS
Hiring	You use this skill to help your recruiters and the hiring team to check requisition status and candidate status and review any pending offers.	<ul style="list-style-type: none"> Oracle Web Microsoft Teams Twilio SMS
HcmV2	You use this skill to start manager self-service transactions and to clarify your employment-related questions.	<ul style="list-style-type: none"> Oracle Web
HCM Knowledge	You use this skill to support user queries on knowledge base content available to Classic HR help desk customers.	<ul style="list-style-type: none"> Oracle Web
Candidate Experience V2	You use this skill to search for jobs, check their application status, and withdraw their application.	<ul style="list-style-type: none"> Oracle Web
Helpdesk	You use this skill to clarify the queries of your employees.	<ul style="list-style-type: none"> Oracle Web

Configure Oracle Web Channel



Watch video

You can use the Oracle Digital Assistant application to configure Oracle Web channel.

1. Sign in to Oracle Digital Assistant.
2. Click **Navigator** > **Development** > **Channels**.
3. Click **Add Channel**.

4. In the Create Channel dialog box, do these tasks:
 - a. Enter the name and description of your channel.
 - b. From the **Channel Type** list, select **Oracle Web**.
 - c. In the **Allowed Domains** field, enter ***** or the URL of your application.

Note: Enter an asterisk to allow unrestricted access to the channel from any domain. If you want the channel to communicate only with specific sites, you can enter one or more domains as a comma-separated list.

- d. Turn off **Client Authentication Enabled** option for unrestricted access.
- e. Optionally, set the availability duration for the Oracle Web channel. The default value is 1440 minutes.

You use the **Session Expiration** field to set the timeout for inactive user sessions. The default value is one day (1440 minutes). When the session expires, the conversation is terminated, and a message is sent to notify the user.

- f. Click **Create**.
5. To associate this channel with FADigitalAssistant, click the **Route To** drop-down list, search, and select the latest version of FADigitalAssistant.
6. Turn on **Channel Enabled** and click **Reset Sessions**.
7. Copy the channel ID or make a note of it.

You'll need this channel ID while enabling your digital assistant.

Configure Digital Assistant to Work with Oracle Web Channel

After you configured the Oracle Web channel, set up the digital assistant to work with the Oracle Web channel and add the digital assistant in Oracle Fusion Cloud Applications. You can also enable attachment sharing for your users. After you enable it, users can share attachments, such as images, while interacting with the digital assistants.

1. Enable the digital assistant for Fusion Applications.
 - a. Sign in to Fusion Applications.
 - b. Click **Navigators > My Enterprise > Setup and Maintenance**.
 - c. In the Setup and Maintenance work area, go to the **Manage Administrator Profile Values** task:
 - Offering: Sales
 - Functional Area: Sales Foundations
 - d. On the Manage Administrator Profile Values page, search for and select the profile option - **Profile option to enable digital assistant (FA_ENABLE_DIGITAL_ASSISTANT)**.
 - e. In the FA_ENABLE_DIGITAL_ASSISTANT: Profile Values section, click the **New** icon.
 - f. From the **Profile Level** list, select **Site**.
 - g. In the **Profile Value** field, enter **Y**.
 - h. Click **Save and Close**.

2. Add the digital assistant to Fusion Applications.
 - a. Activate a sandbox that has the HCM Experience Design Studio tool in it.
 - b. On the **Tools** menu, select **HCM Experience Design Studio**.
 - c. On the HCM Experience Design Studio page, click Digital Assistant Configuration tab.
 - d. In the Network Configuration section, enter values in these fields.

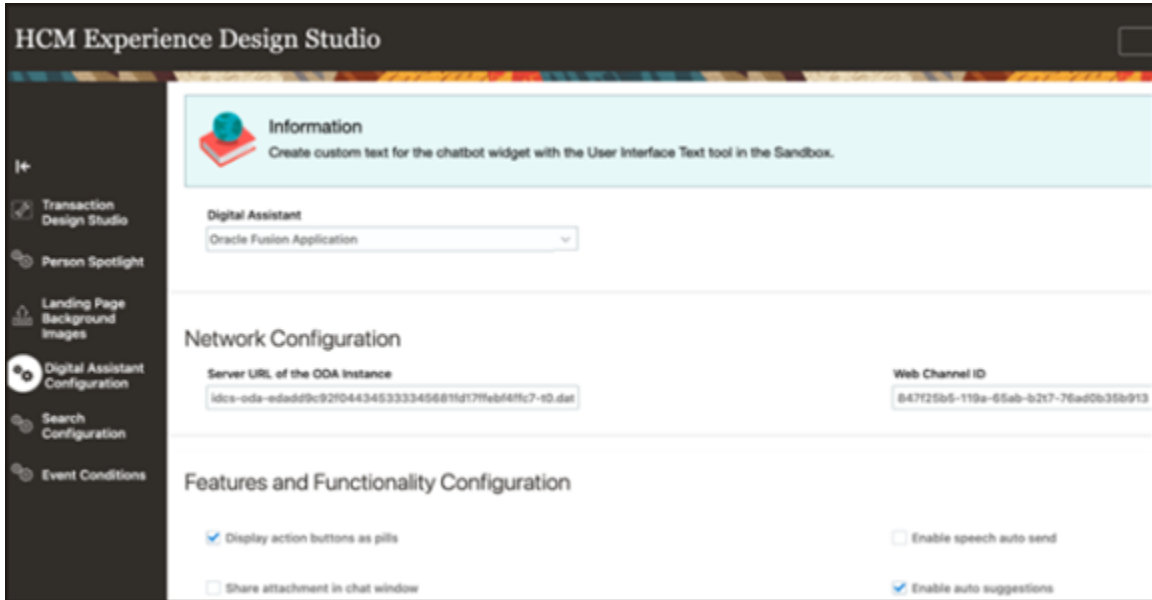

- In the **Server URL of the ODA Instance** field, enter the server URL of your digital assistant instance where the Oracle Web channel is configured. For example, `idcs-oda-88343450fd012b9fb498be0c36-t0.data.digitalassistant.oci.com`.

Note: When you enter the server ODA URL, make sure it doesn't contain `https://` or a trailing slash.

- In the **Web Channel ID** field, enter the web channel ID, which you got when you configured Oracle Web channel for your digital assistant.

Note: When you enter the web channel ID, make sure it doesn't contain any spaces.

- e. In the Features and Functionality Configuration section, specify other web channel preferences, such as enable attachment sharing.

This table describes the various features and functionality configurations available for the digital assistant.

Features and Functionality Configuration	Description
Display action buttons as pills	Select this checkbox to display the action buttons as pill buttons outside the message bubble.
Share attachment in chat window	Select this checkbox to share the attachment in a chat window.

Features and Functionality Configuration	Description
	<p>Note: As standard features, you can share attachments only for the Expenses and Helpdesk skills. For other skills, you need to design a custom task to share attachments.</p>
Bot responses in audio	Select this checkbox to enable the skill's utterances to be read aloud using the web speech synthesis API.
Show clear message button on chat window header	Select this checkbox to display the Clear Message button in the chat widget header.
Open chat window when page is loaded	Select this checkbox to open the chat widget when the application is loaded.
Displays chat bubble icon when user is waiting for the bot to respond	Select this checkbox to display an animated chat bubble icon in the conversation pane when waiting for a response.
Time stamp mode	<p>Select this checkbox to display the date and time as absolute or relative on each conversation.</p> <ul style="list-style-type: none"> - The absolute value displays the exact time of the conversation. - The relative value displays the number of moments, minutes, hours, days, months, or years ago the previous message was received. For example, '5 seconds ago' or '3 minutes ago'.
Auto play audio	Select this checkbox to enable the skill's utterances to be read aloud as they're received using the web speech synthesis API.
Auto play video	Select this checkbox to enable video autoplay.
Enable speech	Select this checkbox to enable the voice recognition service so that the user can converse with the skill using voice messages. The voice gets converted to text messages.
Enable speech auto send	Select this checkbox to enable the user's speech response to be automatically sent to the chat server (and displayed as a sent message in the chat widget). When this option is deselected, the user's speech response is rendered in the message text field before it's sent to the chat server so that the user can change it before sending it manually or deleting the message.
Enable auto suggestions	Select this checkbox to give users autocomplete suggestions for building their utterances and selecting the appropriate entity values. Autocomplete suggestions must be included in the skill's intents. When a user types a character into the chat input field, the autocomplete suggestions for the intents then show up in a dialog box to suggest the proper format, thereby reducing user errors.

Features and Functionality Configuration	Description
	<p>Note: The autocomplete suggestions for an intent must not be a comprehensive word dictionary, but they give better guidance to the user.</p>
Enable launch button dragging	<p>Select this checkbox to enable users to drag the Launch button out of the way when it's blocking content on the web page. This feature also works for Android and iOS Safari browsers.</p> <p>Note: For Redwood applications, this checkbox isn't available.</p>
Enable local conversation history	<p>Select this checkbox to enable loading the previous conversation linked with a given user Id in a browser after the widget is initialized.</p>
Initialize bot audio muted	<p>Select this checkbox to initialize the skill message utterance in muted mode.</p> <p>Note: This checkbox is applicable only when the Bot responses in audio check box are selected.</p>
Open links in new window	<p>Select this checkbox to override the user's browser preference by opening links in a new window. This setting applies to all links present in the conversation, including action buttons, fallback links for attachments, and card links. It's not recommended for Fusion Applications deep links.</p>
Disable previous action buttons to prevent users from selecting them again	<p>Select Yes from the drop-down list to disable action buttons in a skill message after the user has used it.</p>
Message automatically sent to bot to start the conversation	<p>Enter a message to be automatically sent to the bot to start the conversation.</p>
Available locale	<p>Enter the language that will be used in the chat widget's multilingual skills.</p>
Default locale	<p>Enter the default language for the widget's text strings. The locale given during initialization takes precedence over the browser locales of the users. If there isn't an exact match, the closest language will be displayed. For example, if the locale is 'da-dk' but only 'da' translations are available, the 'da' translation is used. In the absence of translations for the given locale, translations for the browser locales are searched and applied. If none of them have translations, the default locale, 'en,' is used for translations.</p>
End conversation	<p>Select this checkbox to add a Close button to the chat header that allows the user to end the current conversation session. Clicking the Close button disconnects the instance from the skill, closes the chat widget, and deletes the conversation history of the current user.</p>

f. Click **Save and Close**.

- g.** Test the configuration in the chat window and publish your sandbox.

Configure Microsoft Teams Channel

You can configure a Microsoft Teams channel so that your users can chat with the digital assistant in Microsoft Teams. But before you start, create an app using App Studio in Microsoft Teams, and add a bot to the app.

Here's how you can configure Microsoft Teams channel.

- 1.** Sign in to Oracle Digital Assistant.
- 2.** Click **Navigator > Development > Channels**.
- 3.** Click **Channel**.
- 4.** In the Create Channel dialog box, do these tasks:
 - a.** Enter the name and description of your channel.
 - b.** From the **Channel Type** list, select **Microsoft Teams**.
 - c.** Enter the Microsoft application ID and password.
Note: You get the ID and password after you add an app in Microsoft Teams.
 - d.** Optionally, set the availability duration for the Microsoft Teams channel. The default value is 60 minutes.
- 5.** Click **Create**.
- 6.** To associate this channel with FADigitalAssistant, click the drop-down button for the **Route To** list, search for the latest version of FADigitalAssistant, and select it.
- 7.** Turn on **Channel Enabled** and click **Reset Session**.
- 8.** Copy the Webhook URL or make a note of it.

You need this URL while configuring Webhook URL for Microsoft Teams.

Note: After you create the Microsoft Teams channel, you must configure Webhook URL for Microsoft Teams, enable apps in your Office 365 tenant, and test your assistant in Microsoft Teams. For more information about configuring Microsoft Teams channel, see *Microsoft Teams*.

Configure Twilio SMS Channel

Before you configure the Twilio SMS channel, make sure that you've a Twilio account. You must make a note of the account SID, authentication token, and phone number from your Twilio account.

- 1.** Sign in to Oracle Digital Assistant.
- 2.** Click **Navigator > Development > Channels**.
- 3.** Click **Channel**.
- 4.** In the Create Channel dialog box, do these tasks:
 - a.** Enter the name and description of your channel.
 - b.** From the **Channel Type** list, select **Twilio SMS**.
 - c.** Specify your account SID, authentication token, and phone number.
 - d.** Click **Create**.
- 5.** To associate this channel with FADigitalAssistant, click the drop-down button for the **Route To** list, search for the latest version of FADigitalAssistant, and select it.
- 6.** Copy the Webhook URL or make a note of it.

You need this URL while configuring Webhook URL for Twilio SMS.

7. Sign in to Twilio application.
8. Click **Navigator** > **Phone Numbers** > **Active Numbers**.
9. On the Active Numbers page, click a Twilio number.
Note: You must have the Twilio phone number. When you buy the Twilio account, you receive the phone number.
10. Click the Configure tab.
11. In the **A Message Comes In** field in the Messaging section, paste the webhook URL.
12. Click **Save**.

Related Topics

- [Before You Start](#)
- [Twilio/SMS](#)
- [Microsoft Teams](#)
- [Create and Activate Sandboxes](#)
- [Session Expiration](#)

Enable Insights in Digital Assistant

You can enable Insights, an analytics feature that reports performance indicators for the skills and the digital assistant. You can diagnose problems with your skills and also improve their understanding of user input.

- Sign in to Oracle Digital Assistant.
- Click **Navigator** > **Development** > **Skills**.
- Select the skill that you've configured.
- Click **Navigator** > **Settings**.
- Click **Enable Insights** to provide insight into how the skill is performing.
- Click **Navigator** > **Insights**.
Here you can see how the skill is performing, for example, complete versus incomplete conversations, and what are the top resolved intents.

Related Topics

- [Oracle Digital Assistant Insights](#)

Test Digital Assistant

You can test your digital assistant in the Oracle Digital Assistant instance. You can also test whether the digital assistant works after configuring Twilio SMS and Oracle Web channels.

Test Digital Assistant in the Oracle Digital Assistant Instance

1. Sign in to Oracle Digital Assistant.

2. Click **Navigator > Development > Digital Assistants**.

3. Click **FADigitalAssistant**, select the skill that you want to test, and click the **Preview** icon as in the screenshot.

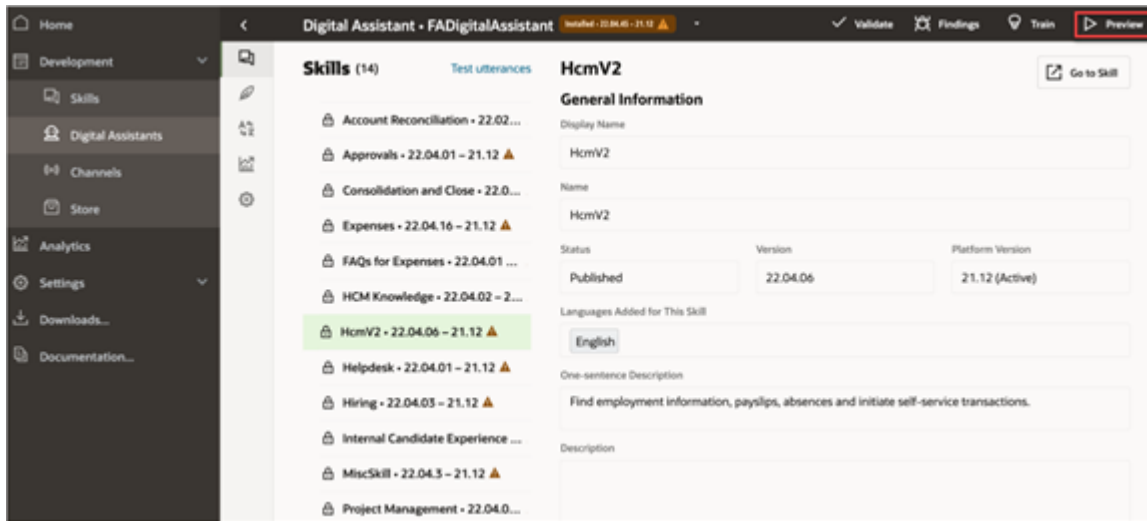

Here's the Conversation Tester page.

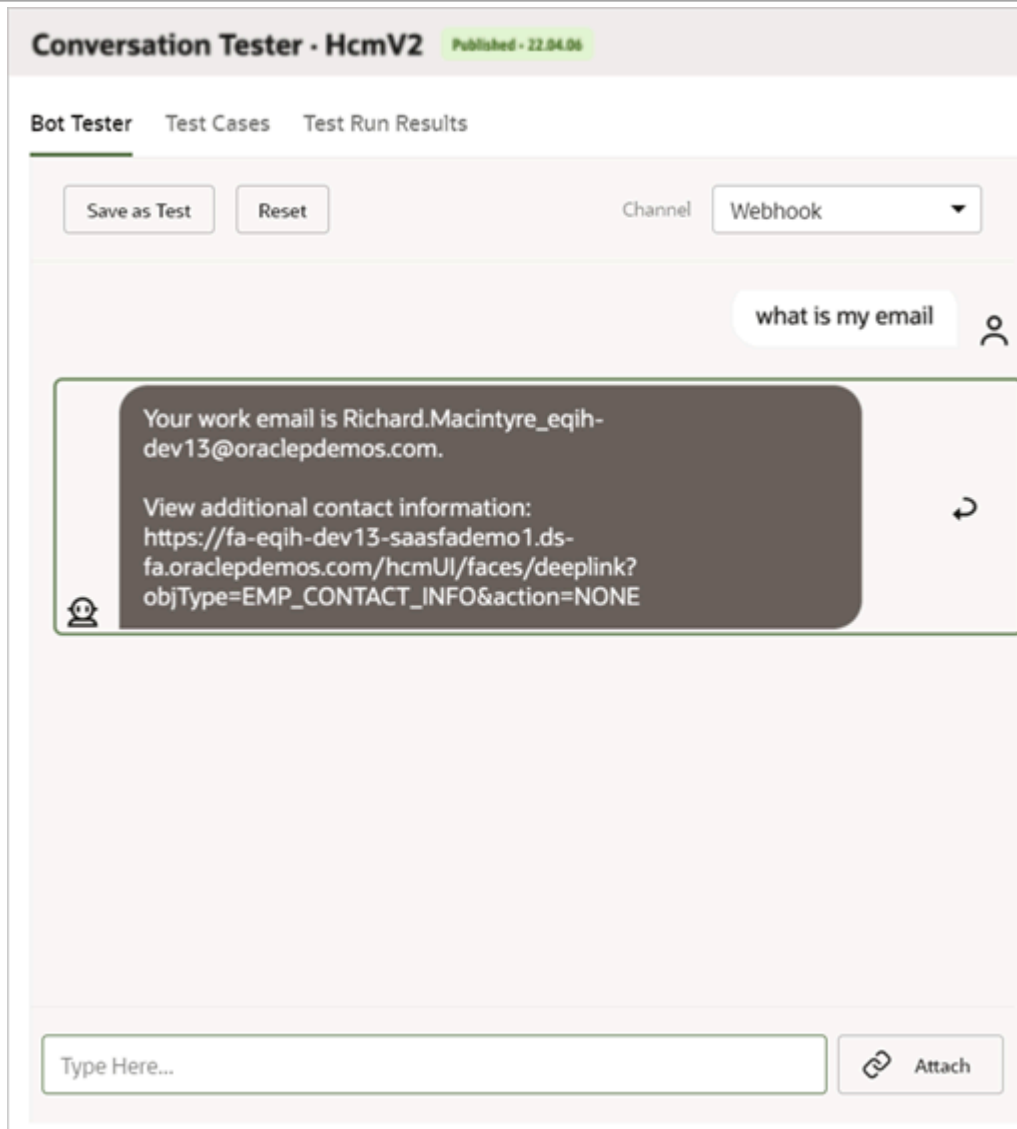

4. On the Conversation Tester page, in the text box, type your utterance, for example, What's my email. You must get a response in the chat window.

Note: Before using the conversation tester, set the endpoint parameter. See [Set da.FARestEndpoint Parameter](#).

Test Digital Assistant for the Twilio SMS Channel

When you configure the Twilio SMS channel, use a mobile device to test your digital assistant.

1. Open Oracle Digital Assistant on your mobile device.

2. Text **Hello** to the phone number that you configured.

The digital assistant responds with the tasks it can do for you as shown in this image.

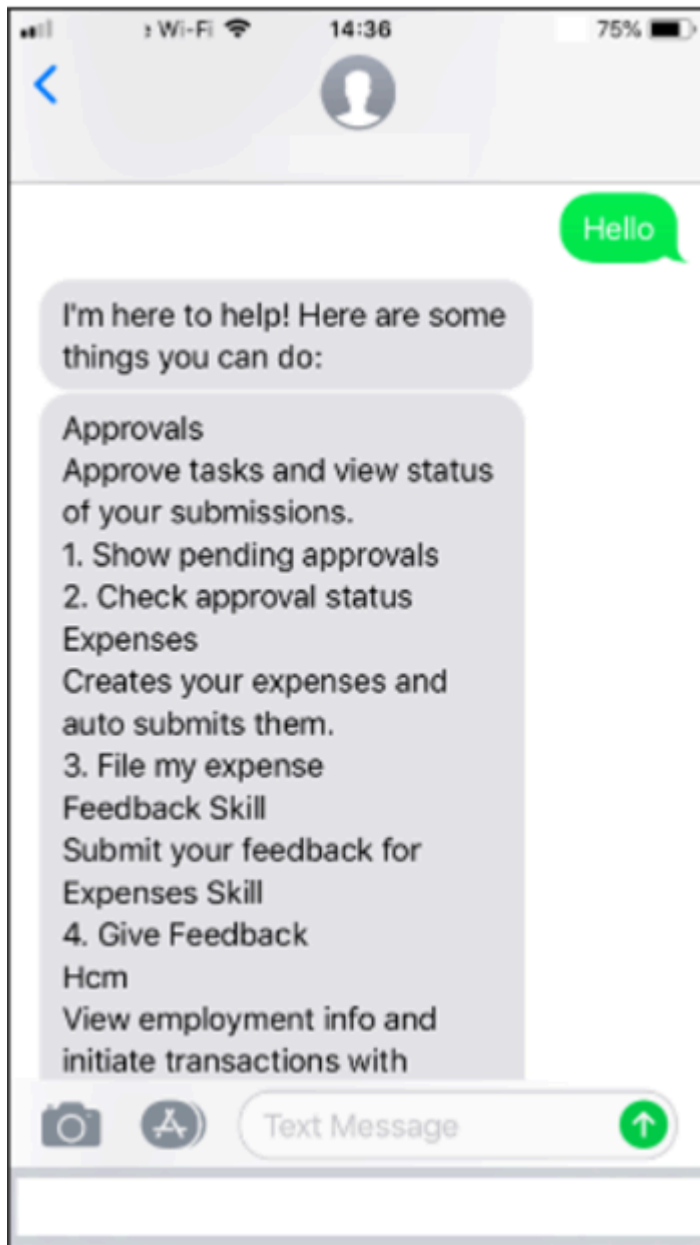

3. Respond by typing something on your mobile device. For example, you can type **Taxi for \$30**.

The digital assistant sends an URL to sign in to Oracle Fusion Cloud Applications.

4. Sign in to your application, and follow the steps provided in the SMS.

Test Digital Assistant for the Oracle Web Channel

After you configure the Oracle Web channel, test the digital assistant in the Oracle Fusion Cloud Applications.

1. In Fusion Applications, you can view the digital assistant, which is displayed as the **Chat** icon on the home page.

This image shows the **Chat** icon on the home page of the application.

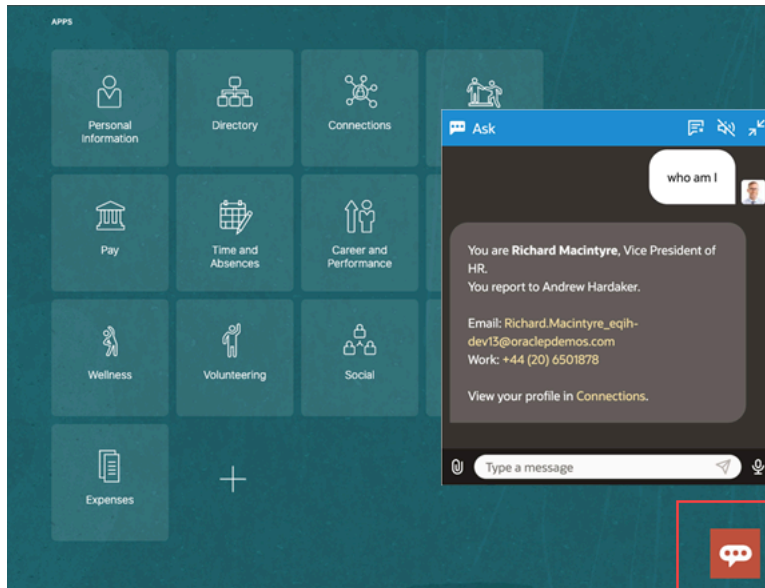

2. Click the **Chat** icon to open a chat window.
3. In the chat window, enter utterance. For example, who am I.

You must get a response in the chat window.

Related Topics

- [System Intents for Digital Assistants](#)
- [Digital Assistant Testing](#)
- [The Skill Tester](#)

About Personalizing Digital Assistants

If you deploy your ready-to-use skills as part of a single digital assistant, here are some things you can do with the digital assistant.

- [Add Skills to Digital Assistant](#)
- [Personalize Your Digital Assistant](#)
- [Tune Routing Behavior](#)
- [Linking of Digital Assistant Instances](#)

Upgrade Digital Assistant

To continuously improve the quality of your skills and digital assistants, you must upgrade and get the latest updates in them.

Here are some best practices for upgrading skills and digital assistants:

- If you've ODA for SaaS subscription, you'll get notifications about new release versions.
- You must install updates from the skill store.
- It's recommended that you align the delivered SaaS skill version and FADigitalAssistant version with your Fusion Cloud Applications version. This allows your skill within FADigitalAssistant to be compatible with the new APIs and URLs along with the latest updated Machine Learning (ML) models.

For a skill or digital assistant you've installed from the skill store, if an update is available, you can update the newest version from the skill store.

1. Sign in to Oracle Digital Assistant.
2. Click **Navigator > Development > Digital Assistants**.
3. In the tile for the skill or digital assistant you want to update, click the **Menu** icon and select **Install Update**.

Note: If the skill or digital assistant you're updating is an extended one, you can rebase your extension to the updated version.

After upgrading, you must associate the required channels with the upgraded version of your digital assistant.

1. Click **Navigator > Development > Channels**.
2. Click **Channel**.
3. In the Create Channel dialog box, enter the details, and from the **Channel Type** list, select required the channel type.
4. Click **Create**.
5. To associate this channel with FADigitalAssistant, click the drop-down button for the **Route To** list, search for the latest version of FADigitalAssistant, and select it.
6. Click **Reset Sessions**.
7. On the Change Channel Routing dialog box, click **Change**.

Export and Import Digital Assistant

You can export your digital assistant from one environment, and import it to another one. But you can export only the custom digital assistants or the predefined digital assistants that were extended.

1. Sign in to the source environment, where you want to export the digital assistant from.
2. Click **Navigator > Development > Digital Assistants**.
3. Search for the digital assistant that you want to export.
4. Click the **Options** icon for the digital assistant that you want to export, and select **Export**.

Note: To export a specific version of a digital assistant, click the **Click to show all versions of this digital assistant**, click the **Options** icon for the version that you want to export, and then select **Export**.

5. Save the .zip file.

6. Sign out of your current session.
7. Sign in to the target environment, where you want to import the digital assistant to.
8. Click **Navigator > Development > Digital Assistants**.
9. On the Digital Assistant page, click **Import Digital Assistant**.
Note: To import an extension, the target instance must have the corresponding base bot installed.
10. Browse and select the .zip file that you want to import. You get a confirmation after the import is complete.

Add Custom Skills

You can create and add your own skills to the digital assistant. To add skills that aren't available in your digital assistant environment, export the skills from another environment, import to your environment, and then add them.

If the skills you want to add are available in your environment, do these steps:

1. Sign in to Oracle Digital Assistant.
2. Click **Navigator > Development > Digital Assistant**.

Here's the screenshot that shows how to add custom skills.

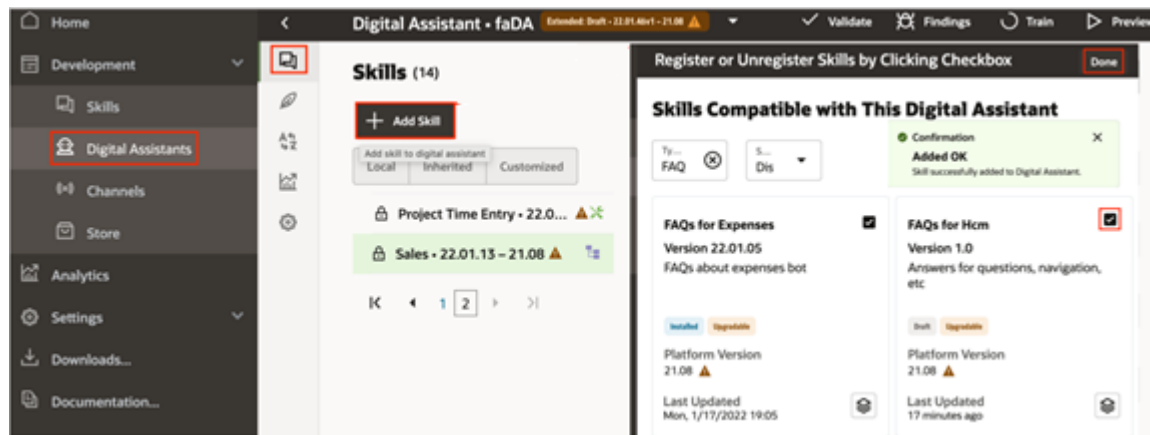

3. Search for the digital assistant you want to add the skills to.
4. Open the extended FADigitalAssistant and click **Add Skill**.
Note: Ensure that the Skills tab is selected.
5. In the extended FADigitalAssistant tile, click the check box to register the skill and then click **Done**.

Related Topics

- [Linking of Digital Assistant Instances](#)

About Extending Installed Skills

After you buy the pillar SKUs for Oracle Fusion Cloud Applications, you can access FADigitalAssistant, and its skills from the Oracle Digital Assistant platform skill store associated with your Fusion Applications.

After you pull a skill or digital assistant from the skill store, you can do these tasks:

- Configure channels supported by Oracle Digital Assistant. For example, Twilio, Oracle Web, and Microsoft Teams.
- Enable and disable skills according to your organization's needs.

You can buy the Oracle Digital Assistant Platform for SaaS (**ODAP4SaaS**) SKU to make more changes in the digital assistant, a few of which are listed here:

- Add utterances to existing intents and retrain to configure FADigitalAssistant.
- Add intents.
- Add entities.
- Change the dialog flow.
- Add or change custom components (change the common response components or add integrations).
- Add other channels supported by Oracle Digital Assistant.
- Add resource bundles for the dialog.
- View and analyze diagnostics, analytics, and transaction logs.

Set Skill Parameter Values in Digital Assistant

After a skill is published and added to a digital assistant, any "da." prefixed parameter values for a skill can be updated without code changes. If the "da." parameter with the same name is defined in multiple skills in the digital assistant, the value of that parameter is shared between the skills.

To set the "da." parameter values in a digital assistant, do these steps:

1. Click **Navigator > Development > Digital Assistants**.
2. In the digital assistant's navigator menu, click the **Skills** icon.
3. Select the required skill and go to the Parameters section and update the value of the required parameter. This table shows the lists of parameters that you can update.

Parameter	Description
da.FARestEndpoint	Enables the digital assistant to communicate with the Fusion Applications instance. The value of this parameter is the URL of your Fusion Applications instance. Note: The URL must begin with <code>https://</code> , end with <code>.com</code> , and not contain a port number. This parameter value is applied to all skills that use this parameter.
da.FAAuthenticationService	Authentication service that manages the Fusion Applications user sign-in process (mainly for channels other than Oracle Web channel). By default, the preprovisioned service name is populated.
da.FAEnableSingleSignOn	Enable or disable the Single Sign-On (SSO) capability for the Microsoft Teams channel, to avoid another sign-in within a chat conversation.

Related Topics

- [Extending Skills](#)

About Extending Ready to use Skills

After you've pulled ready to use skills, you can deploy them as is, or extend and then deploy them.

Explore these topics to learn what you can do and how to do it:

- Deploy a skill or digital assistant through a channel. See *Channel Basics*.
- Configure the skill for your business. See *Extending Digital Assistants and Skills*.
- Create tests for your extensions. See *Test Cases*.
- Learn the basics of skills:
 - *Intents*
 - *Entities*
 - *The Dialog Flow Definition*
 - *Custom Components*
- Translating skills. See *Languages and Skills*.

Export and Import Skills

You can export a skill from one environment, and import it to another one.

Note: You can export only custom skills or the predefined skills that were extended, not the installed skills.

1. Sign in to the source environment, where you want to export a skill from.
2. Click **Navigator > Development > Skills**.
3. Search for the skill that you want to export.
4. Click the **Options** icon for the skill that you want to export, and select **Export**.

Note: To export a specific version of a skill, click the **Click to show all versions of this skill**, click the **Options** icon for the version that you want to export, and then select **Export**.

5. Save the .zip file.
6. Sign out of your current session.
7. Sign in to the target environment, where you want to import the skill to.
8. Click **Navigator > Development > Skills**.
9. On the Skills page, click **Import Skill**.

Note: To import an extended skill, the target instance must have the corresponding base bot installed.

10. Browse and select the .zip file you want to import. You get a confirmation after the import is complete.

Set the Duration for User Session Timeout

You must use Oracle Cloud Infrastructure (OCI) identity domain and Oracle Digital Assistant applications to set the duration for session timeout.

In OCI identity domain, the duration is 7 days by default. So, if the users leave the application idle for 7 days, their session will expire. The duration for the session timeout can be the same in both the applications, but if it isn't, then the minimum duration is applied.

Here's how you can set the duration for session timeout using OCI identity domain:

1. Sign in to Oracle Cloud Console.
2. On the console, from the **Identity domain** menu, click **Oracle Cloud Services**.
3. On the Oracle Cloud Services page, search and open your ODA application instance provisioned on your identity domain.

Tip: You can search for **idcs-oda**.

4. On the ODA application instance, click OAuth Configurations tab from the **Resources** menu.
5. In the Resources section, select the **Is Refresh Token Allowed** checkbox if it's not selected.
6. In the **Refresh Token Expiration** field, enter the duration in seconds.
7. Click **Save**.

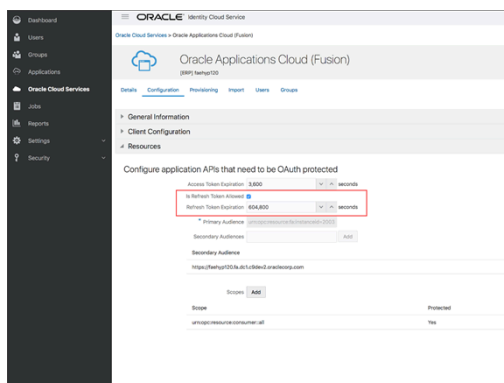

Here's how you can set the duration for session timeout using Oracle Digital Assistant:

1. Sign in to Oracle Digital Assistant.
2. Click **Navigator > Settings > Authentication Services**.
3. Select the service that you want to set the duration for.

4. In the **Refresh Token Retention Period** field, enter the duration in days. The maximum timeout duration you can set is 30 days.

Your changes are saved automatically.

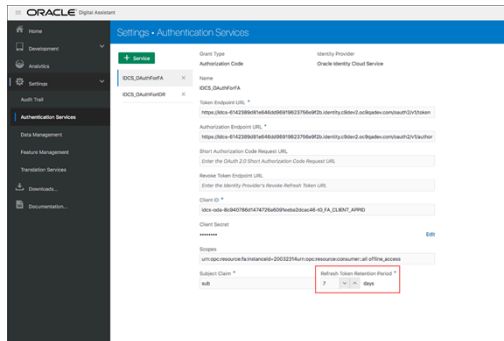

FAQs for Configuration of Digital Assistant

Why can't I access Oracle Cloud Console to configure a digital assistant?

That's probably because you don't have the FA_GSI_Administrator role assigned to you.

Check with your primary administrator who can access Oracle Cloud Console and get you a cloud administrator account with the FA_GSI_Administrator role assigned, but only for these cases:

- You're are the existing administrator, and you can't sign in to Oracle Cloud Console or have lost your password.
- The existing administrator is no longer available, for example, they're no longer working for your company.
- The cloud account user or user name isn't part of the IDCS_ADMINISTRATORS group for the particular IDCS stripe.

Note: If the credentials are used to sign in for the first time and the user or user name isn't part of the IDCS_ADMINISTRATORS group, then the user can only view Oracle Cloud console and can't view the ODA application instance provisioned on your identity domain to configure ODA.

The problem type for the request must be **Cloud Hosting Services (Outage, P2T/T2T, Enable SSO, Resize, CloudPortal, MyServices, User/Password, Network, Schedule Maintenance)**.

How can users sign in to the digital assistant?

The methods for signing in to the digital assistant vary based on the Oracle Identity Management setup for Oracle Fusion Cloud Applications.

- Single Sign-On: If SSO is enabled for Fusion Applications

- Single Sign-On with two-factor authentication: If SSO is enabled with two-factor authentication for Fusion Applications
- Fusion Applications user ID and password: If SSO isn't enabled for Fusion Applications

Note: Your users can use any of these methods even if VPN is enabled.

How to add FA_GSI_Administrator role to a user?

You need the FA_GSI_Administrator role to set up ODA. To add this role, do these steps:

1. Open your Oracle cloud account url in your browser. For example, <https://cloud.oracle.com/identity/domains/?tenant=icorinternal&domain=Default®ion=us-phoenix-1>. Here the tenant name is your cloud account name.
2. On the Oracle Cloud Account Sign In page, enter your cloud account user name and the password that you configured during the cloud account activation and click **Sign In**.
3. On Oracle Cloud Console, go to the **Compartment** drop-down list on the navigation menu, and select your compartment.
4. On the Domains page, select your domain.
5. On the console, from the **Identity domain** menu, click **Oracle Cloud Services** to view all the instances.
6. On the Oracle Cloud Services page, search and open Oracle Applications Cloud (Fusion).
7. On the Oracle Applications Cloud (Fusion) instance, click the Application Roles tab from the **Resources** menu.
8. Select FA_GSI_Administrator role and click the corresponding downward dropping arrow and then click the **Manage** link for Assigned users.
9. On the Manage user assignments dialog box click the **Show available users** link.
10. From the Available users section, search for the required user name, select it, and click **Assign** to grant the FA_GSI_Administrator role to the user.

Can I use the same Twilio number for the custom skills and the digital assistant?

Yes, you can do so. But you must first add your custom skills to the digital assistant and then configure the Twilio SMS channel.

What happens if I add a custom skill to a digital assistant, and then upgrade the digital assistant?

There won't be any impact on your custom skill. When you upgrade the digital assistant, the upgraded version will contain the predefined and custom skills that you already added to your digital assistant.

Note: When a digital assistant is upgraded to the latest platform version, the custom skill will need to be in the same platform version for it to be added to FADigitalAssistant.

What are the different channels available in the digital assistant?

This table lists the different skills and the supported channels.

Skill	Description	Channels Supported
Expenses	You use this skill to do your day-to-day expenses-related tasks.	<ul style="list-style-type: none"> Oracle Web Microsoft Teams Twilio SMS
Project Time Entry	You use this skill to record your project-based time entries and submit time cards.	<ul style="list-style-type: none"> Microsoft Teams Twilio SMS
Project Management	You use this skill to do your project management activities, such as view and update tasks, deliverables, issues, and action items. You can also check the project progress and financial status.	<ul style="list-style-type: none"> Microsoft Teams Twilio SMS
CX Sales	You use this skill to do your day-to-day sales-related tasks.	<ul style="list-style-type: none"> Microsoft Teams
Internal Candidate Experience	You use this skill to help your employees to search for jobs, check their application status, and withdraw their application.	<ul style="list-style-type: none"> Oracle Web Microsoft Teams Twilio SMS
Hiring	You use this skill to help your recruiters and the hiring team to check requisition status and candidate status and review any pending offers.	<ul style="list-style-type: none"> Oracle Web Microsoft Teams Twilio SMS
HcmV2	You use this skill to start manager or employee self-service transactions and to clarify your employment-related questions.	<ul style="list-style-type: none"> Oracle Web
Candidate Experience V2	You use this skill to search for jobs, check their application status, and withdraw their application.	<ul style="list-style-type: none"> Oracle Web
Helpdesk	You use this skill to clarify the queries of your employees.	<ul style="list-style-type: none"> Oracle Web