

Oracle Taleo Enterprise Edition

Implementing Career Section

24B

This software and related documentation are provided under a license agreement containing restrictions on use and disclosure and are protected by intellectual property laws. Except as expressly permitted in your license agreement or allowed by law, you may not use, copy, reproduce, translate, broadcast, modify, license, transmit, distribute, exhibit, perform, publish, or display any part, in any form, or by any means. Reverse engineering, disassembly, or decompilation of this software, unless required by law for interoperability, is prohibited.

The information contained herein is subject to change without notice and is not warranted to be error-free. If you find any errors, please report them to us in writing.

If this is software or related documentation that is delivered to the U.S. Government or anyone licensing it on behalf of the U.S. Government, then the following notice is applicable:

U.S. GOVERNMENT END USERS: Oracle programs (including any operating system, integrated software, any programs embedded, installed or activated on delivered hardware, and modifications of such programs) and Oracle computer documentation or other Oracle data delivered to or accessed by U.S. Government end users are "commercial computer software" or "commercial computer software documentation" pursuant to the applicable Federal Acquisition Regulation and agency-specific supplemental regulations. As such, the use, reproduction, duplication, release, display, disclosure, modification, preparation of derivative works, and/or adaptation of i) Oracle programs (including any operating system, integrated software, any programs embedded, installed or activated on delivered hardware, and modifications of such programs), ii) Oracle computer documentation and/or iii) other Oracle data, is subject to the rights and limitations specified in the license contained in the applicable contract. The terms governing the U.S. Government's use of Oracle cloud services are defined by the applicable contract for such services. No other rights are granted to the U.S. Government.

This software or hardware is developed for general use in a variety of information management applications. It is not developed or intended for use in any inherently dangerous applications, including applications that may create a risk of personal injury. If you use this software or hardware in dangerous applications, then you shall be responsible to take all appropriate fail-safe, backup, redundancy, and other measures to ensure its safe use. Oracle Corporation and its affiliates disclaim any liability for any damages caused by use of this software or hardware in dangerous applications.

Oracle and Java are registered trademarks of Oracle and/or its affiliates. Other names may be trademarks of their respective owners.

Intel and Intel Inside are trademarks or registered trademarks of Intel Corporation. All SPARC trademarks are used under license and are trademarks or registered trademarks of SPARC International, Inc. AMD, Epyc, and the AMD logo are trademarks or registered trademarks of Advanced Micro Devices. UNIX is a registered trademark of The Open Group.

This software or hardware and documentation may provide access to or information about content, products, and services from third parties. Oracle Corporation and its affiliates are not responsible for and expressly disclaim all warranties of any kind with respect to third-party content, products, and services unless otherwise set forth in an applicable agreement between you and Oracle. Oracle Corporation and its affiliates will not be responsible for any loss, costs, or damages incurred due to your access to or use of third-party content, products, or services, except as set forth in an applicable agreement between you and Oracle.

Contents

Preface	i
<hr/>	
1 Getting Started	1
Career Section Overview	1
Login	2
Getting Help	2
Menus and Navigation Tools	3
Basic Concepts	7
Important Changes to the Sign in with Google Service	15
Settings Required to Enable Single Sign-On	15
2 Accessibility	17
Accessibility in the Career Section: Overview	17
Accessibility Best Practices for Career Section	17
Job Application Flow: Example	18
3 Statements	21
Statement Management	21
4 Forms	31
User-defined Forms	31
Diversity Form	39
Documents	51
5 Application Flow	59
Application Flow	59
Progress Bar	82
6 Career Sections	85
Career Section	85
Career Section Components	88

Career Portal Pages	98
Career Sections - Other Configuration Tasks	116
Onboarding (Transitions) Tasks in Career Sections	125
Candidate Communication Agent	135
Technical Help Information	137
Career Section Sequence	140
Public or Private Career Sections	141
Masking Personal Information	142
Linking Standard Career Sections to Mobile Career Sections	143
Displaying All Candidate Submissions in the My Referrals Tab	149
7 Career Portal Brand	151
Portal Brand	151
8 Theme	165
Theme	165
9 General Configuration	215
Career Section URL	215
Personalized Job List Matching Criteria	219
Requisition Status	220
Job Submission Status	225
Matched Candidate Display	233
Agent Confirmation Request	236
Secure Message Delivery with the Message Center	237
Keyword Search	239
Help Panel	239
Apply as Guest	242
Single Sign-On	243
10 Security	265
Security	265
Career Section Security Settings	271
11 Social Media	281
Apply with LinkedIn 2.0	281

Twitter	293
Taleo Social Sourcing	294
Jobs in Google Search Results	295
12 Candidate File Import	297
Candidate File Import	297
13 Metrics	303
Metrics	303
14 Product Resource Administration	307
Resource Administration	307
Changing Career Section Resources	310
15 Appendix	313
Career Portal Page Field Identification Numbers	313
Original Submission Medium and Latest Submission Medium	423

Preface

This preface introduces information sources that can help you use the application and this guide.

Oracle Applications Guides

To find guides for Oracle Applications, go to the Oracle Help Center at <http://docs.oracle.com/>.

Documentation Accessibility

For information about Oracle's commitment to accessibility, visit the [Oracle Accessibility Program website](#).

Diversity and Inclusion

Oracle is fully committed to diversity and inclusion. Oracle respects and values having a diverse workforce that increases thought leadership and innovation. As part of our initiative to build a more inclusive culture that positively impacts our employees, customers, and partners, we're working to remove insensitive terms from our products and documentation. We're also mindful of the necessity to maintain compatibility with our customers' existing technologies and the need to ensure continuity of service as Oracle's offerings and industry standards evolve. Because of these technical constraints, our effort to remove insensitive terms is ongoing and will take time and external cooperation.

Comments and Suggestions

Access to Oracle Support

Oracle customers that have purchased support have access to electronic support through My Oracle Support. For information, visit [My Oracle Support](#) or visit [Oracle Accessibility Learning and Support](#) if you are hearing impaired.

Comments and Suggestions

Please give us feedback about Oracle Applications Help and guides! You can send an e-mail to: talent_acquisition_doc_feedback_ww_grp@oracle.com.

1 Getting Started

Career Section Overview

Career Sections are the candidate-facing portion of Taleo Enterprise. It is potential employees' first glimpse into an organization.

Candidates interact with the Career Section of an organization's corporate Web site when they apply for a job, create a profile, refer others to the organization, or manage their accounts. An organization can have multiple Career Sections with distinct branding, for example, to distinguish the organization's different divisions, to separate external applicants from internal applicants, or to support the organization's international presence. Each Career Section is accessed by a different URL. Once candidates complete a job application or submit a profile, they have access to the Candidate Career Portal Pages within the Career Section. Career Portal Pages display information that pertains to the candidate, such as the candidate's own job submissions and profile.

Here is a typical workflow of how candidates access a Career Section. Candidates access the Careers area of an organization's Web site and then begin reviewing the job list or conduct a search to find job openings. Once candidates have run a search for an opening, the Job List appears. Candidates can click the Job Title link to learn more about the position. Once candidates have found a desired position, they can apply for the job. Candidates complete information presented in different pages, such as personal information, experience, references. These pages are called the application flow. Once candidates complete a page in an application flow, the progress bar can be used to return to a previous page in the flow. Once candidates have created a general profile or submitted a job-specific application, they have access to the Career Portal Page which provides access to the candidate general profile, completed job submissions, saved job searches, etc.

Career Section system administrators are responsible of building career sections and controlling the experience of candidates while they apply for a job or submit a general profile. Career Sections are assembled using the following elements:

- Career sections are made up of application flows.
- Application flows are made up of pages.
- Pages contain blocks. Pages are the individual Web pages that candidates complete.
- Blocks are added to a page of an application flow. Examples of blocks are statements, Diversity forms.
- Fields are added to blocks.

Other elements such as branding, theme, settings, must also be configured by Career Section system administrators.

Login

Login Procedure

When users open the Oracle Taleo Enterprise Edition solution, the User Sign In page is typically displayed.

On the Sign In page, users can select the language in which they want to use the application. If users change the default language on the Sign In page, the page is displayed in the new language and subsequent Oracle Taleo Enterprise Edition product pages are presented in that language. After selecting a language, users can also instruct the system to "remember" their selection so that the next time they sign in, the User Sign In page will be presented in the language they selected.

If single sign-on (SSO) is not enabled within an organization, users must enter a user name and password on the user Sign In page. The user name and password are provided by system administrators. Users can modify their password. If SSO was configured through a consulting engagement (which requires a statement of work (SOW)), the Sign In page is not displayed and the default language that was configured is used.

Once a user's credentials are accepted, the *Welcome Center* or table of contents page is displayed. The Oracle Taleo Enterprise Edition products available for use are dependent on which products were purchased by the organization and on the user's user type and permissions. If a user has permission to see only one Oracle Taleo Enterprise Edition product and the Display Welcome Center setting is set to "Yes", the product is displayed directly.

The Welcome Center

The Welcome Center is the page displayed immediately after you sign in.

The Welcome Center is organized in these areas:

- The auxiliary navigation bar provides links to the online help and your personal setup options.
- The core navigation bar contains tabs to Oracle Taleo Enterprise Edition products.
- The Quick Access panel provides a "one-click" access to the same products available in the core navigation bar. It also provides access to specific content such as a requisitions and submissions.
- In the central panel, your organization can put information of interest to all product users.

Getting Help

Online Help

The administration module offers an online help that provides comprehensive information about concepts or tasks to perform.

The online help, represented by the Question Mark icon or the [Help](#) link, is available in the auxiliary navigation bar located in the top right-hand corner of all pages. When clicking the icon or link, a table of contents of available help topics is displayed. It is also possible to search the help database to locate specific subjects.

Support Link

The Support link gives users access to the My Oracle Support.

The Support link is available in the auxiliary navigation bar of all pages of the application. From the site, you can:

- Search and browse the Knowledge database.
- Obtain product documentation.
- Submit an incident.

Tooltip

A tooltip is a short, explanatory text which appears when "hovering" a mouse over a button, a link, a table cell heading or icon without clicking it.

Tooltips are available throughout the system and they give additional information about an action before performing it. Tooltips are provided for buttons, links, icons, and table header cells. These tooltips are not configurable. However, for screening services, the system administrator can create tooltips for some types of user-defined fields.

Menus and Navigation Tools

Configuration Menu

The Configuration menu gives system administrators access to all administration components of Taleo Enterprise products in one centralized menu.

The Configuration menu is composed of sub-administration menus divided into two main sections:

- **Central Configuration:** Elements in the Central Configuration menu are used to manage content, data, settings, and configurations that are used across multiple products.
- **Specific Configuration:** Elements in the Specific Configuration menu are used to manage content, data, settings, and configurations that are targeted to a specific product or product area.

Depending on the products activated within your organization, the content of the Configuration menu may vary.

Central Configuration	Description
Operations	Operation Modes and Release Notes.

Central Configuration	Description
General Configuration	Settings and Welcome Center Content.
Selection Lists	Standard selections used in different products such as Education Levels, Employee Statuses, etc.
Roles	Role definitions of both hierarchical and functional roles. Both role types are used for the Dynamic Approval Routing feature. In addition, functional roles are used in defining onboarding tasks.
Dynamic Approval Routing	Approval workflow definitions for requisitions and offers according to specified business rules.
Security	Security policies, message templates related to access and passwords, and legal agreements presented to users when signing in an application. Note that agreements for career sections are managed under Career Section Administration.
Competencies	Competency tools used in Taleo Performance for Rating Models, Competencies, Guidance Plans, etc.
Synchronization Tool	A tool to export configuration elements, such as career sections, application flows, etc., from a source database to a target database.

Specific Configuration
SmartOrg
Recruiting
Career Section
Onboarding
Onboarding (Transitions)
Taleo Performance
Evaluation Management
Reporting and Analytics

Configuration

The *Access Administration* permission is required to access the Configuration menu.

User Type Permission	Location
Access Administration	Configuration > [SmartOrg] Administration > [Users] User Types > Recruiting > Administration

Career Section Administration Menu

The Career Section Administration menu allows system administrators to fully configure Career Section features.

Element	Description
<i>Career Sections</i>	Manages the creation of career sections.
<i>Application Flows</i>	Manages application flows.
<i>User-defined Forms</i>	Manages forms used in application flows.
<i>Diversity Forms</i>	Manages Diversity forms such as EE and EEO used in career sections.
<i>Statements</i>	Manages statements such as Privacy Agreement, eSignature, Background Check Consent, Diversity (EE/EEO).
<i>Documents</i>	Stores PDF files loaded into the Taleo system.
General Configuration	Manages global career section settings, URLs for a specific career section page, personalized job lists (criteria used to determine when a match is to be made between a job-specific requisition and a candidate), requisition status configuration, job submission status configuration, matched candidate display.
<i>Corporate Brands</i>	Manages career portal brands which provide the control over the look and feel of each career section.
<i>Themes</i>	Manages themes that is CSS fonts, font sizes, background color, etc.
<i>Global Security</i>	Manages global security settings such as SSL encryption, password, user accounts, sign in, etc.
Product Resources	Display of resource ID of user interface labels.

Configuration

The *Access Administration* permission is required to access the Career Section Administration menu.

User Type Permission	Location
Access Administration	Configuration > [SmartOrg] Administration > [Users] User Types > Recruiting > Administration

Auxiliary Navigation Bar

The auxiliary navigation bar is the bar located at the top right of pages.

If enabled, the auxiliary navigation bar is available at all times for users to see and access.

The content of the auxiliary navigation bar varies depending on the features enabled and permissions granted to users to access those features.





Element	Description
Home	<ul style="list-style-type: none"> If you have access to multiple Taleo products and you click Home, the Welcome Center is displayed. If you have access to Taleo Recruiting only and you click Home, the Recruiting Center front page is displayed.
Resources	May include: <ul style="list-style-type: none"> Setup: Access to personal preferences, account information, and general preferences. Support: Access to My Oracle Support. Help: Online help about career section configuration features. About: Information about the application such as the version number and the build number you need to provide to Oracle Support when you need to contact them.
Sign Out	Terminates the session and you are automatically signed out of all Taleo products.

Breadcrumb Trail

The breadcrumb trail located at the top of each page allows users to see where they are located within the application and to jump to previously viewed pages. The breadcrumb trail is only available in navigation mode; it disappears in edit mode.

Navigation Icons

When information is spread across multiple pages, navigation icons are available.

Icon	Description
	Displays the previous page.
	Goes to the previous 10 pages.
	Displays the next page.
	Goes to the next 10 pages.

Recently Viewed Items

The Recently Viewed Items panel contains direct links to the last ten pages you most recently accessed (according to your permissions) during the current session or previous ones. They can be pages where you made modifications or simply pages that you accessed without making modifications. To access a recently viewed item, simply click the item.

Basic Concepts

Application Time-out

A security feature warns users when the application has not been used for more than thirty minutes even if a user is still signed into the application. When the time-out delay is reached, a message notifies users that the time-out delay for the application is imminent.

Two scenarios are possible:

- User takes action: When the application has been idled for thirty minutes, a message notifies the user that the application requires attention. Clicking "Access the application" directs the user to the application. When the user accesses the application, the user can reset the application and a message indicates the remaining time before the session expires.
- User does not take action: If the user does not reset the application within the defined delay, a message is displayed, indicating that the user has been signed out of the application and has to sign in again to use the application.

The time-out delay is set by default to thirty minutes. The reminder displayed before time-out is set by default to ten minutes before time-out.

Session Sharing

Session sharing is not a supported feature, as it may cause data to be lost. Logging into more than one instance of the application in the same browser simultaneously, known as session sharing, is not supported in Taleo. When users log out of one open instance, the application will terminate all open sessions. Unexpected results may occur and the user will be directed back to the login screen. Any unsaved work will be lost.

System Status

A status indicates the current state of an element in the system.

Elements can have one of the following statuses:

- **Draft:** A Draft element can be modified. A Draft element cannot be used. The status must be made Active before it can be used.
- **Active:** When an element is Active, only the name and description can be modified. It is not possible to update the behavior of the element.
- **Inactive:** When an element is inactive it can be modified. An inactive element cannot be used. The status must be made active before it can be used.

A Draft element can become Active. An Active element can become Inactive. An Inactive element can become Active. However, an Active element cannot return to Draft status.

History Tracking

The History feature presents useful tracking details on an item.

The three most recent events are displayed in the History section. To view a more complete listing of events, click More Info.

History Item	Description
Date and Time	Date and time when an event occurred.
Event	Event or action performed on an element.
Details	Information regarding the event.
By	The "actor" (person or system) who performed the event.

Information of the user that performed an action on an item can be viewed for better tracking and troubleshooting purposes.

Note: History tracking of items such as settings and user types are not item specific. Tracking is global for all changes made in the area. This means if looking at a specific user type and going to view its history, you will see all of the history for all user type changes, not just the changes that have occurred with that specific user type.

Refine by Option

The Refine by option allows users to filter a list according to different criteria.

The Refine by option is available throughout the system. When an element is selected in the Refine by list, users have to enter data in a field or select an element by which the list will be filtered. The Refresh button must then be clicked to refresh the list.

Languages

Oracle Taleo Enterprise Edition products are available in different optional languages.

Not all languages are available for all Oracle Taleo Enterprise Edition products and languages must be activated by the system administrator before they can be used in an application.

The preferred language of a user is set in the user's account by the system administrator. The preferred language is used by the system as the default content language which is the same across all Oracle Taleo Enterprise Edition products. If a product does not support the same set of content languages, it will have its own preference configuration.

In Oracle Taleo Enterprise Edition applications, the languages in which an item is available are indicated in the Languages field. When creating or editing an item, the user can choose the base language as well as the languages in which an item will be available. The base language of an item is the item's reference language, usually used as a reference for other languages or fallback display in list mode. The user's preferred language is used as the default base language when the user creates an item. The base language of an item can be changed at any time by the user. A language must be activated before it can be designated as a base language.

When multiple languages are used for an item, the Earth icon is displayed. Hovering the mouse over the icon displays the languages activated for the item. When only one language is used for an item, the name of the language is displayed. When only one language is used in a company, there is no special indicator.

Supported Languages

The languages supported for Oracle Taleo Enterprise Edition products as well as specific features are listed below. For details regarding language availability for Oracle Learn Cloud and Oracle Taleo Business Edition, see the documentation for those products.

- **Assessment:** All listed languages are supported except Indonesian (Bahasa).
- **OBIEE (Oracle Business Intelligence and OAS (Oracle Analytics):** All listed languages are supported except Indonesian (Bahasa), Lithuanian, Malaysian (Malay), Serbian, Slovenian.
- **Resume Parsing:** Resume parsing is delivered using a third party partner service. The functionalities are delivered as-is. Customers needing additional or different resume parsing capabilities should explore partner services.

Language	Locale	Recruiting and Onboarding	Performance	Mobile	Sourcing	Resume Parsing
Bulgarian	bg	Available	Available			
Simplified Chinese	zh_CN	Available	Available	Available	Available	
Traditional Chinese	zh_TW	Available	Available	Available	Available	
Croatian	hr	Available	Available			
Czech	cs	Available	Available		Available	

Language	Locale	Recruiting and Onboarding	Performance	Mobile	Sourcing	Resume Parsing
Danish	da	Available	Available			
Dutch	nl	Available	Available	Available	Available	Limited
English	en	Available	Available	Available	Available	Supported
English (U.K.)	en_GB	Available	Available	Available	Available	Supported
Finnish	fi	Available	Available		Available	
French (Canada)	fr	Available	Available	Available		Limited
French (France)	fr_FR	Available	Available	Available	Available	Limited
German	de	Available	Available	Available	Available	Limited
Greek	el	Available	Available			
Hungarian	hu	Available	Available		Available	
Italian	it	Available	Available	Available	Available	Limited
Indonesian (Bahasa)*	in	Available	Available	Available		
Japanese	ja	Available	Available	Available	Available	
Korean	ko	Available	Available	Available	Available	
Lithuanian*	lt	Available	Available			
Malaysian (Malay)*	ms	Available	Available			
Norwegian	no	Available	Available		Available	
Polish	pl	Available	Available	Available	Available	
Portuguese (Brazil)	pt_BR	Available	Available	Available	Available	Limited
Portuguese (Portugal)	pt	Available	Available		Available	
Romanian	ro	Available	Available		Available	
Russian	ru	Available	Available	Available	Available	
Serbian*	sr (sh)	Available	Available			
Slovak	sk	Available	Available		Available	
Slovenian*	sl	Available	Available			
Spanish (Worldwide)	es	Available	Available	Available	Available	Limited
Swedish	sv	Available	Available	Available	Available	
Thai	th	Available	Available		Available	

Language	Locale	Recruiting and Onboarding	Performance	Mobile	Sourcing	Resume Parsing
Turkish	tr	Available	Available		Available	

Selecting the Base Language

Before you start

Language must be active.

If only one language is activated, the base language option is not displayed.

Here's what to do

1. Edit an element.
2. In the Activated Languages drop-down list, select Configure.
3. Select the Base option for the desired language.
4. If necessary, select Active in the Status drop-down list.
5. Click Save.

Results:

The word Base appears next to the language in the Activated Languages drop-down list.

Activating a Language

Before you start

The item must be in Edit mode.

Here's what to do

1. Open the item that you want to make available in another language so its fields are in edit mode.
2. Select Configure next to the Language drop-down list.
3. On the Language Configuration page, select Active from the Status drop-down list for each required language.
4. Click Save.

Results:

Activated languages appear in the Language drop-down list of item.

What to do next

Once a new language has been enabled, values for some related fields (most often Name) will need to be provided.

Deactivating a Language

Before you start

The item must be in Edit mode and the language must not be the base language.

Here's what to do

1. Open an item.
2. Select Configure next to the Language drop-down list.
3. For each language, select Not Used in the Status drop-down list.

If the language to deactivate is the Base language, you will need to select another active language as the base language.

4. Click Save.

Results:

Selected languages no longer appear in the Language drop-down list of the item.

Information Added Automatically to Other Language Versions of Candidate Profile

When candidates fill out a candidate profile in a new language for the first time, fields in the new language are prepopulated with the profile information from the language version the candidates updated most recently.

When candidates have a profile in at least one language, the first time they apply for a job in a new language or begin a profile flow in a new language, they fill in fields resulting in the creation of the candidate profile in the new language. Part of the process involves entering some information manually that does not vary from one language to another. The values of certain fields in the most recently updated language version of the profile are reproduced automatically in the new language version of the profile. Candidates can keep the values added to the new language version of the profile or they can modify them according to their needs.

Take the case of a candidate who speaks English, Spanish and German and has a candidate profile in English and in German. The German version was updated most recently. If the person applies for a job posted on the Spanish career section or updates his/her profile so it includes a Spanish version, fields in such sections as Education, Work Experience and Certifications will be prepopulated with values he or she entered in the German version of the candidate profile. The information is copied as soon as a job application flow or candidate profile flow is started in a particular language for which there is no existing profile in that language. Conversely, if candidates edit a candidate profile in a particular language, the current values are not updated automatically with values from another language version of the candidate profile (this is by design).

Values from the following fields from the most recently updated candidate profile are reproduced in each additional language candidate profile at creation: Education, Work Experience, Certifications, Plain Text Resume, Plain Text Cover Letter, Additional Information.

Fundamental Data Structure: Organization-Location-Job Field (OLF)

The data structure enables each customer to customize Oracle Taleo Enterprise Edition products such that they reflect how the customer does business. Each customer's organization is defined as a combination of three main elements: Organizations, Locations, Job Fields (OLF). OLF is also referred to as contextualization.

Organization describes the hierarchical structure of an organization. Up to 20 organization levels can be created. The system proposes the following organization structure, but other terms may be chosen to better reflect the hierarchical structure of a company:

- Company
- Sector
- Department
- Division

Location represents a geographical area, such as a country or state. Locations are listed in a hierarchical order, from the broadest geographical area (often a country) to increasingly specific areas (work location). Up to 5 location levels can be created. Locations must be associated to network locations used for various purposes, mainly integration with external systems, using a common and standard universal structure. Oracle strongly recommends defining a zip code for the location. A common location structure is:

- Country
- State/Province
- Region
- City
- Work Location

Worker locations can be mapped to the Location structure. The worker location is used as an employee (post-hire) function whereas the location (in OLF) is meant for recruiting purposes. For example, a location could be 100 Main Street and a worker location could be "Sector 44" or "Cubicle A". Worker locations are not created in Configuration. Worker locations are typically imported from an external HRMS system. Once worker locations are imported, worker locations can be mapped to the Location structure via Integration or by the system administrator in Configuration. Any Location element can be given the Worker Location and the Worker Location Address properties. System administrators can then configure worker locations to appear in requisitions, offers, correspondences, requisitions lists, and candidates lists just like any other fields. For details, see Worker Location.

Job Field represents the employment sectors or domains. Up to 4 job field levels can be created. Job fields must also be mapped to the network job fields, again to have a common language with the external world, be for posting or integrations. This mapping also serves to inherit existing classification for competencies. The system proposes the following job field structure, but other terms may be chosen to better reflect the structure of a company:

- Category
- Function
- Specialty

Contextualization, that is the Organization-Location-Job Field structure associated to an element, represents the framework the application uses to organize, classify, link, match or search for information in the application. Although Organization-Location-Job Field structures are configured with the help of an Oracle representative during the implementation phase, modifications to structure elements can be done in maintenance mode at any time. It is possible to customize the system to reflect a company's unique structure and make modifications to Organization-Location-Job field elements in real time so that the data accounts for any changes in the structure.

There are several key elements of the Oracle Taleo Enterprise Edition products that are tied to the Organization-Location-Job field structure such as candidate selection workflows, requisitions and requisition templates, message templates, user management, prescreening, approvals, etc.

The purpose of contextualizing an element is to make the element relevant according to a specific context. Below is an example of contextualization with candidate selection workflows. The CSW1 would not be available to the user for this requisition, because the last level of its Location does not match that of the requisition. The CSW2 could be available to the user for this requisition. The parent element of the lowest level of the requisition for each dimension (Organization, Location or Field) must be the same as the lowest level of the workflow for each dimension.

Example:

Requisition:

- Organization: Urban transportation
- Location: United States/California/Los Angeles
- Job Field: Bus driver

CSW1:

- Organization: Urban transportation
- Location: United States/California/San Jose
- Job Field: Bus driver

CSW2:

- Organization: Urban transportation
- Location: United States
- Job Field: Bus driver

When using contextualization, the system applies the AND operator between Organizations, Locations and Job Fields entities. However, the OR operator is applied between elements of the same entity.

In the following example, a field would be displayed if Canada (or any of its children) AND Architecture were selected.

- Location: Canada
- Job Field: Architecture

In the following example, a field would be displayed if Canada AND Architecture were selected, or if United States AND Architecture were selected.

- Location: Canada
- Location: United States
- Job Field: Architecture

Important Changes to the Sign in with Google Service

A change to the Sign in with Google service used by candidates to register and sign in to the Taleo Career Section requires your action to maintain continued service.

Google is replacing their existing Sign in with Google service with Sign in with Google+. Google requires vendors, such as Oracle, to replace the existing Sign in with Google authentication method with the newer Sign in with Google+ authentication method to avoid user disruption.

All customers are impacted by Google's changes. Customers who are currently using the Sign in with Google service must upgrade to Taleo 15A or 14B.3 or higher and undergo configuration steps to enable the Sign in with Google+ service prior to Google's deprecation of the Sign in with Google service, scheduled for April 20, 2015. If the Sign in with Google+ service is not enabled, candidates using their Google credentials to sign into a customer's career section will lose the ability to access their accounts. Customers who are not currently using the Sign in with Google service but wish to allow candidates to login using Google credentials in the future must also upgrade to Taleo 15A or 14B.3 or higher and undergo the same configuration steps to enable the Sign in with Google+ service.

Instructions on how to configure Google+ feature are provided here: [Setting Up Google+ Login if Upgrading to Release 14B.3, 15A or Higher.](#)

Settings Required to Enable Single Sign-On

To enable Single Sign-On (SSO), specific settings must be configured.

The setting Use the following authentication method must be set to Single Sign-On.

Though not a requirement to implement SSO, it is recommended that the following two settings be set to Yes.

- Require users to sign in before accessing the Job List: Yes.
- Require users to sign in before accessing job descriptions: Yes.

This ensures that only internal candidates and employees can view the job list and job descriptions on the internal career section. If the settings are set to No, external candidates who happened to know the URL could view the job list and job descriptions.

Configuration

Setting	Location
Use the following authentication method	Configuration > [Career Section] Administration > Internal Career Sections > [Default Values] Show > [User Accounts] Edit
Require users to sign in before accessing the Job List	Configuration > [Career Section] Administration > Internal Career Sections > [Default Values] Show > [Security Settings] Edit

Setting	Location
Require users to sign in before accessing job descriptions	Configuration > [Career Section] Administration > Internal Career Sections > [Default Values] Show > [Security Settings] Edit

2 Accessibility

Accessibility in the Career Section: Overview

The following content outlines the recommended practices and configurations customers should consider when setting up their Career Section for delivering candidates an experience aligned with accessibility standards.

Note that the recommended practices outlined below are not a certification of configurations. Customers are ultimately responsible for configuring and testing their Career Section to align it with accessibility requirements.

Oracle has published a Voluntary Product Accessibility Template (VPAT) document for the Oracle Taleo Enterprise Edition Career Section product. For more information about Oracle's VPATs, visit [Product Status \(VPATs\) website](#).

Note: Customers are responsible for ensuring customizations (e.g., via custom branding, css, JS, etc) they (or third-parties) make to the product align to accessibility standards.

Accessibility Best Practices for Career Section

Areas of the product that can be configured to align with accessibility standards include:

- Branding
- Theme
- Career Section content
- Job description content
- Basic Search page
- Job Details page
- Job application flow

Branding

Branding allows you to customize the look and feel of the frame surrounding the area displaying the job listings, that is the header, footer, and site navigation. You may need to consider adjusting the font size, font style, color contrast, text size, and layout of screen elements to make them larger and more prominent. For details about branding configuration, see [Career Portal Brand](#).

Theme

Theme allows you to customize the overall look and feel of the Career Section. Consider using colors that provide the recommended contrast ratio. This includes the configuration of font colors and background colors. Align the colors

of the theme so they match the element definition set in the branding file. For details about theme configuration, see [Theme](#).

Career Section Content

You can adjust labels on the Career Section to provide clear directions to users. This includes labels on pages, tabs, links, and buttons. When creating or updating page content, consider accessibility guidelines for link purpose, headings, labels, use of color, and sensory characteristics to deliver a more accessible experience to users. For details about career section content, see [Career Portal Pages](#).

Job Description Content

When you write the job description, make sure the description aligns with accessibility guidelines.

Behaviors Aligned with Accessibility Guidelines

Below are behaviors of the Career Section basic search, job details, and job application flows aligned with accessibility guidelines. It does not include custom or referenced content.

- **Images:** Images on the Basic Search page, Job Details page, and application flow contain alternative text describing the image.
- **Headings, Titles, Labels:** Headings, titles, and labels on the Basic Search page, Job Details page, and application flow make the purpose of the screens clear to the users. They are also presented in a manner that help users understand the context of the page they are currently viewing.
- **Event Notification and Error Handling:** Errors and notifications displayed on the Basic Search page, Job Details page, and application flow are presented using ARIA alerts.
- **Labels for Controls:** Controls on the Basic Search page, Job Details page, and application flow have labels that help users understand the controls being presented.
- **Instructions do not Rely on Sensory Characteristics:** Instructions provided on key parts of the Basic Search page, Job Details page, and application flow do not rely on sensory characteristics such as shape and color.
- **Logical Reading Sequence:** The content displayed on the Basic Search page, Job Details page, and application flow is presented in a logical manner. Assistive technology understands and presents content of these pages in a logical manner.
- **Logical Tab Order:** Keyboard users can tab through elements on the Basic Search page, Job Details page, and application flow in a logical order. These pages do not contain keyboard traps.
- **Skip Navigation Links:** Keyboard users can skip to the main content of the Basic Search page, Job Details page, and application flow, allowing them to efficiently navigate through a page.
- **Keyboard:** Users can navigate the Career Section without a mouse and access all relevant functionality using only the keyboard.

Job Application Flow: Example

Example of what a job application flow aligned with accessibility guidelines could look like.

Use Basic Search

Use Basic Search to provide an accessible experience for users using assistive technology. This will provide candidates the ability to search for jobs, review the results page, and navigate into job details.

With Basic Search, candidates can search for jobs using criteria such as the job number, the job field, the location, review the results page, and view job details. For details about Basic Search, see [Career Portal Pages](#).

View Job Details and Apply for Job

Candidates can view job details and apply for the job. When candidates apply for a job, they enter the job application flow and go through a sequence of pages that they must complete.

Configure Job Application Flow

Configure the job application flow to include these key sections:

- Profile Upload
- Candidate Personal Information
- Education
- Work Experience
- E-Signature
- Review and Submit

The **Profile Upload** page enables candidates to import their resume into the career section. If a resume is selected, the system parses the resume into available fields. If LinkedIn and Indeed profile import options are configured, candidates can import information that they have stored on their external social profiles into the job application flow.

Note: Third party service providers such as LinkedIn or Indeed are not owned by Oracle. Any issues with the services provided must be logged and worked through with these third party service providers.

The **Candidate Personal Information** page enables candidates to provide their personal information data. The information typically collected in this page includes:

- First name and last name
- Address
- Phone number
- Email address

The **Education** page enables candidates to provide education information. The information collected in this page includes:

- Institution
- Program / Major
- Education level (e.g., Master, PhD)
- Start date and end date

The **Work Experience** page enables candidates to provide their work experience. Candidates can add more employers as necessary. The information collected in this page includes:

- Employer
- Job function
- Start date and end date

The **E-Signature** page enables candidates to validate that they agree to the privacy policy of the employer. Candidates must sign their name and enter an additional piece of information such as the zip code to sign the agreement.

The **Review and Submit** page enables candidates to review and validate the information they submitted. Candidates can edit and update the information as necessary.

The last page on the job application flow is the Thank You page. This page confirms that the information provided by the candidate was submitted.

3 Statements

Statement Management

Statement

Statements are paragraphs containing legal language that appear above the Diversity form, background check consent form and eSignature form. Privacy statements also contain legal language but they are attached directly to a specific career section and are not placed in an information block.

The creation and management of statements is performed in the Statements section of the Career Section Administration menu. Four types of statements can be used in an application flow:

- **Privacy Agreement:** A privacy agreement informs candidates of what the organization can and cannot do with the information candidates provide. It is the only statement that can be attached to a career section outside of an application flow. For example, an organization might want candidates to indicate their agreement with the privacy statement before the latter begin an application process rather than have them indicate agreement within an application flow. Candidates who decline the privacy agreement cannot proceed and no record of them is retained.
- **eSignature:** The eSignature statement is part of an information block comprised of an eSignature statement and an *eSignature form*. The eSignature statement provides an explanation regarding an eSignature form that candidates electronically sign while completing their job submission. Once candidates have saved the eSignature information, the eSignature area cannot be edited. Each job submission will have a unique eSignature and the system will save the eSignature information on the Tracking tab of each candidate's record. This information is also stored for reporting purposes.
- **Background Check Consent:** Your organization might want to include a statement whose purpose is to obtain candidates' consent to having a background check performed.
- **Diversity (EEO/EE):** The diversity statement is part of an information block composed of a diversity statement and a *Diversity form*. Candidates can read the diversity statement to learn about your organization's diversity policy. Though a Diversity form includes diversity questions such as gender and race, each of these components is created separately. All organizations that collect EE and EEO information can customize the diversity statement that is displayed above the Diversity form.

When you create legal statements, you can associate statements to locations and organizations. By doing so, a specific statement is displayed only if the locations and/or organizations of the requisition match the location and/or organizations of the statement. A statement can also be associated with one or several career section types, that is Internal, External, Agency Portal, Onboarding Portal. For example, if a privacy agreement statement is only associated with the Agency Portal career section type, it will be unavailable for Internal career sections.

Note: Even though the diversity, background check consent and eSignature statements can be associated with an Agency Portal career section type, these blocks cannot be included in the Agency flow and therefore associating these statements with an Agency Portal will have no effect.

You can choose to display a *privacy agreement* statement before the login page or registration page. In these cases, the context (organizations and locations) of the statement must match the context of the career section. If no privacy agreement statement is selected for a career section, no statement will be displayed before the login or registration pages.

A privacy agreement can also be displayed at the beginning of an application flow. You can choose to create a contextualized privacy agreement statement that will be displayed if it matches the requisition's organization, location and/or career section type.

- If no privacy statement exists for the context, the privacy agreement statement selected for the career section is displayed.
- If no privacy statement is defined and no contextualized privacy statement exists for the context, no statement is displayed at the beginning of the application flow.
- If a requisition is associated to multiple locations, all privacy statements are displayed. For example, if a job is available in the United States and in Canada and a privacy statement exists for each country, both privacy statements are displayed. The lowest level in the Location tree determines the display of the privacy statement. For example, if nothing is specified at level 4 for the location (City), then level 3 (State/Province) is considered. If nothing is specified at level 3, then level 2 (Country) is considered. If nothing is specified at level 2, then level 1 (World Region) is considered. If nothing is specified at level 1, the system displays the privacy agreement statement for the career section (if one was selected).

Each instance that a candidate agreed to a Privacy Agreement on the Career Section is captured helping to audit the Privacy Agreement terms that apply to your candidates. This allows you to identify which candidates agreed to which Privacy Agreements, at which points in time. The context of the agreement, such as the Career Section, job submission and language is also tracked.

Statements are not mandatory. For example, if no diversity statement is created and a Diversity block is used in an application flow, no statement is displayed. This is also true if the context of the statement does not match the context of the requisition.

Candidates, agents, and referrers need indicate their agreement only once with a specific privacy statement.

Creating Statements

The creation of a statement consists of the following steps.

1. *Creating the statement.*
2. *Associating the statement to a location.*
3. *Associating the statement to an organization.*
4. *Associating the statement to a career section type.*
5. *Adding paragraphs to the statement.*
6. *Creating paragraphs for the statement (optional).*
7. *Ordering paragraphs in the statement (optional).*
8. *Activating the statement.*

Creating a Statement

Before you start

The *Access the Career Section administration section* user type permission is required.

Configuration > [Career Section] Administration > Statements

Here's what to do

1. Click **Create**.
2. Select the language in which you want to create the statement.
3. Select a statement type, that is, Privacy Agreement, eSignature, Background Check Consent or Diversity.
4. Click **Save**.
5. Enter a code and a name.
6. Click **Save**.

Results:

Your statement is displayed on a read-only page with links to edit the properties and add locations, organizations, career section types, and paragraphs.

Associating a Location to a Statement

Before you start

The *Access the Career Section administration section* user type permission is required.

The statement must have Inactive or Draft status.

Configuration > [Career Section] Administration > Statements

Here's what to do

1. Click the name of the statement.
2. Click **Add** next to Locations.
3. Select one or several locations.
4. Click **Select**.

Results:

The statement is displayed only if the location of the requisition matches the location of the statement.

Associating an Organization to a Statement

Before you start

The *Access the Career Section administration section* user type permission is required.

The statement must have Inactive or Draft status.

Configuration > [Career Section] Administration > Statements

Here's what to do

1. Click the name of the statement.
2. Click **Add** next to Organizations.

3. Select one or several organizations.
4. Click **Select**.

Results:

The statement is displayed only if the organization of the requisition matches the organization of the statement.

Associating a Career Section Type to a Statement

Before you start

The *Access the Career Section administration section* user type permission is required.

The statement must have Inactive or Draft status.

Configuration > [Career Section] Administration > Statements

Here's what to do

1. Click the name of the statement.
2. Click **Add** next to Career Section Types.
3. Select one or several types of career sections.
4. Click **Select**.

Results:

The statement can be used for the specified career section types.

Adding a Paragraph to a Statement

Before you start

The *Access the Career Section administration section* user type permission is required.

The statement must have Inactive or Draft status.

Configuration > [Career Section] Administration > Statements

Here's what to do

1. Click the name of a statement.
2. Click **Add** next to Paragraphs.
3. Select one or several paragraphs.
4. Click **Select**.

Creating a Statement Paragraph

Before you start

The *Access the Career Section administration section* is required.

The statement must have only one language whose status is Active.

The statement must have Inactive or Draft status.

Configuration > [Career Section] Administration > Statements

Here's what to do

1. Click the name of a statement.
2. Click **Create** next to Paragraphs.
3. Select the language in which you want to create the paragraph.
4. Enter a code and a name.
5. Enter text for the paragraph. Use formatting tools if desired.

The paragraph can contain up to 16,000 characters. Translations must be supplied for each activated language of the statement and for each block included in the statement.

6. Click **Save**.

Results:

Paragraph is available in Paragraph Selector list and can be added to a statement.

Ordering Paragraphs in a Statement

Before you start

The *Access the Career Section administration section* user type permission is required.

Statement must have Inactive or Draft status.

Configuration > [Career Section] Administration > Statements

Here's what to do

1. Click the name of a statement.
2. Click **Reorder** next to Paragraph.
3. Select a paragraph and use the arrows to change the position of the paragraph.
4. Click **Save**.

Results:

The paragraphs are displayed in the selected order.

Activating a Statement

Before you start

The *Access the Career Section administration section* user type permission is required.

Configuration > [Career Section] Administration > Statements

Here's what to do

1. Click the name of a statement.

2. Click **Activate**.

Results:

The statement will be displayed to candidates whose context allows them to view the statement. The statement can no longer be deleted.

Statement - Other Configuration Tasks

Deleting a Statement

Before you start

The *Access the Career Section administration section* user type permission is required.

The statement must have Draft status.

Configuration > [Career Section] Administration > Statements

Here's what to do

1. Click **Delete** next to a statement.
2. Confirm the deletion.

Results:

The statement is permanently deleted from the database.

Deactivating a Statement

Before you start

The *Access the Career Section administration section* user type permission is required.

Configuration > [Career Section] Administration > Statements

Here's what to do

1. Click the name of a statement.
2. Click **Deactivate**.

Results:

The statement is no longer displayed to candidates.

Dissociating a Location from a Statement

Before you start

The *Access the Career Section administration section* user type permission is required.

The statement must have Inactive or Draft status.

Configuration > [Career Section] Administration > Statements

Here's what to do

1. Click the name of a statement.
2. Click **Remove** next to a location.

Dissociating an Organization from a Statement

Before you start

The *Access the Career Section administration section* user type permission is required.

The statement must have Inactive or Draft status.

Configuration > [Career Section] Administration > Statements

Here's what to do

1. Click the name of a statement.
2. Click **Remove** next to an Organization.

Dissociating Career Section Type from a Statement

Before you start

The *Access the Career Section administration section* user type permission is required.

The statement must have Inactive or Draft status.

Configuration > [Career Section] Administration > Statements

Here's what to do

1. Click the name of a statement.
2. Click **Add** next to Career Section Types.
3. Clear the Career Section Type selections.
4. Click **Select**.

Modifying the Text of a Statement

Before you start

The *Access the Career Section administration section* user type permission is required.

The statement must have Inactive or Draft status.

Configuration > [Career Section] Administration > Statements

Here's what to do

1. Click a statement.

2. Click **Edit** next to the paragraph.
3. Edit the paragraphs of the statement.
4. Click **Save**.

Results:

The new text is displayed the next time the statement is used. Modifications to a paragraph within a statement are reproduced in all statements that use the paragraph.

Removing a Paragraph from a Statement

Before you start

The *Access the Career Section administration section* user type permission is required.

The statement must have Inactive or Draft status.

Configuration > [Career Section] Administration > Statements

Here's what to do

1. Click the name of a statement.
2. Click **Remove** next to the name of a paragraph.
3. Click **Save**.

Results:

The paragraph is no longer displayed in the statement. Paragraph remains available for use in a statement.

Associating a Privacy Agreement Statement to a Career Section

Before you start

The *Access the Career Section administration section* user type permission is required.

Career section must have Inactive status.

A Privacy Agreement statement must be associated with the Career Section type.

Configuration > [Career Section] Administration > Career Sections

Here's what to do

1. Click a career section.
2. Click **Edit** next to Properties.
3. In the Authentication Privacy Agreement section, select a privacy agreement statement from the Name menu.
4. Click **Save**.

Results:

The Privacy Agreement statement is displayed to candidates if the system administrator chooses to display a Privacy Agreement statement before the Login page, the Registration page, or before the job submission flow.

Displaying a Contextualized Privacy Agreement Before an Application Flow

Before you start

The *Access the Career Section administration section* user type permission is required.

Career section must have Inactive status.

A privacy agreement statement must be selected for the career section.

Configuration > [Career Section] Administration > Career Sections

Here's what to do

1. Click a career section.
2. Click **Edit** next to properties.
3. In the Authentication Privacy Agreement section, select **Yes** from the **Display Dynamically a Privacy Agreement at the Beginning of an Application Flow** menu.
4. Click Save.

Results:

If the context of the Privacy Agreement statement matches the context of the requisition, the statement is displayed to the candidate applying to a job.

Displaying the Privacy Agreement Statement Before the Registration Page

Before you start

The *Access the Career Section administration section* user type permission is required.

Career section must have Inactive or Draft status.

A privacy agreement statement must be selected for the career section.

Configuration > [Career Section] Administration > Career Sections

Here's what to do

1. Click a career section.
2. Click **Edit** next to Properties.
3. In the Authentication Privacy Agreement section, select **Registration page** from the Display the Authentication Privacy Agreement Before field.
4. Click **Save**.

Results:

Each time a new candidate wants to register at a career section, the selected privacy agreement statement will be displayed.

Displaying the Privacy Agreement Statement Before the Login Page

Before you start

The *Access the Career Section administration section* user type permission is required.

Career section must have Inactive status.

A privacy agreement statement must be selected for the career section.

Configuration > [Career Section] Administration > Career Sections

Here's what to do

1. Click a career section.
2. Click **Edit** next to properties.
3. In the Authentication Privacy Agreement section, select **Login page** from the **Display the Authentication Privacy Agreement Before** field.
4. Click **Save**.

Results:

Each time a candidate wants to log into a career section, the selected privacy agreement statement will be displayed.

Hiding the Privacy Agreement Statement in a Career Section

Before you start

The *Access the Career Section administration section* user type permission is required.

Career section must have Inactive status.

A privacy agreement statement must be selected for the career section.

Configuration > [Career Section] Administration > Career Sections

Here's what to do

1. Click a career section.
2. Click **Edit** next to Properties.
3. In the Authentication Privacy Agreement section, select **Not Specified** from the Display the Authentication Privacy Agreement Before field.
4. Click **Save**.

Results:

No privacy agreement statement will be displayed to candidates before the Login page or Registration page. If no contextualized privacy agreement is created, no statement will be displayed at the beginning of the application flow.

4 Forms

User-defined Forms

User-defined Form

A user-defined form is a block of information containing standard and/or custom fields that can be used in a specific context.

Default forms are provided to be used in Career Section application flows. These forms are used to specify the data fields your organization is capturing from candidates when they apply to a position on your Career Section. The application flow controls the sequence of pages and type of information the candidate or referrer has to provide.

You have the ability to modify the default forms that will be presented to candidates or referrers within the application flow. You also have the ability to create user-defined forms from scratch and configure the layout, field labels, and help text of the forms.

When you create a user-defined form, you select the type of form from a list and choose between creating the form from scratch versus using the template for the specific form type. Each type of form has a template that pre-populates the form with relevant fields. In both cases, it is possible to customize the layout of the form, field labels, etc. Fields appearing in a user-defined form can be removed provided that they are not mandatory (indicated by a red dot).

User-defined Form	Description
Basic Profile	Gathers candidates' Basic Profile preferences such as job type, shift, schedule, travel, salary, or availability. The information collected via this form is displayed in the candidate file. A candidate cannot have more than one Basic Profile. Within the Profile, candidates can choose to receive invitations to apply to a job in the future if the job matches their preferences.
Background Check Consent - General	Gathers candidates' general information such as driver's license information, mother's maiden name, or place of birth for the purposes of performing a background check.
Background Check Consent - Address History	Gathers candidates' address history if desired. This form is usually presented on the same page in the application flow as other Background Check forms.
Background Check Consent - Military Service	Gathers candidates' military service history if applicable. This form is usually presented on the same page in the application flow as other Background Check forms.
Candidate Personal Information	Allows candidates to provide and manage their personal information, such as their name, address, phone numbers, and any other fields related to their personal information. The information collected

User-defined Form	Description
	on this form is displayed in the candidate file. The information remains the same for each job submission.
Candidate Personal Information - Agency	Allows agents to provide and manage the personal information of candidates they refer via the agency portal, such as the candidates' name, address, phone numbers, etc. The information collected on this form is displayed in the candidate file. The information remains the same for each job submission.
Certifications	Collects information about the candidate's professional and industry certifications. This form includes fields such as issuing organization, issue date, and expiration date. You can use the certifications form on job-specific application flows or on the general profile flow. The information collected via this form is displayed in the candidate file. The information can change from one job submission to another because candidates can have different certification highlights for the different job submissions.
Education	Allows candidates to build the education part of their submission using a series of education-related fields such as institution, program, and degree. The information collected via this form is displayed in the candidate file. The information can change from one job submission to another because candidates can have different education highlights on different job submissions
eSignature	Uses the eSignature form if your organization wants candidates to sign their online job submission. The form collects the information your organization wants the candidate to fill out as they sign their online job submission, such as full name and/or unique signature (for example, Social Security Number + home zip code). This form is typically presented on a page in the application flow that is comprised of the eSignature form and the eSignature statement (which declares exactly what the candidates are agreeing to when they provide an eSignature). The form and the statement must be presented together. When this feature is activated, candidates must provide separate eSignatures for each job submission. See example below.
References	Gathers candidates' business or personal references (for example, the name(s), contact information and details about how they know the person). You can use the References form on a job-specific application flow or on a general profile flow. The information collected on this form is displayed in the candidate file. Candidates can have different references highlighted for different job submissions.
Referrer Personal Information	Referrers (agents and/or employees who are referring candidates) can provide their own personal information, such as their name, address, phone numbers, etc.
Work Conditions	Gathers candidates' work condition preferences such as hourly expected pay, hours and times willing to work, etc. for either job-specific applications or general profile applications. The information collected via this form is displayed in the candidate file. Candidates can only have one set of work conditions in their candidate file.
Work Experience	Candidates can build the Work Experience part of their resume using a series of work-related fields (such as employer, title, accomplishments, etc.) The information collected via the Work Experience form is displayed in the candidate file. Candidates can have different work experience highlights for different jobs to which they apply.

Example of a eSignature statement and eSignature form.

eSign your application

eSignature Statement

eSignature

Please read the following statement carefully, then acknowledge that you have read and approved it by providing the information requested at the bottom of the page. Please note that an esignature is the electronic equivalent of a hand-written signature.

By "signing" this application, I certify that the information given here is true and correct to the best of my knowledge.

eSignature Form

DO NOT E-SIGN UNTIL YOU HAVE READ THE ABOVE STATEMENT.
By my eSignature below, I certify that I have read, fully understand and accept all terms of the foregoing statement. Please signify your acceptance by entering the information requested in the fields below.

*Please enter your full name:

*Please enter your unique identifier, i.e. the first four digits of your social security number followed by your zip code:

Candidate Submission User-Defined Fields Available in Career Section

When candidate submission user-defined fields (UDFs) are made available to be used in career sections, they can be used in forms and flows.

Submission UDFs are available in the Basic Profile, Candidate Personal Information, Candidate Personal Information - Agency, and Submission form types. When administrators create user-defined forms using one of these form types, they can select submission UDFs to design their form. When administrators create application flows, Submission Information forms are available under the Basic Profile, Candidate Personal Information, and Submission Information blocks.

Creating User-defined Forms

The creation of a user-defined form consists of the following steps.

1. In the Recruiting Administration menu, *specifying the fields that can be used in career sections*.
2. *Creating the user-defined form*.
3. *Activating the user-defined form*.

Making a Field Available in Career Sections

Before you start

Configuration > [Recruiting] Administration > Fields

Here's what to do

1. Click a field category.
2. Click the name of a field.
3. Click Edit Field Availability.
4. Select the Career Section option so that the field is available in career sections.
5. In the case of the Date of Birth, Social Security Number and candidate user-defined fields, you can select an additional option: Personally Identifiable Information (in Career Section).
If you select the check box, when candidates later enter a value in the field and save the page, the value will no longer be displayed in the field and asterisks will be displayed in place of the value on the Summary page. See *Masking Personal Information*.
6. Indicate if the content for the field is required to save, approve (requisition fields only), or source (requisition fields only) or if it is not required.
7. Specify the security level of the field, that is General, Restricted, or Confidential.
8. Click Save.

Creating a User-defined Form

Before you start

The *Access the Career Section administration section* user type permission is required.

Consider duplicating an existing user-defined form to save time.

Configuration > [Career Section] Administration > User-defined Forms

Here's what to do

1. Click Create.
2. Choose the type of form you wish to create.
3. Select the Use the default template option if you wish the form to be pre-populated with relevant fields.
4. Click Create.
5. Provide a code and a name.
6. Provide a description to facilitate future references.
7. Add rows, columns, and sections using the Toolbox features.
8. In the Field Chooser list, click a field, then drag and drop it in the desired section.
9. Edit the field properties by selecting a field and scrolling to the *Selected Element Properties* section at the bottom of the form.
10. Click Save.

Results:

The user-defined form is associated to a block that can be associated to an application flow provided the user-defined form is activated.

Activating a User-defined Form

Before you start

The *Access the Career Section administration section* user type permission is required.

Configuration > [Career Section] Administration > User-defined Forms

Here's what to do

Click Activate next to the user-defined form.

Results:

The status of the user-defined form is changed to Active in the Status column of the User-defined Forms list. The user-defined form can be used when building an application flow.

User-defined Form - Other Configuration Tasks

Deleting a User-defined Form

Before you start

The status of the user-defined form must be Inactive or draft.

The *Access the Career Section administration section* user type permission grants users access to this feature.

Configuration > [Career Section] Administration > User-defined Forms

Here's what to do

1. Click Delete next to the user-defined form.
2. Confirm the deletion.

Results:

The user-defined form no longer appears in the User-defined Forms list. The user-defined form can no longer be associated to a block.

Deactivating a User-defined Form

Before you start

The user-defined form must be active.

The user-defined form must not be in use.

The *Access the Career Section administration section* user type permission is required.

Configuration > [Career Section] Administration > User-defined Forms

Here's what to do

Click Deactivate next to the user-defined form.

Results:

The status of the user-defined form is changed to Draft in the Status column of the User-defined Forms list. The user-defined form can no longer be associated to a block.

Adding Fields to a User-defined Form

Before you start

The *Access the Career Section administration section* user type permission is required.

Configuration > [Career Section] Administration > User-defined Forms

Here's what to do

1. Click the name of a form.
2. In the Field Chooser list, click a field, then drag and drop it in the desired section.
3. Drag and drop the field into the desired section.
4. Edit the field properties by selecting a field and scrolling to the *Selected Element Properties* section at the bottom of the form.
5. Click Save.

Editing the Properties of a Field Included in a User-defined Form

Before you start

The *Access the Career Section administration section* user type permission is required.

Configuration > [Career Section] Administration > User-defined Forms

Here's what to do

1. Click the name of a user-defined form.
2. In the Page Content section, click inside a field.
3. Scroll down at the bottom of the page.
4. In the *Selected Element Properties* section, located at the bottom of the form, modify the properties of the field.
5. Click Save.

Previewing a User-defined Form

Before you start

The *Access the Career Section administration section* user type permission is required.

Configuration > [Career Section] Administration > User-defined Forms

Here's what to do

Click Preview next to the user-defined form.

Results:

The page containing the form is displayed without having to login to the Taleo application.

Viewing the Application Flows Associated to a User-defined Form

Before you start

The *Access the Career Section administration section* and the *Access Administration* user type permissions are required.

Configuration > [Career Section] Administration > User-defined Forms

Here's what to do

Click View Associated Flows next to a user-defined form.

Results:

The list of all application flows using this user-defined form is displayed. This allows system administrators to view in which part of the Career Section a change made to the user-defined form has an impact.

User-defined Forms Selected Element Properties

Available properties depend on the type of field. Not all properties are available for all elements or for all products.

Property Option	Description
Access (Editable/ Read Only)	Indicates if the field is read-only or editable. When read-only is selected, a user is unable to modify the field. Default value is Editable.
Binding field	Data source to which the element is bound. The value displayed in the Binding field represents the data value (available in the first list of the Field Chooser) to which the element is associated. For example, the Annual Bonus field is bound to the AssignmentOfferForForm/AnnualBonus. The value in the Binding field is not editable.
Columns	Number of columns. Administrator can determine how many columns of fields to display in each area of each page of the forms.
CSS Style	The desired visual style for displaying the value within an input field. Use styles as defined in the Cascading Style Sheets 2.0 standard: www3.org.reference . This style will override the main style that is used when the form is displayed to assignees and viewers. If no style information is entered, the default visual presentation will be used for that page.
CSS Style Label	This is used to control the formatting of the label above the input field that is displayed to the assignee and form viewer.

Property Option	Description
CSS Style Instructions	This style will override the style defined in the career section theme. If no information is entered, the style defined in the career section theme will be used.
Default Value	Default value of the input field
Field Label	Input Field Label
Field Size	Indicates the number of elements displayed in a list. Field Size is used for multiple-selection fields. Default value is 1. For example, if the field size is 2, the list will display 2 values.
Field Type	<p>This property should not be used for fields that are filled by candidates in career sections because RTF input is not supported. Field type is mainly used for requisition content.</p> <ul style="list-style-type: none"> • Text Input • Password Input • Suggest • Text Area • Check Box • Radio Button • Drop-down List • Check Box • Multi level Selector - this enables the user to select a collection of cascading values that are dependent on each other. Such as selecting a country, followed by a state/province and then a city. • Date input • Date Drop- down list • Selector • Read-only Text • URL - this enables the value of the field to be displayed as a clickable link when the user accesses the form. • Image URL - works the same as the URL, but makes the corresponding image a clickable link.
Help Callout	Similar to instructions, but this is displayed as a help bubble on the form and can provide information about a field to the user.
Input Mask	Format of the input value. The following syntax must be used:9=any number, a = any letter, n=any letter or number, =logical, or\9=the 9 character, \a=the a character, \n=the n character, \ =the, character, Any other symbol=the symbol (including a space). Possible formats for SSN and Zip/Postal codes: SSN: 999-99-9999ZIP Code United States: 99999 99999-9999Postal Code Canada: a9a9a9 a9a9a9 a9a-9a9Note: Make sure to not add a space before and after the operator. For example, do not enter 99999 99999-9999
Instructions	This can be used to provide any special instructions necessary to explain what is being requested for the field. The instructions will appear just below the field.
Mandatory	Indicates, by selecting the Yes or No option, if the field must be completed. When a field is mandatory, a red square appears in front of the field. This can be useful for preventing an assignee from submitting a form with the value 'Not Specified' in a user-defined selection. Marking the field as Mandatory will require the assignee to specify a value.
Rows	Number of rows available in a text area.

Property Option	Description
Save Literals	If Input Mask is used for a field, it may require that specific numbers or letters appear within the field when the assignee fills it out at runtime. Save Literals determines if specific characters in the input mask will be saved in this field, or if they are simply required for the user to type in but removed from the saved value. This is useful for helping assignees to recognize the right information to type in, while removing the redundant characters for later use.
Status (Deactivated/Activated)	Indicates if the field is activated or deactivated (that is, grayed out or not). The use of this field depends on the value selected in the Access field. Editable access + Activated status=field can be modified Read-only access + Activated status=field not editable Read-only access + Deactivated status=field not editable Editable access + Deactivated status=field not editable
Tooltip	Displays the text entered in the input field as a tooltip when the assignee/viewer hovers over the field in the form.
Value	Area where user input should be entered or where the information saved in a field is displayed.

Diversity Form

Diversity Form

The Diversity form is used to collect diversity data such as gender or ethnicity from candidates during the application process.

One information block that can be included in a career section is the Diversity block. The Diversity block is comprised of a *Diversity statement* and a Diversity form. The Diversity statement consists of text that the candidate reads regarding your organization's Diversity policy. While the Diversity form includes the diversity questions. Each of these components is created separately.

Example of a diversity form with a diversity statement.

Diversity

Diversity

Please provide the information requested in the fields below regarding diversity:

Diversity Statement

Important: Applicants, please read.
Solely to help us comply with federal and state Equal Employment Opportunity record keeping, reporting, and other legal requirements, we request that you complete this data information questionnaire. The information you provide is confidential and will only be used by the organization for carrying out its obligation under the Employment Equity Act. Your response is voluntary.

* 1 Ethnicity
Not Specified

* 2 Race
Not Specified

* 3 Gender
Not Specified

* 4 Vietnam Era Veterans and Other Veterans
Not Specified

* 5 Special Disabled Veterans
Not Specified

* 6 Individuals with Disabilities
Do you consider yourself an individual with a disability?
Not Specified

Diversity Form

Standard US and Canadian Diversity forms are provided to address regulatory needs and compliance regardless of location. These forms are the EEO1, EEO2a, EEO2b, and EE diversity forms. You can configure these standard forms, and you can also create custom diversity forms. You can configure Diversity statements and Diversity forms for each country where your organization does business, which means that candidates are presented the appropriate content and questions based on the location of the job to which they are applying. It is also possible to have a generic Diversity form for all locations.

For standard US and Canadian Diversity forms:

- It is not possible to create a new question. Only the available answers can be changed.
- It is not possible to create a new answer for a question, only the label of the answer can be changed.
- It is not possible to change the answer type of an answer.

Organizations do not always include the Diversity form upon a candidate's initial application in a career section. For U.S. EEO collection specifically, you can choose when you want to collect the diversity data. It can be during the time the candidate applies in the career section or later on in the selection process. A setting allows you to specify when in the process you want to collect EEO data.

Setting	Description	Default Value	Location
Threshold to Collect EEO information (USA)	Collect the EEO/Affirmative Action information (United States) when a candidate reaches the selected status.	New	Configuration > [Recruiting] Settings

Note: When the Threshold to Collect EEO information (USA) setting is set to Never, the Diversity block containing the Diversity form will not appear. In the case of Pipeline requisitions, the Pipeline reference model is before the NEW status. If the setting is set to Never, it means that there is no threshold applied and the Diversity block will display.

Key benefits of the Diversity form:

- Provides a standard method to address regulatory and compliance issues regardless of location.
- Questions and instructions can be tailored for each country of operation.
- Diversity data is collected based on the location of requisitions, allowing for data collection for multiple countries from a single career section.
- Configurable standard questions are available, in addition to creating up to ten user-defined questions.
- Standard forms are provided with a set of standard questions. Configurable standard questions are available, allowing for the reporting of individual data points (for example, gender) across all countries. All information is presented in a standard format with no confusion on location and formatting differences.

Optional Disability Form Questions and Fields

The Documents feature and the Disability form prescribed by the Office of Federal Contract Compliance Programs (OFCCP) for use in the United States discussed in this guide precede this current version of Oracle Taleo Enterprise Edition.

Career Section administrators can specify for individual questions on a Diversity form whether providing an answer is mandatory or optional. When candidates applying for a job or completing a general profile access a document containing any of these questions, the questions will be mandatory or optional as configured on the Diversity form. Candidates have the option of skipping any or all of the optional questions and are still able to advance to the next step in the submission flow. User-defined fields on the document can also be made mandatory or optional.

Career Section administrators can designate individual questions on a Diversity form as mandatory or optional and these designations are reflected in documents (most often disability forms) after the latter are associated with a Diversity form. There are two steps then:

1. Making Diversity form answers mandatory or optional
2. Associating disability form answers and user-defined fields with the corresponding Diversity form answers and user-defined fields

At time of upgrade, all questions on the Diversity form receive the same property (mandatory or optional) as the property of the entire form. Administrators can then modify the mandatory/optional property for individual questions if so desired.

Disability Form Supports Data Masking

The "Masking Diversity Question Answers" setting is extended to the Documents block in the job submission flow. If the setting is enabled and candidates have made submissions in the past, that information is not displayed on a document in a new submission flow. If the setting is enabled, any values provided during previous submissions for the full name and date user-defined fields are also masked.

Creating Diversity Forms

The creation of a Diversity form consists of the following steps.

1. *Creating the Diversity Form.*
2. *Creating questions for the Diversity Form.*
3. *Ordering questions in the Diversity Form (Optional).*
4. *Activating the Diversity Form.*

Creating a Diversity Form

Before you start

The *Access the Career Section administration section* user type permission is required.

Configuration > [Career Section] Administration > Diversity Forms

Here's what to do

1. Click Create.
2. Indicate if you want to create a generic form corresponding to all locations, or a specific form corresponding to a particular location.
 - a. If you selected Specific, click Add to add locations. The selected locations will appear in the Location section of the form.
 - b. If you selected Generic, All Locations will appear in the Location section of the form.
3. Click Continue.
4. Enter a name and a code. The code must be unique among all diversity forms.
5. Enter the desired information in the Description field.
6. Click Finish.

Creating a Question for Diversity Form

Before you start

The *Access the Career Section administration section* user type permission is required.

The Diversity form must have Draft or Inactive status.

The number of questions is unlimited provided none of them have the same question type. For example, a Diversity form cannot include two questions whose type is Disability.

Configuration > [Career Section] Administration > Diversity Forms

Here's what to do

1. Click the code of a Diversity form.
2. Click Create next to Questions.
3. Enter a code.

4. Select the type of question you want to create.
5. Select the format of the answer, that is Single Answer or Multiple Answers.
6. Make a selection from the Display list, that is Radio Buttons, Dropdown List, or Check Boxes.
7. To make it mandatory to provide an answer to the question, select the check box next to Answers mandatory. Otherwise, candidates will have the option of answering or skipping the question before proceeding to the next question or step in the submission process.
8. Type the question in the Question box.
9. Click Continue.
10. In the first Answer field, type an answer.
11. In the second Answer field, type a different answer.
12. If you need more Answer fields, click Create next to Answers.
13. For each answer, select the type of answer.
14. Click Finish.

What to do next

Before a question can be enabled (Active status), "Not Specified" must be specified as one of the possible answers, except in the case of Radio Button and Checkbox format questions. Also, if your organization enabled other languages in addition to the base language, translations must be entered for the question and all answers for each language.

Ordering Questions in a Diversity Form

Before you start

The *Access the Career Section administration section* user type permission is required.

Configuration > [Career Section] Administration > Diversity Forms

Here's what to do

1. Click the code of a Diversity form.
2. Click Reorder next to Questions.
3. Use the arrows to reorder the questions.
4. Click Save.

Activating a Diversity Form

Before you start

The *Access the Career Section administration section* user type permission is required.

Set up questions carefully before activating the Diversity form. While a diversity form is in Draft status, it is possible to create, define, and delete questions and the Diversity form itself can also be deleted. Once the Diversity form is given Active status, modifications are limited and the form cannot be deleted.

Only one Diversity form version can be activated per location.

Configuration > [Career Section] Administration > Diversity Forms

Here's what to do

1. Click the name of a form.
2. Click Activate.

Results:

When a Diversity block is used in an application flow, the activated Diversity form is displayed. If location was specified, the block is only displayed if the location matches the location of the Career Section.

Diversity Form - Other Configuration Tasks

Deleting a Diversity Form

Before you start

The *Access the Career Section administration section* user type permission is required.

Configuration > [Career Section] Administration > Diversity Forms

Here's what to do

1. Click Delete next to a Diversity form.
2. Click Yes to confirm the deletion.

Results:

The Diversity form is no longer displayed in the application flow. Questions and answers related to this form will also be deleted.

Deactivating a Diversity Form

Before you start

The *Access the Career Section administration section* user type permission is required.

Configuration > [Career Section] Administration > Diversity Forms

Here's what to do

1. Click the code of a Diversity form.
2. Click Deactivate.
3. Click Yes to confirm the deactivation.

Results:

The Diversity form is no longer displayed in the application flow.

Associating a Diversity Form to a Location

Before you start

The *Access the Career Section administration section* user type permission is required.

The Diversity form must not be draft.

Configuration > [Career Section] Administration > Diversity Forms

Here's what to do

1. Click the code of a Diversity form.
2. Click Edit.
3. Click Add next to Location.
4. Select one or more locations.
5. Click Select.

Editing a Question in a Diversity form

Before you start

The *Access the Career Section administration section* user type permission is required.

Only the status and the question can be edited.

Configuration > [Career Section] Administration > Diversity Forms

Here's what to do

1. Click the code of a Diversity form.
2. Click the code of a question.
3. Click Edit next to Properties.
4. Make changes.
5. Click Save.

Results:

The new question is displayed when a candidate fills out the Diversity form.

Deleting a Question for Diversity Form

Before you start

The *Access the Career Section administration section* user type permission is required.

Configuration > [Career Section] Administration > Diversity Forms

Here's what to do

1. Click the code of a Diversity form.
2. Click Delete next to the question.

Results:

The question is no longer included in the Diversity form.

Making Answers Mandatory or Optional on a Diversity Form

Before you start

The *Access the Career Section administration section* user type permission is required.

Configuration > [Career Section] Administration > Diversity Forms

Here's what to do

1. Click a Diversity form code.
2. Click the code of the Diversity form question whose answer you want to make mandatory or optional on a disability document.
3. Click Edit.
4. Make it mandatory to answer the question by selecting the Answers mandatory check box or make it optional by ensuring the check box is not selected.
5. Click Save.

Results:

Depending on the selection you made, candidates will be required to answer the question on the Diversity form or they will have the option of answering or skipping the question before continuing to another question or step in the application flow.

Editing the Answer of a Question

Before you start

The *Access the Career Section administration section* user type permission is required.

The question type of an answer cannot be changed once the question has been created.

Configuration > [Career Section] Administration > Diversity Forms

Here's what to do

1. Click the code of a Diversity form.
2. Click the code of a question.
3. Click Edit next to Answers.
4. Make changes.
5. Click Save.

Ordering Answers for a Question

Before you start

The *Access the Career Section administration section* user type permission is required.

Configuration > [Career Section] Administration > Diversity Forms

Here's what to do

1. Click the code of a Diversity form.
2. Click the code of a question.
3. Click Reorder next to Answers.
4. Use the arrows to reorder the answers.
5. Click Save.

Deleting an Answer from a Question

Before you start

The *Access the Career Section administration section* user type permission is required.

The question must have Draft status.

Configuration > [Career Section] Administration > Diversity Forms

Here's what to do

1. Click the code of a Diversity form.
2. Click the code of a question.
3. Click Delete next to the answer.
4. Click Yes to confirm the deletion.

Results:

The answer is permanently deleted.

Disabling an Answer for a Question

Before you start

The *Access the Career Section administration section* user type permission is required.

The question must have Draft status.

Configuration > [Career Section] Administration > Diversity Forms

Here's what to do

1. Click the code of a Diversity form.
2. Click the code of a question.
3. Click Disable next to the answer.
4. Click Yes to confirm deletion.

Results:

The answer is disabled for the question but remains available in the database.

Forcing Candidates to Provide Information

Before you start

The *Access the Career Section administration section* user type permission is required.

This type of answer is only available for standard diversity forms.

Configuration > [Career Section] Administration > Diversity Forms

Here's what to do

1. Click the name of a standard US or Canadian Diversity form.
2. Click the code of a question.
3. Click Enable.

Results:

Candidates are required to provide information on questions included in the standard US and Canadian Diversity forms.

Creating an Question Type

You cannot create a question type from scratch, the existing ones must be modified.

Deleting a Question Type.

Question types cannot be deleted, they can only be disabled.

Activating a Question Type

Before you start

The *Access the Career Section administration section* user type permission is required.

Configuration > [Career Section] Administration > Question Types

Here's what to do

1. Click the code of a question type.
2. Click Activate.

Results:

The question type is now available when creating a question for a Diversity form.

Editing a Question Type

Before you start

The *Access the Career Section administration section* user type permission is required.

Only the name of the question can be edited.

Configuration > [Career Section] Administration > Question Types

Here's what to do

1. Click the code of a question type.
2. Click Edit next to Properties.
3. Make changes.
4. Click Save.

Creating an Answer Type for a Question Type

Before you start

The *Access the Career Section administration section* user type permission is required.

Question type must be draft or inactive.

Configuration > [Career Section] Administration > Question Types

Here's what to do

1. Click the code of a question type.
2. Click Create next to Possible Answer Types.
3. Complete the fields.
4. Click Save.

Editing a Possible Answer Type for a Question Type

Before you start

The *Access the Career Section administration section* user type permission is required.

Diversity form must be draft.

Configuration > [Career Section] Administration > Question Types

Here's what to do

1. Click the code of a question type.
2. Click the name of the answer type.
3. Click Edit next to Properties.
4. Change the name.

5. Click Save.
6. Click Finish.

Diversity Question Answer Masking

Answers that candidates provide for diversity questions while completing a job submission or general profile can be masked after the candidates save the corresponding page.

A setting can be configured such that if candidates provide answers to diversity questions and save the corresponding page, the answers are no longer displayed on the page and asterisks are displayed in place of the answers on the Summary page.

If candidates edit their candidate profile or the job-specific application after saving a page containing answers configured for masking, they have to reenter their answers because the existing values will have been cleared. If candidates neglect to reenter the answers, a warning message lists the unanswered questions and invites the candidates to reenter answers.

Similarly, if candidates fill out other job-specific applications on the same career section and the corresponding application workflows contain diversity questions with answer masking enabled, the candidates have to reenter the values if they want to include them in the job submission. If candidates neglect to reenter the answers, a warning message lists the unanswered questions and invites the candidates to reenter answers.

Note: Because candidates are obliged to reenter answers to diversity questions (provided the masking feature is enabled) each time they edit their general profile or apply for jobs, enabling this feature can have a negative impact on the candidate experience. The inclusion of diversity questions with answers masking enabled in "primary" flows is therefore not recommended. Diversity questions, if configured for masking, are more suitable for "secondary" flows such as Invitation to Self-Identify and Request More Info.

Masking Answers for a Question in a Diversity Form

Before you start

Configuration > [Career Section] Settings

Here's what to do

1. Click Masking Diversity Question Answers.
2. Click Edit.
3. In the Value section, click the radio button next to Yes.
4. Click Save.

Results:

Answers that candidates provide for diversity questions while completing a job submission or general profile will be masked after the candidates save the corresponding page.

Documents

Documents

The Documents section of the Career Section Administration menu stores PDF files loaded into the Taleo system.

The PDF document includes fields and questions already configured. That alone, however, is not enough for application flows to be able to use the document. The fields and questions still need to be connected to fields and a diversity question using the Field Binding capability. In turn, when the document is presented to candidates via a Documents block in Career Section application flows, candidates populate the data fields in this document. Documents cannot be used for other purposes such as data output. The only documents available are two instances of the *Voluntary Self-Identification of Disability (Exp. 31-01-2020)* form. Customers can neither modify the documents, nor upload additional documents. The Documents block can only exist on its own as a page; it cannot be on a page with other blocks.

Documents work in a complementary fashion with the Diversity block in an application flow; they do not replace it. The Career Section administrator can associate the document with a Diversity form. This enables the administrator to then associate questions on the document with questions on the Diversity form. This action also ensures that the questions on the document are not displayed a second time on the Diversity block in the application flow, even though the questions are included in the configuration of that Diversity form. The Documents block in an application flow will inherit the location contextualization from the associated Diversity form. Because the functionality is only relevant for a United States-specific document provided in the Taleo system, the associated Diversity form will be contextualized to the United States. As such, the Documents block will only be displayed to candidates who are applying for requisitions whose locations are in the United States.

System administrators bind the fields on the form with the corresponding Diversity answers and candidate user-defined fields in the Taleo system. Administrators can configure the form such that it is displayed to candidates as part of a profile submission or job-specific application flow. The supplied forms are available in English only, and will render in English on application flows in other languages. Because administrators bind the data fields to preexisting Diversity questions in the Taleo system, reports referencing Diversity questions should not require any changes to accommodate this feature.

When the document is presented to candidates in the career section, the width of the document is modified automatically so it does not exceed the width of the content window thereby avoiding horizontal scrolling. The size of the content window is determined by the customer's branding file or other web design constraints. The candidate has a "View Actual Size" option to render the document in the size of the original PDF.

Infrastructure is in place to track the documents and the data submitted each time a document is submitted by candidates. Future features may use this link.

The Documents block in the application flow is compatible with the "Diversity Question Answer Masking" feature. If masking is enabled, the responses are not displayed on the Summary page of the submission. If candidates return to edit a form or there is data from past submissions, the information is not displayed on the form. Finally, masking extends to two user-defined fields, full name and date.

Note: The Documents feature is incompatible with Internet Explorer browsers running in Compatibility Mode, for both the Configuration Module and Career Section. Note that Compatibility Mode on Internet Explorer is outside of the technical requirements for the Taleo System.

OFCCP Disability Form

The *Voluntary Self-Identification of Disability* forms are preloaded in the Taleo system.

Except for naming conventions, the two forms are identical. One form can be used for pre-offer situations while the other one can be used for post-offer situations. The Disability form is rendered as an image overlaid with fields that are completed by candidates after they have read the content of the form. Neither candidates nor system administrators need any Adobe Acrobat products to configure the form or enter data in the career section.

System administrators can display the *Voluntary Self-Identification of Disability* forms issued by the OFCCP to candidates as part of application flows.

The Disability forms with the expiration of 31-01-2020 are available in the Resizable Image document format. When using the Disability forms with the expiration of 31-05-2023, you can choose whether you want the document format to be Resizable Image or Rich Text.

The Rich Text Document Format improves overall accessibility in all aspects of how a screen reader and, a browser user, interacts with the *Voluntary Self-Identification of Disability* form.

When releasing this document, the OFCCP offered some guidelines about how the form is to be presented.

Among them:

- The document should be a facsimile of the form delivered by the OFCCP.
- Text font and size specifications.
- Candidates are required to enter the current day's date and their full name.

For this reason, Oracle is delivering the exact form into customers' zones.

Please note that Oracle does not confirm that the functionality and configuration described in this document will ensure regulatory compliance. Customers are advised to seek guidance from their legal counsel.

The *Voluntary Self-Identification of Disability (Exp. 31-01-2020)* form is available in Taleo Enterprise 13A.6.13, 13B.6.6, 13B.7.1, 13C.3.3, 13C.4.1 and later versions.

Configuring the OFCCP Disability Form

The *OFCCP Voluntary Self-Identification of Disability* forms are pre-loaded in the Taleo system.

In order to use the OFCCP Disability form, system administrators must perform specific configuration tasks.

1. ***Editing the disability question and its answers.*** It is suggested that the disability question and answers in the Taleo system are relabeled. Relabeling the question and answers will drive the display of this data on the Summary Page of the career section application flow.
2. ***Creating a user-defined field for the candidate's name.*** The Candidate user-defined field will be linked to the Your Name field embedded in the Disability form.
3. ***Creating a user-defined field for the date.*** The Date user-defined field will be linked to the Today's Date field embedded in the Disability form.
4. ***Binding the disability question and the UDFs.*** The disability answers, the candidate name and the date embedded in the Disability form are linked to the disability question and UDFs created in the Taleo system.

5. *Positioning the Diversity block in the application flow.* The Diversity block contains the diversity statement which provides instructions on how to complete the Diversity form as well as the OFCCP Disability form which contains fields that candidates must complete.

Example of a career section application flow with the OFCCP Disability Form in the Diversity block.

The screenshot shows a user interface for an application flow. At the top, it says 'Welcome. You are signed in. | My Account Options' and 'My Job Cart (0 Items) | Sign Out'. Below that are 'Job Search' and 'My Jobpage' buttons. The main header indicates 'Applying for: Quality Assurance Specialist (Job Number: T-001)' and 'Step 3 out of 5 | Print/Email'. A progress bar shows five steps: 'Resume Upload', 'Personal Information', 'Diversity Part 1' (highlighted), 'Diversity Part 2', and 'Summary'. Below the progress bar are 'Save and Continue', 'Save as Draft', and 'Quit' buttons. The main content area is titled 'Diversity Part 1 Form' and contains the text 'Please review and complete the form below.' Below this is a large white box containing the 'Voluntary Self-Identification of Disability' form, with 'Form CC-305' and 'OMB Control Number 1250-0005' visible in the bottom right corner.

Editing the Disability Question and its Answers

Before you start

Configuration > [Career Section] Administration > Diversity Forms

Here's what to do

1. Click the **EEO1** form.
2. Under Questions, click the **EEO1 Disability** question.
3. Click **Edit** next to Properties.
4. To make it mandatory to provide an answer to the question, select the check box next to Answers mandatory. Otherwise, candidates will have the option of answering or skipping the question before proceeding to the next question or step in the flow.
5. In the Question field, replace the existing text. For example: **Please check one of the boxes below:**
6. Click **Save**.
7. Click **Edit** next to Answers.

8. Modify the existing answers. For example:
 - o Answer: Not Specified
 - o Answer: YES, I HAVE A DISABILITY
 - o Answer: NO, I DON'T HAVE A DISABILITY
 - o Answer: I DON'T WISH TO ANSWER

9. Click **Save**.

Results:

The new labels for the disability question and its answers will be rendered on the Summary page of the career section application flow.

Creating a User-Defined Field for the Candidate's Name

Before you start

Configuration > [Recruiting] Administration > Fields > Candidate

Here's what to do

1. Click **Create User-defined Field**.
2. In the Type list, select **Text**.
3. In the Name field, type a name for the candidate name field. For example: USA_DISABILITY_FULLNAME.
4. In the Label field, type **Your Name**.
5. In the Attributes section, enter the following values:
 - o Max. Num. Chars.: 40
 - o Width: 25
 - o Num. of lines: 1
6. Translate the field into all available languages. Languages are available at the upper right of the page.
7. Click **Save**.
8. Configure the properties of the field as follows:
 - a. In the Candidate Fields list, click **Show User-defined Fields**.
 - b. Click the **Your Name** field.
 - c. Click **Edit Field Availability**.
 - d. Under Show Standard Fields, select **Taleo Recruiting** and **Career Section**.
 - e. Under Content Required, select **Not Required**.
 - f. Under Security Level, it is suggested to select **Confidential**.
 - g. Click **Save**.

Results:

The field is available in the Candidate Fields list and can be linked to the Your Name field embedded in the OFCCP Voluntary Self-Identification of Disability (Exp. 31-01-2020) form.

Creating a User-Defined Field for the Date

Before you start

Configuration > [Recruiting] Administration > Fields > Candidate

Here's what to do

1. Click **Create User-defined Field**.
2. In the Type list, select **Date**.
3. In the Name field, type a name for the date field. For example: USA_DISABILITY_DATE.
4. In the Label field, type **Today's Date**.
5. In the Attributes section, enter the following values:
 - o First Year in Range: This year
 - o Last Year in Range: +1
 - o Display Order: Ascending
 - o Day Displayed: Yes
6. Translate the field into all available languages. Languages are available at the upper right of the page.
7. Click **Save**.
8. Configure the properties of the field as follows:
 - a. In the Candidate Fields list, click **Show User-defined Fields**.
 - b. Click the **Today's Date** field.
 - c. Click **Edit Field Availability**.
 - d. Under Show Standard Fields, select **Taleo Recruiting** and **Career Section**.
 - e. Under Content Required, select **Not Required**.
 - f. Under Security Level, it is suggested to select **Confidential**.
 - g. Click **Save**.

Results:

The field is available in the Candidate Fields list and can be linked to the Today's Date field embedded in the OFCCP Voluntary Self-Identification of Disability (Exp. 31-01-2020) form.

Binding the Disability Question and the UDFs

Before you start

The moment the disability document is enabled (Active status), the diversity question used in the field binding is excluded from the Diversity block. It is therefore recommended to disable the career section where the OFCCP Disability form is available.

Configuration > [Career Section] Administration > Documents

Here's what to do

1. Click the disability document name.
To edit the document, its status must be Draft or Inactive.

2. Click **Edit** next to Field Binding.
3. From the Diversity Form list, select the Diversity form you want to associate with the PDF disability form.
Only the diversity questions in the disability form you select will be available for field binding.

Once a disability question is used in field binding, this question is no longer presented to candidates on the Diversity form despite the fact that it is part of the questionnaire. Take the case of a Diversity form containing four questions: race, ethnicity, gender and disability. Candidates will see questions 1, 2 and 3 only. Question 4 on disability will be excluded automatically from rendering on the career section in the Diversity block because the question is referenced in the PDF document.

4. Associate the YES, I HAVE A DISABILITY answer with the diversity answer you modified earlier.
 - a. Click **YES, I HAVE A DISABILITY**.
The Insert Data Element window is displayed.
 - b. In the Diversity Question drop-down list, select the appropriate disability question.
 - c. In the Answer drop-down list, select **YES, I HAVE A DISABILITY**.
The Mandatory check box is displayed for information purposes only. It's value is "inherited" from the Diversity form.
 - d. Click **Save**.
5. Associate the NO, I DON'T HAVE A DISABILITY answer with the diversity answer you modified earlier.
 - a. Click **NO, I DON'T HAVE A DISABILITY**.
 - b. In the Diversity Question drop-down list, select the appropriate disability question.
 - c. In the Answer drop-down list, select **NO, I DON'T HAVE A DISABILITY**.
The Mandatory check box is displayed for information purposes only. Its value is "inherited" from the Diversity form.
 - d. Click **Save**.
6. Associate the I DON'T WISH TO ANSWER answer with the diversity answer you modified earlier.
 - a. Click **I DON'T WISH TO ANSWER**.
 - b. In the Diversity Question drop-down list, select the appropriate disability question.
 - c. In the Answer drop-down list, select **I DON'T WISH TO ANSWER**.
The Mandatory check box is displayed for information purposes only. It's value is "inherited" from the Diversity form.
 - d. Click **Save**.
7. Associate the Your Name field with the Your Name user-defined field you created earlier.
 - a. Click **Your Name**.
 - b. In the User-defined Field drop-down list, select **Your Name**.
 - c. You can configure the Your Name user-defined field as mandatory or optional by selecting or clearing the Mandatory check box.
The check box affects only the display of the field in the context of the disability form. Where the field is displayed elsewhere in a form or in the Recruiting Center, the standard permissions continue to determine the field's behavior.
 - d. Click **Save**.

8. Associate the Today's Date field with the Today's Date user-defined field you created earlier.
 - a. Click **Today's Date**.
 - b. In the User-defined Field drop-down list, select **Today's Date**.
 - c. You can configure the Today's Date user-defined field as mandatory or optional by selecting or clearing the Mandatory check box.

The check box affects only the display of the field in the context of the disability form. Where the field is displayed elsewhere in a form or in the Recruiting Center, the standard permissions continue to determine the field's behavior.
 - d. Click **Save**.
9. Click **Save**.
10. Click **Activate**.

Results:

The Active document can now be used in application flows. Once a document's status is Active, the Properties and Field Binding sections of the document can no longer be modified. Also note that a document can only be disabled while it is not referenced by any application flow.

Positioning the Diversity Block in the Application Flow

Before you start

Configuration > [Career Section] Administration > Application Flows

Here's what to do

1. Open an application flow.
2. Make sure the status of the application flow is Draft or Inactive.
3. You may choose to display the Documents block on its own page, or combine the Documents block with the Diversity block (or any other block) on one page. The procedure below describes the first option. Add the pages where the Documents and Diversity blocks will appear.
 - a. In the Add a Page field, type the name of the page. For example, Diversity Part 1.
 - b. Click Create a Page. The page appears in the Flow section.
 - c. In the Add a Page field, type the name of the page. For example, Diversity Part 2.
 - d. Click Create a Page. The page appears in the Flow section.
4. Add the Diversity blocks in the pages.
 - a. In the Available Blocks section, select the Diversity block which contains the diversity statement.
 - b. Drag and drop the block in the Diversity Part 1 page.
 - c. In the Available Blocks section, select the Documents block which contains the disability form.
 - d. Drag and drop the block in the Diversity Part 2 page.
5. Click Save.
6. Select the disability form.
 - a. In the Page Ordering section of the application flow, click the Documents link.
 - b. Click Edit next to Properties.
 - c. Select the proper disability form.
 - d. Click Save.
7. Activate the application flow.

What to do next

You can now put the *application flow on the career section*, and *activate the career section*.

5 Application Flow

Application Flow

Application Flow

An application flow is a sequence of pages that must be completed by a candidate when applying for a job or when submitting a profile on a Career Section. Application flows are also used by referrers, recruiters, hiring managers, and agents to enter candidate profiles, invite candidates to apply for a job, or enter information on behalf of candidates.

Four types of application flows can be associated with internal or external career sections:

- **Job-specific Application:** This flow is filled out by candidates who are submitting their application for a specific job opening that is listed by your organization. This type of flow can also be used by a referrer.
- **Job-specific Referral:** This flow allows referrers to apply for a specific job on behalf of a candidate.
- **Candidate Profile:** This flow does not pertain to a specific job; rather it is filled out by candidates who wish to upload their job preferences profile so they can be considered for future opportunities at your organization.
- **Candidate Profile - Referrer:** This flow allows referrers to enter a general profile on behalf of a candidate.

Two types of application flows can be associated to agency portals:

- **Application - Agency:** This flow is displayed when a candidate applies for a job via an agency portal.
- **Profile - Agency:** This flow is displayed when candidates complete their profile via an agency portal.

Two application flows are used for a specific type of information:

- **Request More Information:** The Request More Information application flow is accessed by candidates via an email sent if the Request More Information alert is set in the requisition or if candidates are manually matched to a requisition. External candidates cannot receive an email requesting more information if the requisition is not posted to an external career section. The Request More Info Active setting allows the activation of this feature. If the setting is activated, the Request More Information is applied to all career sections.
- **Invitation to Self-identify:** This flow is used exclusively when tracking EEO information (Equal Employment Information and Diversity programs). You may decide to send an email at a specific step of the application. When candidates reach the specified step (status), they receive an email from which the Invitation to Self-identify flow is accessed. The Invitation to Self-identify setting allows the activation of this feature, and the Threshold to Collect EEO information (USA) setting allows the selection of the step. The EEO, Invitation to Self-identify message template must also be activated.

Setting	Description	Default Value	Location
Request More Info Active	Activated flow for the "Request More Information" option.		Configuration > [Career Sections] Settings

Setting	Description	Default Value	Location
Invitation to Self-identify	Activated Flow for Invitation to Self-identify		Configuration > [Career Section] Settings
Threshold to Collect EEO Information (USA)	Collect the EEO/Affirmative Action information (United States) when a candidate reaches the selected status.	New	Configuration > [Recruiting] Settings

Each career section must have at least one application flow active for the career section to be made active and have jobs posted to it. A career section can include more than one flow. For example, a graduate student applying to a campus career section might choose between applying for a specific job versus registering with the site for future opportunities. In the first case, the student would follow a Job-specific Application flow; in the second case, the student would follow a Candidate Profile flow.

When building an application flow, you must create pages to which **blocks** are added. The list of available blocks are set by the system. Blocks you used to create a page are made of either standard fields or user-defined fields. Depending on the type of application flow, the lists of blocks available to create a page of the application flow differ. If a block contains standard fields the disposition and the availability of the fields cannot be changed. You can modify the value and the formatting of the field text. If a block contains user-defined fields, then you can select the fields included in the block via the user-defined form associated to the block. The text and the formatting can also be changed. The order of the information blocks in the Block Ordering section indicates the order in which the information is displayed in the application flow. In other words, the top information block in the Block Ordering section represents the information displayed at the top of the page; the box below it represents the information displayed immediately below the top information block and so forth. Some blocks can be mandatory and can only be used at a specific step of the application flow. For example, the Thank You block in a Job-specific Application is always on the last page of the application flow and is mandatory. It is a best practice that application flows contain fewer than seven pages.

The following is an example of an application flow. The flow contains pages and selected blocks. The form used and actions that can be performed are also presented.

Note: Fields which are configured as a block on the Career Section flow are not available for contextualization by OLF.

Flow Type	Pages	Selected Blocks	Form	Action	
Candidate Profile	Resume Upload	Resume upload	None, system defined	None	
	Company Source Tracking	Company source tracking	None, system defined	None	
	Disqualification Questions	Disqualification Questions	None, system defined	None	
	Education		Education Certifications	Form-0043 Default Certifications	None
			Basic Profile Information	Form-0026	
	Profile skills	Profile competencies	Simple then Detailed format	Processing answers for disqualification questions	
	Diversity	Diversity	None, system defined	None	

Flow Type	Pages	Selected Blocks	Form	Action
	Thank you	Thanks you (General Profile)	None, system defined	None

Building an Application Flow

Building an application flow consists of the following steps:

1. *Creating the application flow.*
2. *Editing the properties of pages in the application flow.*
3. *Editing the properties of blocks added to pages of the application flow.*
4. *Changing the text of fields in the application flow.*
5. Changing the text of fields in a block.
6. *Activating the application flow.*
7. *Associating the application flow to a career section.*

Creating an Application Flow

Before you start

The *Access the Career Section administration section* user type permission grants users access to this feature.

Consider duplicating an existing application flow.

Configuration > [Career Section] Administration > Application flows

Here's what to do

1. Click Create.
2. Select a flow type.
3. Click Create.
4. Enter a code, name, and description.
5. Specify if you want to enable the *progress bar*.
6. Specify if you want to enable the autofill after initial submission.

This allows users to automatically progress through the application stopping at the first page that either has mandatory fields that the user has not already completed or at a page for which the page property "Always display this page if the autofill option is enabled" is set to Yes. If all mandatory fields have been filled in and there is no stop on a page, the system displays the first page that is incomplete or the first page of the flow (whether the page was completed or not).

7. Create pages.
 - a. In the Add a Page field, type the name of the page.
 - b. Click Create a Page. The page appears in the Flow section.
 - c. Create as many pages as necessary.
8. Add *blocks* to pages.
 - a. In the Available Blocks section, select a block.

- b. Drag and drop the block in the page. The block appears in the page.
 - c. Add as many block as necessary.
9. Add *actions*. An action can only appear once in an application flow.
 - a. In the Available Actions section, select an action.
 - b. Drag and drop the action in the page. The action appears in the page.
 - c. Add as many actions as necessary.
10. Click Save.

Editing the Properties of a Page in an Application Flow

Before you start

The *Access the Career Section Administration section* user type permission grants users access to this feature.

Application flow must be inactive or draft.

Configuration > [Career Section] Administration > Application Flows

Here's what to do

1. Click the name of an application flow.
2. In the Page Ordering section, click the name of a page (name displayed in bold).
3. Click Edit next to Page Properties.
4. Modify the fields and settings. For details, see *Application Flow Page Properties*.
5. Click Save.

Editing the Properties of a Block in an Page

Before you start

The *Access the Career Section Administration section* user type permission grants users access to this feature.

Application flow must be inactive or draft.

Configuration > [Career Section] Administration > Application Flows

Here's what to do

1. Click the name of an application flow.
2. In the Page Ordering section, click the name of a block.
3. Click Edit next to Page Properties.

If the Edit link does not appear, it is because the block does not have any specific properties.
4. Modify the properties. For details, see *Application Flow Blocks*.
5. Click Save.

Changing the Text of a Field in an Application Flow

Before you start

The *Access the Career Section administration section* user type permission grants users access to this feature.

Application flow must be inactive or draft.

Display resource identifiers associated to each field.

Access the career section containing the application flow you wish to modify.

Locate the label you wish to modify and note the resource ID. Resource IDs are displayed in front of each label.

Configuration > [Career Section] Administration > Application Flows

Here's what to do

1. Click the name of the application flow.
2. Click Edit User-defined Labels next to Application Flow Properties.
3. Locate the resource to be changed by sorting by, or refining by resource number.
4. Click the name of the resource.
5. Click Edit next to Properties.
6. In the Override field, type the new label. A maximum of 1,000 characters is allowed.
7. Click Save.

Changing the Text of a Field in a Block

Before you start

The *Access the Career Section administration section* user type permission grants users access to this feature.

Application flow must be inactive or draft.

Display resource identifiers associated to each field.

Access the career section containing the application flow you wish to modify.

Locate the label you wish to modify and note the resource ID. Resource IDs are displayed in front of each label.

Configuration > [Career Section] Administration > Application Flows

Here's what to do

1. Click the name of the application flow.
2. In the Page Ordering section, click a block.
3. Click Edit User-defined Labels next to Properties.
4. Locate the resource to be changed by sorting by, or refining by resource number.
5. Click the name of the resource.
6. Click Edit next to Properties.
7. In the Override field, type the new label. A maximum of 1,000 characters is allowed.
8. Click Save.

Activating an Application Flow

Before you start

The *Access the Career Section administration section* user type permission grants users access to this feature.

Configuration > [Career Section] Administration > Application Flows

Here's what to do

1. Click the name of an application flow.
2. Click Activate.

Results:

The application flow can now be used in the applicable Career Section.

Associating an Application Flow to a Career Section

Before you start

The *Access the Career Section administration section* user type permission grants users access to this feature.

Career section must have Inactive or Draft status.

Configuration > [Career Section] Administration > Career Sections

Here's what to do

1. Click the name of a Career Section.
2. Click Edit next to Application Flow.
3. Select the application flows to be used for each situation.
4. Click Save.

Application Flow Blocks

Name	Description	Flow Types	Properties
Additional Information	Allows the candidate to provide additional information regarding qualifications, career objectives, or any other details that may help explain qualifications.	<ul style="list-style-type: none"> • Application - Agency • Candidate Profile • Candidate Profile - Referral • Job-specific Application • Job-specific Referral • Profile - Agency • Request More Information 	Career Objectives <ul style="list-style-type: none"> • Number of columns • Number of rows Supplementary Comments <ul style="list-style-type: none"> • Number of columns • Number of rows
Attachments	Enables candidates who are completing a job submission to include file attachments from their computer or from their general profile. The Attachments section in the application flow lists all file attachments the candidates added manually in addition to any file attachments associated with their general profile.	<ul style="list-style-type: none"> • Application - Agency • Candidate Profile • Candidate Profile - Referral • Job-specific Applications • Job-specific Referral 	Attachment Mandatory <ul style="list-style-type: none"> • Yes • No

Name	Description	Flow Types	Properties
	<p>Candidates can then select the check box in the Relevant Files column next to files they want to include in the job submission. They can select the check box in the Resume column next to files they want to identify as career resumes and the resumes will be identified as such in the Recruiting Center.</p> <p>The Resume column and corresponding check boxes are displayed to candidates provided the latter attached at least one file to their general profile prior to applying for the job. See also: Resume file attachments and Taleo Connect.</p>	<ul style="list-style-type: none"> Profile - Agency 	
Background Check Address History	<p>Data included in the Background Check block is intended to be used for background checking only. Even if company policy is to only conduct background checks on a small subset of candidates or on the candidate who is hired, not collecting background check data from all may cause harm. Consider collecting background check data from all candidates. A best practice is to place the Background Check Consent block early in the application flow to filter out candidates before they spend time providing data that is not needed or exposing selection content (prescreening questions or assessments) to them unnecessarily. Because regulations governing background check consent vary by location, defining local legal disclaimers helps to ensure candidates understand what they are consenting to.</p>	<ul style="list-style-type: none"> Invitation to Self-identify Job-specific Applications Request More Information 	<p>Use this form in the application flow</p> <ul style="list-style-type: none"> Background Check Consent - Address History type forms
Background Check Consent	<p>Data included in the Background Check block is intended to be used for background checking only. Even if company policy is to only conduct background checks on a small subset of candidates or on the candidate who is hired, not collecting background check data from all may cause harm. Consider collecting background check data from all candidates. A best practice is to place the Background Check Consent block early in the application flow to filter out candidates before they spend time providing data that is not needed or exposing selection content (prescreening questions or assessments) to them unnecessarily. Because regulations governing background check consent vary by location, defining local legal disclaimers helps to ensure candidates understand what they are consenting to.</p>	<ul style="list-style-type: none"> Invitation to Self-identify Job-specific Applications Request More Information 	

Name	Description	Flow Types	Properties
Background Check General Information	Data included in the Background Check block is intended to be used for background checking only. Even if company policy is to only conduct background checks on a small subset of candidates or on the candidate who is hired, not collecting background check data from all may cause harm. Consider collecting background check data from all candidates. A best practice is to place the Background Check Consent block early in the application flow to filter out candidates before they spend time providing data that is not needed or exposing selection content (prescreening questions or assessments) to them unnecessarily. Because regulations governing background check consent vary by location, defining local legal disclaimers helps to ensure candidates understand what they are consenting to.	<ul style="list-style-type: none"> • Invitation to Self-identify • Job-specific Applications • Request More Information 	Use this form in the application flow <ul style="list-style-type: none"> • Background Check Consent - General Information type forms
Background Check Military Experience	Data included in the Background Check block is intended to be used for background checking only. Even if company policy is to only conduct background checks on a small subset of candidates or on the candidate who is hired, not collecting background check data from all may cause harm. Consider collecting background check data from all candidates. A best practice is to place the Background Check Consent block early in the application flow to filter out candidates before they spend time providing data that is not needed or exposing selection content (prescreening questions or assessments) to them unnecessarily. Because regulations governing background check consent vary by location, defining local legal disclaimers helps to ensure candidates understand what they are consenting to.	<ul style="list-style-type: none"> • Invitation to Self-identify • Job-specific Applications • Request More Information 	Use this form in the application flow <ul style="list-style-type: none"> • Background Check Consent - Address History type forms
Basic Profile Information	A candidates basic information.	<ul style="list-style-type: none"> • Application - Agency • Candidate Profile - Referral • Job-specific Applications • Job-specific Referral • Profile - Agency 	Use this form in this application flow <ul style="list-style-type: none"> • Basic Profile type forms
Candidate Personal Information	A candidate's personal information. Allows candidates to provide an anonymous application (application without personal identification information). The personal identification fields are grayed out so that candidates do not provide this type of information. The required fields for	<ul style="list-style-type: none"> • Candidate Profile • Candidate Profile - Referral • Invitation to Self-identify • Job-specific Applications • Job-specific Referral 	Force candidates to provide a valid U.S. social security number <ul style="list-style-type: none"> • Yes • No Allow anonymous candidates <ul style="list-style-type: none"> • Yes

Name	Description	Flow Types	Properties
	<p>an anonymous application are logon ID, password, email and location. If candidates decide that they no longer want their application to be anonymous and fill out the personal information fields, they are not able to revert back to an anonymous application. To activate the anonymous application feature, the Allow Anonymous Candidates option must be selected in the Candidate Personal Information block properties. It is possible to restrict access to anonymous candidates by activating the following setting: Include candidates whose identification is missing in candidate list and in candidate search results (does not apply to Quick Search)</p> <p>When <i>Activate the identification of potentially duplicate candidates</i> is selected, if a potential duplicate is found by the system, a Duplicate Check task is sent to the owner of the requisition, that is the recruiter assistant. If no recruiter assistant was defined, it is sent to the recruiter. For the duplicate check task performed in a profile context, if a potential duplicate is found, since there is no recruiter the task is redirected to the person defined in the General Profile Duplicate Check Task Assignee setting.</p>		<ul style="list-style-type: none"> • No <p>Use this form in the application flow</p> <ul style="list-style-type: none"> • Candidate Personal Information type forms <p>Activate the identification of potentially duplicate candidates</p> <ul style="list-style-type: none"> • Yes • No
Certifications	<p>The Certifications block only accommodates standard fields. No user-defined fields can be inserted. It is recommended to implement the Certifications block when this type of data is critical. For example, for health care, financial services and consulting positions.</p>	<ul style="list-style-type: none"> • Application - Agency • Candidate Profile • Candidate Profile - Referral • Job-specific Application • Job-specific Referral • Profile - Agency • Request More Information 	<p>Minimum number of certification entries</p> <ul style="list-style-type: none"> • 0-10 <p>For selection fields, force the user to specify a value from the selector</p> <ul style="list-style-type: none"> • Yes • No <p>Use this form in this application flow</p> <ul style="list-style-type: none"> • Certifications type form
Cover Letter (plain text)	<p>Allows a candidate to input a plain text cover letter.</p>	<ul style="list-style-type: none"> • Application - Agency • Candidate Profile • Candidate Profile - Referral • Job-specific Referral • Profile - Agency • Request More Information 	<p>Number of columns Number of rows</p> <p>Minimum number of characters required in the Cover Letter Field</p>
Contingent Staffing	<p>An agency can enter information about a contingent worker.</p>	<ul style="list-style-type: none"> • Application - Agency 	

Name	Description	Flow Types	Properties
Disqualification Questions	The Disqualification Questions block must be placed alone on a page. It is a best practice to also process answers for disqualification questions on this page. If a candidate is disqualified on this action they will be brought to a modified thank you page informing them they have not met the minimum requirements for the position.	<ul style="list-style-type: none"> • Candidate Profile • Job-specific Application 	Number of questions per page
Diversity	Taleo provides standard EEO1, EEO2a, EEO2b and EE Diversity forms. Customers can configure these standard forms as well as create custom Diversity forms.	<ul style="list-style-type: none"> • Candidate Profile • Invitation to Self-identify • Job-specific Application • Request More Information 	Display all questionnaires on the same page. <ul style="list-style-type: none"> • Yes • No
Education	The candidate can provide information about their educational history.	<ul style="list-style-type: none"> • Application - Agency • Candidate Profile • Candidate Profile - Referral • Job-specific Referral • Profile - Agency • Request More Information 	Minimum number of education entries <ul style="list-style-type: none"> • 0-10 For selection fields, force the user to specify a value from the selector <ul style="list-style-type: none"> • Yes • No Use this form in this application flow <ul style="list-style-type: none"> • Education type forms
eSignature	There is no restriction on where the eSignature block can appear. However, it is recommended to include it at the end of the application flow to ensure that the candidate has entered all required information prior to electronically signing the application. If the eSignature block is included in an application flow, the former is displayed to candidates each time they apply even if Autofill After Initial Submission Enabled is selected in the application flow properties. Users can view eSignature block information if the View the "eSignature" block information permission is selected for their user type in SmartOrg.	<ul style="list-style-type: none"> • Job-specific Application 	Use this form in this application flow <ul style="list-style-type: none"> • Electronic Signature type forms
Job Sourcing Tracking	System administrators have the ability to specify if the Source Tracking block is hidden from candidates if the source is pre-filled. An example would be when the source code is embedded into the URL that redirects candidates to the Career Section from a job board. The following option is available in the properties of the Job Sourcing Tracking block of an application flow: Hide the "Source Tracking" block if it is pre-filled. When set to Yes, candidates do not see, in the application flow or, on the summary page, the Source Tracking	<ul style="list-style-type: none"> • Job-specific Application • Job-specific Referral 	Hide the "Source Tracking" block if it is pre-filled <ul style="list-style-type: none"> • Yes • No

Name	Description	Flow Types	Properties
	<p>block if the source was pre-filled. Use this option to not provide candidates the opportunity to change the value. When set to No, the Source Tracking block is displayed no matter what. By default, the option is set to No. The <i>Display internal sources on internal Career Sections</i> private settings allows the display of internal sources in the source block of an application flow.</p>		
Location Selection	<p>Allows the candidate to identify the locations of interest for the job.</p>	<ul style="list-style-type: none"> • Application - Agency • Job-specific Application 	<p>Select as default location</p> <ul style="list-style-type: none"> • All • Primary Location
OLF Selection - One level per page	<p>Allow a candidate to specify work preferences such as the job field, location, and organization. If the full OLF block or portions of the block are not included in the Candidate Profile type flow, then OLF contextualized information (such as contextualized fields for the OLF) will not be available in the general profile unless the candidate already has OLF preferences in their candidate record.</p>	<ul style="list-style-type: none"> • Application - Agency • Candidate Profile • Candidate Profile - Referral • Job-specific Application • Job-specific Referral 	<p>Display the Organization menu</p> <ul style="list-style-type: none"> • Yes • No
Personal Information - Agency	<p>Agents can refer a new candidate, or a known candidate using the candidate's email.</p>	<ul style="list-style-type: none"> • Application - Agency • Candidate Personal Information - Agency 	<p>Force candidates to provide a valid U.S. social security number</p> <ul style="list-style-type: none"> • Yes • No <p>Activate the identification of potentially duplicate candidates</p> <ul style="list-style-type: none"> • Yes • No <p>Display the email validation section in the Personal Information - Agency block</p> <ul style="list-style-type: none"> • Yes • No <p>Allow anonymous candidates</p> <ul style="list-style-type: none"> • Yes • No <p>Use this form in this application flow</p>
Plain Text Resume	<p>Candidates can type in or paste in a plain text resume.</p>	<ul style="list-style-type: none"> • Application - Agency • Candidate Profile • Candidate Profile - Referral • Job-specific Application • Job-specific Referral 	<p>Number of columns Number of rows</p> <p>Minimum number of characters required in the Resume field</p>

Name	Description	Flow Types	Properties
Prescreening Competencies	Prescreening competencies are configured in the competency library and added to a requisition in the recruiting center. This block must be included for prescreening competencies to appear in the Career Section.	<ul style="list-style-type: none"> • Profile - Agency • Application - Agency • Job-specific Application • Job-specific Referral 	<p>Number of competencies per page</p> <p>While applying for a job or filling out a general profile, only show competencies or questions that have not been evaluated</p> <ul style="list-style-type: none"> • Yes • No <p>Display the mandatory statement checkbox after the detailed format</p> <ul style="list-style-type: none"> • Yes • No <p>Use this competency assessment format</p> <ul style="list-style-type: none"> • Detailed • Simple • Simple then Detailed format • Simple then voluntary Detailed format <p>When showing competencies in the detailed format, only show competencies that reach the minimum level defined for the abridged format</p> <ul style="list-style-type: none"> • Yes • No <p>Display the mandatory statement checkbox after the simple format</p> <ul style="list-style-type: none"> • Yes • No <p>Save only competency assessments when the candidate provides information about a given competency.</p> <ul style="list-style-type: none"> • Yes • No
Prescreening Questionnaire	Prescreening questionnaire questions are configured on the requisition in the recruiting center. This block must be included for the prescreening questionnaire to appear in the Career Section.	<ul style="list-style-type: none"> • Application - Agency • Job-specific Application • Job-specific Referral 	<p>Number of questions per page</p> <p>Mandatory questions</p> <ul style="list-style-type: none"> • None • Single-answer • Single and Multiple-answer • All <p>When applying for a job or filling out a general profile, only show skills or questions that have not been evaluated</p>

Name	Description	Flow Types	Properties
Profile Competencies	Profile competencies are configured in the competency library in the recruiting center. This block must be included for profile competencies to appear in the Career Section.	<ul style="list-style-type: none"> • Application - Agency • Candidate Profile • Job-specific Application • Profile - Agency 	<p>Number of competencies per page</p> <p>While applying for a job or filling out a general profile, only show competencies or questions that have not been evaluated</p> <ul style="list-style-type: none"> • Yes • No <p>Display the mandatory statement checkbox after the detailed format</p> <ul style="list-style-type: none"> • Yes • No <p>Use this competency assessment format</p> <ul style="list-style-type: none"> • Detailed • Simple • Simple then Detailed format • Simple then voluntary Detailed format <p>When showing competencies in the detailed format, only show competencies that reach the minimum level defined for the abridged format</p> <ul style="list-style-type: none"> • Yes • No <p>Display the mandatory statement checkbox after the simple format</p> <ul style="list-style-type: none"> • Yes • No <p>Save only competency assessments when the candidate provides information about a given competency.</p> <ul style="list-style-type: none"> • Yes • No
Profile Questionnaire	Profile questionnaire questions are configured in the question library in the recruiting center. This block must be included for the profile questionnaire to appear in the Career Section.	<ul style="list-style-type: none"> • Application - Agency • Candidate Profile • Job-specific Application • Job-specific Referral • Profile - Agency • Request More Information 	<p>Number of questions per page</p> <p>Mandatory questions</p> <ul style="list-style-type: none"> • None • Single-answer • Single and Multiple-answer • All <p>When applying for a job or filling out a general profile, only show skills or questions that have not been evaluated</p>

Name	Description	Flow Types	Properties
References	The References block only accommodates standard fields. No user-defined fields can be inserted.	<ul style="list-style-type: none"> • Application - Agency • Candidate Profile • Job-specific Application • Profile - Agency • Request More Information 	Minimum number of reference entries <ul style="list-style-type: none"> • 0-10 Use this form in this application flow <ul style="list-style-type: none"> • References type forms
Referrer Personal Information	The referrer must enter personal information about themselves, and the candidate that is being referred.	<ul style="list-style-type: none"> • Candidate Profile - Referral • Job-specific Referral 	Force candidate to provide a valid U.S. social security number <ul style="list-style-type: none"> • Yes • No Use this form in this application flow. <ul style="list-style-type: none"> • Referrer Personal Information type forms
Resume Content	Give the candidate an option to replace the information in the general profile with the information entered for the job submission. If this block is not present the general profile will always be updated with the information on the job submission.	<ul style="list-style-type: none"> • Job-specific Application 	
Resume Upload	The block must be alone on its page before any Attachments, Candidate Personal Information, Education, Work Experience or Resume block. If <i>Resume Parsing</i> is turned on the candidate has an option to upload a resume. The candidate can upload information from a third party.	<ul style="list-style-type: none"> • Candidate Profile • Job-specific Application 	
Resume Upload	Offers the candidate the option of uploading a resume. The block must be alone on its page before any Attachments, Candidate Personal Information, Education, Work Experience or Resume block.	<ul style="list-style-type: none"> • Candidate Profile - Referral • Job-specific Referral • Application - Agency • Profile - Agency 	
Screening	Multiple screening blocks can be configured on an application flow. When the screening block is configured as inline it must be on its own page, and not co-mingled on a page with other blocks. For security reasons, candidates must enter their login information (user name and password) before filling out an assessment. The email sent to candidates contains a hyperlink that direct them to the login page.	<ul style="list-style-type: none"> • Invitation to Self-identify • Job-specific Application • Request More Information 	Allow candidates to receive questionnaire information later by email. <ul style="list-style-type: none"> • Yes • No Show this block to the following candidates <ul style="list-style-type: none"> • ACE Candidates • Those who Meet RMI Criteria • Those who Meet Required Criteria

Name	Description	Flow Types	Properties
			<ul style="list-style-type: none"> All Candidates <p>Display Mode</p> <ul style="list-style-type: none"> Pop-up window Inline <p>This service is mandatory (candidates must click the link to access the questionnaire immediately or choose to receive it by email, if the latter is activated).</p> <ul style="list-style-type: none"> Yes No <p>Service</p> <ul style="list-style-type: none"> The services available to the zone.
Send New Jobs To Candidate	Candidates can choose to receive an email notification whenever a new positing matching the profile is posted.	<ul style="list-style-type: none"> Candidate Profile - Referral Job-specific Application Job-specific Referral 	<p>By default, select the check box: Accept invitations by Email on career opportunities matching this profile</p> <ul style="list-style-type: none"> Yes No
Shift Availability Grid	<p>The work shift availability grid is only activated by default for applications created for hourly and campus requisitions. The information is stored at the profile level, so once the data has been completed on one application, all other applications display this information. Otherwise, professional and executive applications do not show a shift availability grid. The grid always displays all days and 5 shift periods. Default values are: Early Morning, Midday, Afternoon, Evening, Overnight. It is not possible to remove a day or shift period from the grid. The grid labels are standard for recruiters and managers; labels are only configurable for candidates and can be configured differently per application flow.</p>	<ul style="list-style-type: none"> Application - Agency Candidate Profile Candidate Profile - Referral Job-specific Application Job-specific Referral Profile - Agency 	
Thank You (Job Submission)	The candidate is taken to the Thank You page after completing a submission.	<ul style="list-style-type: none"> Application - Agency Invitation to Self-identify Job-specific Application Job-specific Referral Request More Information 	<p>Display the Candidate Profile hyperlink</p> <ul style="list-style-type: none"> Yes No <p>Display links to these job lists</p> <ul style="list-style-type: none"> None Link to Standard List Link to Personalized Job List Both Links

Name	Description	Flow Types	Properties
Thank You (General Profile)	The candidate is taken to the Thank You page after completing a submission.	<ul style="list-style-type: none"> • Candidate Profile - Referral • Profile - Agency 	Display links to these job lists <ul style="list-style-type: none"> • None • Link to Standard List • Link to Personalized Job List • Both Links
Work Conditions	The work conditions block is only available for hourly and campus hiring types.	<ul style="list-style-type: none"> • Application - Agency • Candidate Profile • Candidate Profile - Referral • Job-specific Application • Job-specific Referral • Profile - Agency 	Use this form in this application flow <ul style="list-style-type: none"> • Work Conditions type forms
Work Experience	The information in this section is only relevant in the case of user-defined forms that include the Current Job field. The Properties section of the Work Experience block contains the Hide the end date in the case of current job field among others. The End Date field in the Work Experience block is irrelevant when candidates enter information about their current job they are typically still employed in the position. If the value of the Hide the end date in the case of current job setting is set to Yes for an application flow, and a user displays a job-specific application that uses the flow, no end date is displayed for the current work experience. The default value is No to ensure backward compatibility. Contingent workers might know the end date of their current job (even though they are still employed in the position). For this reason, one might choose to configure contingent application flows such that the End Date field is displayed.	<ul style="list-style-type: none"> • Application - Agency • Candidate Profile • Candidate Profile - Referral • Job-specific Application • Job-specific Referral • Profile - Agency 	Minimum number of education entries <ul style="list-style-type: none"> • 0-10 For selection fields, force the user to specify a value from the selector <ul style="list-style-type: none"> • Yes • No Hide the end date in the case of current job <ul style="list-style-type: none"> • Yes • No Use this form in this application flow <ul style="list-style-type: none"> • Work Experience type forms

Resume file attachments and Taleo Connect

When exporting and importing information about attachments, it is possible to determine if an attachment is a resume or not using the AttachmentType entity (AttachmentType,Code=RESUME).

When importing information about attachments, it is possible to specify if an attachment is a resume or not, by using TCC services (with AttachmentType parameter):

- attach-file-to-application-by-type
- attach-file-to-profile-by-type
- attach-recruiter-file-to-application-by-type
- attach-recruiter-file-to-profile-by type

When importing information about attachments, it is possible to specify if an attachment is a resume or not, by using new operations of the Candidate web service (with AttachmentType parameter):

- attachFileToApplicationByType
- attachFileToProfileByType
- attachRecruiterFileToApplicationByType
- attachRecruiterFileToProfileByType

Note: The system has identified documents uploaded via the Resume Upload (Parsing) block as resumes since 13B (although this designation was not displayed in Career Section or in the Recruiting Center in 13B). Consequently, if a zone is migrated from 13B to 13C or a later version, and if Resume Upload (parsing) is in use, there will be files parsed by the Resume Upload (Parsing) block in 13B that are identified as resumes in the 13C zone.

Application Flow Page Properties

Element	Description
Name	Name of the page.
Page Title	Title appearing in the <i>progress bar</i> box as well as at the top of each page.
Page Header	Header that appears in a career section, just above the sentence <i>Required Information is signaled by this indicator</i> . The page header can contain a maximum of 4000 characters and can be formatted using HTML options. A page header may contain an image tag. A tracking URL can be added to application flow pages via the image tag. Taleo has created three tokens that can be used by the company to track page hit locations: {ApplicationNumber}, {CandidateNumber}, {RandomNumber}. The following URL has spaces for formatting:
Display the Ctrl key for multiple selection hint	If you select Yes, the following sentence is displayed in the career section: "Hold down the CTRL key (Command key for Mac) to make multiple selections or to deselect items."
Display the required field hint	If you select Yes, the following sentence is displayed in the career section: "Required Information is signaled by this indicator *."
Always display this page if the autofill option is enabled	Provided the "Autofill After Initial Submission Enabled" field is set to Yes, a page in the flow can be configured such that if candidates return to an incomplete job application or apply for a new job, the page is always displayed even if it contains no mandatory fields. Activating this setting for a file attachment page, for example, ensures that candidates who return to an incomplete job application have the opportunity to verify which attachments they want to include with the application.

Application Flow Action

An action is performed by the system when a step is reached by the applicant in the application flow.

An action is added to a page of an application flow. An action can only appear once in an application flow. Actions are available according to the type of application flow. Actions cannot be added to every type of application flow.

- Job Specific Application available actions:
 - Processing Answers for Disqualification questions
 - Sending a Job Submission Acknowledgment Letter
 - Sending an ACE Candidate Alert Mail
- Job Specific Referral available actions:
 - Sending a Referral Acknowledgment Letter
 - Sending a Referral Thank You Letter
 - Sending an ACE Candidate Alert Mail
- Candidate Profile available actions:
 - Processing Answers for Disqualification questions
 - Sending a Profile Acknowledgment Letter
- Candidate Referral available actions:
 - Sending a Referral Acknowledgment Letter
 - Sending a Referral Thank You Letter
- Request More Information
- Invitation To Self Identify
- Application-Agency available actions:
 - Sending a Referral Acknowledgment Letter
 - Sending a Referral Thank You Letter
 - Sending an ACE Candidate Alert Mail
- Profile-Agency available actions:
 - Sending a Referral Acknowledgment Letter
 - Sending a Referral Thank You Letter

You can choose to add one of several of the following actions to an application flow. When selecting an action which sends correspondence to a candidate, it is a best practice to activate the *Send this acknowledgment only if the application is completed* property of the action.

- Sending a Referral Acknowledgment Letter: The system sends an acknowledgment letter to referrers who reach the application flow Thank You page and who have submitted a complete job submission.
- Sending a Referral Thank You Letter: The system sends an acknowledgment letter to candidates who reach the application flow Thank You page and who have submitted a complete job submission.
- Sending a Profile Acknowledgment Letter: The system sends an acknowledgment letter to candidates who reach the application flow Thank You page and who have submitted a complete general profile.
- Sending a Job Submission Acknowledgment Letter: The system sends an acknowledgment letter to candidates who reach the application flow Thank You page and who have submitted a complete job submission. You can add this action to all application flows (external, internal, agency and referral). This is to prevent the candidate from getting a Thank You after completing a draft or the summary page.
- Processing Answers for Disqualification Questions: The system disqualifies or marks the candidates for review if they do not meet the minimum requirements. The Disqualification Questions block must be placed alone on

a page. It is a best practice to also process answers for disqualification questions on this page. If candidates are disqualified on this action they will be brought to a modified Thank You page informing them they have not met the minimum requirements for the position.

- **Sending an Ace Candidate Alert Mail:** When a candidate's profile matches the Ace Candidate profile an email is sent by the system to the recruiter or hiring manager. The Sending an ACE Candidate Alert action is placed on the page where you want to determine if the candidate is an ACE candidate; this action is often placed on the questions page.

The Send this Acknowledgment only if the application is completed option is located in the properties in the application flow of the action.

Application Flow - Other Configuration Tasks

Deleting an Application Flow

Before you start

The *Access the Career Section administration section* user type permission grants users access to this feature.

Application flow must be inactive or draft.

Configuration > [Career Section] Administration > Application Flows

Here's what to do

1. Click Delete located on the same row as the application flow.
2. Confirm Deletion.

Results:

The Application flow is permanently deleted from the database.

Deactivating an Application Flow

Before you start

The *Access the Career Section administration section* user type permission grants users access to this feature.

Application flow must not be used in a Career Section.

Configuration > [Career Section] Administration > Application Flows

Here's what to do

1. Click the name of an application flow.
2. Click Deactivate.

Results:

The application flow can no longer be selected in a Career Section.

Viewing the Career Sections Associated to an Application Flow

Before you start

The *Access the Career Section administration section* user type permission grants users access to this feature.

Configuration > [Career Section] Administration > Application Flows

Here's what to do

1. Click the name of an application flow.
2. Click View Associated CS located at the top of the page.

Results:

A list of all the Career Sections using the application flow is presented.

Adding a Page to an Application Flow

Before you start

The *Access the Career Section administration section* user type permission grants users access to this feature.

Application flow must be inactive or draft.

Configuration > [Career Section] Administration > Application Flows

Here's what to do

1. Click the name of an application flow.
2. Click Edit.
3. Enter the name of a page in the Add a Page field.
4. Click Create a Page.
5. Click Save.

Results:

A new page is added to the application flow.

Removing a Page from an Application Flow

Before you start

The *Access the Career Section administration section* user type permission grants users access to this feature.

Application flow must be inactive or draft.

Configuration > [Career Section] Administration > Application Flows

Here's what to do

1. Click the name of an application flow.

2. Click Edit.
3. Click Delete located on the page to delete.
4. Click Save.

Results:

The page is no longer available to the application flow.

Reordering the Pages of an Application Flow

Before you start

The *Access the Career Section administration section* user type permission grants users access to this feature.

Application flow must be inactive or draft.

Configuration > [Career Section] Administration > Application Flows

Here's what to do

1. Click the name of an application flow.
2. Click Edit.
3. Under the Flow section, drag and drop the pages to the desired order.
4. Click Save.

Changing the Text of an Application Flow Page Header

Before you start

The *Access the Career Section administration section* user type permission grants users access to this feature.

Application flow must be inactive or draft.

Configuration > [Career Section] Administration > Application Flows

Here's what to do

1. Click the name of an application flow.
2. In the Page Ordering section, click the name of a page (name displayed in bold).
3. Click Edit next to Page Properties.
4. In the Page Header box, change the text. You can also format the text with the formatting tools.
5. Click Save.

Adding a Block to an Application Flow

Before you start

The *Access the Career Section administration section* user type permission grants users access to this feature.

Application flow must be inactive or draft.

A page must be created.

Configuration > [Career Section] Administration > Application Flows

Here's what to do

1. Click the name of an application flow.
2. Click Edit next to Application Flow Properties.
3. In the Available Blocks section, select a block.
4. Drag and drop the block in the page. The block appears in the page.
5. Click Save.

Results:

The new block is displayed to the candidate when the application flow is used in a Career Section.

Removing a Block for an Application Flow

Before you start

The *Access the Career Section administration section* user type permission grants users access to this feature.

Application flow must be inactive or draft.

A page must be created.

Configuration > [Career Section] Administration > Application Flows

Here's what to do

1. Select an application flow.
2. Click Edit.
3. Drag and drop a block from the Flow section to the Available Blocks section.
4. Click Save.

Results:

The removed block is no longer displayed to the candidate when the application flow is used in a Career Section.

Ordering Blocks in an Application Flow

Before you start

The *Access the Career Section administration section* user type permission grants users access to this feature.

Application flow must be inactive.

A page must be created with block elements.

Configuration > Application Flows

Here's what to do

1. Select an application flow.
2. Click Edit.

3. Drag and drop a blocks in the appropriate order on the pages of the application flow.
4. Click Save.

Results:

The page displays the fields included in the block in the selected order when the application flow is used in a Career Section.

Adding an Action to an Application Flow

Before you start

The *Access the Career Section administration section* user type permission grants users access to this feature.

Application flow must be inactive or draft.

A page must be created.

Configuration > [Career Section] Administration > Application Flows

Here's what to do

1. Click the name of an application flow.
2. Click Edit.
3. Drag and drop an action from the Available Actions section to a page.
4. Click Save.

Results:

The action is carried out when the application flow is used in a Career Section. If the application flow contains an action which sends correspondence to a candidate, it is a best practice to activate the *Send this acknowledgment only if the application is completed* property of the action.

Removing an Action from an Application Flow

Before you start

The *Access the Career Section administration section* user type permission grants users access to this feature.

Application flow must be inactive or draft.

A page must be created.

Configuration > [Career Section] Administration > Application Flows

Here's what to do

1. Click the name of an application flow.
2. Click Edit.
3. Drag and drop an action from the Flow section to the Available Actions section.
4. Click Save.

Results:

The action is no longer carried out when the application flow is used in a Career Section.

Editing the Properties of an Action in an Application Flow

Before you start

The *Access the Career Section Administration* section user type permission grants users access to this feature.

Application flow must be inactive.

Not all actions have properties.

Configuration > [Career Section] Administration > Application Flows

Here's what to do

1. Click on the name of an application flow.
2. Click an action.
3. Click Edit next to Properties.
4. Edit the properties. For details, see *Application Flow Actions*.
5. Click Save.

Activating the Invitation to Self-identify Message Template

Before you start

The *Access Administration* user type permission grants users access to this feature.

Configuration > [Recruiting] Message Template

Here's what to do

1. Click the EEO, Invitation to Self-identify message template.
2. Click Activate.

Results:

When an invitation to self-identify is sent, the *EEO, Invitation to Self-identify* message template is be used.

Progress Bar

Progress Bar

The progress bar indicates the different steps of the application flow and highlights where the candidates are in the application process.

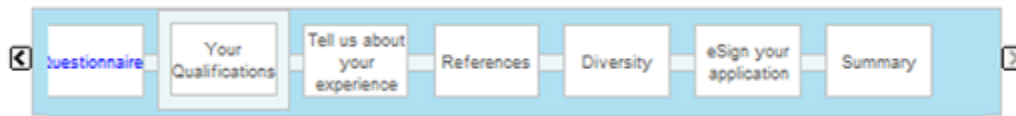

The progress bar allows candidates to move to a previous step (page) at any time and make changes during the application process. Once candidates have completed their job submission, they are taken to a summary page displaying all the information they provided

The progress bar is displayed by default. You can choose to activate the progress bar for a specific application flow. The titles correspond to the title of the pages used in the application flow, and you can change them. If the progress bar does not properly fit in the width of the page, you can adjust it in the main section of the Career Section Theme.

There is one box for each step in the application flow. However, a block that contains multiple pages is displayed as a single box in the progress bar. For example, if disqualification questions span 3 pages, this is indicated to the candidate (Page X of 3, where X represents the page the candidate is currently on). The previous situation can happen in the following cases:

- eSignature for jobs available in multiple countries.
- Diversity data when there are multiple questionnaires.
- Questions, skills and disqualification questions.
- OLF block which always spans 3 pages.

Displaying the Progress Bar

Before you start

The *Access the Career Section Administration Section* user type permission grants users access to this feature.

Configuration > [Career Section] Administration > Application Flows

Here's what to do

1. Click the name of an application flow.
2. Click Edit next to Application Flow Properties.
3. Select Yes from the Progress Bar Enabled option.
4. Click Save.

Results:

The Progress Bar is displayed to candidates when the application flow is used in a Career Section.

Changing the Text of the Progress Bar Boxes

Before you start

The *Access the Career Section administration section* user type permission grants users access to this feature.

Application flow must be inactive or draft.

Configuration > [Career Section] Administration > Application Flows

Here's what to do

1. Click the name of an application flow.
2. In the Page Ordering section, click the name of a page (name displayed in bold).
3. Click Edit next to Page Properties.
4. Change the text of the Page Title field.
5. Click Save.

Formatting the Text of the Progress Bar Boxes

Before you start

The *Access the Career Section administration section* user type permission grants users access to this feature.

Application flow must be inactive.

Configuration > [Career Section] Administration > Application Flows

Here's what to do

1. Click the name of an application flow.
2. In the Page Ordering section, click the name of a page (name displayed in bold).
3. Click Edit next to Page Properties.
4. Use the Page Header box to change the formatting of the text.
5. Click Save.

6 Career Sections

Career Section

Career Section

A Career Section is a Web site where candidates can search and apply for a job available in an organization.

There are four types of Career Sections which address different hiring needs:

- Internal: accessed only by current employees or anyone you give access to.
- External: for candidates who are interested in current employment opportunities in your organization.
- Agency: used by recruiting agencies or agents.
- *Onboarding Portal*: task-oriented career section containing a single tab called "Tasks" where candidates, new hires or employees can complete their tasks. No job-related information is available.

Career Sections are highly configurable. Before building a Career Section, elements presented in the Career Section must be created, for example *statements* such as privacy agreement and eSignature, *Diversity forms* to collect diversity data such as gender or ethnicity, *user-defined forms*, and *applications flows*. The look and feel of the Career Section must also be defined with *themes* and *branding*.

When the content and design are configured, you are ready to build a Career Section. The Career Sections area in the Career Section Administration menu allows you to view existing Career Sections, create new ones or duplicate existing Career Sections, and define options and settings in the *different components of the career section*.

Configuration

The *Access the Career Section administration section* permission is required to make changes to Career Sections.

User Type Permission	Location
Access the Career Section administration section	Configuration > [SmartOrg] Administration > User Types > Recruiting > Career Section

Best Practices for Career Sections

While creating a career section, keep in mind that a poorly designed one increases the chances that potential candidates will abandon the job application process. Some sources of frustration that candidates might encounter are: application processes that are unduly long, password lock issues, reentering information, product stability and the inability to obtain help. Following some best practices will help you make the application process a pleasant one.

Reduce Application Process Complexity

Question the complexity of the application process. Candidates are less willing to provide information they don't see as truly relevant to the process.

- Does the organization actually use all the information candidates are required to provide during the selection process?
- Could some information be included in a secondary application flow?
- Is a single job application flow for executives and hourly employees desirable?
- Would you want to complete the entire application process yourself? Would the CEO complete the job application process?
- Why use the copy/paste resume box when there is an HTML preview in the application?

Inform Candidates of Password Lock Settings

If the password lock feature, which prevents candidates from signing in to a career section after a specific number of unsuccessful sign in attempts, is enabled be sure to modify the default error message such that the system displays clear instructions to candidates as to what to do. The message could include your organization's Support email address or a link to a FAQ section. The message should never suggest contacting My Oracle Support.

The following tokens can be edited in TexTool to modify the locked account message:

- 298464
- 298446
- 298533

Create a FAQ

It is highly recommended to include a career section FAQ on the Web site for visitors or provide the email address of your organization's Support team. The FAQ link or email address could be placed in the Help section of the job list page or the Help link that is available on the career page.

Populate the Help Link

A Help link can be added to a career section. The link can point to the custom Help text or the customer's email address.

Give Candidates Extra Features on the Career Section Sign In Page

Enabling the settings that display the "Forgot your user name" and "Forgot your password" links is highly recommended. The Sign In features on the career section is where the links are enabled.

Create Candidate Friendly Page Layouts

Reduce the need to scroll within a page to view information. For example, forms should be configured to not extend beyond the established width of the career section. Eliminate the horizontal scroll bar that would otherwise be displayed at the bottom of the page by limiting the number of fields on a row and adjusting the width of fields and labels (through the CSS style).

It is important to test forms in a career section before deployment.

Name Application Flow Pages Appropriately for Display

If a page in an application flow has no title (often the case with multilingual customers), the progression bar box is blank. For this reason, provide page titles in all languages available in the career section.

If the page title is too long, the text extends beyond the box. The recommended maximum length is 25 characters.

Configure Theme for Proper Integration Within the Web Site

Each career section can be assigned a theme. A change to a theme causes a change in every career section that uses it.

A theme should be configured such that the career section pages conform to the organization's other pages. Adjust the colors and fonts so they are the same as those used in the branding.

Configure the progression bar within the theme so it does not extend beyond the established width of the career section (720px).

The width of the help panel is configured in the theme. The recommended width of the help panel is between 100 and 200px. Remove the Help panel entirely by setting its width to 0px.

The colors of the tabs and sub-tabs can be adjusted such that they conform to the Web standards. For example, white tabs are typically used to indicate a selected tab.

Further Integrate Career Section Into the Web Site Using Branding

Complete the look and feel of the career section by providing a branding file. The branding file should be tested and validated before being uploaded. Branding that includes JavaScript must be validated by Taleo.

Follow these Career Section Customization Guidelines

Career Sections are highly customizable; display, font, text, colors, etc. can be changed to reflect the needs of your organization. As a system administrator, you can change several aspects of the Career Section to have it reflect the specific needs of your organization. To successfully achieve customization, consider the general overview of the Career Section. Keep in mind that the Career Section is divided into features. To modify an element, you must know to which feature of the Career Section this element belongs. For example, style formatting is done via the theme feature, i.e. changes to colors, fonts, size etc. To hide or display a specific element, understand to which area it belongs. For example, use an application flow feature to hide the application progress bar because the progress bar is displayed in the application flow. Or, use the Career Portal Pages feature to hide the Personalized Job List tab under the Career Sections section because they belong to the career portal pages. Change one element at a time, then see the results by previewing the Career Section.

Building a Career Section

The building of a career section consists of the following steps:

1. *Creating a branding file.*
2. *Creating statements (privacy agreements).*
3. *Creating user-defined forms.*
4. *Creating Diversity forms.*
5. *Building application flows.*
6. *Creating a theme.*
7. *Configuring security options for career sections.*

8. *Creating the career section and define its properties.*
9. *Configuring career portal pages.*
10. *Activating the career section.*

Career Section Components

Each of the areas that you can configure for each of your Career Sections is described below.

Properties: Each Career Section has its own Properties settings, which include the Career Section code, name, description, and type as well as different options. For details, see *Career Section Properties*.

Application Flow Properties: An application flow is a sequence of pages that must be completed by a candidate when applying for a job or when submitting a profile on a Career Section. Application flows are also used by referrers, recruiters, hiring managers, and agents to enter candidate profiles, invite candidates to apply for a job, or enter information on behalf of candidates. You must attach at least one application flow to each Career Section, and you can attach up to four. For details, see *Application Flow Properties*.

Career Section URL : You can add different Career Section URLs to lead candidates to specific jobs or locations; for example, the URL could take them to a list of marketing jobs in Canada. For details, see *Career Section URLs*.

Career Portal Pages: The Candidate Career Portal is the applicant-facing aspect of the Career Section. You administer the Career Portal Pages within each Career Section independently, as the settings within the Career Portal Pages can vary from one Career Section to another. For example, within the Career Portal Pages area, you can control how the Basic Search settings allow a candidate to search an organization's job list. For details, see *Career Portal Pages*.

Security Settings: Each Career Section can have its own specific security settings. Specific settings are configured in the Security Settings section of each Career Section. Global Security defaults for all Career Sections of a particular type are accessed from the Career Section Administration page, under Global Security. For details, see *Security Setting Options*.

User Accounts: System administrators can choose the number of hours during which access codes sent to candidates by e-mail remain valid. After the number of hours specified has been exceeded, the access codes are suspended. Access codes can be sent to candidates by e-mail for a variety of reasons: candidates who choose or are required to create a new user name or password, candidate file creation following employee referrals, imports via Integration. In prior releases, such access codes remained valid forever. Because the e-mails can remain in candidates' e-mail accounts for any length of time, customers can now impose a specific period of time (expressed in hours) after which the access codes are suspended. If candidates attempt to use an access code that is suspended, they'll receive an e-mail instructing them to apply for a new one.

A new setting is available: Validity period for the registration and password email (in hours).

- Minimum value: 1 hour (zero hours is not accepted)
- Maximum value: 10,000 hours (equivalent to 417 days)
- Default: 1440 hours (equivalent to 60 days)

The default value of the setting Validity period for the registration and password email (in hours) is 1440. The length of time for the setting is expressed in hours. To specify 2 days, for example, the system administrator enters "48". A different value can be assigned to each career section. The setting applies to all access codes sent to candidates. For this reason, system administrators should choose a length of time that accounts for a variety of situations, for example, where candidates use the Forgot your password feature, where candidates are on vacation when they are referred for a job by an employee, or when candidates are imported through data integration. An access code that exceeds the time limit is suspended, not deleted, from the system. Take the case where the validity period of access codes was 8 hours.

If candidates used an access code 1 day after receiving it, the code would be rejected. If the system administrator then changed the validity period to 3 months, candidates could use the same access code up to 3 months after receiving it and it would be accepted. All access codes, even those generated in prior releases, are subject to this behavior.

Sign In: You can set up the sign in conditions for candidates; for example, whether or not the "Forgot User Name" link will show when candidates attempt to log in. For details, see [Sign In Policy Options](#)

Self-Registration: You can configure self-registration, which would require new users to provide a password and confirm their password. You can ask for an email address and activate the Registration Confirmation page in the Self-Registration area. For details, see [Self-Registration Policy Options](#).

User Name: User Name parameters configure functions such as the number of sign in attempts or the period during which the system prevents access to an account that has been locked. For details, see [User Name Policy Options](#).

Career Section Properties

Element	Description		
General			
Code	The code must be unique. Career Section codes must not include multi-byte characters. This is because the code forms part of the URL and multi-byte characters in Oracle Taleo Enterprise Edition URLs are not supported.		
Name	The name must be unique and cannot be used for any other career section.		
Description	A brief description of the Career Section.		
<i>Type</i>	<ul style="list-style-type: none"> • External • Internal • Agency Portal • Onboarding Portal 		
Use anchor on refresh	When the option is enabled, if candidates make a change that causes the system to update the page that is currently displayed, the system refreshes the page but the candidates remain on the same section of the updated page.		
Enable the radius search	Allows candidates to search for jobs based on their zip/postal code. Your organization must be using Work Locations to support radius search. If you enable this feature for a Career Section, candidates can enter a zip/postal code and specify the distance from the work location for which they want to search		

Element	Description		
	<p>(i.e., 1 to 100 miles or kilometers). Candidates then select a work location (only work locations that contain posted requisitions are displayed). The system then presents the positions available in the selected work location. Each work location is displayed as a hyperlink. When candidates click a hyperlink, a window opens containing a Google map of the work location address. Radius searches are completed using the zip/postal code associated with the work location. If the work site zip/postal code is not recognized or the geocoder service is unavailable at time of query, the system will use the associated RSLocations coordinates instead of the work locations zip/postal code.</p> <p>Taleo recommends implementing this feature when multiple work locations are concentrated in a single geographic area as well as for audiences where location is an important driver in employment (for example, hourly). The radius search can be used globally (it is not only for US locations).</p>		
<i>Sequence</i>	<p>Before redirecting a candidate coming from a job specific URL (from a job board, a job posting notification, etc.) to a career section, the system first evaluates the career sections in order of sequence number from lowest to highest.</p>		
Display links allowing to withdraw submissions in the My Submissions page and in the My Referrals page	<p>Displays the Withdraw link in the My Submissions page and My Referrals page to allow a candidate to withdraw a job submission.</p>		
Display the link allowing to deactivate the account in the My account page	<p>Displays the Deactivate link in the My Account page to allow the candidate to deactivate his or her account.</p>		
Enable the RSS feature	<p>Real Simple Syndication, or RSS, allows candidates to receive a notification for jobs corresponding to their job search criteria.</p>		
<i>Mobile Career Section</i>	<p>You can specify if a career section can be accessed from mobile devices.</p>		

Element	Description		
<i>Linked Mobile Career Section</i>	You can specify if a career section can be accessed from mobile devices.		
Display the "Email me a copy" link in the Summary Page	Allows candidates to receive a summary of their submission by email.		
<i>Display Type</i>	If you set the Display Type property to Private, URLs that do not include a precise career section code cannot lead candidates to that career section. The Display Type property can also be used to specify which career sections are not to be excluded when jobs are pulled via an integration process. When customers migrate to a new version, the value (Public or Private) specified for each career section is maintained. When a new external career section is created, the property is set to Public by default. When an internal career section is created, the property is set to Private by default.		
Technical Help			
<i>Type</i>	Content type of the technical help.		
Content	Content of the technical help.		
Posting			
By default, select this Career Section for posting	Specify if you wish this career section to be selected by default when posting a requisition via the Recruiting Center.		
Default Posting Start Date	Indicate the default posting start date in the Recruiting Center (Requisition > Posting and Sourcing tab > Career Sections > Modify).		
Default Posting End Date	Indicate the default posting end date in the Recruiting Center (Requisition > Posting and Sourcing tab > Career Sections > Modify).		
Display the job posting date in the My Submissions page and in the My referrals page	Specify if you wish to display the job posting date in the My Submissions page and the My Referrals page.		
Candidate Communication Agent			
Display user-defined job submission statuses in the My	The Candidate Communication Agent must be activated by Oracle Support. This feature		

Element	Description		
Submissions page and in the My Referrals page	enables candidates to view job submission statuses and stay informed of where they are in an application process. You can display links that enable candidates to view their user-defined job submission statuses and the View Email Messages link in the My Submission page.		
Display the <i>View Email Messages link</i> in the My Submissions page	Allows candidates to see messages relating to their job submissions. Messages can be emails or detailed text regarding the status of their job submissions.		
URL			
Alternate Job List URL	Provides a point of return to the Job List when the candidate clicks Exit, Return to Job, email URL or Forgot Password. See <i>Career Section URL</i> .		
Alternate Candidate Profile URL	Provides an alternate candidate profile URL. When a candidate clicks on one of the Profile URLs, the alternate profile URL provides an alternate profile link. This will redirect the candidate to any other URL of the standard profiler flow. See <i>Career Section URL</i> .		
Application Flows			
<i>Job-specific Application</i>	Application flow that allows candidates to apply for a specific job.		
<i>Candidate Profile</i>	Application flow that allows candidate to enter a general profile.		
<i>Job-specific Referral</i>	Application flow that allows referrers to apply for a specific job on behalf of a candidate.		
<i>Candidate Profile - Referral</i>	Application flow that allows referrers to enter a general profile on behalf of a candidate.		
<i>Application - Agency</i>	Application flow displayed when a candidate applies for a job via an agency portal.		
<i>Profile - Agency</i>	Application flow displayed when candidates complete their profile via an agency portal.		
Allow users to delete their attachments	Allows candidates to delete attachments from their profile.		
Email address used to apply	If you enter an email address in the field, candidates will have the		

Element	Description		
	<p>ability to apply via email instead of going through the application flow. When a candidate clicks the Apply button, an email browser window containing a pre-populated address opens and the candidate simply submits his/her application via email (instead of going through the online submission process). The candidate can apply for the job while remaining in the same submission page. Once the candidate has completed the email, he/she will remain on the same page of the career section.</p> <p>Note: This feature applies only to Basic search and Advanced search, not to Faceted Search.</p>		
Display a link to the profile in portal pages			
Always force this Career Section's job specific application flow	<p>If the setting is set to Yes, the current career section's flow is applied when a candidate applies for a job through the career section. Note that if the job is not posted on the current career section, the candidate is unable to edit the submission. If the setting is set to No, the system locates the first available career section (according to Career Section Number and starting with external ones) in which the job is posted and displays that flow to the candidate even if the candidate is visiting another career section.</p>		
Levels displayed in the Candidate Profile			
Job Field Levels	Select the levels you want the system to display in the candidate profile flow. Levels available were configured in SmartOrg.		
Location Levels	Select the levels you want the system to display in the candidate profile flow. Levels available were configured in SmartOrg.		
Organization Levels	Select the levels you want the system to display in the candidate profile flow. Levels available were configured in SmartOrg.		
Authentication Privacy Agreement			
Name	In the Name list, select the primary privacy agreement that will be displayed when a candidate visits		

Element	Description		
	the career section for the first time. If no privacy agreement is selected (that is, you selected Not Specified in the list), then no agreement is displayed to candidates when they initially log in.		
<i>Display dynamically a privacy agreement at the beginning of the job submission flow</i>	The privacy agreement will show up at the beginning of a job submission flow.		
Display the authentication privacy agreement before	Specify where the privacy agreement will appear in the career section. Possible options are before the <i>Login page</i> or the <i>Registration page</i> .		
Corporate Brand			
Name	<i>Corporate brand</i> that will appear in the career section.		
Theme			
Name	<i>Theme</i> that will appear in the career section.		

Application Flow Properties

Element	Description
Job-specific Application	This flow is filled out by candidates who are submitting their application for a specific job opening that is listed by your organization. This type of flow can also be used by a referrer.
Job-specific Referral	This flow allows referrers to apply for a specific job on behalf of a candidate.
Candidate Profile	This flow does not pertain to a specific job; rather it is filled out by candidates who wish to upload their job preferences profile so they can be considered for future opportunities at your organization.
Candidate Profile - Referral	This flow allows referrers to enter a general profile on behalf of a candidate.

Career Section URL

When a Career Section is created, a URL is automatically generated for the Career Section. When candidates access the Career Section of an organization, they are taken to the URL created for the Career Section.

System administrators can choose the page that is displayed when candidates access the Career Section; the default page is the Basic Search page.

Note: The URL cannot be identical to an existing URL, and it cannot contain the word "admin". Multi-byte characters in Oracle Taleo Enterprise Edition Career Section URLs are not supported.

System administrators can provide:

- an alternate job list URL, i.e. when candidates are in a Career Section, the alternate job list URL provides a point of return to the Job List when candidates click Exit, Return to Job, email URL, or Forgot Password.
- an alternate candidate profile URL i.e. when candidates click on one of the profile URLs, the alternate profile URL provides an alternate profile link. This redirects candidates to any other URL of the standard profiler flow.

The above two options are available in the *Career Section properties*.

System administrators can create additional Career Section URLs that can later be added to different areas of the Career Section or to email correspondence. For example, rather than have candidates start from the job search page, they could be directed to the portal and log in to the My Submissions page. A specific Career Section URL could be created for this purpose. When a URL is created for a Career Section, only part of the URL is displayed in the URL column of the Career Section URL list, this portion must be added to the domain name of the organization to obtain a complete URL.

System administrators can embed a source ID, a media ID, or an event ID to the URL; therefore when candidates apply for a job, the right source, or media or event is automatically selected.

URL and Source ID: Put the "src=" parameter plus a source ID in the URL. For example: <https://abc.taleo.net/careersection/5/jobdetail.ftl?lang=en&job=51380&src=JB-10088>. By doing that, the right source is automatically selected when a candidate applies for a job. This feature is available for any valid sources. For a list of sources, consult the Sources feature in the Recruiting Administration module.

URL and Media ID: Put the "src=" parameter plus a media ID in the URL. This parameter can only be used for eQuest.

URL and Event ID: Put the "src=" parameter plus an event ID in the URL. For example: <http://v750dev.qa.rsft.net/careersection/2/jobapply.ftl?job=7397&src=EV-001>. By doing that, the right event is automatically selected when a candidate applies for a job. It provides you the ability to track which events, banners or online campaigns are attracting the most candidates to your organization career section. Note that event IDs must be valid and active and they must have been activated in the Sources feature of the Recruiting Administration module. Event IDs are case sensitive. For example, ev-001 and EV-001 are two distinct Event IDs.

Parameters can be manually added to a URL to direct candidates to a specific Career Section or to filter what is displayed on the page. For example:

- to have candidates land on a French page, add `&art_servlet_language=fr`
- to have the Career Section visible for internal candidates only, add `&csNo=1`
- to display only urgent jobs in the job list page, add `&u=1`

Note: As mentioned earlier in this section, multi-byte characters in Oracle Taleo Enterprise Edition Career Section URLs are not supported.

URL considerations for standard career sections using only Advanced search and linked to a mobile career section

Career Section administrators create career section URLs for a variety of reasons (Configuration > Career Section Administration > Career Section URLs).

The special situation involves standard career sections for which:

- the Advanced search page is enabled and
- the Basic and Faceted search pages are disabled and
- a mobile career section is linked to the standard career section.

In such a situation, it is important to configure any URL for the Advanced search in the standard career section such that the URL ends with "jobsearch.ftl". E.g. <http://customerzone/careersection/careersectioncode/jobsearch.ftl>. This might seem odd given that "jobsearch.ftl" points to the Basic search or Faceted search (both disabled on the standard career section) but this configuration works well in practice. Because the Basic search and Faceted search are disabled, visitors to the standard career section are redirected automatically to the URL ending with "moresearch.ftl" and the Advanced search page. Because of "jobsearch.ftl" (pointing to Basic search or Faceted search) in the standard career section URL and because the Faceted search page is enabled for mobile career sections, mobile device users are automatically redirected to the mobile career section and the Faceted search page.

When system administrators use the Preview functionality of the Career Section, the system automatically creates a candidate in the Career Section with the login information of the system administrator. The system administrator is then logged in to the Career Section directly using this candidate's account. All changes made in the preview page are also made in the actual Career Section. The data the system administrator creates in the Career Section is saved under this candidate's name. This data can later be accessed in the Recruiting Center and deleted.

Security Setting Options

Security setting options can be set in the following places:

- Configuration > [Career Section] Administration > Internal Career Sections
- Configuration > [Career Section] Administration > External Career Sections
- Configuration > [Career Section] Administration > Agency Portals
- Configuration > [Career Section] Administration > Career Sections > Career Section Name

Security setting options can be applied globally to a Career Section type or to a specific Career Section.

Security Setting Options
Require users to sign in before accessing the Job List
Require users to sign in before accessing job descriptions
Allow users to change their user name
Allow access by internal candidates (employees) only

Security Setting Options

Log the user out when the last page of the flow has been reached, then display the main Job List if the user attempts to go Back

Use this phone number as hotline for users who encounter login problems

Require users to authenticate after changing their email address or user name.

Sign In Policy Options

Sign in policy options can be set in the following places:

- Configuration > [Career Section] Administration > Internal Career Sections
- Configuration > [Career Section] Administration > External Career Sections
- Configuration > [Career Section] Administration > Career Sections > Internal or External Career Section Name
- Configuration > [Career Section] Administration > Agency Portals

Sign In Policy Options

Allow new users to register in system

Display the link "Forgot your user name?"

Display the link "Forgot your password?"

Show explicit error messages to users at login

Display the OpenID option

Self-Registration Policy Options

Self-registration policy options can be set in the following places:

- Configuration > [Career Section] Administration > Internal Career Sections
- Configuration > [Career Section] Administration > External Career Sections
- Configuration > [Career Section] Administration > Career Sections > Internal or External Career Section Name

Self-registration policy options are unavailable for Agency Portals.

Self-Registration Policy Options

Ask new users to provide a password when they register

Ask new users to confirm the password when they register

Ask new users to provide an email address when they register

Self-Registration Policy Options
Ask new users to confirm the email address when they register
Activate the registration confirmation page
Number of username attempts before closing the session

User Name Policy Options

User name policy options can be viewed in the following places:

- Configuration > [Career Section] Administration > Internal Career Sections
- Configuration > [Career Section] Administration > External Career Sections
- Configuration > [Career Section] Administration > Career Sections> Career Section name

User Name Policy Options
Activate this user name security policy
Require user names that contain at least X characters
Require user names that contain no more than X characters

Career Portal Pages

Once candidates have accessed the Career Section, they have access to portal pages. A career portal page is a page displayed by clicking either the tabs or the links at the top of the Career Section, below the branding. Career portal pages each represent a specific area of the Career Section.

Career portal pages allow you to customize each Career Section to the specific needs of your organization. Career portal pages are highly configurable. You can choose which career portal pages are displayed for a given Career Section. A set of properties defines each career portal page allowing the customizing of fields, icons etc. to be displayed.

Text in tabs, links, fields and buttons appearing in career portal pages can be changed if the text has a product resource identification number. See [Changing the Text of a Field in a Career Portal Page](#).

The color and formatting of text, color and background color can also be changed via the *Theme* feature.

Below is a description of each of the career portal pages:

Basic Search page allows candidates to perform basic searches using criteria such as the job number, the job field, the location. Basic Search is the default search type. If Basic Search is not selected, the Advanced Search becomes the default. If Basic Search and Advanced Search are not selected, the All Jobs search becomes the default. If Basic Search, Advanced Search and All Jobs are not selected, My Job page becomes the default and candidates are required to log in.

It is not possible to change the order of search tabs. For example, the Advanced Search tab cannot appear before the Basic Search tab. However, it is possible to disable any search tabs in a Career Section. If all search pages are displayed, the display order is: Basic Search, Advanced Search, Jobs Matching My Profile, All Jobs.

Advanced Search page allows candidates to perform advanced searches using more criteria than the basic search. For example, the job number, the job field, the job type, the job status, the location, the work shift availability, the education level, etc.

Job List page allows for the configuration of standard fields and user-defined fields that are included as columns in job lists. Job lists can be configured for specific Career Sections. This flexibility enables a Career Section to provide a more effective job search for specific candidate pools by displaying the most useful information. The inclusion of user-defined fields allows customer-specific data to be readily available in the list so that candidates do not have to open the job offer to find important details. User-defined fields can be added to job lists, but they cannot be used to sort lists.

Personalized Job List allows candidates, who have completed a job specific application or a general profile, the access jobs that match the preferences they have set in their general profile. Candidates simply need to click the Jobs Matching My Profile link, and they are presented with a list of available jobs. The system administrator can set the criteria that determine when a match is to be made between a job and a candidate; Only jobs meeting all the specified criteria are displayed in the Career Section Jobs Matching My Profile page. If a candidate clicks on the Jobs Matching My Profile tab, the candidate is asked to sign in if he/she has not already signed in. If the candidate has not created a general profile or has not applied to at least one job, he/she does not see any jobs and the following message is displayed: "You don't have a candidate profile for the moment".

My Job Cart allows candidates to conduct job searches and select jobs that they wish to place in their job cart for later review.

My Saved Searches allows candidates to select the search criteria they want for a specific job search, run the search, view search results and then save the search.

My Submissions page allows candidates to have access to information (including the job description and job status) regarding all of their applications on job-specific acquisitions and their draft submissions. Jobs that have been updated since a candidate last visited the site is highlighted. The candidate has the opportunity to complete or withdraw draft submissions, and view or withdraw completed ones. Submission status (in the context of career section work flows) and messaging capability are features available at extra cost to Taleo customers. When the Jobs Matching My Profile page is set to be displayed, if a candidate clicks on the Jobs Matching My Profile tab, the candidate is asked to sign in if he/she has not already signed in. If the candidate has not created a general profile or has not applied to at least one job, he/she does not see any jobs and the following message is displayed: "You don't have a candidate profile for the moment".

The *My Referrals* career portal page provides candidates with a single list that brings together all of their respective referrals. The candidates can create draft referrals and complete them at a later time. They can view their past and present referrals and withdraw any of them. The ownership period is configurable.

Job Description allows users to display the job title as a hyperlink in the Career Section. When clicking the link, candidates are brought to a new page containing the complete job description. On this page, candidates are provided a link to go back to the job submission process. Candidates are returned to the page where they were at and the data they entered before clicking the link is still there.

Requisition Balloon page displays a hover callout beside the job title containing a short description of the job. Candidates have the ability to view the job description at any point in time when they apply.

The *Search Query Balloon* displays a hover callout beside the Basic Search and Advanced Search. This callout contains search criteria of the last search that was performed.

My Account allows candidates to configure the following account options: Personal information such as first name, last name, email address, phone numbers, address, social security number; Login information such as user name, password and security question and its answer; Correspondence preferences.

My Messages allows candidates to access correspondence directly from the secure message center in the Career Section.

Access Management gives access to user-defined labels that can be customized in the following Career Section pages: Sign In page, New User Registration page, Forgot Your Password page, Forgotten User Name page.

Faceted Search allows candidates to perform searches using dynamic search filters (facets). When the Faceted Search is activated, it replaces the existing Basic Search page and Job List page and provides candidates with a robust way to search for jobs. To activate the Faceted Search, the Faceted Search protected setting must be enabled by Oracle Support (Configuration > [Career Section] Settings).

Basic Search Properties

Property	Description
Displayed	When set to Yes, displays the Basic Search page in the Career Section.
Display the organization search control	When set to Yes, the Organization search criteria is displayed in the Career Section.
Display the search criteria section expanded	When set to Yes, search criteria in the Career Section are expanded. When set to No, search criteria are collapsed; to see them, candidates must click Show Search Criteria.

Advanced Search Properties

Property	Description
Displayed	When set to Yes, displays the Advanced Search tab in the Career Section.
Display the job number search criteria	When set to Yes, the Job Number search criteria is displayed in the Career Section.
Display the job field search criteria	When set to Yes, the Job Field search criteria is displayed in the Career Section.
Display the schedule search criteria	When set to Yes, the Schedule search criteria (Full Time, Part Time, etc.) is displayed in the Career Section.
Display the job type search criteria	When set to Yes, the Job Type search criteria (Summer Job, Internship, etc.) is displayed in the Career Section.
Display the location search criteria	When set to Yes, the Location search criteria is displayed in the Career Section.
Display the education level search criteria	When set to Yes, the Education Level search criteria (Bachelor's Degree, Master's Degree, etc.) is displayed in the Career Section.
Display the travel search criteria	When set to Yes, the Travel search criteria (e.g., Will travel 50% of the time) is displayed in the Career Section.
Display the organization search criteria	When set to Yes, the Organization search criteria is displayed in the Career Section.
Display the employee status search criteria	When set to Yes, the Employee Status search criteria (Regular, Temporary, etc.) is displayed in the Career Section.

Property	Description
Display the job level search criteria	When set to Yes, the Job Level search criteria (Entry Level, Team Leader, etc.) is displayed in the Career Section.
Display the shift search criteria	When set to Yes, the Shift search criteria (Day Job, Evening Job, etc.) is displayed in the Career Section.
Display the keyword search criteria	When set to Yes, the Keywords search criteria is displayed in the Career Section. The search engine returns keywords found in the job title, job description (internal if internal career section, and external if external Career Section), job qualifications (internal if internal Career Section, and external if external career section) and job locations. For example, if a candidate types "San Francisco" in the Keywords field, jobs in this location are returned even if the word "San Francisco" does not appear in the actual text of the job description or qualifications.
Display the posting date search criteria	When set to Yes, the Posting Date search criteria (e.g., Today, Yesterday, Last 7 days, etc.) is displayed in the Career Section.
Display the urgent need job search criteria	When set to Yes, the Urgent Jobs search criteria is displayed in the Career Section.
Display the following user-defined fields related to the department	The list contains user-defined fields that can be used as search criteria.
Display the following user-defined fields related to the offer	The list contains user-defined fields that can be used as search criteria.
Display the following user-defined fields related to the job	The list contains user-defined fields that can be used as search criteria.
Display the search criteria section expanded	When set to Yes, search criteria in the career section are expanded. When set to No, search criteria are collapsed; to see them, candidates must click Show Search Criteria. By default, search criteria are expanded.

Job List Properties

Property	Description
Displayed	When set to Yes, activates the Job List feature.
Always show urgent need jobs on top of the job list	When set to Yes, urgent need jobs are displayed first on the search result list of the Career Section.
"Already applied for this job" icon displayed	When set to Yes, the "Already applied for this job" icon is displayed in the Career Section.
"Urgent Need Job" icon displayed	When set to Yes, the "Urgent Need Job" icon is displayed in the Career Section.
Search on multilingual jobs	<p>Career sections can be configured such that if job lists contain jobs posted in multiple languages, candidates and employees can use the "Jobs available in" filter at the top right-hand corner of search pages to limit the jobs displayed to those posted in a specific language. For example, a candidate selects the Spanish language from the "Jobs available in" list. The system then displays the jobs posted in the selected language.</p> <p>The "Jobs available in" list is displayed in a career section provided:</p> <ul style="list-style-type: none"> Multiple languages are enabled in the career section. The career section includes jobs posted in multiple languages.

Property	Description
	<ul style="list-style-type: none"> In Configuration, the Basic Search is enabled and the "Search on multilingual jobs" property is set to Yes on the Job List properties page.
Default number of positions displayed	<p>Possible values are 5, 10, 25.</p> <p>Default value is 10.</p>
Default Sort Field	<p>Possible values</p> <ul style="list-style-type: none"> Posting Date (Ascending Order) Posting Date (Descending Order) Job Title (Ascending Order) Job Title (Descending Order) Schedule (Ascending Order) Location (Ascending Order) Location (Descending Order) <p>Default value is Posting Date (Descending Order)</p>
Job Field Level Displayed	Select the levels of job field to display in the Basic Search, Advanced Search and Search Results. The system administrator can decide up to which level the Job field is displayed.
Location Level Displayed	Select the levels of location to display in the Basic Search, Advanced Search and Search Results. The system administrator can decide up to which level the location is displayed. Select the desired level. For multiple selections, use the SHIFT key.
Organization Level Displayed	Select the levels of organization to display in the Basic Search, Advanced Search and Search Results. The system administrator can decide up to which level the Organization is displayed.
Display the job posting date with date and time. If you select No, only the date will be displayed.	When set to Yes, the job posting date will display the date and the time.
Display the job unposting date with date and time. If you select No, only the date will be displayed.	When set to Yes, the job unposting date will display the date and the time.

Personalized Job List Properties

Property	Description
Displayed	When set to Yes, activates the Job Matching My Profile feature.
"Already applied for this job" icon displayed	When set to Yes, the "Already applied for this job" icon is displayed in the Career Section.
Default number of positions displayed	Possible values are 5, 10, 25. Default value is 10.
Job field level displayed	Select the levels to display in the Career Section, The administrator can decide up to which level the Job Field is displayed. Multiple selections are possible.

Property	Description
Organization level displayed	Select the levels to display in the Career Section. The administrator can decide up to which level the Organization is displayed. Multiple selections are possible.
Location Level Displayed	Select the levels to display in the Career Section. The administrator can decide up to which level the Location is displayed. Multiple selections are possible.
Always show urgent need jobs on top of the job list	When set to Yes, urgent need jobs are displayed first on the search result list of the Career Section.
Search on multilingual jobs	When set to Yes, the multilingual job search is activated in the Career Section. When activated, candidates can access jobs in multiple languages in a single Career Section. This enables candidates to view jobs that match the search criteria entered, regardless of the language in which the job is posted. For example, a job is created in English and is not translated into French. Candidates visiting the Career Section could choose to search for jobs using the French language option. Links to jobs matching the criteria and available in other languages are displayed. In this scenario, jobs which are in English are now available to the candidate via a link located at the bottom of the page. The following information would be displayed: Jobs also available in: English French Clicking on English would display the jobs posted in English.
“Urgent Need Job” icon displayed	When set to Yes, the “Urgent Need Job” icon is displayed in the Career Section.
Maximum number of jobs displayed in the personalized job list	Possible values are Unlimited, 10, 15, 20 and 40. Default value is Unlimited.
Default Sort Field	<p>Possible values</p> <ul style="list-style-type: none"> • Posting Date (Ascending Order) • Posting Date (Descending Order) • Job Title (Ascending Order) • Job Title (Descending Order) • Schedule (Ascending Order) • Location (Ascending Order) • Location (Descending Order) <p>Default value is Posting Date (Descending Order)</p>

My Job Cart Properties

Property	Description
Displayed	When set to Yes, activates the My Job Cart feature.
Default number of positions displayed	Specify the number of positions displayed in My Job Cart page. Possible values are 5, 10, 25. Default value is 10.
Default sort field	<p>Default value is Posting Date (Descending Order)</p> <p>Possible values are</p> <ul style="list-style-type: none"> • Posting Date (Ascending Order) • Posting Date (Descending Order)

Property	Description
	<ul style="list-style-type: none"> • Job Title (Ascending Order) • Job Title (Descending Order) • Schedule (Ascending Order) • Schedule (Descending Order) • Location (Ascending Order) • Location (Descending Order)
Location Level displayed	Select the levels to display in the Career Section. The administrator can decide up to which level the Location is displayed. Multiple selections are possible.
Always show urgent need jobs on top of the job list	When set to Yes, urgent need jobs are displayed first on the search result list of the Career Section. Default value is Yes.
"Urgent Need Job" icon displayed	When set to Yes, the Urgent Need Job icon is displayed in the Career Section. Default value is Yes.
Job Field Level Displayed	Select the levels to display in the Career Section. The administrator can decide up to which level the Job Field is displayed. Multiple selections are possible.
Organization Level Displayed	Select the levels display in the Career Section. The administrator can decide up to which level the Organization is displayed. Multiple selections are possible.

My Saved Searches Properties

Property	Description
Displayed	When set to Yes, activates the My Saved Search feature.

My Submissions Properties

Property	Description
Displayed	When set to Yes, activates the My Submissions feature.
Ask reason for withdrawal	When set to Yes, the Career Section displays a field where candidates can provide the reason why they decided to withdraw their job submission.
Default number of positions displayed	Specifies the number of positions displayed in the My Submissions page. Possible values are 5, 10, 25. Default value is 10.

My Referrals Properties

Property	Description
Displayed	When set to Yes, activates the My Referrals feature.
Ask reason for withdrawal	When set to Yes, the Career Section displays a field where candidates can provide the reason why they decided to withdraw their job submission. Default value is No.
Withdraw Reason is Mandatory	When set to Yes, candidates must provide a reason why they decided to withdraw.
Default number of positions displayed	Possible values are 5, 10, 25. Default value is 10.
Display to the referrer submissions for which candidates applied by themselves.	When set to Yes, referrers can see all submissions of a candidate who they referred and who is still active. Default value is No. See <i>Displaying All Candidate Submissions in the My Referrals Tab</i> .

Job Description Properties

Property	Description
Displayed	When set to Yes, activates the job description feature.
Enable job invitations through social networks	When set to Yes, the candidate will have an option to share the job listing via social network, or email.
Display the job posting date with date and time. If you select No, only the date will be displayed.	When set to Yes, the job posting date will display the date and the time.
Display the job unposting date with date and time. If you select No, only the date will be displayed.	When set to Yes, the job unposting date will display the date and the time.

Requisition Balloon Property

Property	Description
Displayed	When set to Yes, a balloon containing information is displayed over the requisition name.

Search Query Balloon Property

Property	Description
Displayed	When set to Yes, a balloon containing information is displayed over a search query.

My Account Properties

If no display options are displayed, the Correspondence block is not displayed to candidates on the My Account page. It is recommended to enable these options and leave candidates the option of deselecting them. On the other hand, disabling options that are not used is also recommended. For example, if the job posting notifications option is not used, disable it. If the hiring process relies on notifications to communicate specific data to candidates, consider eliminating the candidate's ability to deselect that type of correspondence.

Property	Description
Displayed	When set to Yes, activates the My Account feature.
SSN Validation (United States Only)	Activates the US social security number validation in personal information pages.
Candidate Personal Information User-defined Form	Select which Candidate Personal Information user-defined form is used.
Display the correspondence language	When set to Yes, allows candidates to configure the language in which they want to receive their correspondence. Set to Yes by default. If only one language is activated, the correspondence language selector is displayed in the Career Section even if this setting is activated. The languages listed in the Career Section My Account page are not limited to the languages available in the Career Section.
Display the job posting notification setting	When set to Yes, allows candidates to specify if they wish to receive job posting notifications. Set to Yes by default.
Display the email acknowledgment setting	When set to Yes, allows candidates to specify if they wish to receive email acknowledgments. Set to Yes by default.
Display the rejection letter setting	When set to Yes, allows candidates to specify if they wish to receive rejection letters. Set to Yes by default.

Access Management Properties

UI Element	Description
Displayed	When set to Yes, activates the job description feature.

My Messages Properties

Property	Description
Displayed	When set to Yes, all correspondence is sent to the candidates secure messaging center.

Faceted Search

Faceted search is a career portal page that provides a new way for candidates and employees to search for jobs via the career section Job Search tab. When enabled, Faceted search replaces the Basic search and Job List career portal pages.

While the Job Search tab is displayed, candidates can type terms in the search bar fields and filter the list of displayed job openings by selecting facets (search filters) in the left panel. Without having to perform a new search, candidates can change their facet selections and the search results are updated immediately to reflect the new filter criteria.

Welcome JC Testerson. You are signed in.

Job Search My Jobpage

Keyword Location

Job Openings 1 - 25 of 38

▼ Posting Date

▼ Location

Country

- Canada (31)
- United States (30)
- Australia (3)

State/Province

- Quebec (3)

Region

- Quebec (3)

[Show more...](#)
[See all locations.](#)

▼ Job Field

Category

- Jobfield1 (18)
- Computer and Mathematics (7)
- Business and Financial Operations (6)

Function

- Computer Specialists (6)
- Business Operations Specialists (3)

[Show more...](#)
[See all job fields.](#)

▼ Job Type

- Standard (19)
- Cooperative (19)

Requisition Title

- Hourly_req
- Req1-Lang1
- purge delete employe
- AdvancedSearch
- Req-sturcotte_006
- Req-sturcotte_015
- Req-sturcotte_007
- Req-sturcotte_001
- Req-sturcotte_003
- Req-sturcotte_002
- Req-sturcotte_013
- Req-sturcotte_012
- Req-sturcotte_011

Oracle Support must first enable the Faceted search protected setting (Configuration > [Career Section] Settings). Afterward, customers' Career Section administrators can configure and make available the Faceted search for whichever career sections they choose. Faceted search can be configured for internal, external and agency career sections.

Search Bar

A search bar is displayed at the top of the page. This search bar can contain up to three fields from the following list:

- Job Field
- Job Number
- Job Title
- Keyword
- Location
- Organization

Those fields (except Job Number) support autosuggest. When candidates type at least two letters, the system suggests values that correspond to the typed characters. Take the example of the Location field. The list would contain only those locations and their "children" that match the characters entered in the field and the Location elements as configured in the Properties section of the Faceted search page. The Organization and Job Field fields behave in a similar manner. In addition, if candidates click See all locations or See all job fields in the left pane of the Faceted search page, and type two or more characters, the system suggests corresponding values. The candidates can make a selection from the list of displayed values or they can type additional characters (and the list of suggested terms is modified accordingly).

The search bar also contains an **Advanced Search** link which takes candidates to the Advanced search page. From there, candidates can perform advanced searches using more criteria than the basic search, for example, the job field, the job type, the education level, etc. The **View All Jobs** link enables candidates to view all open jobs in the organization.

Job Openings List

Jobs in the Job Openings list can be displayed in single-line view or multiple-line view and information on each job is displayed divided into columns. The number of columns that can be displayed in the list varies depending on whether the filter panel is displayed. The width of each column can also be specified. If the content in a column is too long, the content is wrapped automatically. The Requisition Title and the Actions columns are always displayed in the Job Openings list. Candidates can click a job title to obtain details about the job. Note that the "balloon" that used to be located next to the job description is no longer displayed.

Actions that can be performed on a job are located in the **Actions** column. The main actions, Apply, Finish Draft Submission, View/Edit Submission are displayed with a button while other actions such as Save Job and Share are displayed in an Action drop-down list.

The number of job openings is displayed at the top of the page. Candidates can navigate between pages by clicking Next, Previous, or the page numbers located at the bottom of the page.

Default Job List Layout

Career Section administrators can determine which job list layout (or view) will be displayed by default on the Faceted search page and whether users will be able to switch between job list layouts.

If Career Section administrators enable the Faceted search for a career section, information about each job in the job list can be displayed on a single line or on multiple lines. In the first case, the job list resembles a table with cells. Administrators can select the column headings displayed in single line layout (Requisition Title is a mandatory column heading).

Career Section administrators set the default job list layout—the way jobs will be displayed each time candidates or employees visit the career section and view jobs on the Faceted search page. The default layout is used throughout a session unless the candidate or employee chooses the other layout.

Administrators can impose a single layout (single line or multiple line) or they can enable candidates and employees to switch between layouts.

If Career Section administrators enable candidates and employees to switch between views, a link is displayed in the career section at the top of the job list. Candidates click the corresponding link: "Single-line" to display information about each job on a single line; "Multi-line" to display information about each job on multiple lines.

If candidates display a job description and return to the job list, the list is displayed in the layout that candidates selected most recently (single line or multiple line). If candidates click a different tab or go to the Advanced search page and return to the Faceted search job list, the default job list layout (selected by the Career Section system administrator) is displayed.

Filters

Filters (or facets) can be used to refine search results. If candidates or employees select filters, the search result display is updated accordingly; only job openings that satisfy the job search criteria and the selected filters are displayed in the Job Openings list. Filters are organized into groups (for example, Location, Job Type, Job Level) and each group displays up to five filters. Within each group, filters are ordered by the number of occurrences in the career section, from greatest to smallest. If there are more than five filters, a **Show more** option enables candidates to view the "top 10" filters. Next to each filter, the number of jobs that satisfy the search criteria and the filter is displayed.

When a filter is selected, it is displayed above the Job Openings list. To remove a filter after having applied it, users click the Delete icon. Alternatively, users can remove all applied filters by clicking Clear at the far right of the selected criteria zone. In both cases, the Job Openings list is adjusted accordingly. When no filter is selected, the Job Openings list displays all jobs posted on the career section.

OLF filters are arranged and displayed by OLF level. Under Location, filters are grouped by two levels: state/province and region. Under Job Field, filters are grouped by two levels: Category and Function. Within a level, filters are ordered by the number of occurrences, from greatest to smallest.

After a candidate or employee enters a value in the OLF field (e.g. Location), and performs the search, the system displays on the left side all the levels below the level of the search term. Below each level, the corresponding filters are displayed. For example, if someone entered "United States" in the Location field as depicted in the screenshot, the system would display the State/Province and Region levels but not the Country level. If someone entered "New York, United States" (as in the State of New York), the system would display the City level. If no OLF values are specified, all levels (including the highest level) are displayed. In the case of Location, for example, Country, State/Province and Region levels would all be displayed.

If candidates click "Show all locations" in the Location section of the "facets" panel, the window that appears displays only locations and their "children" that match the Location elements as configured in the Properties section of the Faceted search page. The "Show all organizations" and "Show all job fields" links behave in a similar manner.

OLF Levels for a Faceted Search Page

OLF levels for a Faceted search page are configured in the page's Properties section. The levels determine the display of:

- The levels displayed in the search bar's "suggest" window when users beginning typing in a search field.
- The levels displayed in the "facets" panel.
- The levels displayed in the window displayed when users click "Show all...". If the window contains 4 or 5 levels, the window will be resized accordingly to accommodate them all.

The number of levels displayed in the facets panel of the Faceted search page is consistent with the number of levels the administrator selects on the Faceted search configuration page.

"Pre-filtered" URLs for Standard Career Sections Redirect Candidates to Mobile Career Sections

When candidates using a mobile device click links to "pre-filtered" searches on a standard career section for which Faceted search is enabled, the candidates are redirected to the associated mobile career section and a Faceted search using the same search parameters is performed. For a more detailed explanation, see ["Pre-filtered" URLs for Standard Career Sections Redirect Candidates to Mobile Career Sections](#)

Configuration

Career Section administrators can select the OLF that will be displayed in pop-up windows when candidates type in OLF search fields or click "Show all..." links on the Faceted search page.

Properties	Location
Job Field level displayed Organization level displayed Location level displayed	Configuration > [Career Section] Administration > Career Sections > (click career section name) > [Career Portal Pages] Show > Faceted Search > Edit Properties

Migration

OLF elements as search criteria on the Faceted search page are restricted to the OLF elements configured for the career section's properties. This is a new, desired behavior. If no OLF elements are configured for the career section's properties, all OLF elements are displayed as search criteria on the Faceted search page.

The OLF levels selected for a career section's "Levels displayed in the Candidate Profile" property prior to migration to 15A become the OLF level selections on the Faceted search properties page immediately following migration.

Customers are advised to review the levels displayed on the "facets" panel and "Show all..." links following migration.

Save This Search

The **Save this Search** feature is located above the list of jobs. When candidates click **Save this Search**, the area is expanded and candidates can provide a name for their search and save the search. Candidates can retrieve the saved search criteria and filters at a later time to look for similar jobs (Save this search > Access My Saved Searches).

My Profile

All information related to a candidate such as profile information, account information, saved searches, referrals, jobs matching my profile is grouped under the Profile menu. If the candidates are logged into a career section, they can access this menu by clicking the small triangle next to their name.

Save Job and Job Cart

The Save Job action is displayed in the Actions column, via the Action drop-down list. Once candidates or employees save a job, they can view it by clicking the Job Cart icon located in the top-right corner of the career section page.

Refer a Friend

The Refer a Friend action is displayed at the bottom of the career section page.

Help Panel

When enabled, the help panel is available on the right side of the career section page. It is collapsed by default. To see the content of the help, candidates click the help icon.

Details on Autosuggest and Filters

Autosuggest is used in the search bar fields. Autosuggest behavior may change depending on the field where it is being used.

Field	Description
Keyword	<ul style="list-style-type: none"> At least two characters must be typed. The system suggests words based on posted requisitions in the career section. Order of words is alphabetical.
Job Title	<ul style="list-style-type: none"> At least two characters must be typed. The system suggests words based on posted requisitions in the career section. Order of words is alphabetical.
Organization Location, Job Field	<ul style="list-style-type: none"> At least two characters must be typed. <p>The list of values displayed is dynamic: each time users type or delete a character in an OLF field, the list of suggested values is updated so the list always displays the most appropriate matches. Users can make a selection from the list while it is displayed and that value will be entered in the field.</p> <p>The list includes only "exact" matches and their "children". For example, if a user typed "jersey" in the Location field, the state "New Jersey, United States", and cities "Atlantic City, New Jersey, United States" and "Cherry Hill, New Jersey, United States" might be displayed in the list but not the country "United States".</p> <p>The list is typically ordered from "highest" level to "lower" levels. For example, if a user typed "cal" in the Location field, "California, United States" would appear before "Fresno, California, United States". Items at the same level are listed in alphabetical order.</p>
Requisition Number	No autosuggest.
Boolean operators, double quotes and parenthesis	Boolean operators (AND, OR, NOT) are ignored in the search. Double quotation marks and parentheses are also ignored.

Filters show the exact number of jobs even if some requisitions include multiple locations. For example, if a requisition is for Montreal and Toronto, there will be a single job in the "Canada" filter.

Once a filter is selected, the other filter categories automatically readjust the count, but the filters within the same category do not. For example, if candidates filter the job list using "Toronto", then the count for the number of part-time and full-time jobs will change but the count for other locations will remain the same.

When candidates select multiple filters, the system adjusts the total of other categories so they reflect the multiple items selected.

Faceted Search Properties

Property	Description
Displayed	When set to Yes, the Job Search page is displayed in the career section. The Basic Search and the Job List career portal pages are automatically disabled. However, the Advanced Search and the Personalized Job List pages are still available.
Help panel displayed	When set to Yes, the Help icon is displayed in the career section and candidates can access helpful information by clicking the icon.
Search on multilingual jobs	<p>Career sections can be configured such that if job lists contain jobs posted in multiple languages, candidates and employees can use the "Jobs available in" filter at the top right-hand corner of search pages to limit the jobs displayed to those posted in a specific language. For example, a candidate selects the Spanish language from the "Jobs available in" list. The system then displays the jobs posted in the selected language.</p> <p>The "Jobs available in" list is displayed in a career section provided:</p> <ul style="list-style-type: none"> • Multiple languages are enabled in the career section. • The career section includes jobs posted in multiple languages. • In Configuration, the Faceted Search is enabled and the "Search on multilingual jobs" property is set to Yes on the Faceted Search properties page.
Displayed filters	<p>Filters appearing in the filter panel.</p> <p>The order of how filters are displayed to candidates can be specified using the up and down arrows. An option is available to expand the filter block by default.</p>
Search bar fields	<p>Fields appearing in the search bar. A maximum of three fields can be selected.</p> <p>The Keyword field searches the following fields: Requisition Title (Job Title), Requisition Number (Job Number), Requisition Description, Requisition Qualifications.</p> <p>The order of how fields are displayed to candidates can be defined using the up and down arrows.</p>
Filter panel location	Three location options are available: Left, Right or Off.
Default job list layout	Career Section administrators can determine which job list layout (or view) will be displayed by default on the Faceted search page and whether users will be able to switch between job list layouts. See the "Default job list layout" section in <i>Faceted Search</i> .
Allow job list layout modification	<p>Administrators can impose a single layout (single line or multiple line) or they can enable candidates to switch between layouts.</p> <p>If Career Section administrators enable candidates to switch between views, a link is displayed in the career section at the top of the job list, right side of the Faceted search page. Candidates click the corresponding link: "Single-line" to display information about each job on a single line; "Multi-line" to display information about each job on multiple lines.</p>

Property	Description
Display the job posting date with date and time. If you select No, only the date will be displayed.	
Display the job unposting date with date and time. If you select No, only the date will be displayed.	
Job list sorting	The selections made in this section determine the choices that will be displayed in the Sort by list. Faceted search users will be able to make a selection in the list and the job list will be sorted automatically by that criterion.
Job list columns	The selections made in this section determine the job list columns displayed on the Faceted search page, single-line mode.
Sorting Direction	
Always show urgent need jobs on top of the job list	If Yes is selected, jobs flagged as urgent need will be displayed at the top of the job list regardless of sorting criterion.

Sorting of Faceted Search Results

Visitors to a career section can sort the results of faceted searches.

After performing a faceted search, users click the Sort by field at the top of the job list and select a sorting criterion. The list is sorted automatically to reflect the sorting selection. In addition, they can display the sorted list in ascending or descending order by making the corresponding selection in the Ascending/Descending list. If users (i.e. candidates or employees) switch between "Single-line" and "Multi-line displays, the jobs continued to be sorted according to the sorting selection until the users make a new sorting selection.

Each time users visit the career section, jobs are first sorted using the default sorting criterion chosen by the Career Section administrator.

Career Section administrators can decide which fields users can select to sort faceted search results and they can also set the default sort field. Administrators can make any or all of the following fields available for sorting faceted search results at a particular career section: Job Title, Location (i.e. Primary Location), Posting Date, Relevancy, Schedule, Unposting Date and Urgent Need. In addition, administrators can decide whether the jobs in Faceted search result lists are displayed in ascending or descending order by default (regardless of which sorting selection users will make). The one exception is Relevancy: this field is always present in the Sort by list and if users select Relevancy, jobs are always listed in descending order (i.e. the most relevant jobs at the top of the list and the least relevant jobs at the end of the list).

Career Section administrators can decide that jobs identified as "urgent need" jobs are displayed at the top of faceted search result lists regardless of the sorting selection that users make. Suppose an administrator selects this option and a user later sorts a Faceted search result list by Location and in ascending order. Jobs identified as "urgent need" jobs would be displayed first in alphabetical order of location, followed by the other jobs also sorted in alphabetical order of location.

If system administrators make no selections, jobs are sorted by Relevancy in descending order.

More generally, the sorting engine first considers "urgent need" jobs if Career Section administrators select that option. It then considers the sorting criterion selected by users, then keyword relevancy (alphabetical order), then posting date (numerical order), and finally requisition ID (alpha-numeric order).

Configuration

Setting	Location
Job List Sorting	Configuration > [Career Section] Administration > Career Sections > (click a career section) > [Career Portal Pages] Show > Faceted Search > Edit Properties
Sorting Direction	Configuration > [Career Section] Administration > Career Sections > (click a career section) > [Career Portal Pages] Show > Faceted Search > Edit Properties
Always show urgent need jobs on top of the job list	Configuration > [Career Section] Administration > Career Sections > (click a career section) > [Career Portal Pages] Show > Faceted Search > Edit Properties

Dependency for Fields in Faceted Search

If certain fields have been configured such that they are not displayed in career sections generally, they cannot be selected on the Faceted search configuration page for display on the Faceted search page of the career section.

The fields are found in the following three sections on the Faceted search configuration page:

- Displayed filters
- Search bar fields
- Job list columns

This feature is best explained by a series of examples. Take the case where the system administrator has configured the Job Field field such that it is not displayed in career sections generally. The administrator does this by going to Configuration > [Recruiting] Administration > [Fields] Requisition > Job Field > Edit Field Availability, and ensuring the check box next to Career Section is not selected. If the system administrator next goes to the Faceted search configuration page of a career section, Configuration > [Career Section] Administration > Career Sections > (click a career section) > [Career Portal Pages] Show > Faceted Search > Edit Properties, the Job Field field is not displayed in the Displayed filters, Search bar fields and Job list columns lists so it cannot be added.

If the system administrator configures the Job Field field such that it is displayed in career sections generally, the field becomes available for selection in the Displayed filters, Search bar fields and Job list columns lists on the Faceted search configuration page. The administrator can then select Job Field to make it available in the corresponding section of the Faceted search page of the career section.

A third case is where a field such a field was added to the Faceted search configuration page and later the system administrator configured the field such that it was not displayed in career sections generally. The field is displayed as a selection on the Faceted search page, however, a yellow icon next to the field serves to indicate that the field was disabled for career sections generally and consequently the field will not be displayed on the Faceted search page in the career section.

If the field is later made available for display in career sections generally, the yellow icon is no longer displayed next to the field on the Faceted search configuration page, indicating that the field is displayed anew in the career section.

Configuring Faceted Search

The configuration of the faceted search consists of the following steps.

1. Oracle Support must enable the **Faceted Search** protected setting (Configuration > [Career Section] Settings). Once the setting is enabled, the Faceted Search career portal page becomes available.
2. *Configuring the Faceted Search career portal page.*
3. *Configuring the theme for Faceted Search elements.*

Configuring the Faceted Search Career Portal Page

Before you start

The *Access the Career Section administration section* user type permission grants users access to this feature.

Career section must have Inactive or Draft status.

Configuration > [Career Section] Administration > Career Sections

Here's what to do

1. Click the name of a career section.
2. Click **Show** next to **Career Portal Pages**.
3. Click the **Faceted Search** career portal page.
4. Click **Edit Properties**.
5. Define each property. For details, see *Faceted Search Properties*.
6. Click **Save**.

Configuring the Theme for Faceted Search

The Theme elements that currently exist for the career section will automatically map to the new Faceted Search theme elements.

There are a few Theme elements specific to the Faceted Search page.

Path: Configuration > [Career Section] Administration > Themes > select a theme

Configurable Element	Style Class
Background and Color Configuration	1054 – Faceted Search - Selected Filters Bar: Color used for the bar containing selected search filters. 1050 – Faceted Search - Search Bar: Color used for the search bar located at the top of the page.
Text Configuration	1051 – Faceted Search - Search Label: Color used for the labels on the search bar located at the top of the page.

Configurable Element	Style Class
	<p>1055 – Faceted Search - Selected Filters Bar: Style used for the labels on the bar containing selected search filters.</p> <p>1056 – Faceted Search - Filter Title: Style used for the filter block title on the filters panel.</p> <p>1057 – Faceted Search - Filter Name: Style used for the filter name on the filters panel.</p> <p>1058 – Faceted Search - Filter Count: Style used for the filter count on the filters panel.</p>
Input and Button Control Configuration	<p>1052 – Faceted Search - Search Button: Style used for the button on the search bar located at the top of the page.</p> <p>1053 – Faceted Search - Result List Button: Style used for the button on the search result panel.</p>
Link Configuration	<p>1062 – Faceted Search - Title Link: Style used for the Job Title text.</p> <p>1063 – Faceted Search - Title Link (Mouse Over Event): Style used for text that displays when the link is moused over.</p> <p>1064 – Faceted Search - Search Modal Link: Style used for the <i>See all locations</i> link.</p> <p>1065 – Faceted Search - Search Modal Link (Mouse Over Event): Style used for text that displays when the link is moused over.</p> <p>1066 – Faceted Search - Expand Facet Link: Style used for the <i>Show more/Show less</i> link.</p> <p>1067 – Faceted Search - Expand Facet Link (Mouse Over Event): Style used for text that displays when the link is moused over.</p>

Career Sections - Other Configuration Tasks

Creating a Career Section

Before you start

The *Access the Career Section administration section* user type permission grants users access to this feature.

If the system administrator chooses to customize the options of the Career Section, the selections used for customization must first be created.

Configuration > [Career Section] Administration > Career Sections

Here's what to do

1. Click Create next to Career Sections.

2. Complete the *properties fields*.
3. Click Save.

Results:

The Career Section appears in the Career Sections list.

Previewing a Career Section

Before you start

The *Access the Career Section administration section* user type permission grants users access to this feature.

Configuration > [Career Section] Administration > Career Sections

Here's what to do

1. Click the name of a Career Section.
2. Click Show next to Career Section URL.
3. Click Preview.
4. Click the URL presented in the message box.

Results:

The system automatically creates a candidate in the Career Section with your current login information and then it logs you directly into the Career Section using this candidate's account. The data you create in the Career Section is saved under this candidate's name. You can afterwards access this data in the Recruiting Center and delete it.

Activating a Career Section

Before you start

The *Access the Career Section administration section* user type permission grants users access to this feature.

Career section must have Inactive or Draft status.

Configuration > [Career Section] Administration > Career Sections

Here's what to do

1. Click the name of the Career Section.
2. Click Activate next to the name of the Career Section.

Results:

The Career Section can be associated to an URL and used by your organization.

Deactivating a Career Section

Before you start

The *Access the Career Section administration section* user type permission grants users access to this feature.

Configuration > [Career Section] Administration > Career Sections

Here's what to do

1. Click the name of the Career Section.
2. Click Deactivate next to the name of the Career Section.

Results:

The Career Section properties can be edited and can no longer be associated to an URL.

Deleting a Career Section

Before you start

The *Access the Career Section administration section* user type permission grants users access to this feature.

Career section must be inactive or draft.

All requisitions posted on the Career Section must be deleted, not only unposted.

Configuration > [Career Section] Administration > Career Sections

Here's what to do

Click Delete located on the same row as the Career Section name.

Results:

The Career Section can no longer be associated to an URL and used by your organization.

Editing the Properties of a Career Portal Page

Before you start

The *Access the Career Section administration section* user type permission grants users access to this feature.

Career section must have Inactive or Draft status.

Configuration > [Career Section] Administration > Career Sections

Here's what to do

1. Click the name of a Career Section.
2. Click Show next to Career Portal Pages.
3. Click the name of a career portal page.
4. Click Edit Properties.
5. Make changes.
6. Click Save.

Displaying a Career Portal Page

Before you start

The *Access the Career Section administration section* user type permission grants users access to this feature.

Career section must have Inactive or Draft status.

Configuration > [Career Section] Administration > Career Sections > Career Section name

Here's what to do

1. Click the name of a career portal page.
2. Click Edit Properties.
3. Select Yes from the Displayed list.
4. Click Save.

Results:

The career portal page is displayed in the Career Section.

Hiding a Career Portal Page

Before you start

The *Access the Career Section administration section* user type permission grants users access to this feature.

Career section must have Inactive or Draft status.

Configuration > [Career Section] Administration > Career Sections > Career Section name

Here's what to do

1. Click the name of a career portal page.
2. Click Edit Properties.
3. Select No from the Displayed list.
4. Click Save.

Results:

The career portal page is not displayed in the Career Section.

Hiding the Job List

Before you start

The *Access the Career Section administration section* user type permission grants users access to this feature.

The career section must have Inactive or Draft status.

All available languages in the Career Section must be active.

An *alternate URL must be populated* for each language.

Configuration > [Career Section] Administration > Career Sections > Career Section name > [Career Portal Pages] Show

Here's what to do

1. Click Job List.
2. Click Edit Properties.
3. Select No in the Displayed list.
4. Click Save.

Changing the Text of a Career Portal Field

Before you start

The *Access the Career Section administration section* user type permission grants users access to this feature.

Text in tabs, links, fields and buttons appearing in career portal pages can be changed if the text has a product resource identification number.

You need the resource identification number of the field. You can look at the list of IDs in the Appendix or you can display the resource identifiers associated to the field.

Configuration > [Career Section] Administration > Career Sections > Career Section name

Here's what to do

1. Access the career portal page where the field is located.
2. Locate the IDs you wish to modify. You can refine the list by resource number.
3. Click on the resource.
4. Click Edit next to Properties.
5. In the Override field, type the new field label. Maximum of 1,000 characters.
6. Click Save.

Adding a Line to the Layout of Job Information

Before you start

The *Access the Career Section administration section* user type permission grants users access to this feature.

Career section must be inactive.

Lines cannot be added between two existing lines.

Lines cannot be reordered.

Configuration > [Career Section] Administration > Career Sections

Here's what to do

1. Click the name of a Career Section.
2. Click Show next to Career Portal Pages.

3. Click the name of a career portal page.
4. Click Edit Layout.
5. Select Add a line from the drop down menu.
6. Click Add.
7. Click Save.

Results:

A new line is added to the carer portal page.

Removing a Line from the Layout of Job Information

Before you start

The *Access the Career Section administration section* user type permission grants users access to this feature.

Career section must be inactive.

Lines cannot be reordered.

Configuration > [Career Section] Administration > Career Sections

Here's what to do

1. Click the name of a Career Section.
2. Click Show next to Career Portal Pages.
3. Click the name of a career portal page.
4. Click Edit Layout.
5. Click Delete Line next to the line to delete.
6. Click Save.

Results:

The line is no longer displayed in the Career Section.

Adding a Field to the Layout of Job Information

Before you start

The *Access the Career Section administration section* user type permission grants users access to this feature.

Career section must be inactive.

Fields for the Career Section must have been created by a Recruiting administrator.

Configuration > [Career Section] Administration > Career Sections

Here's what to do

1. Select the name of a Career Section.
2. Click Show next to Career Portal Pages.
3. Click the name of a career portal page.

4. Click Edit Layout.
5. Select a line.
6. Select a field from the Available Fields list.
7. Click Add a Field.
8. Click Save.

Results:

The selected field is added to the layout of the job in the career portal page.

Removing a Field from the Layout of Job Information

Before you start

The *Access the Career Section administration section* user type permission grants users access to this feature.

Career section must be inactive.

Configuration > [Career Section] Administration > Career Sections

Here's what to do

1. Select the name of a Career Section.
2. Click Show next to Career Portal Pages.
3. Click the name of a career portal page.
4. Click Edit Layout.
5. Select a field in a line of the Job Layout section.
6. Click Delete Selected Item.
7. Click Save.

Results:

The line no longer includes the field. The field is not longer displayed in the job information.

Adding a Title to the Layout of Job Information

Before you start

The *Access the Career Section administration section* user type permission grants users access to this feature.

Career section must be inactive.

Configuration > [Career Section] Administration > Career Sections

Here's what to do

1. Click the name of a Career Section.
2. Click Show next to Career Portal Pages.
3. Click the name of a career portal page.
4. Click Edit Layout.
5. Select a line.

6. Select a label from the Available Labels list.
7. Click Add a Label.
8. Click Save.

Results:

The title is included in the selected line. The title is displayed in the job information when the career portal page is displayed in a Career Section.

Removing a Title from the Layout of Job Information

Before you start

The *Access the Career Section administration section* user type permission grants users access to this feature.

Career section must be inactive.

Configuration > [Career Section] Administration > Career Sections

Here's what to do

1. Select the name of a Career Section.
2. Click show next to Career Portal Pages.
3. Click the name of a career portal page.
4. Click Edit Layout.
5. Select a label in a line.
6. Click Delete Selected Item.
7. Click Save.

Results:

The title no longer appears in the line.

Adding a URL in a Career Section

Before you start

The *Access the Career Section administration section* user type permission grants users access to this feature.

Career section must have Inactive or Draft status.

Configuration > [Career Section] Administration > Career Sections

Here's what to do

1. Click the name of a Career Section.
2. Click Add URL next to Career Section URL.
3. Enter a code.

The code must be unique. The URL code must not include multi-byte characters. This is because the code forms part of the URL and multi-byte characters in Oracle Taleo Enterprise Edition Career Section URLs are not supported.

4. Select a default language.

5. Select the default page that will be displayed when accessing the career section.
6. Specify the URL parameters of the page where candidates will land.
7. Click Save.

Results:

The new URL is now available to be used in the Career Section.

Deleting a URL in a Career Section

Before you start

The *Access the Career Section administration section* user type permission grants users access to this feature.

Configuration > [Career Section] Administration > Career Sections

Here's what to do

1. Click the name of a Career Section.
2. Click Show next to Career Section URL.
3. Click Delete.

Results:

The URL is no longer available to be used in a Career Section.

Adding a URL to a Career Section Field

Before you start

The *Access the Career Section administration section* user type permission grants users access to this feature.

The HTML editor must be supported for the field.

Configuration > [Career Section] Administration > Career Sections

Here's what to do

1. Create an additional URL for a Career Section.
2. Copy the partial URL displayed in the URL column of the Career Section URL list.
3. Preview the Career Section.
4. Paste the partial URL copied at step 2 after the desired zone URL.
 - o Example
 - o Partial URL: /cp1/profile.ftl?lang=en
 - o Career Section URL: http://v750sp1.qa.rsft.net/careersection2/jobsearch.ftl?lang=en
 - o Complete URL to use: http://v750sp1.qa.rsft.net/careersection2/cp1/profile.ftl?lang=en
5. You need the resource identification number of the field. You can look at the list of IDs in *the appendix* or you can display the resource identifiers associated to the field.
6. Access the career portal page when the field is located.
7. Locate the ID you wish to modify. You can refine the list by resource number.

8. Click on the resource.
9. Click Edit next to Properties.
10. In the Override field, click the link icon.
11. Paste the URL in the URL field
12. Click OK.

Onboarding (Transitions) Tasks in Career Sections

Onboarding (Transitions) Tasks in Standard Career Sections

If Onboarding (Transitions) is enabled in your organization and a Recruiting Center user starts a process for someone, the candidate or employee can view on the career section Tasks tab the tasks he or she has to perform. The tab is displayed in every career section to which the person has access.

The Tasks tab is divided into two sections. The left panel displays the list of tasks assigned to a person. When clicking a task in the left panel, the information associated with the selected task is displayed in the right panel. The "information" might be forms to be completed, links to PDF documents, electronic offers, email correspondence, rich content tasks that can include images and links and provide information about almost anything (a welcome message, documents about policies within the organization, the specific job and work the new hire will perform, volunteer opportunities, the campus where the person will be working, etc.).

Displaying the Tasks tab in the career section

All career sections that a person can access display the Tasks tab. This includes internal and external career sections. There is no way for a Career Section Administrator to turn off the Tasks tab: it appears if it is relevant for the logged-in user. The Tasks tab for a given candidate appears on every single career section to which the candidate has access. A career section can be configured so that a single URL directs candidates to an external career section before they are hired, and directs candidates to an internal career section once they are hired and become employees.

As soon as the first task in a process gets assigned to the candidate/new hire, the Tasks tab appears on the person's career sections. Processes that are running but have not yet assigned any tasks to the candidate/new hire are not accessible on the career sections. As soon as the last task in a process gets completed and the process reaches 100% Complete, then all of these tasks cease to be accessible on the career sections. If there are no other Onboarding (Transitions) processes running at this time, the Tasks tab disappears. Note that several Onboarding (Transitions) processes can be running for the same person, for example for different requisitions, or for one Pre-Hire process and one New Hire process for the same requisition.

Note that the label "Tasks" can be changed, like any text in any career section. This is helpful for instance if only Offboarding tasks are being handled on a given career section.

In addition, a separate career section can be configured which only contains the Tasks tab. See [Onboarding \(Transitions\)-Only Career Section](#).

Accessing tasks in the career section

Candidates, new hires or employees can click the Tasks tab while in the career section.

- If one process is running with at least one In Progress task, they land on that task. If the process has more than one In Progress task, they land on the first In Progress task.

- If one process is running but all the tasks currently assigned to the candidate are Complete, they land on the first Complete task.
- If more than one process is running, they land on a page that lists each running process. The name of the process is displayed, there is a graphic of how many tasks are complete out of the total tasks, and candidates can click the tasks of each process.

Candidates, new hires or employees can also receive an email message containing a link to the specific task or to their Tasks tab (and hence to all their tasks).

Displaying completed tasks

If candidates, new hires or employees arrived at the task after clicking the Tasks tab or after clicking the URL in the email they received, the system will automatically show them the next In Progress task after they complete/submit a task. If there is no In Progress task after this one, and if the process is still not 100% complete, the system will bring them back to the first Completed task.

If candidates, new hires or employees arrived at the task by clicking on its name in the left-hand side of the Tasks tab, then the system will remain on the current task after they click to complete it. They can now choose to click another task name in the list at the left-hand side of the page.

If this was the last task and its completion caused the overall process to reach 100% Complete, with no additional tasks waiting for any other assignees, then this process will disappear from the career section. The candidates, new hires or employees can no longer access any completed tasks nor PDF documents or reference hyperlinks within that process. If there are no other Onboarding (Transitions) processes running for this candidate, then the Tasks tab will disappear. Each task gets completed in its own way:

- User-defined form task: The person reads the instructions or other text; clicks any hyperlinks to visit any resources or sites; reviews or updates the data in any fields, especially the mandatory required fields; provides any e-Signature that is required; visits the Learn page from the URL if any is configured in the form; clicks the Submit button when done. Note that there is no option to save a partially-completed form; any changes that are made in the form are lost if they are not submitted.
- Document task: The only information shown on the right panel of the Tasks tab is the name of the PDF document. When the person clicks the name of the document, the browser opens the PDF in a new tab, depending on the browser version and settings. This PDF can contain personalized information due to any variables that it contains. By clicking to open the PDF, the person has automatically changed this task's status to Completed; there is no additional button to click.
- Correspondence task: The person can open and view the email message sent to him/her. The Send Correspondence type of task is automatically in status Completed from the moment it appears; there is no way for the candidate to mark it complete. The email message is a copy of what was emailed by the Send Correspondence type of task. Any additional reminders or notifications for any other tasks are not displayed here; those emails only go to the selected email address of the candidate. Also, this is not related to the Secure Message Center where Recruiting's messages can be displayed, for zones that have configured this feature.
- Content Page task: The person can read the content and can also access any hyperlinks or resources that are embedded within the content. Some organizations may find that the history tracking for task completion provides a sufficient audit mechanism, so that using separate forms to gather Eignatures is not necessary.
- Partner Service task: This is a special kind of correspondence task, configured to provide partner-related information. It may contain a URL to visit the partner so that the candidate can do any necessary actions, or it may simply contain partner data and updates. This task appears in the status "In Progress", and there is no button/way to mark this task as complete. When the overall partner communication is completed and the final results have been sent from the partner back to the system, then this task is automatically completed.

Configuring the Tasks tab

For the Tasks tab to be displayed in career sections, the Onboarding (Transitions) Administrator must configure an Onboarding (Transitions) process and assign tasks to the New Hire role. When the process starts and a task is assigned to the new hire, the new hire sees the Tasks tab in the career section. There is no configuration to be done in the Career Section Administration menu to make the Tasks tab appear.

The Tasks tab must share the same theme, branding and colors as the rest of the career section. This provides a look and feel that is familiar to people who visited the career section as a candidate and return to perform other tasks while employed at your organization.

Just like any other career section, it is always possible for the Career Section Administrator to select one place in each career section that will be the default landing page for candidates after they log in.

Files Uploaded from Tasks Tab Available in Onboarding (Transitions) Center

Organizations can invite or require new hires to submit files through the Career Section Tasks tab as part of their Onboarding (Transitions) processes and the uploaded files will be available in the Onboarding (Transitions) Center.

Tasks on the Career Section Tasks tab can be used to invite or require new hires to upload files. A driver's license, social security card, and academic transcripts are a few examples of documents that some organizations might want new hires to submit in digital form as part of an Onboarding (Transitions) process.

Candidate File Upload in Onboarding Center

Enables the onboarding specialist to upload files to a new hire's onboarding process from the Onboarding Center. This allows files to be added and replaced at any time during or after the onboarding process, whether that process is active, completed or canceled. Files may only be uploaded into the file categories which are configured on the Content Pages for the process through which the candidate is being onboarded. History tracking is provided.

Career Section Tasks Tab

When new hires are involved in a process that includes a content page configured for file uploading, the corresponding task is displayed on the Career Section Tasks tab. The following screenshot is an example of how the task might be displayed on the Tasks tab to new hires.

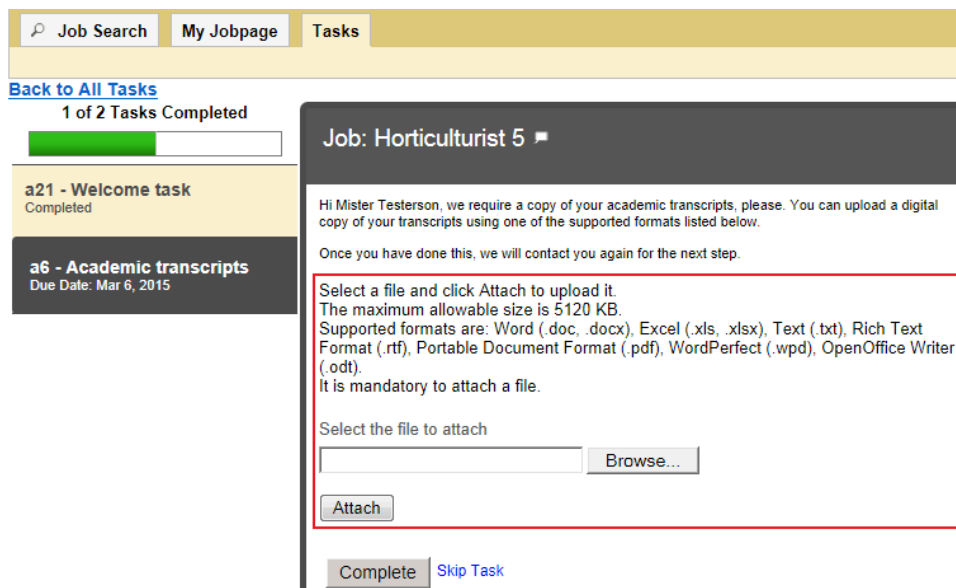

The new hires locate and attach the file they want to upload to complete the task. They can select a different file from the one they initially selected provided they have not yet clicked Complete. Once they click Complete, the file is uploaded immediately and usually cannot be changed afterward.

Files are scanned for viruses before they are uploaded to the Oracle Taleo system.

What if the task was completed and it was necessary to replace the file with another version of the same file or with a different file altogether? There are two possibilities.

- The Onboarding (Transitions) administrator could reassign the content page task to the new hire.
- The Onboarding (Transitions) administrator could have included a second content page task later in the process, a task assigned the *same* file category. (The file uploaded first would be replaced by the file uploaded later.)

New hires can upload a single file via a content page. If organizations want to request multiple files, the process requires multiple content pages and each content page in the process must have a unique file category.

Onboarding (Transitions) Center

In the Onboarding (Transitions) Center, the uploaded files associated with a process are displayed in the Candidate Files section on the process page, whether the process's status is In Progress or Completed. To display or download an uploaded file, users click the corresponding link.

System Documents | Add

1-1 out of 1 | << < 1 > >>

<input type="checkbox"/>	Name ▲	Code	Size	Delete
<input type="checkbox"/>	a3 cover page	a3 cover page	13 KB	<input type="button" value="Delete"/>

1-1 out of 1 | << < 1 > >>

Candidate Files

1-2 out of 2 | << < 1 > >>

Name ▲	Category	Date	Size	Delete
HillcrestCollege.pdf	High school diploma	Mar 16, 2015, 2:25:17 PM	6 KB	<input type="button" value="Delete"/>
SCarolinaDriversLicense.docx	Driver's license	Mar 16, 2015, 2:24:57 PM	14 KB	<input type="button" value="Delete"/>

1-2 out of 2 | << < 1 > >>

Each file in the Candidate Files section includes a category. How is a category useful? The files might not have names that accurately indicate their content. Onboarding (Transitions) Center users would be unlikely to form an accurate idea of the content of a file named Reg-2468 helix.docx. If the file category was "High school diploma", however, users would understand immediately the type of information the file contained.

System Documents | Add

1-1 out of 1 | << < 1 > >>

<input type="checkbox"/>	Name ▲	Code	Size	Delete
<input type="checkbox"/>	a3 cover page	a3 cover page	13 KB	<input type="button" value="Delete"/>

1-1 out of 1 | << < 1 > >>

Candidate Files

1-3 out of 3 | << < 1 > >>

Name ▲	Category	Date	Size	Delete
Basic1.pdf	Driver's license	Feb 2, 2015, 11:52:42 AM	1681 KB	<input type="button" value="Delete"/>
Req-2468 helix.docx	High school diploma	Feb 2, 2015, 11:55:30 AM	55 KB	<input type="button" value="Delete"/>
SeanR_photo.docx	New hire photo	Feb 2, 2015, 12:02:04 PM	14 KB	<input type="button" value="Delete"/>

Onboarding (Transitions) Center users can delete file attachments from the Candidate Files section but they cannot upload file attachments to it. A deleted file cannot be restored. The dates and times displayed in the Candidate Files section are the dates and times when the uploads occurred and might differ from the dates and times when the new hires completed the tasks.

Configuration

To create a task enabling new hires to upload a file as part an onboarding process, Onboarding (Transitions) administrators need to create file categories, configure a content page that includes the file upload section, and then create a content page-based task that includes the content page.

1. Administrators create a file category for the type of document they plan to ask new hires to upload as part of an onboarding process. Perhaps a category for PDFs of university transcripts, or one for new hire photos, or another for a list of references and so forth.
2. Administrators create or edit a content page, add the file category they created in the previous step, and designate a file upload mandatory or optional.
3. Administrators create a content page-based task that contains the content page.

File Category

File categories are created in an operation separate from content pages. See the Onboarding (Transitions) Configuration Guide. Only file categories whose status is Draft can be deleted; categories whose status is Active can be disabled at any time.

Though the same file category can be assigned to multiple content pages, a 1:1 relationship is far more typical.

Note: Take the case of a process that included two content pages having the same file category. The file uploaded through the first content page would be replaced by the file uploaded through the second content page. In most cases, this would not be desirable. On the other hand, this method could be used effectively to overwrite a file with a more recent version. One example is a process including a content page requesting new hires to upload a scanned document. A subsequent task in the process might require a recruiter to verify if the quality of the scanned document was adequate. In the event that the document was deemed to be too blurry, the process could be routed to a second content page requesting new hires to upload a clearer scan of the document. When the new hire performed this task, the new file would overwrite the older one because only one file can be associated with a file category.

The following file category codes are used by the system and therefore cannot be used by Onboarding (Transitions) administrators: candidate, CONTACT, default, FLIPBOOK, GOAL, MESSAGE_SENT, MESSAGE_TEMPLATE, OFFER, OTHER, recruiter, REQUISITION, RESUME, REVIEW, TALENTUSER. Because these internal codes are case sensitive, administrators could use words as file category codes provided a different case is used.

Note: File categories have only a code; no name or description. Consequently, file categories cannot be translated into other languages at the present time. Take the case of an organization that enabled English, Japanese and Spanish and an administrator who created a category whose code was "Employer References". In a process that included a content page with the category, "Employer References" would be displayed in the Category column of the Onboarding (Transitions) Center for all users regardless of the language they were using in the product.

Content Page - File Upload Section

While creating or editing a content page, Onboarding (Transitions) administrators can add a file upload section, assign a category relevant to the type of file that new hires will be requested to upload, and specify whether uploading a file is mandatory or optional. If the action is mandatory, new hires will be unable to complete the task until they upload a file.

Content Page – New hire photo

This page allows you to modify an existing content page.

Mandatory fields are marked with a red indicator.

Properties

* Code

* Name

Default Content Page

Show file upload section below the content page

* File Category

File upload is mandatory

A content page can include only one file category and new hires can upload a single file via a content page. If organizations want to request multiple files, they can create as many categories and content pages as their needs require.

Note: The fact that content pages can be created and configured for specific organizations, locations and job fields (OLF) can be used to great effect. Suppose a transportation company wanted new hires based in New Zealand to provide a photocopy of a driver's license for that country. The administrator could create a specific content page to include a driver's license file category and the country location, New Zealand, in the OLF.

Permission required to create and configure file categories	Location
Manage task definitions, related sources, content pages, images, and file categories	Configuration > [SmartOrg] Administration > User Types > (select a user type) > Recruiting > [Onboarding (Transitions)] Edit

Permission required to view, download and delete candidates files in Onboarding (Transitions) Center	Location
View, add, print, and delete System Documents (PDFs), and view, add, and delete Candidate Files	Configuration > [SmartOrg] Administration > User Types > (select a user type) > Recruiting > [Onboarding (Transitions)] Edit

Setting	Location
Attached File Maximum Number	Configuration > [General Configuration] Settings
Attached File Maximum Size	Configuration > [General Configuration] Settings
Attachments Format Filter	Configuration > [General Configuration] Settings

Note: The Attached File Maximum Number and Attached File Maximum Size settings are shared with other Oracle Taleo Enterprise Edition products but are considered separately for each product. "Considered separately" in the sense that if Attached File Maximum Number was set to 5, a candidate could upload up to 5 files for a job submission and later, as a new hire, upload up to 5 more files during an onboarding process. "Shared" in the sense that if the setting value is changed to 2, the new maximum of 2 files applies to all products.

New Content Page Properties	Location
Show file upload section below the content page	Configuration > [Onboarding (Transitions)] Administration > Content Pages
File upload is mandatory	Configuration > [Onboarding Transitions] Administration > Content Pages > (click content page)

Candidate files uploaded during Onboarding (Transitions) processes can be exported through integration (TCC, TCB, API, Web services). The TransitionProcess entity includes a relation called "AttachedFiles". Using "AttachedFiles" (in the TransitionsProcess context), organizations can export the following candidate file information: Comment, CreationDate, FileContent, FileName, LastModificationDate, MimeType, Size, FileCategory, Status. Comment is not currently used so the field will not contain any information. Regarding FileCategory, the AttachedFiles entity can determine the code of the file category. Regarding Status, this is always set to "Active" (status code="ACTIVE"). Uploaded files are available for export immediately even if the new hire has not yet completed the task. It is not possible to import candidate files through integration.

If the export mode is set to "T-XML" or "CSV-entity", filtering on the FileCategory entity fields will work correctly provided the largegraph option is set to "False" in the export query. If the largegraph option is set to "True", filtering on the FileCategory entity fields will work correctly only when a mode other than T-XML or CSV-entity is used.

Onboarding (Transitions)-only Career Sections

An Onboarding (Transitions) career section type was developed for organizations who want to create task-oriented career sections for candidates or employees.

This career section type contains a single tab called "Tasks" where candidates, new hires or employees can complete their tasks. No job-related information such as the Job Search tab, the My Jobpage tab, job lists or application flows is available.

Dedicated Onboarding (Transitions)-Only Career Sections are ideal if you want to create distinct portals for specific purposes and audiences. You can create dedicated Onboarding portals for onboarding, "cross-boarding" (internal mobility), promotion, relocation, offboarding or other purposes. Each one can have theme, branding and colors that are different from your other career sections and you can rename labels if desired. A dedicated Onboarding portal for offboarding processes, for example, could have a unique theme, branding and colors and you could change the default tab name "Tasks" to "Offboarding".

Email messages which bring employees to these dedicated Onboarding (Transitions)-Only Career Sections must be configured to include the specific URL for that destination, rather than any variable. This is because only invited employees should find out about this career section; other more standard internal and external career sections should be configured to have earlier sequence numbers, so that these will receive all of the standard candidate traffic.

To create this type of career section, you select the Onboarding Portal type in the career section properties. By default, the Tasks tab appears. The My Account and Access Management career portal pages are enabled by default; the other career portal pages cannot be enabled. For details, see [Building an Onboarding \(Transitions\)-Only Career Section](#).

Building Onboarding (Transitions)-only Career Sections

The building of an Onboarding (Transitions)-only career section consists of the following steps. These steps are performed from the Career Section Administration menu:

1. **Creating a branding file (optional).** It is recommended to put custom information only at the top and bottom of the browser page. Constraining the width of the page by adding navigation or a margin at the left or right around the career section is not recommended. These items make the usable area within the career section very narrow. Though job searching might not be affected too much from a narrow page, the Tasks tab contains its own task list on the left, which occupies some space, leaving considerably less space for displaying forms, content, and other Onboarding (Transitions) tasks.
2. **Creating a privacy agreement.** Note that the other types of statement (e-Signature, Background Check Consent, Diversity) are irrelevant to the Onboarding (Transitions)-only career section. The privacy agreement must be associated with the Onboarding Portal career section type.
3. **Creating a theme (optional).**
4. **Configuring security options for career sections.** Security options can be configured specifically for the Onboarding (Transitions)-only career section.
5. **Defining the properties of the career section.** For details on which properties can be defined, see [Onboarding \(Transitions\)-only Career Section Properties](#).
6. **Configuring career portal pages.** The My Account and Access Management career portal pages are enabled by default; configure the properties as desired. The other career portal pages cannot be turned on.
7. **Changing the label of the Tasks tab (optional).** For example, if the Onboarding (Transitions)-only career section is used for offboarding, you could rename the tab Offboarding.

8. Enabling the **Activate SSL encryption** setting to ensure data sent from the candidate to the server is encrypted. (*Career Sections > select the Onboarding Portal career section > Security Settings*).
9. *Activating the career section.*
10. Creating an Onboarding (Transitions) message template (in the Onboarding (Transitions) Administration menu) and putting the Onboarding portal URL in the message sent to candidates, new hires or employees. This URL is available under *Career Sections > select the Onboarding Portal career section > Career Section URL > Show*). Do not use the standard variable {TransitionsURLs_Para.TaskAccessURL}.

Onboarding (Transitions)-Only Career Section Properties

Element	Description
General	
Code	The code must be unique
Name	The name must be unique.
Description	A brief description of the Career Section.
Type	Select Onboarding Portal.
Sequence	Before redirecting a candidate coming from a job specific URL (from a job board, a job posting notification, etc.) to a career section, the system first evaluates the career sections in order of sequence number from lowest to highest. For Onboarding (Transitions)-Only Career Section, make sure to put the Onboarding (Transitions)-only career section last in the sequence to avoid people landing on this career section by mistake.
Display the link allowing to deactivate the account in the My account page	Displays the Deactivate link in the My Account page to allow the candidate to deactivate his or her account. This can be useful if the My Account career portal page is enabled in the Onboarding (Transitions)-Only Career Section.
Authentication Privacy Agreement	
Name	In the Name list, select the privacy agreement you created for the Onboarding (Transitions)-Only Career Section.
Display the authentication privacy agreement before	Specify where the privacy agreement will appear in the career section. Possible options are before the Login page or the Registration page.

Element	Description
Corporate Brand	
Name	Corporate brand that will appear in the Onboarding (Transitions)-Only Career Section.
Theme	
Name	Theme that will appear in the Onboarding (Transitions)-Only Career Section.

Candidate Communication Agent

The Candidate Communication Agent module allows candidates to see job submission statuses and to always be informed of where they are in the application process.

You can display links allowing candidates to view:

- Their job submission statuses such as rejected, interviewing, screening, etc. on the My submission page and My referral page.
- The View Email Messages link on the My Submission page.

View Email Messages link: This feature provides an alternate means for candidates to receive messages. Candidates can also print messages and delete them. Messages can be emails or detailed text regarding the status of their job application. Only job specific email correspondence is displayed. Paper, fax and Onboarding correspondence is not displayed. When viewing a list of messages, the following information is provided:

- The title of the message.
- The name of the person who is sending the message.
- The date and time when the message was sent.
- The requisition for which the message is intended.

Messages are retained as long as the candidate's file is active and the candidate has not deleted the message.

All job specific messages generated by templates with a recipient value of *All Candidates* will appear with View Email Messages. Email messages must have a recipient value of *WebTop User* to be excluded from the candidates' view.

Displaying the Candidate Job Submission Status

Before you start

The *Access the Career Section administration section* user type permission is required to access this feature.

The *Enable Customization of Job Submission Statuses* Career Section setting must be set to Yes.

Career Section must be draft or inactive.

User-defined Job Submission Status must be created and activated.

Configuration > [Career Section] Administration > Career Sections

Here's what to do

1. Click the name of a Career Section.
2. In the Candidate Communication Agent section, select Yes from the Display user-defined job submission statuses in the My submissions page and in the My referrals page.
3. Click Save.

Results:

The job submission status of the candidate is displayed in the My submissions page and in the My Referrals page on the career section.

Hiding the Candidate Job Submission Status

Before you start

The *Access the Career Section administration section* user type permission is required to access this feature.

The *Enable Customization of Job Submission Statuses Career Section* setting must be set to Yes.

Career Section must be draft or inactive.

Configuration > [Career Section] Administration > Career Sections

Here's what to do

1. Click the name of a Career Section.
2. In the Candidate Communication Agent section, select No from the Display user-defined job submission statuses in the My submissions page and in the My referrals page.
3. Click Save.

Results:

The job submission status of the candidate is no longer displayed in the My Submissions page, and in the My Referrals page of the Career Section.

Displaying the View Email Messages Link

Before you start

The *Access the Career Section administration section* user type permission is required to access this feature.

The *Access to "View Email Messages"* Career Section setting must be set to Yes.

Career Section must be draft or inactive.

Configuration > [Career Section] Administration > Career Sections

Here's what to do

1. Click the name of a Career Section.

2. In the Candidate Communication Agent section, select Yes from the Display the "View Email Messages" link in the My Submissions page.
3. Click Save.

Results:

The View email Messages link is displayed to candidates in the My Submissions page of the Career Section.

Hiding the View Email Messages Link

Before you start

The *Access the Career Section administration section* user type permission is required to access this feature.

The *Access to "View Email Messages"* Career Section setting must be set to Yes.

Career Section must be draft or inactive.

Configuration > [Career Section] Administration > Career Sections

Here's what to do

1. Click the name of a Career Section.
2. In the Candidate Communication Agent section, select No from the Display the "View Email Messages" link in the My Submissions page.
3. Click Save.

Results:

The View Email Messages link is no longer displayed to candidates in the My Submissions page of the Career Section.

Technical Help Information

Providing technical help improves the candidate experience of those candidates who encounter issues and ensures that they can successfully complete the application process and perform other tasks such as job searches.

Technical help can be added to Career Sections, which can take the form of a text, a URL link, or an email address.

If technical help is enabled, the link is displayed at the upper-right and bottom-right corners of Career Section pages bearing the top and bottom "bars". The location of the links cannot be modified.

There are four technical help information types to choose from:

- None removes the technical help from the Career Section.
- Default displays the *technical help information type* configured in the Career Section global settings. The global setting default is None. If the global setting is text or link the content of TextTool Resource ID 2116390 in Resource Group Header Panel 102166 will display. If this content hasn't been provided no technical help will display.
- Link displays a hyperlink to the help page, or the email of the organizations support contact.
- Text displays a plain text help message such as "For help contact customer service 888-999-5555."

The technical help information type is automatically set to Default.

Customers who already provide technical help in another form on Career Sections have the option of disabling the Technical Help Information feature across all their Career Sections or on a specific Career Section.

Technical help information will not be displayed if in the Career Section properties:

- Technical Help type is set to none.
- Technical Help type is set to Default and the global *technical help information type* setting is set to none.
- Technical Help type is set to text and content is empty. This is not recommended as a technical help icon displays.
- Technical Help type is set to text and content is empty. This is not recommended as a technical help icon displays.

Displaying Technical Help

Before you start

The *Access the Career Section administration section* user type permission grants users access to this feature.

Career section must have Inactive or Draft status.

Configuration > [Career Section] Administration > Career Sections

Here's what to do

1. Click on the name of the Career Section.
2. Click Edit next to Properties.
3. In the Technical Help section, choose Default, Text, or Link.
4. Click Save.

Hiding Technical Help

Before you start

The *Access the Career Section administration section* user type permission grants users access to this feature.

Career section must have Inactive or Draft status.

Configuration > [Career Section] Administration > Career Sections

Here's what to do

1. Click on the name of the Career Section.
2. Click Edit next to Properties.
3. In the Technical Help section, choose None in the Technical Help Type list.
4. Click Save.

Results:

The help text no longer appears on the top right and bottom right of the Career Section.

Editing Technical Help Text

Before you start

The *Access the Career Section administration section* user type permission grants users access to this feature.

Career section must have Inactive or Draft status.

Career Section technical help type must be set to text.

Configuration > [Career Section] Administration > Career Sections

Here's what to do

1. Click on the name of the Career Section.
2. Click Edit next to Properties.
3. Edit the text in the Content editor.
4. Click Save.

Results:

The help text appears on the top right and bottom right of the Career Section.

Editing a Technical Help Link

Before you start

The *Access the Career Section administration section* user type permission grants users access to this feature.

Career section must have Inactive or Draft status.

Career Section technical help type must be set to link.

Configuration > [Career Section] Administration > Career Sections

Here's what to do

1. Click the name of the Career Section.
2. Click Edit next to Properties.
3. In the Technical Help section, click Source in the Content field.
4. Enter an hyperlink in the format `Help`.
5. Click Source to view the hyperlink as it will appear in the Career Section.
6. Click Save.

Results:

The help link appears on the top right and bottom right of the Career Section.

Career Section Sequence

The system searches the career sections in the order you configured (see the Sequence column of the Career Sections list) in determining to which career section candidates coming from a job specific URL (from a job board, a job posting notification, etc.) will be redirected.

To put this another way, when a candidate is coming from a job specific URL (from a job board, a job posting notification, etc.), the system has to redirect the candidate to a career section. The system evaluates which career section is the most appropriate one, first evaluating the career section that has the lowest sequence number before evaluating the career section that has the next lowest sequence number and so forth.

When a career section is created, it is automatically assigned the highest number of the sequence.

- For internal candidates, the system redirects the candidates to internal career sections first, going from lowest sequence number to the highest one.
- For external candidate, the system redirects the candidates to external career sections, going from the lowest sequence number to the highest sequence number.

System administrators can change the sequence i.e. change the order in which the career sections are chosen by the system.

The sequence is also used in the candidate sourcing manager to sort the career section display in the posting page. Career sections are displayed on this page based on this sequence, all external sites being grouped first, followed by all internal career sites.

The career section sequence defined in the Career Section Reorder page is used when a message must be sent to a candidate and the system needs to find the career section where a job is posted. Suppose, for example, that the sequence of career sections is:

- 1- Internal (1) - (Internal)
- 2- Corporate - (External)
- 3- Career Fair - (External)
- 4- Students - (External)
- 5- Test - (External)

If an external career section is needed, the system first looks for the "2 - Corporate" career section. If the job is not posted on this career section, the system looks for the "3 - Career Fair", then the "4 - Students", etc.

Defining the Sequence of Career Sections

Before you start

The *Access the Career Section administration section* user type permission grants users access to this feature.

Configuration > [Career Section] Administration > Career Sections

Here's what to do

1. Click Reorder.
2. Click the career section whose relative position you want to change, and move the career section to the new position by clicking the green up and down arrows as necessary.

3. Click Save.

The new position is displayed in the Sequence column of the Career Sections list.

Results:

The system searches the career sections in the order you configured (see the Sequence column of the Career Sections list) in determining to which career section candidates coming from a job specific URL (from a job board, a job posting notification, etc.) will be redirected.

Public or Private Career Sections

Career Section administrators can configure the Display Type property to designate a career section as public or private. A URL that does not include a precise career section code cannot lead candidates to a career section whose Display Type property is set to Private.

The Display Type property can be used to do two things:

- Career sections created to gather additional information from candidates selected for a job or involved in an offer process can be configured such that they will be unavailable to other, "uninvited" candidates (Display Type: Private).
- It is possible to "hide" a career section from the sitemap (job scraping) feature (Display Type: Private).
- A career section's Display Type property can be set to Private to automatically exclude the career section from the logic used to resolve the Click Here link URL variables in message templates.

Most of the text in this section provides context and explanations regarding the first point.

Ensuring "uninvited" candidates are not directed to career sections created to gather additional information from candidates selected for a job or involved in an offer process.

URLs may or may not include a career section code. An example of a URL that includes a career section code is: <https://zone.taleo.net/careersection/ex/jobdetail.ftl?job=1500123> where "ex" is the career section code and "1500123" is the requisition number. An example of a URL that does not include a career section code is: <https://stghere.taleo.net/careersection/jobdetail.ftl?job=1500123>. Two examples of URLs that do not typically include a career section code are jobs posted on job boards and URLs sent to Job Distribution Enablement (JDE) integrators.

URLs that do not include a career section code use the sequence order as displayed in the Sequence column in the list of career sections (*Configuration > [Career Section] Administration > Career Sections*) to direct candidates to the most appropriate career section.

For example, a URL that does not include a career section code typically brings external candidates to the external career section that has the lowest sequence number among the career sections on which the job is posted. Similarly, if the system identifies candidates as internal, the system directs them to the internal career section that has the lowest sequence number among the internal career sections on which the job is posted.

Organizations might have situations where their recruiters want to invite selected candidates who completed a job submission through a public career section to visit a second career section to provide additional information (e.g. social insurance number, date of birth) that might be required for background screening or other pre-hire steps. Requisitions might have been "unposted" (removed) from the public career sections but they could continue to be posted on the second career section for the purpose of gathering additional information from candidates selected for a job or involved in an offer process. How can organizations ensure that candidates who access a URL that does not include a career

section code are not directed to a career section intended only for candidates who receive an invitation to provide additional information?

One method involves configuring the second career section (the one for requesting additional information from selected candidates) such that it has the highest sequence number among the career sections. Although this method can be very effective, if the second career section is the only place where the job is posted at a point in time, it will necessarily have the lowest sequence number among the career sections regardless of its number as displayed in the Sequence column. In such a case, some candidates who did not receive an invitation to visit the career section might land on the career section nonetheless. This might happen when:

- URLs do not include a precise career section code and are published on job boards or at other locations.
- Integrations are designed to pull all postings on external career sections.

A second, additional method consists of configuring the second career section as private. When external candidates access a URL that does not include a precise career section code, the system examines the external career sections that the job is posted on and selects the one that has the lowest sequence number *while excluding all private career sections*. Similarly, when internal candidates access a URL that does not include a precise career section code, the system examines the internal career sections that the job is posted on and selects the one that has the lowest sequence number *while excluding all private career sections*. To summarize, a URL that does not include a precise career section code cannot bring "uninvited" candidates to a private career section.

The second method also prevents job boards and web crawlers from indexing a career section.

Configuration

Administrators configure a career section as public or private through the Display Type career section property.

Property Name	Location
Display Type	Configuration > [Career Section] Administration > Career Sections > (click career section) > [Properties] Edit

The Display Type setting can be configured for external and internal career sections.

Because the Display Type property is not new, at migration the value (Public or Private) specified for each career section is maintained. However, if candidates or new hires click a career section URL that does not include a career section code, they will not be directed to any career section whose Display Type is Private.

Masking Personal Information

Some personal information candidates provide while completing a job submission or general profile can be masked after the candidates save the corresponding page.

The Date of Birth, Social Security Number and candidate user-defined fields can be configured such that if candidates enter a value in the field and save the page, the value is no longer displayed in the field and asterisks are displayed in place of the value on the Summary page.

If candidates save a page containing fields configured for masking and later edit their candidate profile or the job-specific application, the values remain masked and are not cleared. If candidates or employees enter a new value into one of those fields, the new value is not masked until the page is saved.

Likewise, if candidates or employees edit a field configured for masking and a drop-down list is involved, the current value is masked in the field, is not masked in the list and the user has no way of knowing which value is the current one. If no selection is made, the current value is retained and masked. If a new selection is made from the drop-down list, the selection is displayed normally in the field and is masked after the user saves the page.

Similarly, if candidates or employees edit a field configured for masking and multiple selections are possible, the current values are masked in the field. If new selections are not made, the current values are retained and masked. If new selections are made, they are displayed normally in the field and are masked after the user saves the page.

Candidates or employees might need to edit a date field configured for masking. In the case of a calendar picker, the calendar contains no indication of the current date selected. In the case of a drop-down list, the current value is masked in the field, is not masked in the list and the user has no way of knowing which value is the current one. If new a selection is not made, the current value is retained and masked. If a new selection is made, it is displayed normally in the field and is masked after the user saves the page.

Candidate user-defined fields that can be configured for masking can be of Text, Multilingual Text, Selection, Date, Number or Boolean type. The values that candidates enter will be masked in the following blocks of application flows that include them: Candidate Personal Information, Referrer Personal Information, Personal Information-Agency, Education, Work Experience, Basic Profile Information.

Configuration

Masking of personal information is not the default behavior at migration or in new zones. The following setting must be selected for each field (Date of Birth, Social Security Number, candidate user-defined field) whose content you want to mask.

Setting	Location
Personally Identifiable Information (in Career Section)	Configuration > [Recruiting] Administration > [Fields] Candidate

Linking Standard Career Sections to Mobile Career Sections

Customers can specify if a career section can be accessed from mobile devices.

When candidates receive a message on their mobile device regarding a new job opening and decide to take a look at the job using their mobile device, the candidates are automatically redirected to the mobile career section where they can view and apply for the job.

How does this occur exactly? First, the job is posted manually on a regular career section and the system automatically posts the requisition on the mobile career section to which the standard career section is linked. When candidates using a mobile device receive a message regarding the job and choose to learn more about the job, they are directed to a

standard career section (this is transparent to candidates). A mobile detection tool ("sniffer") detects the mobile device and redirects the candidates to the mobile career section.

Note: The detection tool provides only the language, default page, location and keyword fields to the mobile career section. Other criteria that might be part of the regular career section are not provided.

Career section administrators configure two properties on the Career Section Editor page to create a link between a standard career section and a mobile career section. Administrators specify whether a career section is a standard or mobile one by configuring the Mobile Career Section field. If they specify that a career section is a standard one, they can then link it to a mobile career section by configuring the Linked Mobile Career Section field.

When Recruiting Center users are posting a requisition, the mobile career section is not displayed in the Career Sections list. This is to prevent users from posting requisitions directly to a mobile career section.

When Recruiting Center users are posting a requisition, the system calculates the posting start date and end date for the mobile career section. The posting start date and end date on the mobile career section are based on the corresponding dates of the linked standard career section(s).

- If a single standard career section is linked to the mobile career section, the posting start date and end date of the standard career section are used.
- If multiple standard career sections are linked to the mobile career section: the earliest start date among the standard career sections is used and the latest end date among the standard career sections is used.

When a requisition is posted to a standard career section, the system automatically posts the requisition to the mobile career section to which the standard career section is linked.

A standard career section can be linked to only one mobile career section. Multiple standard career sections can be linked to the same mobile career section however. In the latter case, the open jobs of all the linked standard career sections will be posted on the mobile career section.

Existing themes and branding files can be used for mobile career sections. However, distinct themes and branding better suited to the needs of mobile device users are recommended.

Note: When a standard career section is linked for the first time to a mobile career section, all requisitions currently posted on the standard career section are posted to the mobile career section. This posting process starts a few minutes after the two career sections are linked and the time required to post those requisition depends on the volume of postings on the standard career section.

Note: The standard career section and the mobile career section must have similar configurations. Otherwise, job postings on the mobile career section might not be possible. For example, if the OLF structure of a standard career section does not match the OLF structure of the mobile career section, the requisition cannot not be posted on the mobile career section.

If a single standard career section is linked to the mobile career section, a "Display standard career section" link is displayed on most pages of the mobile career section. Mobile device users can click the link to proceed to the standard career section that typically contains more complete information and features than the mobile career section. The link is displayed on the My Submissions, My Job Cart, My Saved Searches, My Referrals and Basic Search pages. It is not displayed on the pages of application flows.

The standard career section does not include a link back to the mobile career section.

Note: If two or more standard career sections are associated with the same mobile career section, the link is not displayed in the mobile career section. This is because a link cannot point to multiple destinations. Customers can create a distinct mobile career section for each standard career section, however, and the "Display standard career section" link will be displayed in each mobile career section.

Invitation for Mobile Candidates to Complete Submission on Standard Career Section

Applications flows can be configured such that candidates and employees who make a job submission on a career section optimized for mobile devices receive an acknowledgement message by email inviting them to complete the full job submission on a standard career section.

The acknowledgement message is sent whether the candidates or employees saved an incomplete job submission or completed the submission process on the mobile career section.

Customers will need to create a customized message template for the Sending a Job Submission Acknowledgement Letter for Mobile Candidate action. It is important that the email template contain the URL leading to the standard career section so that candidates and employees can access the career section directly. The application workflow associated with the job in the standard career section is typically longer, contains more fields and presents information within a wider layout.

Configuration

A page in the application flow must include the Sending a Job Submission Acknowledgement Letter for Mobile Candidate action.

Application Flow Action	Location
Sending a Job Submission Acknowledgement Letter for Mobile Candidate	Configuration > [Career Section] Administration > Application Flows > (click application flow whose status is Draft)

Linking a Standard Career Section to a Mobile Career Section

Before you start

Configuration > [Career Section] Administration > Career Sections

Here's what to do

1. Click a career section.
2. Click **Edit** next to **Properties**.
3. In the **Mobile Career Section** field, select **No**.
4. In the **Linked Mobile Career Section** field, select the desired mobile career section.
5. Click **Save**.

Plain Text Resume Parsing for Mobile Devices

While completing a job-specific application or general profile using a mobile device, candidates and employees can copy and paste their resume.

The option Paste the resume is available on career sections.

The screenshot shows a web form titled "Resume profile". Under the "Profile Upload" section, there are three options for uploading a resume:

- LinkedIn (with a LinkedIn logo icon)
- Or upload a resume
 - Select the resume file to upload (with a "Browse..." button)
 - Paste the resume. (This option and its associated text area are highlighted with a red box in the image.)
- No thanks, I will fill out the online submission manually

Below the "Paste the resume" option is a large text area labeled "Plain Text Resume". Below the text area are two notes:

- Note: Once the process is completed, please verify the fields containing values automatically.
- Note: A text file with your resume content will be attached to your submission

At the bottom of the form are three buttons: "Save and Continue", "Save as Draft", and "Quit".

The system parses the pasted text and the information is used to pre-populate the job application or candidate file. The pasted text is also flagged as both a job-specific submission attachment and as a resume. Consequently, it is stored as a text file attached to the job submission and general profile. Recruiting Center users can view the attachment in the same way they can view other attachments.

Naming of the text file conforms to the following conventions:

- In the case where the pasted text originated from a job submission: `FirstName_LastName_RequisitionNumber_LanguageSymbol.txt`. E.g. `Clint_Campbell_1400123_EN.txt`.
- In the case where the pasted text originated from a general profile: `FirstName_LastName_LanguageSymbol.txt`. E.g. `Alejandra_Dos_Santos_ES.txt`.

- The language is the language of the career section when the candidate submitted the pasted text.
- Spaces in names are converted to underscores.

If the Plain Text Resume box displays content, this content is the starting point for text parsing.

Configuration

The application flow must include the Resume Upload block and the Resume pasting enabled setting must be set to Yes.

Setting	Location
Resume pasting enabled	Configuration > [Career Section] Administration > Application Flows > click application flow > Selected Blocks - Resume Upload

"Pre-filtered" URLs for Standard Career Sections Redirect Candidates to Mobile Career Sections

When candidates using a mobile device click links to "pre-filtered" searches on a standard career section for which Faceted search is enabled, the candidates are redirected to the associated mobile career section and a Faceted search using the same search parameters is performed.

Customers have long been able to create URLs to specific career section pages (*Configuration > [Career Section] Administration > Career Section URLs*) including URLs to the Basic and Advanced search pages and add the URLs to career sections (*Configuration > [Career Section] Administration > Career Sections > (click career section) > [Career Section URL] Show*), email correspondence, image maps, etc. It is not possible to create a URL to a Faceted search page using the same method.

This section explains how to create URL links to specific Faceted searches. It also explains a related feature for mobile device users. When candidates using a mobile device click such links to Faceted searches on a standard career section, they will be redirected to the mobile career section (providing one is associated with the standard career section). A Faceted search using the same search parameters specified in the URL will run automatically in the mobile career section and a list of jobs that satisfies the Faceted search criteria will be displayed in the job list.

Configuration

Career Section administrators first create a fictitious candidate (one with a user name and password), then perform the Faceted search they plan to create a URL for, and save the search.

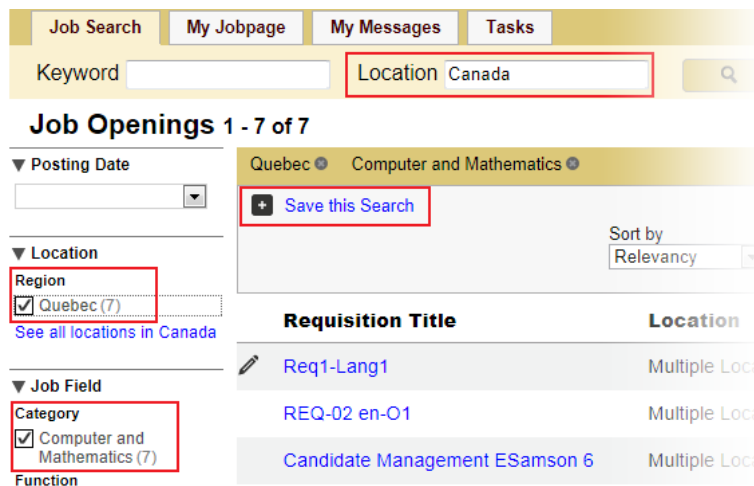

They can later retrieve and run the saved Faceted search and copy the URL that is generated. The following example of such a URL is loosely based on the previous screenshot:

```
https://your15Azone.taleo.net/careersection/10020/jobsearch.ftl?f=LOCATION(50437)|
JOB_FIELD(150000)&LOCATION=1038&a=null&multiline=false&ignoreSavedQuery&sasNo=20116751886
```

where LOCATION(50437) represents the Quebec (City) area, JOB_FIELD(150000) represents the Computer and Mathematics Job Field category and LOCATION=1038 represents Canada in the Location field in the top bar.

Administrators keep the URL up to *and including* "&ignoreSavedQuery" while deleting whatever follows. In our example, administrators would delete &sasNo=20116751886 and the edited URL to be copied would read:

```
https://your15Azone.taleo.net/careersection/10020/jobsearch.ftl?f=LOCATION(50437)|
JOB_FIELD(150000)&LOCATION=1038&a=null&multiline=false&ignoreSavedQuery
```

Note: It is important to include &ignoreSavedQuery in the URL.

It is this "shortened" URL that administrators would use when creating a URL. The "shortened" URL could be included in an email sent to candidates or added as a hotspot to an image map on the organization's Web site. When candidates clicked the link or hotspot, they would be redirected to the specific career section, the Faceted search would run automatically and a list of jobs that satisfied the Faceted search criteria (e.g.: Location: "Canada", Job Field: "Computer and Mathematics", and "Quebec (City)" area) would be displayed in the job list.

Note: As mentioned earlier, the method described in this section applies to Faceted searches only. A URL created for a Basic or Advanced search (*Configuration > [Career Section] Administration > Career Section URLs*) does not contain the parameters necessary to run a Faceted search.

When candidates using a mobile device click such links to Faceted searches on a standard career section, they will be redirected to the mobile career section (providing one is associated with the standard career section). A Faceted search using the same search parameters specified in the URL will run automatically in the mobile career section and a list of jobs that satisfies the Faceted search criteria will be displayed in the job list.

Note: The mobile career section must be configured such that the Faceted search page is enabled.

Displaying All Candidate Submissions in the My Referrals Tab

Referrers can see all submissions of a candidate who they referred and who is still active.

Employee referrals works as follows:

- When a candidate is referred to a job, the referrer can see that candidate's job-specific referral in the career section My Referrals tab as long as the referral is still effective.
- If a referred candidate is matched to a job, the referrer can only see the referral in the My Referrals tab if the "Matched Candidate Display" option for the referrer is set to "Always" or is based on a step and the candidate had passed that step in the candidate selection workflow.
- If a referred candidate applied on a job by himself/herself, the referrer can see that referral in the My Referrals tab if the "Display to the referrer submissions for which candidates applied by themselves" option is set to Yes.

The option "Display to the referrer submissions for which candidates applied by themselves" only controls the visibility of the jobs for which a candidate applied; it has no impact on the jobs for which the candidate was matched or referred. Also, this option does not overwrite the Matched Candidate Display setting (*Configuration > [Career Section] Administration > Matched Candidate Display*).

"Matched Candidate Display" setting	"Display to the referrer submissions for which candidates applied by themselves" option	The referrer will see:
Yes	Yes	Jobs for which he referred the candidate. Jobs to which the candidate was matched. Jobs for which the candidate applied by himself.
No	Yes	Jobs for which he referred the candidate. Jobs for which the candidate applied by himself.
Yes	No	Jobs for which he referred the candidate. Jobs to which the candidate was matched.
No	No	Jobs for which he referred the candidate.

Referrers will only see jobs for which the referral is active. Candidates will see jobs in line with how the settings were configured: the candidate's own submissions, the jobs for which a candidate was referred (even if the referral is inactive), the jobs to which a candidate was matched (according to the "Matched Candidate Display" option).

7 Career Portal Brand

Portal Brand

Branding

Branding allows the system administrator to customize the look and feel of a Career Section with headers, footers and site navigation.

Branding allows the system administrator to customize the frame surrounding the areas of the Career Section displaying the job listings. The objective is to create a Web page that mimics the customer's own Web site to create a seamless transfer as the end-user looks for a career/job on the customer's Web site.

Branding for a Career Section is set up with the Career Portal Brand feature of the Career Section Administration. The Branding file is uploaded into a Career Portal Brand which can be associated to one or several Career Sections.

A base locale must be specified among all branding files submitted. If a Career Section using a brand is accessed with a locale where no file was submitted, the branding file associated to the base locale is used.

An organization branding is submitted via a compressed (zip max of 1MB) file that contains the branding definition, that is a XHTML file and all the required static files (images, JavaScript, CSS, objects). These files create the cast of the Web page which will carry the embedded "job listing" section (that is, career portal pages and application flow). The file (conforming to Oracle Taleo's specifications) can include left and right navigation items as well as heading and footer content, which together enable your organization to create a Career Section that conveys a particular look and feel. The URL of each Career Section that uses the branding must be attached.

There is no dynamic content based on the type of job search performed within a Career Section. For example, with Oracle Taleo hosting the page, it is not possible to display marketing content on a Career Section when candidates search for marketing jobs. Branding can be set per Career Section. If the organization wants marketing jobs to drive marketing content, create different Career Sections for different target audiences. The Career Section Administration module supports the upload of JavaScript files in the form of branding file extensions. However, branding file extensions cannot be enabled without a review and approval by Oracle Taleo.

The compressed branding file is saved in your organization's database zone and is cached by the Oracle Taleo file system. When candidates access the Career Section, the cached files are accessed. Oracle Taleo Enterprise Edition is hosting the entire Web page (versus the page being embedded as a frame), therefore eliminating double scrolling for candidates. Since Oracle Taleo Enterprise Edition is hosting the page, the Oracle Taleo URL is used. If the organization has more than one brand, a separate compressed file can be created for each of them. The organization can then assign any one of those brands to a single Career Section or can assign a brand to multiple Career Sections.

Organizations should modify their Career Section page (1024 x 768 screen resolution) to account for the 720 pixel size recommended page width.

Branding File

The branding file is a compressed (max of 1MB) file that contains the branding definition of an organization.

The branding definition is defined by an XHTML file and all the required static files (images, CSS, objects).

The compressed (zip) file must contain:

- an index.html file on the root folder.
- a Theme folder that includes
 - a CSS folder containing .css files referred by the "index.html" file.
 - an Images folder containing images referred by the "index.html" file. The format of images must be supported by the principal Web browsers. There is no limitation for the type or size of images. However, it is recommended to use .jpg or .gif as they take less space.
 - an Objects folder containing objects (for example, applet classes, Flash animation files) referred by the "index.html" file.

When creating the compressed ("zip") file, the compressed file must **not** include a folder that contains the "index.html" file and the "theme" folder. To avoid this select the "theme" folder and "index.html" simultaneously and send them to a "zip" file. See [Creating a Branding File](#) for detailed steps.

The index.html file **must**:

- host the objects (images, CSS, Flash)
- be XHTML 1.0 Strict coding format for the Web site. This ensures that the HTML codes used to create the Web site follows those standards agreed upon by the World Wide Web Association.
- include at the beginning of the file
 - `<!DOCTYPE html PUBLIC "-//W3C//DTD XHTML 1.0 Strict//EN" "http://www.w3.org/TR/xhtml1/DTD/xhtml1-strict.dtd">`
- contain an `<insertcontent>` tag which is used to insert Taleo content in the page.
- not include the `<insertcontent>` tag inside a form tag.
- declare all the HTML tags with the "http://www.w3.org/1999/xhtml" namespace.
- declare the `<insertcontent>` tag with the "http://www.taleo.com/templates" namespace. For example, `<insertcontent xmlns="http://www.taleo.com/templates" />`
- Add the line `<insertcontent xmlns=http://www.taleo.com/templates />` to the HTML file for the job-listing section to appear. Without this, the career site will not have a section for the user to look for a job. If using a validator, this line always fails the validation. Please proceed, the upload automatically ignores this statement.
- Not host the Flash images; Flash files must be hosted separately.

Following simple rules when creating the CSS file will avoid several error messages upon upload:

- Do not use cap locks.
- Always use codes for special characters.
- Do not use global CSS tags. Using CSS definitions on standard HTML tags when creating a branding file can have an impact on the Theme configuration. If the definition of a CSS tag is not the same in the theme and the branding, display problems will occur and Taleo will not have the ability to provide any support. For example, if in a Career Section using branding hyperlinks are black, but in the Career Section's theme the hyperlinks are

defined as being blue, this situation will cause a conflict. To avoid discrepancies, do not use global CSS style; Taleo recommends adding the name of your organization to the name of the style classes used for branding to avoid any conflict with the style classes set in the Themes.

- Do not add Flash images in the branding file; Flash files must be hosted separately.

Career Section administrators can update the HTML, cascading style sheets (CSS) and image content of their branding without enlisting the help of Oracle Consulting Services through a statement of work (SOW). They can also create multiple branding files. This is done in the Career Portal Brand page.

Note: Branding files cannot have a .js folder or JavaScript embedded in the index.html file. To display some dynamic content, organizations can use JavaScript provided it is in the form of a branding file extension (not included in the branding file). The JavaScript must be analyzed and approved by Oracle Taleo before it will be enabled. For more information, see *Branding with JavaScript*.

Branding with JavaScript

It is possible to display some dynamic content, and forms such as search widgets on your Career Section using JavaScript provided the latter is included in branding file extensions.

Whenever administrators configure a career section, they can assign a branding file containing HTML, CSS and images and they have the option of specifying a branding file extension, a file containing all the JavaScript they want to enable for the branding. The two files are merged automatically at runtime.

Branding file extensions cannot contain any HTML, CSS or image content—only JavaScript.

Configuration

On the New Career Portal Brand configuration page, Career Section administrators will see only the "Branding File" option in the Type list. The Type list includes a new attribute called "Branding File Extension" that is only displayed to Oracle Taleo employees who have the permissions required to upload JavaScript files. There is also a field for specifying the file to be uploaded.

Oracle Taleo Enterprise Edition customers can create "branding file extension" files themselves, have a third party do this or submit a SOW to have Oracle Consulting Services create the files.

Submitting a Branding File Extension for Addition into Your Account

Customers no longer need to contract with Oracle Consulting Services (OCS) to upload JavaScript into their career portals. With the new process Oracle has put in place, customers are able to request the upload JavaScript into their career portals using a Service Request. The process must be followed for every Java Script branding file upload request, including updates to the Java Script branding file.

Oracle Support is only uploading the Java Script branding file into the customer Oracle Taleo Enterprise Edition instance. They are not responsible for troubleshooting or triaging issues with the branding file. It is the customer's sole responsibility to troubleshoot and triage the branding file.

1. Customers raise a Service Request with Oracle Support requesting to upload a JavaScript branding file to the customer Oracle Taleo Enterprise Edition instance. The customer should provide the target zone and target Career Portal Brand [**Configuration > Career Section Administration > Career Portal Brands**] element that they wish to have the JavaScript Branding File Extension added to.
2. Oracle Support will review the request, and then present the customer with a waiver that a customer must review and agree to in the Service Request.
3. Once the customer has read through and agreed to the waiver, they can then provide Oracle Support with the JavaScript branding file they wish to be uploaded into their Oracle Taleo Enterprise Edition instance.
4. Oracle Support will upload the Java Script branding file into the customer's target Oracle Taleo Enterprise Edition instance per the customer's request.

What to do next

If for any reason Oracle determines there is an issue with the JavaScript branding file or does not get clear agreement from the customer, they may decline to upload it into the target Oracle Taleo Enterprise Edition instance. Additionally, if after uploading the Java Script branding file into the customer zone, Oracle has the authority to disable and / or delete the Java Script branding file for any reason (these reasons include but are not limited to impacts to the performance, security, etc.).

Width

Career sections (whether or not they use the Taleo branding feature) are designed to fit in a 720 pixel size.

Taleo strongly recommends using a 720 pixel size, along with a 1024 x 768 screen resolution to provide a more pleasing appearance, more white space, and consequently, superior readability.

The Career Section automatically adjusts to either:

- The width size specified in the branding file.
- The width size of the window where it is placed.
- The width size of the frame where it is placed.

For example, if your organization uses a 600 pixel wide frame, the career section fits that space automatically. However, if the pixel size drops below the recommended 720 pixel size, the Career Section becomes compressed and some features either need to be turned off to accommodate the lack of space or appear squeezed on the screen.

Your organization should take into account the recommended page width when creating the branding, the XHTML code and the images that are included in the branding file.

Setting Up Branding

1. Create the XHTML file
2. Validate the XHTML file.
3. Create the static files (images, JavaScript, CSS, objects).
4. Create a zip branding file.
5. Your branding file must not contain JavaScript. If you want to include JavaScript in your branding, see *Branding File Extension for JavaScript*.

6. Upload the branding file.
7. Associate a career portal brand (hence a branding file) with a career section.

Validating a XHTML File

Before you start

Always validate the branding file before uploading the file.

Ignore the error concerning the `insertcontent` tag because is not a valid XHTML tag (it is a Taleo tag)

Here's what to do

1. Go to <http://validator.w3.org>
2. Follow the on-screen instructions.

Results:

If the index.html file does not have any errors, it can be uploaded for use in career sections.

If the file contains errors, correct the file and validate again.

Uploading a Branding File

Before you start

The *Access the Career Section administration section* user type permission grants users access to this feature.

A branding file that must not include a .js folder or JavaScript.

Configuration > [Career Section] Administration > Career Portal Brands

Here's what to do

1. Click Create.
2. Enter a code and name for the branding file in the corresponding fields.
3. Next to the File field, click Browse and select the compressed file archive containing the HTML, cascading style sheets (CSS) and image content for the branding.
The branding file archive cannot have a .js folder or JavaScript embedded in the index.html file.
4. Ensure that "Branding File" is displayed in the Type field and click Save.
The branding file is uploaded provided no error was detected.
5. Click Activate to enable the branding.

Results:

The branding file is displayed on the Career Portal Brands list and can be added to career sections.

What to do next

Administrators can assign the branding file (and any enabled branding file extension if desired) to career sections. See "Assigning a Branding File and Branding File Extension to Career Section".

Deactivating a Career Portal Brand

Before you start

The *Access the Career Section administration section* user type permission grants users access to this feature.

The career portal brand must not be associated with a career section.

Configuration > [Career Section] Administration > Career Portal Brands

Here's what to do

1. Click the name of a career portal brand.
2. Click Deactivate next to the name of the career portal brand.

Results:

The career portal brand (hence the branding file) is no longer available in the Name menu of the Corporate Brand section of the Career Section properties. The system administrator is no longer able to associate the branding file with a career section via the career portal brand.

Editing Branding Files

Before you start

The *Access the Career Section administration section* user type permission grants users access to this feature.

Branding Files should be modified by qualified personnel.

Configuration > [Career Section] Administration > Career Portal Brands

Here's what to do

1. Click a career portal brand name.
2. Click Download.
3. Choose to open or save the file on computer.

Results:

The files contained in the branding definition are available to the administrator to be edited.

What to do next

Create a new branding file archive and upload it.

Associating a Career Section to a Branding File

Before you start

The *Access the Career Section administration section* user type permission grants users access to this feature.

A validated branding file archive must be uploaded.

The career section must have Inactive status.

Configuration > [Career Section] Administration > Career Sections

Here's what to do

1. Click the name of the career section.
2. Click Edit next to Properties.
3. In the Corporate Brand section, select a branding file from the Branding File list.
 - a. Optionally, select a branding file extension from the Branding File Extension list.
4. Click Save.

Results:

The selected branding definition is displayed in the career section of the organization's Web site.

Viewing which Career Sections are Associated to a Branding File

Before you start

The *Access the Career Section administration section* user type permission grants users access to this feature.

A Brand file must be available.

Configuration > [Career Section] Administration > Career Portal Brands

Here's what to do

1. Click the name of a Career Portal Brand.
2. Click View Associated CS.

Results:

The list of all the career sections using the Branding file associated with the career portal brand is displayed.

Creating a Branding File

Before you start

Have all files validated before creating the branding file.

Here's what to do

1. Create a folder with the name of the brand.
2. Within the brand folder create "*index.html*" and a folder named theme.
3. Within theme create two folders: images, and css. Folders "js" for JavaScript and "object" for object files are optional.
4. Put all *style files* in the correct folders.
5. Return to your brand folder and select the theme folder and the index file.
6. Right-click and select **Send To > Compressed(zipped) Folder** from the shortcut menu.
7. Rename the file archive.

What to do next

Upload the "zip" branding file archive.

Index File

To get started with branding use this example as a template for an index.html file as a guide to complete the look and feel of a Career Section.

```
<?xml version='1.0' encoding='utf-8'?>
<!DOCTYPE html PUBLIC "-//W3C//DTD XHTML 1.0 Strict//EN"
"http://www.w3.org/TR/xhtml1/DTD/xhtml1-strict.dtd">
<html xml:lang='en' lang='en' xmlns='http://www.w3.org/1999/xhtml'>
<head>
<title>Your Company Title Here</title>
<meta http-equiv="content-type" content="text/html; charset=iso-8859-1" />
<meta name="description" content="" />
<meta name="keywords" content="" />
<meta name="robots" content="all" />
<link href="theme/css/styles.css" rel="stylesheet" type="text/css" />
</head>
<div id="mainfixcenter" style="text-align:center;">
<div id="main">
<div id="content">
<!-- head page -->
<div id="head">
<div id="headmenu">
</div>
<div id="Logo"><a href="http://www.taleo.com/"><img src="" width="329" height="32" alt="Your Company Logo
Here" style="border:0" /></a></div>
<div id="menu">
<ul>
<li id="company"><a href="#">Company</a></li>
<li id="solutions"><a href="#">Solutions</a></li>
<li id="services"><a href="#">Services</a></li>
<li id="customers"><a href="#">Customers</a></li>
<li id="alliances"><a href="#">Alliances</a></li>
<li id="research"><a href="#">Research</a></li>
<li id="news"><a href="#">News &#38; Events</a></li>
<li id="careers"><a href="#">Careers</a></li>
</ul>
</div><!--/UdmComment-->
</div>
<!-- End head page -->
<!-- center page -->
<div id="centerpage">
<div id="arianne">
</div>
<!-- left menu -->
<!--UdmComment--><div id="menuleft">
<ul>
<li id="link1"><a href="#">Job Opportunities</a></li>
</ul>
<div class="submenu">
<ul id="slink1">
<li id="slink11"><a href="#">Job Search</a></li>
<li id="slink12"><a href="#">How to Apply</a></li>
<li id="slink13"><a href="#">Your Profile</a></li>
</ul>
</div>
<ul>
<li id="link2"><a href="#">Locations</a></li>
<li id="link3"><a href="#">Benefits</a></li>
```

```
<li id="link4"><a href="#">About Taleo</a></li>
</ul>
</div><!--/UdmComment-->

<!-- Content -->
<div id="textcontent2" style="margin-right:0;">
<h1 class="lp" style="width:100%;">Job Opportunities</h1>
<insertcontent xmlns="http://www.taleo.com/templates"/>
</div>
<div id="endcontent2"></div>
</div>
<!-- end center page -->
<!-- Footer -->
<!--UdmComment--><div id="footer" style="visibility:visible; ">
<div id="footercontent">
<ul>
<li><a href="#">Home</a></li>
<li></li>
<li><a href="#">Contact Us</a></li>
<li></li>
<li><a href="#">Privacy Policy</a></li>
<li></li>
<li><a href="#">SiteMap</a></li>
</ul>
</div>
<p>Copyright © 2007 Taleo Corporation. All Rights Reserved.</p>
</div><!--/UdmComment-->
<!-- end footer -->
</div>
</div>
</div>
</body>
</html>
```

Cascading Style Sheet

To get started with branding use this CSS as a guide style.css to complete the look and feel of a Career Section.

```
body{background-color:#FFF; margin:0;font-family: Verdana,Helvetica,Arial,Tahoma,sans-serif; color:#000;
font-size:11px;}
#textcontent a,#textcontent2 a{color:#000;}
a{color:#0B5500;}
#main{width:800px; margin:0 auto; background-color:#FFF; text-align:left;}
#content{ margin:0 10px;}
#rightlist{ position:absolute; left:370px;top:449px; width:210px;}
/** Head menu **/
#head{position:relative;}
#headmenu{height:20px;}
#headmenu ul{ list-style:none; margin:0;padding:0;height:20px;}
#Logo{clear:both;}
#headmenu ul li{border-right: 1px solid #80C31A; float:right; margin-left:60px; padding-right:5px; padding-
top:5px;}
#headmenu ul li a{display:block; font-size:10px; font-family: Helvetica,Verdana,Arial,Tahoma,sans-serif;
color:#000; text-decoration:none; font-weight:bold;}
#menucustomer{visibility:hidden; position:absolute; left:510px;top:20px; width:150px; height:auto;}
/** end head menu **/
/** menu **/
#menu{height:35px;}
#menu ul{ padding:5px 0 0 0; list-style:none; margin:0;}
#menu ul li{float:left; margin-right:20px;}
#menu ul li a{text-decoration:none; color:#666; font-size:11px; font-family:
Helvetica,Verdana,Arial,Tahoma,sans-serif; font-weight:bold;}
```

```

/**** end menu ****/
/**** footer ****/
#footer{margin-top:10px; padding:0 0 5px 0; visibility:hidden; width:780px; height:50px;}
#footercontent{ background-color:#666; height:30px; position:relative; margin-bottom:3px;}
#footercontent ul{list-style:none; margin:0 0 0 10px;padding:0;}
#footercontent ul li{color:#FFF; margin-right:10px; font-size:9px; line-height:30px; float:left;}
#footercontent ul li a{color:#FFF; font-size:9px; text-decoration:none;}
#footer p{text-align:right; font-size:9px; color:#666; margin:0;}
#arianne{ border-top:1px solid #B2B2B2; height:10px; display:block;}
#centerpage{}
/**** left menu ****/
#menuleft{float:left; overflow: hidden; width:117px;}
#menuleft ul li a{display:block;width:117px;}
#menuleft ul li.done ul li a{width:108px;}
#menuleft ul li._current ul li a{width:108px;}
/**** content ****/
#textcontent{margin:0 0 0 135px; width:425px;}
#textcontent2{margin:0 0 0 5px; float:left; overflow: hidden; position: relative; width: 655px;}
#endcontent2{clear:both;}
#textcontentNoMenu{margin:0 220px 0 0px;}
#textcontent2NoMenu{margin:0 100px 0 0px;}
/**** Left menu ****/
#menuleft ul, #menuleft ul li ul{list-style:none; margin:0; padding:0;}
#menuleft div.submenu ul
#menuleft ul li{font-size:10px; line-height:12px; width:117px; margin-bottom:3px;}
#menuleft div.submenu ul li{margin:0 0 2px 0; font-size:10px; line-height:12px;}
#menuleft ul li a{display:block; padding:4px 5px; color:#FFF; text-decoration:none; background-color:#000;}
#menuleft ul li.done a{ background-color:#000;}
#menuleft ul li._current a{ background-color:#000;}
#menuleft div.submenu ul li a{background: 4px 6px no-repeat; padding-left:12px; display:block; color:#666;
padding-top:2px;}
#menuleft div.submenu ul li.done a{padding-left:12px; display:block;}
#menuleft div.submenu ul li._current a{padding-left:12px; display:block;}
/**** text elements ****/
#textcontent h1,#textcontent2 h1{margin:0; font-size:14px;}
#textcontent h1.lp, #textcontent2 h1.lp{ background-repeat: no-repeat; color: white; font-size:13px; font-
weight: bold; width:658px; margin: 0 0 5px; padding-top: 2px; padding-bottom: 2px; padding-left:49px;}
#textcontent h2,#textcontent2 h2{margin:10px 0 0 0; font-size:12px;}
#textcontent h3,#textcontent2 h3{margin:10px 0 0 0; font-size:12px;}
/**** hover menu ****/
#company a:hover{color:#80C31C;}
#solutions a:hover{color:#0099CC;}
#services a:hover{color:#003366;}
#customers a:hover{color:#FF9900;}
#alliances a:hover{color:#005967;}
#research a:hover{color:#660000;}
#news a:hover{color:#D74B00;}
#careers a:hover{color:#006600;}
#menu ul li.done a{color:#006600;}
#menuleft ul li a{background-color:#009900;}
#menuleft ul li.done a{ background-color:#009900;}
#menuleft ul li.done ul li a{ background-color:#FFF;}
#menuleft ul li ul li a{background-color:transparent; border:1px solid #FFF;}
#menuleft ul li ul li.done a,#menuleft ul li.done ul li a:hover{border:1px solid #009900; padding-left:12px;
display:block; color:#009900;}
#menuleft ul li ul li.done ul li a,#menuleft ul li ul li.done ul li a:hover{color:#009900; border:none;
padding-left:20px;}
/**** text elements ****/
#textcontent h1{color:#009900;}
#textcontent h2.head,#textcontent2 h2.head{background-color:#bfd9bf; color:#009900; border-bottom:2px solid
#99c299;}
#textcontent p.head{background-color:#E8F1E8;}
#textcontent h1.lp, #textcontent2 h1.lp{width: 700px; height: 17px; background-color: #009900;}

```

Special Character Codes

Special Character	Description	Code	Special Character	Description	Code
<	Less than sign	<	>	Greater than sign	>
[Left Bracket	[]	Right bracket]
{	Left curly brace	{	}	Right curly brace	}
'	Left single quote	‘	'	Right single quote	’
“	Left double quote	“	”	Right Double quote	”
“	Left double quote	“	”	Right double quote	”
«	Double left than sign	«	»	Double greater than	»
-	Short Dash	–	-	Longer dash	—
—	Dash	—	*	Asterisk	*
†	Dagger	†	‡	Double Dagger	‡
...	Ellipsis	…	•	Bullet	•
~	Tilde	~		Vertical Bar	|
¿	Inverted question mark	¿	¡	Inverted exclamation point	¡
¢	Cent sign	¢	£	Pound sign	£
¥	Yen sign	¥	€	Euro sign	€
™	Trade Mark	™	®	Registered trade mark	®
©	Copyright sign	©	‡	Broken vertical bar	¦
¬	Logical not sign	¬	°	Degree sign	°
÷	Division sign	÷	±	Plus or minus sign	±
+	Plus sign	+	=	Equals sign	=
¹	Super script 1	¹	²	Superscript 2	²
³	Super script 3	³	¼	Fraction ¼	¼
½	Fraction ½	½	¾	Fraction ¾	¾
@	At sign	@	'	Apostrophe	'

Troubleshooting Branding

Display Problems	Solution
Progression bar expanded beyond page limit.	Ensure at least 720 pixels (width-wise) is allocated for the job listing section. Although this is not required, it is highly recommended. 720 pixels allows ample room to accommodate for the career section. Without this space, many branding files seem stretched or certain fields are deprecated.
Job descriptions are too close to the left edge of the page.	In the HTML file, scroll through and look for the lines : “<insertcontent xmlns=http://www.taleo.com/templates />” Applying the following lines “<div style=“padding-left:10px”>” before and “</div>” after, to add a space to left side edge of the job listing section.
The “Welcome. You are not signed in” message is very close to the Job Search tab.	The metapanel section (which is the text “Welcome ... not signed in) is deprecated and it does not know what height size it is supposed to be. Add the line “.accessmanagement .headersection .metapanel {height:14px;}” anywhere in the CSS.
Some of the characters such as > or do not appear although in the HTML file.	Sometimes when the branding file is uploaded, characters which do not have a paragraph or link tag around are not acknowledged. Verify that all characters in the HTML file have a <a> or <p> around the characters.
Job Listings displayed under the left hand side navigation bar instead of being displayed of the navigation bar.	Manually reducing the width of the job listing section so that it fits in the white space. This is done by applying a “width:750px” in a div tag surrounding the <insertcontent> line.
When applying to a requisition, some input fields seem very wide pushing the whole screen wider than wanted.	A script determines the optimal size for these fields. In IE6, the script determines that the optimal size is 250px wide. In sections where there is first, last, middle name field. The field therefore takes up 750px of space. 2 solutions are possible: <ul style="list-style-type: none"> • Change the size of the field in the user-defined form. After choosing the field, scroll to the bottom of the user-defined page and observe the line “CSS Style”. By adding “Width: 150px” to the field, the size of the field is shortened. Remember, the default is 250px if blank. • Insert at the end of the CSS file the following four lines: <ul style="list-style-type: none"> ○ .blockpanel .entity-value, .blockpanel .entity-value select {width:150px;} ○ .blockpanel .input-checkbox {width:20px;} ○ .blockpanel .input-date-time select {width:60px;} ○ .blockpanel .input-radio {width:auto;}
White empty box is displayed instead of filter boxes. To display the filters user needs to resize the screen.	Enter the following script right before the </body> located at the very end of the HTML file). <ul style="list-style-type: none"> • <script type=“text/javascript”> //<![CDATA[setTimeout("_ftl_api.updateFloats()",1000); //]]></script> Do not apply this JavaScript until the branding file is finalized.</td> </tr> <tr> <td>Only the 1st CSS file is read while ignoring the other CSS files although several are available.</td> <td>Merge the CSS files together i.e. copy/paste the contents of the other CSS files to the end of the primary (1st) CSS file. Doing this does not cause any issues. You may want to add some comments to ensure that future developers can clearly understand where one CSS file ends and where the other starts.</td> </tr> <tr> <td>The top border is not correctly placed at the job listing section. The top border should be touching the side border creating a proper border around the sections. There are also small dots as well.</td> <td>You must find the padding style causing the problem. In this case, the padding is affecting a <p> declaration. Go into the CSS file and do a search for the word “padding”. Continue hitting the search until you find something similar to: <pre>p{ padding: 8px 0px 10px 0px;</pre> </td> </tr> </tbody> </table> </div> <div data-bbox="69 921 193 940" data-label="Page-Footer"> <p>ORACLE</p> </div> <div data-bbox="912 910 952 928" data-label="Page-Footer"> <p>162</p> </div>]]>

Display Problems	Solution
	<pre>} Notice how this padding declaration affects all "p". So any time there is a paragraph, this CSS creates a space around it. The 4 numbers represent top, right, bottom, and left. In that order. The easiest thing to do at this point is change the 8px (which affects the top border) and the 10px (affecting the bottom border) and replace them with 0px.</pre>
Long job title overlapping the "Step 1 of x Print/Email" line.	<p>Add the following lines, anywhere in the CSS.</p> <pre>.mainsection .metapanel{ padding-top:15px; margin-bottom:2px; }</pre>
Vertical lines in bread crumb all grouped together instead of being placed between words.	In the branding file, add <code><spam></code> after each word that should be separated from another word by a vertical line.
Job listings section is not displayed.	The line <code><insertcontent xmlns=http://www.taleo.com/templates /></code> must be added to the HTML file for the job-listing section to appear. Without this, the career site will not have a section for the user to look for a job. If using a validator, this line always fails the validation. Please proceed, the upload automatically ignores this statement.
Pages are displayed on the left hand side, instead of being centered.	If you are using IE6, change the margin to auto;
Flash animations not displaying in the career section	Flash images must not be included in the branding file, but hosted by the customer.
On rare occasions, images in a branding file are not displayed in the career section.	<p>Though this issue has not been resolved yet, there is an effective workaround. Add <code>basethemepath/[languageCode]/</code> to the beginning of the <code>src=</code> or <code>href=</code> parameter of the image or link HTML tag, replacing <code>[languageCode]</code> with the language code of the branding file.</p> <p>Two examples: in English</p> <pre><link type="text/css" rel="stylesheet" media="all" href="theme/css/system.css"/></pre> <p>should be changed to</p> <pre><link type="text/css" rel="stylesheet" media="all" href="basethemepath/en/theme/css/system.css"/></pre> <p>in Dutch</p> <pre></pre> <p>should be changed to</p> <pre></pre>

Font Problems	Solution
Font size in the job listing section too large, especially in internet explorer.	Often Internet Explorer ignores the font-size assigned and defaults to the largest size. The workaround is to re-apply the font-size for the area; usually the job-listing section.

Font Problems	Solution
	In the HTML file, look for the lines : "<insertcontent xmlns=http://www.taleo.com/templates />" Applying the following lines "<div style="font-size:10px">" before and "</div>" after, to force the browser to increase or decrease the font-size.
Font-size in the information balloon of a job listing screen is very large.	In the CSS file, add the style "font-size:62.5%;" to the body's style. This is usually added by Talents own CSS, but often ignored by Internet Explorer due to a conflicting instruction.
Some of the characters such as > or do not appear although in the HTML file.	Sometimes when the branding file is uploaded, characters which do not have a paragraph or link tag around are not acknowledged. Verify that all characters in the HTML file have a <a> or <p> around the characters.

Color Problem	Solution
When using a colored back ground, a white bar is displayed on the right hand side of the career section.	In the XHTML file, change the width to 100%.
In the privacy agreement page, the Print Format link at the top right has a different background color than the rest of the page.	Add to the CSS style sheet .mainsection .blockpanel .metagrouppanel .metapanel .metalink2 .nav-btn{ background-color:transparent; }

Error Message when Uploading the Branding File	Solution
The template file "index.html" contains the following XHTML errors: javax.xml.transform.TransformerException: java.io.UTFDataFormatException: Invalid byte 1 of 1- byte UTF-8 sequence.	This is caused by the use of special characters in the HTML file. Use the codes supplied in the Special Character Codes table.
You must select a .zip file containing a theme file	Make sure there are a CSS and Images folders in the Theme folder.
Bad doc Type. <ul style="list-style-type: none"> <!DOCTYPE html PUBLIC "-//W3C//DTD XHTML 1.0 Strict//EN" "http://www.w3.org/TR/xhtml1/DTD/xhtml1-strict.dtd"> 	Add <!DOCTYPE html PUBLIC "-//W3C//DTD XHTML 1.0Strict//EN" "http://www.w3.org/TR/xhtml1/DTD/xhtml1-strict.dtd"> at the beginning index.html file
Warning error is displayed on attributes	Check if caps locks are used in the XHTML file.
unescaped & or unknown entity "&justice.gif"	In the XHTML file, Replace & sign by &}

8 Theme

Theme

Theme

The theme gives an organization complete control regarding the general font type and size, and the color scheme of a Career Section.

Themes are the style sheets specifying the overall look and feel of a Taleo Career Section. The theme feature allows the system administrator to configure:

- Background and color
- Text
- Link
- Input and Button Control
- Custom Resource

Each Career Section is associated to a theme providing the Career Section a particular look and feel. The same theme can be applied to multiple career sections or a theme can be created for a single Career Section. By adjusting the colors and the fonts of the theme to match the element definition set in the branding file, the Taleo pages fit seamlessly within the Career Section.

The Theme also allows for the control of:

- the width of the progression bar
- the width of the help panel

The colors of the tabs and sub-tabs should be adjusted to comply to the web standards. Parent-child tab configuration is identified through matching colors.

Each element can be customized, however the available style values for each element differ. Available style values are:

- Font Size
- Font Family
- Color
- Font Weight
- Text Decoration
- Font Style
- Background color

The system administrator can choose a default theme for the organization. Two themes are supplied with the system. When a theme is created, the system automatically duplicates the Taleo Default theme. The user can then customize the aspect and feel of the new theme. Theme changes are applied to all the elements of a theme. For example, the font and

color of a single button can not be changed; all buttons included in the theme that is, displayed in the application flow or in the career portal pages reflect the change.

The name of a style class being used for branding and for theme definition should be renamed to avoid any possible conflict. At implementation, style classes defined for a theme are first applied to a zone and then the ones used for Branding are applied. If the same type class name is used, but with different values, style classes in conflict do not render as expected. Taleo strongly recommends to have unique style class names. The same name of a style class for different elements of a theme can be reused, as this does not cause conflicts. An easy way to avoid style class conflicts is to add the company prefix to the name of the style classes being used for Branding.

Colors should be selected according to the organization best practices in terms of accessibility and branding. Colors should be provided or chosen in Hex value which can be found at <http://www.webreference.com/html/tools/colorizer/>

Style Classes

The system administrator uses style classes to customize the look and feel of the Career Section.

Style classes are assigned to areas or text of the Career Section which can be formatted via the Theme feature.

Configurable elements are:

- Background and color
- Text
- Link
- Input and Button Control
- Custom Resource

Text style classes are applied to an element according to a specific hierarchy.

Text Style Class Hierarchy		
First level	Second Level	Third Level
General Font	Text	Help Text
		Legend Text
		Search Text
		List text
		Page Text
		Warning Text
		Error Text
		Message Text
		Balloon Text

Text Style Class Hierarchy		
First level	Second Level	Third Level
	Subtitle	Help Subtitle
		Search Subtitle
		List Subtitle
		Page Subtitle
	Label	Search Label
		List Label
		Page Label
		Balloon Label

The General font is applied systematically to all text appearing in the Career Section formatted via the theme feature. The style values of this style class cannot be overridden by a child style class and cannot be configured else where in the application.

- If no style values are set for the third level, then the style values of the second level are applied to the elements.
- If style values are set for the third level, then the style values of the second level are overridden by the style values of the third level, for the specific element.

For example, if the Text style class is set to be red with a normal weight then

- If the Legend Text style class is set to be bold, then the text appearing in the legend is red and bold
- If no style values are set for Error Text style class, then the Text style class values are used in Error Text that is, the text used in Error Text is red with a normal weight.

Creating a Theme

Before you start

The *Access the Career Section administration section* user type permission grants users access to this feature.

Consider duplicating an existing theme.

Configuration > [Career Section] Administration > Themes

Here's what to do

1. Click Create.
2. Complete the fields.
3. Click Save.

What to do next

Configuring the theme.

Activating a Theme

Before you start

The *Access the Career Section administration section* user type permission grants users access to this feature.

Configuration > [Career Section] Administration > Themes

Here's what to do

1. Click the name of a theme.
2. Click Activate next to the theme name.

Results:

The theme can be associated to a Career Section.

Deactivating a Theme

Before you start

The *Access the Career Section administration section* user type permission grants users access to this feature.

Theme must not be a in use

Configuration > [Career Section] Administration > Themes

Here's what to do

1. Click the name of a theme.
2. Click Deactivate next to the theme name.

Results:

The theme can no longer be associated to a Career Section.

Modifying an Existing Theme

Before you start

The *Access the Career Section administration section* user type permission grants users access to this feature.

Theme must be inactive.

Modifying the theme does not allow user to change the text of a label.

Here's what to do

1. Preview the Career Section.
2. Locate the element type to modify (button, hyperlink, box etc...)
3. Locate the area of the career where the element to modify is located (Application flow page, balloon, error message.....)

4. Refer to the tables of style classes to identify the style class to be modified.
Style classes used to define an area of a Career Section are presented in the same table.
5. Access the theme section where the style class can be edited.
The path is indicated with the table of style classes.
6. Change the values of the style class.
7. Click Save.
8. Preview the Career Section to validate that proper changes where made.

Changing the Properties of a Theme Element

Before you start

The *Access the Career Section administration section* user type permission grants users access to this feature.

User must know the style class used for the element.

Configuration > [Career Section] Administration > Themes

Here's what to do

1. Click the name of a theme.
2. Click the configurable element.
3. Click the name of a style class.
4. Click the name of a style value.
5. Click Edit.
6. Select a value.
7. Click Save.

Results:

The Career Sections using this theme reflect changes.

Changing the Values of a Style Class

Before you start

The *Access the Career Section administration section* user type permission grants users access to this feature.

Theme must be draft or inactive.

Configuration > [Career Section] Administration > Themes > Theme name

Here's what to do

1. Click the type of configurable element.
2. Click the name of a style class.
3. Click the name of a style value.
4. Click Edit.
5. Select a value.
6. Click Save.

Results:

The new value is applied next time the theme is used in a Career Section. All elements using this style class reflect the change.

What to do next

Activating the theme.

Selecting a Default Theme

Before you start

The *Access the Career Section administration section* user type permission grants users access to this feature.

Theme must be inactive.

No other theme must be selected as the default theme.

Configuration > [Career Section] Administration > Themes

Here's what to do

1. Click the name of a theme.
2. Click Set as Default.

Results:

Career Sections with no assigned theme have the values from this theme applied.

What to do next

Activating the theme

Selecting a Theme for a Career Section

Before you start

The *Access the Career Section administration section* user type permission grants users access to this feature.

Career section must have Inactive or Draft status.

Configuration > [Career Section] Administration > Career Sections

Here's what to do

1. Click the name of a Career Section.
2. Click Edit near Properties.
3. Select the name of theme from the Theme drop-down section.
4. Click Save.

Results:

Next time the Career Section is used, the selected theme is used.

Selecting the Font of the Progression Bar

Before you start

The *Access the Career Section administration section* user type permission grants users access to this feature.

Theme must be deactivated.

Configuration > [Career Sections] Administration > Themes > Theme name > Text Configuration

Here's what to do

1. Click Flow Progress Bar.
2. Click the Style Value to change.
3. Click Edit next to Properties.
4. Change the style values of the Flow Progress Bar.
5. Click Save.

Results:

The text displayed in the boxes of the Progress Bar reflect the changes made.

What to do next

Activating the theme.

Viewing Career Sections Associated to a Theme

Before you start

The *Access the Career Section administration section* user type permission grants users access to this feature.

Configuration > [Career Section] Administration > Themes

Here's what to do

1. Select the name of a theme.
2. Click View Associated Career Sections.

Results:

The list of all the Career Sections using this theme is displayed.

Guidelines for Theme Configuration

UI Element	Guidelines
Shopping cart icon	The shopping cart icon is displayed at 2 different areas. The background color of these two areas is not set by the same element. The shopping cart displayed on the top menu, is set on the First color background and the shopping cart located in the legend is set on the Main background color.

UI Element	Guidelines
Links	The action links are not all displayed on the same background color. For example the action link on the search list is set on the Fourth background color, but the links displayed above the progress bar are set on the First background color.
Selected Tab color	Use the same background color for the selected Main tab as for the selected sub tab.
Unselected tab	Use the same background color for the Unselected Main tab as for the unselected sub tab.
Tabs	The text displayed on a tab can be changed via the career portal page feature, but the color of the formatting of the text cannot be changed.
Screening services	The Theme does not control the elements of the external services such as the background check, tax forms... These elements are configured with the Recruiting Screening Service feature.
Word wrapping	If words are wrapping, change the width of display. Recommended width is 720 pixels, but if labels are long they may wrap in a 720 pixel size screen.

Basic Color Customization Guide

This table outlines the theme elements to change to conduct a BASIC theme customization for a Career Section. This process changes the basic colors to customize the general look/feel of a Career Section. Actual colors should be selected according to the organizations best practices in terms of accessibility and branding.

Best Practice for All Career Sections			
Style Class Element	Code	Path in Career Section Administration	Comment
Selected Subtab	88	Themes >Text Configuration > Selected Subtab> Background Color	White
Selected Tab	89	Themes > Text Configuration > Selected Subtab > Background Color	White

Main Background Color #1 in Example			
Style Class Element	Code	Path in Career Section Administration	Comment for choice of color
First Color	98	Background and Color Configuration>First Color>Background Color	Not too dark

Secondary Background Color #2 in Example			
Style Class Element	Code	Path in Career Section Administration	Comment
Unselected Tab	90	Themes >Background and Color Configuration > Unselected tab > Background Color	Medium

Secondary Background Color #2 in Example			
Style Class Element	Code	Path in Career Section Administration	Comment
Second Color	97	Themes > Background and Color Configuration > Unselected tab > Background Color	Medium

Third Background Color #3 in Example			
Style Class Element	Code	Path in Career Section Administration	Comment
Third Color	96	Themes >Background and Color Configuration > Third Color> Background Color	Lightest

Buttons Background Color # 4 in Example			
Style Class Element	Code	Path in Career Section Administration	Comment
Button	398	Themes >Input and Button Control Configuration > Button > Background Color	Medium

Errors / Notifications Background Color #5 in Example			
Style Class Element	Code	Path in Career Section Administration	Comment
Error Message	93	Themes >Background and Color Configuration > Error Message Box > Background Color	
Warning Message Box	94	Themes > Background and Color Configuration > Warning Message> Background Color	
Notification Message Box	95	Themes > Background and Color Configuration > Notification Message Box> Background Color	

Page Title Text Color # 6 in Example			
Style Class Element	Code	Path in Career Section Administration	Comment
Summary Section Title	173	Themes >Text Configuration > Summary Section Title> Color	Darkest
Second Color	175	Themes > Text Configuration > Page title > Color	Darkest

Basic color customization example:

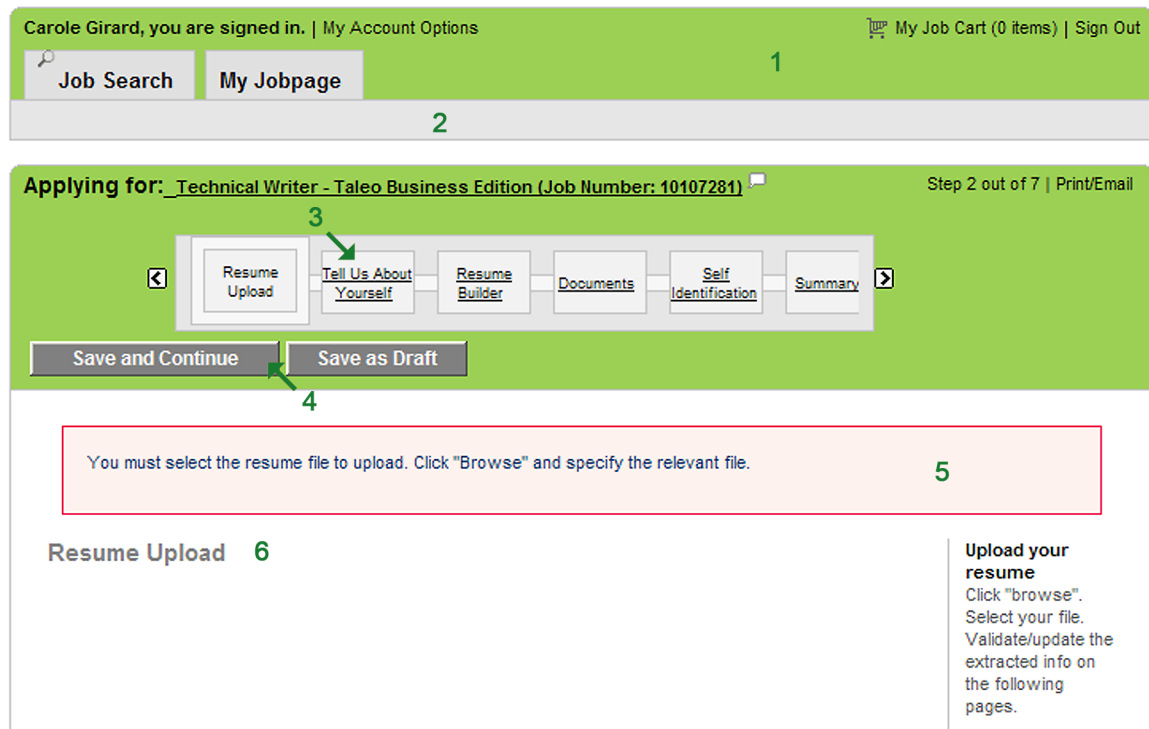

Style Class Values for the Default Taleo Theme

Configurable Elements	Style Classes (code)	Style Values	Values
Background and Color Configuration (Color)	Main Background (99)	Background Color	white
Background and Color Configuration (Color)	First Color (98)	Background Color	#DCC879
Background and Color Configuration (Color)	Second Color (97)	Background Color	#FAF1D1
Background and Color Configuration (Color)	Third Color (96)	Background Color	#FAF1D1
Background and Color Configuration (Color)	Notification Message Box (95)	Background Color	#F1F1F2
Background and Color Configuration (Color)	Warning Message Box (94)	Background Color	#FFF8E5
Background and Color Configuration (Color)	Error Message Box (93)	Background Color	#FEF2EE

Configurable Elements	Style Classes (code)	Style Values	Values
Background and Color Configuration (Color)	Fourth Color (91)	Background Color	#F7F7F7
Background and Color Configuration (Color)	Unselected Tab (90)	Background Color	#F7F7F7
Background and Color Configuration (Color)	Selected Tab (89)	Background Color	#FAF1D1
Background and Color Configuration (Color)	Selected Subtab (88)	Background Color	white
Custom Resource Configuration (Custom)	Custom1 (499)	Background Color	
Custom Resource Configuration (Custom)	Custom1 (499)	Color	
Custom Resource Configuration (Custom)	Custom1 (499)	Font Size	
Custom Resource Configuration (Custom)	Custom1 (499)	Font Style	
Custom Resource Configuration (Custom)	Custom1 (499)	Font Weight	
Custom Resource Configuration (Custom)	Custom1 (499)	Text Decoration	
Custom Resource Configuration (Custom)	Custom2 (498)	Background Color	
Custom Resource Configuration (Custom)	Custom2 (498)	Color	
Custom Resource Configuration (Custom)	Custom2 (498)	Font Size	
Custom Resource Configuration (Custom)	Custom2 (498)	Font Style	
Custom Resource Configuration (Custom)	Custom2 (498)	Font Weight	
Custom Resource Configuration (Custom)	Custom2 (498)	Text Decoration	
Datatraining Configuration (Datatraining)	datatraining-tv Width (1010)	Width	58em
Datatraining Configuration (Datatraining)	datatraining-wrapper Width (1000)	Width	72em
Text Configuration (Font)	General Font (199)	Font Family	helvetica neue, arial, verdana, sans-serif
Text Configuration (Font)	General Font (199)	Font Size	1.1em
Text Configuration (Font)	Subtitle (198)	Color	black
Text Configuration (Font)	Subtitle (198)	Font Size	1.2em

Configurable Elements	Style Classes (code)	Style Values	Values
Text Configuration (Font)	Subtitle (198)	Font Style	normal
Text Configuration (Font)	Subtitle (198)	Font Weight	bold
Text Configuration (Font)	Subtitle (198)	Text Decoration	none
Text Configuration (Font)	Label (197)	Color	#575757
Text Configuration (Font)	Label (197)	Font Size	1.2em
Text Configuration (Font)	Label (197)	Font Style	normal
Text Configuration (Font)	Label (197)	Font Weight	normal
Text Configuration (Font)	Label (197)	Text Decoration	none
Text Configuration (Font)	Text (196)	Color	black
Text Configuration (Font)	Text (196)	Font Size	1.2em
Text Configuration (Font)	Text (196)	Font Style	normal
Text Configuration (Font)	Text (196)	Font Weight	normal
Text Configuration (Font)	Text (196)	Text Decoration	none
Text Configuration (Font)	Header Username (195)	Color	black
Text Configuration (Font)	Header Username (195)	Font Size	1.2em
Text Configuration (Font)	Header Username (195)	Font Style	normal
Text Configuration (Font)	Header Username (195)	Font Weight	bold
Text Configuration (Font)	Header Username (195)	Text Decoration	none
Text Configuration (Font)	Help Title (194)	Color	black
Text Configuration (Font)	Help Title (194)	Font Size	1.0em
Text Configuration (Font)	Help Title (194)	Font Style	normal
Text Configuration (Font)	Help Title (194)	Font Weight	bold
Text Configuration (Font)	Help Title (194)	Text Decoration	none
Text Configuration (Font)	Help Subtitle (193)	Color	#575757
Text Configuration (Font)	Help Subtitle (193)	Font Size	1.0em
Text Configuration (Font)	Help Subtitle (193)	Font Style	normal
Text Configuration (Font)	Help Subtitle (193)	Font Weight	bold
Text Configuration (Font)	Help Subtitle (193)	Text Decoration	none
Text Configuration (Font)	Help Text (192)	Color	#575757
Text Configuration (Font)	Help Text (192)	Font Size	1.0em
Text Configuration (Font)	Help Text (192)	Font Style	normal

Configurable Elements	Style Classes (code)	Style Values	Values
Text Configuration (Font)	Help Text (192)	Font Weight	normal
Text Configuration (Font)	Help Text (192)	Text Decoration	none
Text Configuration (Font)	Legend Title (191)	Color	black
Text Configuration (Font)	Legend Title (191)	Font Size	1.0em
Text Configuration (Font)	Legend Title (191)	Font Style	normal
Text Configuration (Font)	Legend Title (191)	Font Weight	bold
Text Configuration (Font)	Legend Title (191)	Text Decoration	none
Text Configuration (Font)	Legend Text (190)	Color	#575757
Text Configuration (Font)	Legend Text (190)	Font Size	1.0em
Text Configuration (Font)	Legend Text (190)	Font Style	normal
Text Configuration (Font)	Legend Text (190)	Font Weight	normal
Text Configuration (Font)	Legend Text (190)	Text Decoration	none
Text Configuration (Font)	Search Subtitle (189)	Color	
Text Configuration (Font)	Search Subtitle (189)	Font Size	
Text Configuration (Font)	Search Subtitle (189)	Font Style	
Text Configuration (Font)	Search Subtitle (189)	Font Weight	
Text Configuration (Font)	Search Subtitle (189)	Text Decoration	
Text Configuration (Font)	Search Text (188)	Color	
Text Configuration (Font)	Search Text (188)	Font Size	
Text Configuration (Font)	Search Text (188)	Font Style	
Text Configuration (Font)	Search Text (188)	Font Weight	
Text Configuration (Font)	Search Text (188)	Text Decoration	
Text Configuration (Font)	Search Label (187)	Color	
Text Configuration (Font)	Search Label (187)	Font Size	
Text Configuration (Font)	Search Label (187)	Font Style	
Text Configuration (Font)	Search Label (187)	Font Weight	
Text Configuration (Font)	Search Label (187)	Text Decoration	
Text Configuration (Font)	Search Group Label (186)	Color	
Text Configuration (Font)	Search Group Label (186)	Font Size	
Text Configuration (Font)	Search Group Label (186)	Font Style	
Text Configuration (Font)	Search Group Label (186)	Font Weight	

Configurable Elements	Style Classes (code)	Style Values	Values
Text Configuration (Font)	Search Group Label (186)	Text Decoration	
Text Configuration (Font)	List Subtitle (185)	Color	
Text Configuration (Font)	List Subtitle (185)	Font Size	
Text Configuration (Font)	List Subtitle (185)	Font Style	
Text Configuration (Font)	List Subtitle (185)	Font Weight	
Text Configuration (Font)	List Subtitle (185)	Text Decoration	
Text Configuration (Font)	List Text (184)	Color	
Text Configuration (Font)	List Text (184)	Font Size	
Text Configuration (Font)	List Text (184)	Font Style	
Text Configuration (Font)	List Text (184)	Font Weight	
Text Configuration (Font)	List Text (184)	Text Decoration	
Text Configuration (Font)	List Label (183)	Color	
Text Configuration (Font)	List Label (183)	Font Size	
Text Configuration (Font)	List Label (183)	Font Style	
Text Configuration (Font)	List Label (183)	Font Weight	
Text Configuration (Font)	List Label (183)	Text Decoration	
Text Configuration (Font)	Job Type (182)	Color	black
Text Configuration (Font)	Job Type (182)	Font Size	1.2em
Text Configuration (Font)	Job Type (182)	Font Style	normal
Text Configuration (Font)	Job Type (182)	Font Weight	normal
Text Configuration (Font)	Job Type (182)	Text Decoration	none
Text Configuration (Font)	Referral Bonus Amount (181)	Color	#008000
Text Configuration (Font)	Referral Bonus Amount (181)	Font Size	1.2em
Text Configuration (Font)	Referral Bonus Amount (181)	Font Style	normal
Text Configuration (Font)	Referral Bonus Amount (181)	Font Weight	bold
Text Configuration (Font)	Referral Bonus Amount (181)	Text Decoration	none
Text Configuration (Font)	Job Posting Date (180)	Color	#575757
Text Configuration (Font)	Job Posting Date (180)	Font Size	1.2em
Text Configuration (Font)	Job Posting Date (180)	Font Style	normal
Text Configuration (Font)	Job Posting Date (180)	Font Weight	normal
Text Configuration (Font)	Job Posting Date (180)	Text Decoration	none

Configurable Elements	Style Classes (code)	Style Values	Values
Text Configuration (Font)	Job Information (179)	Color	black
Text Configuration (Font)	Job Information (179)	Font Size	1.2em
Text Configuration (Font)	Job Information (179)	Font Style	normal
Text Configuration (Font)	Job Information (179)	Font Weight	bold
Text Configuration (Font)	Job Information (179)	Text Decoration	none
Text Configuration (Font)	Flow Progress Bar (178)	Color	#575757
Text Configuration (Font)	Flow Progress Bar (178)	Font Size	1.0em
Text Configuration (Font)	Flow Progress Bar (178)	Font Style	normal
Text Configuration (Font)	Flow Progress Bar (178)	Font Weight	normal
Text Configuration (Font)	Flow Progress Bar (178)	Text Decoration	none
Text Configuration (Font)	Flow Step (177)	Color	black
Text Configuration (Font)	Flow Step (177)	Font Size	1.2em
Text Configuration (Font)	Flow Step (177)	Font Style	normal
Text Configuration (Font)	Flow Step (177)	Font Weight	normal
Text Configuration (Font)	Flow Step (177)	Text Decoration	none
Text Configuration (Font)	Warning Text (176)	Color	#575757
Text Configuration (Font)	Warning Text (176)	Font Size	1.1em
Text Configuration (Font)	Warning Text (176)	Font Style	italic
Text Configuration (Font)	Warning Text (176)	Font Weight	normal
Text Configuration (Font)	Warning Text (176)	Text Decoration	none
Text Configuration (Font)	Page Title (175)	Color	#D74B00
Text Configuration (Font)	Page Title (175)	Font Size	1.6em
Text Configuration (Font)	Page Title (175)	Font Style	normal
Text Configuration (Font)	Page Title (175)	Font Weight	bold
Text Configuration (Font)	Page Title (175)	Text Decoration	none
Text Configuration (Font)	Page Subtitle (174)	Color	
Text Configuration (Font)	Page Subtitle (174)	Font Size	
Text Configuration (Font)	Page Subtitle (174)	Font Style	
Text Configuration (Font)	Page Subtitle (174)	Font Weight	
Text Configuration (Font)	Page Subtitle (174)	Text Decoration	
Text Configuration (Font)	Summary Section Title (173)	Color	black

Configurable Elements	Style Classes (code)	Style Values	Values
Text Configuration (Font)	Summary Section Title (173)	Font Size	1.4em
Text Configuration (Font)	Summary Section Title (173)	Font Style	normal
Text Configuration (Font)	Summary Section Title (173)	Font Weight	bold
Text Configuration (Font)	Summary Section Title (173)	Text Decoration	none
Text Configuration (Font)	Page List Header (172)	Color	#575757
Text Configuration (Font)	Page List Header (172)	Font Size	1.2em
Text Configuration (Font)	Page List Header (172)	Font Style	normal
Text Configuration (Font)	Page List Header (172)	Font Weight	bold
Text Configuration (Font)	Page List Header (172)	Text Decoration	none
Text Configuration (Font)	Page List Element Title (171)	Color	black
Text Configuration (Font)	Page List Element Title (171)	Font Size	1.2em
Text Configuration (Font)	Page List Element Title (171)	Font Style	normal
Text Configuration (Font)	Page List Element Title (171)	Font Weight	bold
Text Configuration (Font)	Page List Element Title (171)	Text Decoration	none
Text Configuration (Font)	Page Text (170)	Color	
Text Configuration (Font)	Page Text (170)	Font Size	
Text Configuration (Font)	Page Text (170)	Font Style	
Text Configuration (Font)	Page Text (170)	Font Weight	
Text Configuration (Font)	Page Text (170)	Text Decoration	
Text Configuration (Font)	Page Label (169)	Color	
Text Configuration (Font)	Page Label (169)	Font Size	
Text Configuration (Font)	Page Label (169)	Font Style	
Text Configuration (Font)	Page Label (169)	Font Weight	
Text Configuration (Font)	Page Label (169)	Text Decoration	
Text Configuration (Font)	Page Value (168)	Color	black
Text Configuration (Font)	Page Value (168)	Font Size	1.2em
Text Configuration (Font)	Page Value (168)	Font Style	normal
Text Configuration (Font)	Page Value (168)	Font Weight	normal
Text Configuration (Font)	Page Value (168)	Text Decoration	none
Text Configuration (Font)	Error Text (167)	Color	#003366
Text Configuration (Font)	Error Text (167)	Font Size	1.2em

Configurable Elements	Style Classes (code)	Style Values	Values
Text Configuration (Font)	Error Text (167)	Font Style	normal
Text Configuration (Font)	Error Text (167)	Font Weight	normal
Text Configuration (Font)	Error Text (167)	Text Decoration	none
Text Configuration (Font)	Message Title (166)	Color	black
Text Configuration (Font)	Message Title (166)	Font Size	1.4em
Text Configuration (Font)	Message Title (166)	Font Style	normal
Text Configuration (Font)	Message Title (166)	Font Weight	bold
Text Configuration (Font)	Message Title (166)	Text Decoration	none
Text Configuration (Font)	Message Text (165)	Color	black
Text Configuration (Font)	Message Text (165)	Font Size	1.2em
Text Configuration (Font)	Message Text (165)	Font Style	normal
Text Configuration (Font)	Message Text (165)	Font Weight	normal
Text Configuration (Font)	Message Text (165)	Text Decoration	none
Text Configuration (Font)	List Section Title (164)	Color	black
Text Configuration (Font)	List Section Title (164)	Font Size	1.2em
Text Configuration (Font)	List Section Title (164)	Font Style	normal
Text Configuration (Font)	List Section Title (164)	Font Weight	bold
Text Configuration (Font)	List Section Title (164)	Text Decoration	none
Text Configuration (Font)	Balloon Title (163)	Color	black
Text Configuration (Font)	Balloon Title (163)	Font Size	1.3em
Text Configuration (Font)	Balloon Title (163)	Font Style	normal
Text Configuration (Font)	Balloon Title (163)	Font Weight	bold
Text Configuration (Font)	Balloon Title (163)	Text Decoration	none
Text Configuration (Font)	Balloon Label (162)	Color	#575757
Text Configuration (Font)	Balloon Label (162)	Font Size	1.2em
Text Configuration (Font)	Balloon Label (162)	Font Style	normal
Text Configuration (Font)	Balloon Label (162)	Font Weight	normal
Text Configuration (Font)	Balloon Label (162)	Text Decoration	none
Text Configuration (Font)	Balloon Value (161)	Color	black
Text Configuration (Font)	Balloon Value (161)	Font Size	1.2em
Text Configuration (Font)	Balloon Value (161)	Font Style	normal

Configurable Elements	Style Classes (code)	Style Values	Values
Text Configuration (Font)	Balloon Value (161)	Font Weight	normal
Text Configuration (Font)	Balloon Value (161)	Text Decoration	none
Text Configuration (Font)	Balloon Text (160)	Color	black
Text Configuration (Font)	Balloon Text (160)	Font Size	1.2em
Text Configuration (Font)	Balloon Text (160)	Font Style	normal
Text Configuration (Font)	Balloon Text (160)	Font Weight	normal
Text Configuration (Font)	Balloon Text (160)	Text Decoration	none
Text Configuration (Font)	Password Policies (159)	Color	
Text Configuration (Font)	Password Policies (159)	Font Size	
Text Configuration (Font)	Password Policies (159)	Font Style	
Text Configuration (Font)	Password Policies (159)	Font Weight	
Text Configuration (Font)	Password Policies (159)	Text Decoration	
Help Configuration (Help)	helppanel Width (1020)	Display	block
Help Configuration (Help)	helppanel Width (1020)	Width	200px
Input and Button Control Configuration (Input)	Input Control (399)	Background Color	white
Input and Button Control Configuration (Input)	Input Control (399)	Color	black
Input and Button Control Configuration (Input)	Input Control (399)	Font Size	1.3em
Input and Button Control Configuration (Input)	Input Control (399)	Font Style	normal
Input and Button Control Configuration (Input)	Input Control (399)	Font Weight	normal
Input and Button Control Configuration (Input)	Button (398)	Background Color	#D4D0C8
Input and Button Control Configuration (Input)	Button (398)	Color	black
Input and Button Control Configuration (Input)	Button (398)	Font Size	1.3em
Input and Button Control Configuration (Input)	Button (398)	Font Style	normal
Input and Button Control Configuration (Input)	Button (398)	Font Weight	normal
Input and Button Control Configuration (Input)	Job Cart Icon (397)	Background	url("images/ cart_black.gif") no-repeat

Configurable Elements	Style Classes (code)	Style Values	Values
Link Configuration (Link)	Faceted Search - Expand Facet Link (Mouse Over Event) (1067)	Text Decoration	
Link Configuration (Link)	Faceted Search - Expand Facet Link (Mouse Over Event) (1067)	Font Style	
Link Configuration (Link)	Faceted Search - Expand Facet Link (Mouse Over Event) (1067)	Color	
Link Configuration (Link)	Faceted Search - Expand Facet Link (Mouse Over Event) (1067)	Font Weight	
Link Configuration (Link)	Faceted Search - Expand Facet Link (Mouse Over Event) (1067)	Font Size	
Link Configuration (Link)	Faceted Search - Expand Facet Link (Mouse Over Event) (1067)	Background Color	
Link Configuration (Link)	Faceted Search - Expand Facet Link (1066)	Text Decoration	
Link Configuration (Link)	Faceted Search - Expand Facet Link (1066)	Font Style	
Link Configuration (Link)	Faceted Search - Expand Facet Link (1066)	Color	
Link Configuration (Link)	Faceted Search - Expand Facet Link (1066)	Font Weight	
Link Configuration (Link)	Faceted Search - Expand Facet Link (1066)	Font Size	
Link Configuration (Link)	Faceted Search - Search Modal Link (Mouse Over Event)(1065)	Text Decoration	
Link Configuration (Link)	Faceted Search - Search Modal Link (Mouse Over Event) (1065)	Font Style	
Link Configuration (Link)	Faceted Search - Search Modal Link (Mouse Over Event) (1065)	Color	
Link Configuration (Link)	Faceted Search - Search Modal Link (Mouse Over Event) (1065)	Font Weight	
Link Configuration (Link)	Faceted Search - Search Modal Link (Mouse Over Event) (1065)	Font Size	
Link Configuration (Link)	Faceted Search - Search Modal Link (Mouse Over Event) (1065)	Background Color	
Link Configuration (Link)	Faceted Search - Search Modal Link (1064)	Text Decoration	
Link Configuration (Link)	Faceted Search - Search Modal Link (1064)	Font Style	
Link Configuration (Link)	Faceted Search - Search Modal Link (1064)	Color	
Link Configuration (Link)	Faceted Search - Search Modal Link (1064)	Font Weight	

Configurable Elements	Style Classes (code)	Style Values	Values
Link Configuration (Link)	Faceted Search - Search Modal Link (1064)	Font Size	
Link Configuration (Link)	Faceted Search - Title Link (Mouse Over Event) (1063)	Font Style	
Link Configuration (Link)	Faceted Search - Title Link (Mouse Over Event) (1063)	Color	
Link Configuration (Link)	Faceted Search - Title Link (Mouse Over Event) (1063)	Font Weight	
Link Configuration (Link)	Faceted Search - Title Link (Mouse Over Event) (1063)	Font Size	
Link Configuration (Link)	Faceted Search - Title Link (Mouse Over Event) (1063)	Background Color	
Link Configuration (Link)	Faceted Search - Title Link (1062)	Text Decoration	
Link Configuration (Link)	Faceted Search - Title Link (1062)	Font Style	
Link Configuration (Link)	Faceted Search - Title Link (1062)	Color	
Link Configuration (Link)	Faceted Search - Title Link (1062)	Font Weight	
Link Configuration (Link)	Faceted Search - Title Link (1062)	Font Size	
Link Configuration (Link)	Header and Footer Link (299)	Color	blue
Link Configuration (Link)	Header and Footer Link (299)	Font Size	1.0em
Link Configuration (Link)	Header and Footer Link (299)	Font Style	normal
Link Configuration (Link)	Header and Footer Link (299)	Font Weight	normal
Link Configuration (Link)	Header and Footer Link (299)	Text Decoration	none
Link Configuration (Link)	Header and Footer Link (Mouse Over Event) (298)	Background Color	
Link Configuration (Link)	Header and Footer Link (Mouse Over Event) (298)	Color	blue
Link Configuration (Link)	Header and Footer Link (Mouse Over Event) (298)	Font Size	
Link Configuration (Link)	Header and Footer Link (Mouse Over Event) (298)	Font Style	
Link Configuration (Link)	Header and Footer Link (Mouse Over Event) (298)	Font Weight	
Link Configuration (Link)	Header and Footer Link (Mouse Over Event) (298)	Text Decoration	underline
Link Configuration (Link)	Regular Link (297)	Color	blue
Link Configuration (Link)	Regular Link (297)	Font Size	1.1em
Link Configuration (Link)	Regular Link (297)	Font Style	normal

Configurable Elements	Style Classes (code)	Style Values	Values
Link Configuration (Link)	Regular Link (297)	Font Weight	normal
Link Configuration (Link)	Regular Link (297)	Text Decoration	none
Link Configuration (Link)	Regular Link (Mouse Over Event) (296)	Background Color	
Link Configuration (Link)	Regular Link (Mouse Over Event) (296)	Color	
Link Configuration (Link)	Regular Link (Mouse Over Event) (296)	Font Size	
Link Configuration (Link)	Regular Link (Mouse Over Event) (296)	Font Style	
Link Configuration (Link)	Regular Link (Mouse Over Event) (296)	Font Weight	
Link Configuration (Link)	Regular Link (Mouse Over Event) (296)	Text Decoration	underline
Link Configuration (Link)	Action Link (295)	Color	blue
Link Configuration (Link)	Action Link (295)	Font Size	1.2em
Link Configuration (Link)	Action Link (295)	Font Style	normal
Link Configuration (Link)	Action Link (295)	Font Weight	bold
Link Configuration (Link)	Action Link (295)	Text Decoration	none
Link Configuration (Link)	Action Link (Mouse Over Event) (294)	Background Color	
Link Configuration (Link)	Action Link (Mouse Over Event) (294)	Color	
Link Configuration (Link)	Action Link (Mouse Over Event) (294)	Font Size	
Link Configuration (Link)	Action Link (Mouse Over Event) (294)	Font Style	
Link Configuration (Link)	Action Link (Mouse Over Event) (294)	Font Weight	
Link Configuration (Link)	Action Link (Mouse Over Event) (294)	Text Decoration	underline
Link Configuration (Link)	Title Link (293)	Color	blue
Link Configuration (Link)	Title Link (293)	Font Size	1.5em
Link Configuration (Link)	Title Link (293)	Font Style	normal
Link Configuration (Link)	Title Link (293)	Font Weight	bold
Link Configuration (Link)	Title Link (293)	Text Decoration	none
Link Configuration (Link)	Title Link (Mouse Over Event) (292)	Background Color	
Link Configuration (Link)	Title Link (Mouse Over Event) (292)	Color	
Link Configuration (Link)	Title Link (Mouse Over Event) (292)	Font Size	
Link Configuration (Link)	Title Link (Mouse Over Event) (292)	Font Style	
Link Configuration (Link)	Title Link (Mouse Over Event) (292)	Font Weight	
Link Configuration (Link)	Title Link (Mouse Over Event) (292)	Text Decoration	underline
Link Configuration (Link)	Pager Disabled Link (291)	Color	black

Configurable Elements	Style Classes (code)	Style Values	Values
Link Configuration (Link)	Pager Disabled Link (291)	Font Size	1.2em
Link Configuration (Link)	Pager Disabled Link (291)	Font Style	normal
Link Configuration (Link)	Pager Disabled Link (291)	Font Weight	normal
Link Configuration (Link)	Pager Disabled Link (291)	Text Decoration	none
Link Configuration (Link)	Help Link (290)	Color	blue
Link Configuration (Link)	Help Link (290)	Font Size	1.0em
Link Configuration (Link)	Help Link (290)	Font Style	normal
Link Configuration (Link)	Help Link (290)	Font Weight	normal
Link Configuration (Link)	Help Link (290)	Text Decoration	none
Link Configuration (Link)	Help Link (Mouse Over Event) (289)	Background Color	
Link Configuration (Link)	Help Link (Mouse Over Event) (289)	Color	blue
Link Configuration (Link)	Help Link (Mouse Over Event) (289)	Font Size	
Link Configuration (Link)	Help Link (Mouse Over Event) (289)	Font Style	
Link Configuration (Link)	Help Link (Mouse Over Event) (289)	Font Weight	
Link Configuration (Link)	Help Link (Mouse Over Event) (289)	Text Decoration	underline
Link Configuration (Link)	Small Link (288)	Color	blue
Link Configuration (Link)	Small Link (288)	Font Size	1.0em
Link Configuration (Link)	Small Link (288)	Font Style	normal
Link Configuration (Link)	Small Link (288)	Font Weight	normal
Link Configuration (Link)	Small Link (288)	Text Decoration	none
Link Configuration (Link)	Small Link (Mouse Over Event) (287)	Background Color	
Link Configuration (Link)	Small Link (Mouse Over Event) (287)	Color	blue
Link Configuration (Link)	Small Link (Mouse Over Event) (287)	Font Size	
Link Configuration (Link)	Small Link (Mouse Over Event) (287)	Font Style	
Link Configuration (Link)	Small Link (Mouse Over Event) (287)	Font Weight	
Link Configuration (Link)	Small Link (Mouse Over Event) (287)	Text Decoration	underline
Link Configuration (Link)	Date Selector Link (286)	Color	blue
Link Configuration (Link)	Date Selector Link (286)	Font Size	1.2em
Link Configuration (Link)	Date Selector Link (286)	Font Style	normal
Link Configuration (Link)	Date Selector Link (286)	Font Weight	normal
Link Configuration (Link)	Date Selector Link (286)	Text Decoration	underline

Configurable Elements	Style Classes (code)	Style Values	Values
Link Configuration (Link)	Button Link (285)	Background Color	#EAEAEA
Link Configuration (Link)	Button Link (285)	Color	black
Link Configuration (Link)	Button Link (285)	Font Size	1.1em
Link Configuration (Link)	Button Link (285)	Font Style	normal
Link Configuration (Link)	Button Link (285)	Font Weight	normal
Link Configuration (Link)	Button Link (285)	Text Decoration	none
Link Configuration (Link)	Button Link (Mouse Over Event) (284)	Background Color	silver
Link Configuration (Link)	Button Link (Mouse Over Event) (284)	Color	
Link Configuration (Link)	Button Link (Mouse Over Event) (284)	Font Size	
Link Configuration (Link)	Button Link (Mouse Over Event) (284)	Font Style	
Link Configuration (Link)	Button Link (Mouse Over Event) (284)	Font Weight	
Link Configuration (Link)	Button Link (Mouse Over Event) (284)	Text Decoration	

Career Section Images

Theme elements properties are used throughout the Career Section. Text in the images has been changed to symbols corresponding to style classes.

Career Section Header

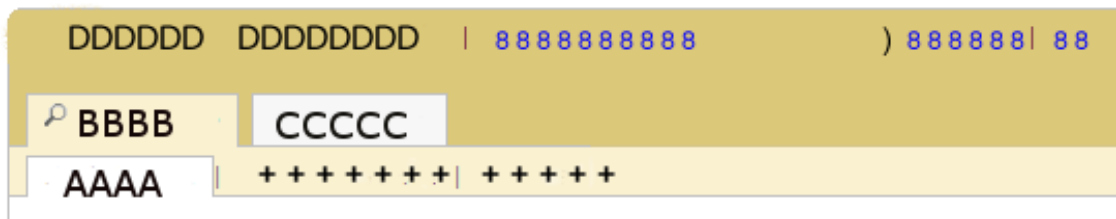

Key

Career Section Footer

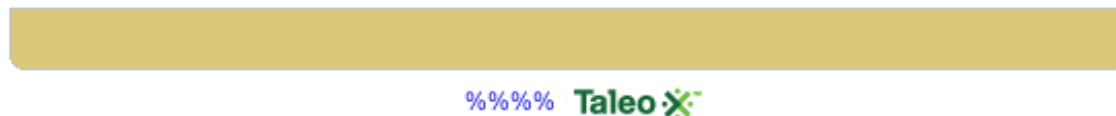

Key

Career Section Login Page

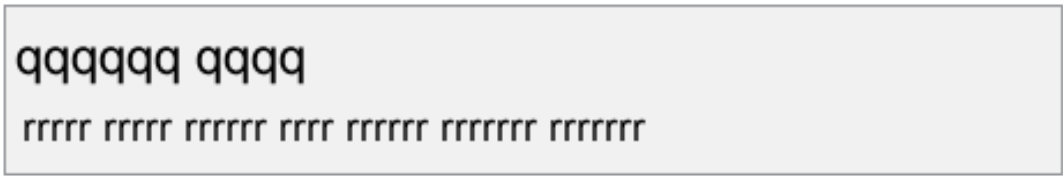

ffffff fffff fff

iiiiii iiiii iiiiiii iiiiiii iiiii iiiii i iiiii iiiii iiiii iiiii iii iiiii iiiii iiiiiii
iiiiiiii iiiii iiiii i iiiii iiiii iiiii iiiii iii iii iiiii iiiiiiiiiiiiiiiii iiiii iiiii iiiiiiiii

dddddddd ddddd ddd ddddd dddd dd ddddd

*+++++

*+++++

e e e e e e e e
e e e e e e e e

Key

Career Section Search Form

EEEEEEEEEEEEEEEE

EEEEEEEEEEEE 

WWW WWWWWW WW WW WWWW WW 999999 | 999999

XXXX XXX

}}}

XXXXXXXX

FFFFFFFF

OOOOOO

}}}

@@@@@@@@

LLLLLLLL

NNNNNNNNNN
NNNNNNNNNN
NNNNN

MMMMM

NNNNNNNNNN
NNNNNNNNNN
NNNNN

MMMMMM

NNNNNNNNNN
NNNNNNNNNN
NNNNN

~~~~~

~~~~

Key

Career Section Search Results

GGGGGGGGGG (GGGGGGGGG)

HHHHHHHH

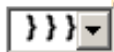

HHHHHHHH

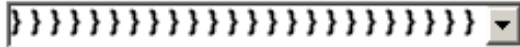

MMMMM

NNNNNNNNN
NNNNNNNNN
NNNNNNNNN
NNNNNNNNN
NNNNNNNNN
NNNNNNNNN
NNNNNNNNN
NNNNNNNNN
NNNNNNNNN
NNNNNNNNN
NNNNNNNNN

<<<<<<<<<<<

PPPPPPP

RRRRRRRRR
RRRRRRRRR

RRRRRRRRR
RRRRRRRRR

RRRRRRRRR
RRRRRRRRR

ZZZZZZ
JJJJJJ JJJJJJ, JJJJJJ JJJJJJ JJJJJJ 9999
bbbbbbbbbbbbbbbb -JJJJJJJJJJJJJJ
JJJJJJJJ JJJJJJJJJJ UUUU
9999 | 99999999

ZZZZZZ
JJJJJJ JJJJJJ, JJJJJJ JJJJJJ JJJJJJ
bbbbbbbbbbbbbbbb -JJJJJJJJJJJJJJ
9999|9999999999

ZZZZZZ
JJJJJJ JJJJJJ, JJJJJJ JJJJJJ JJJJJJ
bbbbbbbbbbbbbbbb -JJJJJJJJJJJJJJ
9999|9999999999

HHH HHHHH HHH HHHHHH %%%% | %%| %%%%

Key

Balloon

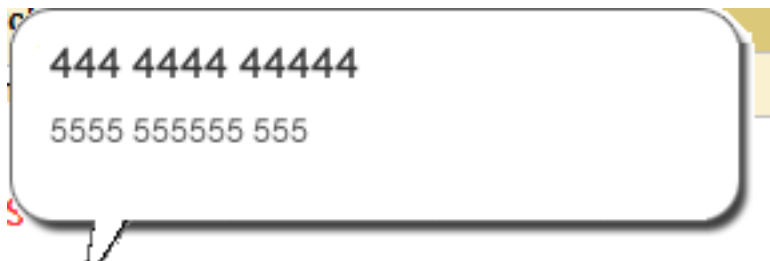

Key

Balloon With Search Criteria

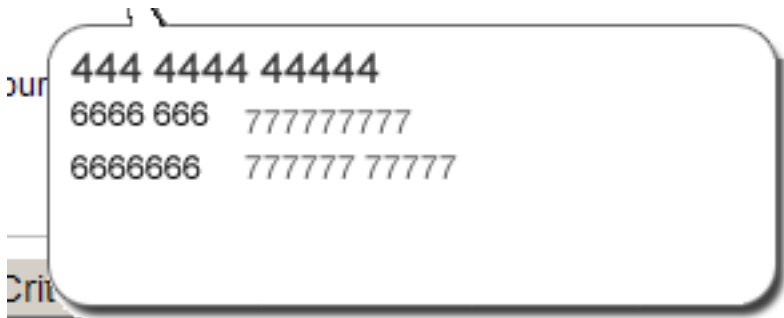

Key

Application Flow Header

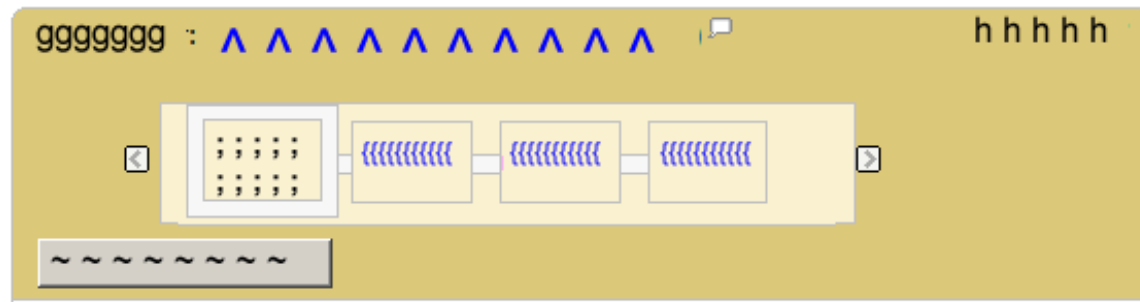

Key

Application Flow Footer



Key

Application Flow Form

333333 333 3333 3333 3333 3333

ffffff ffffff fff

iiiiiiiiiii iiiiii iii

* * * * * .

* * * * * * * * * * * * * * * * * *

SSSSSSSSSS SSSSSSSSS

iiiiiiiiiiiiii iiiiiiiiiiiiiiii iiiiiiiiiiiiiiii iiiiiiiiiiiiiiii iiiiiiiiiiiiiiii iiiiiiiii

| | | |
|--------------------------|----------------|--------------|
| *222222222222 | * 222222222222 | 222222222222 |
| tttttttttttttttttttttttt | tttttttttt | tttttttttt |

LLLLLLLLL

NNNNNNNNNN
NNNNNNNNNN
NNNNNNNNNN
NNNNNNNNNN
NNNNNNNNNN
NNNNNNNNNN
NNNNNNNNNN
NNNNNNNNNN

Key

Application Flow OLF Block

eeeeeeeeee eeeeeee

iiiiiii iiiiiiiiii iiiiiiiiiiiiiiii iiiiiiiiii iiiiiiiiiiiiiiii iiiiiiiiii iiii

eeeeeeeeeeeeee

| |
|-----------------|
| ¥ ¥ ¥ ¥ ¥ ¥ ¥ ¥ |
| £ £ £ £ £ £ |

| | |
|---------|-------|
| ~ ~ ~ ~ | ~ ~ ~ |
|---------|-------|

eeeeeeeeeeeeee

KKKKKKKKKKKKKKKK

iii iiiiiiiiii iiiiiiiiiiiiiiii iiiiiiiiii iiii

€ € € € € €

Key

Application Flow Shift Grid

| TTTTTT | TTTTTTTTT | | | | | | |
|--------|-------------------------------------|-------------------------------------|--------------------------|--------------------------|--------------------------|--------------------------|--------------------------|
| (((| ((| ((| ((| ((| ((| ((| ((|
| (((| <input type="checkbox"/> | <input type="checkbox"/> | <input type="checkbox"/> | <input type="checkbox"/> | <input type="checkbox"/> | <input type="checkbox"/> | <input type="checkbox"/> |
| (((| <input checked="" type="checkbox"/> | <input type="checkbox"/> | <input type="checkbox"/> | <input type="checkbox"/> | <input type="checkbox"/> | <input type="checkbox"/> | <input type="checkbox"/> |
| (((| <input type="checkbox"/> | <input checked="" type="checkbox"/> | <input type="checkbox"/> | <input type="checkbox"/> | <input type="checkbox"/> | <input type="checkbox"/> | <input type="checkbox"/> |
| (((| <input type="checkbox"/> | <input type="checkbox"/> | <input type="checkbox"/> | <input type="checkbox"/> | <input type="checkbox"/> | <input type="checkbox"/> | <input type="checkbox"/> |
| (((| <input type="checkbox"/> | <input type="checkbox"/> | <input type="checkbox"/> | <input type="checkbox"/> | <input type="checkbox"/> | <input type="checkbox"/> | <input type="checkbox"/> |

Key

Application Flow Summary

fffff fffff fff

kkkkkkk kkkkkkk kkkkkkkkkk kkkkkkkkk kkkkkkkk
kkkkkkkkkkk kkkkkkkkkkkkkkkkkkkkkk kkkkkkk kkkkkkkkkkk

mmmmmmmmmm | &&&&

eeeeeeeeeeee

222 2222222222
2222222 22222

| | |
|--------------------------|--------------|
| tttttttttttttttttttttttt | 222222222222 |
| tttttttttttttttttttttttt | 222222222222 |

mmmmmmmm | &&&&

| TTTTTTT | TTTTTTT | | | | | | |
|--------------|---------|-----|-----|-----|-----|-----|-----|
| kkkkkkkkkkkk | kkk | kkk | kkk | kkk | kkk | kkk | kkk |
| kkkkkkkkkkkk | ✓ | | | | | | |
| kkkkkkkkkkkk | | | | | | | |
| kkkkkkkkkkkk | | | | | | | |
| kkkkkkkkkkkk | | | | | | | |
| kkkkkkkkkkkk | | | | | | | |

Key

Style Classes

Style classes is a guide to the element properties of the Career Section images.

| Key | Description | Background | Text |
|---------------------------|---|-----------------------------|---|
| Career Section Header | | | Black |
| A | Selected sub-tab <ul style="list-style-type: none"> Career Section Header | Selected sub-tab: 88 | Black |
| B | Selected tab <ul style="list-style-type: none"> Career Section Header | Selected tab: 89 | Black |
| C | Unselected Tab <ul style="list-style-type: none"> Career Section Header | Unselected Tab: 90 | Black |
| D | Candidate user logged in status <ul style="list-style-type: none"> Career Section Header | First Color: 98 | Header Username: 195 |
| 8 | Links in the Career Section header <ul style="list-style-type: none"> Career Section Header | First Color: 98 | <ul style="list-style-type: none"> Header and Footer Link: 299 Header and Footer Link (Mouse over event):298 |
|) | Job cart icon <ul style="list-style-type: none"> Career Section Header | First Color: 98 | Job Cart Icon: 397 |
| + | Unselected sub-tab <ul style="list-style-type: none"> Career Section Header | Second Color: 98 | Black |
| Career Section Footer | | | |
| % | Search results pager links <ul style="list-style-type: none"> Career Section Search Results Career Section Footer | Background:99 | Disabled Links <ul style="list-style-type: none"> Page Disabled Link:291 Active Links <ul style="list-style-type: none"> Button Link:285 Button Link(Mouse over event):284 |
| Career Section Login Page | | | |
| d | Required fields marked with an asterisk message in the Career Section. <ul style="list-style-type: none"> Career Section Login | Second Color:98 | Warning Text:176 |
| f | Login page titles <ul style="list-style-type: none"> Career Section Login Application Flow Form Application Flow Summary | Background:99 | Page Title:175 |
| i | Text <ul style="list-style-type: none"> Career Section Login Application Flow Form Application flow OLF block | Background:99 | Page Text:170 |
| q | Message title for form errors in the Career Section. | Notification Message Box:95 | Message Title:166 |

| Key | Description | Background | Text |
|----------------------------|---|---|---|
| | <ul style="list-style-type: none"> Career Section Login | | |
| r | Message body for form errors in the Career Section. <ul style="list-style-type: none"> Career Section Login | Notification Message Box:95 | Message Text:165 |
| ~ | Button <ul style="list-style-type: none"> Career Section Search Form Career Section Login Application Flow Header Application Flow Footer Application Flow OLF Block | Button:398 | Button:398 |
| € | Login help links <ul style="list-style-type: none"> Career Section Login | Background:99 | Blue |
| ‡ | Login form labels <ul style="list-style-type: none"> Career Section Login | Background:99 | Black |
| ¿ | Login form elements <ul style="list-style-type: none"> Career Section Login | White | Black |
| Career Section Search Form | | | |
| E | Search title and subtitle <ul style="list-style-type: none"> Career Section Search Form | Background:99 | <ul style="list-style-type: none"> Subtitle:198198 Search Subtitle:189 overrides 198 174 overrides 189 |
| F | Tab label <ul style="list-style-type: none"> Career Section Search Form | <ul style="list-style-type: none"> Tab> Fourth Color: 91 Back panel>Second Color:96 | Label:197 |
| L | Help panel title <ul style="list-style-type: none"> Career Section Search Form Application Flow Form | Background:99 | Help Title:194 |
| M | Subtitles in the help panel <ul style="list-style-type: none"> Career Section Search Form Career Section Search Results | Background:99 | Help Subtitle:193 |
| N | Help panel text <ul style="list-style-type: none"> Career Section Search Form Career Section Search Results Application Flow Form | Background:99 | Help Text:192 |
| O | Search form select list label <ul style="list-style-type: none"> Career Section Search Form | Fourth Color: 91 | Text:196 |
| W | Job search form instructions | Background:99 | <ul style="list-style-type: none"> Search Text:188 |

| Key | Description | Background | Text |
|-------------------------------|---|------------------------------------|---|
| | <ul style="list-style-type: none"> Career Section Search Form | | <ul style="list-style-type: none"> Page Text:170 |
| X | Search form text box labels <ul style="list-style-type: none"> Career Section Search Form | Background: 99 | Search Label: 187 |
| 9 | Links <ul style="list-style-type: none"> Career Section Search Form Career Section Search Results | Background: 99 | <ul style="list-style-type: none"> Regular Link:297 Regular Link (Mouse over event):296 |
| @ | Add or remove olf criteria <ul style="list-style-type: none"> Career Section Search Form | Fourth Color: 91 | <ul style="list-style-type: none"> Action Link:295 Action Link (Mouse over event):294 |
| ~ | Button <ul style="list-style-type: none"> Career Section Search Form Career Section Login Application Flow Header Application Flow Footer Application Flow OLF Block | Button: 398 | Button: 398 |
| } | System Form Content <ul style="list-style-type: none"> Career Section Search Results Career Section Search Form | Input Control: 399 | Input Control: 399 |
| Career Section Search Results | | | |
| G | Search results title <ul style="list-style-type: none"> Career Section Search Results | Background: 99 | <ul style="list-style-type: none"> Subtitle:198 List Subtitle:185 overrides 198 |
| H | Label for the search results form <ul style="list-style-type: none"> Career Section Search Results | Background: 99 | List Label: 183 |
| J | List Text <ul style="list-style-type: none"> Career Section Search Results | Background: 99 | <ul style="list-style-type: none"> Subtitle:198 List Text:184 overrides 198 |
| M | Subtitles in the help panel <ul style="list-style-type: none"> Career Section Search Form Career Section Search Results | Background: 99 | Help Subtitle: 193 |
| N | Help panel text <ul style="list-style-type: none"> Career Section Search Form Career Section Search Results Application Flow Form | Background: 99 | Help Text: 192 |
| P | Title for the icon legend <ul style="list-style-type: none"> Career Section Search Results | Background: 99 | Legend Title: 191 |
| R | Text for the icon legend <ul style="list-style-type: none"> Career Section Search Results | Background: 99 | Legend Text: 190 |

| Key | Description | Background | Text |
|------------------------------|---|--------------------|---|
| U | Referral Bonus Amount <ul style="list-style-type: none"> Career Section Search Results | Background:99 | Referral Bonus Amount:181 |
| Z | | Background:99 | |
| b | Job Posting Date <ul style="list-style-type: none"> Career Section Search Results | Background:99 | Job Posting Date:180 |
| 9 | Links <ul style="list-style-type: none"> Career Section Search Form Career Section Search Results | Background:99 | <ul style="list-style-type: none"> Regular Link:297 Regular Link (Mouse over event):296 |
| % | Search results pager links <ul style="list-style-type: none"> Career Section Search Results Career Section Footer | Background:99 | Disabled Links <ul style="list-style-type: none"> Page Disabled Link:291 Active Links <ul style="list-style-type: none"> Button Link:285 Button Link(Mouse over event):284 |
| } | System Form Content <ul style="list-style-type: none"> Career Section Search Results Career Section Search Form | Input Control: 399 | Input Control: 399 |
| < | Links in the help panel <ul style="list-style-type: none"> Career Section Search Results | Background:99 | <ul style="list-style-type: none"> Help Link:290 Help Link (Mouse over event):289 |
| # | Job listing title <ul style="list-style-type: none"> Career Section Search Results | Background:99 | <ul style="list-style-type: none"> Title Link:293 Title Link(Mouse over event):292 |
| Information Balloon | | | |
| 4 | Balloon Title <ul style="list-style-type: none"> Information Balloon Search Criteria Balloon | White | Balloon Title:163 |
| 5 | Balloon Text <ul style="list-style-type: none"> Information Balloon | White | Balloon Text:160 |
| Balloon With Search Criteria | | | |
| 4 | Balloon Title <ul style="list-style-type: none"> Information Balloon Search Criteria Balloon | White | Balloon Title:163 |
| 6 | Balloon search summary label <ul style="list-style-type: none"> Search Criteria Balloon | White | Balloon Label:162 |
| 7 | Balloon search summary value <ul style="list-style-type: none"> Search Criteria Balloon | White | Balloon Value:161 |
| Application Flow Header | | | |

| Key | Description | Background | Text |
|-------------------------|---|--|---|
| g | Applying for <ul style="list-style-type: none"> Application Flow Header | First Color:98 | Job Information:179 |
| h | Application flow page number information <ul style="list-style-type: none"> Application Flow Header | First Color:98 | Flow Step:177 |
| ^ | Job title in the application flow header <ul style="list-style-type: none"> Application Flow Header | First Color:98 | <ul style="list-style-type: none"> Action Link:295 Action Link (Mouse over event):294 |
| { | Links in the progress bar <ul style="list-style-type: none"> Application Flow Header | <ul style="list-style-type: none"> Flow Step>Third Color:96 Progress Bar> Second Color:97 | <ul style="list-style-type: none"> Small Link:288 Small Link (Mouse over event):287 |
| & | Edit <ul style="list-style-type: none"> Application Flow Summary | Second Color:97 | <ul style="list-style-type: none"> Regular Link:297 Regular Link (Mouse over event):296 |
| ; | Selected Flow Step <ul style="list-style-type: none"> Application Flow Header | <ul style="list-style-type: none"> Flow Step>Third Color:96 Flow Step Frame>Fourth Color: 91 Progress Bar> Second Color:97 | Flow Progress Bar:178 |
| ~ | Button <ul style="list-style-type: none"> Career Section Search Form Career Section Login Application Flow Header Application Flow Footer Application Flow OLF Block | Button:398 | Button:398 |
| Application Flow Footer | | | |
| ~ | Button <ul style="list-style-type: none"> Career Section Search Form Career Section Login Application Flow Header Application Flow Footer Application Flow OLF Block | Button:398 | Button:398 |
| Application Flow Form | | | |
| L | Help panel title <ul style="list-style-type: none"> Career Section Search Form Application Flow Form | Background:99 | Help Title:194 |
| N | Help panel text <ul style="list-style-type: none"> Career Section Search Form | Background:99 | Help Text:192 |

| Key | Description | Background | Text |
|----------------------------|---|----------------------|--|
| | <ul style="list-style-type: none"> Career Section Search Results Application Flow Form | | |
| S | Application flow block title <ul style="list-style-type: none"> Application Flow Form | Background:99 | Subtitle:198 |
| f | Application flow page titles <ul style="list-style-type: none"> Career Section Login Application Flow Form Application Flow Summary | Background:99 | Page Title:175 |
| i | Text <ul style="list-style-type: none"> Career Section Login Application Flow Form Application flow OLF block | Background:99 | Page Text:170 |
| t | Input Labels <ul style="list-style-type: none"> Application Flow Form Summary page element labels | | Page Label:169 |
| 2 | Label <ul style="list-style-type: none"> Application Flow Form | Background:99 | Page Value:168 |
| 3 | Application Flow Form Error <ul style="list-style-type: none"> Application Flow Form | Error Message Box:93 | Error Text:167 |
| * | Application flow form tips <ul style="list-style-type: none"> Application Flow Form | Background:99 | Black |
| Application Flow OLF Block | | | |
| K | Preference title in OLF block <ul style="list-style-type: none"> Application flow OLF block | Background99 | Page List Element Title:171 |
| e | Page subtitles in the application flow <ul style="list-style-type: none"> Application flow OLF block Application Flow Summary | Background:99 | <ul style="list-style-type: none"> List Text:198 Page Subtitle:174 overrides 198 |
| i | Text <ul style="list-style-type: none"> Career Section Login Application Flow Form Application flow OLF block | Background:99 | Page Text:170 |
| ~ | Button <ul style="list-style-type: none"> Career Section Search Form Career Section Login Application Flow Header Application Flow Footer | Button:398 | Button:398 |

| Key | Description | Background | Text |
|-----------------------------|---|--|--|
| | <ul style="list-style-type: none"> Application Flow OLF Block | | |
| ¥ | OLF form label <ul style="list-style-type: none"> Application Flow OLF Block | Background:99 | Grey |
| £ | OLF form element <ul style="list-style-type: none"> Application Flow OLF Block | White | Black |
| € | Remove <ul style="list-style-type: none"> Application Flow OLF Block | Background:99 | Blue |
| Application Flow Shift Grid | | | |
| T | Shift grid title <ul style="list-style-type: none"> Shift Grid Block Application Flow Summary | First Color:98 | <ul style="list-style-type: none"> Subtitle:198 Page Subtitle:174 overwrites 198 |
| (| Shift grid buttons <ul style="list-style-type: none"> Shift Grid Block | <ul style="list-style-type: none"> Button Link:285 Button Link(Mouse over event):284 | <ul style="list-style-type: none"> Button Link:285 Button Link(Mouse over event):284 |
| Application Flow Summary | | | |
| T | Shift grid title <ul style="list-style-type: none"> Shift Grid Block Application Flow Summary | First Color:98 | <ul style="list-style-type: none"> Subtitle:198 Page Subtitle:174 overwrites 198 |
| e | Page subtitles in the application flow <ul style="list-style-type: none"> Application flow OLF block Application Flow Summary | Background:99 | <ul style="list-style-type: none"> List Text:198 Page Subtitle:174 overrides 198 |
| f | Application flow page titles <ul style="list-style-type: none"> Application Flow Form Application Flow Summary | Background:99 | Page Title:175 |
| k | Text in the heading of the summary page of the application flow <ul style="list-style-type: none"> Application Flow Summary | Background:99 | Summary Section Title:173 |
| m | Summary section title <ul style="list-style-type: none"> Application Flow Summary | Second Color:97 | Summary Section Title:173 |
| n | | Second Color:97 | Page Text:170 |
| t | Input Labels <ul style="list-style-type: none"> Application Flow Form Summary page element labels | | Page Label:169 |
| 2 | Label <ul style="list-style-type: none"> Application Flow Form | Background:99 | Page Value:168 |

| Key | Description | Background | Text |
|-----|---|---|---|
| & | Edit <ul style="list-style-type: none"> Application Flow Summary | Second Color: 97 | <ul style="list-style-type: none"> Regular Link:297 Regular Link (Mouse over event):296 |

Style Guide

Style classes can be configured in Configuration > [Career Section] Administration > Themes > Theme name > Text Configuration.

| Code | Configurable Elements | Style Class | Description |
|------|--|----------------------------------|--|
| 88 | Background and Color Configuration <ul style="list-style-type: none"> Background Color | Selected Sub-tab | Style used for selected sub-tabs. |
| 89 | Background and Color Configuration <ul style="list-style-type: none"> Background Color | Selected Tab | Style used for selected tabs. |
| 90 | Background and Color Configuration <ul style="list-style-type: none"> Background Color | Unselected Tab | Style used for unselected tabs. |
| 91 | Background and Color Configuration <ul style="list-style-type: none"> Background Color | Fourth Color | Color used for list groupings and search areas content. |
| 93 | Background and Color Configuration <ul style="list-style-type: none"> Background Color | Error Message Box | Message box used for errors. |
| 94 | Background and Color Configuration <ul style="list-style-type: none"> Background Color | Warning Message Box | Message box used for warnings. |
| 95 | Background and Color Configuration <ul style="list-style-type: none"> Background Color | Notification Message Box | Message box used for notifications. |
| 96 | Background and Color Configuration <ul style="list-style-type: none"> Background Color | Third Color | Color used for search components, subtabs, etc. |
| 97 | Background and Color Configuration <ul style="list-style-type: none"> Background Color | Second Color | Color used for subtabs, updated list elements, group content, etc. |
| 98 | Background and Color Configuration <ul style="list-style-type: none"> Background Color | First Color | Color used for headers, footers, tabs, group headers, etc. |
| 99 | Background and Color Configuration <ul style="list-style-type: none"> Background Color | Main Background | Color used for the main background. |
| 158 | Text Configuration <ul style="list-style-type: none"> Font Style Text Decoration | Highlighted Job Status Indicator | Style used for “New” that is displayed next to each new job added to a candidate’s job cart. |

| Code | Configurable Elements | Style Class | Description |
|------|---|--------------------|--|
| | <ul style="list-style-type: none"> Font Size Font Weight Color | | |
| 159 | Text Configuration <ul style="list-style-type: none"> Font Style Text Decoration Font Size Font Weight Color | Password Policies | Style used for error message that appears when entering invalid information when logging in. |
| 160 | Text Configuration <ul style="list-style-type: none"> Font Style Text Decoration Font Size Font Weight Color | Balloon Text | Style used for balloon text. |
| 161 | Text Configuration <ul style="list-style-type: none"> Font Style Text Decoration Font Size Font Weight Color | Balloon Value | Style used for balloon values. |
| 162 | Text Configuration <ul style="list-style-type: none"> Font Style Text Decoration Font Size Font Weight Color | Balloon Label | Style used for balloon labels. |
| 163 | Text Configuration <ul style="list-style-type: none"> Font Style Text Decoration Font Size Font Weight Color | Balloon Title | Style used for balloon titles. |
| 164 | Text Configuration <ul style="list-style-type: none"> Font Style Text Decoration Font Size | List section title | Style used for section titles in list pages. |

| Code | Configurable Elements | Style Class | Description |
|------|---|---------------|--|
| | <ul style="list-style-type: none"> Font Weight Color | | |
| 165 | Text Configuration <ul style="list-style-type: none"> Font Style Text Decoration Font Size Font Weight Color | Message Text | Style used for text and titles in message boxes. |
| 166 | Text Configuration <ul style="list-style-type: none"> Font Style Text Decoration Font Size Font Weight Color | Message Title | Style used for titles in message boxes. |
| 167 | Text Configuration <ul style="list-style-type: none"> Font Style Text Decoration Font Size Font Weight Color | Error Text | Style used for text in error message boxes. |
| 168 | Text Configuration <ul style="list-style-type: none"> Font Style Text Decoration Font Size Font Weight Color | Page Value | Style used for values in flow and summary pages. |
| 169 | Text Configuration <ul style="list-style-type: none"> Font Style Text Decoration Font Size Font Weight Color | Page Label | Style used for labels in flow and summary pages. |
| 170 | Text Configuration <ul style="list-style-type: none"> Font Style Text Decoration Font Size Font Weight | Page Text | Style used for text in flow and summary pages. |

| Code | Configurable Elements | Style Class | Description |
|------|---|-------------------------|---|
| | <ul style="list-style-type: none"> • Color | | |
| 171 | Text Configuration <ul style="list-style-type: none"> • Font Style • Text Decoration • Font Size • Font Weight • Color | Page List Element Title | Style used for list element titles in flow pages. |
| 172 | Text Configuration <ul style="list-style-type: none"> • Font Style • Text Decoration • Font Size • Font Weight • Color | Page List Header | Style used for list headers in flow pages. |
| 173 | Text Configuration <ul style="list-style-type: none"> • Font Style • Text Decoration • Font Size • Font Weight • Color | Summary Section Title | Style used for section titles in summary pages. |
| 174 | Text Configuration <ul style="list-style-type: none"> • Font Style • Text Decoration • Font Size • Font Weight • Color | Page Subtitle | Style used for subtitles in flow and summary pages. |
| 175 | Text Configuration <ul style="list-style-type: none"> • Font Style • Text Decoration • Font Size • Font Weight • Color | Page Title | Style used for titles in flow and summary pages. |
| 176 | Text Configuration <ul style="list-style-type: none"> • Font Style • Text Decoration • Font Size • Font Weight • Color | Warning Text | Style used for text in warning message boxes. |

| Code | Configurable Elements | Style Class | Description |
|------|---|-----------------------|--|
| 177 | Text Configuration <ul style="list-style-type: none"> Font Style Text Decoration Font Size Font Weight Color | Flow Step | Style used for flow steps in the progress bar on flow pages. |
| 178 | Text Configuration <ul style="list-style-type: none"> Color | Flow Progress Bar | Style used for the progress bar in flow pages. |
| 179 | Text Configuration <ul style="list-style-type: none"> Font Style Text Decoration Font Size Font Weight Color | Job Information | Style used for job information in flow pages. |
| 180 | Text Configuration <ul style="list-style-type: none"> Font Style Text Decoration Font Size Font Weight Color | Job Posting Date | Style used for job posting dates in job list and job description pages. |
| 181 | Text Configuration <ul style="list-style-type: none"> Font Style Text Decoration Font Size Font Weight Color | Referral Bonus Amount | Style used for referral bonus amounts in job list and job description pages. |
| 182 | Text Configuration <ul style="list-style-type: none"> Color Font Weight Font Style Font Size Text Decoration | Job Type | Style used for job types in job list and job description pages. |
| 183 | Text Configuration <ul style="list-style-type: none"> Color Font Weight Text Decoration Font Style | List Label | Style used for labels in list pages. |

| Code | Configurable Elements | Style Class | Description |
|------|---|--------------------|---|
| | <ul style="list-style-type: none"> Font Size | | |
| 184 | Text Configuration <ul style="list-style-type: none"> Font Size Font Weight Font Style Color Text Decoration | List Text | Style used for text entries in list pages. |
| 185 | Text Configuration <ul style="list-style-type: none"> Color Font Style Text Decoration Font Size Font Weight | List Subtitle | Style used for list subtitles in list pages. |
| 186 | Text Configuration <ul style="list-style-type: none"> Font Size Font Weight Font Style Text Decoration Color | Search Group Label | Style used for field labels in search groups of the search pages. |
| 187 | Text Configuration <ul style="list-style-type: none"> Text Decoration Font Size Font Style Font Weight Color | Search Label | Style used for labels in the search pages. |
| 188 | Text Configuration <ul style="list-style-type: none"> Color Font Weight Font Size Font Style Text Decoration | Search Text | Style used for text in the search pages. |
| 189 | Text Configuration <ul style="list-style-type: none"> Font Style Color Font Size Font Weight Text Decoration | Search Subtitle | Style used for subtitles in the search pages. |

| Code | Configurable Elements | Style Class | Description |
|------|---|-----------------|---|
| 190 | Text Configuration <ul style="list-style-type: none"> • Color • Text Decoration • Font Size • Font Style • Font Weight | Legend Text | Style used for the icon legend text and title in the help panel. |
| 191 | Text Configuration <ul style="list-style-type: none"> • Font Style • Color • Font Size • Font Weight • Text Decoration | Legend Title | Style used for the icon legend title in the help panel. |
| 192 | Text Configuration <ul style="list-style-type: none"> • Color • Text Decoration • Font Size • Font Style • Font Weight | Help Text | Style used for text in the help panel. |
| 193 | Text Configuration <ul style="list-style-type: none"> • Font Style • Color • Font Size • Font Weight • Text Decoration | Help Subtitle | Style used for subtitles in the help panel. |
| 194 | Text Configuration <ul style="list-style-type: none"> • Font Size • Text Decoration • Color • Font Style • Font Weight | Help Title | Style used for titles in the help panel. |
| 195 | Text Configuration <ul style="list-style-type: none"> • Font Style • Color • Font Size • Font Weight • Text Decoration | Header Username | Style used for the username in the header. |
| 196 | Text Configuration | Text | Style used for text entries. Modifying this style can affect all other text entry styles. |

| Code | Configurable Elements | Style Class | Description |
|------|---|--------------------------------|---|
| | <ul style="list-style-type: none"> • Font Size • Text Decoration • Color • Font Style • Font Weight | | |
| 197 | Text Configuration <ul style="list-style-type: none"> • Font Weight • Color • Font Size • Font Style • Text Decoration | Label | Style used for labels. Modifying this style can affect all other label styles. |
| 198 | Text Configuration <ul style="list-style-type: none"> • Text Decoration • Color • Font Size • Font Weight | Subtitle | Style used for subtitles. Modifying this style can affect all other subtitle styles. |
| 199 | Text Configuration <ul style="list-style-type: none"> • Font Family • Font Size | General Font | Font used in all career section pages. |
| 284 | Link Configuration <ul style="list-style-type: none"> • Text Decoration • Font Size • Color • Font Weight • Font Style • Background Color | Button Link (Mouse over event) | Style used for tooltips related to button links that appear in the Shift Availability grid. |
| 285 | Link Configuration <ul style="list-style-type: none"> • Text Decoration • Font Size • Color • Font Weight • Font Style | Button Link | Style used for links that appear in the Shift Availability grid. |
| 286 | Link Configuration <ul style="list-style-type: none"> • Text Decoration • Font Size • Color • Font Weight | Date Selector Link | Link style used for date selectors. |

| Code | Configurable Elements | Style Class | Description |
|------|---|-------------------------------|---|
| | <ul style="list-style-type: none"> Font Style | | |
| 287 | Link Configuration <ul style="list-style-type: none"> Text Decoration Font Size Color Font Weight Font Style Background Color | Small Link (Mouse over event) | Style used for tooltips related to links that appear in the progression bar and in the suggestive input fields. |
| 288 | Link Configuration <ul style="list-style-type: none"> Text Decoration Font Size Color Font Weight Font Style | Small Link | Style used for links that appear in the progression bar. |
| 289 | Link Configuration <ul style="list-style-type: none"> Text Decoration Font Size Color Font Weight Font Style Background Color | Help Link (Mouse over event) | Style used for tooltips related to links that appear in the help panel. |
| 290 | Link Configuration <ul style="list-style-type: none"> Text Decoration Font Size Color Font Weight Font Style | Help Link | Style used for links that appear in the help panel. For example, Access my profile. |
| 291 | Link Configuration <ul style="list-style-type: none"> Text Decoration Font Size Color Font Weight Font Style | Pager Disabled Link | Style used for disabled links in the pager component. |
| 292 | Link Configuration <ul style="list-style-type: none"> Text Decoration Font Size Color | Title Link (Mouse over event) | Style used for tooltips related to links used for job titles. |

| Code | Configurable Elements | Style Class | Description |
|------|---|---|---|
| | <ul style="list-style-type: none"> Font Weight Font Style Background Color | | |
| 293 | Link Configuration <ul style="list-style-type: none"> Text Decoration Font Size Color Font Weight Font Style | Title Link | Style used for links in job title. |
| 294 | Link Configuration <ul style="list-style-type: none"> Text Decoration Font Size Color Font Weight Font Style Background Color | Action Link (Mouse over event) | Style used for tooltips related to links that appear in the Job Field, Location and Organization sections of a career section page. |
| 295 | Link Configuration <ul style="list-style-type: none"> Text Decoration Font Size Color Font Weight Font Style | Action Link | Style used for links that appear in the Job Field, Location and Organization sections of a career section page. For example, Add Job Field, Add Location, Add Organization. |
| 296 | Link Configuration <ul style="list-style-type: none"> Text Decoration Font Size Color Font Weight Font Style Background Color | Regular Link (Mouse over event) | Style used for tooltips related to links that appear in the central section of a career section page. |
| 297 | Link Configuration <ul style="list-style-type: none"> Text Decoration Font Size Color Font Weight Font Style | Regular Link | Style used for links that appear in the central section of a career section page. For example, Save this Search, Hide Search Criteria, Apply, Add to My Job Cart. |
| 298 | Link Configuration <ul style="list-style-type: none"> Text Decoration | Header and Footer Link (Mouse over event) | Style used for tooltips related to links that appear in the header and footer of a career section page. |

| Code | Configurable Elements | Style Class | Description |
|------|---|---|--|
| | <ul style="list-style-type: none"> Font Size Color Font Weight Font Style Background Color | | |
| 299 | Link Configuration <ul style="list-style-type: none"> Text Decoration Font Size Color Font Weight Font Style | Header and Footer Link | Style used for links that appear in the header and footer of a career section page. For example, My Account Options, My Job Cart, Sign In. |
| 1062 | Link Configuration <ul style="list-style-type: none"> Text Decoration Font Style Color Font Weight Font Size | Faceted Search - Title Link | Style used for job titles in faceted search. |
| 1063 | Link Configuration <ul style="list-style-type: none"> Text Decoration Font Style Color Font Weight Font Size Background Color | Faceted Search - Title Link (Mouse over event) | Style used for mouse over events on job titles in faceted search. |
| 1064 | Link Configuration <ul style="list-style-type: none"> Text Decoration Font Style Color Font Weight Font Size | Faceted Search - Search Modal Link | Style used for links which reveal the organization, location, and job field selector in faceted search. |
| 1065 | Link Configuration <ul style="list-style-type: none"> Text Decoration Font Style Color Font Weight Font Size Background Color | Faceted Search - Search Modal Link (Mouse over event) | Style used for mouse over events on links which reveal the organization, location, and job field selector in faceted search. |

| Code | Configurable Elements | Style Class | Description |
|------|---|--|---|
| 1066 | Link Configuration <ul style="list-style-type: none"> • Text Decoration • Font Style • Color • Font Weight • Font Size | Faceted Search - Expand
Facet Link | Style used for links which reveal more selections on facets. |
| 1067 | Link Configuration <ul style="list-style-type: none"> • Text Decoration • Font Style • Color • Font Weight • Font Size • Background Color | Faceted Search - Expand
Facet Link (Mouse over event) | Style used for mouse over events on links which reveal more selections on facets. |
| 397 | Input and Button Control Configuration <ul style="list-style-type: none"> • Black Bag • White Bag • Black Basket • White Basket • Black Cart • White Cart | Job Cart Icon | Style used for the job cart icon. |
| 398 | Input and Button Control Configuration <ul style="list-style-type: none"> • Font Size • Color • Font Size • Background Color • Font Weight | Button | Style used for buttons. |
| 399 | Input and Button Control Configuration <ul style="list-style-type: none"> • Font Size • Font Weight • Color • Background Color • Font Style | Input Control | Style used for text boxes, text areas, combo boxes, etc. |

9 General Configuration

Career Section URL

When a Career Section is created, a URL is automatically generated for the Career Section. When candidates access the Career Section of an organization, they are taken to the URL created for the Career Section.

System administrators can choose the page that is displayed when candidates access the Career Section; the default page is the Basic Search page.

Note: The URL cannot be identical to an existing URL, and it cannot contain the word "admin". Multi-byte characters in Oracle Taleo Enterprise Edition Career Section URLs are not supported.

System administrators can provide:

- an alternate job list URL, i.e. when candidates are in a Career Section, the alternate job list URL provides a point of return to the Job List when candidates click Exit, Return to Job, email URL, or Forgot Password.
- an alternate candidate profile URL i.e. when candidates click on one of the profile URLs, the alternate profile URL provides an alternate profile link. This redirects candidates to any other URL of the standard profiler flow.

The above two options are available in the *Career Section properties*.

System administrators can create additional Career Section URLs that can later be added to different areas of the Career Section or to email correspondence. For example, rather than have candidates start from the job search page, they could be directed to the portal and log in to the My Submissions page. A specific Career Section URL could be created for this purpose. When a URL is created for a Career Section, only part of the URL is displayed in the URL column of the Career Section URL list, this portion must be added to the domain name of the organization to obtain a complete URL.

System administrators can embed a source ID, a media ID, or an event ID to the URL; therefore when candidates apply for a job, the right source, or media or event is automatically selected.

URL and Source ID: Put the "src=" parameter plus a source ID in the URL. For example: `https://abc.taleo.net/careersection/5/jobdetail.ftl?lang=en&job=51380&src=JB-10088`. By doing that, the right source is automatically selected when a candidate applies for a job. This feature is available for any valid sources. For a list of sources, consult the Sources feature in the Recruiting Administration module.

URL and Media ID: Put the "src=" parameter plus a media ID in the URL. This parameter can only be used for eQuest.

URL and Event ID: Put the "src=" parameter plus an event ID in the URL. For example: `http://v750dev.qa.rsft.net/careersection/2/jobapply.ftl?job=7397&src=EV-001`. By doing that, the right event is automatically selected when a candidate applies for a job. It provides you the ability to track which events, banners or online campaigns are attracting the most candidates to your organization career section. Note that event IDs must be valid and active and they must have been activated in the Sources feature of the Recruiting Administration module. Event IDs are case sensitive. For example, ev-001 and EV-001 are two distinct Event IDs.

Parameters can be manually added to a URL to direct candidates to a specific Career Section or to filter what is displayed on the page. For example:

- to have candidates land on a French page, add `&art_servlet_language=fr`
- to have the Career Section visible for internal candidates only, add `&csNo=1`
- to display only urgent jobs in the job list page, add `&u=1`

Note: As mentioned earlier in this section, multi-byte characters in Oracle Taleo Enterprise Edition Career Section URLs are not supported.

URL considerations for standard career sections using only Advanced search and linked to a mobile career section

Career Section administrators create career section URLs for a variety of reasons (Configuration > Career Section Administration > Career Section URLs).

The special situation involves standard career sections for which:

- the Advanced search page is enabled and
- the Basic and Faceted search pages are disabled and
- a mobile career section is linked to the standard career section.

In such a situation, it is important to configure any URL for the Advanced search in the standard career section such that the URL ends with "jobsearch.ftl". E.g. `http://customerzone/careersection/careersectioncode/jobsearch.ftl`. This might seem odd given that "jobsearch.ftl" points to the Basic search or Faceted search (both disabled on the standard career section) but this configuration works well in practice. Because the Basic search and Faceted search are disabled, visitors to the standard career section are redirected automatically to the URL ending with "moresearch.ftl" and the Advanced search page. Because of "jobsearch.ftl" (pointing to Basic search or Faceted search) in the standard career section URL and because the Faceted search page is enabled for mobile career sections, mobile device users are automatically redirected to the mobile career section and the Faceted search page.

When system administrators use the Preview functionality of the Career Section, the system automatically creates a candidate in the Career Section with the login information of the system administrator. The system administrator is then logged in to the Career Section directly using this candidate's account. All changes made in the preview page are also made in the actual Career Section. The data the system administrator creates in the Career Section is saved under this candidate's name. This data can later be accessed in the Recruiting Center and deleted.

Creating an Additional URL for a Career Section

Before you start

The *Access the Career Section administration section* user type permission grants users access to this feature.

Career Section does not need to be deactivated.

Configuration > [Career Section] Administration > Career Section URLs

Here's what to do

1. Click **Create**.
2. Enter a code.

The code must be unique. The URL code must not include multi-byte characters. This is because the code forms part of the URL and multi-byte characters in Oracle Taleo Enterprise Edition Career Section URLs are not supported.

3. Select a default language.
4. Select a career section.
5. Select the default page that will be displayed when accessing the career section.
6. Specify the URL parameters of the page where candidates will land.
7. Click Save.

Results:

The URL is available to be used in the selected Career Section.

Adding a URL in a Career Section

Before you start

The *Access the Career Section administration section* user type permission grants users access to this feature.

Career section must have Inactive or Draft status.

Configuration > [Career Section] Administration > Career Sections

Here's what to do

1. Click the name of a Career Section.
2. Click Add URL next to Career Section URL.
3. Enter a code.

The code must be unique. The URL code must not include multi-byte characters. This is because the code forms part of the URL and multi-byte characters in Oracle Taleo Enterprise Edition Career Section URLs are not supported.

4. Select a default language.
5. Select the default page that will be displayed when accessing the career section.
6. Specify the URL parameters of the page where candidates will land.
7. Click Save.

Results:

The new URL is now available to be used in the Career Section.

Deleting a URL in a Career Section

Before you start

The *Access the Career Section administration section* user type permission grants users access to this feature.

Configuration > [Career Section] Administration > Career Sections

Here's what to do

1. Click the name of a Career Section.
2. Click Show next to Career Section URL.
3. Click Delete.

Results:

The URL is no longer available to be used in a Career Section.

Adding a URL to a Career Section Field

Before you start

The *Access the Career Section administration section* user type permission grants users access to this feature.

The HTML editor must be supported for the field.

Configuration > [Career Section] Administration > Career Sections

Here's what to do

1. Create an additional URL for a Career Section.
2. Copy the partial URL displayed in the URL column of the Career Section URL list.
3. Preview the Career Section.
4. Paste the partial URL copied at step 2 after the desired zone URL.
 - o Example
 - o Partial URL: /cp1/profile.ftl?lang=en
 - o Career Section URL: http://v750sp1.qa.rsft.net/careersection2/jobsearch.ftl?lang=en
 - o Complete URL to use: http://v750sp1.qa.rsft.net/careersection2/cp1/profile.ftl?lang=en
5. You need the resource identification number of the field. You can look at the list of IDs in *the appendix* or you can display the resource identifiers associated to the field.
6. Access the career portal page when the field is located.
7. Locate the ID you wish to modify. You can refine the list by resource number.
8. Click on the resource.
9. Click Edit next to Properties.
10. In the Override field, click the link icon.
11. Paste the URL in the URL field
12. Click OK.

Adding a Source, Event or Media to the Job Application Flow

Before you start

The system administrator must know the ID of the source, the event, or the media. The ID must be valid and active.

Event IDs are case sensitive.

Media ID can only be used for eQuest.

The URL must be created for the career section.

Here's what to do

1. Add `&src=` to the URL.
2. Add the ID of the event, the media or the source after `src=`.

Results:

The right source, media, or event is automatically selected when a candidate applies for a job. If a customer has a source id and an event id that are the same and are both active, the source id will be selected over the event id.

Personalized Job List Matching Criteria

The Personalized Job List - Matching Criteria feature enables system administrators to set the criteria that determine when a match is to be made between a job and a candidate. Only jobs that meet all specified criteria are displayed in the Career Section Jobs Matching My Profile page.

To efficiently match jobs to qualified candidates, system administrators can select matching criteria that improves the quality of their results. Matching is done by comparing answers provided by candidates to criteria specified in the requisition by the recruiter or the hiring manager. Because the matching criteria are global settings, they apply to all Career Sections in your organization.

| Matching Criteria |
|--|
| Structure |
| A match exists between the "Job" specified in the requisition and the candidate's "Preferred Jobs" |
| A match exists between the "Locations" specified in the requisition and the candidate's "Preferred Locations" |
| A match exists between the "Organization" specified in the requisition and the candidate's "Preferred Organizations" |
| A match exists between the "Locations" specified in the requisition and the candidate's "Place of Residence" |
| Competencies |
| A match exists between the competencies specified in the requisition and the competencies of the candidate (based on competencies marked as required) |
| A match exists between the competencies specified in the requisition and the competencies of the candidate (based on competencies marked as required AND competencies marked as asset) |
| Questions |
| A match exists between the questions specified in the requisition and the candidate answers (Based on answers marked as required) |
| A match exists between the questions specified in the requisition and the candidate answers (Based on answers marked as required AND answers marked as asset) |
| Basic Profile |
| Job Level |
| Job Type |
| Schedule |
| Shift |
| Employee Status |
| Education Level |

| Matching Criteria |
|-----------------------|
| Travel |
| Minimum Annual Salary |

Basic Profile, Competencies and Questions criteria are considered as wildcards. If these criteria are not selected as Required in the requisition, or if a candidate does not enter answers for these criteria, the answers are still considered. The candidate is matched if he/she matches all the other required criteria.

For some criteria, three values are possible:

- **Required:** the criterion is mandatory. The candidate must meet this specific criterion to be considered. Candidates who meet all the Required criteria are automatically matched to the selected requisition and appear in the Matching Candidate List in the Recruiting Center.
- **Desired:** the criterion is not mandatory and is considered as an asset. If a candidate does not match a Desired criterion, he/she is not rejected. Candidates who meet all the Required criteria and who also meet some Desired criteria appear at the top of the Matching Candidate List in the Recruiting Center. Desired criteria are considered as a plus.
- **Not Required:** the criterion is not considered.

Taleo recommends to not make competencies and questions required because candidates might not answer these questions and therefore the candidates are excluded.

Selecting Criteria to Match a Candidate to a Job

Before you start

The *Access the Career Section administration* section user type permission grants users access to this feature.

Configuration > [Career Section] Administration > Personalized Job List

Here's what to do

1. Click **Edit**.
2. Make selections.
3. Click **Save**.

Results:

The matching criteria are applied to all Career Sections in your organization.

Requisition Status

On the My Submissions page, the display of the job status can be configured to display whether submissions are still being accepted.

On the My Referrals page, the display of the job status can be configured to display whether candidates are still being accepted.

| Requisition Status | Default Label displayed in the Career section |
|--------------------|---|
| Active | Accepting Job Submissions |
| Inactive | No Longer Accepting Job Submissions |

The requisition status can indicate the status of the requisition in the Recruiting Center.

| Requisition Status | Default Label displayed in the Career section |
|--------------------|---|
| Canceled | Closed |
| On Hold | On Hold |
| Filled | Filled |
| Open | Accepting Job Submissions |

The labels of requisition statuses displayed in the My Submission page and My referrals page can be customized. Default labels are supplied for all requisition types and types of user (agent, internal or external candidates, referrer or all types of users). System administrators can create a specific label for a specific combination of user and type of requisition. When a requisition status is customized for a specific usage, the customized status is applied to all Career Sections and to all staffing types. If no user-defined requisition status is created then the default value is displayed. Only one status can be configured for a given combination of requisition type and user.

Creating a User-defined Requisition Status

Before you start

The *Access the Career Section administration section* user type permission grants users access to this feature.

The requisition status display type must be set to Requisition Status.

Configuration > [Career Section] Administration > Requisition Statuses

Here's what to do

1. Click the name of a requisition status.
2. Click Create.
3. Enter a code and a name.
4. Click Save.

Results:

When the combination of a requisition type and user in a Career Section matches the combination of the user-defined requisition status, the requisition status created for the user-defined requisition status is used instead of the default value.

Activating a User-defined Requisition Status

Before you start

The *Access the Career Section administration section* user type permission grants users access to this feature.

Configuration > [Career Section] Administration > Requisition Statuses

Here's what to do

1. Click the name of a requisition status.
2. Click the name of a user-defined requisition status.
3. Click Activate.

Results:

When the combination of a requisition type and type of user being used in the Career Section matches the combination of the user-defined requisition status, the label created for the user-defined requisition status is used instead of the default value.

Deactivating a User-defined Requisition Status

Before you start

The *Access the Career Section administration section* user type permission grants users access to this feature.

Configuration > [Career Section] Administration > Requisition Statuses

Here's what to do

1. Click the name of a requisition status.
2. Click the name of a user-defined requisition status.
3. Click Deactivate.

Results:

The label of the requisition status created for the user-defined requisition status is no longer used when the combination of a requisition type and user matches the combination of the user-defined requisition status. The default value for the requisition status is used.

Deleting a User-defined Requisition Status

Before you start

The *Access the Career Section administration section* user type permission grants users access to this feature.

Configuration > [Career Section] Administration > Requisition Statuses

Here's what to do

1. Click the name of a requisition status.
2. Click the name of a user-defined requisition status.

3. Click Delete next to the name of a user-defined requisition status.
4. Confirm the deletion.

Results:

The label specified for the combination of requisition type and user is no longer used, the default value is used.

Defining a Usage for a Requisition Status

Before you start

The *Access the Career Section administration section* user type permission grants users access to this feature.

Configuration > [Career Section] Administration > Requisition Statuses

Here's what to do

1. Click the name of a requisition status.
2. Click the name of a user-defined requisition status.
3. Click Create next to Statuses usage.
4. Click Create.
5. Select a requisition type and a user type.
6. Click Save.

Results:

When the combination of a requisition type and user in a Career Section matches the combination of the user-defined requisition status, the requisition status created for the user-defined requisition status is used instead of the default value.

Deleting a Usage for a Requisition Status

Before you start

The *Access the Career Section administration section* user type permission grants users access to this feature.

Configuration > [Career Section] Administration > Requisition Statuses

Here's what to do

1. Click the name of a requisition status.
2. Click the name of a user-defined requisition status.
3. Click Delete next to a status.
4. Confirm the deletion.

Results:

The combination of a requisition type and user is no longer matched to the combination of the user-defined requisition status, the default value is used.

Changing the Label of a User-defined Requisition Status

Before you start

The *Access the Career Section administration section* user type permission grants users access to this feature.

Configuration > [Career Section] Administration > Requisition Statuses

Here's what to do

1. Click the name of a requisition status.
2. Click the name of a requisition status.
3. Click Edit next to Properties.
4. Change the text in the Name field.
5. Click Save.

Results:

The new name of the user-defined requisition status is displayed in the My Submissions and the My Referrals pages.

Selecting the Requisition Status Display Type

Before you start

The *Access the Career Section administration section* user type permission grants users access to this feature.

Configuration > [Career Section] Administration > Requisition Statuses

Here's what to do

1. Click Edit.
2. Select the Display Type.
3. Click Save.

Results:

The requisition status is displayed in the selected format for all Career Sections and all staffing types.

Selecting a Usage for a Requisition Status

Before you start

The *Access the Career Section administration section* user type permission grants users access to this feature.

Configuration > [Career Section] Administration > Requisition Statuses

Here's what to do

1. Click the name of a requisition status.
2. Click the name of a user-defined requisition status.
3. Click Create next to Statuses usage.

4. Click Create.
5. Make selections.
6. Click Save.

Results:

When the combination of a requisition type and user matches the combination of the user-defined requisition status, the requisition status created for the user-defined requisition status is used instead of the default value.

Job Submission Status

Job Submission Status is a feature that allows candidates to be informed of where they are in the hiring process because they can view the status associated to their job applications.

The Job Submission Statuses feature allows system administrators to display the status of job submissions in the My Submissions page and the My Referrals page of a Career Section. The Job Submission Statuses feature is part of the Candidate Communication Agent module. The Candidate Communication Agent options must be activated for each Career Section otherwise the job submission statuses are not displayed in the My Submissions or the My Referrals pages.

System administrator can choose the display type of the job submission status:

- If the Default Configuration is selected, the Taleo Default values are used in the Career Section to display the job submission status.
- If the Customized Configuration is selected, the custom values are displayed when the usage context of the status matches the context of the candidate selection workflow.

Default job submission statuses are available to all organizations:

- Draft indicates that a candidate has not completed his/her job application.
- Complete indicates that a candidate has completed his/her job application.
- Withdraw indicates that a candidate has withdrawn his/her job application.

Labels are created for a specific step of a candidate selection workflow. When creating a job submission status, system administrators can choose to use the default value of a job submission status or a customized version for a specific step of a candidate selection workflow. System administrators can customize the job submission status for all the possible steps that can be added to a candidate selection workflow in the Recruiting Center. System administrators can add a more detailed description that the candidate can view on the customized job submission status.

For example, for the 1st interview step, the system administrator has customized the label of the job submission status when all types of candidates are applying on a professional type of requisition. When a candidate applying on a Professional type of requisition reaches the 1st Interview step, the customized job submission status label is displayed in the My Submissions or My Referrals pages of the candidate in the Career Section. In Recruiting, recruiters and managers can view the candidate status in the candidate file header. This allows recruiters to know what the candidate is being told about the position via the Career Section.

Configuration

| Setting | | | |
|---|---|---------------|---|
| Name | Possible Values | Default Value | Location |
| Enable Customization of Job Submission Statuses | <ul style="list-style-type: none"> No Yes | No | Configuration > [Career Section] Administration > Career Section Settings |

Creating a User-defined Job Submission Status for a Step

Before you start

The *Access the Career Section administration section* user type permission grants users access to this feature.

The *Enable Customization of Job Submission Statuses* setting allows the activation of this feature.

Display type must be Custom Configuration.

Configuration > [Career Section] Administration > Job Submission Statuses

Here's what to do

1. Click the name of a status.
2. Click **Create**.
3. Complete the fields.
4. Click Save.

Results:

The text in the Name field is the customized job submission status and the Description field displays the additional information the candidate can view on the job submission status.

What to do next

Selecting a usage for the new status.

Deleting a User-defined Job Submission Status from a Step

Before you start

The *Access the Career Section administration section* user type permission grants users access to this feature.

The *Enable Customization of Job Submission Statuses* setting allows the activation of this feature.

Display type must be Custom Configuration.

User-defined Job Submission Status must be Inactive.

Configuration > [Career Section] Administration > Job Submission Statuses

Here's what to do

1. Select a Workflow Statuses Usage
2. Click Delete next to the name of a User-defined Job submission Status.

Results:

The default status is used if no user-defined Job submission Status is defined.

Selecting the Display Type of the Job Submission Status

Before you start

The *Access the Career Section administration section* user type permission grants users access to this feature.

The *Enable Customization of Job Submission Statuses* setting allows the activation of this feature.

Configuration > [Career Section] Administration > Job Submission Statuses

Here's what to do

1. Click Edit.
2. Select the display type.
3. Click Save.

Results:

If Default Configuration was selected, the Taleo Default values are used in the Career Section to display the job submission status.

If Customized Configuration was selected, the custom values are displayed when the usage context of the status matches the context of the candidate selection workflow.

Defining a Usage for a Job Submission Status

Before you start

The *Access the Career Section administration section* user type permission grants users access to this feature.

The *Enable Customization of Job Submission Statuses* setting allows the activation of this feature.

Job submission status display type must be Custom Configuration.

User-defined Job Submission Status must be created.

Configuration > [Career Section] Administration > Job Submission Statuses

Here's what to do

1. Click a Workflow Statuses Usage status.
2. Click the name of a user-defined Job Submission Statuses.
3. Click Create.
4. Select a requisition and user type.
5. Click Save.

6. Click Activate next to the user-defined Job Submission title, if necessary.
If Deactivate is displayed next to the title, then the user-defined Job Submission Status is already activated.

Results:

The usage is activated, and the new label is displayed when a step is used in the specified context.

Activating a User-defined Job Submission Status for a Step

Before you start

The *Access the Career Section administration section* user type permission grants users access to this feature.

The *Enable Customization of Job Submission Statuses* setting allows the activation of this feature.

Configuration > [Career Section] Administration > Job Submission Statuses

Here's what to do

1. Click the name of a Workflow Statuses Usage status.
2. Click the name of a User-defined Job submission Status.
3. Click Activate.

Results:

The user-defined Job submission Status is available for use.

Deactivating a User-defined Job Submission Status for a Step

Before you start

The *Access the Career Section administration section* user type permission grants users access to this feature.

The *Enable Customization of Job Submission Statuses* setting allows the activation of this feature.

Configuration > [Career Section] Administration > Job Submission Statuses

Here's what to do

1. Click the name of a Workflow Statuses Usage status.
2. Click the name of a User-defined Job submission Status.
3. Click Deactivate.

Results:

The user defined status is longer be available for use.

Activating the Candidate Communication Agent

Before you start

The *Access the Career Section administration section* user type permission grants users access to this feature.

The *Enable Customization of Job Submission Statuses* setting allows the activation of this feature.

Career Section must be inactive.

Configuration > [Career Section] Administration > Career Section

Here's what to do

1. Click Edit next to Properties.
2. Select Yes from the *Display user-defined job submission statuses in the My Submissions page and in the My Referrals page* drop down menu.
3. Click Save.

Results:

User-defined job submission statuses are displayed in the My Submissions and the My Referrals pages of the Career Section.

Deactivating the Candidate Communication Agent

Before you start

The *Access the Career Section administration section* user type permission grants users access to this feature.

The *Enable Customization of Job Submission Statuses* setting allows the activation of this feature.

Career Section must be inactive.

Configuration > [Career Section] Administration > Career Section

Here's what to do

1. Click Edit next to Properties.
2. Select No from the *Display user-defined job submission statuses in the My Submissions page and in the My Referrals page* drop down menu,
3. Click Save.

Results:

User-defined job submission statuses are no longer displayed in the My Submissions and the My Referrals page of the Career Section.

Changing the Description of a Job Submission Status

Before you start

The *Access the Career Section administration section* user type permission grants users access to this feature.

The *Enable Customization of Job Submission Statuses* setting allows the activation of this feature.

Job submission status display type must be Custom Configuration.

Configuration > [Career Section] Administration > Job Submission Statuses

Here's what to do

1. Click the name of a Status.
2. Click the name of a user-defined Job Submission Statuses.
3. Click Edit.
4. Change the text in the Description field.
5. Click Save.

Results:

The new description is displayed next time a step is used in the specified context.

Changing the Label of a Job Submission Status

Before you start

The *Access the Career Section administration section* user type permission grants users access to this feature.

The *Enable Customization of Job Submission Statuses* setting allows the activation of this feature.

Job submission status display type must be Custom Configuration.

Configuration > [Career Section] Administration > Job Submission Statuses

Here's what to do

1. Click the name of a Status.
2. Click the name of a user-defined Job Submission Statuses.
3. Click Edit.
4. Change the text of the Name field.
5. Click Save.

Results:

The new label is displayed next time a step is used in the specified context.

Deleting a Usage for a Job Submission Status

Before you start

The *Access the Career Section administration section* user type permission grants users access to this feature.

The *Enable Customization of Job Submission Statuses* setting allows the activation of this feature.

Job submission status must be inactive or Draft.

Configuration > [Career Section] Administration > Job Submission Statuses

Here's what to do

1. Click the name of a Workflow Statuses Usage.
2. Click the name of a user-defined Job Submission Status.
3. Click Delete next to a usage.
4. Click Yes to confirm Deletion.

Results:

The default value is used if no status is set for a specific usage.

Exporting Job Submission Statuses Through Integration

Customers can get the appropriate customer-defined job submission statuses for candidate submissions, exported through integration.

In the Taleo Career Section product, it is possible to configure job submission statuses to describe the current progression state of a candidate submission. These job submission statuses are displayed to external candidates, internal candidates, referrers or agents.

An entity hierarchy is available in the Recruiting integration offering: "ApplicationStatusesByContext". The entities in this hierarchy are available for export through TCC, TCB and Web services.

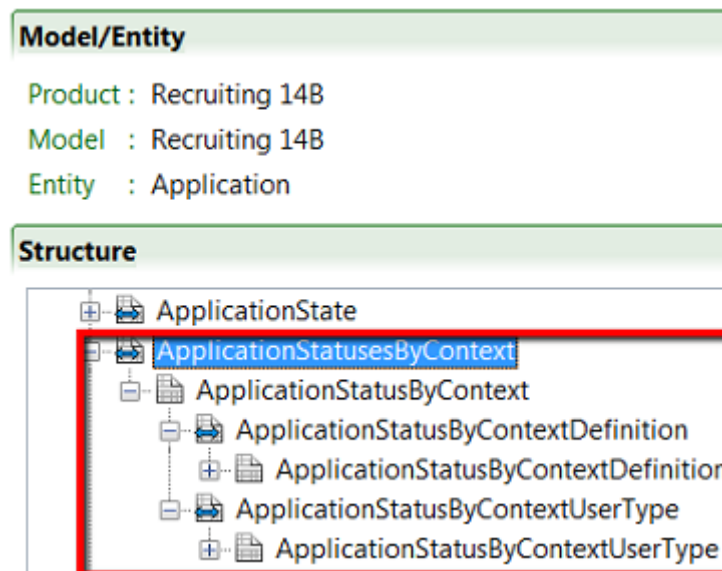

Below is a description of these entities.

ApplicationStatusesByContext

- Collection of items (ApplicationStatusByContext).
- Child entity of the Application entity.

ApplicationStatusbyContext

- Represents a job submission status for one type of user (external candidates, internal candidates, referrers, agents).
- Describes a status defined by the customer or one of the default statuses provided by Taleo (depending on if a customized status for this context has been configured).

- Parent entity for ApplicationStatusByContextDefinition and ApplicationStatusByContextUserType.

ApplicationStatusByContextDefinition

- Contains the name and description of a specific status.
- Contains the following fields:
 - Name: Name of the returned status. This name does not take into consideration customer-specific customizations that may have been done on the name of the Taleo default statuses (customizations done through support requests).
 - CustomizedName: Same as "Name" but takes into consideration customer-specific customizations that may have been done on the name of the Taleo default statuses (customizations done through support requests). If no customizations have been made on the Taleo default statuses, it contains the same value as the "Name" field.
 - Description: Description of the returned status (description provided by the administrator). The text from this field is in rich text format and can include links, images, bold text, etc.

ApplicationStatusByContextUserType

- Identifies the type of user (external candidates, internal candidates, referrers, agents) for which a status is targeted.
- Contains the following fields:
 - Description: Description of the type of user to which this status applies. Possible values: External Candidate, Internal Candidate, Referrer, Agent.
 - Number: Number representing the type of user to which this status applies. Possible values: 1 (External Candidate), 2 (Internal Candidate), 3 (Referrer), 4 (Agent).

Below is a sample output.

```
<e:Application>
  <e:ApplicationStatusesByContext>
    <e:ApplicationStatusByContext>
      <e:ApplicationStatusByContextDefinition>
        <e:ApplicationStatusByContextDefinition>
          <e:Code>under_review</e:Code>
          <e:Name>
            <e:value locale="en">Under review</e:value>
          </e:Name>
          <e:CustomizedName>
            <e:value locale="en">Under review</e:value>
          </e:CustomizedName>
          <e:Description>
            <e:value locale="en">Your submission is currently <strong>under review</strong></e:value>
          </e:Description>
        </e:ApplicationStatusByContextDefinition>
      </e:ApplicationStatusByContextDefinition>
      <e:ApplicationStatusByContextUserType>
        <e:ApplicationStatusByContextUserType>
          <e:Description>
            <e:value locale="en">External Candidate</e:value>
          </e:Description>
        </e:ApplicationStatusByContextUserType>
      </e:ApplicationStatusByContextUserType>
    </e:ApplicationStatusByContext>
  </e:ApplicationStatusesByContext>
</e:Application>
```

Important Information

When exporting field values from the ApplicationStatusByContextDefinition entity, if different locale (language) filterings are applied to the fields from this entity, the output may not contain the locales that were requested. To avoid this situation, make sure to set the same locale filtering on all multilingual fields from the ApplicationStatusByContextDefinition entity.

The order in which the four possible statuses (ApplicationStatusbyContext) are returned in the export output will not always be the same if running the same export query multiple times. For example, when using the export output, do not rely on the external candidate status to be returned first. Always validate the user type for which a status applies to.

It is recommended to always use the CustomizedName field value of the ApplicationStatusByContextDefinition entity instead of the Name field value. If no customer-specific customizations have been done on the names of the Taleo default statuses, both fields will have the same value. If customizations have been made, only CustomizedName will take those customizations into consideration. The only reason to use the Name field would be if you want the standard Taleo default statuses, ignoring customizations made to the text for those default statuses.

Matched Candidate Display

The Matched Candidate Display feature allows system administrators to specify if jobs manually matched to candidates in the Recruiting Center are displayed in the candidate's Career Section My Submissions page.

System administrators can choose to *display jobs manually matched* to candidates in the My submissions page based on the type of candidate:

- Internal candidates
- External candidate
- Candidate referred
- Candidates matched by an agent

Matched jobs can be displayed for one, several or all types of candidates.

System administrators can choose *if and when matched jobs are to be displayed* in the My Submissions page of the candidate:

- Never (default value)
- Always
- Yes, when candidate reaches one of the selected steps.

Displaying matched jobs in the My Submissions page to candidates should be done at a significant step; avoid displaying these jobs too early in the process. If display matched jobs on a selected step is being used, be sure that the selected step is used in the application flow associated with the Career Section. If the step is not used in the application flow the candidate is not able to view the matched job.

A candidate does not absolutely have to reach the selected step in order for the matched jobs to be displayed. If the recruiter/manager advances a candidate past the step selected for the Matched Candidate Display feature, the job is displayed to the candidate.

Selecting if Matched Jobs are Displayed

Before you start

The *Access the Career Section administration section* user type permission grants users access to this feature.

Configuration > [Career Section] Administration > Matched Candidate Display

Here's what to do

1. Select a type of user.
2. Click Edit next to Properties
3. Select a display type.
4. Click Save.

Hiding Matched Jobs in the My Submissions Page

Before you start

The *Access the Career Section administration section* user type permission grants users access to this feature.

Configuration > [Career Section] Administration > Matched Candidate Display

Here's what to do

1. Click the name of a type of user.
2. Click Edit.

3. Select Never from the Display type drop down list.
4. Click Save.

Results:

When a candidate is manually matched to a requisition, the job no longer appears in the My submissions page of the candidate and remove the ones that were previously displayed.

Selecting a Step triggering the Display of a Matched Job

Before you start

The *Access the Career Section administration section* user type permission grants users access to this feature.

Display Type must be Yes, when candidate reaches one of the selected steps.

Configuration > [Career Section] Administration > Matched Candidate Display

Here's what to do

1. Click the name of a type of user.
2. Click Add.
3. Select a Step.
4. Click Select.

Results:

When the candidate reaches the step of the candidate selection work flow, matched jobs are displayed in My submissions page of the candidate.

Removing a Step Triggering the Display of Matched Jobs

Before you start

The *Access the Career Section administration section* user type permission grants users access to this feature.

Display Type must be Yes, when candidate reaches one of the selected steps.

Configuration > [Career Section] Administration > Matched Candidate Display

Here's what to do

1. Click the name of a type of user.
2. Click Delete.
3. Select Yes to confirm the deletion.
4. Click Select.

Results:

When the candidate reaches the step of the candidate selection work flow, matched jobs are no longer displayed in My submissions page of the candidate.

Agent Confirmation Request

The system can be configured to send a request to the agent to confirm a candidate's availability.

This feature is normally used for contingent hiring. When deciding to contract with a specific contingent worker, the system can be configured to send a request to the agent owning the candidate record of the contingent worker to confirm the candidate's availability. The agent receives an email and is brought back to the portal. This feedback loop in the contingent process is configured by the system administrator via the Agent Confirmation Request feature.

An agent confirmation request can be created for all available candidate selection application flows used in a career section or the system administrator can chose to create an agent confirmation request for only one or several specific candidate selection application flows. The agent confirmation request can be added to any status of a step of a candidate selection application flow. The system administrator can also decide the status the candidate automatically reaches based on the answer sent by the agent. Yes the candidate is available, or no the candidate is unavailable. The email sent to the agents requesting a confirmation, contains the text included in the Agent Confirmation Question (multilingual).

If an agent confirmation request is created, a translation must be provided for all available languages.

Configuration

| User Type Permission Name | Location |
|---|--|
| Access Correspondence Manager configuration | Configuration > [SmartOrg] Administration > User Types > Recruiting > Administration |

Creating an Agent Confirmation Request

Before you start

The *Access the Career Section administration section* user type permission grants users access to this feature.

Configuration > [Career Section] Administration > Agent Confirmation Requests

Here's what to do

1. Click **Create**.
2. Complete the form.
3. Click **Save**.

Results:

When an agent owned candidate reaches the specified status of the step for the selected candidate selection work flow, an email is sent to the agent requesting the confirmation of the availability of the candidate.

Deleting an Agent Confirmation Request

Before you start

The *Access the Career Section administration section* user type permission grants users access to this feature.

Configuration > [Career Section] Administration > Agent Confirmation Requests

Here's what to do

1. Click Delete next to a Confirmation Request.
2. Confirm the deletion.

Results:

When an agent owned candidate reaches the specified status of the step for the selected candidate selection work flow, an email is no longer sent to the agent requesting the confirmation of the availability of the candidate.

Editing the Properties of an Agent Confirmation Request

Before you start

The *Access the Career Section administration section* user type permission grants users access to this feature.

Configuration > [Career Section] Administration > Agent Confirmation Requests

Here's what to do

1. Click the code of an Agent Confirmation Request.
2. Click **Edit**.
3. Make changes.
4. Click **Save**.

Results:

When an agent owned candidate reaches the specified status of the step for the selected candidate selection workflow, an email is sent to the agent requesting the confirmation of the availability of the candidate.

Secure Message Delivery with the Message Center

Customers who wish to have increased control over the information sent to Career Section users via email may choose to enable the Secure Message Delivery feature. When enabled, all messages are delivered to a secure Message Center accessible from any of the customer's Career Sections. Message recipients are directed to the Message Center to retrieve their messages.

The Secure Message Delivery feature is enabled in the Recruiting Administration. See the *Recruiting Configuration Guide* for configuration options.

The Secure Message Delivery feature applies only to messages sent to Career Section users, that is candidates, agents, and referrers. It does not impact Recruiting Center users or messages sent with other Taleo products.

If a message is sent via email (whether it is an automated message or the sender selected to send it via email), rather than receiving the actual message via email the message recipient receives a notification of message delivery containing a deeplink. To receive a notification of message delivery, message recipients must have a valid email address on file and the notification template message must be active.

Note: All messages sent to a single email address will be accessible from any Secure Message Center that is linked to that email. This may cause candidates to see one another's message content, just as though they were receiving messages via a shared inbox. If this is not desired, then the Email Uniqueness setting should be changed (Configuration > [Recruiting] Settings).

To access the Message Center, the message recipient clicks on the deeplink in the message and must then authenticate himself by entering his user name and password. If the user does not yet have an account, he must create one prior to being able to access his messages. Alternatively, the Message Center can be directly accessed via any active Career Section by clicking the My Messages tab.

Once in the Message Center, the message recipient can read his messages, delete them, and download the files attached to the messages in order to view them. Before accessing an attachment, the recipient must accept a download agreement. Messages are displayed in a print friendly format should Career Section users wish to print a message using the browser's print functionality.

When viewing a specific message, the recipient can navigate from one message to the next without returning to the list view by using the Previous or Next links. The message may also be deleted. Clicking Back returns the user to the message list.

For Career Section users who do not have an email address, the message sender can still send them messages and these users can access their messages from within the Message Center. For example, a candidate exists in the system and did not supply an email address. A recruiter will still be able to send an email message to the candidate using the Recruiting Center correspondence wizard.

The Message Center

The Message Center has the same look and feel as the Career Section; it adopts the theme and branding of the Career Section. Messages inside the Message Center retain the formatting attributes of the message template.

The Message Center language matches the language from where the Message Center was originally accessed. If the user is coming from a Career Section, the Message Center is presented in the same language as the Career Section. If coming from the deeplink contained in the notification, the Message Center is presented in the same language as the notification sent to the user. Messages inside the Message Center are in the language used to transmit the message.

Help text is displayed in the right-hand side of the Message Center. Default universal help text, which can be edited via TexTool, is provided by Taleo. If desired, the text can be customized by a Career Section administrator using the Career Portal Page user-defined labels feature. This text change only affects the Message Center on that particular Career Section.

The Message Center stores messages sent within the past 6 months to a maximum of 100 messages. If more than 100 messages have been delivered, only the most recent 100 messages are accessible.

Messages that do not have a subject cannot be opened from the Message Center.

Keyword Search

Candidates can use the search functionality to find jobs via the Basic Search and the Advanced Search pages of a Career Section.

When using the search function to perform a basic search on the Basic Search page or an advanced search on the Advanced Search page, candidates can enter partial words composed of the first two or more characters or 1 character + 1 special character (eg. C+) in the Keywords field. Using partial words in the Keywords field, candidates can create search strategies that usually retrieve more jobs than similar searches that include only complete words. Candidates can enter multiple partial and complete words in the Keywords field. This offers candidates more possibilities in creating search strategies.

The accepted special characters are # + - @ . ! % /

Reserved words such as AND and OR will be removed from the search terms.

Words encased in quotes will be considered one search term by the system.

The search engine treats each search term in the Keywords field as if it ends with a wildcard, whether the term is a complete word or not.

The search engine does not, however, apply a wildcard to the beginning of search terms. The search engine searches the following fields for terms entered in the Keywords field:

- Job Title
- Job Description
- Primary Location
- Qualifications

Help Panel

The Help panel displays helpful information to the candidate.

When a theme is created 200 pixels are reserved for the Help Panel, and it displays by default. The help panel can be displayed in career portal pages and application flow pages. The system administrator can configure, via different features, the following elements:

- pixel size of the help panel
- the text appearing in the help panel
- font of the text in the help panel.

The size of the help panel, and whether it is displayed or not, is set for the entire Career Section. Text and formatting can be set for each page of the career portal and for the application flow, independently. It is important to note that the Career Section automatically adjusts to fit the amount of given space. However, the content, text and fonts do not automatically adjust. If there is no default help text in the help panel, the width of the page is not constrained to what is

not taken up by the help panel resource. However, when text is added in the help panel, including a single blank space, the page uses the help panel resource area.

The text of the help panel that is, the Help Title, the Help Subtitle and the Help Text, can be formatted by the system administrator via the Theme feature.

If the help panel is removed (that is, entering 0 pixels), the following links available in the help panel have to be placed in another location: Access my profile, Submit a friend's profile, Refer a Friend.

Hiding the Help Panel

Before you start

The *Access the Career Section administration section* user type permission grants users access to this feature.

User must know the theme associated to the Career Section.

The theme must be inactive.

Configuration > [Career Section] Administration > Themes

Here's what to do

1. Click the name of a theme.
2. Click Edit.
3. In the Width in pixel reserved for the Online Help in Theme field, enter 0.
4. Click Save.

Results:

The help panel is no longer displayed.

What to do next

Activating the theme.

Changing the Width of the Help Panel

Before you start

The *Access the Career Section administration section* user type permission grants users access to this feature.

User must know the theme associated to the Career Section.

The theme must be inactive.

Configuration > [Career Section] Administration > Themes

Here's what to do

1. Click the name of a theme.
2. Click Edit.
3. In the *Width in pixel reserved for the Online Help* in Theme field, enter a value. It is a best practice to keep the help panel between 100 and 200px.
4. Click Save.

Results:

The help panel is displayed in the specified width in every area of the Career Section. If the width is set to 0px the help panel is not shown.

What to do next

Activate the theme.

Changing the Help Panel Text in a Career Portal Page

Before you start

The *Access the Career Section administration section* user type permission grants users access to this feature.

Configuration > [Career Section] Administration > Career Section > Career Section name

Here's what to do

1. Click Show next to Career Portal Page.
2. Click the name of a career portal page.
3. Click Edit User-defined Labels.
4. Select HelpPanelResources from the Refine by list.
5. Click the element to change.
6. Click Edit.
7. Add text to the override box.
8. Click Save.

Results:

The new text appears in the help panel.

What to do next

Activate the theme.

Changing the Help Panel Text in the Application Flow

Before you start

The *Access the Career Section administration section* user type permission grants users access to this feature.

Configuration > [Career Section] Administration > Application Flows

Here's what to do

1. Click the name of an application flow.
2. Click Edit User-defined Labels.
3. Select HelpPanelResources from the Refine by list.
4. Click the element to change.
5. Click Edit.

6. Add text to the override box.
7. Click Save.

Results:

The new text appears in the help panel in the selected application flow.

Formatting Help Panel Text

Before you start

The *Access the Career Section administration section* user type permission grants users access to this feature.

Configuration > [Career Section] Administration > Themes

Here's what to do

1. Click a Theme.
2. Click Text Configuration.
3. Click the name of a Help style class.
4. Click a Style name.
5. Click Edit next to Properties.
6. Change the value.
7. Click Save.

Results:

The new format is applied in the Help panel.

Apply as Guest

Allows candidates to easily enter the application flow by entering only their email. Candidates are encouraged to create credentials after completing their application so that they are able to later access their account. An Apply as Guest button is available on the login page for job applications and general profile submissions. Apply as Guest is only available on the vertical layout of the authentication pages.

Apply as Guest is intended to be used a single time during a candidate's first visit, however, there are three possible paths and results when candidates select Apply as Guest:

- First time guest user – email does not exist

A new candidate is created, their email saved and they land on the first page of the application flow. When they complete their application and land on the Thank You page, the Career Section detects that this candidate does not have a personalized user name and password and they are presented with a link to create these credentials. If they choose to do this, security questions display (if configured) and they are returned to the job search. If these first time guest users either do not reach the Thank You page or choose not to create credentials, they are sent an email with an access code to set up their credentials.

This flow is similar to the Apply with LinkedIn experience.

- Returning guest user – does not have a user name and password
A guest user returns to the Career Section and attempts to use Apply as Guest again and also never set up a user name and password in their first visit. They are invited to send themselves a new copy of the email with the access code that will allow them to create these credentials and recover their account.
- Returning user – already has a user name and password
This candidate's email is recognized and is required to sign in. If they do not remember their user name and password, they are able to use the Forgot User Name/Forgot Password if needed.

The available values in the configuration setting, Allow new users to register in the system, are:

- With Username
- With Username and as Guest
- No

This configuration is available on both external and internal career sections on a per career section basis.

Single Sign-On

Single Sign-On

Single Sign-On (SSO) enables users to log into Oracle Taleo Enterprise Edition applications using their corporate credentials.

In an SSO environment, users are authenticated by an Identity Provider (e.g. OIF, ADFS) that is maintained by their corporate IT department. Both employees and candidates who have access to internal career sections can use SSO to access Oracle Taleo Enterprise Edition products. SSO cannot be used for external career sections.

Customers who want to use SSO can implement it themselves through the SSO configuration interface. Customers perform easy configuration steps to enable and support one or more identity providers. The feature supports two flows to authenticate users:

- Users are authenticated through their company portal, then they access Oracle Taleo Enterprise Edition products through the portal (Identity Provider initiated flow).
- Users access the Oracle Taleo Enterprise Edition product URL directly and are redirected to their identity provider for authentication (Service Provider initiated flow).

Customers can configure the authentication request flows, and exit and error URLs for seamless integration with their environment.

SSO setup requires:

- An Identity Provider with SAML 2.0 support.
- A user/candidate synchronization feed between the Identity Provider and Oracle Taleo Enterprise Edition. This can be developed using Taleo Connect Client (TCC).
- A corporate portal (optional).

Information technology professionals (system administrators, implementation consultants, etc.) who are planning on integrating Oracle Taleo Enterprise Edition with their corporate Single Sign-On (SSO) system should be familiar with:

- Oracle Taleo Enterprise Edition
- SAML 2.0 based SSO
- SSO Identity Provider (IdP) setup
- Taleo Connect Client (TCC)

SSO is only available for new customers or current customers who do not have an SSO setup in their zone. The SSO configuration screens are unavailable to customers who already have an SSO setup in place.

Single Sign-On Basic Concepts

Identity Provider (IdP) and Service Provider

Single Sign-On (SSO) in Oracle Taleo Enterprise Edition is accomplished through the use of SAML (version 2.0). SAML provides a mechanism to exchange authentication and authorization data between two trusting entities.

In a generic SAML context, the entities are:

- The Asserting party (or SAML authority)
- The Relying party (or SAML requester)

In an SSO context, the Asserting party is the Identity Provider (IdP) and the Relying party is the Service Provider (SP). The Identity Provider is the customer's SAML federation server (OIF, ADFS etc.) and the Service Provider is the Oracle Taleo Enterprise Edition application.

A trust relationship is established between the Identity Provider and the Service Provider. The Service Provider trusts the information received from the Identity Provider. The information sent is called the SAML assertion. It contains the identity of the user that has been authenticated by the IdP. Upon receiving the assertion, Oracle grants the appropriate level of access to resources, based on the identity of the user.

Metadata File

SSO is set up by exchanging metadata files between the Identity Provider (IdP) and the Service Provider (SP).

The SAML 2.0 metadata file format is supported. This metadata file contains information about each SSO entity (URLs, protocols supported, certificates etc.). The IdP's metadata file can be imported into the SSO user interface. If any changes are made to the IdP, the metadata file must be re-imported.

Also, metadata files can be generated for the Oracle Taleo Enterprise Edition Service Providers (SmartOrg and Career Section). These files must be imported into the IdP. A separate metadata file will be generated for each SP-IdP combination. For example, if the customer has 2 IdPs, then up to 4 metadata files will be generated (2 for SmartOrg and 2 for Career section).

For an example of an Identity Provider metadata file, see [Identity Provider Metadata Example](#).

For an example of a SmartOrg metadata file, see [SmartOrg Metadata Example](#).

For an example of a career section Service Provider metadata file, see [Career Section Metadata Example](#).

Single Sign-On Flows

There are two types of Single Sign-On flows: Identity Provider (IdP)-initiated and Service Provider (SP)-initiated.

Identity Provider (IdP)-initiated Flow

In the IdP-initiated flow, the user logs in first to the IdP. The person then requests access to the Service Provider (SmartOrg or career section) – often through an SSO Portal. The Identity Provider will initiate an SSO connection to the Oracle Taleo Enterprise Edition product and provide an assertion. The assertion contains the identity, attributes and entitlements of the requesting user. Oracle will grant access to the user based on the assertion information.

The image represents an Identity Provider (IdP)-initiated flow.

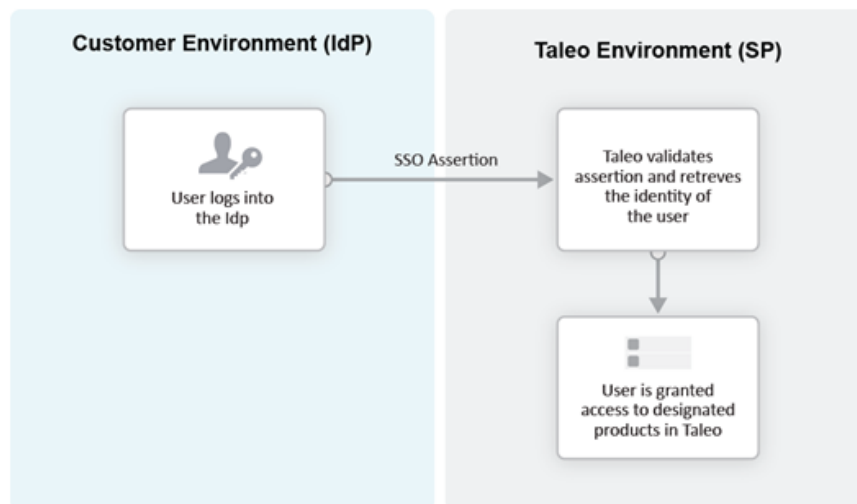

The IdP-initiated flow is the most commonly used configuration.

When SSO is configured, the IdP-initiated flow is activated by default.

Multiple IdPs are supported for IdP-initiated flows. Each IdP can redirect users to the Service Provider (SmartOrg and career section). The Service Provider accepts request from each IdP as long as the IdP is properly defined.

Service Provider (SP)-initiated Flow

In the Service Provider-initiated flow, the user accesses the Oracle Taleo Enterprise Edition product (SP) directly. For example, this can be done by typing the URL of the zone in the browser. The Service Provider then redirects the user to the Identity Provider. After authenticating the user, the IdP generates and sends an assertion back to the SP. The assertion contains the identity, attributes and entitlements of the requesting user. Oracle grants access to the user based on the assertion information.

The Challenge URL setting, depicted in the following illustration, is used to set up a Service Provider-initiated flow.

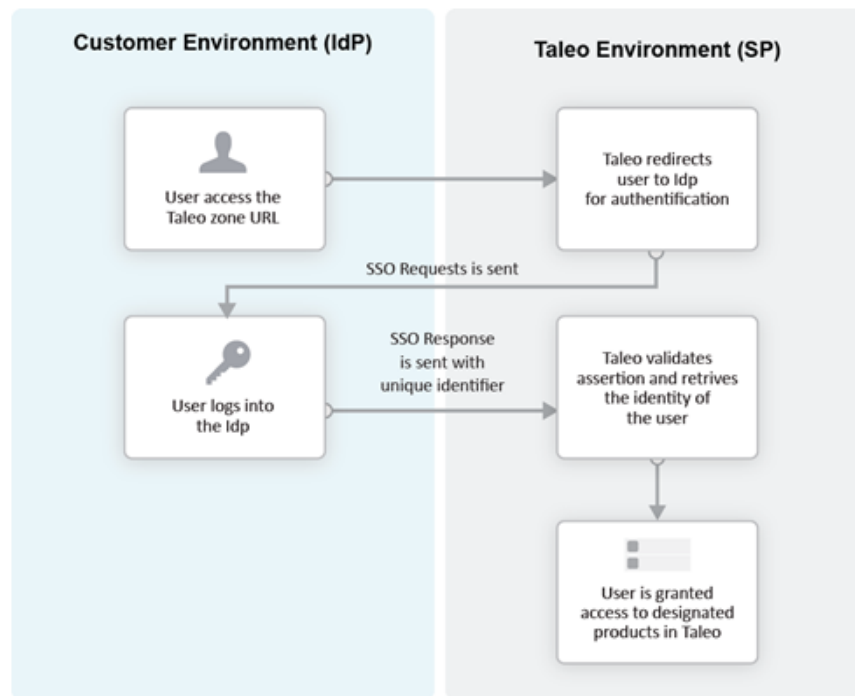

The customer can choose to optionally activate SP-initiated flow as well.

For SP-initiated flow from SmartOrg, only one IdP can be configured. All SP-initiated requests from SmartOrg are redirected to this IdP.

For SP-initiated flow from career sections, by default all requests are redirected to a single default IdP. However, individual career sections can be set up to redirect requests to a different IdP.

The following illustration depicts a single Identity Provider, SmartOrg and single career section:

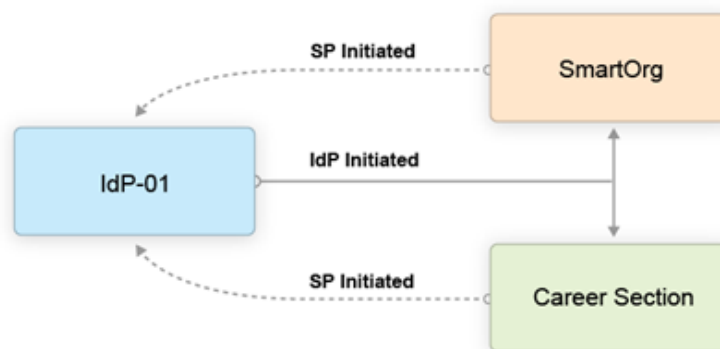

- Users can access both SmartOrg and the career section from the Idp (IdP-initiated flows).
- When users access SmartOrg directly, they are redirected to the IdP for authentication (SP-initiated flows).

- When users access the career section directly, they are redirected to the IdP for authentication (SP-initiated flows).

Note: This is the most commonly used configuration.

The following illustration depicts an SSO setup with two Identity Providers, SmartOrg and three career sections:

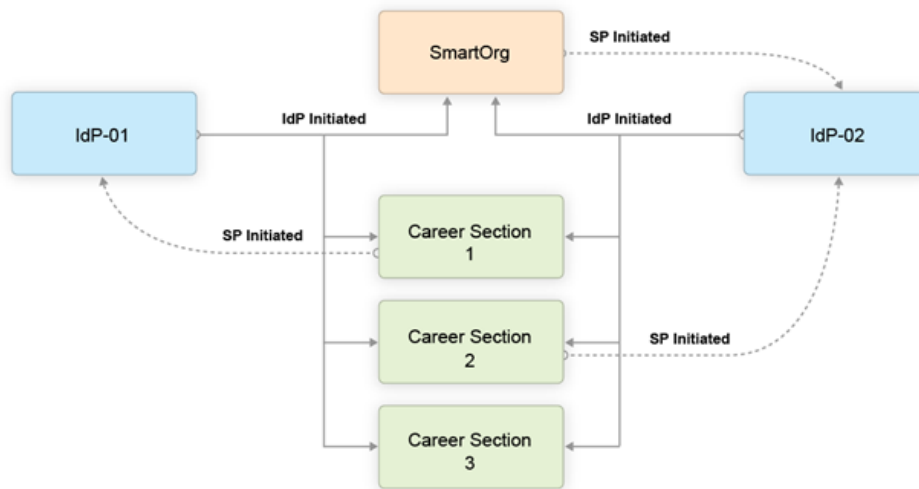

- Users can access both SmartOrg and each career section from the Idp-01 (IdP-initiated flows).
- Users can access both SmartOrg and each career section from the Idp-02 (IdP-initiated flows).
- When users access SmartOrg directly, they are redirected to the IdP-02 for authentication (SP-initiated flows).
- When users access career section 1 directly, they are redirected to the IdP-01 for authentication (SP-initiated flows).
- When users access career section 2 directly, they are redirected to the IdP-02 for authentication (SP-initiated flows).
- When users access career section 3 directly, they are not redirected to any IdPs. Instead, they are prompted for their credentials.

Note: This configuration is very rare.

Challenge, Error and Exit URLs

Challenge, Error and Exit URLs can be defined to configure the destination to which the user will be redirected under various conditions.

One set of URLs can be configured for each SP (SmartOrg and career section). In addition, individual career sections can have their own values for these URLs. These values will override the defaults for the career section SP.

Challenge URL

The Challenge URL setting defines the page where the user will be directed to present his credentials. There are two options:

- Default login page: Standard Oracle Taleo Enterprise Edition page. No redirection to the IdP.
- SP Initiated Servlet redirect: The user is redirected to the IdP's login page. This option must be selected to enable SP initiated flows from SmartOrg and career section to the chosen IdP.

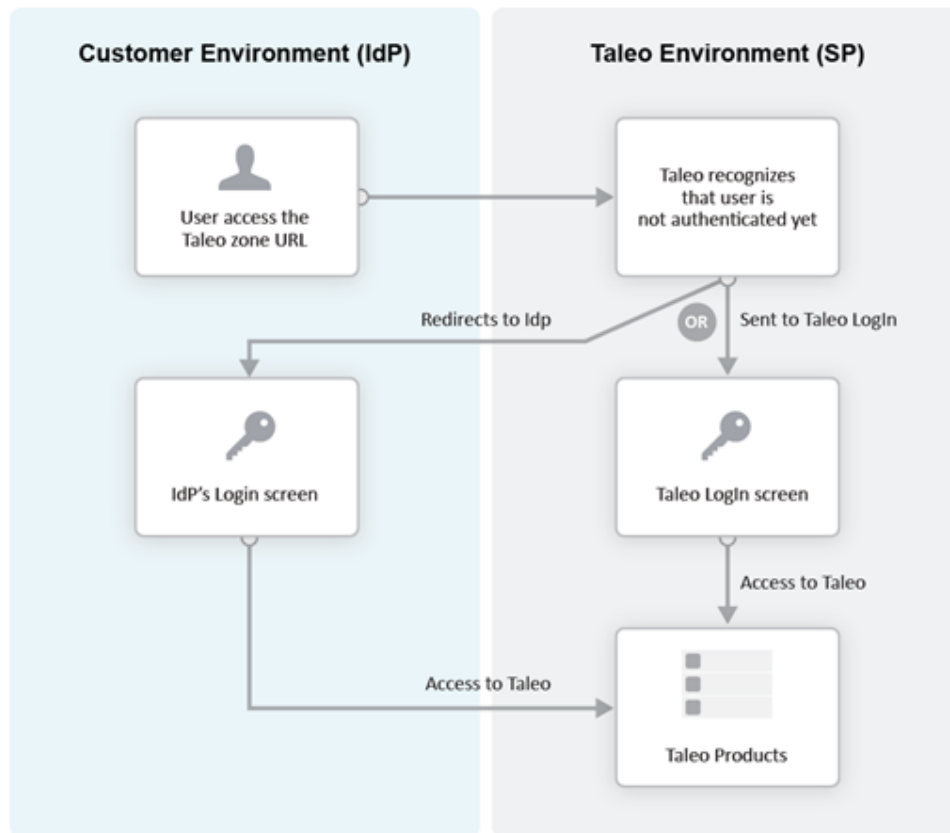

Error URL

The Error URL setting defines the page where the user will be directed when an SSO error occurs. It can be the default Oracle Taleo Enterprise Edition error page or a custom page defined by the customer. Typical errors that would generate an SSO error are:

- Locked user account
- Invalid Assertion (generic SSO response issue)

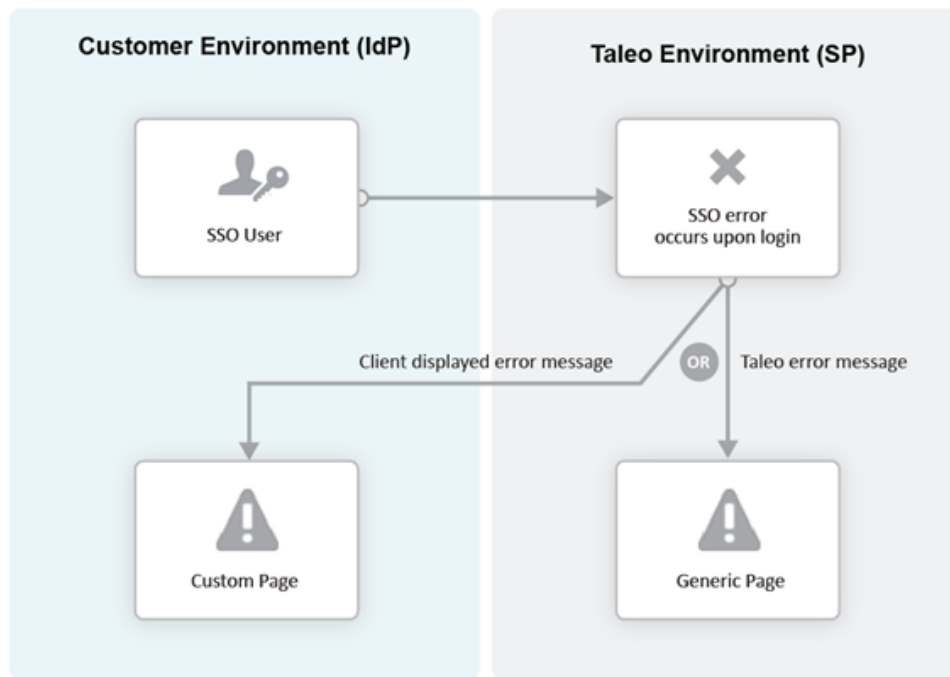

Exit URL

This Exit URL setting defines where the Service Provider sends the user upon exiting the application. Three options are available:

- Default exit page – Display the login screen
- Custom URL – Display a custom page defined by the customer
- No exit page – Display the exit screen

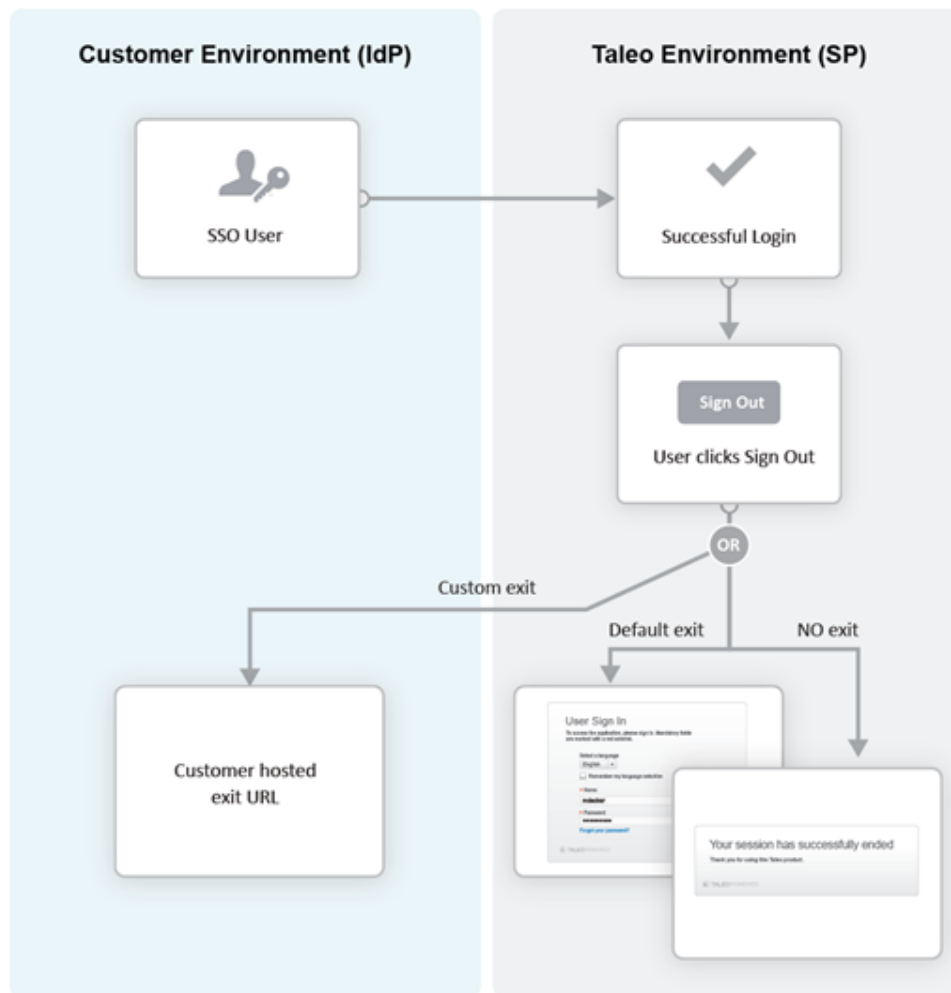

Certificate and Validation

A trust relationship is established between the IdP and the SP when both exchange their respective certificates.

All communications (SAML Request and Response) will be signed by the issuing party. The receiving party will use the certificate to validate the received communication.

IdP Certificates

The IdP's certificate is usually available in its metadata file. The certificate will be automatically imported when the metadata file is imported. After import, this certificate can be viewed and managed in the SSO interface. Certificates can also be manually imported. The certificate can be associated to one or both Service Providers (SmartOrg and career section). Each certificate will have a validity period defined by a start date and an end date.

Multiple certificates can be imported for an IdP. At least one has to be valid for SSO connections to be established.

SP Certificates

The SP certificates are available through SP's metadata file. A separate certificate is generated for each SP-IdP combination.

Validation

Upon receiving an assertion, each Service Provider performs the following validity checks.

- Signature – Validate that the assertion has been signed by the IdP.
- Timeout – Validate that the age of assertion has not exceeded a specified timeout period. The age is calculated as the time difference between the moment the assertion was received (by the SP) and the moment the assertion was issued (by the IdP). A timeout period of up to 30,000 milliseconds can be configured.

User Synchronization

The customer must configure synchronization of users between the Identity Provider(s) and Oracle Taleo Enterprise Edition.

The IdP will identify the user (subject) in the assertion. This user identifier must also be stored in the system. Upon receiving the assertion, Oracle extracts the user identifier from the assertion and then searches for the user in the system. Upon finding a match, the appropriate privileges are granted to this user.

Taleo Connect Client (TCC) can be used to import the user identifier into Oracle Taleo Enterprise Edition. A TCC import file can be created and scheduled for automatic import into Oracle Taleo Enterprise Edition. Both user and candidate information must be updated. The following fields must be updated with the SSO user identifier:

- Employee/Username (for SmartOrg Service Provider)
- Candidate/Credentials/SSOID (for career section Service Provider)

For information about TCC, please refer to the Taleo Connect Client documentation.

Users can also be created manually:

- SmartOrg users: Create the users manually through the SmartOrg interface.
- Internal career sections: Use the career section SSO Configuration Wizard. See [Career Section SSO Configuration Wizard](#).

Identity Provider Bindings

Identity provider bindings specify the IdP URLs that can be used to perform various SAML transactions.

These URLs will be used by the Oracle Taleo Enterprise Edition Service Providers. It is expected that some bindings will be identical. The metadata file provides values for these bindings automatically, however, you can edit the values as needed.

Identity Provider Trusted Certificates

Trusted certificates are needed to confirm the identity of Identity Providers. Each assertion received will be validated against these certificates.

IdP certificates included in the metadata file are imported and displayed automatically. Certificates can also be imported manually in the Identity Provider Trusted Certificates section. Certificates can be chosen to confirm the identity of Identity Providers for SmartOrg, career sections or both. Afterward, each assertion received is validated against the certificates.

Configuring Single Sign-On

Recommended SSO Implementation

Before you start

The Manage SSO configuration user type permission is required. (See: [Granting Permission to Manage Single Sign-On \(SSO\)](#)).

It is recommended that you enable and test IdP initiated flows *before* enabling SP initiated flows. If both IdP and SP initiated flows are enabled at the same time, you run the risk of completely locking out users due to incorrect SSO configuration.

Here's what to do

1. Obtain the metadata file for the corporate Identity Provider from your IT department.
2. Register the Identity Provider in Oracle Taleo Enterprise Edition.
 - a. Decide which Service Providers (SmartOrg, career section or both) must be activated for this IdP.
 - b. Initially activate just IdP initiated flows.
 - c. Set up the exit and error URLs if necessary.
3. Export the Service Provider metadata files from Oracle Taleo Enterprise Edition.
4. Register the Service Providers in the IdP by importing the metadata files.
5. Synchronize SmartOrg SSO user identity (either using TCC or manually).
6. Test IdP initiated access to SmartOrg.
7. Activate SSO in one or more career sections.
8. Synchronize career section SSO identity (either using TCC or the career section SSO wizard).
9. Test IdP initiated access to these career sections.
10. Activate SP initiated flows for the IdP.
11. Test SP initiated access to SmartOrg.
12. Test SP initiated access to career section.

Granting Permission to Manage Single Sign-On

Before you start

Configuration > [SmartOrg] Administration > User Types > (click user type) > Configuration > [Security Management] Edit

Here's what to do

1. Click the check box next to Manage SSO Configuration.
2. Click Save.

Results:

Users who have the user type will be able to configure SSO.

Configuring an Identity Provider

Before you start

The Manage SSO configuration user type permission is required.

Configuration > SSO Configuration

Here's what to do

1. Next to Identity Provider Configuration, click Show.
2. Click Create.
3. SAML 2.0 is the only possible selection. Click Next.
4. In the Automated Identity Provider Information section, perform one of the following steps:
 - a. To upload an IdP metadata file, click Browse..., select the file and then click Upload.
 - b. Type a URL to the IdP metadata file in the corresponding field and click Retrieve.

The Display Name and Entity Id or issuer identity fields are filled automatically.

5. In the Manual Identity Provider Information section, complete the fields as needed.
 - o You can change the display name if you wish.
 - o In the Entity Id or issuer identity field, you can enter the identity of the user who was authenticated by the IdP.
 - o The UserID Type refers to the type of identifying information and currently "Loginname", the login name of the user in the system, is the only type supported so ensure that "Loginname" is the value displayed.
 - o The User ID Attribute Name (XPath value) does not require a value.
6. Click Next.
7. In the Bindings section, complete the fields as needed and click Next.

8. You can add certificates manually (in addition to the certificates imported automatically from the metadata file) by clicking Add.
 - a. To specify that a certificate be used to confirm the identity of Identity Providers for SmartOrg, career sections, or both, click the corresponding radio button.
 - b. Click Browse... and select a certificate file.
 - c. Click Save.
 - d. Click Next.
9. In the Authentication Settings section, you specify whether SAML requests issued by Oracle will be signed, whether the signature of SAML responses received from the IdP will be validated, and the time period (30,000 milliseconds is recommended) beyond which assertions will no longer be considered valid.
It is strongly recommended to have assertions validated (ensure that the Default SAML Signature check box is selected).
 - a. If you want to change the default values, clear the Default SAML Signature check box and make your selections.
 - b. Click Next.
10. In the SmartOrg Configuration section, configure your SmartOrg Service Provider by making your selections. For details regarding these settings, see *SmartOrg Service Provider Settings* and *Challenge, Error and Exit URLs*.
Note: If Default for SP Initiated Flow is set to Yes, it is important to also select Custom Exit Page URL and type a Custom Exit Page URL in the corresponding field or leave the field empty.
11. Click Next.
12. In the Career Section Configuration section, configure your Career Service Provider by making your selections. For details regarding these settings, see *Career Section Service Provider Settings* and *Challenge, Error and Exit URLs*.
13. Click Next.
The information headings are displayed. You can click Edit next to a heading to edit the corresponding information as needed.
14. Click Finish to generate the metadata and certificates for the Service Providers (SmartOrg and Career Section).
If the Service Provider-initiated flow was enabled and the challenge URL was configured, the users will be redirected to the IdP. SSO will fail, however, because the IdP is not yet configured. Because this can create a temporary lockout situation, a direct URL is available to bypass SSO as necessary. See *Bypassing Single Sign-On*.

SmartOrg Service Provider Settings

| Setting | Description |
|-------------------------------|--|
| Default for SP Initiated Flow | <ul style="list-style-type: none"> • Set this value to Yes if you want to enable Service Provider-initiated flow for the SmartOrg Service Provider. • If the value Yes, this IdP will be the default for Service Provider-initiated flows to SmartOrg. All Service Provider-initiated requests to SmartOrg will be redirected to this IdP. • If the value Yes and a different IdP was configured at a prior time, the IdP will no longer be the default for Service Provider-initiated flows. |
| Challenge URL | <ul style="list-style-type: none"> • Select Default Login Page if you want the general login page to be displayed. • Select SP Initiated Servlet redirect if you want to enable Service Provider-initiated flow for the SmartOrg Service Provider. This selection will redirect SmartOrg login requests to the IdP for authentication. |

| Setting | Description |
|-----------------------|---|
| Error URL | <ul style="list-style-type: none"> Your selection will determine whether users are redirected to the default error page or a custom URL whenever an error occurs. If Custom Error Page URL is selected, you must specify a complete URL, e.g. http://exit.corporate.com. |
| Exit URL | <ul style="list-style-type: none"> You can redirect users who quit the application to the default exit page or to a custom URL. If Custom Exit Page URL is selected, you must specify a complete URL, e.g. http://exit.corporate.com. The Custom Exit Page URL field can also have an "empty value". Important - If Server Provider-initiated flow is enabled, type a Custom Exit Page URL or leave the field empty. Do not use the default exit page option. |
| Execute Global Logout | <ul style="list-style-type: none"> Set this setting to Yes. When users log out, all open sessions with the Identity Provider will end. This is the safest way to log out because it closes the connection to the IdP. |

Career Section Service Provider Settings

| Setting | Description |
|-------------------------------|---|
| Default for SP Initiated Flow | <ul style="list-style-type: none"> Set this value to Yes if you want to enable Service Provider-initiated flow for the Career Section Service Provider. If the value is Yes, this IdP will be the default for Service Provider-initiated flows to Career Section. All Service Provider-initiated requests to Career Section will be redirected to this IdP. Note: This IdP can be overridden for individual career sections. See <i>Configuring Career Sections Individually for Service Provider-Initiated Access</i>. If the value Yes and a different IdP was configured at a prior time, the IdP will no longer be the default for Service Provider-initiated flows. |
| Challenge URL | <ul style="list-style-type: none"> Select Default Login Page if you want the general Oracle Taleo Enterprise Edition login page to be displayed. Select SP Initiated Servlet redirect if you want to enable Service Provider-initiated flow for the Career Section Service Provider. This selection will redirect Career Section login requests to the IdP for authentication. |
| Error URL | <ul style="list-style-type: none"> Your selection will determine whether users are redirected to the default error page or a custom URL whenever an error occurs. If Custom Error Page URL is selected, you must specify a complete URL, e.g. http://exit.corporate.com. |
| Exit URL | <ul style="list-style-type: none"> You can redirect users who quit the application to the default exit page or to a custom URL. If Custom Exit Page URL is selected, you must specify a complete URL, e.g. http://exit.corporate.com. The Custom Exit Page URL field can also have an "empty value". Important - If Server Provider-initiated flow is enabled, type a Custom Exit Page URL or leave the field empty. Do not use the default exit page option. |

Exporting SmartOrg Service Provider Metadata Files

Before you start

Here's what to do

To download the metadata file associated with a SmartOrg Service Provider, go to: <https://ZoneName/smartorg/sp/metadata.jss?target=EntityID>, replacing ZoneName by your Oracle Taleo Enterprise Edition zone name, and replacing EntityID by the Entity ID value imported from the IdP metadata file.

The Entity ID value is displayed in the Identity Provider Information section for the Identity Provider.

Registering Service Providers (SmartOrg and Career Section) in the IdP

The metadata files exported in previous steps can be imported into your IdP system (OIF, ADFS etc.). You should set up a single Service Provider for SmartOrg and a single, different Service Provider for Career Section.

See [Configuring Oracle Identity Federation](#) for an example of how to set up Service Providers in Oracle Identity Federation (OIF).

Deleting an Identity Provider

Before you start

The Manage SSO configuration user type permission is required.

Ensure that all SSO flows are disabled before deleting an IdP. The IdP to be deleted should not be the default for any Service Provider-initiated flows.

Configuration > SSO Configuration

Here's what to do

1. Next to Identity Provider Configuration, click Show.
2. Click the Delete that corresponds to the Identity Provider you want to delete.
3. Click Yes.

Adding an IdP Trusted Certificate to an Identity Provider

Before you start

The Manage SSO configuration user type permission is required.

Configuration > SSO Configuration

Here's what to do

1. Next to Identity Provider Configuration, click Show.

2. Click the IdP to which you want to add a trusted certificate.
3. Next to Identity Provider Trusted Certificates, click Edit.
4. Click Add.
5. To indicate what the certificate will be used for, select the appropriate radio button.
The certificate is typically used for both SmartOrg and career sections.
6. Click Browse... and select the certificate file.
7. Click Save.

Deleting an IdP Trusted Certificate from an Identity Provider

Before you start

The Manage SSO configuration user type permission is required.

Configuration > SSO Configuration

Here's what to do

1. Next to Identity Provider Configuration, click Show.
2. Click the IdP you want to remove a trusted certificate from.
3. Next to Identity Provider Trusted Certificates, click Edit.
4. Locate the trusted certificate you want to delete and click the corresponding Delete.
5. Click Yes.
6. Click Save.

Configuring Career Sections Individually for Service Provider-Initiated Access

Before you start

The Manage SSO configuration user type permission is required.

Configuration > SSO Configuration

Here's what to do

1. Next to SP Initiated Access for Career Sections, click Show.
The screen displays the internal career sections enabled for SSO. For each career section associated with a specific IdP, the latter is displayed. If no IdP is displayed, this indicates that the career section users will be redirected to the default service provider.
2. Locate the career section with which you want to associate an IdP and click the corresponding Configure.
3. Select the IdP to which the career section users will be redirected.
The Challenge, Error and Exit URL settings are selected automatically based on the IdP selected. For more information on these settings, see *Career Section Service Provider Settings*. You can change these settings as needed.

Displaying SSO-protected URLs

Before you start

The Manage SSO configuration user type permission is required.

Configuration > SSO Configuration

Here's what to do

Next to SSO Protected URLs, click Show.

System administrators can embed these URLs within their corporate SSO portals.

Bypassing Single Sign-On

1. Copy the following URL and replace the three occurrences of "ZoneURL" with your zone information (e.g. xyz.taleo.net):

```
https://ZoneURL/smartorg/iam/accessmanagement/login.jsf?redirectionURI=https%3A%2F%2FZoneURL%2Fsmartorg%2Fsmartorg%2Fcommon%2Ftoc.jsf%3Flang%3Den&TARGET=https%3A%2F%2FZoneURL%2Fsmartorg%2Fsmartorg%2Fcommon%2Ftoc.jsf%3Flang%3Den
```

2. Paste the edited URL into your Internet browser.

Direct access to Oracle Taleo Enterprise Edition is typically used by system administrators to diagnose SSO configuration issues.

3. Enter your Oracle Taleo Enterprise Edition user name and password (not the IdP credentials).

Results:

You are logged into Oracle Taleo Enterprise Edition directly, bypassing Single Sign-On.

Career Section SSO Configuration Wizard

The Single Sign-On wizard enables internal candidates to link a candidate account to their SSO user identifier.

This method can be used instead of running a Taleo Connect-based integration feed to populate the SSO user identifier in the candidate account.

If the wizard is enabled, the first time that internal candidates log into an internal career section through their Single Sign-On portal, they are prompted to associate their SSO user identifier (profile) with a candidate account. The users can either create a new candidate account or use an existing account. Upon successfully logging in using the candidate account credentials, the SSO user identifier is associated with this candidate account by the Single Sign-On wizard. This operation has to be performed only once. The user will be automatically authenticated in the internal career section for subsequent logins.

Welcome. You are signed in. [Sign Out](#)

[Next](#) [Quit](#)

Welcome to the Candidate Profile Single Log-in Configuration

Please specify a user name and password below. You can use this username and password in the future to access any of the zone1 candidate portals. This username and password can also be used as a backup measure, in case your single log-in service provider is down. We suggest you use the same login information as for your single log-in.

User Identification
Mandatory fields are marked with an asterisk.

*User Name

*Password

[Forgot your user name?](#)
[Forgot your password?](#)

Do you already have a Candidate Profile?

Yes, I have a Candidate Profile and I would like to associate it to my single log-in

No, I don't have a Candidate Profile but I would like to create one now.

[Next](#) [Quit](#)

Identity Provider Metadata Example

This is an example of an IdP metadata file.

```
<dsig:X509SubjectName>CN=adc-fap1067-idm.oracle-demos.com OIF Encryption
  Certificate</dsig:X509SubjectName>
</dsig:X509Data>
</dsig:KeyInfo>
<md:EncryptionMethod Algorithm="http://www.w3.org/2001/04/xmlenc#rsa-1_5" />
<md:EncryptionMethod Algorithm="http://www.w3.org/2001/04/xmlenc#aes128-cbc" />
<md:EncryptionMethod Algorithm="http://www.w3.org/2001/04/xmlenc#aes192-cbc" />
<md:EncryptionMethod Algorithm="http://www.w3.org/2001/04/xmlenc#aes256-cbc" />
<md:EncryptionMethod Algorithm="http://www.w3.org/2001/04/xmlenc#triple-des-cbc" />
</md:KeyDescriptor>
<md:ArtifactResolutionService Binding="urn:oasis:names:tc:SAML:2.0:bindings:SOAP"
  Location="https://adc-fap1067-idm.oracle-demos.com/fed/idp/soap" index="1" isDefault="true" />
<md:SingleLogoutService Binding="urn:oasis:names:tc:SAML:2.0:bindings:HTTP-POST"
  Location="https://adc-fap1067-idm.oracle-demos.com/fed/idp/samlv20" ResponseLocation="https://adc-
fap1067-idm.oracle-demos.com/fed/idp/samlv20" />
<md:SingleLogoutService Binding="urn:oasis:names:tc:SAML:2.0:bindings:HTTP-Redirect"
  Location="https://adc-fap1067-idm.oracle-demos.com/fed/idp/samlv20" ResponseLocation="https://adc-
fap1067-idm.oracle-demos.com/fed/idp/samlv20" />
<md:NameIDFormat>urn:oasis:names:tc:SAML:1.1:nameid-format:emailAddress</md:NameIDFormat>
<md:NameIDFormat>urn:oasis:names:tc:SAML:1.1:nameid-format:unspecified</md:NameIDFormat>
<md:SingleSignOnService Binding="urn:oasis:names:tc:SAML:2.0:bindings:HTTP-POST"
  Location="https://adc-fap1067-idm.oracle-demos.com/fed/idp/samlv20" />
<md:SingleSignOnService Binding="urn:oasis:names:tc:SAML:2.0:bindings:HTTP-Redirect"
  Location="https://adc-fap1067-idm.oracle-demos.com/fed/idp/samlv20" />
</md:IDPSSODescriptor>
</md:EntityDescriptor>
```

SmartOrg Metadata Example

This is an example of a metadata file for SmartOrg.

```
<md:EntityDescriptor entityID="http://z15awlrsv2.hcm.taleocloud.net/smartorg"
  validUntil="2016-05-26T14:54:16.285Z">
  <md:SPSSODescriptor AuthnRequestsSigned="true" WantAssertionsSigned="true"
    protocolSupportEnumeration="urn:oasis:names:tc:SAML:1.1:protocol
    urn:oasis:names:tc:SAML:2.0:protocol">
  <md:KeyDescriptor use="signing">
  <ds:KeyInfo>
  <ds:KeyName>SP SSO Key</ds:KeyName>
  <ds:X509Data>
  <ds:X509Certificate>MIICUzCCAbgAwIBAgIIAyVm2cMLSc8wDQYJKoZIhvcNAQELBQAwPDEbMBkGA1UEChMST3
  JhY2xl IENvcnBvcmlFOaW9uMQ0wCwYDVQQLewRQcm9kMQ4wDAYDVQQDEwVUWYxlbzAeFw0xNTA1MjcxNDU0
  MTZaFw0xNjA1MjYxNDU0MTZaMDwxGzAaZBGNVBAoTEk9yYWNsZSBDb3Jwb3JhdGlvbWJENMAsGA1UE
  CxMEUHVzZDEOZawGA1UEAxMFVGFsZW8wZG9yZG9yZG9yZG9yZG9yZG9yZG9yZG9yZG9yZG9yZG9yZG9y
  P4+4EiAmhAuaLAdSbdpjsnxTbc1tc4zSI+KAEIBSw9aJC3s0AKyVLYJZENLC0qUPzQC+LXndYn
  s+U5TgUpQr3H0jf0GLCvLKfG5oEwshUPLwh/nLG6sdOk9kuMBiCuLUuLskGyKIjtg8N+c19hNQ5q
  cTU90su1NQU/AgMBAAAGjXjBcMFoGCCsGAQUFBwEBBE4wTDBKBma2BgEFBQcwAYY+aHR0cHM6Ly96
  MTVhd2xyc3YyLmhjbS50YWxlb2Nsb3Vklm5ldC9zbWVydG9yZy9vY3NwL3N0YXR1cy5qc3MwDQYJ
  KoZIhvcNAQELBQADgYEAsoMI3SNkrfclmbs80qOe00M5P55v1WGUSUWsYoWLSKgzfeiJWvpPcfigj
  GnrESeI4wpxp/gf8z2xKuCOIhL+Enqz20a1bvZIHARnoXARbukdVcV999YEBx6TVGLmLPOTegSX
  3PMFdYsfCzCQ7bKxE/d2/0rG6JVA44xrcLsiPlw=</ds:X509Certificate>
  <ds:X509IssuerSerial>
  <ds:X509IssuerName>CN=Taleo, OU=Prod, O=Oracle Corporation</ds:X509IssuerName>
  <ds:X509SerialNumber>226700441718311375</ds:X509SerialNumber>
  </ds:X509IssuerSerial>
  </ds:X509Data>
  </ds:KeyInfo>
  </md:KeyDescriptor>
  <md:SingleLogoutService Binding="urn:oasis:names:tc:SAML:2.0:bindings:HTTP-POST"
    Location="https://z15awlrsv2.hcm.taleocloud.net/smartorg/SamlAssertionConsumerService.
    jss"
    ResponseLocation="https://z15awlrsv2.hcm.taleocloud.net/smartorg/iam/accessmanagement/
    globalLogout.jsf?lang=en"/>
  <md:NameIDFormat>urn:oasis:names:tc:SAML:1.1:nameid-format:unspecified</md:NameIDFormat>
  <md:AssertionConsumerService Binding="urn:oasis:names:tc:SAML:2.0:bindings:HTTP-POST"
    Location="https://z15awlrsv2.hcm.taleocloud.net/smartorg/SamlAssertionConsumerService.
    jss" index="0" isDefault="true"/>
  <md:AssertionConsumerService Binding="urn:oasis:names:tc:SAML:1.0:profiles:browser-post"
    Location="https://z15awlrsv2.hcm.taleocloud.net/smartorg/SamlAssertionConsumerService.
    jss" index="1"/>
  <md:AssertionConsumerService Binding="urn:oasis:names:tc:SAML:2.0:bindings:HTTP-Redirect"
    Location="https://z15awlrsv2.hcm.taleocloud.net/smartorg/SamlAssertionConsumerService.
    jss" index="2"/>
  </md:SPSSODescriptor>
  <md:Organization>
  <md:OrganizationName xml:lang="en">Oracle</md:OrganizationName>
  <md:OrganizationDisplayName xml:lang="en">Oracle</md:OrganizationDisplayName>
  <md:OrganizationURL xml:lang="en">http://www.oracle.com</md:OrganizationURL>
  </md:Organization>
  </md:EntityDescriptor>
```

Career Section Metadata Example

This is an example of a metadata file for Career Section.

```
<md:EntityDescriptor entityID="http://z15awlrsv2.hcm.taleocloud.net/careersection"
  validUntil="2016-05-26T14:54:16.000Z">
  <md:SPSSODescriptor AuthnRequestsSigned="true" WantAssertionsSigned="true"
    protocolSupportEnumeration="urn:oasis:names:tc:SAML:1.1:protocol
    urn:oasis:names:tc:SAML:2.0:protocol">
  <md:KeyDescriptor use="signing">
  <ds:KeyInfo>
  <ds:KeyName>SP SSO Key</ds:KeyName>
  <ds:X509Data>
  <ds:X509Certificate>MIICUzCCAbgAwIBAgII TbRCZ z28o2wwDQYJKoZIhvcNAQELBQAwPDEbMBkGA1UEChMST3
  JhY2xl IENvcnBvcnF0aW9uMQ0wCwYDVQQLEwRQcm9kMQ4wDAYDVQQDEwVUYWxlbzAeFw0xNTA1MjcxdDU0
  MTZaFw0xNjA1MjYxNDU0MTZaMDwxGzA ZBGNVBAoTE kryYWNsZSBDb3Jwb3JhdGlvbjENMAsGA1UE
  CxMEUHVJvZDEOMAwGA1UEAxMFVGFSZW8wgZ8wDQYJKoZIhvcNAQEBBQADgY0AMIGJAoGBAI 1YGiXn
  uEicYl19Rfg4Sog2X1JjpzZ4zJq9UVnL4d9KYd+ThfZhNJOOXwafCuFqwo0TXKmroe8Kwv41zPMA
  fuAbFDiKekQoWTy7RAgKUcaRp3nKA6Z3HHEX9ycLqogPzVsb4uwHjimYVYxUd9g6P9wEgt+N4gFv
  xR1VDzI J6RRvAgMBAAGjXjBcMFoGCCsGAQUFBwEBBE4wTDBKBgggRgEFBQcwAAYY+aHR0cHM6Ly96
  MTVhd2xyc3YyLmhhb2S0YXxlbn2Nsb3Vklm51dC9zbWYydG9yZy9vY3NwL3N0YXR1cy5qc3MwDQYJ
  KoZIhvcNAQELBQADgYEAB IijJj gorOW1gJ8j eCEBf1GY9UTbG8h+mpU/ 2A6qPvkf104Brvtounqn
  5Z9WzflUS9kQ4q2exMh5YaUg/eUTgZ2mVucASvx8pl/zBTC94F994wHUAtAlvRn+1AizA6YQTNyH
  g08+YGB1jdjgKsMt7xi/502urZefPk0d4VwynHY=</ds:X509Certificate>
  <ds:X509IssuerSerial>
  <ds:X509IssuerName>CN=Taleo, OU=Prod, O=Oracle Corporation</ds:X509IssuerName>
  <ds:X509SerialNumber>5599173247913206636</ds:X509SerialNumber>
  </ds:X509IssuerSerial>
  </ds:X509Data>
  </ds:KeyInfo>
  </md:KeyDescriptor>
  <md:SingleLogoutService Binding="urn:oasis:names:tc:SAML:2.0:bindings:HTTP-POST"
    Location="https://z15awlrsv2.hcm.taleocloud.net/careersection/SamlAssertionConsumerSer
    vice.jss"
    ResponseLocation="https://z15awlrsv2.hcm.taleocloud.net/careersection/iam/accessmanage
    ment/globalLogout.jsf?lang=en"/>
  <md:NameIDFormat>urn:oasis:names:tc:SAML:1.1:nameid-format:unspecified</md:NameIDFormat>
  <md:AssertionConsumerService Binding="urn:oasis:names:tc:SAML:2.0:bindings:HTTP-POST"
    Location="https://z15awlrsv2.hcm.taleocloud.net/careersection/SamlAssertionConsumerSer
    vice.jss" index="0" isDefault="true"/>
  <md:AssertionConsumerService Binding="urn:oasis:names:tc:SAML:1.0:profiles:browser-post"
    Location="https://z15awlrsv2.hcm.taleocloud.net/careersection/SamlAssertionConsumerSer
    vice.jss" index="1"/>
  <md:AssertionConsumerService Binding="urn:oasis:names:tc:SAML:2.0:bindings:HTTP-Redirect"
    Location="https://z15awlrsv2.hcm.taleocloud.net/careersection/SamlAssertionConsumerSer
    vice.jss" index="2"/>
  </md:SPSSODescriptor>
  <md:Organization>
  <md:OrganizationName xml:lang="en">Oracle</md:OrganizationName>
  <md:OrganizationDisplayName xml:lang="en">Oracle</md:OrganizationDisplayName>
  <md:OrganizationURL xml:lang="en">http://www.oracle.com</md:OrganizationURL>
  </md:Organization>
  </md:EntityDescriptor>
```

Configuring Oracle Identity Federation

Before you start

Here's what to do

1. To register SmartOrg and career sections, begin by logging into Fusion Middleware's Enterprise Manager.

2. Locate the OIF instance and click it.
3. Click Oracle Identity Federation.
4. Click Administration.
5. Click Federation.
6. Click Add.
 - a. Click Choose File.
Do not change the displayed values.
 - b. Browse to the location where the user saved the SmartOrg metadata and upload the metadata to OIF.
 - c. Click OK.
7. Select the federation you created and click Edit.
8. Click the Oracle Identity Federation Settings tab.
9. Click the icon to the left of the Identity Provider/Authority Settings section to display the section.
10. In the Identity Provider/Authority Settings section:
 - a. Set the Default SSO Response Binding to: HTTP POST.
 - b. Select the check box next to Response with Assertion – SOAP.
 - c. Select the check box next to Response with Assertion – HTTP POST.
 - d. Click Apply.

10 Security

Security

Settings

Settings are used to configure features in Oracle Taleo Enterprise Edition products.

There are two types of settings:

- Global settings: Settings that affect multiple Oracle Taleo Enterprise Edition products.
- Product settings: Settings specific to an Oracle Taleo Enterprise Edition product, for example, Recruiting, Career Section, Onboarding (Transitions), Performance, Reporting and Analytics.

| Setting | Location |
|-----------------------------------|---|
| Global settings | Configuration > [Central Configuration] Settings |
| SmartOrg settings | Configuration > [SmartOrg] Settings |
| Recruiting settings | Configuration > [Recruiting] Settings |
| Career Section settings | Configuration > [Career Section] Settings |
| Onboarding (Transitions) settings | Configuration > [Onboarding (Transitions)] Settings |
| Performance settings | Configuration > [Performance] Settings |
| Reporting and Analytics settings | Configuration > [Reporting and Analytics] Settings |

Settings are configured by system administrators. A default value is set prior to product delivery. System administrators can modify the value and the change will be applied throughout the product. Certain setting values can be changed by users. In that case, the value set by the user will override the value set by the system administrator.

A setting has one of the following security levels: Public, Protected, Private.

| Security Level | Description |
|----------------|---|
| Public | System administrators can view and change the setting. |
| Protected | System administrators can view the setting, but changes can only be performed by Oracle. |
| Private | System administrators cannot view or change the setting. Only Oracle can view and change the setting. |

Configuring a Setting

Before you start

The security level of the setting must be Public.

The *Manage Settings* user type permission is required.

For global settings:

Configuration > [General Configuration] Settings

For product settings:

Configuration > [Product name] Settings

Here's what to do

1. Locate the setting using the Refine by list or the Feature column.
2. Click the name of a setting.
3. Click Edit next to the name of the setting.
4. Make changes.
5. Click Save.

Restoring the Default Value of a Setting

Before you start

The security level of the setting must be Public.

The *Manage Settings* user type permission is required.

For global settings:

Configuration > [General Configuration] Settings

For product settings:

Configuration > [Product name] Settings

Here's what to do

1. Locate the setting using the Refine by list or the Feature column.
2. Click the name of a setting.
3. Click Reset next to the name of the setting.

Results:

The default value of the setting is restored and the change is reflected in the product.

Career Section Settings

A setting is assigned one of the following security levels: Public, Protected, Private.

| Security Level | Description |
|----------------|---|
| Public | System administrators can view and change the setting. |
| Protected | System administrators can view the setting, but changes can only be done by Taleo. |
| Private | System administrators cannot view nor change the setting. Only Taleo can view and change the setting. |

| Career Section Settings | | | |
|--|--|----------------|---------------|
| Setting | Description | Security Level | Default Value |
| Access to "View Email Messages" | This setting displays or not the "View Messages" link in the candidate portal and for all candidate portals. | Public | No |
| Activate Secure Login | When configured to No, candidates' browsers will cache all career pages. When configured to Yes, candidates' browsers will only cache pages from the unauthenticated state. | Private | Yes |
| Advanced Logic Draft Submission Activation | Allow the administrator to activate the advanced logic for draft submissions. | Public | No |
| Always Display Profile Import Services | Determines the display of third-party profile import services on the Resume Upload block. If the setting is set to "No", the services are hidden from view when data is present in both the Education block and the Work Experience block. If the setting is set to "Yes", the services are always displayed. | Public | No |
| Authentication Page Layout | When configured as "horizontal", the sign-in partners section displays to the right of the username and password fields on the Login and New User Registration screens. When configured as "vertical", the sign-in partners section, and other authentication methods, displays below the username and password fields on the Login and New User Registration screens. | Public | Horizontal |
| Beacon Interval | Time out period setup of the Career Section. The ping frequency of the beacon in milliseconds. | Protected | 300000 |
| Candidate maximum attachment updates | Maximum number of possible candidate attachment updates per period. | Protected | 5 |

| Career Section Settings | | | |
|--|---|----------------|---|
| Setting | Description | Security Level | Default Value |
| Career Section Hits Tracking Activation | Activate the Career Section hits tracking on the customer zone. | Public | Yes |
| Career Section Latest Page Tracking Activation | Allow support team to activate tracking on latest page accessed by candidates in the Career Section. | Public | Yes |
| Career Section Services Password | This setting defines the password used in a special URL that returns the job list or the job description without using any sessions. | Public | |
| Career Section Session Timeout for Screening Block | The total amount of time (in milliseconds) available to candidates to fill out a screening questionnaire. This setting is used to extend the time available beyond the normal session timeout value of the JVM. | Protected | 1800000 |
| Career Section URL Redirection | Indicates if Career Section links must be redirected to the alternate job list URL when they are generated for an email or for a job board. (Variable {CAREER_SECTION_URL}) | Public | No |
| Cross Frame Protection Allowed Domains | Lists domains where Career Sections are allowed to be embedded in frames. Enter domains without protocols and pipe-separated. The * wildcard is accepted. Example: *.company.com company2.com | Public | |
| Default Time Zone | Indicates the default time zone for the WebTop. | Public | |
| Disable access for candidates not using cookies | Blocks candidates without cookie support. | Public | No |
| Disqualified Candidates Lock Out Period | Disqualification lock out period preventing candidates from returning to their application or profile depending on where the disqualification occurred. | Public | Allow Always |
| Employee Referral Program URL | URL for the Employee Referral Program within the organization's Web site. Value used in the token {COMPANY_STATIC_PAGE} only for the Referral Acknowledgment letter sent to the candidate. | Public | |
| Enable Background Check Consent Disqualification Functions | When activated for Background Check Consent, this setting enables candidate disqualification functions. | Public | No |
| Enable Customization of Job Submission Statuses | This setting enables the administrator to configure messaging to candidates from the "My Jobpage" area of the Career section. | Public | No |
| Entry File for Career Section Links | Contains the complete path of the HTML file that contains the organization frames and the Taleo frame. | Public | |
| Faceted Search | Determines whether Faceted search can be enabled for specific career sections. | Public | No |
| Full Organization Name | Used to specify the organization name that must be used in the Job Application | Public | en=VIDE5; fr=VIDE5; es=VIDE5; de=VIDE5; |

| Career Section Settings | | | |
|--|---|----------------|---|
| Setting | Description | Security Level | Default Value |
| | Information email and Correspondence Manager parts of the application. | | it=VIDE5; nl=VIDE5; en-GB=VIDE5; zh-CN=VIDE5; ja=VIDE5; fr-FR=VIDE5 |
| General Profile Duplicate Check Task Assignee | Allows system administrators to specify the person who will perform the duplicate check task in the Recruiting Center for candidate general profiles. | | |
| Google Structured Data Location Mapping Country | The location level configured will use the value from the requisition's location for indexing into Google's location structure of "Country". This setting is optional for the Google indexing feature. | Public | Not specified |
| Google Structured Data Location Mapping Locality | The location level configured will use the value from the requisition's location for indexing into Google's location structure of "Locality", which is the concept of City. When this setting is configured to "Not Specified", the Google indexing feature will be disabled. | Public | Not specified |
| Google Structured Data Location Mapping Postal Code | The location level configured will use the value from the requisition's location for indexing into Google's location structure of "Postal Code". This setting is optional for the Google indexing feature. | Public | Not specified |
| Google Structured Data Location Mapping Region | The location level configured will use the value from the requisition's location for indexing into Google's location structure of "Region", which is the concept of State/Province. When this setting is configured to "Not Specified", the Google indexing feature will be disabled. | Public | Not specified |
| Google Structured Data Location Mapping Street Address | The location level configured will use the value from the requisition's location for indexing into Google's location structure of "Street Address". This setting is optional for the Google indexing feature. | Public | Not specified |
| Invitation To Self-identify | Activated Flow for Invitation To Self-identify. | Public | None |
| Legal Statement Decline URL | URL used to redirect a candidate who declines a legal statement placed before the login page when this candidate needs to log in before seeing the job list. | Public | |
| Masking Diversity Question Answers | Enables the masking of diversity question answers in Career Sections. | Public | No |
| Maximum attempts to attach file period | Period during which the maximum number of candidate attachment attempts apply. | Protected | 30 |
| Message Delete Permission | This setting displays or not the "Delete" link for each message in all candidate portals. | Public | No |

| Career Section Settings | | | |
|---|--|----------------|---------------|
| Setting | Description | Security Level | Default Value |
| Number of Unreceived Pings Before Time Out | Time out period setup of the Career Section. Number of missing pings before the session is terminated. | Protected | 2 |
| Organization Web Address | Web site host name of the organization. Home page of the organization, not the Career Section home page. | Public | www.VIDE4.com |
| Populate Source Tracking for Employee Referral | <p>When the setting is enabled and employees use the Refer a friend feature from within an internal career section, the Source Tracking value on the Job Submission tab of the candidate file is automatically filled with the "Our Employee" value. This feature applies to both general profile and job-specific requisition referrals by employees.</p> <p>The source does not have to be configured as In Profiler and In Requisition.</p> <p>The source does not have to be configured as an active source on the requisition.</p> <p>Only source code REF-12 can be used with this feature; it cannot be used with sources configured by customers.</p> <p>This feature is not associated in any way with referrals made through Sourcing.</p> | Public | No |
| Profile Import Partner Availability Apply With LinkedIn | Activated, the Apply With LinkedIn service is exposed in Configuration for a customer to configure and enable. Deactivated, it is not displayed in Configuration. If deactivated after prior activation, historic configuration is stored. | Public | Yes |
| Propagate Username in Login Pages | Automatically propagate the username when the user browses through the login pages (login, registration, forgotten password, forgotten username etc.). | Public | Yes |
| Request More Info Active | Activated Flow for Request More Information | Public | None |
| Resume Parsing Languages and Scope | Indicates the content languages allowed in a flow to extract and display data from a resume file, using the resume upload function. | Protected | en*,1 |
| RSS Feed Activation | Activate the RSS feed feature on the customer zone. | Public | No |
| Session Maximum Inactive Interval | Time out period setup of the Career Section. Maximum inactive interval, in milliseconds, for a user before his session is terminated. | Protected | 3600000 |
| Session Time Out Reminder Interval | Time out period setup of the Career Section. Time in milliseconds before session timeout reminder is displayed. | Protected | 1200000 |

| Career Section Settings | | | |
|------------------------------------|--|----------------|---------------|
| Setting | Description | Security Level | Default Value |
| Show Explicit Login Error Messages | Specifies if the error messages returned by the system identify whether the user ID or password was incorrect. | Public | No |
| Technical Help Information Type | Indicates the type of information used to explain how to get technical help. | Public | None |

Career Section Security Settings

Security Policies

Security settings can be set globally for each type of Career Section, and also for a specific Career Section.

System administrators can set security settings globally for each type of Career Section (internal, external, agency portal) under the Global Security section of the Career Section Administration menu. For example, Sign In requirements might be different for those who already work for the organization (Internal Career Sections) versus candidates who do not already work for the organization (External Career Sections). Or, Agency Portals might have entirely different User Account parameters.

System administrators can also set security settings for a specific Career Section by accessing the career section page under the Career Section section of the Career Section Administration menu. If a system administrator configures the security settings for a given Career Section, it is the configuration specifically made for that Career Section that is applied, not the configuration set for a Career Section type. The security settings set at the Career Section type level are used as the default settings if no settings are defined for a given Career Section.

Security settings are organized into five groups:

- Security Settings
- Sign In
- User Accounts
- Self-registration (not for agency portals)
- User Name

There are two groups of security settings that can only be set at the Career Section type:

- Password
- Forgot Password

Several Career Section settings allows the configuration of several Security Settings. For example, the system administrator can choose to enforce a security protection on all pre-authentication pages in order to prevent browser to cache all credentials (login/password, access code, secret question/answer) request. The Activate Secure Login setting allows the system administrator to enable this feature. When this setting is activated, the Back button in browser may not work properly anymore.

| Setting | Possible Values | Default Value | Location |
|------------------------------------|---|---------------|---|
| Show Explicit Login Error Messages | <ul style="list-style-type: none"> No Yes | No | Configuration > [Career Section] Settings |
| Propagate Username in Login Pages | <ul style="list-style-type: none"> No Yes | Yes | Configuration > [Career Section] Settings |
| Career Section Services Password | user-defined | None | Configuration > [Career Section] Settings |
| Activate Secure Login | <ul style="list-style-type: none"> No Yes | No | Configuration > [Career Section] Settings |
| Use SSN as User Name | User-defined | No | Configuration > [Career Section] Settings |
| Invitation to Self-identify | User-defined | none | Configuration > [Career Section] Settings |

Configuration

| User Type Permission Name | Location |
|---------------------------|--|
| Manage Security Policies | Configuration > [SmartOrg] Administration > User Types > Configuration |

Configuring Security Options for a Career Section Type

Before you start

The *Access the Career Section administration section* user type permission grants users access to this feature.

Configuration > [Career Section] Administration > [Global Security] Career Section types

Here's what to do

1. Select a career section type (internal, external, agency portal, Onboarding portal).
2. Click Show next to the settings type.
3. Click Edit next to the security option.
4. Make changes.
5. Click Save.

Results:

If no options are set specifically for a Career Section, then the selections made for a specific type of Career Section are applied.

Configuring Security Options for a Specific Career Section

Before you start

The *Access the Career Section administration section* user type permission grants users access to this feature.

Career section must have Inactive status.

Configuration > [Career Section] Administration > Career Sections

Here's what to do

1. Click the name of a Career Section.
2. Click Edit next to the security category.
3. Make changes.
4. Click Save.

Results:

Security options are applied to that specific Career Section.

Security Setting Options

Security setting options can be set in the following places:

- Configuration > [Career Section] Administration > Internal Career Sections
- Configuration > [Career Section] Administration > External Career Sections
- Configuration > [Career Section] Administration > Agency Portals
- Configuration > [Career Section] Administration > Career Sections > Career Section Name

Security setting options can be applied globally to a Career Section type or to a specific Career Section.

| Security Setting Options |
|--|
| Require users to sign in before accessing the Job List |
| Require users to sign in before accessing job descriptions |
| Allow users to change their user name |
| Allow access by internal candidates (employees) only |
| Log the user out when the last page of the flow has been reached, then display the main Job List if the user attempts to go Back |
| Use this phone number as hotline for users who encounter login problems |
| Require users to authenticate after changing their email address or user name. |

Sign In Policy Options

Sign in policy options can be set in the following places:

- Configuration > [Career Section] Administration > Internal Career Sections
- Configuration > [Career Section] Administration > External Career Sections

- Configuration > [Career Section] Administration > Career Sections > Internal or External Career Section Name
- Configuration > [Career Section] Administration > Agency Portals

| Sign In Policy Options |
|--|
| Allow new users to register in system |
| Display the link "Forgot your user name?" |
| Display the link "Forgot your password?" |
| Show explicit error messages to users at login |
| Display the OpenID option |

User Account Policy

User account policy options can be set in the following places:

- Configuration > [Career Section] Administration > Internal Career Sections
- Configuration > [Career Section] Administration > External Career Sections

| User Account Policy Options |
|--|
| Number of incorrect sign-in attempts allowed per user before his/her account is locked |
| Period during which the system prevents access to an account that has been locked |
| Use the following authentication method |
| Activate the Career Section Single Sign-On Configuration Wizard |

Self-Registration Policy Options

Self-registration policy options can be set in the following places:

- Configuration > [Career Section] Administration > Internal Career Sections
- Configuration > [Career Section] Administration > External Career Sections
- Configuration > [Career Section] Administration > Career Sections > Internal or External Career Section Name

Self-registration policy options are unavailable for Agency Portals.

| Self-Registration Policy Options |
|--|
| Ask new users to provide a password when they register |

| Self-Registration Policy Options |
|---|
| Ask new users to confirm the password when they register |
| Ask new users to provide an email address when they register |
| Ask new users to confirm the email address when they register |
| Activate the registration confirmation page |
| Number of username attempts before closing the session |

User Name Policy Options

User name policy options can be viewed in the following places:

- Configuration > [Career Section] Administration > Internal Career Sections
- Configuration > [Career Section] Administration > External Career Sections
- Configuration > [Career Section] Administration > Career Sections > Career Section name

| User Name Policy Options |
|---|
| Activate this user name security policy |
| Require user names that contain at least X characters |
| Require user names that contain no more than X characters |

Password Policy Options

Password policy options can be set in the following places:

- Configuration > [Career Section] Administration > Internal Career Sections
- Configuration > [Career Section] Administration > External Career Sections
- Configuration > [Career Section] Administration > Agency Portals

Password policy options can only be applied globally to a Career Section type.

| Password Policy Options |
|---|
| Allow a password to be valid for X days (leave the field empty and passwords will not expire) |
| When a password change is required, prevent the reuse of the previous X passwords |
| Require passwords that contain at least X characters |
| Require passwords that contain at least X characters |

| Password Policy Options |
|--|
| Require passwords that contain no more than X characters |
| Require passwords that contain at least X letters of the Roman alphabet |
| Require passwords that contain at least X lowercase letters of the Roman alphabet |
| Require passwords that contain at least X uppercase letters of the Roman alphabet |
| Require passwords that contain at least X numeric characters |
| Require passwords that contain at least X characters other than letters and numbers (! # \$ % & () * + , - . / : ; < = > ? @ [] _ ` { } ~) |
| Require passwords that contain no more than X identical consecutive characters |
| Require passwords that do not contain the user's first name |
| Require passwords that do not contain the user's last name |
| Require passwords that do not contain the corresponding user name |
| Require passwords that do not contain the user's email address |

Forgot Password Policy

Forgot password policy options must be set for each of the three Career Section types.

- Configuration > [Career Section] Administration > Internal Career Sections
- Configuration > [Career Section] Administration > External Career Sections
- Configuration > [Career Section] Administration > Agency Portals

Forgot Password policy options can only be set globally for a Career Section type.

| Forgot Password Policy Options |
|--|
| Use this method to change passwords |
| Number of incorrect attempts allowed per user to enter the email address |
| Lock a user's account when the number of incorrect attempts allowed to enter the email address is exceeded |
| Require X security questions |
| Require answers that contain at least X characters (X must be greater than 0) |
| Number of attempts allowed per user to answer the security question |
| Lock a user's account when the number of attempts allowed to answer the security question is exceeded |
| Mask the security answer values |

Details regarding the “Use this method to change passwords” setting

The change password procedure contains six options of authentication:

Note: Oracle recommends using the Security Questions and Access Code method as it is the most secure method for the Forgot Password feature.

| Options for the “Use this method to change passwords” Setting | |
|---|---|
| Option | Description |
| Access Code | An email containing an access code is sent to the user once the user has confirmed his/her email address. |
| Security Questions | The user is asked to answer the security questions (from 1 to 3) previously entered in his/her profile. If the answer is correct, the user is invited to enter a new password. |
| Security Questions and Access Code | The user is asked to answer the security questions (from 1 to 3) previously entered in his/her profile. If the answer is correct, an email containing an access code is sent to the user once the user has confirmed his/her email address. |
| Security Questions or Access Code | The user is asked to answer the security questions (from 1 to 3) previously entered in his/her profile. If the answer is correct and the user has an email address, an access code is sent to the user once the user has confirmed his/her email address. If the user does not have an email address and the answer to the security question is correct, the access is granted to the application and the user is invited to change his/her password. |
| Security Questions and/or Access Code | When this option is activated, one of the following situation will happen. See the <i>Security Questions and/Or Access Code</i> table. |
| Contact System Administrator | The user is asked to contact the system administrator. Only the system administrator can then generate a new password and communicate it to the user. |

| Details Regarding the “Security Questions and/or Access Code” Option | | |
|--|-----------------------------------|---|
| The user has an email address | Security questions were activated | |
| Yes | Yes | The user will have to answer the security questions correctly and an access code will be emailed. |
| Yes | No | The user will receive an access code by email. |
| No | Yes | The user will have to answer the security questions correctly to be able to access the application. |
| No | No | The user will be asked to contact the technical support. |

Details regarding the Use this method for the Forgot Username setting

Career Section users who forget their user name can now receive it in an e-mail.

If Career Section users forget their user name, they use the Forgot your user name? link and then enter their e mail address in the corresponding field.

Afterwards, they receive an e-mail containing their user name. They then use this information (and their password) to log into the career section.

In prior releases, the user name was displayed on-screen; there was no option to send it in an e-mail.

A new setting (configured for internal and/or external career sections separately) is available: Use this method for the Forgot Username feature. Administrators can choose between:

- Email: The user name is sent by e-mail.
- On Screen: The user name is displayed in clear text.

The default value of the setting Use this method for the Forgot Username feature is On Screen.

There is a separate message template called "Find username" associated with this feature. That message template should not be confused with the "Forgot username" message template.

Customers who plan to enable user name recovery through e-mail are advised to add the E-mail field to their Registration page. This measure ensures that the system has an e-mail on record for every candidate and will therefore send the "Find username" message even to users who don't complete the first page of an application flow.

It is recommended that customers set the value of the Propagate Username in Login Pages setting to No (Configuration > Career Section Settings). This is because candidates can also use the Forgot your password feature to retrieve their user name. If they were to lend their device to someone else, the feature could be used for user name harvesting.

Details regarding the "Mask the security answer values" setting

If the setting value is set to Yes, answers to security questions are masked (concealed) while they are being typed and submitted. This provides candidates and employees with better security by preventing people who might be looking at the computer screen or tablet from seeing the answers to security questions. Visitors must enter the answer (also masked) in a second field to confirm their answer.

First-time Sign-in and Security Question Answers

If candidates or employees sign into a career section for the first time to create their candidate profile and they are required to provide answers for security questions, asterisks are displayed in place of the answers they type. For each security question, visitors must also enter their answer (also masked) in a second field to confirm the answer they provided in the first field.

"Forgot your password?" and Masking Security Answer Questions

If candidates or employees forget their password and are required to provide answers for security questions, visitors must enter their answer to each question in two fields, the second field serving as confirmation of the answer they entered in the first field. You can configure security question answers such that they are masked while being typed and submitted.

If the setting value is set to No, the characters will be displayed as the candidates or employees type them.

The "Mask the security answer values" setting is only displayed for internal and/or external career section configuration if the value of the corresponding "Use this method to change passwords" setting is set to include security questions.

For example, if you select Access Code as the method to change passwords for internal career sections, the "Mask the security answer values" setting is not displayed (hence cannot be configured) for internal career sections.

11 Social Media

Apply with LinkedIn 2.0

RSS Feature

Real Simple Syndication, or RSS, allows candidates to receive a notification for jobs corresponding to their job search criteria.

When creating a Career Section, system administrators can enable the RSS option allowing candidates visiting their Career Sections to create RSS job feeds. Thereafter, candidates receive a notification (job title and short description) via their RSS feed, of jobs that correspond to the job search criteria they specified in Career Sections. Each RSS feed will display up to 10 jobs to a candidate, plus a link to the Career Section to see all the jobs.

If a job is posted in multiple languages, the language of the RSS feed a person receives corresponds to the language preference specified by that person. When the RSS feature is activated for a Career Section, the candidate can request job feeds based on Job Field and Location. The job feeds include only jobs that conform to a person's permissions at login. For example, the job feed an external user receives does not include internal job postings even if his/her search criteria match the internal job profile.

A private Career Section setting "RSS Feed Activation" allows the activation of this feature. By default this settings is set to OFF; please contact Oracle Support to have this setting activated. RSS is unavailable for Agency portals.

Note: The RSS feed does not display correctly in the Firefox 3.6 browser; to view the RSS feed, update to Firefox 4.0 or use a different browser.

Configuration

To enable the RSS feature the career section must have Inactive status.

| Career Section Property | Location |
|-------------------------|---|
| Enable the RSS Feature | Configuration > [Career Section] Administration > Career Sections > [Career Section] Name > [Properties] Edit |

Apply with LinkedIn

To allow job seekers to use their LinkedIn account for both their profile data and authentication, an Apply with LinkedIn button is presented on the Login and Registration pages of the Career Section. This enables job seekers to authenticate into the Career Section using LinkedIn and import their profile in one step; this removes the friction from the steps to register or login with a username and password prior to applying to a job. By using their LinkedIn session, job seekers

can create new job submissions without creating a personalized username and password in the Career Section. If the job seeker has an active cookie from LinkedIn on their device, the button displays as Apply with LinkedIn, and allows one-click authentication. In this case, the LinkedIn section displays in the LinkedIn user profile preference language.

Returning user

*User Name

*Password

Login

Forgot your user name?
Forgot your password?

Don't have an account?



New User

Use your profile data to apply

Your full LinkedIn profile
will be shared. [Learn More](#)

Apply with LinkedIn

Use a sign-in partner

If the job seeker does not have an active LinkedIn cookie, the button displays as, Sign in with LinkedIn. In this case, the LinkedIn section displays in the browser language.

Returning user

*User Name

*Password

Login

Forgot your user name?
Forgot your password?

Don't have an account?



New User

Use your profile data to apply

Please sign in to apply
with LinkedIn

Sign in with LinkedIn

Use a sign-in partner

There is a section on the Thank You page supporting this feature that invites users to create a username and password after they complete their job submission. When the user arrives at the Thank You page after completing the application flow, a Create my User Name and Password link displays if they do not have a personalized username and password in place. This LinkedIn feature is solely for creating new job submissions, not viewing or updating new submissions, therefore, users must create a personalized username and password to view or update their submissions, or for signing in to use other Career Section functions.

Danielle Millar, you are signed in. | [My Account Options](#) [My Job Cart \(0 Items\)](#) | [Sign Out](#)

[Job Search](#) [My Jobpage](#)

Thank You

Process completed

Thank you for sending us your online job submission. If your employment profile corresponds to our requirements, a member of our human resources department will contact you.

Set up a User Name and Password

You must create access credentials to view or update your submission in the future.

[Create my User Name and Password](#) 

If you choose not to set up access credentials now, you will receive an email with instructions to do so later.

Those users who do not create a username and password after arriving on the Thank You page will be sent an email inviting them to create the username and password at their convenience. Job seekers that do not reach the Thank You page, but begin a job submission will also receive this email invitation.

The Career Section has scenario handling built in which covers cases such as returning users who may not have created a username and password, and connecting LinkedIn authentication to existing accounts. There are five main scenarios that users will experience are as follows:

1. New Candidate - First job submission.

Details: The job seeker does not exist in Oracle Taleo Enterprise Edition and is applying to their first job.

User Experience: Uses the Apply with LinkedIn button, a user record is created and the LinkedIn profile data is imported. They proceed through the application flow and are invited to create a username and password on the Thank You page.

2. Returning User - Uses Apply with LinkedIn to apply to a second job.

Details: The job seeker has used the Apply with LinkedIn function in the past to apply to a job, and is now applying to another, different job.

User Experience: Uses the Apply with LinkedIn button, their latest LinkedIn profile data is imported augmenting the existing candidate record in Oracle Taleo Enterprise Edition. They proceed through the application flow. If they created a username and password previously, they are presented with a standard Thank You page. If they did not create a username and password, they are invited to create a username and password on the Thank You page.

3. **Returning User - First use of LinkedIn; their email address already exists in Oracle Taleo Enterprise Edition.**

Details: The job seeker uses the Apply with LinkedIn button for the first time. The Career Section detects that the email on their LinkedIn profile already exists in Oracle Taleo Enterprise Edition on a candidate record.

User Experience: After using the Apply with LinkedIn button, they are presented with a login screen to sign in with their Career Section username and password. This will tether their LinkedIn authentication to their existing Career Section account. Their profile is imported, augmenting their existing account.

They can also bypass this login and account tethering action, and create a new account. If email uniqueness is on the email address will not be imported since this will create a conflict with the other existing candidate record.

4. **Returning User - Used LinkedIn in the past to apply and attempts to do so again to update an existing job submission. Has a personalized username and password.**

Details: Career Section detects that they are a returning user who set up a username and password in a prior session.

User Experience: They are presented with a login screen to use their username and password to sign in.

5. **Returning User - Used LinkedIn in the past to apply and attempts to do so again to update an existing job submission. Does not have a personalized username and password.**

Details: Career Section recognizes that they are a returning user who did not set up a username and password in a prior session when they used Apply with LinkedIn, nor in response to the email they would have been sent which invited them to create a username and password.

User Experience: They are presented with a page with a Send Email button to re-send the email with an invitation to create a username and password.

Enabling Apply with LinkedIn

An Administrator must be logged into a LinkedIn Administrator account prior to enabling the Apply with LinkedIn service in Oracle Taleo Enterprise Edition.

The Vertical Layout of the Login page must be enabled to use Apply with LinkedIn.

1. Click Configuration.
2. Click Administration in the Career Section section.
3. Click Profile Import in the Integration section.
4. Under Profile Import Services, click the Apply with LinkedIn (applywithlinkedin) link.
5. Click Edit.

- At the bottom of the page, enter your zone in the Zone URL(s) authorized to use this LinkedIn Service field and then click Connect to LinkedIn.

Configuration > Career Section Administration > Profile Import Services > Apply with LinkedIn > Apply with LinkedIn

Apply with LinkedIn

This action allows you to view all service details. [More info](#)

Properties

Name: Code: applywthlinkedin

Description: Enables the Apply with LinkedIn service for candidates. Administrators should log out of other LinkedIn sessions prior to logging into LinkedIn as an administrator of this service. Settings: Inactive

Settings

| Name | Value |
|---------------------|-------|
| Client ID | |
| Zones | |
| Integration Context | |

* Zone URL(s) authorized to use this LinkedIn service (e.g.: customer.taleo.net|stgcustomer.taleo.net)

LinkedIn returns and populates the Client ID and the Zone URLs in both http and https formats and a LinkedIn widget is presented.

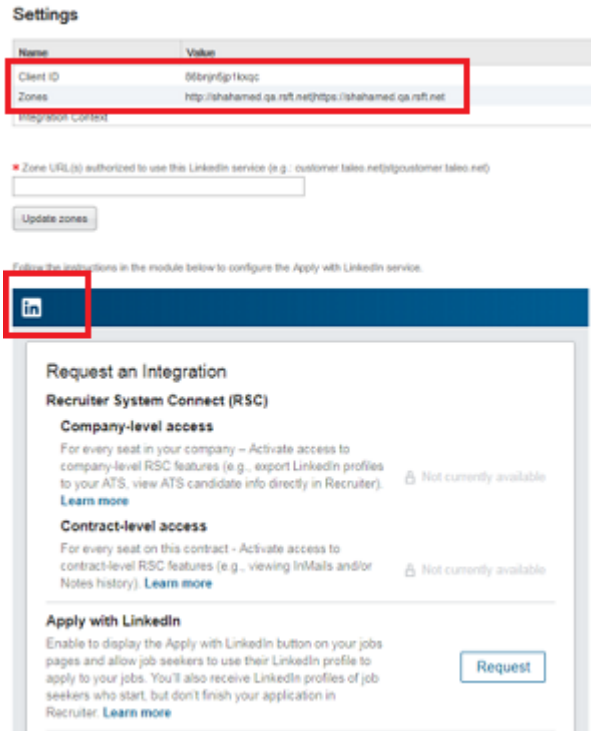

7. Click the Request button on the LinkedIn widget.

This populates the last of the needed settings, the Integration Context, in the Profile Import Settings.

8. Click Save.

9. Click Activate.

Note: This Oracle LinkedIn integration may enable You to link to or transmit Your Content or Third Party Content to, or otherwise access, or retrieve content from, LinkedIn and its platforms, users, or services. Oracle does not control and is not responsible for LinkedIn sites or platforms or services, the performance or availability of the services, or any content received or sent. You bear any and all risks associated with access to and use of LinkedIn sites, platforms, and services and are solely responsible for entering into and compliance with separate terms between you and LinkedIn. Oracle is not responsible for the security, protection or confidentiality of such content (including obligations in the Hosting and Delivery Policies and Data Processing Agreement and Oracle's Privacy Policy) that is transmitted to such LinkedIn sites or platforms or services. You are solely responsible for obtaining or having any required consents or other legal basis for your use of this integration. Oracle reserves the rights to terminate your connection and integration if your use of this integration violates the terms of your Agreement(s) with Oracle. Data that may be transmitted to LinkedIn as a result of use of this feature includes:

- Customer organization
- Applicant/Candidate email/identity
- Requisition Number
- Date of creating the submission
- Whether that submission is completed or not by the candidate

Viewing LinkedIn Company Connections

Candidates can view their LinkedIn Connections at a company while applying for a job on that company's career site. When a candidate visits a career section of a company and selects a job to apply for, the Job Description page displays a widget that shows the LinkedIn Connections of the candidate at that company.

To see their LinkedIn Company Connections, candidates must be logged in to LinkedIn. To take advantage of this feature, Recruiter System Connect (RSC) must be activated and each of the following settings must be enabled:

- Company Connection
 - a. Go to Configuration and click Administration under the Recruiting section.
 - b. Click Recruiting Services under the Integration section.
 - c. Select the LinkedIn Recruiter System Connect setting by clicking on its name.
 - d. Click Edit next to Properties and scroll to the bottom of the page to the Apply Package section.
 - e. Select the Company Connection checkbox to enable the LinkedIn Company Connections widget.
 - f. Click Save changes.
- LinkedIn Company Connections
 - a. Go to Configuration and click Settings under the Career Section section.
 - b. Select Name under Refine By and then enter LinkedIn Company Connections in the blank field and click Refresh.
 - c. Select the LinkedIn Company Connections setting by clicking on its name. This setting is enabled by default.
 - d. To disable and enable this setting, click Edit next to the LinkedIn Company Connections title.
 - e. Select a value of Yes or No and click Save to save your changes.
- Display the LinkedIn Connections Widget
 - a. Go to Configuration and click Administration under the Career Section section.
 - b. Click Career Sections under the Career Sections section.
 - c. Select a career section by clicking on its name and click Deactivate if active, to enable editing.
 - d. Click Edit next to Properties. Scroll down until you see the Display the LinkedIn Connections Widget setting.
 - e. Select a value of Yes or No and click Save to save your changes.
- Display LinkedIn Company Connections Widget
 - 1. Go to Configuration and click Administration under the Career Section section.
 - 2. Click Career Sections under the Career Sections section.
 - 3. Select a career section by clicking on its name and click Deactivate if active, to enable editing.
 - 4. Click Show next to Career Portal Pages.
 - 5. Click on Job Description.
 - 6. Click Edit next to Properties and go to the Display the LinkedIn Company Connections widget setting.
 - 7. Select a value of Yes or No and click Save to save your changes.

Candidate Sign In Using Third-Party Credentials

Candidates can log into their Career Section account (candidate profile) using third-party credentials such as Google.

It is a Taleo best practice to activate this feature, especially in external Career Sections, because it is a great time-saver for candidates.

If the third-party credentials are not linked to a candidate profile in the Taleo customer's Career Sections, the system verifies if the email address from the third-party application is an email address or user name in a candidate profile in the customer's Career Sections.

If no duplicate email address is found, the system creates a candidate profile in the Career Section automatically, using the email address (from the third-party login process) as the user name and generating a password that conforms to the security policies configured for the Career Section. If a security question was enabled for candidate profiles, the candidate is asked to provide this information.

If a duplicate email address is found in a candidate profile, the system displays the login page from which candidates can log into their account in the Career Section. Candidates select one of two options:

- If candidates select "Yes, I have a Candidate Profile and I would like to associate it to my single sign-on", the third-party account credentials are linked to the candidate profile in the Career Section. This option enables candidates to later sign into the Career Section directly (provided the candidates selected "Keep me logged in" or similar setting in the third-party product) by simply clicking the third-party icon on the Career Section.
- Candidates can choose to create a candidate profile. Thereafter, the third-party account credentials are linked to the new candidate profile in the Career Section and the candidates can sign into the Career Section directly (provided the candidates selected "Keep me logged in" or similar setting in the third-party product) by simply clicking the third-party icon on the Career Section.

If a security question was enabled for candidate profiles, the candidate is asked to provide this information.

When signing into a Taleo customer's Career Section using third-party credentials, candidates must indicate their acceptance or refusal of a legal agreement stating that they are responsible for logging out of the third-party solution after they have finished. Logging out of third-party solutions when finished is particularly important when candidates are using a public computer. If candidates accept the legal agreement, their acknowledgment is recorded in the database. If they decline the agreement, the career section Sign-In page is displayed anew. The text of the legal agreement cannot be configured.

Configuration

Display the OpenID Option can be set at the global level and at the career section level for external and internal career sections. If the Career Section Sign-on property *Allow new users to register in the system* is set to *No*, then it is recommended that the *Display the OpenID Option* for the career section also be disabled.

Note: For this solution to work, the Career Section must not be configured for single sign-on (SSO), which usually only affects Internal Career Sections. If SSO is turned on for a Career Section, then the property *Display the OpenID Option* must be disabled or the candidate will receive error messages.

| Setting | Location |
|---------------------------|---|
| Display the OpenID Option | Configuration > [Career Section] Administration > [Global Security] Internal Career Sections > [Sign In] Edit |
| Display the OpenID Option | Configuration > [Career Section] Administration > [Global Security] External Career Sections > [Sign In] Edit |
| Display the OpenID Option | Configuration > [Career Section] Administration > Career Sections > [Name] > Sign In > Edit |

Separate sets of labels are available for customers who want a single sign-on (SSO) login page for internal users and an SSO login page with third-party login options for external users. Taleo customers should contact their customer executive if they wish to have separate text for each type of candidate.

TexTool Labels for External and Internal Career Sections Using SSO

| Default Label | TexTool ID - External SSO | TexTool ID - Internal SSO |
|---|---------------------------|---------------------------|
| Welcome to the Candidate Profile Single Log-in Configuration | 2418132 | 355212 |
| Our records indicate that your email address is already linked to a candidate profile in our system. Please enter the username and password for the existing account, which will link your two accounts together and allow you to view your existing candidate profile. | 2419711 | 2412630 |
| Candidate Profile Creation | 2416824 | 355086 |
| Please specify a user name and password below. You can use this username and password in the future to access any of the {0} candidate portals. This username and password can also be used as a backup measure, in case your single log-in service provider is down. We suggest you use the same login information as for your SSO connection. | 2416761 | 355083 |

TexTool Labels for Third-party Credentials (in Career Sections Using SSO)

| Default Label | TexTool ID |
|---|------------|
| Yes, I have a Candidate Profile and I would like to associate it to my single log-in. | 355203 |
| No, I don't have a Candidate Profile, but I would like to create one now. | 355200 |

Important Changes to the Sign in with Google Service

A change to the Sign in with Google service used by candidates to register and sign in to the Taleo Career Section requires your action to maintain continued service.

Google is replacing their existing Sign in with Google service with Sign in with Google+. Google requires vendors, such as Oracle, to replace the existing Sign in with Google authentication method with the newer Sign in with Google+ authentication method to avoid user disruption.

All customers are impacted by Google's changes. Customers who are currently using the Sign in with Google service must upgrade to Taleo 15A or 14B.3 or higher and undergo configuration steps to enable the Sign in with Google+ service prior to Google's deprecation of the Sign in with Google service, scheduled for April 20, 2015. If the Sign in with Google+ service is not enabled, candidates using their Google credentials to sign into a customer's career section will lose the ability to access their accounts. Customers who are not currently using the Sign in with Google service but wish

to allow candidates to login using Google credentials in the future must also upgrade to Taleo 15A or 14B.3 or higher and undergo the same configuration steps to enable the Sign in with Google+ service.

Instructions on how to configure Google+ feature are provided here: [Setting Up Google+ Login if Upgrading to Release 14B.3, 15A or Higher](#).

Setting Up Google+ Login if Upgrading to Release 14B.3, 15A or Higher

It is recommended that you perform this configuration shortly after the zone is delivered to minimize the time during which candidates will be unable to access the career section using their Google credentials.

1. Access the Google Developers Console (<https://console.developers.google.com>). You may choose to use or create a company-specific Google account rather than a personal account.

2. Create a project for your zone.

- Click Projects, then Create Project.
- In the Project Name field, enter the project name that will be listed in the Google account.
- In the Project ID field, enter a unique project identifier for the zone you are configuring.
- Click Create.

3. Generate Google credentials.

- In the left panel navigation, under APIs auth, select Credentials.
- In the Auth section, click the Create new Client ID button.
- Under Application Type, select Web application.
- Click Configure consent screen button.

4. Complete the consent screen.

- Click Consent screen.
- In the email address field, enter the Google email address associated with the project you created as part of step 2.
- In the Product Name field, select the product name to be displayed in the Google consent screen.
- In the Homepage URL field, enter the home page of the zone being configured (<https://zonename.taleo.net>).
- Click Save.

5. Create the Client ID.

- Under Application Type, select Web application.
- In the Authorized Javascript Origins field, enter the full URL of the zone DNS: <https://zonename.taleo.net>
- In the Authorized Redirect URIs field, enter the URL below, substituting 'zonename>' with your zone. <https://zonename.taleo.net/careersection/RedirectOpenIdConnectResponseServlet.js>
- Click Create Client ID.

6. Note the results.

- In the Client ID for web application page, take note of the following information:
 - Client ID
 - Client Secret
 - Redirect URLs

7. Configure Google credentials in Taleo.

- In Taleo home page, click Configuration.
- In the Configuration menu, click Administration under Career Section.
- Under Global Security, click OpenID Authentication Configuration.
- Click the Google provider link.
- In the OpenID Version field, make sure that OpenID Connect Version is selected.
- Select the Enabled option.
- In the Open ID Connect Redirect URL field, enter the redirect URL. <https://zonename.taleo.net/careersection/RedirectOpenIdConnectResponseServlet.jss>
- In the Open ID Connect Client ID field, enter the Client ID provided by Google.
- In the Open ID Connect Client Secret field, enter the Client Secret provided by Google
- In the Open ID Connect Automatic Discovery URL field, enter the URL below. It is the same for all zones. <https://accounts.google.com/.well-known/openid-configuration>

Once the configuration is done, you should test the connectivity with Google using a testing candidate.

The image shows two configuration screens. The top screen, titled "Client ID for web application", contains a table with the following fields:

| | |
|--------------------|---|
| CLIENT ID | [REDACTED]d9dugabv9fuaa5v7652vop.apps.googleusercontent.com |
| EMAIL ADDRESS | [REDACTED]bv9fuaa5v7652vop@developer.gserviceaccount.com |
| CLIENT SECRET | [REDACTED]whsfksiNn |
| REDIRECT URIS | https://[REDACTED]/careersection/RedirectOpenIdConnectResponseServlet.jss |
| JAVASCRIPT ORIGINS | https://[REDACTED]leo.net |

Below the table are buttons for "Edit settings", "Reset secret", "Download JSON", and "Delete".

The bottom screen, titled "OpenID Connect", has four input fields:

- Open ID Connect Redirect URI
- Open ID Connect Client ID
- Open ID Connect Client Secret
- Open ID Connect Automatic Discovery URL

Blue arrows point from the Client ID, Email Address, Client Secret, and Redirect URIS fields of the top screen to their respective input fields in the bottom screen. A blue arrow also points from the "Open ID Connect Automatic Discovery URL" field to the URL <https://accounts.google.com/well-known/openid-configuration>.

Twitter

RSS Feed for Twitter

This feature allows Career Section visitors to post jobs to a Twitter account.

Career Section visitors have the ability to post recent jobs to a Twitter account based on various locations and job fields. For example, a visitor could want to post new marketing jobs available on Career Section to a Twitter account called "ABCMarketingJobs".

TwitterFeed or any third party vendor that can feed RSS to Twitter accounts can be used.

Setting Up an RSS Feed for Twitter

Before you start

A Twitter account must exist.

A TwitterFeed account (or an account with a 3rd party vendor that can feed RSS to a Twitter account) must exist.

RSS must be enabled on the Career Section.

Here's what to do

1. Access a Career Section.
2. In a search page, select a location or job field.
3. Click the RSS icon.
4. Copy the URL located at the top of the page.
5. Access TwitterFeed or any third party vendor that can feed RSS to a Twitter account.
6. Start the Feed creation wizard.
7. Paste the URL in the RSS Field URL field.
8. Follow the on-screen instructions.

Taleo Social Sourcing

CS Job Search Tab Redirect to Sourcing

This feature provides Oracle Taleo Enterprise Edition Career Section (CS) customers, who want to use Sourcing (or another product) as the primary career site, the ability to redirect users from the CS Job Search tab back to Sourcing (or other product).

When a customer uses Sourcing as the Job Search front-end for Taleo Enterprise, and a candidate searches for jobs and finds one they are interested in applying to, the candidate is handed off to CS for the application flow. During the application process, if the candidate decides to search for more jobs and this feature is enabled, when the user clicks the Taleo Enterprise Job Search tab they are navigated back to Sourcing via the configured URL. They can then use Sourcing to search for more jobs.

Candidates using external URLs which point to a CS job search or job list page are also redirected to the configured Sourcing job search.

The settings to enable this feature are located in the Taleo Enterprise Configuration module under the Career Section Administration section. See the table below for the full navigation path and settings names.

Configuration

Configuration properties for this feature are listed in the table below.

| Property Name | Location |
|--|---|
| Alternate Job List URL text box | [TEE Career Section] Configuration > [Career Section] Administration > Career Sections (click career section name) [Properties] Edit |
| Apply Alternate Job List URL to Job Search Tab dropdown list (Yes or No) | [TEE Career Section] Configuration > [Career Section] Administration > Career Sections (click career section name) [Properties] Edit |

One of the CS portal pages for job search needs to be activated, to display the Job Search tab for a navigation link that can be redirected.

Job Description Redirect URL

Candidates coming from job boards or who click the link to a job in email correspondence can be redirected to Taleo Sourcing or other product (instead of a "standard" career section) and can view the job description there.

Some organizations use Taleo Sourcing or other products as their job search page while using Oracle Taleo Enterprise Edition Career Section for the application process.

Career Section administrators can specify an alternate URL that will enable candidates coming from job boards or links in emails to view the job description hosted on Taleo Social Sourcing (or other product).

How does this work? Suppose the following URL is for a job description at an organization's career section is

`https://zone.taleo.net/careersection/cscod/jobdetail.ftl?job=1400123&lang=en&src=linkedin`

In the previous URL, "cscod" is the code of the career section, "1400123" is the requisition number and "en" is the language (English) of the job description. Suppose also that the value of the new setting, Job Description redirect URL, is

`https://pm.referrals.selectminds.com/`

The Taleo system would replace the "https://zone.taleo.net/careersection/CSCODE/" portion of the original with the value populated in the Job Description redirect URL setting. The two components would be combined to form

`https://pm.referrals.selectminds.com/job=1400123&lang=en&src=linkedin`

This new URL enables Taleo Social Sourcing (or other product) to display the job description even though the candidate clicked the URL to the standard career section. Other customer systems using this feature will have to parse the concatenated URLs. If no language is specified (lang=), the system will use the base language of the requisition. If no source tracking is specified (src=), it is omitted in the concatenated URL. If the parameters are not in the correct order, the Taleo system will rearrange them into the correct order. This setting is unilingual because language management is managed by the URL.

Configuration

| User Type Permission Name | Location |
|------------------------------|---|
| Job Description redirect URL | Configuration > [Career Section] Administration > Career Sections > (click a career section name) > [Properties] Edit |

Ensure that the "downstream" system is able to parse the concatenated Taleo URLs.

Ensure that the "downstream" system has error handling for cases where the job is no longer posted in the system.

Jobs in Google Search Results

Google Structured Data for Indexing

Jobseekers searching for jobs on Google are able to find jobs in their Google search results. This feature adds markers in the page layout of the Career Section Job Description page which allows Google to index jobs. A block of code is included in the Job Description page which Google Search tools can index according to its formatting rules. This enables jobs posted on Career Sections to be indexed and searchable on Google Search.

Administrators enable this feature through mapping SmartOrg location levels to Google's levels. The levels in the settings reflect the language and levels used in Google's level concepts. When the feature is enabled, through location mapping, the system will automatically include those fields which are mapped in the code block.

The five settings represent location level concepts in Google's data model and reside in the Career Section settings:

- Google Structured Data Location Mapping Country – Optional for indexing

The location level configured will use the value from the requisition's location for indexing into Google's location structure of "Country". This setting is optional for the Google indexing feature.

- Google Structured Data Location Mapping Locality – Mandatory for indexing

The location level configured will use the value from the requisition's location for indexing into Google's location structure of "Locality", which is the concept of City. When this setting is configured to "Not Specified", the Google indexing feature will be disabled.

- Google Structured Data Location Mapping Postal Code – Optional for indexing

The location level configured will use the value from the requisition's location for indexing into Google's location structure of "Postal Code". This setting is optional for the Google indexing feature.

- Google Structured Data Location Mapping Region – Mandatory for indexing

The location level configured will use the value from the requisition's location for indexing into Google's location structure of "Region", which is the concept of State/Province. When this setting is configured to "Not Specified", the Google indexing feature will be disabled.

- Google Structured Data Location Mapping Street Address – Optional for indexing

The location level configured will use the value from the requisition's location for indexing into Google's location structure of "Street Address". This setting is optional for the Google indexing feature.

Fields which are optional in the Google Structured Data format are only included in the code block if they are:

- Configured to be displayed on the Job Description page layout for that Career Section.
- For locations, when the settings are mapped to SmartOrg locations.

Note:

- This feature only applies to external career sections.
- For locations, we only show the locations that are mapped in the five SmartOrg location settings.

12 Candidate File Import

Candidate File Import

Profile Import Options for Candidates

Candidates can upload a profile making the application process more streamlined.

For this feature, some of the well-known third-party sites are supported. Third-parties supported are subject to change at any time.

Candidates are able to import a profile for *application flows* of type Candidate Profile, and Job-specific Application. The profile import is dependent on the *Resume Upload* block. It is a best practice to put the Resume Upload block on all application flows to ease the input burden on the candidates. If *Resume Parsing* is on, candidates have the option of uploading a resume.

The candidates can also upload information from a third party using the Import Profile options. If the candidates select one of the Import Profile options, authentication credentials need to be provided to the third party before the data is imported. Depending on which third-party solution is selected, the candidates may be presented automatically with a legal authorization page.

The candidates will always be presented with the *Resume Upload* block if the Education or Experience blocks of a submission are empty.

After uploading a resume the candidates are returned to the application flow and continue with the application flow with data imported in. All fields mapped by the profile import service are populated, whether or not those fields are displayed in a job-specific submission or general profile flow. In the case where a field is not configured in the flow, the candidate will not have the opportunity to correct or edit that specific information while advancing through the flow. If the candidates end the application process part way through, all valid data from the import is saved in the candidates' record, whether they have reached that page in the flow or not, however the application is still flagged as incomplete.

Customers can configure their career sections to always display partner import services (i.e. even if there is candidate information already in the system).

Customers can enable a setting to display partner import services such as LinkedIn and Indeed even if there is Education and Work Experience information on file in the customers' zone. Whenever candidates choose to import data from one of these partners (and they can do so as often as they wish), any new structured data will be added to the system while, in the case of Indeed, any existing structured data will be updated accordingly. The substantial usefulness of this feature resides in the fact that candidates typically keep their profile information up-to-date on sites such as LinkedIn or Indeed, rather than updating their information on each customer's zone.

Customers can modify the following user-defined labels to provide information they feel will help candidates choose the most appropriate import options for their profile.

User-defined Labels for Profile Upload

| TexTool ID | Default Label |
|-------------------|---|
| TexTool Resources | |
| 2323111 | You can submit personal and professional information by uploading a profile. The system will automatically extract the relevant information included in the profile and fill out part of the online submission. You can review the extracted information and make the appropriate changes in the next steps. |
| 2323114 | You can submit personal and professional information by importing a resume or by importing a profile from a third-party service. The system will automatically extract the relevant information from the profile or the resume and fill out part of the online submission. You can review the extracted information and make the appropriate changes in the next steps. |
| 2323117 | Profile Upload |
| 2323120 | LinkedIn |
| 2323123 | No thanks, I will fill out the online submission manually |
| 2323126 | Or upload a resume |
| 2323129 | If you do not upload a profile, you will need to fill out the online submission manually. |
| 2323132 | If you do not upload a profile or a resume, you will need to fill out the online submission manually. |
| 2323138 | Upload data from |
| 2323154 | To import a profile from a third-party service, select the radio button next to the relevant service icon. The system imports the data included in the third-party profile. Once the process is complete, you must review the imported data. |
| 2323161 | Uploading a profile |

Configuring Perpetual Display of Partner Import Services

To display partner import services even if there is candidate information already in the system perform the following steps.

Before you start

Configuration

Configuration

Here's what to do

1. Click Configuration.
2. In the Career Section section, click Settings.
3. Find the Always Display Profile Import Services setting and click it.
4. Click Edit.
5. Click Yes.
6. Click Save.

Profile Information Imported from Indeed

Candidates applying for a job or completing their candidate profile on career sections powered by Oracle Taleo can import information they created at Indeed, a search engine for job listings.

Indeed is a single-topic search engine for job listings, a type of vertical search. The Web site aggregates job listings from thousands of Web site including job boards, staffing firms, associations and company career pages. Job seekers can apply directly to jobs on Indeed's site. Indeed also offers resume posting and storage.

The ability to import profile information from Indeed applies to cases where Career Section administrators added the Resume Upload block to candidate profile flows or job submission flows. When candidates reach the Resume Parsing Profile Upload page in a flow, they click the radio button next to the Indeed icon and enter their Indeed login information in the window that appears.

The profile information in Indeed is entered automatically in the corresponding fields in the candidate profile flow or job submission flow. The Indeed session is terminated automatically and the candidates can enter any other information requested in the flow.

Data from Indeed is placed into the following standard fields in Oracle Taleo:

- First and last name
- City and country of residence
- Summary statement
- Additional information
- Custom URLs
- URL to the Indeed profile
- Work experience: Other Employer, Other Job Field, Start Date, End Date, Achievements
- Education: Other Institution, Other Program, City, Start Date, Graduation Date
- Certifications: certification names, dates

Note: Indeed does not offer an integration functionality that would enable file attachments to be imported into the Oracle Taleo system.

Configuration

Steps 1, 2 and 3 can be performed in any order.

1. Career Section administrators must add the Resume Upload block to the general profile flows or job submission flows on which they want the Indeed icon to be displayed.
2. The administrators can include the Additional Information block as well because it also contains fields that can be populated by information imported from Indeed.
3. The administrators can add the Website Address field to Candidate Personal Information forms because the field can be filled by information imported from Indeed.
4. A "token" and "secret" from Indeed are required. See *Registering With Indeed*.
5. The administrators enter the "token" and "secret" into the Taleo system (Configuration > [Career Section] Administration > [Integration] Profile Import > Indeed > Edit). See *Enabling Indeed Apply*.

Registering With Indeed

Before you start

Here's what to do

1. Go to <https://secure.indeed.com/account/apikeys>.
2. Perform the following steps if you do not have an Indeed account:
 - a. Click the Create an account free link.
 - b. Enter an email address and password in the corresponding fields.
Providing a shared email address or an email address that will remain valid in spite of personnel changes is strongly recommended. For example: recruiting@YourCompany.com.
3. Click Register.
4. Enter the name of your application in the Application Name field. For example: YourCompany Recruiting Application.
5. Click Add Api Key.
6. Make note of the application name, "token" and "secret".

What to do next

You'll require the "token" and "secret" to enable Indeed Apply in Taleo Configuration. See [Enabling Indeed Apply](#).

Enabling Apply with Indeed

Before you start

Career Section administrators must add the Resume Upload block to the general profile flows or job submission flows on which they want the Indeed icon to be displayed.

The administrators can include the Additional Information block as well because it also contains fields that can be populated by information imported from Indeed.

The administrators can add the Website Address field to Candidate Personal Information forms because the field can be filled by information imported from Indeed.

A "token" and "secret" from Indeed are required. See [Registering With Indeed](#).

Configuration > [Career Section] Administration > Profile Import

Here's what to do

1. In the Profile Import Settings section, click Indeed.
2. If the current status is Active, click Deactivate.
3. Click Edit.
4. Paste the API key in the Token field and the "secret" in the Secret field.
5. Click Save.
6. Click Activate.

Results:

If the Resume block is included in general profile or job-specific application flows, the Indeed icon will be displayed when candidates proceed to that step in the flow. The Indeed icon will not be displayed in flows that do not include the Resume block.

Automatic Termination of LinkedIn Session

After a LinkedIn profile is imported, the LinkedIn session is terminated automatically.

In previous releases, when candidates imported their LinkedIn profile into the Oracle Taleo Enterprise Edition system, they were required to read and agree to an agreement explaining that it was their responsibility to sign out of the LinkedIn system (signing out of the Oracle Taleo system did not sign them out of LinkedIn). After submitting their general profile or job submission, they had to sign out of LinkedIn if they wanted to formally end the LinkedIn session. Now, no agreement is displayed and the LinkedIn session is terminated automatically once the LinkedIn profile has been imported into the Oracle Taleo system.

New User Registration Using Third-party Credentials

Visitors to a career section can register (create) a Career Section account (i.e. candidate profile) using third-party credentials such as Google.

Visitors to career sections who click the New User button will be able to create a candidate profile in the same manner, using third-party credentials such as Google, from the New User Registration page. It is an Oracle Taleo best practice to activate this feature, especially in external career sections because it is a great time-saver for candidates.

If the third-party credentials are not linked to a candidate profile in the Taleo customer's career sections, the system verifies if the email address from the third-party application is an email address or user name in a candidate profile in the customer's career sections.

If no duplicate email address is found, the system creates a candidate profile in the career section automatically, using the email address (from the third-party login process) as the user name and generating a password that conforms to the security policies configured for the career section. If a security question was enabled for candidate profiles, the candidate is asked to provide this information.

If a duplicate email address is found in a candidate profile, the system displays the login page from which candidates can log into their account in the Career Section. Visitors select one of two options:

- If candidates select "Yes, I have a Candidate Profile and I would like to associate it to my single sign-on", the third-party account credentials are linked to the candidate profile in the career section. This option enables candidates to later sign into the career section directly (provided the candidates selected "Keep me logged in" or similar setting in the third-party product) by simply clicking the third-party icon on the career section.
- Candidates can choose to create a candidate profile. Thereafter, the third-party account credentials are linked to the new candidate profile in the career section and the candidates can sign into the career section directly (provided the candidates selected "Keep me logged in" or similar setting in the third-party product) by simply clicking the third-party icon on the career section.

Enabling New User Registration Using Third-party Credentials

Before you start

For this solution to work, the Career Section must not be configured for single sign-on (SSO), which usually only affects Internal Career Sections. If SSO is turned on for a Career Section, then the property Display the OpenID Option must be disabled or the visitor will receive error messages.

Here's what to do

1. Click Configuration.
2. In the Career Section section, click Administration.
3. In the Global Security section, click External Career Sections.
4. Click Show next to Default Values.
5. Click Edit next to Sign In.
6. Next to Display the OpenID option, select Yes.

Display the OpenID Option can be set at the global level and at the career section level for external and internal career sections. If the “Allow new users to register in the system” Career Section Sign-on property is set to “No”, then it is recommended that the Display the OpenID Option for the career section also be disabled. This feature is particularly relevant for customers who use Social Sourcing. Candidates who apply for a job through Social Sourcing and who do not exist yet in Taleo Enterprise are directed (via a deep link) to the New User Registration page directly where they can use the Google authentication.

7. Click Save.

What to do next

You must also enable OpenID Authentication for a specific third-party partner if you have not already done this.

Enabling OpenID Authentication for a Specific Third-party Partner

1. Click Configuration.
2. In the Career Section section, click Administration.
3. In the Global Security section, click OpenID Authentication Configuration.
4. Click the provider's code and configure the properties and other values.

13 Metrics

Metrics

Monitoring Career Section Traffic on Job Description Views

Via reporting, it is possible to determine how many candidates and potential candidates per day visit a Career Section and view the job description page.

Tracking can be useful for evaluating the relative popularity of a career section and for determining how many visitors apply for a particular job compared with the number of visitors who simply view the job description.

The system tracks the following information with regard to Job Description hits:

- career section
- career section locale
- job requisition
- date on the job description page
- the number of hits on a job description page.

The hits are tracked every 15 minutes but there is a delay of 48 hours before the data is available in the reporting universe or for integration purposes.

A visitor who displays a Job Description page, navigates to another page and then returns to the Job Description page in the same session is counted only once.

Configuration

Hit tracking is “off” by default at migration and when a new zone is created.

To enable hit tracking, submit a request to Oracle Support to have to setting activated.

Monitoring the Last Career Section Page Accessed by a Candidate

Provides the ability to know where candidates stop submitting their job application and which steps in the process are causing problems.

The ability to track the last page accessed by a candidate when applying for a job allows the organization to create reports identifying bottlenecks in the application process. The information collected is kept for two years in the system.

It is a best practice to activate this feature and to run reports on a monthly basis to identify problems in the application flow and deal with them effectively.

The system tracks the following information with regard to the last Career Section page accessed by a candidate:

- Career Section ID
- Career Section Name
- Application Flow ID
- Application Flow Name
- Candidate ID
- Job Requisition Number
- Application Complete
- Date
- Latest Page Visited (Name)
- Latest Page Visited (Sequence in the application flow)

Configuration

To enable the feature, the *Career Section Latest Page Tracking Activation* private setting must be activated by Taleo.

Tracking Application Flow Page Hits

A modified image tag can be used by customers to track page hits.

When an image tag configured to send tracking code via the application flow header, and a candidate accesses an application flow that has the image tag, the system will send the data to the appropriate party. Three tokens are available to enhance analytics:

- CandidateNumber will capture the candidate number of the candidate into the URL.
- ApplicationNumber will capture the application number of the application. If the candidate is entering a general profile the ApplicationNumber token will not have a value associated to it.
- RandomNumber will be a random number generated by the system on each page utilizing the header.

The URL formatting of the tokens should be as follows:

- {ApplicationNumber}
- {CandidateNumber}
- {RandomNumber}

Additional spaces have been added into the URL for formatting purposes.

```

```

Adding Tracking Code to Application Flow Pages

Before you start

The application flow must be inactive.

The tracking code must be contained in an image tag.

Iframe and Javascript are not supported.

Configuration > [Career Section] Administration > Application Flows

Here's what to do

1. Click the name of an application flow.
2. Click the name of a page.
3. Click Edit next to Page Properties.
4. Click Source in the Page Header RTF editor.
5. Enter tracking code in an `` tag.
Three tokens are available to enhance analytics: {ApplicationNumber}, {CandidateNumber}, {RandomNumber}.
6. Click Source to view header output.
7. Click Save.

14 Product Resource Administration

Resource Administration

The Resource Administration feature allows system administrators to display the ID associated to text appearing on pages of Oracle Taleo Enterprise Edition products in order to modify the text.

Each element of text also called resource, such as fields, buttons, tooltips, links, page titles and sections, has a unique ID associated to it. These IDs can be displayed in the application, in front of each resource, so users can precisely locate and identify a resource they need to modify or override in the application. If an "X" appears at the right of the resource ID, this means that the text was already overridden.

The value of a resource can be composed of units, special characters, and letters. The resource value is not unique, therefore the same text can be used for different resources. Resource values can be modified and updated in the application by system administrators. To make a global change to the value of a resource for all zones, contact your Oracle representative.

Example: The Save button can be used on several pages of the application. Each Save button appearing in the application will have a specific ID, and the value of every Save button will be text Save.

Resource values can be refreshed. This enables system administrators to apply any changes made to the resource values for the customer's custom set of resources. System administrators can block the refresh of the resource value. This allows system administrators to use a testing environment where the actual value of a resource is either chosen or not. This is usually done while performing some temporary testing in a staging zone.

Each product has a specific Resource Administration feature allowing the display of the product's resource IDs. The New Hire Portal Resource Administration is accessed from this URL: <http://yourzonename/newhireportal/ResourceConsole.jss>.

| Product | Administration Menu |
|---|--|
| Career Section Administration | Career Section Administration Menu |
| Career Section | Career Section Administration Menu |
| Central Configuration | SmartOrg Administration Menu |
| Onboarding (Transitions) Administration | Onboarding (Transitions) Administration Menu |
| Onboarding (Transitions) Center | Onboarding (Transitions) Administration Menu |
| Performance Administration | Performance Administration Menu |
| Performance | Performance Administration Menu |
| Recruiting Administration | Recruiting Administration Menu |
| Recruiting Center | Recruiting Administration Menu |

| Product | Administration Menu |
|----------|------------------------------|
| SmartOrg | SmartOrg Administration Menu |

Configuration

| User Type Permission | Description | Location |
|------------------------------|--|---|
| Manage resources | Provides users the ability to refresh resource values, to block resource value refresh, and to force the refresh of resource values. | Configuration > [SmartOrg] Administration > User Types > Functional Domains > Configuration > Resource Management |
| Display resource identifiers | Provides users the ability to display resource IDs using the Show Identifier button in the Resource Administration page. | Configuration > [SmartOrg] Administration > User Types > Functional Domains > Configuration > Resource Management |

Note: To modify resource values for a specific product, user type permissions specific to the product are also required in some cases. To modify Onboarding (Transitions) resource values, for example, users require the permissions described in the previous table and at least one Onboarding (Transitions) permission, for example, "Manage Onboarding (Transitions) processes of all types".

Displaying Resource Identifiers

Before you start

The Display Resource Identifiers user type permission is required.

Configuration > [Product] Administration > Resource Administration

Here's what to do

1. Click Show Identifiers.
2. Close this window.

Results:

Starting with the next page that is displayed, resource IDs will be displayed in front of each element of the application.

Hiding Resource Identifiers

Before you start

Resource Identifiers must be displayed.

The Display Resource Identifiers user type permission is required.

Configuration > [Product] Administration > Resource Administration

Here's what to do

1. Click Hide Identifiers.

2. Close this window.

Results:

Starting with the next page that is loaded, resource IDs will no longer be displayed in front of each element of the application.

Refreshing Resource Values

Before you start

Two user type permissions are required: Manage Resources and Display Resource Identifiers.

Configuration > [Product] Administration > Resource Administration

Here's what to do

1. Click Unblock Refresh.
2. Select the desired type of refresh.
3. Enter the name of the project if necessary.
The project name is associated with revisions made to the customer's custom set of resource values, administered in TexTool application.
4. Click Refresh Values.
5. Close the window.

Results:

The latest value of the resources is displayed.

Blocking Resource Value Refresh

Before you start

Two user type permissions are required: Manage Resources and Display Resource Identifiers.

Configuration > [Product] Administration > Resource Administration

Here's what to do

1. Click Block Refresh.
2. Add a comment.
3. Click Save.
4. Close the window.

Results:

It will no longer be possible to have the application reflect any changes applied to a value.

Unblocking Resource Value Refresh

Before you start

Two user type permissions are required: Manage Resources and Display Resource Identifiers.

Configuration > [Product] Administration > Resource Administration

Here's what to do

1. Click Unblock Refresh.
2. Close the window.

Results:

Any changes applied to resource values will be reflected in the application when refreshing the values.

Changing Career Section Resources

Some commonly used career section resources can be overridden by a Career Section system administrator.

A resource that can be overridden by a system administrator is referred to in this guide as a user-defined label. User-defined labels can be changed in career sections, career portal pages, application flows, and application flow blocks. A user-defined label can contain up to 4,000 bytes.

| Element | Location |
|------------------------|--|
| Career Section | Configuration > [Career Section] Administration > Career Sections > Career Section Name > [Career Portal Pages] Edit User-defined Labels |
| Career Portal Page | Configuration > [Career Section] Administration > Career Sections > Career Section Name > [Career Portal Pages] Click on a Career Portal Page > Edit User-defined labels |
| Application Flow | Configuration > [Career Section] Administration > Application Flows > Application Flow > [Application Flow Properties] Edit User-defined Labels |
| Application Flow Block | Configuration > [Career Section] Administration > Application Flows > Application Flow > Block Name > Edit User-defined Labels |

To see if a resource can be changed manually, system administrators must display the resource identifiers and then view the career section.

In the Career Portal Page Field Identification Number table located in the Appendix, locate the ID number of the field you want to edit, then navigate to the career portal page using the path displayed in the PATH column.

Note: Career portal user-defined labels – any label changes made to the JobSubmissionPrivacyAgreementResources resource group (Configuration > [Career Section] Administration > Career Sections > (career section) > Edit User-defined Labels) will only affect the privacy statement displayed before the login and registration pages. Application flow user-defined labels – any label changes made to the JobSubmissionPrivacyAgreementResources resource group (Configuration > [Career Section] Administration > Application Flows > application flow) > Edit User-defined Labels) will only affect the privacy statement displayed at the beginning of the job submission process.

Changing the Text of a Field in a Career Portal Page

Before you start

The *Access the Career Section administration section* user type permission grants users access to this feature.

Text in tabs, links, fields and buttons appearing in career portal pages can be changed if the text has a product resource identification number.

You need the resource identification number of the field. You can look at the list of IDs in the Appendix or you can display the resource identifiers associated to the field.

Configuration > [Career Section] Administration > Career Sections > Career Section name

Here's what to do

1. Access the career portal page where the field is located.
2. Locate the IDs you wish to modify. You can refine the list by resource number.
3. Click on the resource.
4. Click Edit next to Properties.
5. In the Override field, type the new field label. Maximum of 1,000 characters.
6. Click Save.

Changing the Text of Fields in a Block

The modification of labels in a block consists of the following steps.

1. Displaying resource identifiers associated to each field.
2. Access the career section containing the application flow you wish to modify. Resource IDs are displayed in front of each label.
3. Locate the label you wish to modify and note the resource ID.
4. Changing the text of a field in a block.

Changing the Text of Fields in an Application Flow

The modification of labels in an application flow consists of the following steps.

1. Displaying resource identifiers associated to each field.
2. Access the career section containing the application flow you wish to modify. Resource IDs are displayed in front of each label.
3. Locate the label you wish to modify and note the resource ID.
4. Changing the text of a field in the application flow.

15 Appendix

Career Portal Page Field Identification Numbers

| ID | NAME | TALEO DEFAULT VALUE | LOCATION |
|------|---------------------------|---|--|
| 9323 | ChangePasswordTitle | Change Password | Configuration > [Career Section] Administration > Career Sections > Career Section name > [Career Portal Pages] Show > Access Management |
| 9324 | ChangePasswordDescription | This page allows you to change your password. | Configuration > [Career Section] Administration > Career Sections > Career Section name > [Career Portal Pages] Show > Access Management |
| 9325 | MoreInfo | More info | Configuration > [Career Section] Administration > Career Sections > Career Section name > [Career Portal Pages] Show > Access Management |
| 9326 | MoreInfoTT | Access the contextual online help | Configuration > [Career Section] Administration > Career Sections > Career Section name > [Career Portal Pages] Show > Access Management |
| 9327 | UserName | User Name | Configuration > [Career Section] Administration > Career Sections > Career Section name > [Career Portal Pages] Show > Access Management |
| 9328 | OldPassword | Old Password | Configuration > [Career Section] Administration > Career Sections > Career Section name > [Career Portal Pages] Show > Access Management |
| 9329 | NewPassword | New Password | Configuration > [Career Section] Administration > Career Sections > Career Section name > [Career Portal Pages] Show > Access Management |
| 9330 | ConfirmNewPassword | Confirm New Password | Configuration > [Career Section] Administration > Career Sections > Career Section name > [Career Portal Pages] Show > Access Management |
| 9332 | OKCommand | OK | Configuration > [Career Section] Administration > Career Sections > Career Section name > [Career Portal Pages] Show > Access Management |
| 9333 | OKCommandTT | Save changes and close this window | Configuration > [Career Section] Administration > Career Sections > Career Section name > [Career Portal Pages] Show > Access Management |
| 9335 | PasswordsDiffer | The passwords you typed do not match. Type the same password in both text fields. | Configuration > [Career Section] Administration > Career Sections > Career Section name > [Career Portal Pages] Show > Access Management |
| 9336 | NewPasswordSameAsOldPassw | The password you typed is the same as the old one. Please select a new password. | Configuration > [Career Section] Administration > Career Sections > Career Section name > [Career Portal Pages] Show > Access Management |

| ID | NAME | TALEO DEFAULT VALUE | LOCATION |
|-------|-------------------------|--|--|
| 9337 | PasswordInHistory | You cannot use the last {0} passwords. Please select a different password. | Configuration > [Career Section] Administration > Career Sections > Career Section name > [Career Portal Pages] Show > Access Management |
| 9338 | OldPasswordInvalid | The old password is either missing or invalid. Please try again. | Configuration > [Career Section] Administration > Career Sections > Career Section name > [Career Portal Pages] Show > Access Management |
| 9339 | NewPasswordInvalid | The new password is either missing or invalid. Please try again. | Configuration > [Career Section] Administration > Career Sections > Career Section name > [Career Portal Pages] Show > Access Management |
| 71408 | AccessCode | Access Code | Configuration > [Career Section] Administration > Career Sections > Career Section name > [Career Portal Pages] Show > Access Management |
| 81735 | PasswordMissing | You must enter a new password. | Configuration > [Career Section] Administration > Career Sections > Career Section name > [Career Portal Pages] Show > Access Management |
| 81746 | MandatoryField | Mandatory fields are marked with a red square. | Configuration > [Career Section] Administration > Career Sections > Career Section name > [Career Portal Pages] Show > Access Management |
| 81749 | MandatoryFieldTT | This field is mandatory | Configuration > [Career Section] Administration > Career Sections > Career Section name > [Career Portal Pages] Show > Access Management |
| 97805 | Title1 | Search Tips | Configuration > [Career Section] Administration > Career Sections > Career Section name > [Career Portal Pages] Show > Basic Search > Edit User-defined Labels |
| 97814 | Description1 | You can search jobs by selecting relevant criteria in the drop-down menus. You can also use a job number or a keyword. | Configuration > [Career Section] Administration > Career Sections > Career Section name > [Career Portal Pages] Show > Basic Search > Edit User-defined Labels |
| 97823 | BasicJobSearchPageTitle | Basic Job Search | Configuration > [Career Section] Administration > Career Sections > Career Section name > [Career Portal Pages] Show > Basic Search > Edit User-defined Labels |
| 97832 | BasicJobsearchPageDesc | Specify your job search criteria, then click "Search for Jobs". | Configuration > [Career Section] Administration > Career Sections > Career Section name > [Career Portal Pages] Show > Basic Search > Edit User-defined Labels |
| 97845 | IconLegendTitle | Icon legend | Configuration > [Career Section] Administration > Career Sections > Career Section name > [Career Portal Pages] Show > Basic Search > Edit User-defined Labels |
| 97845 | IconLegendTitle | Icon legend | Configuration > [Career Section] Administration > Career Sections > Career Section name > [Career Portal Pages] Show > Job List > Edit User-defined Labels |
| 97845 | IconLegendTitle | Icon legend | Configuration > [Career Section] Administration > Career Sections > Career Section name > [Career Portal Pages] Show > My Job Cart > Edit User-defined Labels |
| 97845 | IconLegendTitle | Icon legend | Configuration > [Career Section] Administration > Career Sections > Career Section name > [Career Portal Pages] Show > My Referrals > Edit User-defined Labels |

| ID | NAME | TALEO DEFAULT VALUE | LOCATION |
|--------|--------------------------|--|--|
| 97845 | IconLegendTitle | Icon legend | Configuration > [Career Section] Administration > Career Sections > Career Section name > [Career Portal Pages] Show > My Submissions > Edit User-defined Labels |
| 97863 | JobNumber | Job Number | Configuration > [Career Section] Administration > Career Sections > Career Section name > [Career Portal Pages] Show > Basic Search > Edit User-defined Labels |
| 97872 | Keywords | Keywords | Configuration > [Career Section] Administration > Career Sections > Career Section name > [Career Portal Pages] Show > Basic Search > Edit User-defined Labels |
| 97947 | Title2 | Saving searches | Configuration > [Career Section] Administration > Career Sections > Career Section name > [Career Portal Pages] Show > Basic Search > Edit User-defined Labels |
| 97956 | Description2 | You can save the current search for reuse by clicking "Save this Search" at the top of the page. Your searches will be saved in the "My Saved Searches" section, under the "My Jobpage" tab. | Configuration > [Career Section] Administration > Career Sections > Career Section name > [Career Portal Pages] Show > Basic Search > Edit User-defined Labels |
| 97961 | Title3 | Advanced job search | Configuration > [Career Section] Administration > Career Sections > Career Section name > [Career Portal Pages] Show > Basic Search > Edit User-defined Labels |
| 97970 | Description3 | To perform a job search using advanced search criteria, click the "Advanced Search" tab and select the relevant criteria. | Configuration > [Career Section] Administration > Career Sections > Career Section name > [Career Portal Pages] Show > Basic Search > Edit User-defined Labels |
| 100324 | SearchJobsCommand | Search for Jobs | Configuration > [Career Section] Administration > Career Sections > Career Section name > [Career Portal Pages] Show > Basic Search > Edit User-defined Labels |
| 100333 | SearchJobsCommandTT | Search for jobs matching the specified criteria | Configuration > [Career Section] Administration > Career Sections > Career Section name > [Career Portal Pages] Show > Basic Search > Edit User-defined Labels |
| 102495 | PrivacyAgreementAction | Privacy Agreement | Configuration > [Career Section] Administration > Career Sections > Career Section name > Configuration > [Career Section] Administration > Career Sections > Career Section name > [Career Portal Pages] Edit User-defined Labels |
| 102525 | PrivacyAgreementActionTT | View the privacy agreement | Configuration > [Career Section] Administration > Career Sections > Career Section name > [Career Portal Pages] Edit User-defined Labels |
| 102559 | Description3 | To perform a job search using basic search criteria, click the "Basic Search" tab and select the relevant criteria. | Configuration > [Career Section] Administration > Career Sections > Career Section name > [Career Portal Pages] Show > Advanced Search > Edit User-defined Labels |
| 102566 | Title3 | Basic job search | Configuration > [Career Section] Administration > Career Sections > Career Section name > [Career Portal Pages] Show > Advanced Search > Edit User-defined Labels |
| 102603 | Description2 | You can save the current search for reuse by clicking "Save this Search" at the top | Configuration > [Career Section] Administration > Career Sections > Career Section name > [Career Portal Pages] Show > Advanced Search > Edit User-defined Labels |

| ID | NAME | TALEO DEFAULT VALUE | LOCATION |
|--------|----------------------------|--|---|
| | | of the page. Your searches will be saved in the "My Saved Searches" section, under the "My Jobpage" tab. | |
| 102608 | Title2 | Saving searches | Configuration > [Career Section] Administration > Career Sections > Career Section name > [Career Portal Pages] Show > Advanced Search > Edit User-defined Labels |
| 102615 | Description1 | You can search jobs by selecting relevant criteria in the drop-down menus. You can also use a job number or a keyword. | Configuration > [Career Section] Administration > Career Sections > Career Section name > [Career Portal Pages] Show > Advanced Search > Edit User-defined Labels |
| 102622 | Title1 | Search Tips | Configuration > [Career Section] Administration > Career Sections > Career Section name > [Career Portal Pages] Show > Advanced Search > Edit User-defined Labels |
| 103245 | Callout | More information | Configuration > [Career Section] Administration > Career Sections > Career Section name > [Career Portal Pages] Show > Basic Search > Edit User-defined Labels |
| 103245 | Callout | More information | Configuration > [Career Section] Administration > Career Sections > Career Section name > [Career Portal Pages] Show > Job List > Edit User-defined Labels |
| 103245 | Callout | More information | Configuration > [Career Section] Administration > Career Sections > Career Section name > [Career Portal Pages] Show > My Job Cart > Edit User-defined Labels |
| 103245 | Callout | More information | Configuration > [Career Section] Administration > Career Sections > Career Section name > [Career Portal Pages] Show > My Referrals > Edit User-defined Labels |
| 103245 | Callout | More information | Configuration > [Career Section] Administration > Career Sections > Career Section name > [Career Portal Pages] Show > My Submissions > Edit User-defined Labels |
| 103252 | AdvancedJobSearchPageTitle | Advanced Job Search | Configuration > [Career Section] Administration > Career Sections > Career Section name > [Career Portal Pages] Show > Advanced Search > Edit User-defined Labels |
| 103269 | AdvancedJobsearchPageDesc | Specify your job search criteria, then click "Search for Jobs". | Configuration > [Career Section] Administration > Career Sections > Career Section name > [Career Portal Pages] Show > Advanced Search > Edit User-defined Labels |
| 103296 | ResultsPerpage | Results per page | Configuration > [Career Section] Administration > Career Sections > Career Section name > [Career Portal Pages] Show > Basic Search > Edit User-defined Labels |
| 103296 | ResultsPerpage | Results per page | Configuration > [Career Section] Administration > Career Sections > Career Section name > [Career Portal Pages] Show > Job Description > Edit User-defined Labels |
| 103296 | ResultsPerpage | Results per page | Configuration > [Career Section] Administration > Career Sections > Career Section name > [Career Portal Pages] Show > Job List > Edit User-defined Labels |
| 103296 | ResultsPerpage | Results per page | Configuration > [Career Section] Administration > Career Sections > Career Section name > [Career Portal Pages] Show > My Job Cart > Edit User-defined Labels |

| ID | NAME | TALEO DEFAULT VALUE | LOCATION |
|--------|---------------------|---|---|
| 103296 | ResultsPerPage | Results per page | Configuration > [Career Section] Administration > Career Sections > Career Section name > [Career Portal Pages] Show > My Referrals > Edit User-defined Labels |
| 103296 | ResultsPerPage | Results per page | Configuration > [Career Section] Administration > Career Sections > Career Section name > [Career Portal Pages] Show > My Submissions > Edit User-defined Labels |
| 103312 | SearchJobsCommand | Search for Jobs | Configuration > [Career Section] Administration > Career Sections > Career Section name > [Career Portal Pages] Show > Advanced Search > Edit User-defined Labels |
| 103319 | SearchJobsCommandTT | Search for jobs matching the specified criteria | Configuration > [Career Section] Administration > Career Sections > Career Section name > [Career Portal Pages] Show > Advanced Search > Edit User-defined Labels |
| 103326 | ClearCommand | Clear | Configuration > [Career Section] Administration > Career Sections > Career Section name > [Career Portal Pages] Show > Basic Search > Edit User-defined Labels |
| 103335 | ClearCommand | Clear | Configuration > [Career Section] Administration > Career Sections > Career Section name > [Career Portal Pages] Show > Advanced Search > Edit User-defined Labels |
| 103342 | ClearCommandTT | Clear all fields | Configuration > [Career Section] Administration > Career Sections > Career Section name > [Career Portal Pages] Show > Basic Search > Edit User-defined Labels |
| 103351 | ClearCommandTT | Clear all fields | Configuration > [Career Section] Administration > Career Sections > Career Section name > [Career Portal Pages] Show > Advanced Search > Edit User-defined Labels |
| 103630 | SaveThisSearch | Save this Search | Configuration > [Career Section] Administration > Career Sections > Career Section name > [Career Portal Pages] Show > Basic Search > Edit User-defined Labels |
| 103647 | SaveThisSearchTT | Save this search criteria | Configuration > [Career Section] Administration > Career Sections > Career Section name > [Career Portal Pages] Show > Basic Search > Edit User-defined Labels |
| 103677 | SaveThisSearch | Save this Search | Configuration > [Career Section] Administration > Career Sections > Career Section name > [Career Portal Pages] Show > Advanced Search > Edit User-defined Labels |
| 103684 | SaveThisSearchTT | Save this search criteria for later | Configuration > [Career Section] Administration > Career Sections > Career Section name > [Career Portal Pages] Show > Advanced Search > Edit User-defined Labels |
| 103697 | HideCriteria | Hide Search Criteria | Configuration > [Career Section] Administration > Career Sections > Career Section name > [Career Portal Pages] Show > Basic Search > Edit User-defined Labels |
| 103708 | HideCriteria | Hide Search Criteria | Configuration > [Career Section] Administration > Career Sections > Career Section name > [Career Portal Pages] Show > Advanced Search > Edit User-defined Labels |
| 103715 | HideCriteriaTT | Hide the search criteria | Configuration > [Career Section] Administration > Career Sections > Career Section name > [Career Portal Pages] Show > Advanced Search > Edit User-defined Labels |

| ID | NAME | TALEO DEFAULT VALUE | LOCATION |
|--------|-------------------------------|---|---|
| 103727 | HideCriteriaTT | Hide the search criteria | Configuration > [Career Section] Administration > Career Sections > Career Section name > [Career Portal Pages] Show > Basic Search > Edit User-defined Labels |
| 103734 | ShowCriteria | Show Search Criteria | Configuration > [Career Section] Administration > Career Sections > Career Section name > [Career Portal Pages] Show > Basic Search > Edit User-defined Labels |
| 103760 | ShowCriteria | Show Search Criteria | Configuration > [Career Section] Administration > Career Sections > Career Section name > [Career Portal Pages] Show > Advanced Search > Edit User-defined Labels |
| 103767 | ShowCriteriaTT | Show the search criteria | Configuration > [Career Section] Administration > Career Sections > Career Section name > [Career Portal Pages] Show > Advanced Search > Edit User-defined Labels |
| 103776 | ShowCriteriaTT | Show the search criteria | Configuration > [Career Section] Administration > Career Sections > Career Section name > [Career Portal Pages] Show > Basic Search > Edit User-defined Labels |
| 103783 | SearchResults | Search Results | Configuration > [Career Section] Administration > Career Sections > Career Section name > [Career Portal Pages] Show > Basic Search > Edit User-defined Labels |
| 103792 | SearchResults | Search Results | Configuration > [Career Section] Administration > Career Sections > Career Section name > [Career Portal Pages] Show > Advanced Search > Edit User-defined Labels |
| 103885 | AddJobField | Add Job Field | Configuration > [Career Section] Administration > Career Sections > Career Section name > [Career Portal Pages] Show > Basic Search > Edit User-defined Labels |
| 103894 | AddLocation | Add Location | Configuration > [Career Section] Administration > Career Sections > Career Section name > [Career Portal Pages] Show > Basic Search > Edit User-defined Labels |
| 103903 | AddOrganization | Add Organization | Configuration > [Career Section] Administration > Career Sections > Career Section name > [Career Portal Pages] Show > Basic Search > Edit User-defined Labels |
| 104497 | SaveThisSearchPageTitle | Saving Search Queries | Configuration > [Career Section] Administration > Career Sections > Career Section name > [Career Portal Pages] Show > Advanced Search > Edit User-defined Labels |
| 104497 | SaveThisSearchPageTitle | Saving Search Queries | Configuration > [Career Section] Administration > Career Sections > Career Section name > [Career Portal Pages] Show > Basic Search > Edit User-defined Labels |
| 104552 | SaveThisSearchPageDescription | Save the search query so that you do not have to fill in the search criteria in the future when you want to search for similar positions. Enter the search query name below, then click "Save". | Configuration > [Career Section] Administration > Career Sections > Career Section name > [Career Portal Pages] Show > Advanced Search > Edit User-defined Labels |
| 104552 | SaveThisSearchPageDescription | Save the search query so that you do not have to fill in the search criteria in the future when you want to search for similar positions. Enter the | Configuration > [Career Section] Administration > Career Sections > Career Section name > [Career Portal Pages] Show > Basic Search > Edit User-defined Labels |

| ID | NAME | TALEO DEFAULT VALUE | LOCATION |
|--------|-----------------|---|---|
| | | search query name below, then click "Save". | |
| 104561 | SearchName | Search Query Name | Configuration > [Career Section] Administration > Career Sections > Career Section name > [Career Portal Pages] Show > Advanced Search > Edit User-defined Labels |
| 104561 | SearchName | Search Query Name | Configuration > [Career Section] Administration > Career Sections > Career Section name > [Career Portal Pages] Show > Basic Search > Edit User-defined Labels |
| 104570 | SaveCommand | Save | Configuration > [Career Section] Administration > Career Sections > Career Section name > [Career Portal Pages] Show > Advanced Search > Edit User-defined Labels |
| 104570 | SaveCommand | Save | Configuration > [Career Section] Administration > Career Sections > Career Section name > [Career Portal Pages] Show > Basic Search > Edit User-defined Labels |
| 104578 | SaveCommandTT | Save the search query | Configuration > [Career Section] Administration > Career Sections > Career Section name > [Career Portal Pages] Show > Advanced Search > Edit User-defined Labels |
| 104578 | SaveCommandTT | Save the search query | Configuration > [Career Section] Administration > Career Sections > Career Section name > [Career Portal Pages] Show > Basic Search > Edit User-defined Labels |
| 104587 | CancelCommand | Cancel | Configuration > [Career Section] Administration > Career Sections > Career Section name > [Career Portal Pages] Show > Advanced Search > Edit User-defined Labels |
| 104587 | CancelCommand | Cancel | Configuration > [Career Section] Administration > Career Sections > Career Section name > [Career Portal Pages] Show > Basic Search > Edit User-defined Labels |
| 104594 | CancelCommandTT | Cancel the action | Configuration > [Career Section] Administration > Career Sections > Career Section name > [Career Portal Pages] Show > Advanced Search > Edit User-defined Labels |
| 104594 | CancelCommandTT | Cancel the action | Configuration > [Career Section] Administration > Career Sections > Career Section name > [Career Portal Pages] Show > Basic Search > Edit User-defined Labels |
| 104600 | Title1 | Where are my saved searches? | Configuration > [Career Section] Administration > Career Sections > Career Section name > [Career Portal Pages] Show > Advanced Search > Edit User-defined Labels |
| 104600 | Title1 | Where are my saved searches? | Configuration > [Career Section] Administration > Career Sections > Career Section name > [Career Portal Pages] Show > Basic Search > Edit User-defined Labels |
| 104612 | Description1 | The searches are saved in the "My Saved Searches" section under the "My Jobpage" tab. | Configuration > [Career Section] Administration > Career Sections > Career Section name > [Career Portal Pages] Show > Advanced Search > Edit User-defined Labels |
| 104612 | Description1 | The searches are saved in the "My Saved Searches" section under the "My Jobpage" tab. | Configuration > [Career Section] Administration > Career Sections > Career Section name > [Career Portal Pages] Show > Basic Search > Edit User-defined Labels |
| 104621 | Link1 | Access My Saved Searches | Configuration > [Career Section] Administration > Career Sections > Career Section name > [Career Portal Pages] Show > Advanced Search > Edit User-defined Labels |

| ID | NAME | TALEO DEFAULT VALUE | LOCATION |
|--------|---------------------|-------------------------------------|---|
| 104621 | Link1 | Access My Saved Searches | Configuration > [Career Section] Administration > Career Sections > Career Section name > [Career Portal Pages] Show > Basic Search > Edit User-defined Labels |
| 104630 | Link1TT | Access the page "My Saved Searches" | Configuration > [Career Section] Administration > Career Sections > Career Section name > [Career Portal Pages] Show > Advanced Search > Edit User-defined Labels |
| 104630 | Link1TT | Access the page "My Saved Searches" | Configuration > [Career Section] Administration > Career Sections > Career Section name > [Career Portal Pages] Show > Basic Search > Edit User-defined Labels |
| 105059 | UrgentNeedJob | Urgent need job | Configuration > [Career Section] Administration > Career Sections > Career Section name > [Career Portal Pages] Show > Basic Search > Edit User-defined Labels |
| 105059 | UrgentNeedJob | Urgent need job | Configuration > [Career Section] Administration > Career Sections > Career Section name > [Career Portal Pages] Show > Job List > Edit User-defined Labels |
| 105059 | UrgentNeedJob | Urgent need job | Configuration > [Career Section] Administration > Career Sections > Career Section name > [Career Portal Pages] Show > My Job Cart > Edit User-defined Labels |
| 105059 | UrgentNeedJob | Urgent need job | Configuration > [Career Section] Administration > Career Sections > Career Section name > [Career Portal Pages] Show > My Referrals > Edit User-defined Labels |
| 105059 | UrgentNeedJob | Urgent need job | Configuration > [Career Section] Administration > Career Sections > Career Section name > [Career Portal Pages] Show > My Submissions > Edit User-defined Labels |
| 105071 | CompletedSubmission | Completed submission | Configuration > [Career Section] Administration > Career Sections > Career Section name > [Career Portal Pages] Show > Basic Search > Edit User-defined Labels |
| 105071 | CompletedSubmission | Completed submission | Configuration > [Career Section] Administration > Career Sections > Career Section name > [Career Portal Pages] Show > Job List > Edit User-defined Labels |
| 105071 | CompletedSubmission | Completed submission | Configuration > [Career Section] Administration > Career Sections > Career Section name > [Career Portal Pages] Show > My Job Cart > Edit User-defined Labels |
| 105071 | CompletedSubmission | Completed submission | Configuration > [Career Section] Administration > Career Sections > Career Section name > [Career Portal Pages] Show > My Referrals > Edit User-defined Labels |
| 105071 | CompletedSubmission | Completed submission | Configuration > [Career Section] Administration > Career Sections > Career Section name > [Career Portal Pages] Show > My Submissions > Edit User-defined Labels |
| 105086 | JobCart | Job cart | Configuration > [Career Section] Administration > Career Sections > Career Section name > [Career Portal Pages] Show > Basic Search > Edit User-defined Labels |
| 105086 | JobCart | Job cart | Configuration > [Career Section] Administration > Career Sections > Career Section name > [Career Portal Pages] Show > Job List > Edit User-defined Labels |

| ID | NAME | TALEO DEFAULT VALUE | LOCATION |
|--------|-----------------|-----------------------|--|
| 105086 | JobCart | Job cart | Configuration > [Career Section] Administration > Career Sections > Career Section name > [Career Portal Pages] Show > My Job Cart > Edit User-defined Labels |
| 105086 | JobCart | Job cart | Configuration > [Career Section] Administration > Career Sections > Career Section name > [Career Portal Pages] Show > My Referrals > Edit User-defined Labels |
| 105086 | JobCart | Job cart | Configuration > [Career Section] Administration > Career Sections > Career Section name > [Career Portal Pages] Show > My Submissions > Edit User-defined Labels |
| 105095 | AddedToJobCart | Added to the job cart | Configuration > [Career Section] Administration > Career Sections > Career Section name > [Career Portal Pages] Show > Basic Search > Edit User-defined Labels |
| 105095 | AddedToJobCart | Added to the job cart | Configuration > [Career Section] Administration > Career Sections > Career Section name > [Career Portal Pages] Show > Job List > Edit User-defined Labels |
| 105095 | AddedToJobCart | Added to the job cart | Configuration > [Career Section] Administration > Career Sections > Career Section name > [Career Portal Pages] Show > My Job Cart > Edit User-defined Labels |
| 105095 | AddedToJobCart | Added to the job cart | Configuration > [Career Section] Administration > Career Sections > Career Section name > [Career Portal Pages] Show > My Referrals > Edit User-defined Labels |
| 105095 | AddedToJobCart | Added to the job cart | Configuration > [Career Section] Administration > Career Sections > Career Section name > [Career Portal Pages] Show > My Submissions > Edit User-defined Labels |
| 105104 | DraftSubmission | Draft submission | Configuration > [Career Section] Administration > Career Sections > Career Section name > [Career Portal Pages] Show > Basic Search > Edit User-defined Labels |
| 105104 | DraftSubmission | Draft submission | Configuration > [Career Section] Administration > Career Sections > Career Section name > [Career Portal Pages] Show > Job List > Edit User-defined Labels |
| 105104 | DraftSubmission | Draft submission | Configuration > [Career Section] Administration > Career Sections > Career Section name > [Career Portal Pages] Show > My Job Cart > Edit User-defined Labels |
| 105104 | DraftSubmission | Draft submission | Configuration > [Career Section] Administration > Career Sections > Career Section name > [Career Portal Pages] Show > My Referrals > Edit User-defined Labels |
| 105104 | DraftSubmission | Draft submission | Configuration > [Career Section] Administration > Career Sections > Career Section name > [Career Portal Pages] Show > My Submissions > Edit User-defined Labels |
| 105560 | PostingDate | Posting Date | Configuration > [Career Section] Administration > Career Sections > Career Section name > [Career Portal Pages] Show > Basic Search > Edit User-defined Labels |
| 105560 | PostingDate | Posting Date | Configuration > [Career Section] Administration > Career Sections > Career Section name > [Career Portal Pages] Show > Job List > Edit User-defined Labels |

| ID | NAME | TALEO DEFAULT VALUE | LOCATION |
|--------|-----------------|--------------------------------------|---|
| 105560 | PostingDate | Posting Date | Configuration > [Career Section] Administration > Career Sections > Career Section name > [Career Portal Pages] Show > My Job Cart > Edit User-defined Labels |
| 105606 | ReferralBonus | Referral Bonus | Configuration > [Career Section] Administration > Career Sections > Career Section name > [Career Portal Pages] Show > Basic Search > Edit User-defined Labels |
| 105606 | ReferralBonus | Referral Bonus | Configuration > [Career Section] Administration > Career Sections > Career Section name > [Career Portal Pages] Show > Job List > Edit User-defined Labels |
| 105606 | ReferralBonus | Referral Bonus | Configuration > [Career Section] Administration > Career Sections > Career Section name > [Career Portal Pages] Show > My Job Cart > Edit User-defined Labels |
| 105606 | ReferralBonus | Referral Bonus | Configuration > [Career Section] Administration > Career Sections > Career Section name > [Career Portal Pages] Show > My Referrals > Edit User-defined Labels |
| 105606 | ReferralBonus | Referral Bonus | Configuration > [Career Section] Administration > Career Sections > Career Section name > [Career Portal Pages] Show > My Submissions > Edit User-defined Labels |
| 106346 | ResultsPageXOfY | Search Results - Page {0} out of {1} | Configuration > [Career Section] Administration > Career Sections > Career Section name > [Career Portal Pages] Show > Basic Search > Edit User-defined Labels |
| 106361 | Previous | Previous | Configuration > [Career Section] Administration > Career Sections > Career Section name > [Career Portal Pages] Show > Basic Search > Edit User-defined Labels |
| 106361 | Previous | Previous | Configuration > [Career Section] Administration > Career Sections > Career Section name > [Career Portal Pages] Show > Job Description > Edit User-defined Labels |
| 106361 | Previous | Previous | Configuration > [Career Section] Administration > Career Sections > Career Section name > [Career Portal Pages] Show > Job List > Edit User-defined Labels |
| 106361 | Previous | Previous | Configuration > [Career Section] Administration > Career Sections > Career Section name > [Career Portal Pages] Show > My Job Cart > Edit User-defined Labels |
| 106361 | Previous | Previous | Configuration > [Career Section] Administration > Career Sections > Career Section name > [Career Portal Pages] Show > My Referrals > Edit User-defined Labels |
| 106361 | Previous | Previous | Configuration > [Career Section] Administration > Career Sections > Career Section name > [Career Portal Pages] Show > My Submissions > Edit User-defined Labels |
| 106382 | PreviousTT | Go to the previous page | Configuration > [Career Section] Administration > Career Sections > Career Section name > [Career Portal Pages] Show > Basic Search > Edit User-defined Labels |
| 106382 | PreviousTT | Go to the previous page | Configuration > [Career Section] Administration > Career Sections > Career Section name > [Career Portal Pages] Show > Job Description > Edit User-defined Labels |

| ID | NAME | TALEO DEFAULT VALUE | LOCATION |
|--------|------------|-------------------------|---|
| 106382 | PreviousTT | Go to the previous page | Configuration > [Career Section] Administration > Career Sections > Career Section name > [Career Portal Pages] Show > Job List > Edit User-defined Labels |
| 106382 | PreviousTT | Go to the previous page | Configuration > [Career Section] Administration > Career Sections > Career Section name > [Career Portal Pages] Show > My Job Cart > Edit User-defined Labels |
| 106382 | PreviousTT | Go to the previous page | Configuration > [Career Section] Administration > Career Sections > Career Section name > [Career Portal Pages] Show > My Referrals > Edit User-defined Labels |
| 106382 | PreviousTT | Go to the previous page | Configuration > [Career Section] Administration > Career Sections > Career Section name > [Career Portal Pages] Show > My Submissions > Edit User-defined Labels |
| 106391 | Next | Next | Configuration > [Career Section] Administration > Career Sections > Career Section name > [Career Portal Pages] Show > Basic Search > Edit User-defined Labels |
| 106391 | Next | Next | Configuration > [Career Section] Administration > Career Sections > Career Section name > [Career Portal Pages] Show > Job Description > Edit User-defined Labels |
| 106391 | Next | Next | Configuration > [Career Section] Administration > Career Sections > Career Section name > [Career Portal Pages] Show > Job List > Edit User-defined Labels |
| 106391 | Next | Next | Configuration > [Career Section] Administration > Career Sections > Career Section name > [Career Portal Pages] Show > My Job Cart > Edit User-defined Labels |
| 106391 | Next | Next | Configuration > [Career Section] Administration > Career Sections > Career Section name > [Career Portal Pages] Show > My Referrals > Edit User-defined Labels |
| 106391 | Next | Next | Configuration > [Career Section] Administration > Career Sections > Career Section name > [Career Portal Pages] Show > My Submissions > Edit User-defined Labels |
| 106400 | NextTT | Go to the next page | Configuration > [Career Section] Administration > Career Sections > Career Section name > [Career Portal Pages] Show > Basic Search > Edit User-defined Labels |
| 106400 | NextTT | Go to the next page | Configuration > [Career Section] Administration > Career Sections > Career Section name > [Career Portal Pages] Show > Job Description > Edit User-defined Labels |
| 106400 | NextTT | Go to the next page | Configuration > [Career Section] Administration > Career Sections > Career Section name > [Career Portal Pages] Show > Job List > Edit User-defined Labels |
| 106400 | NextTT | Go to the next page | Configuration > [Career Section] Administration > Career Sections > Career Section name > [Career Portal Pages] Show > My Job Cart > Edit User-defined Labels |
| 106400 | NextTT | Go to the next page | Configuration > [Career Section] Administration > Career Sections > Career Section name > [Career Portal Pages] Show > My Referrals > Edit User-defined Labels |

| ID | NAME | TALEO DEFAULT VALUE | LOCATION |
|--------|-----------------------|---------------------------------------|---|
| 106400 | NextTT | Go to the next page | Configuration > [Career Section] Administration > Career Sections > Career Section name > [Career Portal Pages] Show > My Submissions > Edit User-defined Labels |
| 107728 | NoMatchingJobs | No jobs match the specified criteria. | Configuration > [Career Section] Administration > Career Sections > Career Section name > [Career Portal Pages] Show > Basic Search > Edit User-defined Labels |
| 107731 | SortBy | Sort by | Configuration > [Career Section] Administration > Career Sections > Career Section name > [Career Portal Pages] Show > Basic Search > Edit User-defined Labels |
| 107731 | SortBy | Sort by | Configuration > [Career Section] Administration > Career Sections > Career Section name > [Career Portal Pages] Show > Job List > Edit User-defined Labels |
| 107731 | SortBy | Sort by | Configuration > [Career Section] Administration > Career Sections > Career Section name > [Career Portal Pages] Show > My Job Cart > Edit User-defined Labels |
| 107753 | PostingDateVariable | Job Posting: {0} | Configuration > [Career Section] Administration > Career Sections > Career Section name > [Career Portal Pages] Show > Basic Search > Edit User-defined Labels |
| 107753 | PostingDateVariable | Job Posting: {0} | Configuration > [Career Section] Administration > Career Sections > Career Section name > [Career Portal Pages] Show > Job Description > Edit User-defined Labels |
| 107753 | PostingDateVariable | Job Posting: {0} | Configuration > [Career Section] Administration > Career Sections > Career Section name > [Career Portal Pages] Show > Job List > Edit User-defined Labels |
| 107753 | PostingDateVariable | Job Posting: {0} | Configuration > [Career Section] Administration > Career Sections > Career Section name > [Career Portal Pages] Show > My Job Cart > Edit User-defined Labels |
| 107753 | PostingDateVariable | Job Posting: {0} | Configuration > [Career Section] Administration > Career Sections > Career Section name > [Career Portal Pages] Show > My Referrals > Edit User-defined Labels |
| 107753 | PostingDateVariable | Job Posting: {0} | Configuration > [Career Section] Administration > Career Sections > Career Section name > [Career Portal Pages] Show > My Submissions > Edit User-defined Labels |
| 107778 | ReferralBonusVariable | {0} Referral Bonus | Configuration > [Career Section] Administration > Career Sections > Career Section name > [Career Portal Pages] Show > Basic Search > Edit User-defined Labels |
| 107778 | ReferralBonusVariable | {0} Referral Bonus | Configuration > [Career Section] Administration > Career Sections > Career Section name > [Career Portal Pages] Show > Job Description > Edit User-defined Labels |
| 107778 | ReferralBonusVariable | {0} Referral Bonus | Configuration > [Career Section] Administration > Career Sections > Career Section name > [Career Portal Pages] Show > Job List > Edit User-defined Labels |
| 107778 | ReferralBonusVariable | {0} Referral Bonus | Configuration > [Career Section] Administration > Career Sections > Career Section name > [Career Portal Pages] Show > My Job Cart > Edit User-defined Labels |

| ID | NAME | TALEO DEFAULT VALUE | LOCATION |
|--------|-----------------------|--|---|
| 107778 | ReferralBonusVariable | {0} Referral Bonus | Configuration > [Career Section] Administration > Career Sections > Career Section name > [Career Portal Pages] Show > My Referrals > Edit User-defined Labels |
| 107778 | ReferralBonusVariable | {0} Referral Bonus | Configuration > [Career Section] Administration > Career Sections > Career Section name > [Career Portal Pages] Show > My Submissions > Edit User-defined Labels |
| 107807 | ApplyAction | Apply | Configuration > [Career Section] Administration > Career Sections > Career Section name > [Career Portal Pages] Show > Basic Search > Edit User-defined Labels |
| 107807 | ApplyAction | Apply | Configuration > [Career Section] Administration > Career Sections > Career Section name > [Career Portal Pages] Show > Job Description > Edit User-defined Labels |
| 107807 | ApplyAction | Apply | Configuration > [Career Section] Administration > Career Sections > Career Section name > [Career Portal Pages] Show > Job List > Edit User-defined Labels |
| 107807 | ApplyAction | Apply | Configuration > [Career Section] Administration > Career Sections > Career Section name > [Career Portal Pages] Show > My Job Cart > Edit User-defined Labels |
| 107807 | ApplyAction | Apply | Configuration > [Career Section] Administration > Career Sections > Career Section name > [Career Portal Pages] Show > My Referrals > Edit User-defined Labels |
| 107807 | ApplyAction | Apply | Configuration > [Career Section] Administration > Career Sections > Career Section name > [Career Portal Pages] Show > My Submissions > Edit User-defined Labels |
| 107822 | ApplyActionTT | Apply for this position | Configuration > [Career Section] Administration > Career Sections > Career Section name > [Career Portal Pages] Show > Basic Search > Edit User-defined Labels |
| 107822 | ApplyActionTT | Apply for this position | Configuration > [Career Section] Administration > Career Sections > Career Section name > [Career Portal Pages] Show > Job Description > Edit User-defined Labels |
| 107822 | ApplyActionTT | Apply for this position | Configuration > [Career Section] Administration > Career Sections > Career Section name > [Career Portal Pages] Show > Job List > Edit User-defined Labels |
| 107822 | ApplyActionTT | Apply for this position | Configuration > [Career Section] Administration > Career Sections > Career Section name > [Career Portal Pages] Show > My Job Cart > Edit User-defined Labels |
| 107822 | ApplyActionTT | Apply for this position | Configuration > [Career Section] Administration > Career Sections > Career Section name > [Career Portal Pages] Show > My Referrals > Edit User-defined Labels |
| 107822 | ApplyActionTT | Apply for this position | Configuration > [Career Section] Administration > Career Sections > Career Section name > [Career Portal Pages] Show > My Submissions > Edit User-defined Labels |
| 107840 | AddToJobCartAction | Add to Configuration > [Career Section] Administration > Career Sections > Career Section name > [Career Portal Pages] Show > My Job Cart > Edit User-defined Labels | Configuration > [Career Section] Administration > Career Sections > Career Section name > [Career Portal Pages] Show > Basic Search > Edit User-defined Labels |

| ID | NAME | TALEO DEFAULT VALUE | LOCATION |
|--------|----------------------|--|---|
| 107840 | AddToJobCartAction | Add to Configuration > [Career Section] Administration > Career Sections > Career Section name > [Career Portal Pages] Show > My Job Cart > Edit User-defined Labels | Configuration > [Career Section] Administration > Career Sections > Career Section name > [Career Portal Pages] Show > Job Description > Edit User-defined Labels |
| 107840 | AddToJobCartAction | Add to Configuration > [Career Section] Administration > Career Sections > Career Section name > [Career Portal Pages] Show > My Job Cart > Edit User-defined Labels | Configuration > [Career Section] Administration > Career Sections > Career Section name > [Career Portal Pages] Show > Job List > Edit User-defined Labels |
| 107840 | AddToJobCartAction | Add to Configuration > [Career Section] Administration > Career Sections > Career Section name > [Career Portal Pages] Show > My Job Cart > Edit User-defined Labels | Configuration > [Career Section] Administration > Career Sections > Career Section name > [Career Portal Pages] Show > My Job Cart > Edit User-defined Labels |
| 107840 | AddToJobCartAction | Add to Configuration > [Career Section] Administration > Career Sections > Career Section name > [Career Portal Pages] Show > My Job Cart > Edit User-defined Labels | Configuration > [Career Section] Administration > Career Sections > Career Section name > [Career Portal Pages] Show > My Referrals > Edit User-defined Labels |
| 107840 | AddToJobCartAction | Add to Configuration > [Career Section] Administration > Career Sections > Career Section name > [Career Portal Pages] Show > My Job Cart > Edit User-defined Labels | Configuration > [Career Section] Administration > Career Sections > Career Section name > [Career Portal Pages] Show > My Submissions > Edit User-defined Labels |
| 107861 | AddToJobCartActionTT | Add this position to the job cart | Configuration > [Career Section] Administration > Career Sections > Career Section name > [Career Portal Pages] Show > Basic Search > Edit User-defined Labels |
| 107861 | AddToJobCartActionTT | Add this position to the job cart | Configuration > [Career Section] Administration > Career Sections > Career Section name > [Career Portal Pages] Show > Job Description > Edit User-defined Labels |
| 107861 | AddToJobCartActionTT | Add this position to the job cart | Configuration > [Career Section] Administration > Career Sections > Career Section name > [Career Portal Pages] Show > Job List > Edit User-defined Labels |
| 107861 | AddToJobCartActionTT | Add this position to the job cart | Configuration > [Career Section] Administration > Career Sections > Career Section name > [Career Portal Pages] Show > My Job Cart > Edit User-defined Labels |
| 107861 | AddToJobCartActionTT | Add this position to the job cart | Configuration > [Career Section] Administration > Career Sections > Career Section name > [Career Portal Pages] Show > My Referrals > Edit User-defined Labels |
| 107861 | AddToJobCartActionTT | Add this position to the job cart | Configuration > [Career Section] Administration > Career Sections > Career Section name > [Career Portal Pages] Show > My Submissions > Edit User-defined Labels |
| 108003 | ApplyOnlineCommand | Apply Online | Configuration > [Career Section] Administration > Career Sections > Career Section name > [Career Portal Pages] Show > Job Description > Edit User-defined Labels |

| ID | NAME | TALEO DEFAULT VALUE | LOCATION |
|--------|-------------------------|--|---|
| 108012 | ApplyOnlineCommandTT | Apply for this position online | Configuration > [Career Section] Administration > Career Sections > Career Section name > [Career Portal Pages] Show > Job Description > Edit User-defined Labels |
| 108101 | AddToJobCartAction | Add to Configuration > [Career Section] Administration > Career Sections > Career Section name > [Career Portal Pages] Show > My Job Cart > Edit User-defined Labels | Configuration > [Career Section] Administration > Career Sections > Career Section name > [Career Portal Pages] Show > Job Description > Edit User-defined Labels |
| 108117 | AddToJobCartActionTT | Add this position to the job cart | Configuration > [Career Section] Administration > Career Sections > Career Section name > [Career Portal Pages] Show > Job Description > Edit User-defined Labels |
| 108130 | BackAction | Back to prior page | Configuration > [Career Section] Administration > Career Sections > Career Section name > [Career Portal Pages] Show > Job Description > Edit User-defined Labels |
| 108270 | JobPageXOfY | Job {0} out of {1} | Configuration > [Career Section] Administration > Career Sections > Career Section name > [Career Portal Pages] Show > Job Description > Edit User-defined Labels |
| 108894 | Title1 | Send this job to a friend | Configuration > [Career Section] Administration > Career Sections > Career Section name > [Career Portal Pages] Show > Job Description > Edit User-defined Labels |
| 108915 | Description1 | Send this job description to a friend by email. All the relevant details will be included in the message. | Configuration > [Career Section] Administration > Career Sections > Career Section name > [Career Portal Pages] Show > Job Description > Edit User-defined Labels |
| 108952 | Link1 | Send this job to a friend | Configuration > [Career Section] Administration > Career Sections > Career Section name > [Career Portal Pages] Show > Job Description > Edit User-defined Labels |
| 109005 | Title2 | Refer a friend for this job | Configuration > [Career Section] Administration > Career Sections > Career Section name > [Career Portal Pages] Show > Job Description > Edit User-defined Labels |
| 109014 | Description2 | Tell us about a friend who might be interested in this job. All privacy rights will be protected. | Configuration > [Career Section] Administration > Career Sections > Career Section name > [Career Portal Pages] Show > Job Description > Edit User-defined Labels |
| 109023 | Link2 | Refer a friend | Configuration > [Career Section] Administration > Career Sections > Career Section name > [Career Portal Pages] Show > Job Description > Edit User-defined Labels |
| 109032 | Link2TT | Open the form used to refer a friend | Configuration > [Career Section] Administration > Career Sections > Career Section name > [Career Portal Pages] Show > Job Description > Edit User-defined Labels |
| 109042 | JobDescriptionPageTitle | Job Description - {0} | Configuration > [Career Section] Administration > Career Sections > Career Section name > [Career Portal Pages] Show > Job Description > Edit User-defined Labels |
| 109192 | JobDescriptionPageDesc | This page displays a job description and allows you to apply for the job online. You can also send this job description to a friend and | Configuration > [Career Section] Administration > Career Sections > Career Section name > [Career Portal Pages] Show > Job Description > Edit User-defined Labels |

| ID | NAME | TALEO DEFAULT VALUE | LOCATION |
|--------|------------------------------|---|---|
| | | refer someone who could be interested in this position. | |
| 109335 | SubmissionsPageXOfY | My Submissions - Page {0} of {1} | Configuration > [Career Section] Administration > Career Sections > Career Section name > [Career Portal Pages] Show > My Submissions > Edit User-defined Labels |
| 109403 | MySubmissionsPageTitle | My Submissions | Configuration > [Career Section] Administration > Career Sections > Career Section name > [Career Portal Pages] Show > My Submissions > Edit User-defined Labels |
| 109409 | MySubmissionsPageDesc | This page displays all relevant details related to your draft and completed submissions. | Configuration > [Career Section] Administration > Career Sections > Career Section name > [Career Portal Pages] Show > My Submissions > Edit User-defined Labels |
| 109616 | WithdrawAllSubmissionsAction | Withdraw All Submissions | Configuration > [Career Section] Administration > Career Sections > Career Section name > [Career Portal Pages] Show > My Submissions > Edit User-defined Labels |
| 109672 | SubmissionsHighlighted | Highlighted submissions have been updated since your last login. | Configuration > [Career Section] Administration > Career Sections > Career Section name > [Career Portal Pages] Show > My Submissions > Edit User-defined Labels |
| 111091 | Title3 | Refer a friend | Configuration > [Career Section] Administration > Career Sections > Career Section name > [Career Portal Pages] Show > My Submissions > Edit User-defined Labels |
| 111100 | Description3 | Tell us about a friend who might be interested in working for our organization. All privacy rights will be protected. | Configuration > [Career Section] Administration > Career Sections > Career Section name > [Career Portal Pages] Show > My Submissions > Edit User-defined Labels |
| 111114 | Link3 | Submit a friend's profile | Configuration > [Career Section] Administration > Career Sections > Career Section name > [Career Portal Pages] Show > My Submissions > Edit User-defined Labels |
| 111123 | Link3TT | Open the form used to refer a friend | Configuration > [Career Section] Administration > Career Sections > Career Section name > [Career Portal Pages] Show > My Submissions > Edit User-defined Labels |
| 111132 | Title2 | Jobs Matching My Profile | Configuration > [Career Section] Administration > Career Sections > Career Section name > [Career Portal Pages] Show > My Submissions > Edit User-defined Labels |
| 114233 | Description2 | Take a look at jobs currently available within our organization that match your professional skills and interests. | Configuration > [Career Section] Administration > Career Sections > Career Section name > [Career Portal Pages] Show > My Submissions > Edit User-defined Labels |
| 114258 | Link2 | View jobs matching my profile | Configuration > [Career Section] Administration > Career Sections > Career Section name > [Career Portal Pages] Show > My Submissions > Edit User-defined Labels |
| 114297 | Link2TT | Access the list of jobs matching the candidate's profile | Configuration > [Career Section] Administration > Career Sections > Career Section name > [Career Portal Pages] Show > My Submissions > Edit User-defined Labels |
| 115085 | DeleteAllSearchesAction | Delete All | Configuration > [Career Section] Administration > Career Sections > Career Section name > [Career Portal Pages] Show > My Saved Searches > Edit User-defined Labels |

| ID | NAME | TALEO DEFAULT VALUE | LOCATION |
|--------|----------------------------|--|---|
| 115101 | DeleteAllSearchesActionTT | Delete all searches saved in this page | Configuration > [Career Section] Administration > Career Sections > Career Section name > [Career Portal Pages] Show > My Saved Searches > Edit User-defined Labels |
| 115116 | MySavedSearchesPageTitle | My Saved Searches | Configuration > [Career Section] Administration > Career Sections > Career Section name > [Career Portal Pages] Show > My Saved Searches > Edit User-defined Labels |
| 115142 | MySavedSearchesPageDesc | This page displays all the job searches you have saved previously. | Configuration > [Career Section] Administration > Career Sections > Career Section name > [Career Portal Pages] Show > My Saved Searches > Edit User-defined Labels |
| 115234 | Title4 | Saving searches | Configuration > [Career Section] Administration > Career Sections > Career Section name > [Career Portal Pages] Show > My Saved Searches > Edit User-defined Labels |
| 115243 | Description4 | You can save a maximum of five searches at a time. Once this number is reached, you must delete a saved search to be able to save a new one. | Configuration > [Career Section] Administration > Career Sections > Career Section name > [Career Portal Pages] Show > My Saved Searches > Edit User-defined Labels |
| 115289 | DeleteAction | Delete | Configuration > [Career Section] Administration > Career Sections > Career Section name > [Career Portal Pages] Show > My Saved Searches > Edit User-defined Labels |
| 115301 | DeleteActionTT | Delete this saved search | Configuration > [Career Section] Administration > Career Sections > Career Section name > [Career Portal Pages] Show > My Saved Searches > Edit User-defined Labels |
| 115397 | MyReferralsPageTitle | My Referrals | Configuration > [Career Section] Administration > Career Sections > Career Section name > [Career Portal Pages] Show > My Referrals > Edit User-defined Labels |
| 115406 | MyReferralsPageDescription | This page displays all candidates you have referred to our company. | Configuration > [Career Section] Administration > Career Sections > Career Section name > [Career Portal Pages] Show > My Referrals > Edit User-defined Labels |
| 140157 | ImportantCorrespondance | Important correspondence | Configuration > [Career Section] Administration > Career Sections > Career Section name > [Career Portal Pages] Show > Basic Search > Edit User-defined Labels |
| 140157 | ImportantCorrespondance | Important correspondence | Configuration > [Career Section] Administration > Career Sections > Career Section name > [Career Portal Pages] Show > Job List > Edit User-defined Labels |
| 140157 | ImportantCorrespondance | Important correspondence | Configuration > [Career Section] Administration > Career Sections > Career Section name > [Career Portal Pages] Show > My Job Cart > Edit User-defined Labels |
| 140157 | ImportantCorrespondance | Important correspondence | Configuration > [Career Section] Administration > Career Sections > Career Section name > [Career Portal Pages] Show > My Referrals > Edit User-defined Labels |
| 140157 | ImportantCorrespondance | Important correspondence | Configuration > [Career Section] Administration > Career Sections > Career Section name > [Career Portal Pages] Show > My Submissions > Edit User-defined Labels |
| 140465 | FromVariable | From: {0} | Configuration > [Career Section] Administration > Career Sections > Career Section name > [Career Portal Pages] Show > My Submissions > Edit User-defined Labels |

| ID | NAME | TALEO DEFAULT VALUE | LOCATION |
|--------|---------------------------|---|---|
| 140490 | SentDateVariable | Sent date: {0} | Configuration > [Career Section] Administration > Career Sections > Career Section name > [Career Portal Pages] Show > My Submissions > Edit User-defined Labels |
| 140499 | PrintableFormatAction | Printable Format | Configuration > [Career Section] Administration > Career Sections > Career Section name > [Career Portal Pages] Show > My Submissions > Edit User-defined Labels |
| 140535 | DeleteAction | Delete | Configuration > [Career Section] Administration > Career Sections > Career Section name > [Career Portal Pages] Show > My Submissions > Edit User-defined Labels |
| 140550 | DeleteActionTT | Delete this message | Configuration > [Career Section] Administration > Career Sections > Career Section name > [Career Portal Pages] Show > My Submissions > Edit User-defined Labels |
| 140595 | UpdatedCapitals | UPDATED | Configuration > [Career Section] Administration > Career Sections > Career Section name > [Career Portal Pages] Show > My Submissions > Edit User-defined Labels |
| 141756 | Link1TT | Send the job description to a friend by email | Configuration > [Career Section] Administration > Career Sections > Career Section name > [Career Portal Pages] Show > Job Description > Edit User-defined Labels |
| 142603 | LastRunVariable | Last run: {0} | Configuration > [Career Section] Administration > Career Sections > Career Section name > [Career Portal Pages] Show > My Saved Searches > Edit User-defined Labels |
| 142621 | JobOpeningsVariable | {0} Job Openings | Configuration > [Career Section] Administration > Career Sections > Career Section name > [Career Portal Pages] Show > My Saved Searches > Edit User-defined Labels |
| 142630 | NoJobOpenings | No Job Openings | Configuration > [Career Section] Administration > Career Sections > Career Section name > [Career Portal Pages] Show > My Saved Searches > Edit User-defined Labels |
| 142641 | EmailNotificationVariable | Email Notification: {0} | Configuration > [Career Section] Administration > Career Sections > Career Section name > [Career Portal Pages] Show > My Saved Searches > Edit User-defined Labels |
| 143073 | All | All | Configuration > [Career Section] Administration > Career Sections > Career Section name > [Career Portal Pages] Show > Basic Search > Edit User-defined Labels |
| 143082 | All | All | Configuration > [Career Section] Administration > Career Sections > Career Section name > [Career Portal Pages] Show > Advanced Search > Edit User-defined Labels |
| 143085 | AddJobField | Add Job Field | Configuration > [Career Section] Administration > Career Sections > Career Section name > [Career Portal Pages] Show > Advanced Search > Edit User-defined Labels |
| 143088 | AddLocation | Add Location | Configuration > [Career Section] Administration > Career Sections > Career Section name > [Career Portal Pages] Show > Advanced Search > Edit User-defined Labels |
| 143091 | AddOrganization | Add Organization | Configuration > [Career Section] Administration > Career Sections > Career Section name > [Career Portal Pages] Show > Advanced Search > Edit User-defined Labels |

| ID | NAME | TALEO DEFAULT VALUE | LOCATION |
|--------|-------------------|---------------------|---|
| 143094 | JobNumber | Job Number | Configuration > [Career Section] Administration > Career Sections > Career Section name > [Career Portal Pages] Show > Advanced Search > Edit User-defined Labels |
| 143097 | Keywords | Keywords | Configuration > [Career Section] Administration > Career Sections > Career Section name > [Career Portal Pages] Show > Advanced Search > Edit User-defined Labels |
| 143112 | JobField | Job Field | Configuration > [Career Section] Administration > Career Sections > Career Section name > [Career Portal Pages] Show > Basic Search > Edit User-defined Labels |
| 143123 | JobField | Job Field | Configuration > [Career Section] Administration > Career Sections > Career Section name > [Career Portal Pages] Show > Advanced Search > Edit User-defined Labels |
| 143126 | Location | Location | Configuration > [Career Section] Administration > Career Sections > Career Section name > [Career Portal Pages] Show > Basic Search > Edit User-defined Labels |
| 143135 | Location | Location | Configuration > [Career Section] Administration > Career Sections > Career Section name > [Career Portal Pages] Show > Advanced Search > Edit User-defined Labels |
| 143138 | Organization | Organization | Configuration > [Career Section] Administration > Career Sections > Career Section name > [Career Portal Pages] Show > Basic Search > Edit User-defined Labels |
| 143147 | Organization | Organization | Configuration > [Career Section] Administration > Career Sections > Career Section name > [Career Portal Pages] Show > Advanced Search > Edit User-defined Labels |
| 143150 | AddJobFieldTT | Add a job field | Configuration > [Career Section] Administration > Career Sections > Career Section name > [Career Portal Pages] Show > Basic Search > Edit User-defined Labels |
| 143163 | AddJobFieldTT | Add a job field | Configuration > [Career Section] Administration > Career Sections > Career Section name > [Career Portal Pages] Show > Advanced Search > Edit User-defined Labels |
| 143166 | AddLocationTT | Add a location | Configuration > [Career Section] Administration > Career Sections > Career Section name > [Career Portal Pages] Show > Basic Search > Edit User-defined Labels |
| 143179 | AddOrganizationTT | Add an organization | Configuration > [Career Section] Administration > Career Sections > Career Section name > [Career Portal Pages] Show > Basic Search > Edit User-defined Labels |
| 143192 | AddOrganizationTT | Add an organization | Configuration > [Career Section] Administration > Career Sections > Career Section name > [Career Portal Pages] Show > Advanced Search > Edit User-defined Labels |
| 143195 | AddLocationTT | Add a location | Configuration > [Career Section] Administration > Career Sections > Career Section name > [Career Portal Pages] Show > Advanced Search > Edit User-defined Labels |
| 143847 | JobTitle | Job Title | Configuration > [Career Section] Administration > Career Sections > Career Section name > [Career Portal Pages] Show > Basic Search > Edit User-defined Labels |

| ID | NAME | TALEO DEFAULT VALUE | LOCATION |
|--------|----------------|---|---|
| 143847 | JobTitle | Job Title | Configuration > [Career Section] Administration > Career Sections > Career Section name > [Career Portal Pages] Show > Job List > Edit User-defined Labels |
| 143847 | JobTitle | Job Title | Configuration > [Career Section] Administration > Career Sections > Career Section name > [Career Portal Pages] Show > My Job Cart > Edit User-defined Labels |
| 143856 | Schedule | Schedule | Configuration > [Career Section] Administration > Career Sections > Career Section name > [Career Portal Pages] Show > Basic Search > Edit User-defined Labels |
| 143856 | Schedule | Schedule | Configuration > [Career Section] Administration > Career Sections > Career Section name > [Career Portal Pages] Show > Job List > Edit User-defined Labels |
| 143856 | Schedule | Schedule | Configuration > [Career Section] Administration > Career Sections > Career Section name > [Career Portal Pages] Show > My Job Cart > Edit User-defined Labels |
| 143865 | Location | Location | Configuration > [Career Section] Administration > Career Sections > Career Section name > [Career Portal Pages] Show > Basic Search > Edit User-defined Labels |
| 143865 | Location | Location | Configuration > [Career Section] Administration > Career Sections > Career Section name > [Career Portal Pages] Show > Job List > Edit User-defined Labels |
| 143865 | Location | Location | Configuration > [Career Section] Administration > Career Sections > Career Section name > [Career Portal Pages] Show > My Job Cart > Edit User-defined Labels |
| 143874 | Relevance | Relevance | Configuration > [Career Section] Administration > Career Sections > Career Section name > [Career Portal Pages] Show > Basic Search > Edit User-defined Labels |
| 143874 | Relevance | Relevance | Configuration > [Career Section] Administration > Career Sections > Career Section name > [Career Portal Pages] Show > Job List > Edit User-defined Labels |
| 143874 | Relevance | Relevance | Configuration > [Career Section] Administration > Career Sections > Career Section name > [Career Portal Pages] Show > My Job Cart > Edit User-defined Labels |
| 143885 | NoMatchingJobs | No jobs match the specified criteria. | Configuration > [Career Section] Administration > Career Sections > Career Section name > [Career Portal Pages] Show > Advanced Search > Edit User-defined Labels |
| 143888 | JobTitleTT | View the description of this job: "{0}" ({1}) | Configuration > [Career Section] Administration > Career Sections > Career Section name > [Career Portal Pages] Show > Basic Search > Edit User-defined Labels |
| 143888 | JobTitleTT | View the description of this job: "{0}" ({1}) | Configuration > [Career Section] Administration > Career Sections > Career Section name > [Career Portal Pages] Show > Job Description > Edit User-defined Labels |
| 143888 | JobTitleTT | View the description of this job: "{0}" ({1}) | Configuration > [Career Section] Administration > Career Sections > Career Section name > [Career Portal Pages] Show > Job List > Edit User-defined Labels |

| ID | NAME | TALEO DEFAULT VALUE | LOCATION |
|--------|-----------------|---|---|
| 143888 | JobTitleTT | View the description of this job: "{0}" ({1}) | Configuration > [Career Section] Administration > Career Sections > Career Section name > [Career Portal Pages] Show > My Job Cart > Edit User-defined Labels |
| 143888 | JobTitleTT | View the description of this job: "{0}" ({1}) | Configuration > [Career Section] Administration > Career Sections > Career Section name > [Career Portal Pages] Show > My Referrals > Edit User-defined Labels |
| 143888 | JobTitleTT | View the description of this job: "{0}" ({1}) | Configuration > [Career Section] Administration > Career Sections > Career Section name > [Career Portal Pages] Show > My Submissions > Edit User-defined Labels |
| 143905 | MoreLocations | More... | Configuration > [Career Section] Administration > Career Sections > Career Section name > [Career Portal Pages] Show > Basic Search > Edit User-defined Labels |
| 143905 | MoreLocations | More... | Configuration > [Career Section] Administration > Career Sections > Career Section name > [Career Portal Pages] Show > Job Description > Edit User-defined Labels |
| 143905 | MoreLocations | More... | Configuration > [Career Section] Administration > Career Sections > Career Section name > [Career Portal Pages] Show > Job List > Edit User-defined Labels |
| 143905 | MoreLocations | More... | Configuration > [Career Section] Administration > Career Sections > Career Section name > [Career Portal Pages] Show > My Job Cart > Edit User-defined Labels |
| 143905 | MoreLocations | More... | Configuration > [Career Section] Administration > Career Sections > Career Section name > [Career Portal Pages] Show > My Referrals > Edit User-defined Labels |
| 143905 | MoreLocations | More... | Configuration > [Career Section] Administration > Career Sections > Career Section name > [Career Portal Pages] Show > My Submissions > Edit User-defined Labels |
| 143917 | MoreLocationsTT | Position available in other locations: {0} | Configuration > [Career Section] Administration > Career Sections > Career Section name > [Career Portal Pages] Show > Basic Search > Edit User-defined Labels |
| 143917 | MoreLocationsTT | Position available in other locations: {0} | Configuration > [Career Section] Administration > Career Sections > Career Section name > [Career Portal Pages] Show > Job Description > Edit User-defined Labels |
| 143917 | MoreLocationsTT | Position available in other locations: {0} | Configuration > [Career Section] Administration > Career Sections > Career Section name > [Career Portal Pages] Show > Job List > Edit User-defined Labels |
| 143917 | MoreLocationsTT | Position available in other locations: {0} | Configuration > [Career Section] Administration > Career Sections > Career Section name > [Career Portal Pages] Show > My Job Cart > Edit User-defined Labels |
| 143917 | MoreLocationsTT | Position available in other locations: {0} | Configuration > [Career Section] Administration > Career Sections > Career Section name > [Career Portal Pages] Show > My Referrals > Edit User-defined Labels |
| 143917 | MoreLocationsTT | Position available in other locations: {0} | Configuration > [Career Section] Administration > Career Sections > Career Section name > [Career Portal Pages] Show > My Submissions > Edit User-defined Labels |

| ID | NAME | TALEO DEFAULT VALUE | LOCATION |
|--------|------------------------|---------------------|---|
| 143926 | AddedToJobCartAction | Added to Job cart | Configuration > [Career Section] Administration > Career Sections > Career Section name > [Career Portal Pages] Show > Basic Search > Edit User-defined Labels |
| 143926 | AddedToJobCartAction | Added to Job cart | Configuration > [Career Section] Administration > Career Sections > Career Section name > [Career Portal Pages] Show > Job Description > Edit User-defined Labels |
| 143926 | AddedToJobCartAction | Added to Job cart | Configuration > [Career Section] Administration > Career Sections > Career Section name > [Career Portal Pages] Show > Job List > Edit User-defined Labels |
| 143926 | AddedToJobCartAction | Added to Job cart | Configuration > [Career Section] Administration > Career Sections > Career Section name > [Career Portal Pages] Show > My Job Cart > Edit User-defined Labels |
| 143926 | AddedToJobCartAction | Added to Job cart | Configuration > [Career Section] Administration > Career Sections > Career Section name > [Career Portal Pages] Show > My Referrals > Edit User-defined Labels |
| 143926 | AddedToJobCartAction | Added to Job cart | Configuration > [Career Section] Administration > Career Sections > Career Section name > [Career Portal Pages] Show > My Submissions > Edit User-defined Labels |
| 143935 | AddedToJobCartActionTT | Access the job cart | Configuration > [Career Section] Administration > Career Sections > Career Section name > [Career Portal Pages] Show > Basic Search > Edit User-defined Labels |
| 143935 | AddedToJobCartActionTT | Access the job cart | Configuration > [Career Section] Administration > Career Sections > Career Section name > [Career Portal Pages] Show > Job Description > Edit User-defined Labels |
| 143935 | AddedToJobCartActionTT | Access the job cart | Configuration > [Career Section] Administration > Career Sections > Career Section name > [Career Portal Pages] Show > Job List > Edit User-defined Labels |
| 143935 | AddedToJobCartActionTT | Access the job cart | Configuration > [Career Section] Administration > Career Sections > Career Section name > [Career Portal Pages] Show > My Job Cart > Edit User-defined Labels |
| 143935 | AddedToJobCartActionTT | Access the job cart | Configuration > [Career Section] Administration > Career Sections > Career Section name > [Career Portal Pages] Show > My Referrals > Edit User-defined Labels |
| 143935 | AddedToJobCartActionTT | Access the job cart | Configuration > [Career Section] Administration > Career Sections > Career Section name > [Career Portal Pages] Show > My Submissions > Edit User-defined Labels |
| 143946 | JobID | Job Number: | Configuration > [Career Section] Administration > Career Sections > Career Section name > [Career Portal Pages] Show > Basic Search > Edit User-defined Labels |
| 143946 | JobID | Job Number: | Configuration > [Career Section] Administration > Career Sections > Career Section name > [Career Portal Pages] Show > Job Description > Edit User-defined Labels |
| 143946 | JobID | Job Number: | Configuration > [Career Section] Administration > Career Sections > Career Section name > [Career Portal Pages] Show > Job List > Edit User-defined Labels |

| ID | NAME | TALEO DEFAULT VALUE | LOCATION |
|--------|-------------------------------|---|---|
| 143946 | JobID | Job Number: | Configuration > [Career Section] Administration > Career Sections > Career Section name > [Career Portal Pages] Show > My Job Cart > Edit User-defined Labels |
| 143946 | JobID | Job Number: | Configuration > [Career Section] Administration > Career Sections > Career Section name > [Career Portal Pages] Show > My Referrals > Edit User-defined Labels |
| 143946 | JobID | Job Number: | Configuration > [Career Section] Administration > Career Sections > Career Section name > [Career Portal Pages] Show > My Submissions > Edit User-defined Labels |
| 143966 | ResultsPageXOfY | Search Results - Page {0} out of {1} | Configuration > [Career Section] Administration > Career Sections > Career Section name > [Career Portal Pages] Show > Advanced Search > Edit User-defined Labels |
| 147349 | JobsMatchingMyProfilePageTitl | Jobs Matching My Profile | Configuration > [Career Section] Administration > Career Sections > Career Section name > [Career Portal Pages] Show > Basic Search > Edit User-defined Labels |
| 147352 | NoMatchingJobs | There are currently no jobs matching your employment profile. | Configuration > [Career Section] Administration > Career Sections > Career Section name > [Career Portal Pages] Show > Basic Search > Edit User-defined Labels |
| 147392 | NoJobsToDisplay | There are currently no jobs available. | Configuration > [Career Section] Administration > Career Sections > Career Section name > [Career Portal Pages] Show > Job List > Edit User-defined Labels |
| 147409 | EmptyJobCart | The job cart is currently empty. | Configuration > [Career Section] Administration > Career Sections > Career Section name > [Career Portal Pages] Show > My Job Cart > Edit User-defined Labels |
| 147426 | NoReferralsToDisplay | There are currently no referrals. | Configuration > [Career Section] Administration > Career Sections > Career Section name > [Career Portal Pages] Show > My Referrals > Edit User-defined Labels |
| 147907 | RemoveLocation | Remove Location | Configuration > [Career Section] Administration > Career Sections > Career Section name > [Career Portal Pages] Show > Basic Search > Edit User-defined Labels |
| 147916 | RemoveLocation | Remove Location | Configuration > [Career Section] Administration > Career Sections > Career Section name > [Career Portal Pages] Show > Advanced Search > Edit User-defined Labels |
| 147919 | RemoveLocationTT | Remove this location from the search criteria: {0} | Configuration > [Career Section] Administration > Career Sections > Career Section name > [Career Portal Pages] Show > Basic Search > Edit User-defined Labels |
| 147936 | RemoveJobField | Remove Job Field | Configuration > [Career Section] Administration > Career Sections > Career Section name > [Career Portal Pages] Show > Basic Search > Edit User-defined Labels |
| 147947 | RemoveJobField | Remove Job Field | Configuration > [Career Section] Administration > Career Sections > Career Section name > [Career Portal Pages] Show > Advanced Search > Edit User-defined Labels |
| 147950 | RemoveLocationTT | Remove this location from the search criteria: {0} | Configuration > [Career Section] Administration > Career Sections > Career Section name > [Career Portal Pages] Show > Advanced Search > Edit User-defined Labels |

| ID | NAME | TALEO DEFAULT VALUE | LOCATION |
|--------|-----------------------|---|--|
| 147961 | RemoveJobFieldTT | Remove this job field from the search criteria: {0} | Configuration > [Career Section] Administration > Career Sections > Career Section name > [Career Portal Pages] Show > Basic Search > Edit User-defined Labels |
| 155032 | MessagesPageXOfY | Messages - Page {0} of {1} | Configuration > [Career Section] Administration > Career Sections > Career Section name > [Career Portal Pages] Show > My Submissions > Edit User-defined Labels |
| 155098 | JobStatusVariable | Job status:{0} | Configuration > [Career Section] Administration > Career Sections > Career Section name > [Career Portal Pages] Show > Basic Search > Edit User-defined Labels |
| 155098 | JobStatusVariable | Job status:{0} | Configuration > [Career Section] Administration > Career Sections > Career Section name > [Career Portal Pages] Show > Job Description > Edit User-defined Labels |
| 155098 | JobStatusVariable | Job status:{0} | Configuration > [Career Section] Administration > Career Sections > Career Section name > [Career Portal Pages] Show > Job List > Edit User-defined Labels |
| 155098 | JobStatusVariable | Job status:{0} | Configuration > [Career Section] Administration > Career Sections > Career Section name > [Career Portal Pages] Show > My Job Cart > Edit User-defined Labels |
| 155098 | JobStatusVariable | Job status:{0} | Configuration > [Career Section] Administration > Career Sections > Career Section name > [Career Portal Pages] Show > My Referrals > Edit User-defined Labels |
| 155098 | JobStatusVariable | Job status:{0} | Configuration > [Career Section] Administration > Career Sections > Career Section name > [Career Portal Pages] Show > My Submissions > Edit User-defined Labels |
| 155853 | PrivacyAgreementTitle | Privacy Agreement | Configuration > [Career Section] Administration > Career Sections > Career Section name > [Career Portal Pages] Edit User-defined Labels Pages] Edit User-defined Labels |
| 155874 | PrivacyAgreementDesc | Please read the privacy agreement stated below carefully and accept or decline it by selecting the relevant option at the bottom of the page. | Configuration > [Career Section] Administration > Career Sections > Career Section name > [Career Portal Pages] Edit User-defined Labels |
| 155891 | SelectLanguage | Select a language | Configuration > [Career Section] Administration > Career Sections > Career Section name > [Career Portal Pages] Edit User-defined Labels |
| 155900 | IDecline | I Decline | Configuration > [Career Section] Administration > Career Sections > Career Section name > [Career Portal Pages] Edit User-defined Labels |
| 155909 | IAccept | I Accept | Configuration > [Career Section] Administration > Career Sections > Career Section name > [Career Portal Pages] Edit User-defined Labels |
| 155918 | CancelCommandTT | Cancel the action | Configuration > [Career Section] Administration > Career Sections > Career Section name > [Career Portal Pages] Edit User-defined Labels |
| 155921 | CancelCommand | Cancel | Configuration > [Career Section] Administration > Career Sections > Career Section name > [Career Portal Pages] Edit User-defined Labels |

| ID | NAME | TALEO DEFAULT VALUE | LOCATION |
|--------|---------------------|---|---|
| 155924 | ContinueCommand | Continue | Configuration > [Career Section] Administration > Career Sections > Career Section name > [Career Portal Pages] Edit User-defined Labels |
| 155937 | ContinueCommandTT | Go to next step | Configuration > [Career Section] Administration > Career Sections > Career Section name > [Career Portal Pages] Edit User-defined Labels |
| 155940 | BackAction | Back | Configuration > [Career Section] Administration > Career Sections > Career Section name > [Career Portal Pages] Edit User-defined Labels |
| 155943 | BackActionTT | Back to the previous page | Configuration > [Career Section] Administration > Career Sections > Career Section name > [Career Portal Pages] Edit User-defined Labels |
| 155946 | PrintableFormat | Printable Format | Configuration > [Career Section] Administration > Career Sections > Career Section name > [Career Portal Pages] Edit User-defined Labels |
| 155955 | PrintableFormatTT | View a printable version of the privacy agreement | Configuration > [Career Section] Administration > Career Sections > Career Section name > [Career Portal Pages] Edit User-defined Labels |
| 157402 | ZipPostalCodeRadius | Zip/Postal Code Radius | Configuration > [Career Section] Administration > Career Sections > Career Section name > [Career Portal Pages] Show > Basic Search > Edit User-defined Labels |
| 157411 | DistanceFromCode | Distance from Zip/Postal Code | Configuration > [Career Section] Administration > Career Sections > Career Section name > [Career Portal Pages] Show > Basic Search > Edit User-defined Labels |
| 157420 | ZipPostalCode | Zip/Postal Code | Configuration > [Career Section] Administration > Career Sections > Career Section name > [Career Portal Pages] Show > Basic Search > Edit User-defined Labels |
| 157429 | Miles | Miles | Configuration > [Career Section] Administration > Career Sections > Career Section name > [Career Portal Pages] Show > Basic Search > Edit User-defined Labels |
| 157438 | Kilometers | Kilometers | Configuration > [Career Section] Administration > Career Sections > Career Section name > [Career Portal Pages] Show > Basic Search > Edit User-defined Labels |
| 157447 | SelectOne | Select one... | Configuration > [Career Section] Administration > Career Sections > Career Section name > [Career Portal Pages] Show > Basic Search > Edit User-defined Labels |
| 157459 | DistanceFromCode | Distance from Zip/Postal Code | Configuration > [Career Section] Administration > Career Sections > Career Section name > [Career Portal Pages] Show > Advanced Search > Edit User-defined Labels |
| 157462 | Kilometers | Kilometers | Configuration > [Career Section] Administration > Career Sections > Career Section name > [Career Portal Pages] Show > Advanced Search > Edit User-defined Labels |
| 157465 | Miles | Miles | Configuration > [Career Section] Administration > Career Sections > Career Section name > [Career Portal Pages] Show > Advanced Search > Edit User-defined Labels |

| ID | NAME | TALEO DEFAULT VALUE | LOCATION |
|--------|---------------------|------------------------|---|
| 157468 | SelectOne | Select one... | Configuration > [Career Section] Administration > Career Sections > Career Section name > [Career Portal Pages] Show > Advanced Search > Edit User-defined Labels |
| 157471 | ZipPostalCode | Zip/Postal Code | Configuration > [Career Section] Administration > Career Sections > Career Section name > [Career Portal Pages] Show > Advanced Search > Edit User-defined Labels |
| 157474 | ZipPostalCodeRadius | Zip/Postal Code Radius | Configuration > [Career Section] Administration > Career Sections > Career Section name > [Career Portal Pages] Show > Advanced Search > Edit User-defined Labels |
| 161774 | JobLevel | Job Level | Configuration > [Career Section] Administration > Career Sections > Career Section name > [Career Portal Pages] Show > Advanced Search > Edit User-defined Labels |
| 161783 | JobType | Job Type | Configuration > [Career Section] Administration > Career Sections > Career Section name > [Career Portal Pages] Show > Advanced Search > Edit User-defined Labels |
| 161792 | JobSchedule | Schedule | Configuration > [Career Section] Administration > Career Sections > Career Section name > [Career Portal Pages] Show > Advanced Search > Edit User-defined Labels |
| 161801 | JobShift | Shift | Configuration > [Career Section] Administration > Career Sections > Career Section name > [Career Portal Pages] Show > Advanced Search > Edit User-defined Labels |
| 161810 | EmployeeStatus | Employee Status | Configuration > [Career Section] Administration > Career Sections > Career Section name > [Career Portal Pages] Show > Advanced Search > Edit User-defined Labels |
| 161819 | EducationLevel | Education Level | Configuration > [Career Section] Administration > Career Sections > Career Section name > [Career Portal Pages] Show > Advanced Search > Edit User-defined Labels |
| 161828 | Travel | Travel (Up to...) | Configuration > [Career Section] Administration > Career Sections > Career Section name > [Career Portal Pages] Show > Advanced Search > Edit User-defined Labels |
| 161895 | SubmissionsPerPage | Submissions per page: | Configuration > [Career Section] Administration > Career Sections > Career Section name > [Career Portal Pages] Show > My Submissions > Edit User-defined Labels |
| 161927 | UpdatedVariable | Updated: {0} | Configuration > [Career Section] Administration > Career Sections > Career Section name > [Career Portal Pages] Show > My Submissions > Edit User-defined Labels |
| 161930 | PostingDateVariable | Job Posting: {0} | Configuration > [Career Section] Administration > Career Sections > Career Section name > [Career Portal Pages] Show > My Submissions > Edit User-defined Labels |
| 161942 | JobStatusVariable | Job Status: {0} | Configuration > [Career Section] Administration > Career Sections > Career Section name > [Career Portal Pages] Show > My Submissions > Edit User-defined Labels |
| 161975 | JobIDVariable | Job Number : {0} | Configuration > [Career Section] Administration > Career Sections > Career Section name > [Career Portal Pages] Show > My Submissions > Edit User-defined Labels |

| ID | NAME | TALEO DEFAULT VALUE | LOCATION |
|--------|------------------------------|--|---|
| 161982 | MoreLocations | More... | Configuration > [Career Section] Administration > Career Sections > Career Section name > [Career Portal Pages] Show > My Submissions > Edit User-defined Labels |
| 161989 | MoreLocationsTT | Position available in other locations: {0} | Configuration > [Career Section] Administration > Career Sections > Career Section name > [Career Portal Pages] Show > My Submissions > Edit User-defined Labels |
| 162010 | WithdrawAllSubmissionsAction | Withdraw all job submissions | Configuration > [Career Section] Administration > Career Sections > Career Section name > [Career Portal Pages] Show > My Submissions > Edit User-defined Labels |
| 162153 | FinishAction | Finish Draft Submission | Configuration > [Career Section] Administration > Career Sections > Career Section name > [Career Portal Pages] Show > My Submissions > Edit User-defined Labels |
| 162160 | FinishActionTT | Finish this draft submission | Configuration > [Career Section] Administration > Career Sections > Career Section name > [Career Portal Pages] Show > My Submissions > Edit User-defined Labels |
| 162235 | WithdrawAction | Withdraw | Configuration > [Career Section] Administration > Career Sections > Career Section name > [Career Portal Pages] Show > My Submissions > Edit User-defined Labels |
| 162238 | WithdrawActionTT | Withdraw this submission | Configuration > [Career Section] Administration > Career Sections > Career Section name > [Career Portal Pages] Show > My Submissions > Edit User-defined Labels |
| 162247 | ViewSubmissionAction | View Submission | Configuration > [Career Section] Administration > Career Sections > Career Section name > [Career Portal Pages] Show > My Submissions > Edit User-defined Labels |
| 162250 | ViewSubmissionActionTT | View this job submission | Configuration > [Career Section] Administration > Career Sections > Career Section name > [Career Portal Pages] Show > My Submissions > Edit User-defined Labels |
| 162259 | ViewMessagesAction | View Email Messages | Configuration > [Career Section] Administration > Career Sections > Career Section name > [Career Portal Pages] Show > My Submissions > Edit User-defined Labels |
| 162268 | ViewMessagesActionTT | View email messages relating to this job submission | Configuration > [Career Section] Administration > Career Sections > Career Section name > [Career Portal Pages] Show > My Submissions > Edit User-defined Labels |
| 162339 | EmailNotificationTitle | Email Notification | Configuration > [Career Section] Administration > Career Sections > Career Section name > [Career Portal Pages] Show > My Saved Searches > Edit User-defined Labels |
| 162391 | Frequency | Frequency | Configuration > [Career Section] Administration > Career Sections > Career Section name > [Career Portal Pages] Show > My Saved Searches > Edit User-defined Labels |
| 162409 | Description5 | Select an option in the drop-down list to specify the frequency you wish to receive email notifications relating to new job postings matching the search criteria. | Configuration > [Career Section] Administration > Career Sections > Career Section name > [Career Portal Pages] Show > My Saved Searches > Edit User-defined Labels |
| 162412 | CancelCommand | Cancel | Configuration > [Career Section] Administration > Career Sections > Career Section name > [Career Portal Pages] Show > My Saved Searches > Edit User-defined Labels |

| ID | NAME | TALEO DEFAULT VALUE | LOCATION |
|--------|--------------------------|--|---|
| 162415 | SaveCommand | Save | Configuration > [Career Section] Administration > Career Sections > Career Section name > [Career Portal Pages] Show > My Saved Searches > Edit User-defined Labels |
| 162418 | SaveCommandTT | Save the selected option | Configuration > [Career Section] Administration > Career Sections > Career Section name > [Career Portal Pages] Show > My Saved Searches > Edit User-defined Labels |
| 162421 | CancelCommandTT | Cancel the action | Configuration > [Career Section] Administration > Career Sections > Career Section name > [Career Portal Pages] Show > My Saved Searches > Edit User-defined Labels |
| 162491 | SaveSearchesHighlighted | You have saved {0} out of 5 possible saved searches. | Configuration > [Career Section] Administration > Career Sections > Career Section name > [Career Portal Pages] Show > My Saved Searches > Edit User-defined Labels |
| 162518 | NoSavedSearchesToDisplay | There are currently no saved searches. | Configuration > [Career Section] Administration > Career Sections > Career Section name > [Career Portal Pages] Show > My Saved Searches > Edit User-defined Labels |
| 162543 | NoSubmissionsToDisplay | There are currently no job submissions. | Configuration > [Career Section] Administration > Career Sections > Career Section name > [Career Portal Pages] Show > My Submissions > Edit User-defined Labels |
| 162672 | ReferralsHighlighted | Highlighted referrals have been updated since your last login. | Configuration > [Career Section] Administration > Career Sections > Career Section name > [Career Portal Pages] Show > My Referrals > Edit User-defined Labels |
| 162697 | ReferralsPageXOfY | My Referrals - Page {0} of {1} | Configuration > [Career Section] Administration > Career Sections > Career Section name > [Career Portal Pages] Show > My Referrals > Edit User-defined Labels |
| 162715 | UpdatedVariable | Updated: {0} | Configuration > [Career Section] Administration > Career Sections > Career Section name > [Career Portal Pages] Show > My Referrals > Edit User-defined Labels |
| 162722 | UpdatedCapitals | UPDATED | Configuration > [Career Section] Administration > Career Sections > Career Section name > [Career Portal Pages] Show > My Referrals > Edit User-defined Labels |
| 162746 | JobIDVariable | Job Number: {0} | Configuration > [Career Section] Administration > Career Sections > Career Section name > [Career Portal Pages] Show > My Referrals > Edit User-defined Labels |
| 162753 | PostingDateVariable | Job Posting: {0} | Configuration > [Career Section] Administration > Career Sections > Career Section name > [Career Portal Pages] Show > My Referrals > Edit User-defined Labels |
| 162772 | ExpirationDateVariable | Expiration Date: {0} | Configuration > [Career Section] Administration > Career Sections > Career Section name > [Career Portal Pages] Show > My Referrals > Edit User-defined Labels |
| 162781 | ReferralDateVariable | Referral Date : {0} | Configuration > [Career Section] Administration > Career Sections > Career Section name > [Career Portal Pages] Show > My Referrals > Edit User-defined Labels |
| 162875 | ViewReferralAction | View Referral | Configuration > [Career Section] Administration > Career Sections > Career Section name > [Career Portal Pages] Show > My Referrals > Edit User-defined Labels |

| ID | NAME | TALEO DEFAULT VALUE | LOCATION |
|--------|----------------------|--|---|
| 162904 | ViewReferralActionTT | View this job-specific referral ({JOB_TITLE}) | Configuration > [Career Section] Administration > Career Sections > Career Section name > [Career Portal Pages] Show > My Referrals > Edit User-defined Labels |
| 162921 | ReferredToPosition | Referred to position: | Configuration > [Career Section] Administration > Career Sections > Career Section name > [Career Portal Pages] Show > My Referrals > Edit User-defined Labels |
| 162931 | FinishAction | Finish Draft Referral | Configuration > [Career Section] Administration > Career Sections > Career Section name > [Career Portal Pages] Show > My Referrals > Edit User-defined Labels |
| 162938 | FinishActionTT | Finish this draft referral | Configuration > [Career Section] Administration > Career Sections > Career Section name > [Career Portal Pages] Show > My Referrals > Edit User-defined Labels |
| 162977 | WhitdrawAction | Withdraw | Configuration > [Career Section] Administration > Career Sections > Career Section name > [Career Portal Pages] Show > My Referrals > Edit User-defined Labels |
| 163008 | WhitdrawActionTT | Withdraw this referral | Configuration > [Career Section] Administration > Career Sections > Career Section name > [Career Portal Pages] Show > My Referrals > Edit User-defined Labels |
| 163062 | NoMessagesToDisplay | There are currently no messages. | Configuration > [Career Section] Administration > Career Sections > Career Section name > [Career Portal Pages] Show > My Submissions > Edit User-defined Labels |
| 163088 | AllJobsPageTitle | Job Openings | Configuration > [Career Section] Administration > Career Sections > Career Section name > [Career Portal Pages] Show > Job List > Edit User-defined Labels |
| 163097 | AllJobsPageDesc | This list includes all jobs currently available within our organization. | Configuration > [Career Section] Administration > Career Sections > Career Section name > [Career Portal Pages] Show > Job List > Edit User-defined Labels |
| 261777 | RemoveOrganization | Remove Organization | Configuration > [Career Section] Administration > Career Sections > Career Section name > [Career Portal Pages] Show > Basic Search > Edit User-defined Labels |
| 261786 | RemoveOrganizationTT | Remove this organization from the search criteria: {0} | Configuration > [Career Section] Administration > Career Sections > Career Section name > [Career Portal Pages] Show > Basic Search > Edit User-defined Labels |
| 261803 | RemoveOrganizationTT | Remove this organization from the search criteria: {0} | Configuration > [Career Section] Administration > Career Sections > Career Section name > [Career Portal Pages] Show > Advanced Search > Edit User-defined Labels |
| 261806 | RemoveJobFieldTT | Remove this job field from the search criteria: {0} | Configuration > [Career Section] Administration > Career Sections > Career Section name > [Career Portal Pages] Show > Advanced Search > Edit User-defined Labels |
| 261809 | RemoveOrganization | Remove Organization | Configuration > [Career Section] Administration > Career Sections > Career Section name > [Career Portal Pages] Show > Advanced Search > Edit User-defined Labels |
| 261812 | Country | Country | Configuration > [Career Section] Administration > Career Sections > Career Section name > [Career Portal Pages] Show > Basic Search > Edit User-defined Labels |

| ID | NAME | TALEO DEFAULT VALUE | LOCATION |
|--------|-----------------|---|---|
| 261819 | Country | Country | Configuration > [Career Section] Administration > Career Sections > Career Section name > [Career Portal Pages] Show > Advanced Search > Edit User-defined Labels |
| 286460 | AscendingOrder | (Ascending Order) | Configuration > [Career Section] Administration > Career Sections > Career Section name > [Career Portal Pages] Show > Basic Search > Edit User-defined Labels |
| 286460 | AscendingOrder | (Ascending Order) | Configuration > [Career Section] Administration > Career Sections > Career Section name > [Career Portal Pages] Show > Job List > Edit User-defined Labels |
| 286460 | AscendingOrder | (Ascending Order) | Configuration > [Career Section] Administration > Career Sections > Career Section name > [Career Portal Pages] Show > My Job Cart > Edit User-defined Labels |
| 286469 | DescendingOrder | (Descending Order) | Configuration > [Career Section] Administration > Career Sections > Career Section name > [Career Portal Pages] Show > Basic Search > Edit User-defined Labels |
| 286469 | DescendingOrder | (Descending Order) | Configuration > [Career Section] Administration > Career Sections > Career Section name > [Career Portal Pages] Show > Job List > Edit User-defined Labels |
| 286469 | DescendingOrder | (Descending Order) | Configuration > [Career Section] Administration > Career Sections > Career Section name > [Career Portal Pages] Show > My Job Cart > Edit User-defined Labels |
| 286773 | Title3 | | Configuration > [Career Section] Administration > Career Sections > Career Section name > [Career Portal Pages] Show > Job Description > Edit User-defined Labels |
| 286776 | Description3 | | Configuration > [Career Section] Administration > Career Sections > Career Section name > [Career Portal Pages] Show > Job Description > Edit User-defined Labels |
| 286782 | Description1 | To deactivate your account, click "Deactivate" next to the page title. Please note that by deactivating your account, the system automatically withdraws all your active job submissions. | Configuration > [Career Section] Administration > Career Sections > Career Section name > [Career Portal Pages] Show > Job List > Edit User-defined Labels |
| 286785 | Description2 | | Configuration > [Career Section] Administration > Career Sections > Career Section name > [Career Portal Pages] Show > Job List > Edit User-defined Labels |
| 286788 | Description3 | | Configuration > [Career Section] Administration > Career Sections > Career Section name > [Career Portal Pages] Show > Job List > Edit User-defined Labels |
| 286791 | Title1 | Deactivating the account | Configuration > [Career Section] Administration > Career Sections > Career Section name > [Career Portal Pages] Show > Job List > Edit User-defined Labels |
| 286794 | Title2 | | Configuration > [Career Section] Administration > Career Sections > Career Section name > [Career Portal Pages] Show > Job List > Edit User-defined Labels |

| ID | NAME | TALEO DEFAULT VALUE | LOCATION |
|--------|-------------------------------|--|---|
| 286797 | Title3 | | Configuration > [Career Section] Administration > Career Sections > Career Section name > [Career Portal Pages] Show > Job List > Edit User-defined Labels |
| 286821 | Title2 | | Configuration > [Career Section] Administration > Career Sections > Career Section name > [Career Portal Pages] Show > Advanced Search > Edit User-defined Labels |
| 286821 | Title2 | | Configuration > [Career Section] Administration > Career Sections > Career Section name > [Career Portal Pages] Show > Basic Search > Edit User-defined Labels |
| 286824 | Title3 | | Configuration > [Career Section] Administration > Career Sections > Career Section name > [Career Portal Pages] Show > Advanced Search > Edit User-defined Labels |
| 286824 | Title3 | | Configuration > [Career Section] Administration > Career Sections > Career Section name > [Career Portal Pages] Show > Basic Search > Edit User-defined Labels |
| 286827 | Description2 | | Configuration > [Career Section] Administration > Career Sections > Career Section name > [Career Portal Pages] Show > Advanced Search > Edit User-defined Labels |
| 286827 | Description2 | | Configuration > [Career Section] Administration > Career Sections > Career Section name > [Career Portal Pages] Show > Basic Search > Edit User-defined Labels |
| 286830 | Description3 | | Configuration > [Career Section] Administration > Career Sections > Career Section name > [Career Portal Pages] Show > Advanced Search > Edit User-defined Labels |
| 286830 | Description3 | | Configuration > [Career Section] Administration > Career Sections > Career Section name > [Career Portal Pages] Show > Basic Search > Edit User-defined Labels |
| 289824 | OverrideSearchConfirmationTit | You are about to override a search query and all of its content. | Configuration > [Career Section] Administration > Career Sections > Career Section name > [Career Portal Pages] Show > Advanced Search > Edit User-defined Labels |
| 289824 | OverrideSearchConfirmationTit | You are about to override a search query and all of its content. | Configuration > [Career Section] Administration > Career Sections > Career Section name > [Career Portal Pages] Show > Basic Search > Edit User-defined Labels |
| 289831 | OverrideSearchMessage | Are you sure that you want to override it? | Configuration > [Career Section] Administration > Career Sections > Career Section name > [Career Portal Pages] Show > Advanced Search > Edit User-defined Labels |
| 289831 | OverrideSearchMessage | Are you sure that you want to override it? | Configuration > [Career Section] Administration > Career Sections > Career Section name > [Career Portal Pages] Show > Basic Search > Edit User-defined Labels |
| 289838 | NoCommand | No | Configuration > [Career Section] Administration > Career Sections > Career Section name > [Career Portal Pages] Show > Advanced Search > Edit User-defined Labels |
| 289838 | NoCommand | No | Configuration > [Career Section] Administration > Career Sections > Career Section name > [Career Portal Pages] Show > Basic Search > Edit User-defined Labels |

| ID | NAME | TALEO DEFAULT VALUE | LOCATION |
|--------|-------------------------------|--|---|
| 289841 | NoCommandTT | Cancel the action | Configuration > [Career Section] Administration > Career Sections > Career Section name > [Career Portal Pages] Show > Advanced Search > Edit User-defined Labels |
| 289841 | NoCommandTT | Cancel the action | Configuration > [Career Section] Administration > Career Sections > Career Section name > [Career Portal Pages] Show > Basic Search > Edit User-defined Labels |
| 289848 | YesCommand | Yes | Configuration > [Career Section] Administration > Career Sections > Career Section name > [Career Portal Pages] Show > Advanced Search > Edit User-defined Labels |
| 289848 | YesCommand | Yes | Configuration > [Career Section] Administration > Career Sections > Career Section name > [Career Portal Pages] Show > Basic Search > Edit User-defined Labels |
| 289851 | YesCommandTT | Override the search query | Configuration > [Career Section] Administration > Career Sections > Career Section name > [Career Portal Pages] Show > Advanced Search > Edit User-defined Labels |
| 289851 | YesCommandTT | Override the search query | Configuration > [Career Section] Administration > Career Sections > Career Section name > [Career Portal Pages] Show > Basic Search > Edit User-defined Labels |
| 295134 | MyAccountOptionsPageTitle | My Account | Configuration > [Career Section] Administration > Career Sections > Career Section name > [Career Portal Pages] Show > Job List > Edit User-defined Labels |
| 295137 | MyAccountOptionsPageDesc | This page displays your account options. To set or modify preferences, click "Edit" next to the relevant section. | Configuration > [Career Section] Administration > Career Sections > Career Section name > [Career Portal Pages] Show > Job List > Edit User-defined Labels |
| 297809 | CancelCommand | Cancel | Configuration > [Career Section] Administration > Career Sections > Career Section name > [Career Portal Pages] Show > Access Management |
| 297812 | CancelCommandTT | Cancel the action | Configuration > [Career Section] Administration > Career Sections > Career Section name > [Career Portal Pages] Show > Access Management |
| 297815 | EmailAddress | Email Address | Configuration > [Career Section] Administration > Career Sections > Career Section name > [Career Portal Pages] Show > Access Management |
| 297818 | ForgotYourPasswordInstruction | Please enter your email address below. You will shortly receive a message explaining how to change your password. | Configuration > [Career Section] Administration > Career Sections > Career Section name > [Career Portal Pages] Show > Access Management |
| 297821 | ForgotYourPasswordTitle | Forgot Your Password? | Configuration > [Career Section] Administration > Career Sections > Career Section name > [Career Portal Pages] Show > Access Management |
| 297824 | MandatoryEmailAddressInstruc | Please enter your user name and email address below, click OK, then follow the instructions. If you don't have an email address, please contact your system administrator for assistance at {0}. | Configuration > [Career Section] Administration > Career Sections > Career Section name > [Career Portal Pages] Show > Access Management |

| ID | NAME | TALEO DEFAULT VALUE | LOCATION |
|--------|---------------------------------|---|--|
| 297827 | MandatoryField | Mandatory fields are marked with an asterisk. | Configuration > [Career Section] Administration > Career Sections > Career Section name > [Career Portal Pages] Show > Access Management |
| 297830 | MandatoryFieldTT | This field is mandatory | Configuration > [Career Section] Administration > Career Sections > Career Section name > [Career Portal Pages] Show > Access Management |
| 297833 | NoEmailAddressInstruction | Please enter your user name below, click OK, then follow the on-screen instructions. | Configuration > [Career Section] Administration > Career Sections > Career Section name > [Career Portal Pages] Show > Access Management |
| 297836 | OKCommand | OK | Configuration > [Career Section] Administration > Career Sections > Career Section name > [Career Portal Pages] Show > Access Management |
| 297839 | OKCommandTT | Save changes and close this window | Configuration > [Career Section] Administration > Career Sections > Career Section name > [Career Portal Pages] Show > Access Management |
| 297842 | OptionalEmailAddressInstruction | Please enter your user name and your email address (if you have one) below, click OK, then follow the on-screen instructions. | Configuration > [Career Section] Administration > Career Sections > Career Section name > [Career Portal Pages] Show > Access Management |
| 297845 | UserName | User Name | Configuration > [Career Section] Administration > Career Sections > Career Section name > [Career Portal Pages] Show > Access Management |
| 297860 | ForgotYourPasswordInstruction | If you forgot your password, please contact your system administrator for assistance at {0}. | Configuration > [Career Section] Administration > Career Sections > Career Section name > [Career Portal Pages] Show > Access Management |
| 297863 | ForgotYourPasswordTitle | Forgot Your Password? | Configuration > [Career Section] Administration > Career Sections > Career Section name > [Career Portal Pages] Show > Access Management |
| 297914 | CancelCommand | Cancel | Configuration > [Career Section] Administration > Career Sections > Career Section name > [Career Portal Pages] Show > Access Management |
| 297917 | CancelCommandTT | Return to the previous page | Configuration > [Career Section] Administration > Career Sections > Career Section name > [Career Portal Pages] Show > Access Management |
| 297920 | EmailAddress | Email Address | Configuration > [Career Section] Administration > Career Sections > Career Section name > [Career Portal Pages] Show > Access Management |
| 297923 | FirstName | First Name | Configuration > [Career Section] Administration > Career Sections > Career Section name > [Career Portal Pages] Show > Access Management |
| 297926 | ForgottenUserNamePageDesc | For the system to identify your unique candidate record and retrieve your user name, you must provide some personal information. Fill in the fields below, then click "Validate" to verify if the information | Configuration > [Career Section] Administration > Career Sections > Career Section name > [Career Portal Pages] Show > Access Management |

| ID | NAME | TALEO DEFAULT VALUE | LOCATION |
|--------|----------------------------|--|--|
| | | matches a unique candidate record. Note that email addresses usually produce the best results. | |
| 297929 | ForgottenUserNamePageTitle | Forgotten User Name | Configuration > [Career Section] Administration > Career Sections > Career Section name > [Career Portal Pages] Show > Access Management |
| 297932 | Initial | Middle Name | Configuration > [Career Section] Administration > Career Sections > Career Section name > [Career Portal Pages] Show > Access Management |
| 297935 | LastName | Last Name | Configuration > [Career Section] Administration > Career Sections > Career Section name > [Career Portal Pages] Show > Access Management |
| 297938 | MandatoryField | Mandatory fields are marked with an asterisk. | Configuration > [Career Section] Administration > Career Sections > Career Section name > [Career Portal Pages] Show > Access Management |
| 297941 | MandatoryFieldTT | This field is mandatory | Configuration > [Career Section] Administration > Career Sections > Career Section name > [Career Portal Pages] Show > Access Management |
| 297944 | PhoneNumber | Phone Number | Configuration > [Career Section] Administration > Career Sections > Career Section name > [Career Portal Pages] Show > Access Management |
| 297947 | StreetAddress | Street Address | Configuration > [Career Section] Administration > Career Sections > Career Section name > [Career Portal Pages] Show > Access Management |
| 297950 | ValidateCommand | Validate | Configuration > [Career Section] Administration > Career Sections > Career Section name > [Career Portal Pages] Show > Access Management |
| 297953 | ValidateCommandTT | Validate the information entered | Configuration > [Career Section] Administration > Career Sections > Career Section name > [Career Portal Pages] Show > Access Management |
| 298007 | AtLeastXCharacters | (at least {0} characters) | Configuration > [Career Section] Administration > Career Sections > Career Section name > [Career Portal Pages] Show > Access Management |
| 298010 | CancelCommand | Cancel | Configuration > [Career Section] Administration > Career Sections > Career Section name > [Career Portal Pages] Show > Access Management |
| 298013 | CancelCommandTT | Cancel the registration | Configuration > [Career Section] Administration > Career Sections > Career Section name > [Career Portal Pages] Show > Access Management |
| 298016 | EmailAddress | Email Address | Configuration > [Career Section] Administration > Career Sections > Career Section name > [Career Portal Pages] Show > Access Management |
| 298019 | MandatoryField | Mandatory fields are marked with an asterisk. | Configuration > [Career Section] Administration > Career Sections > Career Section name > [Career Portal Pages] Show > Access Management |

| ID | NAME | TALEO DEFAULT VALUE | LOCATION |
|--------|-----------------------------|---|--|
| 298022 | MandatoryFieldTT | This field is mandatory | Configuration > [Career Section] Administration > Career Sections > Career Section name > [Career Portal Pages] Show > Access Management |
| 298025 | Password | Password | Configuration > [Career Section] Administration > Career Sections > Career Section name > [Career Portal Pages] Show > Access Management |
| 298028 | ReEnterEmailAddress | Re-enter Email Address | Configuration > [Career Section] Administration > Career Sections > Career Section name > [Career Portal Pages] Show > Access Management |
| 298031 | ReEnterPassword | Re-enter Password | Configuration > [Career Section] Administration > Career Sections > Career Section name > [Career Portal Pages] Show > Access Management |
| 298034 | RegisterCommand | Register | Configuration > [Career Section] Administration > Career Sections > Career Section name > [Career Portal Pages] Show > Access Management |
| 298037 | RegisterCommandTT | Create an account | Configuration > [Career Section] Administration > Career Sections > Career Section name > [Career Portal Pages] Show > Access Management |
| 298040 | RegistrationPageDescription | Please take a few moments to register. You will need this information to access your account in the future. | Configuration > [Career Section] Administration > Career Sections > Career Section name > [Career Portal Pages] Show > Access Management |
| 298043 | RegistrationPageTitle | New User Registration | Configuration > [Career Section] Administration > Career Sections > Career Section name > [Career Portal Pages] Show > Access Management |
| 298046 | UserName | User Name | Configuration > [Career Section] Administration > Career Sections > Career Section name > [Career Portal Pages] Show > Access Management |
| 298049 | UserNameEmail | Email Address | Configuration > [Career Section] Administration > Career Sections > Career Section name > [Career Portal Pages] Show > Access Management |
| 298052 | UserNameSSN | Social Security Number | Configuration > [Career Section] Administration > Career Sections > Career Section name > [Career Portal Pages] Show > Access Management |
| 298061 | AccessCode | Access Code | Configuration > [Career Section] Administration > Career Sections > Career Section name > [Career Portal Pages] Show > Access Management |
| 298064 | FirstLogin | First Login? | Configuration > [Career Section] Administration > Career Sections > Career Section name > [Career Portal Pages] Show > Access Management |
| 298067 | FirstLoginTT | Access the first login page | Configuration > [Career Section] Administration > Career Sections > Career Section name > [Career Portal Pages] Show > Access Management |
| 298070 | ForgotYourPassword | Forgot your password? | Configuration > [Career Section] Administration > Career Sections > Career Section name > [Career Portal Pages] Show > Access Management |

| ID | NAME | TALEO DEFAULT VALUE | LOCATION |
|--------|--------------------------|--|--|
| 298073 | ForgotYourPasswordTT | Access the forgotten password instructions page | Configuration > [Career Section] Administration > Career Sections > Career Section name > [Career Portal Pages] Show > Access Management |
| 298076 | ForgotYourUserNameTT | Access the forgotten user name instructions page | Configuration > [Career Section] Administration > Career Sections > Career Section name > [Career Portal Pages] Show > Access Management |
| 298079 | ForgotYourUsername | Forgot your user name? | Configuration > [Career Section] Administration > Career Sections > Career Section name > [Career Portal Pages] Show > Access Management |
| 298082 | MandatoryField | Mandatory fields are marked with an asterisk. | Configuration > [Career Section] Administration > Career Sections > Career Section name > [Career Portal Pages] Show > Access Management |
| 298085 | MandatoryFieldTT | This field is mandatory | Configuration > [Career Section] Administration > Career Sections > Career Section name > [Career Portal Pages] Show > Access Management |
| 298088 | Password | Password | Configuration > [Career Section] Administration > Career Sections > Career Section name > [Career Portal Pages] Show > Access Management |
| 298091 | PopupBlockersInfo | Taleo advises not to use pop-up blockers as they may interfere with the application. | Configuration > [Career Section] Administration > Career Sections > Career Section name > [Career Portal Pages] Show > Access Management |
| 298094 | PopupBlockersTitle | Pop-up Blockers | Configuration > [Career Section] Administration > Career Sections > Career Section name > [Career Portal Pages] Show > Access Management |
| 298097 | RecommendedBrowsersInfo | In order to access this service, Taleo recommends using Internet Explorer 5.01 SP1 or later on Microsoft Windows operating system. | Configuration > [Career Section] Administration > Career Sections > Career Section name > [Career Portal Pages] Show > Access Management |
| 298100 | RecommendedBrowsersTitle | Recommended Browsers | Configuration > [Career Section] Administration > Career Sections > Career Section name > [Career Portal Pages] Show > Access Management |
| 298103 | Registration | New User | Configuration > [Career Section] Administration > Career Sections > Career Section name > [Career Portal Pages] Show > Access Management |
| 298106 | RegistrationTT | Access the registration page | Configuration > [Career Section] Administration > Career Sections > Career Section name > [Career Portal Pages] Show > Access Management |
| 298109 | SignInCommand | Login | Configuration > [Career Section] Administration > Career Sections > Career Section name > [Career Portal Pages] Show > Access Management |
| 298112 | SignInCommandTT | Log in to the system | Configuration > [Career Section] Administration > Career Sections > Career Section name > [Career Portal Pages] Show > Access Management |
| 298115 | SupportedMonitorsInfo | This application is designed for a display resolution of at least 800 x 600. | Configuration > [Career Section] Administration > Career Sections > Career Section name > [Career Portal Pages] Show > Access Management |

| ID | NAME | TALEO DEFAULT VALUE | LOCATION |
|--------|-------------------------------|--|--|
| 298118 | SupportedMonitorsTitle | Supported Monitors | Configuration > [Career Section] Administration > Career Sections > Career Section name > [Career Portal Pages] Show > Access Management |
| 298121 | UserName | User Name | Configuration > [Career Section] Administration > Career Sections > Career Section name > [Career Portal Pages] Show > Access Management |
| 298124 | UserSignInInstruction | To access your account, please identify yourself by providing the information requested in the fields below, then click "Login". If you are not registered yet, click "New user" and follow the instructions to create an account. | Configuration > [Career Section] Administration > Career Sections > Career Section name > [Career Portal Pages] Show > Access Management |
| 298127 | UserSignInTitle | Login | Configuration > [Career Section] Administration > Career Sections > Career Section name > [Career Portal Pages] Show > Access Management |
| 298521 | AccessDenied | Your user permissions do not authorize you to access this product. | Configuration > [Career Section] Administration > Career Sections > Career Section name > [Career Portal Pages] Show > Access Management |
| 298524 | AccountDeleted | Your account has been deleted. For further details, please contact your System Administrator. | Configuration > [Career Section] Administration > Career Sections > Career Section name > [Career Portal Pages] Show > Access Management |
| 298527 | AccountExpired | Your account has expired. Please contact your System Administrator. | Configuration > [Career Section] Administration > Career Sections > Career Section name > [Career Portal Pages] Show > Access Management |
| 298530 | AccountInactive | Your account has been deactivated. Please contact your System Administrator to reactivate it. | Configuration > [Career Section] Administration > Career Sections > Career Section name > [Career Portal Pages] Show > Access Management |
| 298533 | AccountLocked | Your account has been locked. Please contact your System Administrator. | Configuration > [Career Section] Administration > Career Sections > Career Section name > [Career Portal Pages] Show > Access Management |
| 298536 | InvalidUserNamePwdCombination | The user name and password combination you entered does not correspond to a registered user. | Configuration > [Career Section] Administration > Career Sections > Career Section name > [Career Portal Pages] Show > Access Management |
| 298539 | LastChanceDescription | The combination of field "{0}" and the field "Password" you entered does not correspond to a registered user. If you attempt to sign in again but fail to provide a valid combination, the system will lock this account. | Configuration > [Career Section] Administration > Career Sections > Career Section name > [Career Portal Pages] Show > Access Management |
| 298542 | LastChanceTitle | This is your last chance to sign in. | Configuration > [Career Section] Administration > Career Sections > Career Section name > [Career Portal Pages] Show > Access Management |

| ID | NAME | TALEO DEFAULT VALUE | LOCATION |
|--------|---------------------------|---|--|
| 298545 | ProvideUserNamePassword | Please provide a user name and a password. | Configuration > [Career Section] Administration > Career Sections > Career Section name > [Career Portal Pages] Show > Access Management |
| 298548 | UnableToLogin | Unable to login | Configuration > [Career Section] Administration > Career Sections > Career Section name > [Career Portal Pages] Show > Access Management |
| 298551 | UnexpectedError | An unexpected error has occurred. Please contact your System Administrator. | Configuration > [Career Section] Administration > Career Sections > Career Section name > [Career Portal Pages] Show > Access Management |
| 298554 | UnknownError | An unknown error has occurred. Please contact your System Administrator. | Configuration > [Career Section] Administration > Career Sections > Career Section name > [Career Portal Pages] Show > Access Management |
| 298557 | UserHasNoGroup | You cannot access this product since you do not belong to any group. Please contact your System Administrator. | Configuration > [Career Section] Administration > Career Sections > Career Section name > [Career Portal Pages] Show > Access Management |
| 298611 | EmailAddressAlreadyExists | A valid record already exists under this email address. If you have already used our system as a candidate or a referrer, please go back to the login page and sign in as a returning user. | Configuration > [Career Section] Administration > Career Sections > Career Section name > [Career Portal Pages] Show > Access Management |
| 298614 | EmailAddressesDiffer | The email addresses you entered do not match. Please enter the same email address in both fields. | Configuration > [Career Section] Administration > Career Sections > Career Section name > [Career Portal Pages] Show > Access Management |
| 298617 | EmailConfirmationEmpty | You must re-enter the email address. | Configuration > [Career Section] Administration > Career Sections > Career Section name > [Career Portal Pages] Show > Access Management |
| 298620 | PasswordConfirmationEmpty | You must re-enter the password. | Configuration > [Career Section] Administration > Career Sections > Career Section name > [Career Portal Pages] Show > Access Management |
| 298623 | PasswordEmpty | You must enter a password. | Configuration > [Career Section] Administration > Career Sections > Career Section name > [Career Portal Pages] Show > Access Management |
| 298626 | PasswordsDiffer | The passwords you entered do not match. Please enter the same password in both fields. | Configuration > [Career Section] Administration > Career Sections > Career Section name > [Career Portal Pages] Show > Access Management |
| 298629 | UserNameAlreadyExists | A valid record already exists under this user name. If you have already used our system as a candidate or a referrer, please go back to the login page and sign in as a returning user. | Configuration > [Career Section] Administration > Career Sections > Career Section name > [Career Portal Pages] Show > Access Management |
| 298632 | UserNameEmailAddressEmpty | You must enter an email address. | Configuration > [Career Section] Administration > Career Sections > Career Section name > [Career Portal Pages] Show > Access Management |

| ID | NAME | TALEO DEFAULT VALUE | LOCATION |
|--------|-----------------------------|--|---|
| 298635 | UserNameEmailAddressInvalid | The email address you used is invalid. Please double check it. Remember that email addresses should be in the following format: alphanumerictext@mailserver.c | Configuration > [Career Section] Administration > Career Sections > Career Section name > [Career Portal Pages] Show > Access Management |
| 298638 | UserNameEmpty | You must enter a user name. | Configuration > [Career Section] Administration > Career Sections > Career Section name > [Career Portal Pages] Show > Access Management |
| 298641 | UserNameInvalid | The user name you entered is invalid. Please double check it. Remember that user names should contain at least {0} alphanumeric characters. | Configuration > [Career Section] Administration > Career Sections > Career Section name > [Career Portal Pages] Show > Access Management |
| 298644 | UserNameSSNAlreadyExists | A valid record already exists under this Social Security Number. If you have already used our system as a candidate or a referrer, please go back to the login page and sign in as a returning user. | Configuration > [Career Section] Administration > Career Sections > Career Section name > [Career Portal Pages] Show > Access Management |
| 298647 | UserNameSSNEmpty | You must enter a Social Security Number. | Configuration > [Career Section] Administration > Career Sections > Career Section name > [Career Portal Pages] Show > Access Management |
| 298650 | UserNameSSNInvalid | The Social Security Number you used is invalid. Please double check it. Remember that you must provide a Social Security Number whose format or content is valid in the United States. | Configuration > [Career Section] Administration > Career Sections > Career Section name > [Career Portal Pages] Show > Access Management |
| 300112 | MyJobCartPageTitle | Configuration > [Career Section] Administration > Career Sections > Career Section name > [Career Portal Pages] Show > My Job Cart > Edit User-defined Labels | Configuration > [Career Section] Administration > Career Sections > Career Section name > [Career Portal Pages] Show > My Job Cart > Edit User-defined Labels |
| 300121 | MyJobCartPageDescription | This page presents all jobs that you have added to the job cart. | Configuration > [Career Section] Administration > Career Sections > Career Section name > [Career Portal Pages] Show > My Job Cart > Edit User-defined Labels |
| 300437 | JobIDVariable | Job Number: {0} | Configuration > [Career Section] Administration > Career Sections > Career Section name > [Career Portal Pages] Show > My Job Cart > Edit User-defined Labels |
| 300444 | JobTitleTT | View the description of this job: "{0}" ({1}) | Configuration > [Career Section] Administration > Career Sections > Career Section name > [Career Portal Pages] Show > My Job Cart > Edit User-defined Labels |
| 300451 | ApplyAction | Apply | Configuration > [Career Section] Administration > Career Sections > Career Section name > [Career Portal Pages] Show > My Job Cart > Edit User-defined Labels |

| ID | NAME | TALEO DEFAULT VALUE | LOCATION |
|--------|--------------------|--|---|
| 300458 | ApplyActionTT | Apply for this position | Configuration > [Career Section] Administration > Career Sections > Career Section name > [Career Portal Pages] Show > My Job Cart > Edit User-defined Labels |
| 300481 | JobStatusVariable | Job status:{0} | Configuration > [Career Section] Administration > Career Sections > Career Section name > [Career Portal Pages] Show > My Job Cart > Edit User-defined Labels |
| 300488 | RemoveAction | Remove from Job Cart | Configuration > [Career Section] Administration > Career Sections > Career Section name > [Career Portal Pages] Show > My Job Cart > Edit User-defined Labels |
| 300497 | RemoveActionTT | Remove this job from the job cart | Configuration > [Career Section] Administration > Career Sections > Career Section name > [Career Portal Pages] Show > My Job Cart > Edit User-defined Labels |
| 300508 | LocationVariable | Location: {0} | Configuration > [Career Section] Administration > Career Sections > Career Section name > [Career Portal Pages] Show > My Job Cart > Edit User-defined Labels |
| 300517 | MoreLocations | More... | Configuration > [Career Section] Administration > Career Sections > Career Section name > [Career Portal Pages] Show > My Job Cart > Edit User-defined Labels |
| 300532 | MoreLocationsTT | Position available in other locations: {0} | Configuration > [Career Section] Administration > Career Sections > Career Section name > [Career Portal Pages] Show > My Job Cart > Edit User-defined Labels |
| 301656 | EditAction | Edit | Configuration > [Career Section] Administration > Career Sections > Career Section name > [Career Portal Pages] Show > Job List > Edit User-defined Labels |
| 301659 | EditActionTT | Edit the content of this section | Configuration > [Career Section] Administration > Career Sections > Career Section name > [Career Portal Pages] Show > Job List > Edit User-defined Labels |
| 301666 | Properties | Properties | Configuration > [Career Section] Administration > Career Sections > Career Section name > [Career Portal Pages] Show > Job List > Edit User-defined Labels |
| 301680 | CreationDate | Account Creation Date | Configuration > [Career Section] Administration > Career Sections > Career Section name > [Career Portal Pages] Show > Job List > Edit User-defined Labels |
| 301902 | AtLeastXCharacters | (at least {0} characters) | Configuration > [Career Section] Administration > Career Sections > Career Section name > [Career Portal Pages] Show > Job List > Edit User-defined Labels |
| 301949 | SaveCommand | Save | Configuration > [Career Section] Administration > Career Sections > Career Section name > [Career Portal Pages] Show > Job List > Edit User-defined Labels |
| 301952 | CancelCommand | Cancel | Configuration > [Career Section] Administration > Career Sections > Career Section name > [Career Portal Pages] Show > Job List > Edit User-defined Labels |
| 301955 | SaveCommandTT | Save the modifications | Configuration > [Career Section] Administration > Career Sections > Career Section name > [Career Portal Pages] Show > Job List > Edit User-defined Labels |

| ID | NAME | TALEO DEFAULT VALUE | LOCATION |
|--------|-----------------------------|---|--|
| 301964 | CancelCommandTT | Cancel the action | Configuration > [Career Section] Administration > Career Sections > Career Section name > [Career Portal Pages] Show > Job List > Edit User-defined Labels |
| 301974 | LoginInfo | Login Information | Configuration > [Career Section] Administration > Career Sections > Career Section name > [Career Portal Pages] Show > Job List > Edit User-defined Labels |
| 302172 | SecurityAnswer | Answer | Configuration > [Career Section] Administration > Career Sections > Career Section name > [Career Portal Pages] Show > Job List > Edit User-defined Labels |
| 303175 | OldPassword | Current Password | Configuration > [Career Section] Administration > Career Sections > Career Section name > [Career Portal Pages] Show > Job List > Edit User-defined Labels |
| 303216 | Password | New Password | Configuration > [Career Section] Administration > Career Sections > Career Section name > [Career Portal Pages] Show > Job List > Edit User-defined Labels |
| 303438 | SecurityQuestion | Security Question | Configuration > [Career Section] Administration > Career Sections > Career Section name > [Career Portal Pages] Show > Job List > Edit User-defined Labels |
| 303479 | RetypePassword | Confirm New Password | Configuration > [Career Section] Administration > Career Sections > Career Section name > [Career Portal Pages] Show > Job List > Edit User-defined Labels |
| 303868 | Username | User Name | Configuration > [Career Section] Administration > Career Sections > Career Section name > [Career Portal Pages] Show > Job List > Edit User-defined Labels |
| 304830 | JobsMatchingMyProfilePageDe | This list includes all jobs currently available within our organization that match your employment profile. | Configuration > [Career Section] Administration > Career Sections > Career Section name > [Career Portal Pages] Show > Basic Search > Edit User-defined Labels |
| 307192 | SavedSearchesEmailFrequency | By default, when I save a search query, email me the new job postings matching my search criteria at the following frequency: | Configuration > [Career Section] Administration > Career Sections > Career Section name > [Career Portal Pages] Show > Job List > Edit User-defined Labels |
| 307261 | JobSubmissionAcknowledgeme | Send me an email acknowledgment when you receive my job submission. | Configuration > [Career Section] Administration > Career Sections > Career Section name > [Career Portal Pages] Show > Job List > Edit User-defined Labels |
| 307264 | CorrespondenceLanguage | Send me my correspondence in the following language (not all correspondence is available in all languages): | Configuration > [Career Section] Administration > Career Sections > Career Section name > [Career Portal Pages] Show > Job List > Edit User-defined Labels |
| 316318 | ChangePasswordAndUserName | This page allows you to change your user name and password. | Configuration > [Career Section] Administration > Career Sections > Career Section name > [Career Portal Pages] Show > Access Management |
| 316347 | ChangePasswordTitle | Change User Name and Password | Configuration > [Career Section] Administration > Career Sections > Career Section name > [Career Portal Pages] Show > Access Management |

| ID | NAME | TALEO DEFAULT VALUE | LOCATION |
|--------|--------------------------|---|---|
| 316376 | ConfirmNewPassword | Confirm New Password | Configuration > [Career Section] Administration > Career Sections > Career Section name > [Career Portal Pages] Show > Access Management |
| 316417 | NewPassword | New Password | Configuration > [Career Section] Administration > Career Sections > Career Section name > [Career Portal Pages] Show > Access Management |
| 316446 | OKCommand | OK | Configuration > [Career Section] Administration > Career Sections > Career Section name > [Career Portal Pages] Show > Access Management |
| 316449 | OKCommandTT | Save changes and close this window | Configuration > [Career Section] Administration > Career Sections > Career Section name > [Career Portal Pages] Show > Access Management |
| 316452 | OldPassword | Old Password | Configuration > [Career Section] Administration > Career Sections > Career Section name > [Career Portal Pages] Show > Access Management |
| 317451 | NewUserName | New User Name | Configuration > [Career Section] Administration > Career Sections > Career Section name > [Career Portal Pages] Show > Access Management |
| 317787 | JobOpeningsVariableTT | View this search results | Configuration > [Career Section] Administration > Career Sections > Career Section name > [Career Portal Pages] Show > My Saved Searches > Edit User-defined Labels |
| 317796 | SearchNameTT | View this search query criteria | Configuration > [Career Section] Administration > Career Sections > Career Section name > [Career Portal Pages] Show > My Saved Searches > Edit User-defined Labels |
| 317936 | NewUserNameInvalid | The new user name is either missing or invalid. Please try again. | Configuration > [Career Section] Administration > Career Sections > Career Section name > [Career Portal Pages] Show > Access Management |
| 317982 | NewUserNameAlreadyExists | The new user name already exists. Please try again. | Configuration > [Career Section] Administration > Career Sections > Career Section name > [Career Portal Pages] Show > Access Management |
| 323409 | CloseDate | Unposting Date | Configuration > [Career Section] Administration > Career Sections > Career Section name > [Career Portal Pages] Show > Advanced Search > Edit User-defined Labels |
| 323409 | CloseDate | Unposting Date | Configuration > [Career Section] Administration > Career Sections > Career Section name > [Career Portal Pages] Show > Basic Search > Edit User-defined Labels |
| 323409 | CloseDate | Unposting Date | Configuration > [Career Section] Administration > Career Sections > Career Section name > [Career Portal Pages] Show > Basic Search > Edit User-defined Labels |
| 323409 | CloseDate | Unposting Date | Configuration > [Career Section] Administration > Career Sections > Career Section name > [Career Portal Pages] Show > Job Description > Edit User-defined Labels |
| 323409 | CloseDate | Unposting Date | Configuration > [Career Section] Administration > Career Sections > Career Section name > [Career Portal Pages] Show > Job List > Edit User-defined Labels |

| ID | NAME | TALEO DEFAULT VALUE | LOCATION |
|--------|---------------|---------------------|---|
| 323409 | CloseDate | Unposting Date | Configuration > [Career Section] Administration > Career Sections > Career Section name > [Career Portal Pages] Show > My Job Cart > Edit User-defined Labels |
| 323409 | CloseDate | Unposting Date | Configuration > [Career Section] Administration > Career Sections > Career Section name > [Career Portal Pages] Show > My Referrals > Edit User-defined Labels |
| 323409 | CloseDate | Unposting Date | Configuration > [Career Section] Administration > Career Sections > Career Section name > [Career Portal Pages] Show > My Submissions > Edit User-defined Labels |
| 323412 | OpenDate | Posting Date | Configuration > [Career Section] Administration > Career Sections > Career Section name > [Career Portal Pages] Show > Advanced Search > Edit User-defined Labels |
| 323412 | OpenDate | Posting Date | Configuration > [Career Section] Administration > Career Sections > Career Section name > [Career Portal Pages] Show > Basic Search > Edit User-defined Labels |
| 323412 | OpenDate | Posting Date | Configuration > [Career Section] Administration > Career Sections > Career Section name > [Career Portal Pages] Show > Basic Search > Edit User-defined Labels |
| 323412 | OpenDate | Posting Date | Configuration > [Career Section] Administration > Career Sections > Career Section name > [Career Portal Pages] Show > Job Description > Edit User-defined Labels |
| 323412 | OpenDate | Posting Date | Configuration > [Career Section] Administration > Career Sections > Career Section name > [Career Portal Pages] Show > Job List > Edit User-defined Labels |
| 323412 | OpenDate | Posting Date | Configuration > [Career Section] Administration > Career Sections > Career Section name > [Career Portal Pages] Show > My Job Cart > Edit User-defined Labels |
| 323412 | OpenDate | Posting Date | Configuration > [Career Section] Administration > Career Sections > Career Section name > [Career Portal Pages] Show > My Referrals > Edit User-defined Labels |
| 323412 | OpenDate | Posting Date | Configuration > [Career Section] Administration > Career Sections > Career Section name > [Career Portal Pages] Show > My Submissions > Edit User-defined Labels |
| 323415 | ContestNumber | Requisition ID | Configuration > [Career Section] Administration > Career Sections > Career Section name > [Career Portal Pages] Show > Advanced Search > Edit User-defined Labels |
| 323415 | ContestNumber | Requisition ID | Configuration > [Career Section] Administration > Career Sections > Career Section name > [Career Portal Pages] Show > Basic Search > Edit User-defined Labels |
| 323415 | ContestNumber | Requisition ID | Configuration > [Career Section] Administration > Career Sections > Career Section name > [Career Portal Pages] Show > Basic Search > Edit User-defined Labels |
| 323415 | ContestNumber | Requisition ID | Configuration > [Career Section] Administration > Career Sections > Career Section name > [Career Portal Pages] Show > Job Description > Edit User-defined Labels |

| ID | NAME | TALEO DEFAULT VALUE | LOCATION |
|--------|---------------|---------------------|---|
| 323415 | ContestNumber | Requisition ID | Configuration > [Career Section] Administration > Career Sections > Career Section name > [Career Portal Pages] Show > Job List > Edit User-defined Labels |
| 323415 | ContestNumber | Requisition ID | Configuration > [Career Section] Administration > Career Sections > Career Section name > [Career Portal Pages] Show > My Job Cart > Edit User-defined Labels |
| 323415 | ContestNumber | Requisition ID | Configuration > [Career Section] Administration > Career Sections > Career Section name > [Career Portal Pages] Show > My Referrals > Edit User-defined Labels |
| 323415 | ContestNumber | Requisition ID | Configuration > [Career Section] Administration > Career Sections > Career Section name > [Career Portal Pages] Show > My Submissions > Edit User-defined Labels |
| 323418 | HotJob | "Urgent Need" Job | Configuration > [Career Section] Administration > Career Sections > Career Section name > [Career Portal Pages] Show > Advanced Search > Edit User-defined Labels |
| 323418 | HotJob | "Urgent Need" Job | Configuration > [Career Section] Administration > Career Sections > Career Section name > [Career Portal Pages] Show > Basic Search > Edit User-defined Labels |
| 323418 | HotJob | "Urgent Need" Job | Configuration > [Career Section] Administration > Career Sections > Career Section name > [Career Portal Pages] Show > Basic Search > Edit User-defined Labels |
| 323418 | HotJob | "Urgent Need" Job | Configuration > [Career Section] Administration > Career Sections > Career Section name > [Career Portal Pages] Show > Job Description > Edit User-defined Labels |
| 323418 | HotJob | "Urgent Need" Job | Configuration > [Career Section] Administration > Career Sections > Career Section name > [Career Portal Pages] Show > Job List > Edit User-defined Labels |
| 323418 | HotJob | "Urgent Need" Job | Configuration > [Career Section] Administration > Career Sections > Career Section name > [Career Portal Pages] Show > My Job Cart > Edit User-defined Labels |
| 323418 | HotJob | "Urgent Need" Job | Configuration > [Career Section] Administration > Career Sections > Career Section name > [Career Portal Pages] Show > My Referrals > Edit User-defined Labels |
| 323418 | HotJob | "Urgent Need" Job | Configuration > [Career Section] Administration > Career Sections > Career Section name > [Career Portal Pages] Show > My Submissions > Edit User-defined Labels |
| 323421 | NbToHire | Number of Openings | Configuration > [Career Section] Administration > Career Sections > Career Section name > [Career Portal Pages] Show > Advanced Search > Edit User-defined Labels |
| 323421 | NbToHire | Number of Openings | Configuration > [Career Section] Administration > Career Sections > Career Section name > [Career Portal Pages] Show > Basic Search > Edit User-defined Labels |
| 323421 | NbToHire | Number of Openings | Configuration > [Career Section] Administration > Career Sections > Career Section name > [Career Portal Pages] Show > Basic Search > Edit User-defined Labels |

| ID | NAME | TALEO DEFAULT VALUE | LOCATION |
|--------|-----------------|---------------------|---|
| 323421 | NbToHire | Number of Openings | Configuration > [Career Section] Administration > Career Sections > Career Section name > [Career Portal Pages] Show > Job Description > Edit User-defined Labels |
| 323421 | NbToHire | Number of Openings | Configuration > [Career Section] Administration > Career Sections > Career Section name > [Career Portal Pages] Show > Job List > Edit User-defined Labels |
| 323421 | NbToHire | Number of Openings | Configuration > [Career Section] Administration > Career Sections > Career Section name > [Career Portal Pages] Show > My Job Cart > Edit User-defined Labels |
| 323421 | NbToHire | Number of Openings | Configuration > [Career Section] Administration > Career Sections > Career Section name > [Career Portal Pages] Show > My Referrals > Edit User-defined Labels |
| 323421 | NbToHire | Number of Openings | Configuration > [Career Section] Administration > Career Sections > Career Section name > [Career Portal Pages] Show > My Submissions > Edit User-defined Labels |
| 323424 | No | Job Number | Configuration > [Career Section] Administration > Career Sections > Career Section name > [Career Portal Pages] Show > Advanced Search > Edit User-defined Labels |
| 323424 | No | Job Number | Configuration > [Career Section] Administration > Career Sections > Career Section name > [Career Portal Pages] Show > Basic Search > Edit User-defined Labels |
| 323424 | No | Job Number | Configuration > [Career Section] Administration > Career Sections > Career Section name > [Career Portal Pages] Show > Basic Search > Edit User-defined Labels |
| 323424 | No | Job Number | Configuration > [Career Section] Administration > Career Sections > Career Section name > [Career Portal Pages] Show > Job Description > Edit User-defined Labels |
| 323424 | No | Job Number | Configuration > [Career Section] Administration > Career Sections > Career Section name > [Career Portal Pages] Show > Job List > Edit User-defined Labels |
| 323424 | No | Job Number | Configuration > [Career Section] Administration > Career Sections > Career Section name > [Career Portal Pages] Show > My Job Cart > Edit User-defined Labels |
| 323424 | No | Job Number | Configuration > [Career Section] Administration > Career Sections > Career Section name > [Career Portal Pages] Show > My Referrals > Edit User-defined Labels |
| 323424 | No | Job Number | Configuration > [Career Section] Administration > Career Sections > Career Section name > [Career Portal Pages] Show > My Submissions > Edit User-defined Labels |
| 323427 | TargetStartDate | Target Start Date | Configuration > [Career Section] Administration > Career Sections > Career Section name > [Career Portal Pages] Show > Advanced Search > Edit User-defined Labels |
| 323427 | TargetStartDate | Target Start Date | Configuration > [Career Section] Administration > Career Sections > Career Section name > [Career Portal Pages] Show > Basic Search > Edit User-defined Labels |

| ID | NAME | TALEO DEFAULT VALUE | LOCATION |
|--------|--------------------|---------------------|---|
| 323427 | TargetStartDate | Target Start Date | Configuration > [Career Section] Administration > Career Sections > Career Section name > [Career Portal Pages] Show > Basic Search > Edit User-defined Labels |
| 323427 | TargetStartDate | Target Start Date | Configuration > [Career Section] Administration > Career Sections > Career Section name > [Career Portal Pages] Show > Job Description > Edit User-defined Labels |
| 323427 | TargetStartDate | Target Start Date | Configuration > [Career Section] Administration > Career Sections > Career Section name > [Career Portal Pages] Show > Job List > Edit User-defined Labels |
| 323427 | TargetStartDate | Target Start Date | Configuration > [Career Section] Administration > Career Sections > Career Section name > [Career Portal Pages] Show > My Job Cart > Edit User-defined Labels |
| 323427 | TargetStartDate | Target Start Date | Configuration > [Career Section] Administration > Career Sections > Career Section name > [Career Portal Pages] Show > My Referrals > Edit User-defined Labels |
| 323427 | TargetStartDate | Target Start Date | Configuration > [Career Section] Administration > Career Sections > Career Section name > [Career Portal Pages] Show > My Submissions > Edit User-defined Labels |
| 323430 | MaximumSalary | Maximum Salary | Configuration > [Career Section] Administration > Career Sections > Career Section name > [Career Portal Pages] Show > Advanced Search > Edit User-defined Labels |
| 323430 | MaximumSalary | Maximum Salary | Configuration > [Career Section] Administration > Career Sections > Career Section name > [Career Portal Pages] Show > Basic Search > Edit User-defined Labels |
| 323430 | MaximumSalary | Maximum Salary | Configuration > [Career Section] Administration > Career Sections > Career Section name > [Career Portal Pages] Show > Basic Search > Edit User-defined Labels |
| 323430 | MaximumSalary | Maximum Salary | Configuration > [Career Section] Administration > Career Sections > Career Section name > [Career Portal Pages] Show > Job Description > Edit User-defined Labels |
| 323430 | MaximumSalary | Maximum Salary | Configuration > [Career Section] Administration > Career Sections > Career Section name > [Career Portal Pages] Show > Job List > Edit User-defined Labels |
| 323430 | MaximumSalary | Maximum Salary | Configuration > [Career Section] Administration > Career Sections > Career Section name > [Career Portal Pages] Show > My Job Cart > Edit User-defined Labels |
| 323430 | MaximumSalary | Maximum Salary | Configuration > [Career Section] Administration > Career Sections > Career Section name > [Career Portal Pages] Show > My Referrals > Edit User-defined Labels |
| 323430 | MaximumSalary | Maximum Salary | Configuration > [Career Section] Administration > Career Sections > Career Section name > [Career Portal Pages] Show > My Submissions > Edit User-defined Labels |
| 323436 | DescriptionExtText | Description | Configuration > [Career Section] Administration > Career Sections > Career Section name > [Career Portal Pages] Show > Advanced Search > Edit User-defined Labels |

| ID | NAME | TALEO DEFAULT VALUE | LOCATION |
|--------|--------------------|---------------------|---|
| 323436 | DescriptionExtText | Description | Configuration > [Career Section] Administration > Career Sections > Career Section name > [Career Portal Pages] Show > Basic Search > Edit User-defined Labels |
| 323436 | DescriptionExtText | Description | Configuration > [Career Section] Administration > Career Sections > Career Section name > [Career Portal Pages] Show > Basic Search > Edit User-defined Labels |
| 323436 | DescriptionExtText | Description | Configuration > [Career Section] Administration > Career Sections > Career Section name > [Career Portal Pages] Show > Job Description > Edit User-defined Labels |
| 323436 | DescriptionExtText | Description | Configuration > [Career Section] Administration > Career Sections > Career Section name > [Career Portal Pages] Show > Job List > Edit User-defined Labels |
| 323436 | DescriptionExtText | Description | Configuration > [Career Section] Administration > Career Sections > Career Section name > [Career Portal Pages] Show > My Job Cart > Edit User-defined Labels |
| 323436 | DescriptionExtText | Description | Configuration > [Career Section] Administration > Career Sections > Career Section name > [Career Portal Pages] Show > My Referrals > Edit User-defined Labels |
| 323436 | DescriptionExtText | Description | Configuration > [Career Section] Administration > Career Sections > Career Section name > [Career Portal Pages] Show > My Submissions > Edit User-defined Labels |
| 323439 | DescriptionIntText | Description | Configuration > [Career Section] Administration > Career Sections > Career Section name > [Career Portal Pages] Show > Advanced Search > Edit User-defined Labels |
| 323439 | DescriptionIntText | Description | Configuration > [Career Section] Administration > Career Sections > Career Section name > [Career Portal Pages] Show > Basic Search > Edit User-defined Labels |
| 323439 | DescriptionIntText | Description | Configuration > [Career Section] Administration > Career Sections > Career Section name > [Career Portal Pages] Show > Basic Search > Edit User-defined Labels |
| 323439 | DescriptionIntText | Description | Configuration > [Career Section] Administration > Career Sections > Career Section name > [Career Portal Pages] Show > Job Description > Edit User-defined Labels |
| 323439 | DescriptionIntText | Description | Configuration > [Career Section] Administration > Career Sections > Career Section name > [Career Portal Pages] Show > Job List > Edit User-defined Labels |
| 323439 | DescriptionIntText | Description | Configuration > [Career Section] Administration > Career Sections > Career Section name > [Career Portal Pages] Show > My Job Cart > Edit User-defined Labels |
| 323439 | DescriptionIntText | Description | Configuration > [Career Section] Administration > Career Sections > Career Section name > [Career Portal Pages] Show > My Referrals > Edit User-defined Labels |
| 323439 | DescriptionIntText | Description | Configuration > [Career Section] Administration > Career Sections > Career Section name > [Career Portal Pages] Show > My Submissions > Edit User-defined Labels |

| ID | NAME | TALEO DEFAULT VALUE | LOCATION |
|--------|---------------------------|---------------------------------|---|
| 323442 | ERTEExternalBonusAmount | Public Referral Bonus | Configuration > [Career Section] Administration > Career Sections > Career Section name > [Career Portal Pages] Show > Advanced Search > Edit User-defined Labels |
| 323442 | ERTEExternalBonusAmount | Public Referral Bonus | Configuration > [Career Section] Administration > Career Sections > Career Section name > [Career Portal Pages] Show > Basic Search > Edit User-defined Labels |
| 323442 | ERTEExternalBonusAmount | Public Referral Bonus | Configuration > [Career Section] Administration > Career Sections > Career Section name > [Career Portal Pages] Show > Basic Search > Edit User-defined Labels |
| 323442 | ERTEExternalBonusAmount | Public Referral Bonus | Configuration > [Career Section] Administration > Career Sections > Career Section name > [Career Portal Pages] Show > Job Description > Edit User-defined Labels |
| 323442 | ERTEExternalBonusAmount | Public Referral Bonus | Configuration > [Career Section] Administration > Career Sections > Career Section name > [Career Portal Pages] Show > Job List > Edit User-defined Labels |
| 323442 | ERTEExternalBonusAmount | Public Referral Bonus | Configuration > [Career Section] Administration > Career Sections > Career Section name > [Career Portal Pages] Show > My Job Cart > Edit User-defined Labels |
| 323442 | ERTEExternalBonusAmount | Public Referral Bonus | Configuration > [Career Section] Administration > Career Sections > Career Section name > [Career Portal Pages] Show > My Referrals > Edit User-defined Labels |
| 323442 | ERTEExternalBonusAmount | Public Referral Bonus | Configuration > [Career Section] Administration > Career Sections > Career Section name > [Career Portal Pages] Show > My Submissions > Edit User-defined Labels |
| 323445 | ERTEExternalBonusTracking | Public Referral Bonus Activated | Configuration > [Career Section] Administration > Career Sections > Career Section name > [Career Portal Pages] Show > Advanced Search > Edit User-defined Labels |
| 323445 | ERTEExternalBonusTracking | Public Referral Bonus Activated | Configuration > [Career Section] Administration > Career Sections > Career Section name > [Career Portal Pages] Show > Basic Search > Edit User-defined Labels |
| 323445 | ERTEExternalBonusTracking | Public Referral Bonus Activated | Configuration > [Career Section] Administration > Career Sections > Career Section name > [Career Portal Pages] Show > Basic Search > Edit User-defined Labels |
| 323445 | ERTEExternalBonusTracking | Public Referral Bonus Activated | Configuration > [Career Section] Administration > Career Sections > Career Section name > [Career Portal Pages] Show > Job Description > Edit User-defined Labels |
| 323445 | ERTEExternalBonusTracking | Public Referral Bonus Activated | Configuration > [Career Section] Administration > Career Sections > Career Section name > [Career Portal Pages] Show > Job List > Edit User-defined Labels |
| 323445 | ERTEExternalBonusTracking | Public Referral Bonus Activated | Configuration > [Career Section] Administration > Career Sections > Career Section name > [Career Portal Pages] Show > My Job Cart > Edit User-defined Labels |
| 323445 | ERTEExternalBonusTracking | Public Referral Bonus Activated | Configuration > [Career Section] Administration > Career Sections > Career Section name > [Career Portal Pages] Show > My Referrals > Edit User-defined Labels |

| ID | NAME | TALEO DEFAULT VALUE | LOCATION |
|--------|--------------------------|-----------------------------------|---|
| 323445 | ERTExternalBonusTracking | Public Referral Bonus Activated | Configuration > [Career Section] Administration > Career Sections > Career Section name > [Career Portal Pages] Show > My Submissions > Edit User-defined Labels |
| 323448 | ERTInternalBonusAmount | Employee Referral Bonus | Configuration > [Career Section] Administration > Career Sections > Career Section name > [Career Portal Pages] Show > Advanced Search > Edit User-defined Labels |
| 323448 | ERTInternalBonusAmount | Employee Referral Bonus | Configuration > [Career Section] Administration > Career Sections > Career Section name > [Career Portal Pages] Show > Basic Search > Edit User-defined Labels |
| 323448 | ERTInternalBonusAmount | Employee Referral Bonus | Configuration > [Career Section] Administration > Career Sections > Career Section name > [Career Portal Pages] Show > Basic Search > Edit User-defined Labels |
| 323448 | ERTInternalBonusAmount | Employee Referral Bonus | Configuration > [Career Section] Administration > Career Sections > Career Section name > [Career Portal Pages] Show > Job Description > Edit User-defined Labels |
| 323448 | ERTInternalBonusAmount | Employee Referral Bonus | Configuration > [Career Section] Administration > Career Sections > Career Section name > [Career Portal Pages] Show > Job List > Edit User-defined Labels |
| 323448 | ERTInternalBonusAmount | Employee Referral Bonus | Configuration > [Career Section] Administration > Career Sections > Career Section name > [Career Portal Pages] Show > My Job Cart > Edit User-defined Labels |
| 323448 | ERTInternalBonusAmount | Employee Referral Bonus | Configuration > [Career Section] Administration > Career Sections > Career Section name > [Career Portal Pages] Show > My Referrals > Edit User-defined Labels |
| 323448 | ERTInternalBonusAmount | Employee Referral Bonus | Configuration > [Career Section] Administration > Career Sections > Career Section name > [Career Portal Pages] Show > My Submissions > Edit User-defined Labels |
| 323451 | ERTInternalBonusTracking | Employee Referral Bonus Activated | Configuration > [Career Section] Administration > Career Sections > Career Section name > [Career Portal Pages] Show > Advanced Search > Edit User-defined Labels |
| 323451 | ERTInternalBonusTracking | Employee Referral Bonus Activated | Configuration > [Career Section] Administration > Career Sections > Career Section name > [Career Portal Pages] Show > Basic Search > Edit User-defined Labels |
| 323451 | ERTInternalBonusTracking | Employee Referral Bonus Activated | Configuration > [Career Section] Administration > Career Sections > Career Section name > [Career Portal Pages] Show > Basic Search > Edit User-defined Labels |
| 323451 | ERTInternalBonusTracking | Employee Referral Bonus Activated | Configuration > [Career Section] Administration > Career Sections > Career Section name > [Career Portal Pages] Show > Job Description > Edit User-defined Labels |
| 323451 | ERTInternalBonusTracking | Employee Referral Bonus Activated | Configuration > [Career Section] Administration > Career Sections > Career Section name > [Career Portal Pages] Show > Job List > Edit User-defined Labels |
| 323451 | ERTInternalBonusTracking | Employee Referral Bonus Activated | Configuration > [Career Section] Administration > Career Sections > Career Section name > [Career Portal Pages] Show > My Job Cart > Edit User-defined Labels |

| ID | NAME | TALEO DEFAULT VALUE | LOCATION |
|--------|--------------------------|-----------------------------------|---|
| 323451 | ERTInternalBonusTracking | Employee Referral Bonus Activated | Configuration > [Career Section] Administration > Career Sections > Career Section name > [Career Portal Pages] Show > My Referrals > Edit User-defined Labels |
| 323451 | ERTInternalBonusTracking | Employee Referral Bonus Activated | Configuration > [Career Section] Administration > Career Sections > Career Section name > [Career Portal Pages] Show > My Submissions > Edit User-defined Labels |
| 323454 | EmployeeStatus | Employee Status | Configuration > [Career Section] Administration > Career Sections > Career Section name > [Career Portal Pages] Show > Advanced Search > Edit User-defined Labels |
| 323454 | EmployeeStatus | Employee Status | Configuration > [Career Section] Administration > Career Sections > Career Section name > [Career Portal Pages] Show > Basic Search > Edit User-defined Labels |
| 323454 | EmployeeStatus | Employee Status | Configuration > [Career Section] Administration > Career Sections > Career Section name > [Career Portal Pages] Show > Basic Search > Edit User-defined Labels |
| 323454 | EmployeeStatus | Employee Status | Configuration > [Career Section] Administration > Career Sections > Career Section name > [Career Portal Pages] Show > Job Description > Edit User-defined Labels |
| 323454 | EmployeeStatus | Employee Status | Configuration > [Career Section] Administration > Career Sections > Career Section name > [Career Portal Pages] Show > Job List > Edit User-defined Labels |
| 323454 | EmployeeStatus | Employee Status | Configuration > [Career Section] Administration > Career Sections > Career Section name > [Career Portal Pages] Show > My Job Cart > Edit User-defined Labels |
| 323454 | EmployeeStatus | Employee Status | Configuration > [Career Section] Administration > Career Sections > Career Section name > [Career Portal Pages] Show > My Referrals > Edit User-defined Labels |
| 323454 | EmployeeStatus | Employee Status | Configuration > [Career Section] Administration > Career Sections > Career Section name > [Career Portal Pages] Show > My Submissions > Edit User-defined Labels |
| 323457 | JobLevel | Job Level | Configuration > [Career Section] Administration > Career Sections > Career Section name > [Career Portal Pages] Show > Advanced Search > Edit User-defined Labels |
| 323457 | JobLevel | Job Level | Configuration > [Career Section] Administration > Career Sections > Career Section name > [Career Portal Pages] Show > Basic Search > Edit User-defined Labels |
| 323457 | JobLevel | Job Level | Configuration > [Career Section] Administration > Career Sections > Career Section name > [Career Portal Pages] Show > Basic Search > Edit User-defined Labels |
| 323457 | JobLevel | Job Level | Configuration > [Career Section] Administration > Career Sections > Career Section name > [Career Portal Pages] Show > Job Description > Edit User-defined Labels |
| 323457 | JobLevel | Job Level | Configuration > [Career Section] Administration > Career Sections > Career Section name > [Career Portal Pages] Show > Job List > Edit User-defined Labels |

| ID | NAME | TALEO DEFAULT VALUE | LOCATION |
|--------|-------------|---------------------|---|
| 323457 | JobLevel | Job Level | Configuration > [Career Section] Administration > Career Sections > Career Section name > [Career Portal Pages] Show > My Job Cart > Edit User-defined Labels |
| 323457 | JobLevel | Job Level | Configuration > [Career Section] Administration > Career Sections > Career Section name > [Career Portal Pages] Show > My Referrals > Edit User-defined Labels |
| 323457 | JobLevel | Job Level | Configuration > [Career Section] Administration > Career Sections > Career Section name > [Career Portal Pages] Show > My Submissions > Edit User-defined Labels |
| 323460 | JobSchedule | Schedule | Configuration > [Career Section] Administration > Career Sections > Career Section name > [Career Portal Pages] Show > Advanced Search > Edit User-defined Labels |
| 323460 | JobSchedule | Schedule | Configuration > [Career Section] Administration > Career Sections > Career Section name > [Career Portal Pages] Show > Basic Search > Edit User-defined Labels |
| 323460 | JobSchedule | Schedule | Configuration > [Career Section] Administration > Career Sections > Career Section name > [Career Portal Pages] Show > Basic Search > Edit User-defined Labels |
| 323460 | JobSchedule | Schedule | Configuration > [Career Section] Administration > Career Sections > Career Section name > [Career Portal Pages] Show > Job Description > Edit User-defined Labels |
| 323460 | JobSchedule | Schedule | Configuration > [Career Section] Administration > Career Sections > Career Section name > [Career Portal Pages] Show > Job List > Edit User-defined Labels |
| 323460 | JobSchedule | Schedule | Configuration > [Career Section] Administration > Career Sections > Career Section name > [Career Portal Pages] Show > My Job Cart > Edit User-defined Labels |
| 323460 | JobSchedule | Schedule | Configuration > [Career Section] Administration > Career Sections > Career Section name > [Career Portal Pages] Show > My Referrals > Edit User-defined Labels |
| 323460 | JobSchedule | Schedule | Configuration > [Career Section] Administration > Career Sections > Career Section name > [Career Portal Pages] Show > My Submissions > Edit User-defined Labels |
| 323463 | JobShift | Shift | Configuration > [Career Section] Administration > Career Sections > Career Section name > [Career Portal Pages] Show > Advanced Search > Edit User-defined Labels |
| 323463 | JobShift | Shift | Configuration > [Career Section] Administration > Career Sections > Career Section name > [Career Portal Pages] Show > Basic Search > Edit User-defined Labels |
| 323463 | JobShift | Shift | Configuration > [Career Section] Administration > Career Sections > Career Section name > [Career Portal Pages] Show > Basic Search > Edit User-defined Labels |
| 323463 | JobShift | Shift | Configuration > [Career Section] Administration > Career Sections > Career Section name > [Career Portal Pages] Show > Job Description > Edit User-defined Labels |

| ID | NAME | TALEO DEFAULT VALUE | LOCATION |
|--------|----------------------|---------------------|---|
| 323463 | JobShift | Shift | Configuration > [Career Section] Administration > Career Sections > Career Section name > [Career Portal Pages] Show > Job List > Edit User-defined Labels |
| 323463 | JobShift | Shift | Configuration > [Career Section] Administration > Career Sections > Career Section name > [Career Portal Pages] Show > My Job Cart > Edit User-defined Labels |
| 323463 | JobShift | Shift | Configuration > [Career Section] Administration > Career Sections > Career Section name > [Career Portal Pages] Show > My Referrals > Edit User-defined Labels |
| 323463 | JobShift | Shift | Configuration > [Career Section] Administration > Career Sections > Career Section name > [Career Portal Pages] Show > My Submissions > Edit User-defined Labels |
| 323466 | JobType | Job Type | Configuration > [Career Section] Administration > Career Sections > Career Section name > [Career Portal Pages] Show > Advanced Search > Edit User-defined Labels |
| 323466 | JobType | Job Type | Configuration > [Career Section] Administration > Career Sections > Career Section name > [Career Portal Pages] Show > Basic Search > Edit User-defined Labels |
| 323466 | JobType | Job Type | Configuration > [Career Section] Administration > Career Sections > Career Section name > [Career Portal Pages] Show > Basic Search > Edit User-defined Labels |
| 323466 | JobType | Job Type | Configuration > [Career Section] Administration > Career Sections > Career Section name > [Career Portal Pages] Show > Job Description > Edit User-defined Labels |
| 323466 | JobType | Job Type | Configuration > [Career Section] Administration > Career Sections > Career Section name > [Career Portal Pages] Show > Job List > Edit User-defined Labels |
| 323466 | JobType | Job Type | Configuration > [Career Section] Administration > Career Sections > Career Section name > [Career Portal Pages] Show > My Job Cart > Edit User-defined Labels |
| 323466 | JobType | Job Type | Configuration > [Career Section] Administration > Career Sections > Career Section name > [Career Portal Pages] Show > My Referrals > Edit User-defined Labels |
| 323466 | JobType | Job Type | Configuration > [Career Section] Administration > Career Sections > Career Section name > [Career Portal Pages] Show > My Submissions > Edit User-defined Labels |
| 323469 | QualificationExtText | Qualifications | Configuration > [Career Section] Administration > Career Sections > Career Section name > [Career Portal Pages] Show > Advanced Search > Edit User-defined Labels |
| 323469 | QualificationExtText | Qualifications | Configuration > [Career Section] Administration > Career Sections > Career Section name > [Career Portal Pages] Show > Basic Search > Edit User-defined Labels |
| 323469 | QualificationExtText | Qualifications | Configuration > [Career Section] Administration > Career Sections > Career Section name > [Career Portal Pages] Show > Basic Search > Edit User-defined Labels |

| ID | NAME | TALEO DEFAULT VALUE | LOCATION |
|--------|----------------------|---------------------|---|
| 323469 | QualificationExtText | Qualifications | Configuration > [Career Section] Administration > Career Sections > Career Section name > [Career Portal Pages] Show > Job Description > Edit User-defined Labels |
| 323469 | QualificationExtText | Qualifications | Configuration > [Career Section] Administration > Career Sections > Career Section name > [Career Portal Pages] Show > Job List > Edit User-defined Labels |
| 323469 | QualificationExtText | Qualifications | Configuration > [Career Section] Administration > Career Sections > Career Section name > [Career Portal Pages] Show > My Job Cart > Edit User-defined Labels |
| 323469 | QualificationExtText | Qualifications | Configuration > [Career Section] Administration > Career Sections > Career Section name > [Career Portal Pages] Show > My Referrals > Edit User-defined Labels |
| 323469 | QualificationExtText | Qualifications | Configuration > [Career Section] Administration > Career Sections > Career Section name > [Career Portal Pages] Show > My Submissions > Edit User-defined Labels |
| 323472 | QualificationIntText | Qualifications | Configuration > [Career Section] Administration > Career Sections > Career Section name > [Career Portal Pages] Show > Advanced Search > Edit User-defined Labels |
| 323472 | QualificationIntText | Qualifications | Configuration > [Career Section] Administration > Career Sections > Career Section name > [Career Portal Pages] Show > Basic Search > Edit User-defined Labels |
| 323472 | QualificationIntText | Qualifications | Configuration > [Career Section] Administration > Career Sections > Career Section name > [Career Portal Pages] Show > Basic Search > Edit User-defined Labels |
| 323472 | QualificationIntText | Qualifications | Configuration > [Career Section] Administration > Career Sections > Career Section name > [Career Portal Pages] Show > Job Description > Edit User-defined Labels |
| 323472 | QualificationIntText | Qualifications | Configuration > [Career Section] Administration > Career Sections > Career Section name > [Career Portal Pages] Show > Job List > Edit User-defined Labels |
| 323472 | QualificationIntText | Qualifications | Configuration > [Career Section] Administration > Career Sections > Career Section name > [Career Portal Pages] Show > My Job Cart > Edit User-defined Labels |
| 323472 | QualificationIntText | Qualifications | Configuration > [Career Section] Administration > Career Sections > Career Section name > [Career Portal Pages] Show > My Referrals > Edit User-defined Labels |
| 323472 | QualificationIntText | Qualifications | Configuration > [Career Section] Administration > Career Sections > Career Section name > [Career Portal Pages] Show > My Submissions > Edit User-defined Labels |
| 323475 | StudyLevel | Education Level | Configuration > [Career Section] Administration > Career Sections > Career Section name > [Career Portal Pages] Show > Advanced Search > Edit User-defined Labels |
| 323475 | StudyLevel | Education Level | Configuration > [Career Section] Administration > Career Sections > Career Section name > [Career Portal Pages] Show > Basic Search > Edit User-defined Labels |

| ID | NAME | TALEO DEFAULT VALUE | LOCATION |
|--------|------------|---------------------|---|
| 323475 | StudyLevel | Education Level | Configuration > [Career Section] Administration > Career Sections > Career Section name > [Career Portal Pages] Show > Basic Search > Edit User-defined Labels |
| 323475 | StudyLevel | Education Level | Configuration > [Career Section] Administration > Career Sections > Career Section name > [Career Portal Pages] Show > Job Description > Edit User-defined Labels |
| 323475 | StudyLevel | Education Level | Configuration > [Career Section] Administration > Career Sections > Career Section name > [Career Portal Pages] Show > Job List > Edit User-defined Labels |
| 323475 | StudyLevel | Education Level | Configuration > [Career Section] Administration > Career Sections > Career Section name > [Career Portal Pages] Show > My Job Cart > Edit User-defined Labels |
| 323475 | StudyLevel | Education Level | Configuration > [Career Section] Administration > Career Sections > Career Section name > [Career Portal Pages] Show > My Referrals > Edit User-defined Labels |
| 323475 | StudyLevel | Education Level | Configuration > [Career Section] Administration > Career Sections > Career Section name > [Career Portal Pages] Show > My Submissions > Edit User-defined Labels |
| 323478 | Title | Title | Configuration > [Career Section] Administration > Career Sections > Career Section name > [Career Portal Pages] Show > Advanced Search > Edit User-defined Labels |
| 323478 | Title | Title | Configuration > [Career Section] Administration > Career Sections > Career Section name > [Career Portal Pages] Show > Basic Search > Edit User-defined Labels |
| 323478 | Title | Title | Configuration > [Career Section] Administration > Career Sections > Career Section name > [Career Portal Pages] Show > Basic Search > Edit User-defined Labels |
| 323478 | Title | Title | Configuration > [Career Section] Administration > Career Sections > Career Section name > [Career Portal Pages] Show > Job Description > Edit User-defined Labels |
| 323478 | Title | Title | Configuration > [Career Section] Administration > Career Sections > Career Section name > [Career Portal Pages] Show > Job List > Edit User-defined Labels |
| 323478 | Title | Title | Configuration > [Career Section] Administration > Career Sections > Career Section name > [Career Portal Pages] Show > My Job Cart > Edit User-defined Labels |
| 323478 | Title | Title | Configuration > [Career Section] Administration > Career Sections > Career Section name > [Career Portal Pages] Show > My Referrals > Edit User-defined Labels |
| 323478 | Title | Title | Configuration > [Career Section] Administration > Career Sections > Career Section name > [Career Portal Pages] Show > My Submissions > Edit User-defined Labels |
| 323481 | WillTravel | Travel | Configuration > [Career Section] Administration > Career Sections > Career Section name > [Career Portal Pages] Show > Advanced Search > Edit User-defined Labels |

| ID | NAME | TALEO DEFAULT VALUE | LOCATION |
|--------|--------------|---------------------|---|
| 323481 | WillTravel | Travel | Configuration > [Career Section] Administration > Career Sections > Career Section name > [Career Portal Pages] Show > Basic Search > Edit User-defined Labels |
| 323481 | WillTravel | Travel | Configuration > [Career Section] Administration > Career Sections > Career Section name > [Career Portal Pages] Show > Basic Search > Edit User-defined Labels |
| 323481 | WillTravel | Travel | Configuration > [Career Section] Administration > Career Sections > Career Section name > [Career Portal Pages] Show > Job Description > Edit User-defined Labels |
| 323481 | WillTravel | Travel | Configuration > [Career Section] Administration > Career Sections > Career Section name > [Career Portal Pages] Show > Job List > Edit User-defined Labels |
| 323481 | WillTravel | Travel | Configuration > [Career Section] Administration > Career Sections > Career Section name > [Career Portal Pages] Show > My Job Cart > Edit User-defined Labels |
| 323481 | WillTravel | Travel | Configuration > [Career Section] Administration > Career Sections > Career Section name > [Career Portal Pages] Show > My Referrals > Edit User-defined Labels |
| 323481 | WillTravel | Travel | Configuration > [Career Section] Administration > Career Sections > Career Section name > [Career Portal Pages] Show > My Submissions > Edit User-defined Labels |
| 329423 | Description1 | | Configuration > [Career Section] Administration > Career Sections > Career Section name > [Career Portal Pages] Show > My Submissions > Edit User-defined Labels |
| 329430 | Description2 | | Configuration > [Career Section] Administration > Career Sections > Career Section name > [Career Portal Pages] Show > My Submissions > Edit User-defined Labels |
| 329437 | Description3 | | Configuration > [Career Section] Administration > Career Sections > Career Section name > [Career Portal Pages] Show > My Submissions > Edit User-defined Labels |
| 329444 | Title1 | | Configuration > [Career Section] Administration > Career Sections > Career Section name > [Career Portal Pages] Show > My Submissions > Edit User-defined Labels |
| 329451 | Title2 | | Configuration > [Career Section] Administration > Career Sections > Career Section name > [Career Portal Pages] Show > My Submissions > Edit User-defined Labels |
| 329458 | Title3 | | Configuration > [Career Section] Administration > Career Sections > Career Section name > [Career Portal Pages] Show > My Submissions > Edit User-defined Labels |
| 329468 | Description1 | | Configuration > [Career Section] Administration > Career Sections > Career Section name > [Career Portal Pages] Show > My Submissions > Edit User-defined Labels |
| 329475 | Description2 | | Configuration > [Career Section] Administration > Career Sections > Career Section name > [Career Portal Pages] Show > My Submissions > Edit User-defined Labels |

| ID | NAME | TALEO DEFAULT VALUE | LOCATION |
|--------|--------------------------------|--|--|
| 329482 | Description3 | | Configuration > [Career Section] Administration > Career Sections > Career Section name > [Career Portal Pages] Show > My Submissions > Edit User-defined Labels |
| 329489 | Title1 | | Configuration > [Career Section] Administration > Career Sections > Career Section name > [Career Portal Pages] Show > My Submissions > Edit User-defined Labels |
| 329496 | Title2 | | Configuration > [Career Section] Administration > Career Sections > Career Section name > [Career Portal Pages] Show > My Submissions > Edit User-defined Labels |
| 329503 | Title3 | | Configuration > [Career Section] Administration > Career Sections > Career Section name > [Career Portal Pages] Show > My Submissions > Edit User-defined Labels |
| 329520 | MyMessagesListTitle | My Messages | Configuration > [Career Section] Administration > Career Sections > Career Section name > [Career Portal Pages] Show > My Submissions > Edit User-defined Labels |
| 329660 | PrintableFormatActionTT | View a printable version of the message | Configuration > [Career Section] Administration > Career Sections > Career Section name > [Career Portal Pages] Show > My Submissions > Edit User-defined Labels |
| 329678 | BackAction | Back | Configuration > [Career Section] Administration > Career Sections > Career Section name > [Career Portal Pages] Show > My Submissions > Edit User-defined Labels |
| 329685 | BackActionTT | Return to the previous page | Configuration > [Career Section] Administration > Career Sections > Career Section name > [Career Portal Pages] Show > My Submissions > Edit User-defined Labels |
| 329692 | MessageTitleTT | View the content of this message | Configuration > [Career Section] Administration > Career Sections > Career Section name > [Career Portal Pages] Show > My Submissions > Edit User-defined Labels |
| 330320 | MessageXOfY | Message {0} out of {1} | Configuration > [Career Section] Administration > Career Sections > Career Section name > [Career Portal Pages] Show > My Submissions > Edit User-defined Labels |
| 330345 | MessageDetailTitle | Messages | Configuration > [Career Section] Administration > Career Sections > Career Section name > [Career Portal Pages] Show > My Submissions > Edit User-defined Labels |
| 330369 | DeleteMessageConfirmationTitle | You are about to delete the message "{0}". | Configuration > [Career Section] Administration > Career Sections > Career Section name > [Career Portal Pages] Show > My Submissions > Edit User-defined Labels |
| 330376 | DeleteMessageText | Are you sure that you want to delete it? | Configuration > [Career Section] Administration > Career Sections > Career Section name > [Career Portal Pages] Show > My Submissions > Edit User-defined Labels |
| 330383 | NoCommand | No | Configuration > [Career Section] Administration > Career Sections > Career Section name > [Career Portal Pages] Show > My Submissions > Edit User-defined Labels |
| 330386 | NoCommandTT | Cancel the action | Configuration > [Career Section] Administration > Career Sections > Career Section name > [Career Portal Pages] Show > My Submissions > Edit User-defined Labels |

| ID | NAME | TALEO DEFAULT VALUE | LOCATION |
|--------|---------------------------------|--|---|
| 330393 | YesCommand | Yes | Configuration > [Career Section] Administration > Career Sections > Career Section name > [Career Portal Pages] Show > My Submissions > Edit User-defined Labels |
| 330396 | YesCommandTT | Delete the message | Configuration > [Career Section] Administration > Career Sections > Career Section name > [Career Portal Pages] Show > My Submissions > Edit User-defined Labels |
| 334104 | JobID | Job Number : | Configuration > [Career Section] Administration > Career Sections > Career Section name > [Career Portal Pages] Show > Job Description > Edit User-defined Labels |
| 335487 | MyAccountEditorPageTitle | My Account Editor - {0} | Configuration > [Career Section] Administration > Career Sections > Career Section name > [Career Portal Pages] Show > Job List > Edit User-defined Labels |
| 336106 | LastAccessSubmissionsList | Last Access to the Submissions List | Configuration > [Career Section] Administration > Career Sections > Career Section name > [Career Portal Pages] Show > Job List > Edit User-defined Labels |
| 336117 | LastAccessReferralsList | Last Access to the Referrals List | Configuration > [Career Section] Administration > Career Sections > Career Section name > [Career Portal Pages] Show > Job List > Edit User-defined Labels |
| 336136 | PersonallInformation | Personal Information | Configuration > [Career Section] Administration > Career Sections > Career Section name > [Career Portal Pages] Show > Job List > Edit User-defined Labels |
| 336180 | PersonallInformationEditorTitle | This page allows you to modify or update your personal data. | Configuration > [Career Section] Administration > Career Sections > Career Section name > [Career Portal Pages] Show > Job List > Edit User-defined Labels |
| 336192 | Description1 | | Configuration > [Career Section] Administration > Career Sections > Career Section name > [Career Portal Pages] Show > Job List > Edit User-defined Labels |
| 336199 | Description2 | | Configuration > [Career Section] Administration > Career Sections > Career Section name > [Career Portal Pages] Show > Job List > Edit User-defined Labels |
| 336206 | Description3 | | Configuration > [Career Section] Administration > Career Sections > Career Section name > [Career Portal Pages] Show > Job List > Edit User-defined Labels |
| 336213 | Title1 | | Configuration > [Career Section] Administration > Career Sections > Career Section name > [Career Portal Pages] Show > Job List > Edit User-defined Labels |
| 336220 | Title2 | | Configuration > [Career Section] Administration > Career Sections > Career Section name > [Career Portal Pages] Show > Job List > Edit User-defined Labels |
| 336227 | Title3 | | Configuration > [Career Section] Administration > Career Sections > Career Section name > [Career Portal Pages] Show > Job List > Edit User-defined Labels |
| 336237 | Description1 | | Configuration > [Career Section] Administration > Career Sections > Career Section name > [Career Portal Pages] Show > Job List > Edit User-defined Labels |

| ID | NAME | TALEO DEFAULT VALUE | LOCATION |
|--------|-----------------------------|--|--|
| 336244 | Description2 | | Configuration > [Career Section] Administration > Career Sections > Career Section name > [Career Portal Pages] Show > Job List > Edit User-defined Labels |
| 336251 | Description3 | | Configuration > [Career Section] Administration > Career Sections > Career Section name > [Career Portal Pages] Show > Job List > Edit User-defined Labels |
| 336258 | Title1 | | Configuration > [Career Section] Administration > Career Sections > Career Section name > [Career Portal Pages] Show > Job List > Edit User-defined Labels |
| 336265 | Title2 | | Configuration > [Career Section] Administration > Career Sections > Career Section name > [Career Portal Pages] Show > Job List > Edit User-defined Labels |
| 336272 | Title3 | | Configuration > [Career Section] Administration > Career Sections > Career Section name > [Career Portal Pages] Show > Job List > Edit User-defined Labels |
| 336282 | Description1 | | Configuration > [Career Section] Administration > Career Sections > Career Section name > [Career Portal Pages] Show > Job List > Edit User-defined Labels |
| 336289 | Description2 | | Configuration > [Career Section] Administration > Career Sections > Career Section name > [Career Portal Pages] Show > Job List > Edit User-defined Labels |
| 336296 | Description3 | | Configuration > [Career Section] Administration > Career Sections > Career Section name > [Career Portal Pages] Show > Job List > Edit User-defined Labels |
| 336303 | Title1 | | Configuration > [Career Section] Administration > Career Sections > Career Section name > [Career Portal Pages] Show > Job List > Edit User-defined Labels |
| 336310 | Title2 | | Configuration > [Career Section] Administration > Career Sections > Career Section name > [Career Portal Pages] Show > Job List > Edit User-defined Labels |
| 336317 | Title3 | | Configuration > [Career Section] Administration > Career Sections > Career Section name > [Career Portal Pages] Show > Job List > Edit User-defined Labels |
| 336324 | LoginInformationEditorTitle | This page allows you to modify or update your login information. | Configuration > [Career Section] Administration > Career Sections > Career Section name > [Career Portal Pages] Show > Job List > Edit User-defined Labels |
| 336341 | SignInAndPassword | Sign In and Password | Configuration > [Career Section] Administration > Career Sections > Career Section name > [Career Portal Pages] Show > Job List > Edit User-defined Labels |
| 336352 | SecurityQuestions | Security Questions | Configuration > [Career Section] Administration > Career Sections > Career Section name > [Career Portal Pages] Show > Job List > Edit User-defined Labels |
| 336391 | FirstSecurityQuestion | First Security Question | Configuration > [Career Section] Administration > Career Sections > Career Section name > [Career Portal Pages] Show > Job List > Edit User-defined Labels |

| ID | NAME | TALEO DEFAULT VALUE | LOCATION |
|--------|------------------------------|---|---|
| 336398 | SecondSecurityQuestion | Second Security Question | Configuration > [Career Section] Administration > Career Sections > Career Section name > [Career Portal Pages] Show > Job List > Edit User-defined Labels |
| 336413 | ThirdSecurityQuestion | Third Security Question | Configuration > [Career Section] Administration > Career Sections > Career Section name > [Career Portal Pages] Show > Job List > Edit User-defined Labels |
| 336426 | FirstSecurityAnswer | Answer to the First Security Question | Configuration > [Career Section] Administration > Career Sections > Career Section name > [Career Portal Pages] Show > Job List > Edit User-defined Labels |
| 336433 | MessagesEditorTitle | This page allows you to modify or update your email notification options. | Configuration > [Career Section] Administration > Career Sections > Career Section name > [Career Portal Pages] Show > Job List > Edit User-defined Labels |
| 336448 | RejectionLetterNotification | Send me a rejection letter when my job submission is not selected. | Configuration > [Career Section] Administration > Career Sections > Career Section name > [Career Portal Pages] Show > Job List > Edit User-defined Labels |
| 336486 | Correspondence | Correspondence | Configuration > [Career Section] Administration > Career Sections > Career Section name > [Career Portal Pages] Show > Job List > Edit User-defined Labels |
| 336505 | SecondSecurityAnswer | Answer to the Second Security Question | Configuration > [Career Section] Administration > Career Sections > Career Section name > [Career Portal Pages] Show > Job List > Edit User-defined Labels |
| 336538 | ThirdSecurityAnswer | Answer to the Third Security Question | Configuration > [Career Section] Administration > Career Sections > Career Section name > [Career Portal Pages] Show > Job List > Edit User-defined Labels |
| 337123 | PrintableFormat | Printable Format | Configuration > [Career Section] Administration > Career Sections > Career Section name > [Career Portal Pages] Show > Job Description > Edit User-defined Labels |
| 337130 | PrintableFormatTT | View a printable version of the job description | Configuration > [Career Section] Administration > Career Sections > Career Section name > [Career Portal Pages] Show > Job Description > Edit User-defined Labels |
| 337165 | MessageSubjectJobApplication | Submission for the position: {0} - (Job Number: {1}) | Configuration > [Career Section] Administration > Career Sections > Career Section name > [Career Portal Pages] Show > Basic Search > Edit User-defined Labels |
| 337165 | MessageSubjectJobApplication | Submission for the position: {0} - (Job Number: {1}) | Configuration > [Career Section] Administration > Career Sections > Career Section name > [Career Portal Pages] Show > Job Description > Edit User-defined Labels |
| 337165 | MessageSubjectJobApplication | Submission for the position: {0} - (Job Number: {1}) | Configuration > [Career Section] Administration > Career Sections > Career Section name > [Career Portal Pages] Show > Job List > Edit User-defined Labels |
| 337165 | MessageSubjectJobApplication | Submission for the position: {0} - (Job Number: {1}) | Configuration > [Career Section] Administration > Career Sections > Career Section name > [Career Portal Pages] Show > My Job Cart > Edit User-defined Labels |
| 337165 | MessageSubjectJobApplication | Submission for the position: {0} - (Job Number: {1}) | Configuration > [Career Section] Administration > Career Sections > Career Section name > [Career Portal Pages] Show > My Referrals > Edit User-defined Labels |

| ID | NAME | TALEO DEFAULT VALUE | LOCATION |
|--------|-------------------------------|--|---|
| 337165 | MessageSubjectJobApplication | Submission for the position: {0} - (Job Number: {1}) | Configuration > [Career Section] Administration > Career Sections > Career Section name > [Career Portal Pages] Show > My Submissions > Edit User-defined Labels |
| 337168 | MessageSubjectReferral | Referral for the position: {0} - (Job Number: {1}) | Configuration > [Career Section] Administration > Career Sections > Career Section name > [Career Portal Pages] Show > Basic Search > Edit User-defined Labels |
| 337168 | MessageSubjectReferral | Referral for the position: {0} - (Job Number: {1}) | Configuration > [Career Section] Administration > Career Sections > Career Section name > [Career Portal Pages] Show > Job Description > Edit User-defined Labels |
| 337168 | MessageSubjectReferral | Referral for the position: {0} - (Job Number: {1}) | Configuration > [Career Section] Administration > Career Sections > Career Section name > [Career Portal Pages] Show > Job List > Edit User-defined Labels |
| 337168 | MessageSubjectReferral | Referral for the position: {0} - (Job Number: {1}) | Configuration > [Career Section] Administration > Career Sections > Career Section name > [Career Portal Pages] Show > My Job Cart > Edit User-defined Labels |
| 337168 | MessageSubjectReferral | Referral for the position: {0} - (Job Number: {1}) | Configuration > [Career Section] Administration > Career Sections > Career Section name > [Career Portal Pages] Show > My Referrals > Edit User-defined Labels |
| 337168 | MessageSubjectReferral | Referral for the position: {0} - (Job Number: {1}) | Configuration > [Career Section] Administration > Career Sections > Career Section name > [Career Portal Pages] Show > My Submissions > Edit User-defined Labels |
| 337777 | BackActionTT | Return to the previous page | Configuration > [Career Section] Administration > Career Sections > Career Section name > [Career Portal Pages] Show > Job Description > Edit User-defined Labels |
| 338506 | DeactivateAction | Deactivate | Configuration > [Career Section] Administration > Career Sections > Career Section name > [Career Portal Pages] Show > Job List > Edit User-defined Labels |
| 338509 | DeactivateActionTT | Deactivate this account | Configuration > [Career Section] Administration > Career Sections > Career Section name > [Career Portal Pages] Show > Job List > Edit User-defined Labels |
| 338524 | DeactivateAccountConfirmation | You are about to deactivate your account and all of its content. | Configuration > [Career Section] Administration > Career Sections > Career Section name > [Career Portal Pages] Show > Job List > Edit User-defined Labels |
| 338531 | DeactivateAccountMessage | By deactivating your account, the system will automatically withdraw all your active job submissions. Are you sure that you want to deactivate it? | Configuration > [Career Section] Administration > Career Sections > Career Section name > [Career Portal Pages] Show > Job List > Edit User-defined Labels |
| 338538 | NoCommand | No | Configuration > [Career Section] Administration > Career Sections > Career Section name > [Career Portal Pages] Show > Job List > Edit User-defined Labels |
| 338541 | NoCommandTT | Cancel the action | Configuration > [Career Section] Administration > Career Sections > Career Section name > [Career Portal Pages] Show > Job List > Edit User-defined Labels |
| 338548 | YesCommand | Yes | Configuration > [Career Section] Administration > Career Sections > Career Section name > [Career Portal Pages] Show > Job List > Edit User-defined Labels |

| ID | NAME | TALEO DEFAULT VALUE | LOCATION |
|--------|---------------------------|--|---|
| 338551 | YesCommandTT | Deactivate the account | Configuration > [Career Section] Administration > Career Sections > Career Section name > [Career Portal Pages] Show > Job List > Edit User-defined Labels |
| 342876 | ViewMySubmissionCommand | View My Submission | Configuration > [Career Section] Administration > Career Sections > Career Section name > [Career Portal Pages] Show > Job Description > Edit User-defined Labels |
| 342883 | ViewMySubmissionCommandT | View my the content of my job submission for this position | Configuration > [Career Section] Administration > Career Sections > Career Section name > [Career Portal Pages] Show > Job Description > Edit User-defined Labels |
| 342892 | FinishMySubmissionCommand | Finish My Submission | Configuration > [Career Section] Administration > Career Sections > Career Section name > [Career Portal Pages] Show > Job Description > Edit User-defined Labels |
| 342899 | FinishMySubmissionCommand | Finish my job submission for this position | Configuration > [Career Section] Administration > Career Sections > Career Section name > [Career Portal Pages] Show > Job Description > Edit User-defined Labels |
| 351695 | ExtendCommand | Extend | Configuration > [Career Section] Administration > Career Sections > Career Section name > [Career Portal Pages] Show > My Saved Searches > Edit User-defined Labels |
| 351704 | ExtendCommandTT | Extend the saved search expiration date | Configuration > [Career Section] Administration > Career Sections > Career Section name > [Career Portal Pages] Show > My Saved Searches > Edit User-defined Labels |
| 352022 | FinishSubmissionAction | Finish Draft Submission | Configuration > [Career Section] Administration > Career Sections > Career Section name > [Career Portal Pages] Show > Basic Search > Edit User-defined Labels |
| 352022 | FinishSubmissionAction | Finish Draft Submission | Configuration > [Career Section] Administration > Career Sections > Career Section name > [Career Portal Pages] Show > Job Description > Edit User-defined Labels |
| 352022 | FinishSubmissionAction | Finish Draft Submission | Configuration > [Career Section] Administration > Career Sections > Career Section name > [Career Portal Pages] Show > Job List > Edit User-defined Labels |
| 352022 | FinishSubmissionAction | Finish Draft Submission | Configuration > [Career Section] Administration > Career Sections > Career Section name > [Career Portal Pages] Show > My Job Cart > Edit User-defined Labels |
| 352022 | FinishSubmissionAction | Finish Draft Submission | Configuration > [Career Section] Administration > Career Sections > Career Section name > [Career Portal Pages] Show > My Referrals > Edit User-defined Labels |
| 352022 | FinishSubmissionAction | Finish Draft Submission | Configuration > [Career Section] Administration > Career Sections > Career Section name > [Career Portal Pages] Show > My Submissions > Edit User-defined Labels |
| 352029 | FinishSubmissionActionTT | Finish this draft submission | Configuration > [Career Section] Administration > Career Sections > Career Section name > [Career Portal Pages] Show > Basic Search > Edit User-defined Labels |
| 352029 | FinishSubmissionActionTT | Finish this draft submission | Configuration > [Career Section] Administration > Career Sections > Career Section name > [Career Portal Pages] Show > Job Description > Edit User-defined Labels |

| ID | NAME | TALEO DEFAULT VALUE | LOCATION |
|--------|--------------------------|--------------------------------|---|
| 352029 | FinishSubmissionActionTT | Finish this draft submission | Configuration > [Career Section] Administration > Career Sections > Career Section name > [Career Portal Pages] Show > Job List > Edit User-defined Labels |
| 352029 | FinishSubmissionActionTT | Finish this draft submission | Configuration > [Career Section] Administration > Career Sections > Career Section name > [Career Portal Pages] Show > My Job Cart > Edit User-defined Labels |
| 352029 | FinishSubmissionActionTT | Finish this draft submission | Configuration > [Career Section] Administration > Career Sections > Career Section name > [Career Portal Pages] Show > My Referrals > Edit User-defined Labels |
| 352029 | FinishSubmissionActionTT | Finish this draft submission | Configuration > [Career Section] Administration > Career Sections > Career Section name > [Career Portal Pages] Show > My Submissions > Edit User-defined Labels |
| 352036 | ViewSubmissionAction | View/Edit Submission | Configuration > [Career Section] Administration > Career Sections > Career Section name > [Career Portal Pages] Show > Basic Search > Edit User-defined Labels |
| 352036 | ViewSubmissionAction | View/Edit Submission | Configuration > [Career Section] Administration > Career Sections > Career Section name > [Career Portal Pages] Show > Job Description > Edit User-defined Labels |
| 352036 | ViewSubmissionAction | View/Edit Submission | Configuration > [Career Section] Administration > Career Sections > Career Section name > [Career Portal Pages] Show > Job List > Edit User-defined Labels |
| 352036 | ViewSubmissionAction | View/Edit Submission | Configuration > [Career Section] Administration > Career Sections > Career Section name > [Career Portal Pages] Show > My Job Cart > Edit User-defined Labels |
| 352036 | ViewSubmissionAction | View/Edit Submission | Configuration > [Career Section] Administration > Career Sections > Career Section name > [Career Portal Pages] Show > My Referrals > Edit User-defined Labels |
| 352036 | ViewSubmissionAction | View/Edit Submission | Configuration > [Career Section] Administration > Career Sections > Career Section name > [Career Portal Pages] Show > My Submissions > Edit User-defined Labels |
| 352039 | ViewSubmissionActionTT | View or modify this submission | Configuration > [Career Section] Administration > Career Sections > Career Section name > [Career Portal Pages] Show > Basic Search > Edit User-defined Labels |
| 352039 | ViewSubmissionActionTT | View or modify this submission | Configuration > [Career Section] Administration > Career Sections > Career Section name > [Career Portal Pages] Show > Job Description > Edit User-defined Labels |
| 352039 | ViewSubmissionActionTT | View or modify this submission | Configuration > [Career Section] Administration > Career Sections > Career Section name > [Career Portal Pages] Show > Job List > Edit User-defined Labels |
| 352039 | ViewSubmissionActionTT | View or modify this submission | Configuration > [Career Section] Administration > Career Sections > Career Section name > [Career Portal Pages] Show > My Job Cart > Edit User-defined Labels |
| 352039 | ViewSubmissionActionTT | View or modify this submission | Configuration > [Career Section] Administration > Career Sections > Career Section name > [Career Portal Pages] Show > My Referrals > Edit User-defined Labels |

| ID | NAME | TALEO DEFAULT VALUE | LOCATION |
|--------|------------------------|--|--|
| 352039 | ViewSubmissionActionTT | View or modify this submission | Configuration > [Career Section] Administration > Career Sections > Career Section name > [Career Portal Pages] Show > My Submissions > Edit User-defined Labels |
| 364104 | JobStatusVariable | Job Status: {0} | Configuration > [Career Section] Administration > Career Sections > Career Section name > [Career Portal Pages] Show > My Referrals > Edit User-defined Labels |
| 364114 | MoreLocations | More... | Configuration > [Career Section] Administration > Career Sections > Career Section name > [Career Portal Pages] Show > My Referrals > Edit User-defined Labels |
| 364121 | MoreLocationsTT | Position available in other locations: {0} | Configuration > [Career Section] Administration > Career Sections > Career Section name > [Career Portal Pages] Show > My Referrals > Edit User-defined Labels |
| 368039 | DraftSubmissions | Draft Submissions | Configuration > [Career Section] Administration > Career Sections > Career Section name > [Career Portal Pages] Show > My Submissions > Edit User-defined Labels |
| 368094 | SubmissionStatus | Submission Status: | Configuration > [Career Section] Administration > Career Sections > Career Section name > [Career Portal Pages] Show > My Submissions > Edit User-defined Labels |
| 368138 | SubmissionStatus | Submission Status: | Configuration > [Career Section] Administration > Career Sections > Career Section name > [Career Portal Pages] Show > My Referrals > Edit User-defined Labels |
| 368158 | CompletedSubmissions | Completed Submissions | Configuration > [Career Section] Administration > Career Sections > Career Section name > [Career Portal Pages] Show > My Submissions > Edit User-defined Labels |
| 368175 | WithdrawnSubmissions | Withdrawn Submissions | Configuration > [Career Section] Administration > Career Sections > Career Section name > [Career Portal Pages] Show > My Submissions > Edit User-defined Labels |
| 368192 | CompletedReferrals | Completed Referrals | Configuration > [Career Section] Administration > Career Sections > Career Section name > [Career Portal Pages] Show > My Referrals > Edit User-defined Labels |
| 368199 | DraftReferrals | Draft Referrals | Configuration > [Career Section] Administration > Career Sections > Career Section name > [Career Portal Pages] Show > My Referrals > Edit User-defined Labels |
| 368206 | WithdrawnReferrals | Withdrawn Referrals | Configuration > [Career Section] Administration > Career Sections > Career Section name > [Career Portal Pages] Show > My Referrals > Edit User-defined Labels |
| 368544 | Draft | Draft | Configuration > [Career Section] Administration > Career Sections > Career Section name > [Career Portal Pages] Show > My Submissions > Edit User-defined Labels |
| 368553 | Completed | Completed | Configuration > [Career Section] Administration > Career Sections > Career Section name > [Career Portal Pages] Show > My Submissions > Edit User-defined Labels |
| 368562 | Withdrawn | Withdrawn | Configuration > [Career Section] Administration > Career Sections > Career Section name > [Career Portal Pages] Show > My Submissions > Edit User-defined Labels |

| ID | NAME | TALEO DEFAULT VALUE | LOCATION |
|--------|-----------------------------|--|---|
| 368571 | Draft | Draft | Configuration > [Career Section] Administration > Career Sections > Career Section name > [Career Portal Pages] Show > My Referrals > Edit User-defined Labels |
| 368578 | Completed | Completed | Configuration > [Career Section] Administration > Career Sections > Career Section name > [Career Portal Pages] Show > My Referrals > Edit User-defined Labels |
| 368585 | Withdrawn | Withdrawn | Configuration > [Career Section] Administration > Career Sections > Career Section name > [Career Portal Pages] Show > My Referrals > Edit User-defined Labels |
| 369516 | JobsAvailableOtherLanguages | Jobs available in: | Configuration > [Career Section] Administration > Career Sections > Career Section name > [Career Portal Pages] Show > Basic Search > Edit User-defined Labels |
| 369516 | JobsAvailableOtherLanguages | Jobs available in: | Configuration > [Career Section] Administration > Career Sections > Career Section name > [Career Portal Pages] Show > Job Description > Edit User-defined Labels |
| 369516 | JobsAvailableOtherLanguages | Jobs available in: | Configuration > [Career Section] Administration > Career Sections > Career Section name > [Career Portal Pages] Show > Job List > Edit User-defined Labels |
| 369516 | JobsAvailableOtherLanguages | Jobs available in: | Configuration > [Career Section] Administration > Career Sections > Career Section name > [Career Portal Pages] Show > My Job Cart > Edit User-defined Labels |
| 369516 | JobsAvailableOtherLanguages | Jobs available in: | Configuration > [Career Section] Administration > Career Sections > Career Section name > [Career Portal Pages] Show > My Referrals > Edit User-defined Labels |
| 369516 | JobsAvailableOtherLanguages | Jobs available in: | Configuration > [Career Section] Administration > Career Sections > Career Section name > [Career Portal Pages] Show > My Submissions > Edit User-defined Labels |
| 369527 | SearchResultsDescription | This list contains all jobs matching your search criteria. To refine your search, click "Show Criteria" in the upper left-hand section of the page and specify the new criteria. | Configuration > [Career Section] Administration > Career Sections > Career Section name > [Career Portal Pages] Show > Advanced Search > Edit User-defined Labels |
| 369536 | SearchResultsDescription | This list contains all jobs matching your search criteria. To refine your search, click "Show Criteria" in the upper left-hand section of the page and specify the new criteria. | Configuration > [Career Section] Administration > Career Sections > Career Section name > [Career Portal Pages] Show > Basic Search > Edit User-defined Labels |
| 373070 | Description1 | Take a few minutes to create or modify your employment profile and to specify your preferred working criteria for future openings matching your interests. | Configuration > [Career Section] Administration > Career Sections > Career Section name > [Career Portal Pages] Show > My Submissions > Edit User-defined Labels |
| 373077 | Link1 | Access my profile | Configuration > [Career Section] Administration > Career Sections > Career Section name > [Career Portal Pages] Show > My Submissions > Edit User-defined Labels |

| ID | NAME | TALEO DEFAULT VALUE | LOCATION |
|--------|--------------|--|---|
| 373084 | Link1TT | Open the form used to manage employment profiles | Configuration > [Career Section] Administration > Career Sections > Career Section name > [Career Portal Pages] Show > My Submissions > Edit User-defined Labels |
| 373091 | Title1 | Candidate Profile | Configuration > [Career Section] Administration > Career Sections > Career Section name > [Career Portal Pages] Show > My Submissions > Edit User-defined Labels |
| 373154 | Description1 | Take a few minutes to create or modify your employment profile and to specify your preferred working criteria for future openings matching your interests. | Configuration > [Career Section] Administration > Career Sections > Career Section name > [Career Portal Pages] Show > Job Description > Edit User-defined Labels |
| 373154 | Description1 | Take a few minutes to create or modify your employment profile and to specify your preferred working criteria for future openings matching your interests. | Configuration > [Career Section] Administration > Career Sections > Career Section name > [Career Portal Pages] Show > Job List > Edit User-defined Labels |
| 373161 | Link1 | Access my profile | Configuration > [Career Section] Administration > Career Sections > Career Section name > [Career Portal Pages] Show > Job Description > Edit User-defined Labels |
| 373161 | Link1 | Access my profile | Configuration > [Career Section] Administration > Career Sections > Career Section name > [Career Portal Pages] Show > Job List > Edit User-defined Labels |
| 373168 | Link1TT | Open the form used to manage employment profiles | Configuration > [Career Section] Administration > Career Sections > Career Section name > [Career Portal Pages] Show > Job Description > Edit User-defined Labels |
| 373168 | Link1TT | Open the form used to manage employment profiles | Configuration > [Career Section] Administration > Career Sections > Career Section name > [Career Portal Pages] Show > Job List > Edit User-defined Labels |
| 373175 | Title1 | Candidate Profile | Configuration > [Career Section] Administration > Career Sections > Career Section name > [Career Portal Pages] Show > Job Description > Edit User-defined Labels |
| 373175 | Title1 | Candidate Profile | Configuration > [Career Section] Administration > Career Sections > Career Section name > [Career Portal Pages] Show > Job List > Edit User-defined Labels |
| 373189 | Description2 | Tell us about a friend who might be interested in working for our organization. All privacy rights will be protected. | Configuration > [Career Section] Administration > Career Sections > Career Section name > [Career Portal Pages] Show > Job Description > Edit User-defined Labels |
| 373189 | Description2 | Tell us about a friend who might be interested in working for our organization. All privacy rights will be protected. | Configuration > [Career Section] Administration > Career Sections > Career Section name > [Career Portal Pages] Show > Job List > Edit User-defined Labels |
| 373210 | Link2 | Submit a friend's profile | Configuration > [Career Section] Administration > Career Sections > Career Section name > [Career Portal Pages] Show > Job Description > Edit User-defined Labels |

| ID | NAME | TALEO DEFAULT VALUE | LOCATION |
|--------|--------------|--|---|
| 373210 | Link2 | Submit a friend's profile | Configuration > [Career Section] Administration > Career Sections > Career Section name > [Career Portal Pages] Show > Job List > Edit User-defined Labels |
| 373217 | Link2TT | Open the form used to refer a friend | Configuration > [Career Section] Administration > Career Sections > Career Section name > [Career Portal Pages] Show > Job Description > Edit User-defined Labels |
| 373217 | Link2TT | Open the form used to refer a friend | Configuration > [Career Section] Administration > Career Sections > Career Section name > [Career Portal Pages] Show > Job List > Edit User-defined Labels |
| 373231 | Title2 | Refer a friend | Configuration > [Career Section] Administration > Career Sections > Career Section name > [Career Portal Pages] Show > Job Description > Edit User-defined Labels |
| 373231 | Title2 | Refer a friend | Configuration > [Career Section] Administration > Career Sections > Career Section name > [Career Portal Pages] Show > Job List > Edit User-defined Labels |
| 373275 | Description3 | | Configuration > [Career Section] Administration > Career Sections > Career Section name > [Career Portal Pages] Show > Job Description > Edit User-defined Labels |
| 373275 | Description3 | | Configuration > [Career Section] Administration > Career Sections > Career Section name > [Career Portal Pages] Show > Job List > Edit User-defined Labels |
| 373282 | Title3 | | Configuration > [Career Section] Administration > Career Sections > Career Section name > [Career Portal Pages] Show > Job Description > Edit User-defined Labels |
| 373282 | Title3 | | Configuration > [Career Section] Administration > Career Sections > Career Section name > [Career Portal Pages] Show > Job List > Edit User-defined Labels |
| 373292 | Description1 | Take a few minutes to create or modify your employment profile and to specify your preferred working criteria for future openings matching your interests. | Configuration > [Career Section] Administration > Career Sections > Career Section name > [Career Portal Pages] Show > Basic Search > Edit User-defined Labels |
| 373299 | Link1 | Access my profile | Configuration > [Career Section] Administration > Career Sections > Career Section name > [Career Portal Pages] Show > Basic Search > Edit User-defined Labels |
| 373306 | Link1TT | Open the form used to manage employment profiles | Configuration > [Career Section] Administration > Career Sections > Career Section name > [Career Portal Pages] Show > Basic Search > Edit User-defined Labels |
| 373313 | Title1 | Candidate Profile | Configuration > [Career Section] Administration > Career Sections > Career Section name > [Career Portal Pages] Show > Basic Search > Edit User-defined Labels |
| 373320 | Description2 | Tell us about a friend who might be interested in working for our organization. All privacy rights will be protected. | Configuration > [Career Section] Administration > Career Sections > Career Section name > [Career Portal Pages] Show > Basic Search > Edit User-defined Labels |

| ID | NAME | TALEO DEFAULT VALUE | LOCATION |
|--------|--------------|--|--|
| 373327 | Description3 | | Configuration > [Career Section] Administration > Career Sections > Career Section name > [Career Portal Pages] Show > Basic Search > Edit User-defined Labels |
| 373334 | Link2 | Submit a friend's profile | Configuration > [Career Section] Administration > Career Sections > Career Section name > [Career Portal Pages] Show > Basic Search > Edit User-defined Labels |
| 373341 | Link2TT | Open the form used to refer a friend | Configuration > [Career Section] Administration > Career Sections > Career Section name > [Career Portal Pages] Show > Basic Search > Edit User-defined Labels |
| 373348 | Title2 | Refer a friend | Configuration > [Career Section] Administration > Career Sections > Career Section name > [Career Portal Pages] Show > Basic Search > Edit User-defined Labels |
| 373355 | Title3 | | Configuration > [Career Section] Administration > Career Sections > Career Section name > [Career Portal Pages] Show > Basic Search > Edit User-defined Labels |
| 373809 | Description1 | Take a few minutes to create or modify your employment profile and to specify your preferred working criteria for future openings matching your interests. | Configuration > [Career Section] Administration > Career Sections > Career Section name > [Career Portal Pages] Show > My Referrals > Edit User-defined Labels |
| 373816 | Link1 | Access my profile | Configuration > [Career Section] Administration > Career Sections > Career Section name > [Career Portal Pages] Show > My Referrals > Edit User-defined Labels |
| 373823 | Link1TT | Open the form used to manage employment profiles | Configuration > [Career Section] Administration > Career Sections > Career Section name > [Career Portal Pages] Show > My Referrals > Edit User-defined Labels |
| 373830 | Title1 | Candidate Profile | Configuration > [Career Section] Administration > Career Sections > Career Section name > [Career Portal Pages] Show > My Referrals > Edit User-defined Labels |
| 373837 | Description2 | Take a look at jobs currently available within our organization that match your professional skills and interests. | Configuration > [Career Section] Administration > Career Sections > Career Section name > [Career Portal Pages] Show > My Referrals > Edit User-defined Labels |
| 373844 | Description3 | Tell us about a friend who might be interested in working for our organization. All privacy rights will be protected. | Configuration > [Career Section] Administration > Career Sections > Career Section name > [Career Portal Pages] Show > My Referrals > Edit User-defined Labels |
| 373851 | Link2 | View jobs matching my profile | Configuration > [Career Section] Administration > Career Sections > Career Section name > [Career Portal Pages] Show > My Referrals > Edit User-defined Labels |
| 373858 | Link2TT | Access the list of jobs matching the candidate's profile | Configuration > [Career Section] Administration > Career Sections > Career Section name > [Career Portal Pages] Show > My Referrals > Edit User-defined Labels |
| 373865 | Link3 | Submit a friend's profile | Configuration > [Career Section] Administration > Career Sections > Career Section name > [Career Portal Pages] Show > My Referrals > Edit User-defined Labels |

| ID | NAME | TALEO DEFAULT VALUE | LOCATION |
|--------|--------------|--|--|
| 373872 | Link3TT | Open the form used to refer a friend | Configuration > [Career Section] Administration > Career Sections > Career Section name > [Career Portal Pages] Show > My Referrals > Edit User-defined Labels |
| 373879 | Title2 | Jobs Matching My Profile | Configuration > [Career Section] Administration > Career Sections > Career Section name > [Career Portal Pages] Show > My Referrals > Edit User-defined Labels |
| 373886 | Title3 | Refer a friend | Configuration > [Career Section] Administration > Career Sections > Career Section name > [Career Portal Pages] Show > My Referrals > Edit User-defined Labels |
| 373925 | Description1 | Take a few minutes to create or modify your employment profile and to specify your preferred working criteria for future openings matching your interests. | Configuration > [Career Section] Administration > Career Sections > Career Section name > [Career Portal Pages] Show > My Job Cart > Edit User-defined Labels |
| 373932 | Link1 | Access my profile | Configuration > [Career Section] Administration > Career Sections > Career Section name > [Career Portal Pages] Show > My Job Cart > Edit User-defined Labels |
| 373939 | Link1TT | Open the form used to manage employment profiles | Configuration > [Career Section] Administration > Career Sections > Career Section name > [Career Portal Pages] Show > My Job Cart > Edit User-defined Labels |
| 373946 | Title1 | Candidate Profile | Configuration > [Career Section] Administration > Career Sections > Career Section name > [Career Portal Pages] Show > My Job Cart > Edit User-defined Labels |
| 373953 | Description2 | Take a look at jobs currently available within our organization that match your professional skills and interests. | Configuration > [Career Section] Administration > Career Sections > Career Section name > [Career Portal Pages] Show > My Job Cart > Edit User-defined Labels |
| 373960 | Description3 | Tell us about a friend who might be interested in working for our organization. All privacy rights will be protected. | Configuration > [Career Section] Administration > Career Sections > Career Section name > [Career Portal Pages] Show > My Job Cart > Edit User-defined Labels |
| 373967 | Link2 | View jobs matching my profile | Configuration > [Career Section] Administration > Career Sections > Career Section name > [Career Portal Pages] Show > My Job Cart > Edit User-defined Labels |
| 373974 | Link2TT | Access the list of jobs matching the candidate's profile | Configuration > [Career Section] Administration > Career Sections > Career Section name > [Career Portal Pages] Show > My Job Cart > Edit User-defined Labels |
| 373981 | Link3 | Submit a friend's profile | Configuration > [Career Section] Administration > Career Sections > Career Section name > [Career Portal Pages] Show > My Job Cart > Edit User-defined Labels |
| 373988 | Link3TT | Open the form used to refer a friend | Configuration > [Career Section] Administration > Career Sections > Career Section name > [Career Portal Pages] Show > My Job Cart > Edit User-defined Labels |
| 373995 | Title2 | Jobs Matching My Profile | Configuration > [Career Section] Administration > Career Sections > Career Section name > [Career Portal Pages] Show > My Job Cart > Edit User-defined Labels |

| ID | NAME | TALEO DEFAULT VALUE | LOCATION |
|--------|------------------------|--|---|
| 374002 | Title3 | Refer a friend | Configuration > [Career Section] Administration > Career Sections > Career Section name > [Career Portal Pages] Show > My Job Cart > Edit User-defined Labels |
| 374069 | SendEmailNotifications | Send me an email notification whenever a new position matching my profile is posted (job posting notification). | Configuration > [Career Section] Administration > Career Sections > Career Section name > [Career Portal Pages] Show > Job List > Edit User-defined Labels |
| 374339 | Description1 | Take a few minutes to create or modify your employment profile and to specify your preferred working criteria for future openings matching your interests. | Configuration > [Career Section] Administration > Career Sections > Career Section name > [Career Portal Pages] Show > My Saved Searches > Edit User-defined Labels |
| 374346 | Link1 | Access my profile | Configuration > [Career Section] Administration > Career Sections > Career Section name > [Career Portal Pages] Show > My Saved Searches > Edit User-defined Labels |
| 374353 | Link1TT | Open the form used to manage employment profiles | Configuration > [Career Section] Administration > Career Sections > Career Section name > [Career Portal Pages] Show > My Saved Searches > Edit User-defined Labels |
| 374360 | Title1 | Candidate Profile | Configuration > [Career Section] Administration > Career Sections > Career Section name > [Career Portal Pages] Show > My Saved Searches > Edit User-defined Labels |
| 374367 | Description2 | Take a look at jobs currently available within our organization that match your professional skills and interests. | Configuration > [Career Section] Administration > Career Sections > Career Section name > [Career Portal Pages] Show > My Saved Searches > Edit User-defined Labels |
| 374374 | Description3 | Tell us about a friend who might be interested in working for our organization. All privacy rights will be protected. | Configuration > [Career Section] Administration > Career Sections > Career Section name > [Career Portal Pages] Show > My Saved Searches > Edit User-defined Labels |
| 374381 | Link2 | View jobs matching my profile | Configuration > [Career Section] Administration > Career Sections > Career Section name > [Career Portal Pages] Show > My Saved Searches > Edit User-defined Labels |
| 374388 | Link2TT | Access the list of jobs matching the candidate's profile | Configuration > [Career Section] Administration > Career Sections > Career Section name > [Career Portal Pages] Show > My Saved Searches > Edit User-defined Labels |
| 374395 | Link3 | Submit a friend's profile | Configuration > [Career Section] Administration > Career Sections > Career Section name > [Career Portal Pages] Show > My Saved Searches > Edit User-defined Labels |
| 374402 | Link3TT | Open the form used to refer a friend | Configuration > [Career Section] Administration > Career Sections > Career Section name > [Career Portal Pages] Show > My Saved Searches > Edit User-defined Labels |
| 374409 | Title2 | Jobs Matching My Profile | Configuration > [Career Section] Administration > Career Sections > Career Section name > [Career Portal Pages] Show > My Saved Searches > Edit User-defined Labels |
| 374416 | Title3 | Refer a friend | Configuration > [Career Section] Administration > Career Sections > Career Section name > [Career Portal Pages] Show > My Saved Searches > Edit User-defined Labels |

| ID | NAME | TALEO DEFAULT VALUE | LOCATION |
|--------|--------------|---|---|
| 374793 | JobsPerPage | Jobs per page: | Configuration > [Career Section] Administration > Career Sections > Career Section name > [Career Portal Pages] Show > Job List > Edit User-defined Labels |
| 374826 | JobsPageXOFY | Jobs - Page {0} out of {1} | Configuration > [Career Section] Administration > Career Sections > Career Section name > [Career Portal Pages] Show > Job List > Edit User-defined Labels |
| 374843 | JobsPerPage | Jobs per page: | Configuration > [Career Section] Administration > Career Sections > Career Section name > [Career Portal Pages] Show > Basic Search > Edit User-defined Labels |
| 374850 | JobsPageXOFY | Jobs - Page {0} out of {1} | Configuration > [Career Section] Administration > Career Sections > Career Section name > [Career Portal Pages] Show > Basic Search > Edit User-defined Labels |
| 374857 | JobsPerPage | Jobs per page: | Configuration > [Career Section] Administration > Career Sections > Career Section name > [Career Portal Pages] Show > My Job Cart > Edit User-defined Labels |
| 374864 | JobsPageXOFY | Configuration > [Career Section] Administration > Career Sections > Career Section name > [Career Portal Pages] Show > My Job Cart > Edit User-defined Labels - Page {0} out of {1} | Configuration > [Career Section] Administration > Career Sections > Career Section name > [Career Portal Pages] Show > My Job Cart > Edit User-defined Labels |
| 374875 | PageNumberTT | Go to page {0} | Configuration > [Career Section] Administration > Career Sections > Career Section name > [Career Portal Pages] Show > Basic Search > Edit User-defined Labels |
| 374875 | PageNumberTT | Go to page {0} | Configuration > [Career Section] Administration > Career Sections > Career Section name > [Career Portal Pages] Show > Job Description > Edit User-defined Labels |
| 374875 | PageNumberTT | Go to page {0} | Configuration > [Career Section] Administration > Career Sections > Career Section name > [Career Portal Pages] Show > Job List > Edit User-defined Labels |
| 374875 | PageNumberTT | Go to page {0} | Configuration > [Career Section] Administration > Career Sections > Career Section name > [Career Portal Pages] Show > My Job Cart > Edit User-defined Labels |
| 374875 | PageNumberTT | Go to page {0} | Configuration > [Career Section] Administration > Career Sections > Career Section name > [Career Portal Pages] Show > My Referrals > Edit User-defined Labels |
| 374875 | PageNumberTT | Go to page {0} | Configuration > [Career Section] Administration > Career Sections > Career Section name > [Career Portal Pages] Show > My Submissions > Edit User-defined Labels |
| 375944 | JobField | Job | Configuration > [Career Section] Administration > Career Sections > Career Section name > [Career Portal Pages] Show > Advanced Search > Edit User-defined Labels |
| 375944 | JobField | Job | Configuration > [Career Section] Administration > Career Sections > Career Section name > [Career Portal Pages] Show > Basic Search > Edit User-defined Labels |

| ID | NAME | TALEO DEFAULT VALUE | LOCATION |
|--------|--------------|---------------------|---|
| 375944 | JobField | Job | Configuration > [Career Section] Administration > Career Sections > Career Section name > [Career Portal Pages] Show > Basic Search > Edit User-defined Labels |
| 375944 | JobField | Job | Configuration > [Career Section] Administration > Career Sections > Career Section name > [Career Portal Pages] Show > Job Description > Edit User-defined Labels |
| 375944 | JobField | Job | Configuration > [Career Section] Administration > Career Sections > Career Section name > [Career Portal Pages] Show > Job List > Edit User-defined Labels |
| 375944 | JobField | Job | Configuration > [Career Section] Administration > Career Sections > Career Section name > [Career Portal Pages] Show > My Job Cart > Edit User-defined Labels |
| 375944 | JobField | Job | Configuration > [Career Section] Administration > Career Sections > Career Section name > [Career Portal Pages] Show > My Referrals > Edit User-defined Labels |
| 375944 | JobField | Job | Configuration > [Career Section] Administration > Career Sections > Career Section name > [Career Portal Pages] Show > My Submissions > Edit User-defined Labels |
| 375947 | Organization | Organization | Configuration > [Career Section] Administration > Career Sections > Career Section name > [Career Portal Pages] Show > Advanced Search > Edit User-defined Labels |
| 375947 | Organization | Organization | Configuration > [Career Section] Administration > Career Sections > Career Section name > [Career Portal Pages] Show > Basic Search > Edit User-defined Labels |
| 375947 | Organization | Organization | Configuration > [Career Section] Administration > Career Sections > Career Section name > [Career Portal Pages] Show > Basic Search > Edit User-defined Labels |
| 375947 | Organization | Organization | Configuration > [Career Section] Administration > Career Sections > Career Section name > [Career Portal Pages] Show > Job Description > Edit User-defined Labels |
| 375947 | Organization | Organization | Configuration > [Career Section] Administration > Career Sections > Career Section name > [Career Portal Pages] Show > Job List > Edit User-defined Labels |
| 375947 | Organization | Organization | Configuration > [Career Section] Administration > Career Sections > Career Section name > [Career Portal Pages] Show > My Job Cart > Edit User-defined Labels |
| 375947 | Organization | Organization | Configuration > [Career Section] Administration > Career Sections > Career Section name > [Career Portal Pages] Show > My Referrals > Edit User-defined Labels |
| 375947 | Organization | Organization | Configuration > [Career Section] Administration > Career Sections > Career Section name > [Career Portal Pages] Show > My Submissions > Edit User-defined Labels |
| 375950 | Program | Education Program | Configuration > [Career Section] Administration > Career Sections > Career Section name > [Career Portal Pages] Show > Advanced Search > Edit User-defined Labels |

| ID | NAME | TALEO DEFAULT VALUE | LOCATION |
|--------|----------------|---------------------|---|
| 375950 | Program | Education Program | Configuration > [Career Section] Administration > Career Sections > Career Section name > [Career Portal Pages] Show > Basic Search > Edit User-defined Labels |
| 375950 | Program | Education Program | Configuration > [Career Section] Administration > Career Sections > Career Section name > [Career Portal Pages] Show > Basic Search > Edit User-defined Labels |
| 375950 | Program | Education Program | Configuration > [Career Section] Administration > Career Sections > Career Section name > [Career Portal Pages] Show > Job Description > Edit User-defined Labels |
| 375950 | Program | Education Program | Configuration > [Career Section] Administration > Career Sections > Career Section name > [Career Portal Pages] Show > Job List > Edit User-defined Labels |
| 375950 | Program | Education Program | Configuration > [Career Section] Administration > Career Sections > Career Section name > [Career Portal Pages] Show > My Job Cart > Edit User-defined Labels |
| 375950 | Program | Education Program | Configuration > [Career Section] Administration > Career Sections > Career Section name > [Career Portal Pages] Show > My Referrals > Edit User-defined Labels |
| 375950 | Program | Education Program | Configuration > [Career Section] Administration > Career Sections > Career Section name > [Career Portal Pages] Show > My Submissions > Edit User-defined Labels |
| 375953 | RecruiterOwner | Recruiter | Configuration > [Career Section] Administration > Career Sections > Career Section name > [Career Portal Pages] Show > Advanced Search > Edit User-defined Labels |
| 375953 | RecruiterOwner | Recruiter | Configuration > [Career Section] Administration > Career Sections > Career Section name > [Career Portal Pages] Show > Basic Search > Edit User-defined Labels |
| 375953 | RecruiterOwner | Recruiter | Configuration > [Career Section] Administration > Career Sections > Career Section name > [Career Portal Pages] Show > Basic Search > Edit User-defined Labels |
| 375953 | RecruiterOwner | Recruiter | Configuration > [Career Section] Administration > Career Sections > Career Section name > [Career Portal Pages] Show > Job Description > Edit User-defined Labels |
| 375953 | RecruiterOwner | Recruiter | Configuration > [Career Section] Administration > Career Sections > Career Section name > [Career Portal Pages] Show > Job List > Edit User-defined Labels |
| 375953 | RecruiterOwner | Recruiter | Configuration > [Career Section] Administration > Career Sections > Career Section name > [Career Portal Pages] Show > My Job Cart > Edit User-defined Labels |
| 375953 | RecruiterOwner | Recruiter | Configuration > [Career Section] Administration > Career Sections > Career Section name > [Career Portal Pages] Show > My Referrals > Edit User-defined Labels |
| 375953 | RecruiterOwner | Recruiter | Configuration > [Career Section] Administration > Career Sections > Career Section name > [Career Portal Pages] Show > My Submissions > Edit User-defined Labels |

| ID | NAME | TALEO DEFAULT VALUE | LOCATION |
|--------|-------------------|---------------------|---|
| 375956 | Currency | Currency | Configuration > [Career Section] Administration > Career Sections > Career Section name > [Career Portal Pages] Show > Advanced Search > Edit User-defined Labels |
| 375956 | Currency | Currency | Configuration > [Career Section] Administration > Career Sections > Career Section name > [Career Portal Pages] Show > Basic Search > Edit User-defined Labels |
| 375956 | Currency | Currency | Configuration > [Career Section] Administration > Career Sections > Career Section name > [Career Portal Pages] Show > Basic Search > Edit User-defined Labels |
| 375956 | Currency | Currency | Configuration > [Career Section] Administration > Career Sections > Career Section name > [Career Portal Pages] Show > Job Description > Edit User-defined Labels |
| 375956 | Currency | Currency | Configuration > [Career Section] Administration > Career Sections > Career Section name > [Career Portal Pages] Show > Job List > Edit User-defined Labels |
| 375956 | Currency | Currency | Configuration > [Career Section] Administration > Career Sections > Career Section name > [Career Portal Pages] Show > My Job Cart > Edit User-defined Labels |
| 375956 | Currency | Currency | Configuration > [Career Section] Administration > Career Sections > Career Section name > [Career Portal Pages] Show > My Referrals > Edit User-defined Labels |
| 375956 | Currency | Currency | Configuration > [Career Section] Administration > Career Sections > Career Section name > [Career Portal Pages] Show > My Submissions > Edit User-defined Labels |
| 375959 | PayFrequencyBasis | Pay Basis | Configuration > [Career Section] Administration > Career Sections > Career Section name > [Career Portal Pages] Show > Advanced Search > Edit User-defined Labels |
| 375959 | PayFrequencyBasis | Pay Basis | Configuration > [Career Section] Administration > Career Sections > Career Section name > [Career Portal Pages] Show > Basic Search > Edit User-defined Labels |
| 375959 | PayFrequencyBasis | Pay Basis | Configuration > [Career Section] Administration > Career Sections > Career Section name > [Career Portal Pages] Show > Basic Search > Edit User-defined Labels |
| 375959 | PayFrequencyBasis | Pay Basis | Configuration > [Career Section] Administration > Career Sections > Career Section name > [Career Portal Pages] Show > Job Description > Edit User-defined Labels |
| 375959 | PayFrequencyBasis | Pay Basis | Configuration > [Career Section] Administration > Career Sections > Career Section name > [Career Portal Pages] Show > Job List > Edit User-defined Labels |
| 375959 | PayFrequencyBasis | Pay Basis | Configuration > [Career Section] Administration > Career Sections > Career Section name > [Career Portal Pages] Show > My Job Cart > Edit User-defined Labels |
| 375959 | PayFrequencyBasis | Pay Basis | Configuration > [Career Section] Administration > Career Sections > Career Section name > [Career Portal Pages] Show > My Referrals > Edit User-defined Labels |

| ID | NAME | TALEO DEFAULT VALUE | LOCATION |
|--------|-------------------|---------------------|---|
| 375959 | PayFrequencyBasis | Pay Basis | Configuration > [Career Section] Administration > Career Sections > Career Section name > [Career Portal Pages] Show > My Submissions > Edit User-defined Labels |
| 375970 | OtherLocations | Other Locations | Configuration > [Career Section] Administration > Career Sections > Career Section name > [Career Portal Pages] Show > Advanced Search > Edit User-defined Labels |
| 375970 | OtherLocations | Other Locations | Configuration > [Career Section] Administration > Career Sections > Career Section name > [Career Portal Pages] Show > Basic Search > Edit User-defined Labels |
| 375970 | OtherLocations | Other Locations | Configuration > [Career Section] Administration > Career Sections > Career Section name > [Career Portal Pages] Show > Basic Search > Edit User-defined Labels |
| 375970 | OtherLocations | Other Locations | Configuration > [Career Section] Administration > Career Sections > Career Section name > [Career Portal Pages] Show > Job Description > Edit User-defined Labels |
| 375970 | OtherLocations | Other Locations | Configuration > [Career Section] Administration > Career Sections > Career Section name > [Career Portal Pages] Show > Job List > Edit User-defined Labels |
| 375970 | OtherLocations | Other Locations | Configuration > [Career Section] Administration > Career Sections > Career Section name > [Career Portal Pages] Show > My Job Cart > Edit User-defined Labels |
| 375970 | OtherLocations | Other Locations | Configuration > [Career Section] Administration > Career Sections > Career Section name > [Career Portal Pages] Show > My Referrals > Edit User-defined Labels |
| 375970 | OtherLocations | Other Locations | Configuration > [Career Section] Administration > Career Sections > Career Section name > [Career Portal Pages] Show > My Submissions > Edit User-defined Labels |
| 375973 | PrimaryLocation | Primary Location | Configuration > [Career Section] Administration > Career Sections > Career Section name > [Career Portal Pages] Show > Advanced Search > Edit User-defined Labels |
| 375973 | PrimaryLocation | Primary Location | Configuration > [Career Section] Administration > Career Sections > Career Section name > [Career Portal Pages] Show > Basic Search > Edit User-defined Labels |
| 375973 | PrimaryLocation | Primary Location | Configuration > [Career Section] Administration > Career Sections > Career Section name > [Career Portal Pages] Show > Basic Search > Edit User-defined Labels |
| 375973 | PrimaryLocation | Primary Location | Configuration > [Career Section] Administration > Career Sections > Career Section name > [Career Portal Pages] Show > Job Description > Edit User-defined Labels |
| 375973 | PrimaryLocation | Primary Location | Configuration > [Career Section] Administration > Career Sections > Career Section name > [Career Portal Pages] Show > Job List > Edit User-defined Labels |
| 375973 | PrimaryLocation | Primary Location | Configuration > [Career Section] Administration > Career Sections > Career Section name > [Career Portal Pages] Show > My Job Cart > Edit User-defined Labels |

| ID | NAME | TALEO DEFAULT VALUE | LOCATION |
|--------|----------------------|--------------------------|---|
| 375973 | PrimaryLocation | Primary Location | Configuration > [Career Section] Administration > Career Sections > Career Section name > [Career Portal Pages] Show > My Referrals > Edit User-defined Labels |
| 375973 | PrimaryLocation | Primary Location | Configuration > [Career Section] Administration > Career Sections > Career Section name > [Career Portal Pages] Show > My Submissions > Edit User-defined Labels |
| 376234 | BonusCurrency | Currency - Bonus Section | Configuration > [Career Section] Administration > Career Sections > Career Section name > [Career Portal Pages] Show > Advanced Search > Edit User-defined Labels |
| 376234 | BonusCurrency | Currency - Bonus Section | Configuration > [Career Section] Administration > Career Sections > Career Section name > [Career Portal Pages] Show > Basic Search > Edit User-defined Labels |
| 376234 | BonusCurrency | Currency - Bonus Section | Configuration > [Career Section] Administration > Career Sections > Career Section name > [Career Portal Pages] Show > Basic Search > Edit User-defined Labels |
| 376234 | BonusCurrency | Currency - Bonus Section | Configuration > [Career Section] Administration > Career Sections > Career Section name > [Career Portal Pages] Show > Job Description > Edit User-defined Labels |
| 376234 | BonusCurrency | Currency - Bonus Section | Configuration > [Career Section] Administration > Career Sections > Career Section name > [Career Portal Pages] Show > Job List > Edit User-defined Labels |
| 376234 | BonusCurrency | Currency - Bonus Section | Configuration > [Career Section] Administration > Career Sections > Career Section name > [Career Portal Pages] Show > My Job Cart > Edit User-defined Labels |
| 376234 | BonusCurrency | Currency - Bonus Section | Configuration > [Career Section] Administration > Career Sections > Career Section name > [Career Portal Pages] Show > My Referrals > Edit User-defined Labels |
| 376234 | BonusCurrency | Currency - Bonus Section | Configuration > [Career Section] Administration > Career Sections > Career Section name > [Career Portal Pages] Show > My Submissions > Edit User-defined Labels |
| 376552 | PostingDate | Posting Date | Configuration > [Career Section] Administration > Career Sections > Career Section name > [Career Portal Pages] Show > Advanced Search > Edit User-defined Labels |
| 376561 | AllJobs | All Jobs | Configuration > [Career Section] Administration > Career Sections > Career Section name > [Career Portal Pages] Show > Advanced Search > Edit User-defined Labels |
| 376570 | UrgentJobsOnly | Urgent Jobs Only | Configuration > [Career Section] Administration > Career Sections > Career Section name > [Career Portal Pages] Show > Advanced Search > Edit User-defined Labels |
| 376579 | UrgentJobs | Urgent Jobs | Configuration > [Career Section] Administration > Career Sections > Career Section name > [Career Portal Pages] Show > Advanced Search > Edit User-defined Labels |
| 382201 | ReferCandidateAction | Refer a Candidate | Configuration > [Career Section] Administration > Career Sections > Career Section name > [Career Portal Pages] Show > Basic Search > Edit User-defined Labels |

| ID | NAME | TALEO DEFAULT VALUE | LOCATION |
|--------|------------------------|---|---|
| 382201 | ReferCandidateAction | Refer a Candidate | Configuration > [Career Section] Administration > Career Sections > Career Section name > [Career Portal Pages] Show > Job Description > Edit User-defined Labels |
| 382201 | ReferCandidateAction | Refer a Candidate | Configuration > [Career Section] Administration > Career Sections > Career Section name > [Career Portal Pages] Show > Job List > Edit User-defined Labels |
| 382201 | ReferCandidateAction | Refer a Candidate | Configuration > [Career Section] Administration > Career Sections > Career Section name > [Career Portal Pages] Show > My Job Cart > Edit User-defined Labels |
| 382201 | ReferCandidateAction | Refer a Candidate | Configuration > [Career Section] Administration > Career Sections > Career Section name > [Career Portal Pages] Show > My Referrals > Edit User-defined Labels |
| 382201 | ReferCandidateAction | Refer a Candidate | Configuration > [Career Section] Administration > Career Sections > Career Section name > [Career Portal Pages] Show > My Submissions > Edit User-defined Labels |
| 382210 | ReferCandidateActionTT | Refer a candidate | Configuration > [Career Section] Administration > Career Sections > Career Section name > [Career Portal Pages] Show > Basic Search > Edit User-defined Labels |
| 382210 | ReferCandidateActionTT | Refer a candidate | Configuration > [Career Section] Administration > Career Sections > Career Section name > [Career Portal Pages] Show > Job Description > Edit User-defined Labels |
| 382210 | ReferCandidateActionTT | Refer a candidate | Configuration > [Career Section] Administration > Career Sections > Career Section name > [Career Portal Pages] Show > Job List > Edit User-defined Labels |
| 382210 | ReferCandidateActionTT | Refer a candidate | Configuration > [Career Section] Administration > Career Sections > Career Section name > [Career Portal Pages] Show > My Job Cart > Edit User-defined Labels |
| 382210 | ReferCandidateActionTT | Refer a candidate | Configuration > [Career Section] Administration > Career Sections > Career Section name > [Career Portal Pages] Show > My Referrals > Edit User-defined Labels |
| 382210 | ReferCandidateActionTT | Refer a candidate | Configuration > [Career Section] Administration > Career Sections > Career Section name > [Career Portal Pages] Show > My Submissions > Edit User-defined Labels |
| 382223 | ReferCandidateAction | Refer a Candidate | Configuration > [Career Section] Administration > Career Sections > Career Section name > [Career Portal Pages] Show > Job Description > Edit User-defined Labels |
| 382230 | ReferCandidateActionTT | Refer a candidate for this position | Configuration > [Career Section] Administration > Career Sections > Career Section name > [Career Portal Pages] Show > Job Description > Edit User-defined Labels |
| 382353 | Agent_Description3 | Tell us about a person who might be interested in working for our organization. All privacy rights will be protected. | Configuration > [Career Section] Administration > Career Sections > Career Section name > [Career Portal Pages] Show > My Referrals > Edit User-defined Labels |
| 382360 | Agent_Link3 | Submit a candidate's profile | Configuration > [Career Section] Administration > Career Sections > Career Section name > [Career Portal Pages] Show > My Referrals > Edit User-defined Labels |

| ID | NAME | TALEO DEFAULT VALUE | LOCATION |
|--------|--------------------|---|---|
| 382367 | Agent_Link3TT | Open the form used to refer a candidate | Configuration > [Career Section] Administration > Career Sections > Career Section name > [Career Portal Pages] Show > My Referrals > Edit User-defined Labels |
| 382374 | Agent_Title3 | Refer a candidate | Configuration > [Career Section] Administration > Career Sections > Career Section name > [Career Portal Pages] Show > My Referrals > Edit User-defined Labels |
| 382421 | Agent_Description2 | Tell us about a person who might be interested in working for our organization. All privacy rights will be protected. | Configuration > [Career Section] Administration > Career Sections > Career Section name > [Career Portal Pages] Show > Job Description > Edit User-defined Labels |
| 382421 | Agent_Description2 | Tell us about a person who might be interested in working for our organization. All privacy rights will be protected. | Configuration > [Career Section] Administration > Career Sections > Career Section name > [Career Portal Pages] Show > Job List > Edit User-defined Labels |
| 382428 | Agent_Link2 | Submit a candidate's profile | Configuration > [Career Section] Administration > Career Sections > Career Section name > [Career Portal Pages] Show > Job Description > Edit User-defined Labels |
| 382428 | Agent_Link2 | Submit a candidate's profile | Configuration > [Career Section] Administration > Career Sections > Career Section name > [Career Portal Pages] Show > Job List > Edit User-defined Labels |
| 382435 | Agent_Link2TT | Open the form used to refer a candidate | Configuration > [Career Section] Administration > Career Sections > Career Section name > [Career Portal Pages] Show > Job Description > Edit User-defined Labels |
| 382435 | Agent_Link2TT | Open the form used to refer a candidate | Configuration > [Career Section] Administration > Career Sections > Career Section name > [Career Portal Pages] Show > Job List > Edit User-defined Labels |
| 382442 | Agent_Title2 | Refer a candidate | Configuration > [Career Section] Administration > Career Sections > Career Section name > [Career Portal Pages] Show > Job Description > Edit User-defined Labels |
| 382442 | Agent_Title2 | Refer a candidate | Configuration > [Career Section] Administration > Career Sections > Career Section name > [Career Portal Pages] Show > Job List > Edit User-defined Labels |
| 388955 | ReferralBonus | Referral Bonus | Configuration > [Career Section] Administration > Career Sections > Career Section name > [Career Portal Pages] Show > Basic Search > Edit User-defined Labels |
| 388955 | ReferralBonus | Referral Bonus | Configuration > [Career Section] Administration > Career Sections > Career Section name > [Career Portal Pages] Show > Job Description > Edit User-defined Labels |
| 388955 | ReferralBonus | Referral Bonus | Configuration > [Career Section] Administration > Career Sections > Career Section name > [Career Portal Pages] Show > Job List > Edit User-defined Labels |
| 388955 | ReferralBonus | Referral Bonus | Configuration > [Career Section] Administration > Career Sections > Career Section name > [Career Portal Pages] Show > My Job Cart > Edit User-defined Labels |
| 388955 | ReferralBonus | Referral Bonus | Configuration > [Career Section] Administration > Career Sections > Career Section name > [Career Portal Pages] Show > My Referrals > Edit User-defined Labels |

| ID | NAME | TALEO DEFAULT VALUE | LOCATION |
|--------|------------------------|--|---|
| 388955 | ReferralBonus | Referral Bonus | Configuration > [Career Section] Administration > Career Sections > Career Section name > [Career Portal Pages] Show > My Submissions > Edit User-defined Labels |
| 389767 | CandidateNameVariable | Candidate Name: {0} | Configuration > [Career Section] Administration > Career Sections > Career Section name > [Career Portal Pages] Show > My Referrals > Edit User-defined Labels |
| 389790 | CandidateEmailVariable | Candidate Email: {0} | Configuration > [Career Section] Administration > Career Sections > Career Section name > [Career Portal Pages] Show > My Referrals > Edit User-defined Labels |
| 389801 | IdentificationMissing | Identification Missing | Configuration > [Career Section] Administration > Career Sections > Career Section name > [Career Portal Pages] Show > My Referrals > Edit User-defined Labels |
| 413388 | NewItem | NEW | Configuration > [Career Section] Administration > Career Sections > Career Section name > [Career Portal Pages] Show > My Job Cart > Edit User-defined Labels |
| 413395 | HighlightedItems | Highlighted jobs have been added to the job cart within the last 24 hours. | Configuration > [Career Section] Administration > Career Sections > Career Section name > [Career Portal Pages] Show > My Job Cart > Edit User-defined Labels |
| 426583 | UnpostedJob | UNPOSTED | Configuration > [Career Section] Administration > Career Sections > Career Section name > [Career Portal Pages] Show > My Job Cart > Edit User-defined Labels |
| 435682 | AgencyPortalMoved | The page you are looking for has been moved to: {0}. Please update your links and bookmarks to point to the new URL. | Configuration > [Career Section] Administration > Career Sections > Career Section name > [Career Portal Pages] Show > Access Management |
| 437545 | AgencyPortalMovedTitle | The portal has been moved. | Configuration > [Career Section] Administration > Career Sections > Career Section name > [Career Portal Pages] Show > Access Management |
| 439475 | ReApplyAction | Re-apply | Configuration > [Career Section] Administration > Career Sections > Career Section name > [Career Portal Pages] Show > My Submissions > Edit User-defined Labels |
| 439484 | ReApplyActionTT | Re-apply for this job | Configuration > [Career Section] Administration > Career Sections > Career Section name > [Career Portal Pages] Show > My Submissions > Edit User-defined Labels |
| 440258 | NotAvailable | Not Available | Configuration > [Career Section] Administration > Career Sections > Career Section name > [Career Portal Pages] Show > My Submissions > Edit User-defined Labels |
| 440265 | NotAvailable | Not Available | Configuration > [Career Section] Administration > Career Sections > Career Section name > [Career Portal Pages] Show > My Referrals > Edit User-defined Labels |
| 441406 | ClosingDateExt | Closing Date (Period for Applying) - External | Configuration > [Career Section] Administration > Career Sections > Career Section name > [Career Portal Pages] Show > Advanced Search > Edit User-defined Labels |
| 441406 | ClosingDateExt | Closing Date (Period for Applying) - External | Configuration > [Career Section] Administration > Career Sections > Career Section name > [Career Portal Pages] Show > Basic Search > Edit User-defined Labels |

| ID | NAME | TALEO DEFAULT VALUE | LOCATION |
|--------|-----------------|---|---|
| 441406 | ClosingDateExt | Closing Date (Period for Applying) - External | Configuration > [Career Section] Administration > Career Sections > Career Section name > [Career Portal Pages] Show > Basic Search > Edit User-defined Labels |
| 441406 | ClosingDateExt | Closing Date (Period for Applying) - External | Configuration > [Career Section] Administration > Career Sections > Career Section name > [Career Portal Pages] Show > Job Description > Edit User-defined Labels |
| 441406 | ClosingDateExt | Closing Date (Period for Applying) - External | Configuration > [Career Section] Administration > Career Sections > Career Section name > [Career Portal Pages] Show > Job List > Edit User-defined Labels |
| 441406 | ClosingDateExt | Closing Date (Period for Applying) - External | Configuration > [Career Section] Administration > Career Sections > Career Section name > [Career Portal Pages] Show > My Job Cart > Edit User-defined Labels |
| 441406 | ClosingDateExt | Closing Date (Period for Applying) - External | Configuration > [Career Section] Administration > Career Sections > Career Section name > [Career Portal Pages] Show > My Referrals > Edit User-defined Labels |
| 441406 | ClosingDateExt | Closing Date (Period for Applying) - External | Configuration > [Career Section] Administration > Career Sections > Career Section name > [Career Portal Pages] Show > My Submissions > Edit User-defined Labels |
| 441409 | ClosingDateInt | Closing Date (Period for Applying) - Internal | Configuration > [Career Section] Administration > Career Sections > Career Section name > [Career Portal Pages] Show > Advanced Search > Edit User-defined Labels |
| 441409 | ClosingDateInt | Closing Date (Period for Applying) - Internal | Configuration > [Career Section] Administration > Career Sections > Career Section name > [Career Portal Pages] Show > Basic Search > Edit User-defined Labels |
| 441409 | ClosingDateInt | Closing Date (Period for Applying) - Internal | Configuration > [Career Section] Administration > Career Sections > Career Section name > [Career Portal Pages] Show > Basic Search > Edit User-defined Labels |
| 441409 | ClosingDateInt | Closing Date (Period for Applying) - Internal | Configuration > [Career Section] Administration > Career Sections > Career Section name > [Career Portal Pages] Show > Job Description > Edit User-defined Labels |
| 441409 | ClosingDateInt | Closing Date (Period for Applying) - Internal | Configuration > [Career Section] Administration > Career Sections > Career Section name > [Career Portal Pages] Show > Job List > Edit User-defined Labels |
| 441409 | ClosingDateInt | Closing Date (Period for Applying) - Internal | Configuration > [Career Section] Administration > Career Sections > Career Section name > [Career Portal Pages] Show > My Job Cart > Edit User-defined Labels |
| 441409 | ClosingDateInt | Closing Date (Period for Applying) - Internal | Configuration > [Career Section] Administration > Career Sections > Career Section name > [Career Portal Pages] Show > My Referrals > Edit User-defined Labels |
| 441409 | ClosingDateInt | Closing Date (Period for Applying) - Internal | Configuration > [Career Section] Administration > Career Sections > Career Section name > [Career Portal Pages] Show > My Submissions > Edit User-defined Labels |
| 441412 | ContactEmailExt | Contact Email - External | Configuration > [Career Section] Administration > Career Sections > Career Section name > [Career Portal Pages] Show > Advanced Search > Edit User-defined Labels |

| ID | NAME | TALEO DEFAULT VALUE | LOCATION |
|--------|-----------------|--------------------------|---|
| 441412 | ContactEmailExt | Contact Email - External | Configuration > [Career Section] Administration > Career Sections > Career Section name > [Career Portal Pages] Show > Basic Search > Edit User-defined Labels |
| 441412 | ContactEmailExt | Contact Email - External | Configuration > [Career Section] Administration > Career Sections > Career Section name > [Career Portal Pages] Show > Basic Search > Edit User-defined Labels |
| 441412 | ContactEmailExt | Contact Email - External | Configuration > [Career Section] Administration > Career Sections > Career Section name > [Career Portal Pages] Show > Job Description > Edit User-defined Labels |
| 441412 | ContactEmailExt | Contact Email - External | Configuration > [Career Section] Administration > Career Sections > Career Section name > [Career Portal Pages] Show > Job List > Edit User-defined Labels |
| 441412 | ContactEmailExt | Contact Email - External | Configuration > [Career Section] Administration > Career Sections > Career Section name > [Career Portal Pages] Show > My Job Cart > Edit User-defined Labels |
| 441412 | ContactEmailExt | Contact Email - External | Configuration > [Career Section] Administration > Career Sections > Career Section name > [Career Portal Pages] Show > My Referrals > Edit User-defined Labels |
| 441412 | ContactEmailExt | Contact Email - External | Configuration > [Career Section] Administration > Career Sections > Career Section name > [Career Portal Pages] Show > My Submissions > Edit User-defined Labels |
| 441415 | ContactEmailInt | Contact Email - Internal | Configuration > [Career Section] Administration > Career Sections > Career Section name > [Career Portal Pages] Show > Advanced Search > Edit User-defined Labels |
| 441415 | ContactEmailInt | Contact Email - Internal | Configuration > [Career Section] Administration > Career Sections > Career Section name > [Career Portal Pages] Show > Basic Search > Edit User-defined Labels |
| 441415 | ContactEmailInt | Contact Email - Internal | Configuration > [Career Section] Administration > Career Sections > Career Section name > [Career Portal Pages] Show > Basic Search > Edit User-defined Labels |
| 441415 | ContactEmailInt | Contact Email - Internal | Configuration > [Career Section] Administration > Career Sections > Career Section name > [Career Portal Pages] Show > Job Description > Edit User-defined Labels |
| 441415 | ContactEmailInt | Contact Email - Internal | Configuration > [Career Section] Administration > Career Sections > Career Section name > [Career Portal Pages] Show > Job List > Edit User-defined Labels |
| 441415 | ContactEmailInt | Contact Email - Internal | Configuration > [Career Section] Administration > Career Sections > Career Section name > [Career Portal Pages] Show > My Job Cart > Edit User-defined Labels |
| 441415 | ContactEmailInt | Contact Email - Internal | Configuration > [Career Section] Administration > Career Sections > Career Section name > [Career Portal Pages] Show > My Referrals > Edit User-defined Labels |
| 441415 | ContactEmailInt | Contact Email - Internal | Configuration > [Career Section] Administration > Career Sections > Career Section name > [Career Portal Pages] Show > My Submissions > Edit User-defined Labels |

| ID | NAME | TALEO DEFAULT VALUE | LOCATION |
|--------|----------------|-------------------------|---|
| 441418 | ContactNameExt | Contact Name - External | Configuration > [Career Section] Administration > Career Sections > Career Section name > [Career Portal Pages] Show > Advanced Search > Edit User-defined Labels |
| 441418 | ContactNameExt | Contact Name - External | Configuration > [Career Section] Administration > Career Sections > Career Section name > [Career Portal Pages] Show > Basic Search > Edit User-defined Labels |
| 441418 | ContactNameExt | Contact Name - External | Configuration > [Career Section] Administration > Career Sections > Career Section name > [Career Portal Pages] Show > Basic Search > Edit User-defined Labels |
| 441418 | ContactNameExt | Contact Name - External | Configuration > [Career Section] Administration > Career Sections > Career Section name > [Career Portal Pages] Show > Job Description > Edit User-defined Labels |
| 441418 | ContactNameExt | Contact Name - External | Configuration > [Career Section] Administration > Career Sections > Career Section name > [Career Portal Pages] Show > Job List > Edit User-defined Labels |
| 441418 | ContactNameExt | Contact Name - External | Configuration > [Career Section] Administration > Career Sections > Career Section name > [Career Portal Pages] Show > My Job Cart > Edit User-defined Labels |
| 441418 | ContactNameExt | Contact Name - External | Configuration > [Career Section] Administration > Career Sections > Career Section name > [Career Portal Pages] Show > My Referrals > Edit User-defined Labels |
| 441418 | ContactNameExt | Contact Name - External | Configuration > [Career Section] Administration > Career Sections > Career Section name > [Career Portal Pages] Show > My Submissions > Edit User-defined Labels |
| 441421 | ContactNameInt | Contact Name - Internal | Configuration > [Career Section] Administration > Career Sections > Career Section name > [Career Portal Pages] Show > Advanced Search > Edit User-defined Labels |
| 441421 | ContactNameInt | Contact Name - Internal | Configuration > [Career Section] Administration > Career Sections > Career Section name > [Career Portal Pages] Show > Basic Search > Edit User-defined Labels |
| 441421 | ContactNameInt | Contact Name - Internal | Configuration > [Career Section] Administration > Career Sections > Career Section name > [Career Portal Pages] Show > Basic Search > Edit User-defined Labels |
| 441421 | ContactNameInt | Contact Name - Internal | Configuration > [Career Section] Administration > Career Sections > Career Section name > [Career Portal Pages] Show > Job Description > Edit User-defined Labels |
| 441421 | ContactNameInt | Contact Name - Internal | Configuration > [Career Section] Administration > Career Sections > Career Section name > [Career Portal Pages] Show > Job List > Edit User-defined Labels |
| 441421 | ContactNameInt | Contact Name - Internal | Configuration > [Career Section] Administration > Career Sections > Career Section name > [Career Portal Pages] Show > My Job Cart > Edit User-defined Labels |
| 441421 | ContactNameInt | Contact Name - Internal | Configuration > [Career Section] Administration > Career Sections > Career Section name > [Career Portal Pages] Show > My Referrals > Edit User-defined Labels |

| ID | NAME | TALEO DEFAULT VALUE | LOCATION |
|--------|----------------|---|---|
| 441421 | ContactNameInt | Contact Name - Internal | Configuration > [Career Section] Administration > Career Sections > Career Section name > [Career Portal Pages] Show > My Submissions > Edit User-defined Labels |
| 441424 | OpeningDateExt | Opening Date (Period for Applying) - External | Configuration > [Career Section] Administration > Career Sections > Career Section name > [Career Portal Pages] Show > Advanced Search > Edit User-defined Labels |
| 441424 | OpeningDateExt | Opening Date (Period for Applying) - External | Configuration > [Career Section] Administration > Career Sections > Career Section name > [Career Portal Pages] Show > Basic Search > Edit User-defined Labels |
| 441424 | OpeningDateExt | Opening Date (Period for Applying) - External | Configuration > [Career Section] Administration > Career Sections > Career Section name > [Career Portal Pages] Show > Basic Search > Edit User-defined Labels |
| 441424 | OpeningDateExt | Opening Date (Period for Applying) - External | Configuration > [Career Section] Administration > Career Sections > Career Section name > [Career Portal Pages] Show > Job Description > Edit User-defined Labels |
| 441424 | OpeningDateExt | Opening Date (Period for Applying) - External | Configuration > [Career Section] Administration > Career Sections > Career Section name > [Career Portal Pages] Show > Job List > Edit User-defined Labels |
| 441424 | OpeningDateExt | Opening Date (Period for Applying) - External | Configuration > [Career Section] Administration > Career Sections > Career Section name > [Career Portal Pages] Show > My Job Cart > Edit User-defined Labels |
| 441424 | OpeningDateExt | Opening Date (Period for Applying) - External | Configuration > [Career Section] Administration > Career Sections > Career Section name > [Career Portal Pages] Show > My Referrals > Edit User-defined Labels |
| 441424 | OpeningDateExt | Opening Date (Period for Applying) - External | Configuration > [Career Section] Administration > Career Sections > Career Section name > [Career Portal Pages] Show > My Submissions > Edit User-defined Labels |
| 441427 | OpeningDateInt | Opening Date (Period for Applying) - Internal | Configuration > [Career Section] Administration > Career Sections > Career Section name > [Career Portal Pages] Show > Advanced Search > Edit User-defined Labels |
| 441427 | OpeningDateInt | Opening Date (Period for Applying) - Internal | Configuration > [Career Section] Administration > Career Sections > Career Section name > [Career Portal Pages] Show > Basic Search > Edit User-defined Labels |
| 441427 | OpeningDateInt | Opening Date (Period for Applying) - Internal | Configuration > [Career Section] Administration > Career Sections > Career Section name > [Career Portal Pages] Show > Basic Search > Edit User-defined Labels |
| 441427 | OpeningDateInt | Opening Date (Period for Applying) - Internal | Configuration > [Career Section] Administration > Career Sections > Career Section name > [Career Portal Pages] Show > Job Description > Edit User-defined Labels |
| 441427 | OpeningDateInt | Opening Date (Period for Applying) - Internal | Configuration > [Career Section] Administration > Career Sections > Career Section name > [Career Portal Pages] Show > Job List > Edit User-defined Labels |
| 441427 | OpeningDateInt | Opening Date (Period for Applying) - Internal | Configuration > [Career Section] Administration > Career Sections > Career Section name > [Career Portal Pages] Show > My Job Cart > Edit User-defined Labels |

| ID | NAME | TALEO DEFAULT VALUE | LOCATION |
|--------|----------------|---|---|
| 441427 | OpeningDateInt | Opening Date (Period for Applying) - Internal | Configuration > [Career Section] Administration > Career Sections > Career Section name > [Career Portal Pages] Show > My Referrals > Edit User-defined Labels |
| 441427 | OpeningDateInt | Opening Date (Period for Applying) - Internal | Configuration > [Career Section] Administration > Career Sections > Career Section name > [Career Portal Pages] Show > My Submissions > Edit User-defined Labels |
| 441430 | AnnualBonus | Annual Bonus | Configuration > [Career Section] Administration > Career Sections > Career Section name > [Career Portal Pages] Show > Advanced Search > Edit User-defined Labels |
| 441430 | AnnualBonus | Annual Bonus | Configuration > [Career Section] Administration > Career Sections > Career Section name > [Career Portal Pages] Show > Basic Search > Edit User-defined Labels |
| 441430 | AnnualBonus | Annual Bonus | Configuration > [Career Section] Administration > Career Sections > Career Section name > [Career Portal Pages] Show > Basic Search > Edit User-defined Labels |
| 441430 | AnnualBonus | Annual Bonus | Configuration > [Career Section] Administration > Career Sections > Career Section name > [Career Portal Pages] Show > Job Description > Edit User-defined Labels |
| 441430 | AnnualBonus | Annual Bonus | Configuration > [Career Section] Administration > Career Sections > Career Section name > [Career Portal Pages] Show > Job List > Edit User-defined Labels |
| 441430 | AnnualBonus | Annual Bonus | Configuration > [Career Section] Administration > Career Sections > Career Section name > [Career Portal Pages] Show > My Job Cart > Edit User-defined Labels |
| 441430 | AnnualBonus | Annual Bonus | Configuration > [Career Section] Administration > Career Sections > Career Section name > [Career Portal Pages] Show > My Referrals > Edit User-defined Labels |
| 441430 | AnnualBonus | Annual Bonus | Configuration > [Career Section] Administration > Career Sections > Career Section name > [Career Portal Pages] Show > My Submissions > Edit User-defined Labels |
| 441433 | CarAllowance | Car Allowance | Configuration > [Career Section] Administration > Career Sections > Career Section name > [Career Portal Pages] Show > Advanced Search > Edit User-defined Labels |
| 441433 | CarAllowance | Car Allowance | Configuration > [Career Section] Administration > Career Sections > Career Section name > [Career Portal Pages] Show > Basic Search > Edit User-defined Labels |
| 441433 | CarAllowance | Car Allowance | Configuration > [Career Section] Administration > Career Sections > Career Section name > [Career Portal Pages] Show > Basic Search > Edit User-defined Labels |
| 441433 | CarAllowance | Car Allowance | Configuration > [Career Section] Administration > Career Sections > Career Section name > [Career Portal Pages] Show > Job Description > Edit User-defined Labels |
| 441433 | CarAllowance | Car Allowance | Configuration > [Career Section] Administration > Career Sections > Career Section name > [Career Portal Pages] Show > Job List > Edit User-defined Labels |

| ID | NAME | TALEO DEFAULT VALUE | LOCATION |
|--------|------------------|---------------------|---|
| 441433 | CarAllowance | Car Allowance | Configuration > [Career Section] Administration > Career Sections > Career Section name > [Career Portal Pages] Show > My Job Cart > Edit User-defined Labels |
| 441433 | CarAllowance | Car Allowance | Configuration > [Career Section] Administration > Career Sections > Career Section name > [Career Portal Pages] Show > My Referrals > Edit User-defined Labels |
| 441433 | CarAllowance | Car Allowance | Configuration > [Career Section] Administration > Career Sections > Career Section name > [Career Portal Pages] Show > My Submissions > Edit User-defined Labels |
| 441436 | CommissionAmount | Commission | Configuration > [Career Section] Administration > Career Sections > Career Section name > [Career Portal Pages] Show > Advanced Search > Edit User-defined Labels |
| 441436 | CommissionAmount | Commission | Configuration > [Career Section] Administration > Career Sections > Career Section name > [Career Portal Pages] Show > Basic Search > Edit User-defined Labels |
| 441436 | CommissionAmount | Commission | Configuration > [Career Section] Administration > Career Sections > Career Section name > [Career Portal Pages] Show > Basic Search > Edit User-defined Labels |
| 441436 | CommissionAmount | Commission | Configuration > [Career Section] Administration > Career Sections > Career Section name > [Career Portal Pages] Show > Job Description > Edit User-defined Labels |
| 441436 | CommissionAmount | Commission | Configuration > [Career Section] Administration > Career Sections > Career Section name > [Career Portal Pages] Show > Job List > Edit User-defined Labels |
| 441436 | CommissionAmount | Commission | Configuration > [Career Section] Administration > Career Sections > Career Section name > [Career Portal Pages] Show > My Job Cart > Edit User-defined Labels |
| 441436 | CommissionAmount | Commission | Configuration > [Career Section] Administration > Career Sections > Career Section name > [Career Portal Pages] Show > My Referrals > Edit User-defined Labels |
| 441436 | CommissionAmount | Commission | Configuration > [Career Section] Administration > Career Sections > Career Section name > [Career Portal Pages] Show > My Submissions > Edit User-defined Labels |
| 441439 | ExpenseAccount | Expense Account | Configuration > [Career Section] Administration > Career Sections > Career Section name > [Career Portal Pages] Show > Advanced Search > Edit User-defined Labels |
| 441439 | ExpenseAccount | Expense Account | Configuration > [Career Section] Administration > Career Sections > Career Section name > [Career Portal Pages] Show > Basic Search > Edit User-defined Labels |
| 441439 | ExpenseAccount | Expense Account | Configuration > [Career Section] Administration > Career Sections > Career Section name > [Career Portal Pages] Show > Basic Search > Edit User-defined Labels |
| 441439 | ExpenseAccount | Expense Account | Configuration > [Career Section] Administration > Career Sections > Career Section name > [Career Portal Pages] Show > Job Description > Edit User-defined Labels |

| ID | NAME | TALEO DEFAULT VALUE | LOCATION |
|--------|-------------------|---------------------|---|
| 441439 | ExpenseAccount | Expense Account | Configuration > [Career Section] Administration > Career Sections > Career Section name > [Career Portal Pages] Show > Job List > Edit User-defined Labels |
| 441439 | ExpenseAccount | Expense Account | Configuration > [Career Section] Administration > Career Sections > Career Section name > [Career Portal Pages] Show > My Job Cart > Edit User-defined Labels |
| 441439 | ExpenseAccount | Expense Account | Configuration > [Career Section] Administration > Career Sections > Career Section name > [Career Portal Pages] Show > My Referrals > Edit User-defined Labels |
| 441439 | ExpenseAccount | Expense Account | Configuration > [Career Section] Administration > Career Sections > Career Section name > [Career Portal Pages] Show > My Submissions > Edit User-defined Labels |
| 441442 | OtherBonus | Other Bonus | Configuration > [Career Section] Administration > Career Sections > Career Section name > [Career Portal Pages] Show > Advanced Search > Edit User-defined Labels |
| 441442 | OtherBonus | Other Bonus | Configuration > [Career Section] Administration > Career Sections > Career Section name > [Career Portal Pages] Show > Basic Search > Edit User-defined Labels |
| 441442 | OtherBonus | Other Bonus | Configuration > [Career Section] Administration > Career Sections > Career Section name > [Career Portal Pages] Show > Basic Search > Edit User-defined Labels |
| 441442 | OtherBonus | Other Bonus | Configuration > [Career Section] Administration > Career Sections > Career Section name > [Career Portal Pages] Show > Job Description > Edit User-defined Labels |
| 441442 | OtherBonus | Other Bonus | Configuration > [Career Section] Administration > Career Sections > Career Section name > [Career Portal Pages] Show > Job List > Edit User-defined Labels |
| 441442 | OtherBonus | Other Bonus | Configuration > [Career Section] Administration > Career Sections > Career Section name > [Career Portal Pages] Show > My Job Cart > Edit User-defined Labels |
| 441442 | OtherBonus | Other Bonus | Configuration > [Career Section] Administration > Career Sections > Career Section name > [Career Portal Pages] Show > My Referrals > Edit User-defined Labels |
| 441442 | OtherBonus | Other Bonus | Configuration > [Career Section] Administration > Career Sections > Career Section name > [Career Portal Pages] Show > My Submissions > Edit User-defined Labels |
| 441445 | OtherCompensation | Other Compensation | Configuration > [Career Section] Administration > Career Sections > Career Section name > [Career Portal Pages] Show > Advanced Search > Edit User-defined Labels |
| 441445 | OtherCompensation | Other Compensation | Configuration > [Career Section] Administration > Career Sections > Career Section name > [Career Portal Pages] Show > Basic Search > Edit User-defined Labels |
| 441445 | OtherCompensation | Other Compensation | Configuration > [Career Section] Administration > Career Sections > Career Section name > [Career Portal Pages] Show > Basic Search > Edit User-defined Labels |

| ID | NAME | TALEO DEFAULT VALUE | LOCATION |
|--------|-------------------|---------------------|---|
| 441445 | OtherCompensation | Other Compensation | Configuration > [Career Section] Administration > Career Sections > Career Section name > [Career Portal Pages] Show > Job Description > Edit User-defined Labels |
| 441445 | OtherCompensation | Other Compensation | Configuration > [Career Section] Administration > Career Sections > Career Section name > [Career Portal Pages] Show > Job List > Edit User-defined Labels |
| 441445 | OtherCompensation | Other Compensation | Configuration > [Career Section] Administration > Career Sections > Career Section name > [Career Portal Pages] Show > My Job Cart > Edit User-defined Labels |
| 441445 | OtherCompensation | Other Compensation | Configuration > [Career Section] Administration > Career Sections > Career Section name > [Career Portal Pages] Show > My Referrals > Edit User-defined Labels |
| 441445 | OtherCompensation | Other Compensation | Configuration > [Career Section] Administration > Career Sections > Career Section name > [Career Portal Pages] Show > My Submissions > Edit User-defined Labels |
| 441448 | PayValue | Salary (Pay Basis) | Configuration > [Career Section] Administration > Career Sections > Career Section name > [Career Portal Pages] Show > Advanced Search > Edit User-defined Labels |
| 441448 | PayValue | Salary (Pay Basis) | Configuration > [Career Section] Administration > Career Sections > Career Section name > [Career Portal Pages] Show > Basic Search > Edit User-defined Labels |
| 441448 | PayValue | Salary (Pay Basis) | Configuration > [Career Section] Administration > Career Sections > Career Section name > [Career Portal Pages] Show > Basic Search > Edit User-defined Labels |
| 441448 | PayValue | Salary (Pay Basis) | Configuration > [Career Section] Administration > Career Sections > Career Section name > [Career Portal Pages] Show > Job Description > Edit User-defined Labels |
| 441448 | PayValue | Salary (Pay Basis) | Configuration > [Career Section] Administration > Career Sections > Career Section name > [Career Portal Pages] Show > Job List > Edit User-defined Labels |
| 441448 | PayValue | Salary (Pay Basis) | Configuration > [Career Section] Administration > Career Sections > Career Section name > [Career Portal Pages] Show > My Job Cart > Edit User-defined Labels |
| 441448 | PayValue | Salary (Pay Basis) | Configuration > [Career Section] Administration > Career Sections > Career Section name > [Career Portal Pages] Show > My Referrals > Edit User-defined Labels |
| 441448 | PayValue | Salary (Pay Basis) | Configuration > [Career Section] Administration > Career Sections > Career Section name > [Career Portal Pages] Show > My Submissions > Edit User-defined Labels |
| 441451 | SignOnBonus | Sign-on Bonus | Configuration > [Career Section] Administration > Career Sections > Career Section name > [Career Portal Pages] Show > Advanced Search > Edit User-defined Labels |
| 441451 | SignOnBonus | Sign-on Bonus | Configuration > [Career Section] Administration > Career Sections > Career Section name > [Career Portal Pages] Show > Basic Search > Edit User-defined Labels |

| ID | NAME | TALEO DEFAULT VALUE | LOCATION |
|--------|-------------|---------------------|---|
| 441451 | SignOnBonus | Sign-on Bonus | Configuration > [Career Section] Administration > Career Sections > Career Section name > [Career Portal Pages] Show > Basic Search > Edit User-defined Labels |
| 441451 | SignOnBonus | Sign-on Bonus | Configuration > [Career Section] Administration > Career Sections > Career Section name > [Career Portal Pages] Show > Job Description > Edit User-defined Labels |
| 441451 | SignOnBonus | Sign-on Bonus | Configuration > [Career Section] Administration > Career Sections > Career Section name > [Career Portal Pages] Show > Job List > Edit User-defined Labels |
| 441451 | SignOnBonus | Sign-on Bonus | Configuration > [Career Section] Administration > Career Sections > Career Section name > [Career Portal Pages] Show > My Job Cart > Edit User-defined Labels |
| 441451 | SignOnBonus | Sign-on Bonus | Configuration > [Career Section] Administration > Career Sections > Career Section name > [Career Portal Pages] Show > My Referrals > Edit User-defined Labels |
| 441451 | SignOnBonus | Sign-on Bonus | Configuration > [Career Section] Administration > Career Sections > Career Section name > [Career Portal Pages] Show > My Submissions > Edit User-defined Labels |
| 441454 | StockAmount | Stock | Configuration > [Career Section] Administration > Career Sections > Career Section name > [Career Portal Pages] Show > Advanced Search > Edit User-defined Labels |
| 441454 | StockAmount | Stock | Configuration > [Career Section] Administration > Career Sections > Career Section name > [Career Portal Pages] Show > Basic Search > Edit User-defined Labels |
| 441454 | StockAmount | Stock | Configuration > [Career Section] Administration > Career Sections > Career Section name > [Career Portal Pages] Show > Basic Search > Edit User-defined Labels |
| 441454 | StockAmount | Stock | Configuration > [Career Section] Administration > Career Sections > Career Section name > [Career Portal Pages] Show > Job Description > Edit User-defined Labels |
| 441454 | StockAmount | Stock | Configuration > [Career Section] Administration > Career Sections > Career Section name > [Career Portal Pages] Show > Job List > Edit User-defined Labels |
| 441454 | StockAmount | Stock | Configuration > [Career Section] Administration > Career Sections > Career Section name > [Career Portal Pages] Show > My Job Cart > Edit User-defined Labels |
| 441454 | StockAmount | Stock | Configuration > [Career Section] Administration > Career Sections > Career Section name > [Career Portal Pages] Show > My Referrals > Edit User-defined Labels |
| 441454 | StockAmount | Stock | Configuration > [Career Section] Administration > Career Sections > Career Section name > [Career Portal Pages] Show > My Submissions > Edit User-defined Labels |
| 441457 | StockOption | Options | Configuration > [Career Section] Administration > Career Sections > Career Section name > [Career Portal Pages] Show > Advanced Search > Edit User-defined Labels |

| ID | NAME | TALEO DEFAULT VALUE | LOCATION |
|--------|-------------|---------------------|---|
| 441457 | StockOption | Options | Configuration > [Career Section] Administration > Career Sections > Career Section name > [Career Portal Pages] Show > Basic Search > Edit User-defined Labels |
| 441457 | StockOption | Options | Configuration > [Career Section] Administration > Career Sections > Career Section name > [Career Portal Pages] Show > Basic Search > Edit User-defined Labels |
| 441457 | StockOption | Options | Configuration > [Career Section] Administration > Career Sections > Career Section name > [Career Portal Pages] Show > Job Description > Edit User-defined Labels |
| 441457 | StockOption | Options | Configuration > [Career Section] Administration > Career Sections > Career Section name > [Career Portal Pages] Show > Job List > Edit User-defined Labels |
| 441457 | StockOption | Options | Configuration > [Career Section] Administration > Career Sections > Career Section name > [Career Portal Pages] Show > My Job Cart > Edit User-defined Labels |
| 441457 | StockOption | Options | Configuration > [Career Section] Administration > Career Sections > Career Section name > [Career Portal Pages] Show > My Referrals > Edit User-defined Labels |
| 441457 | StockOption | Options | Configuration > [Career Section] Administration > Career Sections > Career Section name > [Career Portal Pages] Show > My Submissions > Edit User-defined Labels |
| 441460 | Vacation | Vacation | Configuration > [Career Section] Administration > Career Sections > Career Section name > [Career Portal Pages] Show > Advanced Search > Edit User-defined Labels |
| 441460 | Vacation | Vacation | Configuration > [Career Section] Administration > Career Sections > Career Section name > [Career Portal Pages] Show > Basic Search > Edit User-defined Labels |
| 441460 | Vacation | Vacation | Configuration > [Career Section] Administration > Career Sections > Career Section name > [Career Portal Pages] Show > Basic Search > Edit User-defined Labels |
| 441460 | Vacation | Vacation | Configuration > [Career Section] Administration > Career Sections > Career Section name > [Career Portal Pages] Show > Job Description > Edit User-defined Labels |
| 441460 | Vacation | Vacation | Configuration > [Career Section] Administration > Career Sections > Career Section name > [Career Portal Pages] Show > Job List > Edit User-defined Labels |
| 441460 | Vacation | Vacation | Configuration > [Career Section] Administration > Career Sections > Career Section name > [Career Portal Pages] Show > My Job Cart > Edit User-defined Labels |
| 441460 | Vacation | Vacation | Configuration > [Career Section] Administration > Career Sections > Career Section name > [Career Portal Pages] Show > My Referrals > Edit User-defined Labels |
| 441460 | Vacation | Vacation | Configuration > [Career Section] Administration > Career Sections > Career Section name > [Career Portal Pages] Show > My Submissions > Edit User-defined Labels |

| ID | NAME | TALEO DEFAULT VALUE | LOCATION |
|--------|--------------------------------|--|---|
| 449673 | Sites | Work Locations | Configuration > [Career Section] Administration > Career Sections > Career Section name > [Career Portal Pages] Show > Advanced Search > Edit User-defined Labels |
| 449673 | Sites | Work Locations | Configuration > [Career Section] Administration > Career Sections > Career Section name > [Career Portal Pages] Show > Basic Search > Edit User-defined Labels |
| 449673 | Sites | Work Locations | Configuration > [Career Section] Administration > Career Sections > Career Section name > [Career Portal Pages] Show > Basic Search > Edit User-defined Labels |
| 449673 | Sites | Work Locations | Configuration > [Career Section] Administration > Career Sections > Career Section name > [Career Portal Pages] Show > Job Description > Edit User-defined Labels |
| 449673 | Sites | Work Locations | Configuration > [Career Section] Administration > Career Sections > Career Section name > [Career Portal Pages] Show > Job List > Edit User-defined Labels |
| 449673 | Sites | Work Locations | Configuration > [Career Section] Administration > Career Sections > Career Section name > [Career Portal Pages] Show > My Job Cart > Edit User-defined Labels |
| 449673 | Sites | Work Locations | Configuration > [Career Section] Administration > Career Sections > Career Section name > [Career Portal Pages] Show > My Referrals > Edit User-defined Labels |
| 449673 | Sites | Work Locations | Configuration > [Career Section] Administration > Career Sections > Career Section name > [Career Portal Pages] Show > My Submissions > Edit User-defined Labels |
| 486036 | NoSubject | No subject | Configuration > [Career Section] Administration > Career Sections > Career Section name > [Career Portal Pages] Show > My Submissions > Edit User-defined Labels |
| 516471 | ReApplyAction | Re-apply | Configuration > [Career Section] Administration > Career Sections > Career Section name > [Career Portal Pages] Show > My Referrals > Edit User-defined Labels |
| 516478 | ReApplyActionTT | Re-apply for this job | Configuration > [Career Section] Administration > Career Sections > Career Section name > [Career Portal Pages] Show > My Referrals > Edit User-defined Labels |
| 516508 | DeleteMessageConfirmationTitle | You are about to delete all your saved searches. | Configuration > [Career Section] Administration > Career Sections > Career Section name > [Career Portal Pages] Show > My Saved Searches > Edit User-defined Labels |
| 516523 | DeleteMessageText | This action cannot be undone. Are you sure that you want to delete them? | Configuration > [Career Section] Administration > Career Sections > Career Section name > [Career Portal Pages] Show > My Saved Searches > Edit User-defined Labels |
| 516538 | NoCommand | No | Configuration > [Career Section] Administration > Career Sections > Career Section name > [Career Portal Pages] Show > My Saved Searches > Edit User-defined Labels |
| 516541 | NoCommandTT | Cancel the action | Configuration > [Career Section] Administration > Career Sections > Career Section name > [Career Portal Pages] Show > My Saved Searches > Edit User-defined Labels |

| ID | NAME | TALEO DEFAULT VALUE | LOCATION |
|--------|--------------------------------|---|---|
| 516556 | YesCommand | Yes | Configuration > [Career Section] Administration > Career Sections > Career Section name > [Career Portal Pages] Show > My Saved Searches > Edit User-defined Labels |
| 516559 | YesCommandTT | Delete all saved searches | Configuration > [Career Section] Administration > Career Sections > Career Section name > [Career Portal Pages] Show > My Saved Searches > Edit User-defined Labels |
| 516579 | DeleteMessageConfirmationTitle | You are about to delete the saved search "{0}". | Configuration > [Career Section] Administration > Career Sections > Career Section name > [Career Portal Pages] Show > My Saved Searches > Edit User-defined Labels |
| 516594 | DeleteMessageText | Are you sure that you want to delete it? | Configuration > [Career Section] Administration > Career Sections > Career Section name > [Career Portal Pages] Show > My Saved Searches > Edit User-defined Labels |
| 516609 | NoCommand | No | Configuration > [Career Section] Administration > Career Sections > Career Section name > [Career Portal Pages] Show > My Saved Searches > Edit User-defined Labels |
| 516612 | NoCommandTT | Cancel the action | Configuration > [Career Section] Administration > Career Sections > Career Section name > [Career Portal Pages] Show > My Saved Searches > Edit User-defined Labels |
| 516627 | YesCommand | Yes | Configuration > [Career Section] Administration > Career Sections > Career Section name > [Career Portal Pages] Show > My Saved Searches > Edit User-defined Labels |
| 516630 | YesCommandTT | Delete the saved search | Configuration > [Career Section] Administration > Career Sections > Career Section name > [Career Portal Pages] Show > My Saved Searches > Edit User-defined Labels |
| 523054 | Relevance | Relevance | Configuration > [Career Section] Administration > Career Sections > Career Section name > [Career Portal Pages] Show > Advanced Search > Edit User-defined Labels |
| 523054 | Relevance | Relevance | Configuration > [Career Section] Administration > Career Sections > Career Section name > [Career Portal Pages] Show > Basic Search > Edit User-defined Labels |
| 523054 | Relevance | Relevance | Configuration > [Career Section] Administration > Career Sections > Career Section name > [Career Portal Pages] Show > Basic Search > Edit User-defined Labels |
| 523054 | Relevance | Relevance | Configuration > [Career Section] Administration > Career Sections > Career Section name > [Career Portal Pages] Show > Job Description > Edit User-defined Labels |
| 523054 | Relevance | Relevance | Configuration > [Career Section] Administration > Career Sections > Career Section name > [Career Portal Pages] Show > Job List > Edit User-defined Labels |
| 523054 | Relevance | Relevance | Configuration > [Career Section] Administration > Career Sections > Career Section name > [Career Portal Pages] Show > My Job Cart > Edit User-defined Labels |
| 523054 | Relevance | Relevance | Configuration > [Career Section] Administration > Career Sections > Career Section name > [Career Portal Pages] Show > My Referrals > Edit User-defined Labels |

| ID | NAME | TALEO DEFAULT VALUE | LOCATION |
|--------|-----------------------------------|--|---|
| 523054 | Relevance | Relevance | Configuration > [Career Section] Administration > Career Sections > Career Section name > [Career Portal Pages] Show > My Submissions > Edit User-defined Labels |
| 523720 | ReferralsPerPage | Referrals per page: | Configuration > [Career Section] Administration > Career Sections > Career Section name > [Career Portal Pages] Show > My Referrals > Edit User-defined Labels |
| 527369 | ViewJobDescriptionTT | View this job description | Configuration > [Career Section] Administration > Career Sections > Career Section name > [Career Portal Pages] Show > Basic Search > Edit User-defined Labels |
| 527369 | ViewJobDescriptionTT | View this job description | Configuration > [Career Section] Administration > Career Sections > Career Section name > [Career Portal Pages] Show > Job Description > Edit User-defined Labels |
| 527369 | ViewJobDescriptionTT | View this job description | Configuration > [Career Section] Administration > Career Sections > Career Section name > [Career Portal Pages] Show > Job List > Edit User-defined Labels |
| 527369 | ViewJobDescriptionTT | View this job description | Configuration > [Career Section] Administration > Career Sections > Career Section name > [Career Portal Pages] Show > My Job Cart > Edit User-defined Labels |
| 527369 | ViewJobDescriptionTT | View this job description | Configuration > [Career Section] Administration > Career Sections > Career Section name > [Career Portal Pages] Show > My Referrals > Edit User-defined Labels |
| 527369 | ViewJobDescriptionTT | View this job description | Configuration > [Career Section] Administration > Career Sections > Career Section name > [Career Portal Pages] Show > My Submissions > Edit User-defined Labels |
| 565451 | OrganizationName | Taleo | Configuration > [Career Section] Administration > Career Sections > Career Section name > [Career Portal Pages] Edit User-defined Labels |
| 565466 | JavaScriptNotActivatedDescription | The JavaScript support is not activated in your browser. Please activate JavaScript. | Configuration > [Career Section] Administration > Career Sections > Career Section name > [Career Portal Pages] Edit User-defined Labels |
| 565483 | JavaScriptNotActivatedTitle | JavaScript Not Enabled | Configuration > [Career Section] Administration > Career Sections > Career Section name > [Career Portal Pages] Edit User-defined Labels |
| 565498 | SignatureLabel | System Administrator | Configuration > [Career Section] Administration > Career Sections > Career Section name > [Career Portal Pages] Edit User-defined Labels |
| 565515 | ThanksUnderstanding | Thank you for your understanding. | Configuration > [Career Section] Administration > Career Sections > Career Section name > [Career Portal Pages] Edit User-defined Labels |
| 575473 | TotalJobsFound | {{0}} jobs found) | Configuration > [Career Section] Administration > Career Sections > Career Section name > [Career Portal Pages] Show > Basic Search > Edit User-defined Labels |
| 575473 | TotalJobsFound | {{0}} jobs found) | Configuration > [Career Section] Administration > Career Sections > Career Section name > [Career Portal Pages] Show > Job Description > Edit User-defined Labels |

| ID | NAME | TALEO DEFAULT VALUE | LOCATION |
|--------|---------------------------|--|--|
| 575473 | TotalJobsFound | {{0}} jobs found) | Configuration > [Career Section] Administration > Career Sections > Career Section name > [Career Portal Pages] Show > Job List > Edit User-defined Labels |
| 575473 | TotalJobsFound | {{0}} jobs found) | Configuration > [Career Section] Administration > Career Sections > Career Section name > [Career Portal Pages] Show > My Job Cart > Edit User-defined Labels |
| 575473 | TotalJobsFound | {{0}} jobs found) | Configuration > [Career Section] Administration > Career Sections > Career Section name > [Career Portal Pages] Show > My Referrals > Edit User-defined Labels |
| 575473 | TotalJobsFound | {{0}} jobs found) | Configuration > [Career Section] Administration > Career Sections > Career Section name > [Career Portal Pages] Show > My Submissions > Edit User-defined Labels |
| 575494 | TotalJobsFound | {{0}} jobs found) | Configuration > [Career Section] Administration > Career Sections > Career Section name > [Career Portal Pages] Show > My Job Cart > Edit User-defined Labels |
| 578100 | TotalSubmissionsFound | {{0}} job submissions found) | Configuration > [Career Section] Administration > Career Sections > Career Section name > [Career Portal Pages] Show > My Submissions > Edit User-defined Labels |
| 578113 | TotalReferralsFound | {{0}} referrals found) | Configuration > [Career Section] Administration > Career Sections > Career Section name > [Career Portal Pages] Show > My Referrals > Edit User-defined Labels |
| 613101 | NoGeneralProfile | You don't have a candidate profile for the moment. | Configuration > [Career Section] Administration > Career Sections > Career Section name > [Career Portal Pages] Show > Basic Search > Edit User-defined Labels |
| 613587 | SubmissionStatusTT | View this submission status details | Configuration > [Career Section] Administration > Career Sections > Career Section name > [Career Portal Pages] Show > My Submissions > Edit User-defined Labels |
| 613594 | SubmissionStatusTT | View this submission status details | Configuration > [Career Section] Administration > Career Sections > Career Section name > [Career Portal Pages] Show > My Referrals > Edit User-defined Labels |
| 617638 | GeneralProfile | General Profile | Configuration > [Career Section] Administration > Career Sections > Career Section name > [Career Portal Pages] Show > My Referrals > Edit User-defined Labels |
| 667616 | RegistrationTitle | Registration | Configuration > [Career Section] Administration > Career Sections > Career Section name > [Career Portal Pages] Show > Access Management |
| 667623 | RegistrationDescription | You received an email to confirm the creation of your user account. Please enter the login information as provided in the email. | Configuration > [Career Section] Administration > Career Sections > Career Section name > [Career Portal Pages] Show > Access Management |
| 721224 | ChangePasswordAndUserName | This page allows you to change your user name and password. | Configuration > [Career Section] Administration > Career Sections > Career Section name > [Career Portal Pages] Show > Access Management |
| 721227 | ChangePasswordTitle | Change User Name and Password | Configuration > [Career Section] Administration > Career Sections > Career Section name > [Career Portal Pages] Show > Access Management |

| ID | NAME | TALEO DEFAULT VALUE | LOCATION |
|--------|---------------------------|--|---|
| 721230 | ConfirmNewPassword | Confirm New Password | Configuration > [Career Section] Administration > Career Sections > Career Section name > [Career Portal Pages] Show > Access Management |
| 721233 | NewPassword | New Password | Configuration > [Career Section] Administration > Career Sections > Career Section name > [Career Portal Pages] Show > Access Management |
| 721236 | NewUserName | New User Name | Configuration > [Career Section] Administration > Career Sections > Career Section name > [Career Portal Pages] Show > Access Management |
| 721239 | OKCommand | OK | Configuration > [Career Section] Administration > Career Sections > Career Section name > [Career Portal Pages] Show > Access Management |
| 721242 | OKCommandTT | Save changes and close this window | Configuration > [Career Section] Administration > Career Sections > Career Section name > [Career Portal Pages] Show > Access Management |
| 721245 | OldPassword | Old Password | Configuration > [Career Section] Administration > Career Sections > Career Section name > [Career Portal Pages] Show > Access Management |
| 757217 | RadiusSearchInstruction | To view a list of relevant site criteria, select a country and a zip/postal code, then specify a distance. The system will display a list of sites available within the selected distance. | Configuration > [Career Section] Administration > Career Sections > Career Section name > [Career Portal Pages] Show > Basic Search > Edit User-defined Labels |
| 757224 | ListContentDescription | The following list displays the {0} closest sites within {1} {2} of the selected zip/postal code. | Configuration > [Career Section] Administration > Career Sections > Career Section name > [Career Portal Pages] Show > Basic Search > Edit User-defined Labels |
| 757231 | SelectingSitesInstuction1 | Select the box next to the sites where you would like to apply for a job to verify if there are any positions available. | Configuration > [Career Section] Administration > Career Sections > Career Section name > [Career Portal Pages] Show > Basic Search > Edit User-defined Labels |
| 757238 | SelectingSitesInstuction2 | To locate a site on a map, click the relevant site name. | Configuration > [Career Section] Administration > Career Sections > Career Section name > [Career Portal Pages] Show > Basic Search > Edit User-defined Labels |
| 757247 | Site | Site | Configuration > [Career Section] Administration > Career Sections > Career Section name > [Career Portal Pages] Show > Basic Search > Edit User-defined Labels |
| 757254 | Address | Address | Configuration > [Career Section] Administration > Career Sections > Career Section name > [Career Portal Pages] Show > Basic Search > Edit User-defined Labels |
| 757261 | SiteNameTT | Locate this site on map: {0} | Configuration > [Career Section] Administration > Career Sections > Career Section name > [Career Portal Pages] Show > Basic Search > Edit User-defined Labels |
| 757268 | ListContentDescription | The following list displays the {0} closest sites within {1} {2} of the selected zip/postal code. | Configuration > [Career Section] Administration > Career Sections > Career Section name > [Career Portal Pages] Show > Advanced Search > Edit User-defined Labels |

| ID | NAME | TALEO DEFAULT VALUE | LOCATION |
|--------|---------------------------|--|---|
| 757271 | Address | Address | Configuration > [Career Section] Administration > Career Sections > Career Section name > [Career Portal Pages] Show > Advanced Search > Edit User-defined Labels |
| 757274 | RadiusSearchInstruction | To view a list of relevant site criteria, select a country and a zip/postal code, then specify a distance. The system will display a list of sites available within the selected distance. | Configuration > [Career Section] Administration > Career Sections > Career Section name > [Career Portal Pages] Show > Advanced Search > Edit User-defined Labels |
| 757277 | SelectingSitesInstuction1 | Select the box next to the sites where you would like to apply for a job to verify if there are any positions available. | Configuration > [Career Section] Administration > Career Sections > Career Section name > [Career Portal Pages] Show > Advanced Search > Edit User-defined Labels |
| 757280 | SelectingSitesInstuction2 | To locate a site on a map, click the relevant site name. | Configuration > [Career Section] Administration > Career Sections > Career Section name > [Career Portal Pages] Show > Advanced Search > Edit User-defined Labels |
| 757283 | Site | Site | Configuration > [Career Section] Administration > Career Sections > Career Section name > [Career Portal Pages] Show > Advanced Search > Edit User-defined Labels |
| 757286 | SiteNameTT | Locate this site on map: {0} | Configuration > [Career Section] Administration > Career Sections > Career Section name > [Career Portal Pages] Show > Advanced Search > Edit User-defined Labels |
| 760679 | MilesMinuscule | miles | Configuration > [Career Section] Administration > Career Sections > Career Section name > [Career Portal Pages] Show > Basic Search > Edit User-defined Labels |
| 760714 | KilometersMinuscule | kilometers | Configuration > [Career Section] Administration > Career Sections > Career Section name > [Career Portal Pages] Show > Basic Search > Edit User-defined Labels |
| 760731 | KilometersMinuscule | kilometers | Configuration > [Career Section] Administration > Career Sections > Career Section name > [Career Portal Pages] Show > Advanced Search > Edit User-defined Labels |
| 760734 | MilesMinuscule | miles | Configuration > [Career Section] Administration > Career Sections > Career Section name > [Career Portal Pages] Show > Advanced Search > Edit User-defined Labels |
| 761012 | NoMatchingEntries | No matching entries found. | Configuration > [Career Section] Administration > Career Sections > Career Section name > [Career Portal Pages] Show > Basic Search > Edit User-defined Labels |
| 761015 | NoMatchingEntries | No matching entries found. | Configuration > [Career Section] Administration > Career Sections > Career Section name > [Career Portal Pages] Show > Advanced Search > Edit User-defined Labels |
| 761354 | UserNameEmail | Email Address | Configuration > [Career Section] Administration > Career Sections > Career Section name > [Career Portal Pages] Show > Access Management |
| 761357 | UserNameSSN | Social Security Number | Configuration > [Career Section] Administration > Career Sections > Career Section name > [Career Portal Pages] Show > Access Management |

| ID | NAME | TALEO DEFAULT VALUE | LOCATION |
|--------|--------------------------|---|---|
| 818890 | AppTimeout | Application has timed out. | Configuration > [Career Section] Administration > Career Sections > Career Section name > [Career Portal Pages] Show > Access Management |
| 818893 | AssertionTimeOut | Assertion has timed out. | Configuration > [Career Section] Administration > Career Sections > Career Section name > [Career Portal Pages] Show > Access Management |
| 818896 | BrowserNotSupported | Incompatible internet browser. | Configuration > [Career Section] Administration > Career Sections > Career Section name > [Career Portal Pages] Show > Access Management |
| 818899 | CookieNotEnabled | Browser settings does not allow the cookies. | Configuration > [Career Section] Administration > Career Sections > Career Section name > [Career Portal Pages] Show > Access Management |
| 818902 | InvalidAssertion | Invalid assertion. | Configuration > [Career Section] Administration > Career Sections > Career Section name > [Career Portal Pages] Show > Access Management |
| 818905 | InvalidPassword | The password you have entered is invalid. | Configuration > [Career Section] Administration > Career Sections > Career Section name > [Career Portal Pages] Show > Access Management |
| 818908 | InvalidSecretQuestion | Invalid answer to secret question. | Configuration > [Career Section] Administration > Career Sections > Career Section name > [Career Portal Pages] Show > Access Management |
| 818911 | InvalidSignOnCredentials | Invalid Sign On Credentials. | Configuration > [Career Section] Administration > Career Sections > Career Section name > [Career Portal Pages] Show > Access Management |
| 818914 | InvalidUserName | The value you have entered in the field "{0}" does not correspond to a registered user. | Configuration > [Career Section] Administration > Career Sections > Career Section name > [Career Portal Pages] Show > Access Management |
| 818917 | JSNotEnabled | Browser setting does not allow javascript. | Configuration > [Career Section] Administration > Career Sections > Career Section name > [Career Portal Pages] Show > Access Management |
| 818920 | NoUserAccount | No account is associated to the user. | Configuration > [Career Section] Administration > Career Sections > Career Section name > [Career Portal Pages] Show > Access Management |
| 818923 | NotProdReady | Application not in production mode. | Configuration > [Career Section] Administration > Career Sections > Career Section name > [Career Portal Pages] Show > Access Management |
| 818926 | PasswordExpired | Password has expired. | Configuration > [Career Section] Administration > Career Sections > Career Section name > [Career Portal Pages] Show > Access Management |
| 818929 | PopupBlocker | Current browser setting has popup blocked enabled. It must be disabled. | Configuration > [Career Section] Administration > Career Sections > Career Section name > [Career Portal Pages] Show > Access Management |
| 825041 | NotSpecified | Not Specified | Configuration > [Career Section] Administration > Career Sections > Career Section name > [Career Portal Pages] Show > Advanced Search > Edit User-defined Labels |

| ID | NAME | TALEO DEFAULT VALUE | LOCATION |
|--------|------------------------------|---|---|
| 883858 | InvalidEmail | The email address you have entered does not correspond to a registered user. | Configuration > [Career Section] Administration > Career Sections > Career Section name > [Career Portal Pages] Show > Access Management |
| 886768 | InvalidLogin | The value you entered for the field "{0}" does not correspond to a registered user. | Configuration > [Career Section] Administration > Career Sections > Career Section name > [Career Portal Pages] Show > Access Management |
| 913282 | OneJobFound | {{0} job found) | Configuration > [Career Section] Administration > Career Sections > Career Section name > [Career Portal Pages] Show > Basic Search > Edit User-defined Labels |
| 913282 | OneJobFound | {{0} job found) | Configuration > [Career Section] Administration > Career Sections > Career Section name > [Career Portal Pages] Show > Job Description > Edit User-defined Labels |
| 913282 | OneJobFound | {{0} job found) | Configuration > [Career Section] Administration > Career Sections > Career Section name > [Career Portal Pages] Show > Job List > Edit User-defined Labels |
| 913282 | OneJobFound | {{0} job found) | Configuration > [Career Section] Administration > Career Sections > Career Section name > [Career Portal Pages] Show > My Job Cart > Edit User-defined Labels |
| 913282 | OneJobFound | {{0} job found) | Configuration > [Career Section] Administration > Career Sections > Career Section name > [Career Portal Pages] Show > My Referrals > Edit User-defined Labels |
| 913282 | OneJobFound | {{0} job found) | Configuration > [Career Section] Administration > Career Sections > Career Section name > [Career Portal Pages] Show > My Submissions > Edit User-defined Labels |
| 914482 | BackToHomePageAction | Return to the home page | Configuration > [Career Section] Administration > Career Sections > Career Section name > [Career Portal Pages] Show > Job Description > Edit User-defined Labels |
| 914495 | BackToHomePageActionTT | Return to the Career Section home page | Configuration > [Career Section] Administration > Career Sections > Career Section name > [Career Portal Pages] Show > Job Description > Edit User-defined Labels |
| 914508 | AddToJobCartActionVariableTT | Add this position to the job cart: {JOB_TITLE} | Configuration > [Career Section] Administration > Career Sections > Career Section name > [Career Portal Pages] Show > Basic Search > Edit User-defined Labels |
| 914508 | AddToJobCartActionVariableTT | Add this position to the job cart: {JOB_TITLE} | Configuration > [Career Section] Administration > Career Sections > Career Section name > [Career Portal Pages] Show > Job Description > Edit User-defined Labels |
| 914508 | AddToJobCartActionVariableTT | Add this position to the job cart: {JOB_TITLE} | Configuration > [Career Section] Administration > Career Sections > Career Section name > [Career Portal Pages] Show > Job List > Edit User-defined Labels |
| 914508 | AddToJobCartActionVariableTT | Add this position to the job cart: {JOB_TITLE} | Configuration > [Career Section] Administration > Career Sections > Career Section name > [Career Portal Pages] Show > My Job Cart > Edit User-defined Labels |
| 914508 | AddToJobCartActionVariableTT | Add this position to the job cart: {JOB_TITLE} | Configuration > [Career Section] Administration > Career Sections > Career Section name > [Career Portal Pages] Show > My Referrals > Edit User-defined Labels |

| ID | NAME | TALEO DEFAULT VALUE | LOCATION |
|--------|--------------------------------|--|---|
| 914508 | AddToJobCartActionVariableTT | Add this position to the job cart: {JOB_TITLE} | Configuration > [Career Section] Administration > Career Sections > Career Section name > [Career Portal Pages] Show > My Submissions > Edit User-defined Labels |
| 914578 | ApplyActionVariableTT | Apply for this position ({JOB_TITLE}) | Configuration > [Career Section] Administration > Career Sections > Career Section name > [Career Portal Pages] Show > Basic Search > Edit User-defined Labels |
| 914578 | ApplyActionVariableTT | Apply for this position ({JOB_TITLE}) | Configuration > [Career Section] Administration > Career Sections > Career Section name > [Career Portal Pages] Show > Job Description > Edit User-defined Labels |
| 914578 | ApplyActionVariableTT | Apply for this position ({JOB_TITLE}) | Configuration > [Career Section] Administration > Career Sections > Career Section name > [Career Portal Pages] Show > Job List > Edit User-defined Labels |
| 914578 | ApplyActionVariableTT | Apply for this position ({JOB_TITLE}) | Configuration > [Career Section] Administration > Career Sections > Career Section name > [Career Portal Pages] Show > My Job Cart > Edit User-defined Labels |
| 914578 | ApplyActionVariableTT | Apply for this position ({JOB_TITLE}) | Configuration > [Career Section] Administration > Career Sections > Career Section name > [Career Portal Pages] Show > My Referrals > Edit User-defined Labels |
| 914578 | ApplyActionVariableTT | Apply for this position ({JOB_TITLE}) | Configuration > [Career Section] Administration > Career Sections > Career Section name > [Career Portal Pages] Show > My Submissions > Edit User-defined Labels |
| 914587 | ApplyActionVariableTT | Apply for this position ({JOB_TITLE}) | Configuration > [Career Section] Administration > Career Sections > Career Section name > [Career Portal Pages] Show > My Job Cart > Edit User-defined Labels |
| 914603 | ViewEditSubmissionActionTT | View or modify this job submission ({JOB_TITLE}) | Configuration > [Career Section] Administration > Career Sections > Career Section name > [Career Portal Pages] Show > Basic Search > Edit User-defined Labels |
| 914603 | ViewEditSubmissionActionTT | View or modify this job submission ({JOB_TITLE}) | Configuration > [Career Section] Administration > Career Sections > Career Section name > [Career Portal Pages] Show > Job Description > Edit User-defined Labels |
| 914603 | ViewEditSubmissionActionTT | View or modify this job submission ({JOB_TITLE}) | Configuration > [Career Section] Administration > Career Sections > Career Section name > [Career Portal Pages] Show > Job List > Edit User-defined Labels |
| 914603 | ViewEditSubmissionActionTT | View or modify this job submission ({JOB_TITLE}) | Configuration > [Career Section] Administration > Career Sections > Career Section name > [Career Portal Pages] Show > My Job Cart > Edit User-defined Labels |
| 914603 | ViewEditSubmissionActionTT | View or modify this job submission ({JOB_TITLE}) | Configuration > [Career Section] Administration > Career Sections > Career Section name > [Career Portal Pages] Show > My Referrals > Edit User-defined Labels |
| 914603 | ViewEditSubmissionActionTT | View or modify this job submission ({JOB_TITLE}) | Configuration > [Career Section] Administration > Career Sections > Career Section name > [Career Portal Pages] Show > My Submissions > Edit User-defined Labels |
| 914612 | ViewSubmissionVariableActionTT | View this job submission ({JOB_TITLE}) | Configuration > [Career Section] Administration > Career Sections > Career Section name > [Career Portal Pages] Show > My Submissions > Edit User-defined Labels |

| ID | NAME | TALEO DEFAULT VALUE | LOCATION |
|--------|-------------------------------|---|---|
| 914620 | FinishDraftSubmissionActionTT | Finish this draft submission ({JOB_TITLE}) | Configuration > [Career Section] Administration > Career Sections > Career Section name > [Career Portal Pages] Show > My Submissions > Edit User-defined Labels |
| 914633 | FinishDraftSubmissionActionTT | Finish this draft submission ({JOB_TITLE}) | Configuration > [Career Section] Administration > Career Sections > Career Section name > [Career Portal Pages] Show > Basic Search > Edit User-defined Labels |
| 914633 | FinishDraftSubmissionActionTT | Finish this draft submission ({JOB_TITLE}) | Configuration > [Career Section] Administration > Career Sections > Career Section name > [Career Portal Pages] Show > Job Description > Edit User-defined Labels |
| 914633 | FinishDraftSubmissionActionTT | Finish this draft submission ({JOB_TITLE}) | Configuration > [Career Section] Administration > Career Sections > Career Section name > [Career Portal Pages] Show > Job List > Edit User-defined Labels |
| 914633 | FinishDraftSubmissionActionTT | Finish this draft submission ({JOB_TITLE}) | Configuration > [Career Section] Administration > Career Sections > Career Section name > [Career Portal Pages] Show > My Job Cart > Edit User-defined Labels |
| 914633 | FinishDraftSubmissionActionTT | Finish this draft submission ({JOB_TITLE}) | Configuration > [Career Section] Administration > Career Sections > Career Section name > [Career Portal Pages] Show > My Referrals > Edit User-defined Labels |
| 914633 | FinishDraftSubmissionActionTT | Finish this draft submission ({JOB_TITLE}) | Configuration > [Career Section] Administration > Career Sections > Career Section name > [Career Portal Pages] Show > My Submissions > Edit User-defined Labels |
| 914636 | WithdrawVariableActionTT | Withdraw this submission ({JOB_TITLE}) | Configuration > [Career Section] Administration > Career Sections > Career Section name > [Career Portal Pages] Show > My Submissions > Edit User-defined Labels |
| 918325 | RemoveActionVariableTT | Remove this job from the job cart ({JOB_TITLE}) | Configuration > [Career Section] Administration > Career Sections > Career Section name > [Career Portal Pages] Show > My Job Cart > Edit User-defined Labels |
| 918344 | ViewReferralVariableActionTT | View/edit this referral ({JOB_TITLE}) | Configuration > [Career Section] Administration > Career Sections > Career Section name > [Career Portal Pages] Show > My Referrals > Edit User-defined Labels |
| 918399 | FinishVariableActionTT | Finish this draft referral ({JOB_TITLE}) | Configuration > [Career Section] Administration > Career Sections > Career Section name > [Career Portal Pages] Show > My Referrals > Edit User-defined Labels |
| 918412 | WhitdrawVariableActionTT | Withdraw this referral ({JOB_TITLE}) | Configuration > [Career Section] Administration > Career Sections > Career Section name > [Career Portal Pages] Show > My Referrals > Edit User-defined Labels |
| 918421 | DeleteVariableActionTT | Delete this message ({JOB_TITLE}) | Configuration > [Career Section] Administration > Career Sections > Career Section name > [Career Portal Pages] Show > My Submissions > Edit User-defined Labels |
| 919937 | ReApplyVariableActionTT | Re-apply for this job ({JOB_TITLE}) | Configuration > [Career Section] Administration > Career Sections > Career Section name > [Career Portal Pages] Show > My Referrals > Edit User-defined Labels |
| 919948 | ReApplyVariableActionTT | Re-apply for this job ({JOB_TITLE}) | Configuration > [Career Section] Administration > Career Sections > Career Section name > [Career Portal Pages] Show > My Submissions > Edit User-defined Labels |

| ID | NAME | TALEO DEFAULT VALUE | LOCATION |
|--------|-------------------------------|---|---|
| 919951 | DeleteVariableActionTT | Delete this saved search ({{0}}) | Configuration > [Career Section] Administration > Career Sections > Career Section name > [Career Portal Pages] Show > My Saved Searches > Edit User-defined Labels |
| 919962 | SearchNameVariableTT | View this search query criteria ({{0}}) | Configuration > [Career Section] Administration > Career Sections > Career Section name > [Career Portal Pages] Show > My Saved Searches > Edit User-defined Labels |
| 919971 | JobOpeningsVarTT | View this search results ({{0}}) | Configuration > [Career Section] Administration > Career Sections > Career Section name > [Career Portal Pages] Show > My Saved Searches > Edit User-defined Labels |
| 919978 | ReferCandidateVariableActionT | Refer a candidate for this position ({{JOB_TITLE}}) | Configuration > [Career Section] Administration > Career Sections > Career Section name > [Career Portal Pages] Show > Job Description > Edit User-defined Labels |
| 923379 | HiringManager | Hiring Manager | Configuration > [Career Section] Administration > Career Sections > Career Section name > [Career Portal Pages] Show > Advanced Search > Edit User-defined Labels |
| 923379 | HiringManager | Hiring Manager | Configuration > [Career Section] Administration > Career Sections > Career Section name > [Career Portal Pages] Show > Basic Search > Edit User-defined Labels |
| 923379 | HiringManager | Hiring Manager | Configuration > [Career Section] Administration > Career Sections > Career Section name > [Career Portal Pages] Show > Basic Search > Edit User-defined Labels |
| 923379 | HiringManager | Hiring Manager | Configuration > [Career Section] Administration > Career Sections > Career Section name > [Career Portal Pages] Show > Job Description > Edit User-defined Labels |
| 923379 | HiringManager | Hiring Manager | Configuration > [Career Section] Administration > Career Sections > Career Section name > [Career Portal Pages] Show > Job List > Edit User-defined Labels |
| 923379 | HiringManager | Hiring Manager | Configuration > [Career Section] Administration > Career Sections > Career Section name > [Career Portal Pages] Show > My Job Cart > Edit User-defined Labels |
| 923379 | HiringManager | Hiring Manager | Configuration > [Career Section] Administration > Career Sections > Career Section name > [Career Portal Pages] Show > My Referrals > Edit User-defined Labels |
| 923379 | HiringManager | Hiring Manager | Configuration > [Career Section] Administration > Career Sections > Career Section name > [Career Portal Pages] Show > My Submissions > Edit User-defined Labels |
| 928993 | ConfirmAction | Confirm | Configuration > [Career Section] Administration > Career Sections > Career Section name > [Career Portal Pages] Show > My Referrals > Edit User-defined Labels |
| 928996 | ConfirmActionTT | Confirm this referral ({{JOB_TITLE}}) | Configuration > [Career Section] Administration > Career Sections > Career Section name > [Career Portal Pages] Show > My Referrals > Edit User-defined Labels |
| 929581 | UserNameAndEmailMandatory | Please enter a User Name and an Email Address. | Configuration > [Career Section] Administration > Career Sections > Career Section name > [Career Portal Pages] Show > Access Management |

| ID | NAME | TALEO DEFAULT VALUE | LOCATION |
|---------|-----------------------------|---|---|
| 993724 | Subject | Subject | Configuration > [Career Section] Administration > Career Sections > Career Section name > [Career Portal Pages] Show > My Submissions > Edit User-defined Labels |
| 995076 | InvalidUserNameAndEmailAddr | The User Name and Email Address combination you entered does not correspond to a registered user. | Configuration > [Career Section] Administration > Career Sections > Career Section name > [Career Portal Pages] Show > Access Management |
| 997363 | OngoingPosting | Ongoing | Configuration > [Career Section] Administration > Career Sections > Career Section name > [Career Portal Pages] Show > Basic Search > Edit User-defined Labels |
| 997363 | OngoingPosting | Ongoing | Configuration > [Career Section] Administration > Career Sections > Career Section name > [Career Portal Pages] Show > Job Description > Edit User-defined Labels |
| 997363 | OngoingPosting | Ongoing | Configuration > [Career Section] Administration > Career Sections > Career Section name > [Career Portal Pages] Show > Job List > Edit User-defined Labels |
| 997363 | OngoingPosting | Ongoing | Configuration > [Career Section] Administration > Career Sections > Career Section name > [Career Portal Pages] Show > My Job Cart > Edit User-defined Labels |
| 997363 | OngoingPosting | Ongoing | Configuration > [Career Section] Administration > Career Sections > Career Section name > [Career Portal Pages] Show > My Referrals > Edit User-defined Labels |
| 997363 | OngoingPosting | Ongoing | Configuration > [Career Section] Administration > Career Sections > Career Section name > [Career Portal Pages] Show > My Submissions > Edit User-defined Labels |
| 1023407 | JobPosting | Job Posting | Configuration > [Career Section] Administration > Career Sections > Career Section name > [Career Portal Pages] Show > Advanced Search > Edit User-defined Labels |
| 1023407 | JobPosting | Job Posting | Configuration > [Career Section] Administration > Career Sections > Career Section name > [Career Portal Pages] Show > Basic Search > Edit User-defined Labels |
| 1023407 | JobPosting | Job Posting | Configuration > [Career Section] Administration > Career Sections > Career Section name > [Career Portal Pages] Show > Basic Search > Edit User-defined Labels |
| 1023407 | JobPosting | Job Posting | Configuration > [Career Section] Administration > Career Sections > Career Section name > [Career Portal Pages] Show > Job Description > Edit User-defined Labels |
| 1023407 | JobPosting | Job Posting | Configuration > [Career Section] Administration > Career Sections > Career Section name > [Career Portal Pages] Show > Job List > Edit User-defined Labels |
| 1023407 | JobPosting | Job Posting | Configuration > [Career Section] Administration > Career Sections > Career Section name > [Career Portal Pages] Show > My Job Cart > Edit User-defined Labels |
| 1023407 | JobPosting | Job Posting | Configuration > [Career Section] Administration > Career Sections > Career Section name > [Career Portal Pages] Show > My Referrals > Edit User-defined Labels |

| ID | NAME | TALEO DEFAULT VALUE | LOCATION |
|---------|-------------------|---------------------|---|
| 1023407 | JobPosting | Job Posting | Configuration > [Career Section] Administration > Career Sections > Career Section name > [Career Portal Pages] Show > My Submissions > Edit User-defined Labels |
| 1038996 | CitizenshipStatus | Citizenship Status | Configuration > [Career Section] Administration > Career Sections > Career Section name > [Career Portal Pages] Show > Advanced Search > Edit User-defined Labels |
| 1038996 | CitizenshipStatus | Citizenship Status | Configuration > [Career Section] Administration > Career Sections > Career Section name > [Career Portal Pages] Show > Basic Search > Edit User-defined Labels |
| 1038996 | CitizenshipStatus | Citizenship Status | Configuration > [Career Section] Administration > Career Sections > Career Section name > [Career Portal Pages] Show > Basic Search > Edit User-defined Labels |
| 1038996 | CitizenshipStatus | Citizenship Status | Configuration > [Career Section] Administration > Career Sections > Career Section name > [Career Portal Pages] Show > Job Description > Edit User-defined Labels |
| 1038996 | CitizenshipStatus | Citizenship Status | Configuration > [Career Section] Administration > Career Sections > Career Section name > [Career Portal Pages] Show > Job List > Edit User-defined Labels |
| 1038996 | CitizenshipStatus | Citizenship Status | Configuration > [Career Section] Administration > Career Sections > Career Section name > [Career Portal Pages] Show > My Job Cart > Edit User-defined Labels |
| 1038996 | CitizenshipStatus | Citizenship Status | Configuration > [Career Section] Administration > Career Sections > Career Section name > [Career Portal Pages] Show > My Referrals > Edit User-defined Labels |
| 1038996 | CitizenshipStatus | Citizenship Status | Configuration > [Career Section] Administration > Career Sections > Career Section name > [Career Portal Pages] Show > My Submissions > Edit User-defined Labels |
| 1038999 | OvertimeStatus | Overtime Status | Configuration > [Career Section] Administration > Career Sections > Career Section name > [Career Portal Pages] Show > Advanced Search > Edit User-defined Labels |
| 1038999 | OvertimeStatus | Overtime Status | Configuration > [Career Section] Administration > Career Sections > Career Section name > [Career Portal Pages] Show > Basic Search > Edit User-defined Labels |
| 1038999 | OvertimeStatus | Overtime Status | Configuration > [Career Section] Administration > Career Sections > Career Section name > [Career Portal Pages] Show > Basic Search > Edit User-defined Labels |
| 1038999 | OvertimeStatus | Overtime Status | Configuration > [Career Section] Administration > Career Sections > Career Section name > [Career Portal Pages] Show > Job Description > Edit User-defined Labels |
| 1038999 | OvertimeStatus | Overtime Status | Configuration > [Career Section] Administration > Career Sections > Career Section name > [Career Portal Pages] Show > Job List > Edit User-defined Labels |
| 1038999 | OvertimeStatus | Overtime Status | Configuration > [Career Section] Administration > Career Sections > Career Section name > [Career Portal Pages] Show > My Job Cart > Edit User-defined Labels |

| ID | NAME | TALEO DEFAULT VALUE | LOCATION |
|---------|-------------------|-----------------------|---|
| 1038999 | OvertimeStatus | Overtime Status | Configuration > [Career Section] Administration > Career Sections > Career Section name > [Career Portal Pages] Show > My Referrals > Edit User-defined Labels |
| 1038999 | OvertimeStatus | Overtime Status | Configuration > [Career Section] Administration > Career Sections > Career Section name > [Career Portal Pages] Show > My Submissions > Edit User-defined Labels |
| 1040535 | TargetEndDate | Target End Date | Configuration > [Career Section] Administration > Career Sections > Career Section name > [Career Portal Pages] Show > Advanced Search > Edit User-defined Labels |
| 1040535 | TargetEndDate | Target End Date | Configuration > [Career Section] Administration > Career Sections > Career Section name > [Career Portal Pages] Show > Basic Search > Edit User-defined Labels |
| 1040535 | TargetEndDate | Target End Date | Configuration > [Career Section] Administration > Career Sections > Career Section name > [Career Portal Pages] Show > Basic Search > Edit User-defined Labels |
| 1040535 | TargetEndDate | Target End Date | Configuration > [Career Section] Administration > Career Sections > Career Section name > [Career Portal Pages] Show > Job Description > Edit User-defined Labels |
| 1040535 | TargetEndDate | Target End Date | Configuration > [Career Section] Administration > Career Sections > Career Section name > [Career Portal Pages] Show > Job List > Edit User-defined Labels |
| 1040535 | TargetEndDate | Target End Date | Configuration > [Career Section] Administration > Career Sections > Career Section name > [Career Portal Pages] Show > My Job Cart > Edit User-defined Labels |
| 1040535 | TargetEndDate | Target End Date | Configuration > [Career Section] Administration > Career Sections > Career Section name > [Career Portal Pages] Show > My Referrals > Edit User-defined Labels |
| 1040535 | TargetEndDate | Target End Date | Configuration > [Career Section] Administration > Career Sections > Career Section name > [Career Portal Pages] Show > My Submissions > Edit User-defined Labels |
| 1040564 | RequestedBillRate | Requested Hourly Rate | Configuration > [Career Section] Administration > Career Sections > Career Section name > [Career Portal Pages] Show > Advanced Search > Edit User-defined Labels |
| 1040564 | RequestedBillRate | Requested Hourly Rate | Configuration > [Career Section] Administration > Career Sections > Career Section name > [Career Portal Pages] Show > Basic Search > Edit User-defined Labels |
| 1040564 | RequestedBillRate | Requested Hourly Rate | Configuration > [Career Section] Administration > Career Sections > Career Section name > [Career Portal Pages] Show > Basic Search > Edit User-defined Labels |
| 1040564 | RequestedBillRate | Requested Hourly Rate | Configuration > [Career Section] Administration > Career Sections > Career Section name > [Career Portal Pages] Show > Job Description > Edit User-defined Labels |
| 1040564 | RequestedBillRate | Requested Hourly Rate | Configuration > [Career Section] Administration > Career Sections > Career Section name > [Career Portal Pages] Show > Job List > Edit User-defined Labels |

| ID | NAME | TALEO DEFAULT VALUE | LOCATION |
|---------|----------------------------|---|---|
| 1040564 | RequestedBillRate | Requested Hourly Rate | Configuration > [Career Section] Administration > Career Sections > Career Section name > [Career Portal Pages] Show > My Job Cart > Edit User-defined Labels |
| 1040564 | RequestedBillRate | Requested Hourly Rate | Configuration > [Career Section] Administration > Career Sections > Career Section name > [Career Portal Pages] Show > My Referrals > Edit User-defined Labels |
| 1040564 | RequestedBillRate | Requested Hourly Rate | Configuration > [Career Section] Administration > Career Sections > Career Section name > [Career Portal Pages] Show > My Submissions > Edit User-defined Labels |
| 1091745 | LastChanceEmailDescription | The field "{0}" and email address combination you entered does not correspond to a registered user. If you attempt to enter your "{0}" and email address again but fail, the system will lock this account. | Configuration > [Career Section] Administration > Career Sections > Career Section name > [Career Portal Pages] Show > Access Management |
| 1091749 | SubjectVariable | Subject: | Configuration > [Career Section] Administration > Career Sections > Career Section name > [Career Portal Pages] Show > My Submissions > Edit User-defined Labels |
| 1100419 | ReApplyAction | Re-apply | Configuration > [Career Section] Administration > Career Sections > Career Section name > [Career Portal Pages] Show > Basic Search > Edit User-defined Labels |
| 1100419 | ReApplyAction | Re-apply | Configuration > [Career Section] Administration > Career Sections > Career Section name > [Career Portal Pages] Show > Job Description > Edit User-defined Labels |
| 1100419 | ReApplyAction | Re-apply | Configuration > [Career Section] Administration > Career Sections > Career Section name > [Career Portal Pages] Show > Job List > Edit User-defined Labels |
| 1100419 | ReApplyAction | Re-apply | Configuration > [Career Section] Administration > Career Sections > Career Section name > [Career Portal Pages] Show > My Job Cart > Edit User-defined Labels |
| 1100419 | ReApplyAction | Re-apply | Configuration > [Career Section] Administration > Career Sections > Career Section name > [Career Portal Pages] Show > My Referrals > Edit User-defined Labels |
| 1100419 | ReApplyAction | Re-apply | Configuration > [Career Section] Administration > Career Sections > Career Section name > [Career Portal Pages] Show > My Submissions > Edit User-defined Labels |
| 1100422 | ReApplyActionTT | Re-apply for this job | Configuration > [Career Section] Administration > Career Sections > Career Section name > [Career Portal Pages] Show > Basic Search > Edit User-defined Labels |
| 1100422 | ReApplyActionTT | Re-apply for this job | Configuration > [Career Section] Administration > Career Sections > Career Section name > [Career Portal Pages] Show > Job Description > Edit User-defined Labels |
| 1100422 | ReApplyActionTT | Re-apply for this job | Configuration > [Career Section] Administration > Career Sections > Career Section name > [Career Portal Pages] Show > Job List > Edit User-defined Labels |

| ID | NAME | TALEO DEFAULT VALUE | LOCATION |
|---------|-----------------------------|---|---|
| 1100422 | ReApplyActionTT | Re-apply for this job | Configuration > [Career Section] Administration > Career Sections > Career Section name > [Career Portal Pages] Show > My Job Cart > Edit User-defined Labels |
| 1100422 | ReApplyActionTT | Re-apply for this job | Configuration > [Career Section] Administration > Career Sections > Career Section name > [Career Portal Pages] Show > My Referrals > Edit User-defined Labels |
| 1100422 | ReApplyActionTT | Re-apply for this job | Configuration > [Career Section] Administration > Career Sections > Career Section name > [Career Portal Pages] Show > My Submissions > Edit User-defined Labels |
| 1121174 | RSSIconTT | This criteria can be used for RSS feed creation: {0} | Configuration > [Career Section] Administration > Career Sections > Career Section name > [Career Portal Pages] Show > Basic Search > Edit User-defined Labels |
| 1121183 | RSSButtonTT | Create an RSS feed | Configuration > [Career Section] Administration > Career Sections > Career Section name > [Career Portal Pages] Show > Basic Search > Edit User-defined Labels |
| 1140123 | No | No | Configuration > [Career Section] Administration > Career Sections > Career Section name > [Career Portal Pages] Show > Job List > Edit User-defined Labels |
| 1140126 | Yes | Yes | Configuration > [Career Section] Administration > Career Sections > Career Section name > [Career Portal Pages] Show > Job List > Edit User-defined Labels |
| 1175467 | RSSButtonTT | Create an RSS feed | Configuration > [Career Section] Administration > Career Sections > Career Section name > [Career Portal Pages] Show > Advanced Search > Edit User-defined Labels |
| 1175470 | RSSIconTT | This criteria can be used for RSS feed creation: {0} | Configuration > [Career Section] Administration > Career Sections > Career Section name > [Career Portal Pages] Show > Advanced Search > Edit User-defined Labels |
| 1184182 | RSSTitle | {0} - Custom Job List | Configuration > [Career Section] Administration > Career Sections > Career Section name > [Career Portal Pages] Edit User-defined Labels |
| 1184192 | NoJobsFoundTitle | No Jobs Found | Configuration > [Career Section] Administration > Career Sections > Career Section name > [Career Portal Pages] Edit User-defined Labels |
| 1184201 | NoJobsFoundDescription | The system could not find jobs matching the criteria you have selected. Click the link above to return to the Career section. | Configuration > [Career Section] Administration > Career Sections > Career Section name > [Career Portal Pages] Edit User-defined Labels |
| 1184214 | TooManyJobsFoundDescription | The system found more than 10 jobs matching the criteria you have selected. Click the link above to return to the Career section and view the remaining jobs. | Configuration > [Career Section] Administration > Career Sections > Career Section name > [Career Portal Pages] Edit User-defined Labels |
| 1184221 | TooManyJobsFoundTitle | More Jobs Available on Career Section... | Configuration > [Career Section] Administration > Career Sections > Career Section name > [Career Portal Pages] Edit User-defined Labels |

| ID | NAME | TALEO DEFAULT VALUE | LOCATION |
|---------|----------------------------|---|---|
| 1197272 | FacebookButtonTT | Add this RSS feed to your Facebook account | Configuration > [Career Section] Administration > Career Sections > Career Section name > [Career Portal Pages] Show > Basic Search > Edit User-defined Labels |
| 1197287 | FacebookButtonTT | Add this RSS feed to your Facebook account | Configuration > [Career Section] Administration > Career Sections > Career Section name > [Career Portal Pages] Show > Advanced Search > Edit User-defined Labels |
| 1271284 | LastChanceEmailTitle | This is your last chance to enter your email address. | Configuration > [Career Section] Administration > Career Sections > Career Section name > [Career Portal Pages] Show > Access Management |
| 1271543 | BackToLoginAction | Back to login page | Configuration > [Career Section] Administration > Career Sections > Career Section name > [Career Portal Pages] Show > Access Management |
| 1271550 | BackToLoginActionTT | Return to the login page | Configuration > [Career Section] Administration > Career Sections > Career Section name > [Career Portal Pages] Show > Access Management |
| 1271557 | ForgotYourUserNameAction | Forgot your user name? | Configuration > [Career Section] Administration > Career Sections > Career Section name > [Career Portal Pages] Show > Access Management |
| 1271560 | ForgotYourUserNameActionTT | Access the forgotten user name instructions page | Configuration > [Career Section] Administration > Career Sections > Career Section name > [Career Portal Pages] Show > Access Management |
| 1271563 | UserNameAlreadyExists1 | A valid record already exists under this user name. | Configuration > [Career Section] Administration > Career Sections > Career Section name > [Career Portal Pages] Show > Access Management |
| 1271566 | UserNameAlreadyExists2 | If you have already used our system as a candidate or a referrer, please go back to the login page and sign in as a returning user. | Configuration > [Career Section] Administration > Career Sections > Career Section name > [Career Portal Pages] Show > Access Management |
| 1271569 | UserNameAlreadyExists3 | If you have already used our system as a candidate or a referrer, please go back to the login page and sign in as a returning user, or use the "Forgot your username?" feature. | Configuration > [Career Section] Administration > Career Sections > Career Section name > [Career Portal Pages] Show > Access Management |
| 1275272 | BackToLoginAction | Back to login page | Configuration > [Career Section] Administration > Career Sections > Career Section name > [Career Portal Pages] Show > Access Management |
| 1275275 | BackToLoginActionTT | Return to the login page | Configuration > [Career Section] Administration > Career Sections > Career Section name > [Career Portal Pages] Show > Access Management |
| 1280415 | SpecifyEmailAddress | Please enter your email address below. If you have never provided your email address, leave the field empty and click "Validate". | Configuration > [Career Section] Administration > Career Sections > Career Section name > [Career Portal Pages] Show > Access Management |

| ID | NAME | TALEO DEFAULT VALUE | LOCATION |
|---------|----------------------|---------------------------------|---|
| 1377820 | Loginname | User Name | Configuration > [Career Section] Administration > Career Sections > Career Section name > [Career Portal Pages] Show > Access Management |
| 1377827 | UserNameEmail | Email Address | Configuration > [Career Section] Administration > Career Sections > Career Section name > [Career Portal Pages] Show > Access Management |
| 1377830 | UserNameSSN | Social Security Number | Configuration > [Career Section] Administration > Career Sections > Career Section name > [Career Portal Pages] Show > Access Management |
| 1405721 | ApplyByEmailAction | Apply by Email | Configuration > [Career Section] Administration > Career Sections > Career Section name > [Career Portal Pages] Show > Basic Search > Edit User-defined Labels |
| 1405721 | ApplyByEmailAction | Apply by Email | Configuration > [Career Section] Administration > Career Sections > Career Section name > [Career Portal Pages] Show > Job Description > Edit User-defined Labels |
| 1405721 | ApplyByEmailAction | Apply by Email | Configuration > [Career Section] Administration > Career Sections > Career Section name > [Career Portal Pages] Show > Job List > Edit User-defined Labels |
| 1405721 | ApplyByEmailAction | Apply by Email | Configuration > [Career Section] Administration > Career Sections > Career Section name > [Career Portal Pages] Show > My Job Cart > Edit User-defined Labels |
| 1405721 | ApplyByEmailAction | Apply by Email | Configuration > [Career Section] Administration > Career Sections > Career Section name > [Career Portal Pages] Show > My Referrals > Edit User-defined Labels |
| 1405721 | ApplyByEmailAction | Apply by Email | Configuration > [Career Section] Administration > Career Sections > Career Section name > [Career Portal Pages] Show > My Submissions > Edit User-defined Labels |
| 1405730 | ApplyByEmailActionTT | Apply to this position by email | Configuration > [Career Section] Administration > Career Sections > Career Section name > [Career Portal Pages] Show > Basic Search > Edit User-defined Labels |
| 1405730 | ApplyByEmailActionTT | Apply to this position by email | Configuration > [Career Section] Administration > Career Sections > Career Section name > [Career Portal Pages] Show > Job Description > Edit User-defined Labels |
| 1405730 | ApplyByEmailActionTT | Apply to this position by email | Configuration > [Career Section] Administration > Career Sections > Career Section name > [Career Portal Pages] Show > Job List > Edit User-defined Labels |
| 1405730 | ApplyByEmailActionTT | Apply to this position by email | Configuration > [Career Section] Administration > Career Sections > Career Section name > [Career Portal Pages] Show > My Job Cart > Edit User-defined Labels |
| 1405730 | ApplyByEmailActionTT | Apply to this position by email | Configuration > [Career Section] Administration > Career Sections > Career Section name > [Career Portal Pages] Show > My Referrals > Edit User-defined Labels |
| 1405730 | ApplyByEmailActionTT | Apply to this position by email | Configuration > [Career Section] Administration > Career Sections > Career Section name > [Career Portal Pages] Show > My Submissions > Edit User-defined Labels |

| ID | NAME | TALEO DEFAULT VALUE | LOCATION |
|---------|---------------------------------|--|---|
| 1405739 | ApplyByEmailCommand | Apply by Email | Configuration > [Career Section] Administration > Career Sections > Career Section name > [Career Portal Pages] Show > Job Description > Edit User-defined Labels |
| 1405742 | ApplyByEmailCommandTT | Apply to this position by email | Configuration > [Career Section] Administration > Career Sections > Career Section name > [Career Portal Pages] Show > Job Description > Edit User-defined Labels |
| 1581215 | FTLHiddenFrameName | EmptyFrame | Configuration > [Career Section] Administration > Career Sections > Career Section name > [Career Portal Pages] Show > Basic Search > Edit User-defined Labels |
| 1581844 | FTLHiddenFrameTitle | Empty frame. Ignore. | Configuration > [Career Section] Administration > Career Sections > Career Section name > [Career Portal Pages] Show > Basic Search > Edit User-defined Labels |
| 1595973 | JobDescriptionPageTitleNoVari | Job Description | Configuration > [Career Section] Administration > Career Sections > Career Section name > [Career Portal Pages] Show > Job Description > Edit User-defined Labels |
| 1758311 | ShowCriteriaCommand | Show Criteria | Configuration > [Career Section] Administration > Career Sections > Career Section name > [Career Portal Pages] Show > Basic Search > Edit User-defined Labels |
| 1758327 | ShowCriteriaCommandTT | Show the search criteria | Configuration > [Career Section] Administration > Career Sections > Career Section name > [Career Portal Pages] Show > Basic Search > Edit User-defined Labels |
| 1758894 | LoginNameFormatInvalid | The username is missing or invalid. It must contain between {1} and {2} characters and must not contain any spaces or special characters (e.g.: \$,&,#,?, etc.). | Configuration > [Career Section] Administration > Career Sections > Career Section name > [Career Portal Pages] Show > Access Management |
| 1759191 | FinishJobSpecificReferralAction | Finish Job-specific Referral | Configuration > [Career Section] Administration > Career Sections > Career Section name > [Career Portal Pages] Show > My Referrals > Edit User-defined Labels |
| 1759200 | FinishJobSpecificReferralVariab | Finish this draft job-specific referral ({JOB_TITLE}) | Configuration > [Career Section] Administration > Career Sections > Career Section name > [Career Portal Pages] Show > My Referrals > Edit User-defined Labels |
| 1759209 | FinishProfileAction | Finish Profile | Configuration > [Career Section] Administration > Career Sections > Career Section name > [Career Portal Pages] Show > My Referrals > Edit User-defined Labels |
| 1759218 | FinishProfileActionTT | Finish this draft general profile referral | Configuration > [Career Section] Administration > Career Sections > Career Section name > [Career Portal Pages] Show > My Referrals > Edit User-defined Labels |
| 1759227 | ViewEditJobSpecificReferralActi | View/Edit Job-specific Referral | Configuration > [Career Section] Administration > Career Sections > Career Section name > [Career Portal Pages] Show > My Referrals > Edit User-defined Labels |
| 1759236 | ViewEditJobSpecificReferralVari | View/edit this job-specific referral ({JOB_TITLE}) | Configuration > [Career Section] Administration > Career Sections > Career Section name > [Career Portal Pages] Show > My Referrals > Edit User-defined Labels |
| 1759248 | ViewEditProfileAction | View/Edit Profile | Configuration > [Career Section] Administration > Career Sections > Career Section name > [Career Portal Pages] Show > My Referrals > Edit User-defined Labels |

| ID | NAME | TALEO DEFAULT VALUE | LOCATION |
|---------|-----------------------------|---|---|
| 1759257 | ViewEditProfileActionTT | View/edit this general profile referral | Configuration > [Career Section] Administration > Career Sections > Career Section name > [Career Portal Pages] Show > My Referrals > Edit User-defined Labels |
| 1767654 | YouMightLooseYourWork | If you do so, you might lose your work. | Configuration > [Career Section] Administration > Career Sections > Career Section name > [Career Portal Pages] Edit User-defined Labels |
| 1783251 | InvalidPasswordReveiveEmail | The password you have entered is invalid. Please click the link "{0}" to have your password emailed to you. | Configuration > [Career Section] Administration > Career Sections > Career Section name > [Career Portal Pages] Show > Access Management |
| 1833831 | RelocationAmount | Relocation Amount | Configuration > [Career Section] Administration > Career Sections > Career Section name > [Career Portal Pages] Show > Advanced Search > Edit User-defined Labels |
| 1833831 | RelocationAmount | Relocation Amount | Configuration > [Career Section] Administration > Career Sections > Career Section name > [Career Portal Pages] Show > Basic Search > Edit User-defined Labels |
| 1833831 | RelocationAmount | Relocation Amount | Configuration > [Career Section] Administration > Career Sections > Career Section name > [Career Portal Pages] Show > Basic Search > Edit User-defined Labels |
| 1833831 | RelocationAmount | Relocation Amount | Configuration > [Career Section] Administration > Career Sections > Career Section name > [Career Portal Pages] Show > Job Description > Edit User-defined Labels |
| 1833831 | RelocationAmount | Relocation Amount | Configuration > [Career Section] Administration > Career Sections > Career Section name > [Career Portal Pages] Show > Job List > Edit User-defined Labels |
| 1833831 | RelocationAmount | Relocation Amount | Configuration > [Career Section] Administration > Career Sections > Career Section name > [Career Portal Pages] Show > My Job Cart > Edit User-defined Labels |
| 1833831 | RelocationAmount | Relocation Amount | Configuration > [Career Section] Administration > Career Sections > Career Section name > [Career Portal Pages] Show > My Referrals > Edit User-defined Labels |
| 1833831 | RelocationAmount | Relocation Amount | Configuration > [Career Section] Administration > Career Sections > Career Section name > [Career Portal Pages] Show > My Submissions > Edit User-defined Labels |
| 1858378 | RelocationType | Relocation Package | Configuration > [Career Section] Administration > Career Sections > Career Section name > [Career Portal Pages] Show > Advanced Search > Edit User-defined Labels |
| 1858378 | RelocationType | Relocation Package | Configuration > [Career Section] Administration > Career Sections > Career Section name > [Career Portal Pages] Show > Basic Search > Edit User-defined Labels |
| 1858378 | RelocationType | Relocation Package | Configuration > [Career Section] Administration > Career Sections > Career Section name > [Career Portal Pages] Show > Basic Search > Edit User-defined Labels |
| 1858378 | RelocationType | Relocation Package | Configuration > [Career Section] Administration > Career Sections > Career Section name > [Career Portal Pages] Show > Job Description > Edit User-defined Labels |

| ID | NAME | TALEO DEFAULT VALUE | LOCATION |
|---------|---------------------------------------|--|--|
| 1858378 | RelocationType | Relocation Package | Configuration > [Career Section] Administration > Career Sections > Career Section name > [Career Portal Pages] Show > Job List > Edit User-defined Labels |
| 1858378 | RelocationType | Relocation Package | Configuration > [Career Section] Administration > Career Sections > Career Section name > [Career Portal Pages] Show > My Job Cart > Edit User-defined Labels |
| 1858378 | RelocationType | Relocation Package | Configuration > [Career Section] Administration > Career Sections > Career Section name > [Career Portal Pages] Show > My Referrals > Edit User-defined Labels |
| 1858378 | RelocationType | Relocation Package | Configuration > [Career Section] Administration > Career Sections > Career Section name > [Career Portal Pages] Show > My Submissions > Edit User-defined Labels |
| 1867751 | CannotCreateRSSFeedTitle | Unable to Create an RSS Feed | Configuration > [Career Section] Administration > Career Sections > Career Section name > [Career Portal Pages] Edit User-defined Labels |
| 1867762 | CannotCreateRSSFeedDescription | The system could not create an RSS feed. Click the link above to return to the Career Section. | Configuration > [Career Section] Administration > Career Sections > Career Section name > [Career Portal Pages] Edit User-defined Labels |
| 1868158 | OldPasswordInvalidAccountWillBeLocked | The old password is either missing or invalid. If you attempt to enter it again but fail to provide the valid information, the system will lock your account. | Configuration > [Career Section] Administration > Career Sections > Career Section name > [Career Portal Pages] Show > Access Management |
| 1874551 | UserNameFormatMissingOrInvalid | The username is missing or invalid. It must contain between {1} and {2} characters and must not contain any spaces or special characters (e.g.: \$,&,#.?, etc.). | Configuration > [Career Section] Administration > Career Sections > Career Section name > [Career Portal Pages] Show > Access Management |
| 1881051 | Description4 | You must be logged and have an email address to send jobs to friends. | Configuration > [Career Section] Administration > Career Sections > Career Section name > [Career Portal Pages] Show > Job Description > Edit User-defined Labels |
| 2323801 | DateReceived | Received | Configuration > [Career Section] Administration > Career Sections > Career Section name > [Career Portal Pages] Edit User-defined Labels > MyMessagesPageResources |
| 2323786 | From | From | Configuration > [Career Section] Administration > Career Sections > Career Section name > [Career Portal Pages] Edit User-defined Labels > MyMessagesPageResources |
| 2323771 | Subject | Subject | Configuration > [Career Section] Administration > Career Sections > Career Section name > [Career Portal Pages] Edit User-defined Labels > MyMessagesPageResources |
| 2323727 | NoMessagesToDisplay | There are no messages to display. | Configuration > [Career Section] Administration > Career Sections > Career Section name > [Career Portal Pages] Edit User-defined Labels > MyMessagesPageResources |
| 2323724 | MessageListTitle | Messages | Configuration > [Career Section] Administration > Career Sections > Career Section name > [Career Portal Pages] Edit User-defined Labels > MyMessagesPageResources |

| ID | NAME | TALEO DEFAULT VALUE | LOCATION |
|---------|-------------------------------|---|---|
| 2323721 | MessageListDescription | This list includes the most recent messages sent to you by the system or another user. | Configuration > [Career Section] Administration > Career Sections > Career Section name > [Career Portal Pages] Edit User-defined Labels > MyMessagesPageResources |
| 2323111 | BlockDescriptionProfile | You can submit personal and professional information by uploading a profile. The system will automatically extract the relevant information included in the profile and fill out part of the online submission. You can review the extracted information and make the appropriate changes in the next steps. | Configuration > [Career Section] Administration > Application Flows > Application Flow (Job-specific Application or Candidate Profile type) > Resume Upload > ResumeUploadResources |
| 2323114 | BlockDescriptionProfileResume | You can submit personal and professional information by importing a resume or by importing a profile from a third-party service. The system will automatically extract the relevant information from the profile or the resume and fill out part of the online submission. You can review the extracted information and make the appropriate changes in the next steps. | Configuration > [Career Section] Administration > Application Flows > Application Flow (Job-specific Application or Candidate Profile type) > Resume Upload > ResumeUploadResources |
| 2323117 | BlockTitleProfileUpload | Profile Upload | Configuration > [Career Section] Administration > Application Flows > Application Flow (Job-specific Application or Candidate Profile type) > Resume Upload > ResumeUploadResources |
| 2323123 | NoThanksIWillFillOutManually | No thanks, I will fill out the online submission manually | Configuration > [Career Section] Administration > Application Flows > Application Flow (Job-specific Application or Candidate Profile type) > Resume Upload > ResumeUploadResources |
| 2323126 | OrUploadResume | Or upload a resume | Configuration > [Career Section] Administration > Application Flows > Application Flow (Job-specific Application or Candidate Profile type) > Resume Upload > ResumeUploadResources |
| 2323129 | ResumeUploadDescription2Prof | If you do not upload a profile, you will need to fill out the online submission manually. | Configuration > [Career Section] Administration > Application Flows > Application Flow (Job-specific Application or Candidate Profile type) > Resume Upload > ResumeUploadResources |
| 2323132 | ResumeUploadDescription2Prof | If you do not upload a profile or a resume, you will need to fill out the online submission manually. | Configuration > [Career Section] Administration > Application Flows > Application Flow (Job-specific Application or Candidate Profile type) > Resume Upload > ResumeUploadResources |
| 2323138 | UploadDatafrom | Upload data from | Configuration > [Career Section] Administration > Application Flows > Application Flow (Job-specific Application or Candidate Profile type) > Resume Upload > ResumeUploadResources |
| 2323154 | Description4 | To upload a profile through a third-party service, select the radio button next to the relevant service icon. The system imports the data included in the third-party | Configuration > [Career Section] Administration > Application Flows > Application Flow (Job-specific Application or Candidate Profile type) > Resume Upload > ResumeUploadResources |

| ID | NAME | TALEO DEFAULT VALUE | LOCATION |
|---------|--------|---|---|
| | | profile. Once the process is complete, you must review the imported data. | |
| 2323161 | Title4 | Uploading a profile | Configuration > [Career Section] Administration > Application Flows > Application Flow (Job-specific Application or Candidate Profile type) > Resume Upload > ResumeUploadResources |

Original Submission Medium and Latest Submission Medium

Recruiting Center users can see which medium was used to submit information about a candidate initially and which medium was used most recently.

Submissions for a job can be entered into the system in a number of ways: candidates can apply through a "standard" or mobile career section; candidate submissions can also be submitted by way of an agency, a referral, or a match performed in the Recruiting Center. The candidates are later invited to visit the career section to complete the application workflow.

The Recruiting Center displays in the Profile section of the candidate file, two fields for medium. The first one indicates the medium used when the candidate submission was submitted the first time; the second field indicates the medium used for the most recent submission. The Original Submission Medium is read-only. The Latest Submission Medium field is updated automatically when a submission is updated using a medium that is different from the one last used. Recruiting Center users can manually indicate the most recent medium used by making a selection from the corresponding list. The list contains the following choices: Agency, Email, External Import, Fax, Import, Internet Mining, Matched to Job, Online, Online Mobile, Phone, Referral, Resume, Staffing Station, Talent Exchange.

The list of values in both the Original Submission Medium and Latest Submission Medium include the following changes:

- External Import: A new value created to support future functionality for creating submissions from candidate information imported from external systems.
- Online Mobile: A new value associated with candidates who use a mobile career section.
- Referral: A new value associated with candidates created through an employee referral.
- Resume: The "Paper Resume" value, a term used prior to 14B, was renamed "Resume".
- Staffing Station: Though unavailable for selection in the Create Candidate process because the Staffing Station is no longer offered, "Staffing Station" is still available for selection in the candidate file in edit mode. If the submission medium of a candidate was "Staffing Station" before migration, this value is retained for that candidate.
- Talent Exchange: Though unavailable for selection in the Create Candidate process because the Talent Exchange no longer exists, "Talent Exchange" is still available for selection in the candidate file in edit mode. If the submission medium of a candidate was "Talent Exchange" before migration, this value is retained for that candidate.

Recruiting administrators can configure Candidate Selection Workflow (CSW) auto-progression rules such that when the original or latest submission medium takes on a specific value, the submission advances automatically to a different

step and/or status. This is best explained by an example. Suppose an organization wanted Recruiting Center users to consider candidates for a phone screening interview only after the candidates had submitted a fully completed submission that included an e-Signature. Original submissions that typically contain rudimentary information could originate, for example, from matches performed by Recruiting Center users, from the recommendations of friends, or from candidates who applied through mobile career sections. The Original Submission Medium value would be Matched to Job, Referral and Online Mobile respectively. In all of these cases, the candidates would receive an email message requesting them to visit the organization's "standard" career section and complete their submission. When the candidates provided a complete submission including an e-Signature, the value of the Latest Submission Medium would be changed automatically to Online. Suppose that the organization had configured a CSW such that candidates whose submission medium was Online were advanced automatically to the Phone screen step and Under consideration status. This would ensure that the candidates at the phone screening step in the CSW had submitted complete submissions. See the "Configuration" subsection later in this section.

Recruiting Center users can configure list formats to include the Original Submission Medium and Latest Submission Medium in candidate lists.

Configuration

While the system determines the value of the Original Submission Medium field for each submission, both the system and Recruiting Center users can set the value of the Latest Submission Medium.

| Field Name | Location |
|----------------------------|--|
| Original Submission Medium | Recruiting Center > Candidates > (click candidate name) > Job Submission tab > Profile |
| Latest Submission Medium | Recruiting Center > Candidates > (click candidate name) > Job Submission tab > Profile |

As mentioned earlier, Recruiting administrators can configure Career Section Workflows such that candidates can be advanced automatically to a new step and/or status based on the value of the original submission medium or the latest one. Note the three new options: Online Mobile, Referral and External Import.