

# Oracle® Database Appliance

## X5-2/X4-2 Deployment and User's Guide



Release 18.7 for Linux x86-64

F20948-01

September 2019

The Oracle logo, consisting of a solid red square with the word "ORACLE" in white, uppercase, sans-serif font centered within it.

ORACLE®

Copyright © 2018, 2019, Oracle and/or its affiliates. All rights reserved.

Primary Author: Aparna Kamath

This software and related documentation are provided under a license agreement containing restrictions on use and disclosure and are protected by intellectual property laws. Except as expressly permitted in your license agreement or allowed by law, you may not use, copy, reproduce, translate, broadcast, modify, license, transmit, distribute, exhibit, perform, publish, or display any part, in any form, or by any means. Reverse engineering, disassembly, or decompilation of this software, unless required by law for interoperability, is prohibited.

The information contained herein is subject to change without notice and is not warranted to be error-free. If you find any errors, please report them to us in writing.

If this is software or related documentation that is delivered to the U.S. Government or anyone licensing it on behalf of the U.S. Government, then the following notice is applicable:

U.S. GOVERNMENT END USERS: Oracle programs, including any operating system, integrated software, any programs installed on the hardware, and/or documentation, delivered to U.S. Government end users are "commercial computer software" pursuant to the applicable Federal Acquisition Regulation and agency-specific supplemental regulations. As such, use, duplication, disclosure, modification, and adaptation of the programs, including any operating system, integrated software, any programs installed on the hardware, and/or documentation, shall be subject to license terms and license restrictions applicable to the programs. No other rights are granted to the U.S. Government.

This software or hardware is developed for general use in a variety of information management applications. It is not developed or intended for use in any inherently dangerous applications, including applications that may create a risk of personal injury. If you use this software or hardware in dangerous applications, then you shall be responsible to take all appropriate fail-safe, backup, redundancy, and other measures to ensure its safe use. Oracle Corporation and its affiliates disclaim any liability for any damages caused by use of this software or hardware in dangerous applications.

Oracle and Java are registered trademarks of Oracle and/or its affiliates. Other names may be trademarks of their respective owners.

Intel and Intel Xeon are trademarks or registered trademarks of Intel Corporation. All SPARC trademarks are used under license and are trademarks or registered trademarks of SPARC International, Inc. AMD, Opteron, the AMD logo, and the AMD Opteron logo are trademarks or registered trademarks of Advanced Micro Devices. UNIX is a registered trademark of The Open Group.

This software or hardware and documentation may provide access to or information about content, products, and services from third parties. Oracle Corporation and its affiliates are not responsible for and expressly disclaim all warranties of any kind with respect to third-party content, products, and services unless otherwise set forth in an applicable agreement between you and Oracle. Oracle Corporation and its affiliates will not be responsible for any loss, costs, or damages incurred due to your access to or use of third-party content, products, or services, except as set forth in an applicable agreement between you and Oracle.

# Contents

## Preface

---

Audience	xvii
Documentation Accessibility	xvii
Related Documents	xviii
Conventions	xviii

## 1 Introduction to Oracle Database Appliance

---

About Oracle Database Appliance	1-1
Oracle Database Appliance Software Terminology	1-3
About the Web Console	1-5

## 2 Preparing for Oracle Database Appliance Installation and Deployment

---

Registering Your Support Identifier on My Oracle Support	2-1
Planning Oracle Database Appliance Configuration Options	2-1
Selecting Database Deployment Options for Oracle Database Appliance	2-2
Selecting Database Shapes for Oracle Database Appliance	2-3
Calculating Required Cores	2-4
Selecting Operating System Groups and Users	2-4
Gathering System Requirement Information	2-6
List of Information You Need Before Deployment	2-7
Checklist for System Details	2-10
Checklist for Custom Network Address Configuration	2-11

## 3 Readyng Oracle Database Appliance for Deployment

---

About Interconnect Cabling	3-1
Attaching Supplied Cables for Oracle Database Appliance	3-2
Attaching Cables for Oracle Database Appliance X5-2	3-2
Attaching Cables for Oracle Database Appliance Models X4-2	3-3

Cabling Oracle Database Appliance to Connect to Fiber Public Networks (Optional)	3-5
Attaching a Storage Expansion Shelf to Oracle Database Appliance	3-6
About Attaching and Cabling Storage Shelves	3-7
Installing and Cabling a Storage Expansion Shelf	3-7
Attaching Peripheral Devices	3-10
Attaching Power Cords and Initializing Components	3-11
Powering On Oracle Database Appliance the First Time	3-11
Defining Your Public Network Interface Type	3-13
Configuring Oracle Integrated Lights Out Manager	3-14

## 4 Provisioning Oracle Database Appliance Baremetal System

---

Plumbing the Network	4-1
Verifying Cabling and Network Connections	4-4
Downloading Oracle Database Appliance Software	4-6
Installing Oracle Database Appliance Software	4-7
Creating the Appliance	4-7

## 6 Oracle Database Appliance Postinstallation Tasks

---

Configuring CPU Core Count	6-1
Securing Oracle ILOM Service Processors	6-1
Changing Oracle Database Appliance Passwords	6-2

## 8 Re-imaging Oracle Database Appliance

---

Cleaning Up Incomplete or Failed Installations	8-1
Restoring an Oracle Database Appliance Baremetal System	8-3
Performing Secure Erase of Data on Storage Disks	8-5

## 9 Managing Oracle Databases

---

About Administrative Groups and Users on Oracle Database Appliance	9-1
About Data Migration Options for Oracle Database Appliance	9-2
Working with Databases	9-3
Viewing Databases	9-4
Creating a Database	9-4
Creating a Database Instance	9-7
Cloning a Database from Backup	9-8
Cloning an Oracle ACFS Database Using the Web Console	9-9
Cloning an Oracle ACFS Database Using Command Line Interface	9-10

Upgrading a Database	9-11
Deleting a Database	9-11
Working with Database Homes	9-11
About Managing Multiple Oracle Homes on Oracle Database Appliance	9-12
Viewing Database Homes	9-13
Creating a Database Home	9-13
Deleting a Database Home	9-13
Migrating Databases	9-14
About Migrating Databases	9-14
Configuring a Static Listener	9-15
Migrating a Database	9-16
Registering a Database	9-17
About Managing Multiple Database Instances Using Instance Caging	9-19
Oracle EM Express and DB Console	9-20

## 10 Managing Storage

---

About Managing Storage	10-1
Preparing for Storage Expansion	10-2

## 11 Backup, Restore and Recover Databases

---

About Database Backup and Recovery Options	11-1
Creating a Mount Point for NFS Backup Location	11-8
Configuring Agent Proxy Settings for Object Store Access	11-9
Creating a Database Backup Policy	11-11
Updating a Database with a Backup Policy	11-12
Updating a Database Backup Policy	11-12
Backing Up a Database Using the Web Console	11-13
Viewing Backup Reports	11-13
Recovering a Database Using the Web Console	11-13
Deleting a Backup Using the Web Console	11-14
Deleting a Backup Policy	11-14
Using the CLI to Backup, Restore, and Recover	11-14
Preparing for Database Backup to Disk	11-15
Preparing for Database Backup to NFS Location	11-16
Preparing for Database Backup to Oracle Cloud	11-17
Backing Up a Database with the CLI	11-18
Recovering a Database with the CLI	11-19
Restoring a Database with the CLI	11-21

## 12 Managing an Oracle Database Appliance Virtualized Platform

---

About Oracle Database Appliance Virtualized Platform	12-2
Oracle Database Appliance Virtualized Platform Architecture	12-3
About Oracle Database Appliance Virtualized Platform Architecture	12-3
About Virtual Machines and Oracle Database Appliance Virtualized Platforms	12-4
About Network Infrastructure and VLANs on Oracle Database Appliance Virtualized Platform	12-7
Configuring Additional Networks on Virtualized Platform	12-9
How to Create and Manage Shared Repositories	12-10
Creating a Shared Repository	12-10
Showing the Status of Shared Repositories	12-11
Starting a Shared Repository	12-11
Stopping a Shared Repository	12-12
Deleting a Shared Repository	12-12
Increasing the Size of a Shared Repository	12-13
How to Manage Virtual Disks in Shared Repositories	12-13
Creating a Virtual Disk for Use in a Shared Repository	12-13
Viewing Information About Virtual Disks	12-14
Cloning Virtual Disks	12-14
Attaching a Virtual Disk to a Virtual Machine	12-15
Deleting a Virtual Disk	12-15
How to Manage Virtual Machine Templates	12-16
About Managing Virtual Machine Templates	12-16
Listing Virtual Machine Templates	12-17
Importing Virtual Machine Templates	12-18
Configuring a Virtual Machine Template	12-19
Showing Configured Values for a Virtual Machine Template	12-20
Modifying a Virtual Machine Template Configuration	12-20
Removing a Virtual Machine Template	12-21
How to Create Clones and Snap Clones of a Template	12-21
About Creating Clones and Snap Clones of a Template	12-21
Cloning a Template With OAKCLI	12-22
Creating a Snap Clone from a Template With OAKCLI	12-23
Creating a Snap Clone of an Existing Virtual Machine With OAKCLI	12-23
How to Manage Virtual Machines on Oracle Database Appliance Virtualized Platform	12-23
About Managing Virtual Machines on Oracle Database Appliance Virtualized Platform	12-24
Listing the Virtual Machines in Your Repositories	12-25

Creating a Virtual Machine	12-26
Configuring a Virtual Machine	12-27
Starting and Stopping a Virtual Machine	12-28
Externally Configuring a Virtual Machine	12-28
Opening a Virtual Machine Console for a Virtual Machine	12-29
Creating an Image for a New Virtual Machine	12-29
Setting Up a Virtual Machine for Access from eth0 Using an IP Address	12-29
Adding or Removing a Virtual Disk to or from a Virtual Machine	12-30
Removing a Virtual Machine from a Shared Repository	12-30
Performing a Live Migration for an Oracle Database Appliance Virtual Machine	12-30
How to Create Driver Domain Virtual Machines	12-31
About Driver Domain Virtual Machines	12-31
Creating a Driver Domain Virtual Machine from a Template	12-32
Converting a Virtual Machine to a Driver Domain Virtual Machine	12-33
Converting a Root Disk to a Driver Domain Disk	12-34
How to Manage High Availability on Oracle Database Appliance Virtualized Platform	12-43
How to Manage CPU Pools on Oracle Database Appliance Virtualized Platform	12-43
About Managing CPU Pools for Resource Allocation	12-44
About Over-Subscribed CPU Pools	12-45
Creating a New CPU Pool on Oracle Database Appliance Virtualized Platform Nodes	12-45
Showing the CPU Pools Configured on Oracle Database Appliance Virtualized Platform Nodes	12-46
Changing the Number of CPUs Assigned to a CPU Pool on Oracle Database Appliance Virtualized Platform Nodes	12-46
Assigning a Virtual Machine to a CPU Pool on Oracle Database Appliance Virtualized Platform	12-46

## 13 Oracle Database Appliance Command-Line Interface

---

About Oracle Database Appliance Command-Line Interface	13-2
Managing ODACLI Privileges and Security with SUDO	13-4
odacli Network Commands	13-7
odacli configure-firstnet	13-8
odacli list-networks	13-9
odacli describe-network	13-10
odacli create-network	13-11
odacli configure-network	13-12
odacli update-network	13-13
odacli delete-network	13-14
odacli describe-networkinterface	13-15
odacli list-networkinterfaces	13-16

odacli Apply Patch and Update Commands	13-17
odacli describe-component	13-19
odacli describe-latestpatch	13-23
odacli create-prepatchreport	13-25
odacli describe-prepatchreport	13-26
odacli list-prepatchreports	13-29
odacli cleanup-patchrepo	13-30
odacli list-availablepatches	13-31
odacli delete-prepatchreport	13-32
odacli list-agentconfig-parameters	13-32
odacli update-agentconfig-parameters	13-34
odacli update-dbhome	13-35
odacli update-dcsadmin	13-36
odacli update-dcscomponents	13-37
odacli update-dcsagent	13-37
odacli update-registry	13-38
odacli update-repository	13-40
odacli update-server	13-41
odaadmcli orachk	13-43
odacli update-storage	13-43
odacli Appliance Commands	13-44
odacli create-appliance	13-45
odacli describe-appliance	13-45
odacli describe-system	13-46
odacli list-featuretracking	13-49
odacli-adm set-credential	13-52
odacli Backup and Recovery Commands	13-52
odacli create-backup	13-54
odacli create-backupconfig	13-55
odacli create-objectstoreswift	13-56
odacli delete-backup	13-57
odacli delete-backupconfig	13-58
odacli delete-objectstoreswift	13-59
odacli describe-backupreport	13-59
odacli describe-schedule	13-61
odacli irestore-database	13-61
odacli list-backupreports	13-63
odacli list-backupconfigs	13-64
odacli list-objectstoreswifts	13-64
odacli list-schedules	13-65
odacli recover-database	13-65



odacli update-backupconfig	13-67
odacli update-database	13-68
odacli update-objectstoreswift	13-69
odacli update-schedule	13-70
odacli CPU Core Commands	13-71
odacli list-cpucores	13-71
odacli describe-cpucore	13-72
update-cpucore	13-72
odacli Database Commands	13-73
odacli list-databases	13-74
odacli describe-database	13-74
odacli create-database	13-75
odacli clone-database	13-79
odacli modify-database	13-80
odacli register-database	13-82
odacli upgrade-database	13-84
odacli delete-database	13-86
odacli DBHome Commands	13-87
odacli list-dbhomes	13-88
odacli describe-dbhome	13-89
odacli create-dbhome	13-89
odacli delete-dbhome	13-90
odacli Database Storage Commands	13-91
odacli list-dbstorages	13-92
odacli describe-dbstorage	13-92
odacli create-dbstorage	13-94
odacli delete-dbstorage	13-95
odacli describe-dgstorage	13-96
odacli list-dgstorages	13-98
odacli Job Commands	13-99
odacli list-jobs	13-99
odacli describe-job	13-103
odacli list-scheduled-executions	13-103
Log Commands	13-105
odaadmcli manage diagcollect	13-105
odacli list-logspaceusage	13-107
odacli create-logcleanjob	13-108
odacli list-logcleanjobs	13-109
odacli describe-logcleanjob	13-110
odacli create-auto-logclean-policy	13-111
odacli list-auto-logclean-policy	13-112

odacli Oracle Auto Service Request Commands	13-113
odacli configure-asr	13-113
odacli update-asr	13-115
odacli describe-asr	13-116
odacli test-asr	13-117
odacli delete-asr	13-118
odacli OS Commands	13-118
odacli list-osconfigurations	13-119
odacli update-osconfigurations	13-119
odaadmcli Hardware Monitoring Commands	13-121
odaadmcli show cooling	13-121
odaadmcli show env_hw	13-122
odaadmcli show fs	13-122
odaadmcli show memory	13-123
odaadmcli show network	13-124
odaadmcli show power	13-125
odaadmcli show processor	13-125
odaadmcli show server	13-126
Storage Commands	13-127
odaadmcli expand storage	13-127
odaadmcli show disk	13-128
odaadmcli show diskgroup	13-130
odaadmcli show controller	13-131
odaadmcli show raidsyncstatus	13-132
odaadmcli show storage	13-132
odaadmcli stordiag	13-133
odaadmcli power disk	13-134
odacli validate-storagetopology	13-135

## 14 Oracle Appliance Manager Command-Line Interface for Virtualization

---

About the Oracle Appliance Manager Command-line Interface (OAKCLI)	14-3
Managing OAKCLI Privileges and Security with SUDO	14-5
oakcli add disk -local	14-7
oakcli configure commands	14-7
oakcli configure additionalnet	14-8
oakcli configure asr	14-9
oakcli configure cpupool	14-10
oakcli configure firstnet	14-10
oakcli configure network	14-11

oakcli configure oda_base	14-11
oakcli configure repo	14-13
oakcli copy	14-13
oakcli create commands	14-14
oakcli create cpupool	14-14
oakcli create database	14-15
oakcli create dbhome	14-17
oakcli create dbstorage	14-18
oakcli create db_config_params	14-19
oakcli create repo	14-20
oakcli create snapshotdb	14-21
oakcli delete commands	14-21
oakcli delete cpupool	14-22
oakcli delete database	14-22
oakcli delete db_config_params	14-23
oakcli delete dbhome	14-23
oakcli delete dbstorage	14-24
oakcli delete repo	14-24
oakcli deploy	14-25
oakcli expand storage	14-26
oakcli diskwritecache	14-27
oakcli locate disk	14-27
oakcli manage diagcollect	14-28
oakcli describe-system	14-29
oakcli modify database	14-30
oakcli orachk	14-31
oakcli reconfigure osparams	14-32
oakcli resize dbstorage	14-33
oakcli restart oda_base	14-34
oakcli show commands	14-34
oakcli show asr	14-37
oakcli show cooling	14-37
oakcli show controller	14-38
oakcli show cpupool	14-38
oakcli show databases	14-39
oakcli show db_config_params	14-39
oakcli show dbhomes	14-40
oakcli show dbstorage	14-41
oakcli show disk	14-42
oakcli show diskgroup	14-43
oakcli show enclosure	14-43

oakcli show env_hw	14-43
oakcli show expander	14-44
oakcli show ismaster	14-44
oakcli show fs	14-45
oakcli show memory	14-45
oakcli show network	14-45
oakcli show power	14-45
oakcli show processor	14-46
oakcli show raidsyncstatus	14-47
oakcli show repo	14-47
oakcli show server	14-48
oakcli show storage	14-48
oakcli show validation storage	14-49
oakcli show validation storage errors	14-49
oakcli show validation storage failures	14-49
oakcli show version	14-50
oakcli start commands	14-51
oakcli start oda_base	14-51
oakcli start repo	14-52
oakcli stop command	14-52
oakcli storddiag	14-53
oakcli test asr	14-54
oakcli unpack	14-55
oakcli update	14-55
oakcli update-cpucore	14-57
oakcli upgrade	14-59
oakcli validate	14-60
oakcli Virtual Disk Commands	14-63
oakcli create vdisk	14-63
oakcli clone vdisk	14-64
oakcli delete vdisk	14-64
oakcli show vdisk	14-65
oakcli Virtual Machine Commands	14-66
oakcli clone vm	14-66
oakcli configure vm	14-68
oakcli delete vm	14-71
oakcli migrate vm	14-71
oakcli modify vm	14-71
oakcli show vm	14-72
oakcli show vmconsole	14-74
oakcli start vm	14-74

oakcli Virtual Machine Template Commands	14-75
oakcli configure vmtemplate	14-75
oakcli delete vmtemplate	14-77
oakcli import vmtemplate	14-78
oakcli modify vmtemplate	14-80
oakcli show vmtemplate	14-80
oakcli VLAN Management Commands for Virtual Platform	14-81
oakcli create vlan	14-81
oakcli delete vlan	14-82
oakcli show vlan	14-83

## 15 Troubleshooting Oracle Database Appliance

---

Viewing Component Information on the Appliance	15-2
Errors When Logging into the Web Console	15-5
Errors when re-imaging Oracle Database Appliance	15-5
Using the Oracle ORAchk Health Check Tool	15-6
About Oracle Trace File Analyzer Collector	15-8
Running Oracle Trace File Analyzer (TFA) Collector Commands	15-9
Running the Disk Diagnostic Tool	15-12
Running the Oracle Database Appliance Hardware Monitoring Tool	15-12
Configuring a Trusted SSL Certificate for Oracle Database Appliance	15-13
Option 1: Creating a Key and Java Keystore and Importing a Trusted Certificate	15-14
Option 2: Packaging an Existing PEM-format Key and Certificates in a New Java Keystore	15-16
Option 3: Converting an Existing PKCS or PFX Keystore to a Java Keystore	15-16
Configuring the DCS Server to Use Custom Keystore	15-17
Configuring the DCS Agent for Custom Certificate	15-18
Disabling the Web Console	15-18
Preparing Log Files for Oracle Support Services	15-19

## A ODACLI Command Reference for OAKCLI Migration

---

Appliance Commands	A-1
Patching Commands	A-2
Database Commands	A-3
Database Home Commands	A-3
Database Storage Commands	A-4
Network Commands	A-4
Storage Commands	A-5
Job Commands	A-6
Hardware Monitoring Commands	A-7

CPU Core Commands	A-7
Oracle Auto Service Request (ASR) Commands	A-8

## **B** Oracle Database Appliance Software Configuration Defaults

---

Directory Paths for Oracle Database Appliance	B-1
Location of Log Files	B-1
Oracle Groups and User Configurations for Oracle Database Appliance	B-3

## **D** Creating an Appliance Using JSON File

---

Loading and Saving Appliance Configurations	D-1
Readme for the Command <code>odacli create-appliance</code>	D-2
Example JSON Files to Create a Single Node Appliance with the CLI	D-2
Example JSON File to Create a Multi-Node Appliance with the CLI	D-7

## **E** Database Templates for Oracle Database Appliance

---

Types of Database Templates for Oracle Database Appliance	E-1
---	-----

## **Index**

---

## List of Figures

---

2-1	Two Custom Users with Six Custom Groups	2-6
3-1	Interconnects and Cables for a Single Storage Shelf on Oracle Database Appliance X5-2	3-2
3-2	Interconnects and Cables for Single Storage Shelf on Oracle Database Appliance X4-2	3-4
3-3	Interconnects When Using Fiber Connections to the Public Network on Oracle Database Appliance Models X5-2	3-6
3-4	Cables for Storage Expansion Shelf on Oracle Database Appliance X5-2	3-9
3-5	Front of Oracle Database Appliance Models X3-2, X4-2, and X5-2: Power Panel	3-12
3-6	Front of Oracle Database Appliance Version 1: Power Panel	3-13
12-1	Oracle Database Appliance Virtualized Platform Architecture	12-4
12-2	Architecture Overview of Oracle Database Appliance Virtualized Platform Shared Repositories	12-6
12-3	Basic Virtual Machine Local Area Network	12-8
12-4	Oracle Database Appliance Virtualized Platform with Virtual Local Area Networks	12-9

## List of Tables

---

1-1	Software for Oracle Database Appliance	1-3
2-1	Checklist for System Configuration Information for Oracle Database Appliance	2-10
2-2	Default IP Address Requirements for Oracle Database Appliance	2-11
3-1	Description of Callouts for Cabling Oracle Database Appliance X5-2 With Single Storage Shelf	3-3
3-2	Description of Callouts for Cabling Oracle Database Appliance X4-2 With Single Storage Shelf	3-4
3-3	Description of Callouts for Cabling Oracle Database Appliance Storage Expansion Shelf	3-9
3-4	Peripheral Device Connections for Oracle Database Appliance	3-10
3-5	Description of Callouts for Powering On Oracle Database Appliance	3-12
8-1	Command Options for Cleanup Utility	8-2
9-1	Operating System Groups and Users on Oracle Database Appliance	9-2
12-1	Parameters Available for Configuring a Virtual Machine	12-27
15-1	Command Options for tfactl Tool	15-9
B-1	Default Operating System Groups and Users Configuration for Oracle Database Appliance	B-3
2	Approximate Database Disk Group Sizes for Oracle Database Appliance X5-2 and X6-2-HA	5
3	Usable Storage on Oracle Database Appliance X5-2	6
4	Oracle ACFS Mount Points and Related Oracle ASM Disk Groups and Volume Information	8
E-1	Oracle Database Appliance Database Generic Template Name Conversions	E-3
E-2	Oracle Database Appliance OLTP Database Template Sizes	E-3
E-3	Oracle Database Appliance DSS Database Template Sizes	E-4
E-4	Oracle Database Appliance In-Memory Database Template Size	E-5
E-5	Oracle Database Appliance X5-2 Database Template Size Storage Performance	E-5
E-6	Oracle Database Appliance X4-2 Database Template Size Storage Performance	E-6
E-7	Oracle Database Appliance X3-2 Database Template Size Storage Performance	E-6
E-8	Oracle Database Appliance Version 1 Database Template Size Storage Performance	E-7



# Preface

Oracle Database Appliance is an optimized, prebuilt database system that is easy to deploy, operate, and manage. By integrating hardware and software, Oracle Database Appliance eliminates the complexities of nonintegrated, manually assembled solutions. Oracle Database Appliance reduces the installation and software deployment times from weeks or months to just a few hours while preventing configuration and setup errors that often result in suboptimal, hard-to-manage database environments.

- [Audience](#)
- [Documentation Accessibility](#)
- [Related Documents](#)
- [Conventions](#)

## Audience

This guide is intended for anyone who configures, maintains, or uses Oracle Database Appliance:

- System administrators
- Network administrators
- Database administrators
- Application administrators and users

This book does not include information about Oracle Database architecture, tools, management, or application development that is covered in the main body of Oracle Documentation, unless the information provided is specific to Oracle Database Appliance. Users of Oracle Database Appliance software are expected to have the same skills as users of any other Linux-based Oracle Database installations.

## Documentation Accessibility

For information about Oracle's commitment to accessibility, visit the Oracle Accessibility Program website at <http://www.oracle.com/pls/topic/lookup?ctx=acc&id=docacc>.

### Access to Oracle Support

Oracle customers that have purchased support have access to electronic support through My Oracle Support. For information, visit <http://www.oracle.com/pls/topic/lookup?ctx=acc&id=info> or visit <http://www.oracle.com/pls/topic/lookup?ctx=acc&id=trs> if you are hearing impaired.

## Related Documents

For more information about Oracle Database Appliance, go to <http://www.oracle.com/goto/oda/docs> and click the appropriate release. The following documents are published in the Oracle Database Appliance online documentation library:

- *Oracle Database Appliance Release Notes*
- *Oracle Database Appliance Licensing Information User Manual*
- *Oracle Database Appliance Security Guide*
- *Oracle Database Appliance Accessibility Guide*
- *Oracle Database Appliance X8-2 Deployment and User's Guide*
- *Oracle Database Appliance X7-2 Deployment and User's Guide*
- *Oracle Database Appliance X6-2-HA Deployment and User's Guide*
- *Oracle Database Appliance X6-2S/M/L Deployment and User's Guide*
- *Oracle Database Appliance X5-2/X4-2 Deployment and User's Guide*
- Oracle Database Appliance Setup Posters and Booklets (a full-size printed copy ships with Oracle Database Appliance)
- *Oracle Database Appliance Owner's Guide*
- *Oracle Database Appliance Service Manual*
- *Oracle Database Appliance Series Safety and Compliance Guide*

For more information about using Oracle Database, go to <http://docs.oracle.com/en/database/> and select the database release from the menu. See the following documents in the Oracle Database online documentation library:

- *Oracle Database Security Guide*
- *Oracle Database Administrator's Guide*
- *Oracle Database SQL Language Quick Reference*
- *Oracle Database Backup and Recovery User's Guide*
- *Oracle Database Backup and Recovery Reference*
- *Oracle Database Utilities*
- *Oracle Automatic Storage Management Administrator's Guide*

For more information about Oracle Integrated Lights Out Manager 3.2, see [https://docs.oracle.com/cd/E37444\\_01/](https://docs.oracle.com/cd/E37444_01/).

For more details about other Oracle products that are mentioned in Oracle Database Appliance documentation, see the Oracle Documentation home page at <http://docs.oracle.com>.

## Conventions

The following text conventions are used in this document:

<b>Convention</b>	<b>Meaning</b>
<b>boldface</b>	Boldface type indicates graphical user interface elements associated with an action or terms defined in the text.
<i>italic</i>	Italic type indicates book titles, emphasis, or placeholder variables for which you supply particular values.
monospace	Monospace type indicates commands within a paragraph, URLs, code in examples, text that appears on the screen, or text that you enter.
# prompt	The pound (#) prompt indicates a command that is run as the root user.

# 1

## Introduction to Oracle Database Appliance

Oracle Database Appliance saves time and money by simplifying deployment, maintenance, and support of database solutions for organizations of every size. Oracle Database Appliance hardware models are optimized to run Oracle Database Standard Edition and Enterprise Edition.

- [About Oracle Database Appliance](#)  
Understand Oracle Database Appliance hardware models, deployment plans, and database options.
- [Oracle Database Appliance Software Terminology](#)  
Understand the software patches available for Oracle Database Appliance.
- [About the Web Console](#)  
Use the Oracle Appliance Manager Web Console to deploy and manage the appliance, databases, networks, and jobs.

## About Oracle Database Appliance

Understand Oracle Database Appliance hardware models, deployment plans, and database options.

### About Oracle Database Appliance Hardware Models

Choose the Oracle Database Appliance hardware model that suits your business needs.

Oracle Database Appliance Hardware Model	Deployment Use Case
Oracle Database Appliance X8-2S, X8-2M, X8-2-HA	<ul style="list-style-type: none"><li>• Oracle Database Appliance X8-2S is a small configuration designed for smaller or entry-level deployments.</li><li>• Oracle Database Appliance X8-2M is a medium-sized configuration designed for performance.</li><li>• Oracle Database Appliance X8-2-HA is a large configuration designed for larger databases and high-availability.</li></ul>
Oracle Database Appliance X7-2S, X7-2M, X7-2-HA	<ul style="list-style-type: none"><li>• Oracle Database Appliance X7-2S is a small configuration designed for smaller or entry-level deployments.</li><li>• Oracle Database Appliance X7-2M is a medium-sized configuration designed for performance.</li><li>• Oracle Database Appliance X7-2-HA is a large configuration designed for larger databases and high-availability.</li></ul>

Oracle Database Appliance Hardware Model	Deployment Use Case
Oracle Database Appliance X6-2S, X6-2M, X6-2L	<ul style="list-style-type: none"> <li>• Oracle Database Appliance X6-2S is a small configuration designed for smaller or entry-level deployments.</li> <li>• Oracle Database Appliance X6-2M is a medium-sized configuration designed for performance.</li> <li>• Oracle Database Appliance X6-2L is a large configuration designed for larger databases.</li> </ul>
Oracle Database Appliance X6-2-HA	Highly-available two-node Oracle RAC clusters that can support both Oracle RAC and single-instance databases.
Oracle Database Appliance X5-2 and X4-2	Highly-available two-node Oracle RAC clusters that can support both Oracle RAC and single-instance databases.

You cannot expand or reconfigure Oracle Database Appliance to a different configuration. For example, you cannot expand Oracle Database Appliance X7-S to Oracle Database Appliance X7-2M. For Oracle Database Appliance hardware configuration details, see the *Oracle Database Appliance Owner's Guide*.

### About Oracle Database Appliance Deployment Plans

Oracle Database Appliance X8-2S and X8-2M are single node systems that you deploy as a bare metal platform.

Oracle Database Appliance X8-2-HA is a two-node system with the option to deploy as a bare metal platform or a virtualized platform.

Oracle Database Appliance X7-2S and X7-2M are single node systems that you deploy as a bare metal platform.

Oracle Database Appliance X7-2-HA is a two-node system with the option to deploy as a bare metal platform or a virtualized platform.

Oracle Database Appliance X6-2S, X6-2M, X6-2L are single node systems that you deploy as a bare metal platform.

Oracle Database Appliance X6-2-HA is a two-node system with the option to deploy as a bare metal platform or a virtualized platform. Starting with Oracle Database Appliance release 18.7, systems deployed as bare metal are migrated from oakcli to oadcli (the DCS software stack). Virtualized systems continue to use the oakcli software stack.

Oracle Database Appliance X5-2 and X4-2 are two-node systems with the option to deploy as a bare metal platform or a virtualized platform. Starting with Oracle Database Appliance release 18.7, systems deployed as bare metal are migrated from oakcli to oadcli (the DCS software stack). Virtualized systems continue to use the oakcli software stack.

### About Database Deployment Options for Oracle Database Appliance

The following Oracle Database editions are available:

Database Edition	Supported Releases	Description
Oracle Database Enterprise Edition	Oracle Database Release 18c, 12.2.0.1, 12.1.0.2, and 11.2.0.4	Supports Oracle Real Application Clusters (Oracle RAC) and single-instance Oracle Databases.
Oracle Database Standard Edition Two	Oracle Database Release 18c, 12.2.0.1, 12.1.0.2, and 11.2.0.4	Supports Oracle Real Application Clusters (Oracle RAC), Oracle RAC One, and single-instance Oracle Databases.
Oracle Database Standard Edition One	Oracle Database Release 11.2.0.4	Supports Oracle Real Application Clusters (Oracle RAC), Oracle RAC One, and single-instance Oracle Databases.
Oracle Database Standard Edition	Oracle Database Release 11.2.0.4	Supports Oracle Real Application Clusters (Oracle RAC), Oracle RAC One, and single-instance Oracle Databases.

 **Note:**  
It is important to understand your Oracle Database licensing before you create databases. You cannot provision Oracle Database Enterprise Edition and Standard Edition databases in the same bare metal platform, or the same ODA\_BASE virtualized deployment, subject to Oracle Database licensing requirements. Review the Database Licensing Information User Manual for the Oracle Database release to review supported options and products.

## Oracle Database Appliance Software Terminology

Understand the software patches available for Oracle Database Appliance.

The table describes the Oracle Database Appliance patches that are available for download and the purpose of the patch.

 **Note:**  
Some hardware models may not use the patches listed in the table.

**Table 1-1 Software for Oracle Database Appliance**

Patch	Description
Oracle Database Appliance patch bundle (quarterly patch release)	Use the patch bundle to update to the latest release after Oracle Database Appliance is deployed. The patch updates the Oracle Database Appliance server, storage, and database components.

**Table 1-1 (Cont.) Software for Oracle Database Appliance**

Patch	Description
Oracle Database Appliance GI/ RDBMS Clone	Use to perform an initial deployment of Oracle Database Appliance. The bundle contains the latest Grid Infrastructure and RDBMS components, Oracle Database Appliance Manager software, Oracle Linux and hardware drivers for deployment on an Oracle Database Appliance that is shipped from factory state. If you reimage Oracle Database Appliance with the Bare Metal ISO Image, download the GI/RDBMS Clone patch to deploy Oracle Database Appliance.
RDBMS Clone	Use the RDBMS Software Clone files to get the latest RDBMS clone binaries for Oracle Database releases 18c, 12.2.0.1, 12.1.0.2, and 11.2.0.4. The RDBMS clone files are needed to create Oracle databases and database homes.
Bare Metal ISO Image	Use to reimage the appliance and reset the system back to the factory configuration.
VM ISO Image (DOM0) (Virtualized Platform ISO Image)	Use to re-image Oracle Database Appliance before deploying the ODA_Base Template and virtualized platform. The Oracle Database Appliance virtualized operating system image contains the following: <ul style="list-style-type: none"> <li>• Oracle Database Appliance Manager oakcli command-line interface</li> <li>• Oracle Database Appliance Manager Configurator</li> <li>• Oracle Linux</li> <li>• Hardware drivers</li> </ul> Required for Virtualized Platform deployments on multi-node high availability (HA) systems.
ODA_BASE Template (Virtualization Template)	Use to create the ODA_Base virtual machine for a virtualized database appliance. The template contains the following: <ul style="list-style-type: none"> <li>• Oracle Virtual Machine template</li> <li>• Oracle Database clone binaries</li> <li>• Oracle Database templates, customized for Oracle Database Appliance deployments</li> <li>• Oracle Grid Infrastructure clone binaries</li> </ul> Required for Virtualized Platform deployments on multi-node HA systems.

**Note:**

See the *Oracle Database Appliance Release Notes* for the patch numbers and download locations and the component versions available in the patch bundle.

 **Note:**

Starting with Oracle Database 18c, Oracle provides quarterly updates in the form of Release Updates (Updates) and Release Update Revisions (Revisions). Oracle no longer releases patch sets. For more information, see My Oracle Support Note 2285040.1.

Oracle Database releases are of type `version` and `version_full` releases. The `version` release is designated in the form major release version.0.0.0.0. The major release version is based on the last two digits of the year in which an Oracle Database version is released for the first time. The `version_full` release is an update of a version release and is designated based on the major release version, the quarterly release update version (Update), and the quarterly release update revision version (Revision).

Prior to Oracle Database release 18c, changing the first or second digit in the release number was an upgrade, and changing the fourth digit indicated an update. With 18c and later releases, changing the first digit is an upgrade, and changing the second indicates an update.

## About the Web Console

Use the Oracle Appliance Manager Web Console to deploy and manage the appliance, databases, networks, and jobs.

The Web Console provides a user-friendly interface to quickly view and perform many of the tasks needed to deploy, patch, and manage your bare metal system. The *Oracle Database Appliance Deployment and User's Guide* for your hardware model describes how to use the Web Console to perform many of the tasks related to deployment, patching, and management of your appliance.

Use the links in the side navigation to view and manage the following:

- **Appliance**
  - Appliance information
  - System information
  - Disk group information including storage utilization such as free and used space
  - Information about all databases that use a storage disk group
  - All the patches and hardware and software components installed on the appliance
  - List of RPMs and RPM Drift information
- **Network**
  - View network details
  - Create, update, and delete networks
  - View interface details
- **Oracle ASR**



- View Oracle Auto Service Request (Oracle ASR) configuration details
- Configure, update, test, and delete Oracle ASR
- **Patch Manager**
  - Update the patch repository with Oracle Database Appliance patches
  - View component details of the patch and versions that are installed on the appliance
  - View component details of the patch and versions that are available, but not yet installed, on the appliance
  - Run patch prechecks before applying the patch
  - Update the server and storage components

Use the links in the top navigation to view and manage the following:

- **Database**
  - Create a database
  - View database details
  - Apply a backup policy for the database
  - Create a manual backup
  - Recover a database from a backup
  - View and update the database backup schedule and update the archive log backup schedule for the database
  - Create, update, and delete backup policies
  - Create, update, and delete database homes
  - Create and delete database backup
  - Clone a database from a database backup or an Oracle ACFS database snapshot
  - Patch database homes
- **Object Store**
  - Create Object Store Credentials for backup and recovery
  - View the details for Object Store Credentials, including the endpoint URL, user name, and tenant
  - Update and delete Object Store Credentials
- **Monitoring**
  - View the status of hardware, storage, memory, cooling, networking, and power
  - View monitoring information for each node, in the case of High-Availability deployments
  - View system health status and drilldown to details of incidents
  - Click the hardware image to view details
- **Activity**
  - View a list of jobs, details, and status
  - Click a job description to view job details

## Update ILOM and User Settings

Expand **About** in the upper right corner of the Web Console to perform the following tasks:

- Click **About** to view the Oracle Database Appliance release that is installed on the appliance.
- Click **Update ILOM Setting** to change the root password. To enable first-time login and access to Oracle ILOM, a default Administrator (root) account and its password are provided with the system.
- Click **Update User Settings** to change the `oda-admin` password.
- Click **Sign Out** to sign out of the Web Console. If you do not sign out, the system automatically signs you out after a period of inactivity. A warning will appear 2 minutes before the session expires.

# 2

## Preparing for Oracle Database Appliance Installation and Deployment

Complete these setup tasks before Oracle Database Appliance is delivered.

Tasks:

- [Registering Your Support Identifier on My Oracle Support](#)  
Add your hardware Support Identifier (SI) to your My Oracle Support account profile.
- [Planning Oracle Database Appliance Configuration Options](#)  
Use these topics to help you to make decisions about your Oracle Database Appliance configuration.
- [Gathering System Requirement Information](#)  
Use these checklists to collect information before deploying Oracle Database Appliance.

### Registering Your Support Identifier on My Oracle Support

Add your hardware Support Identifier (SI) to your My Oracle Support account profile.

Your hardware SI is supplied when you purchase Oracle Database Appliance. If you acquire new software licenses, then you must also register your new software SIs. The SI registration process can take up to 24 hours to complete.

 **Note:**

You cannot obtain support or software from Oracle without registered SIs.

### Planning Oracle Database Appliance Configuration Options

Use these topics to help you to make decisions about your Oracle Database Appliance configuration.

These topics help you to select the correct Oracle Database Appliance and plan for deployment. Record your decisions and the information that you require before you proceed to complete system configuration checklists.

**▲ Caution:**

Do not use Oracle Database Configuration Assistant (DBCA) to create databases on Oracle Database Appliance. Only use Oracle Appliance Manager for database configuration. Deploying Oracle Database instances using Oracle Appliance Manager ensures that these databases are properly configured, optimized, and supported on Oracle Database Appliance.

Topics:

- [Selecting Database Deployment Options for Oracle Database Appliance](#)  
If you plan to create an initial database during deployment, then use these lists to select an Oracle Database deployment option, and prepare for the deployment.
- [Selecting Database Shapes for Oracle Database Appliance](#)  
Oracle Database Appliance software includes preconfigured templates, known as shapes, that incorporate Oracle best practices with optimization for different classes of databases.
- [Calculating Required Cores](#)  
After you select templates for your planned Oracle Database, identify your workload type, and determine the total number of CPUs that you require to support the templates.
- [Selecting Operating System Groups and Users](#)  
Determine how you want to configure your operating system groups and users and whether or not you want to allow operating system role separation.

## Selecting Database Deployment Options for Oracle Database Appliance

If you plan to create an initial database during deployment, then use these lists to select an Oracle Database deployment option, and prepare for the deployment.

Oracle Appliance Manager installs Oracle Database software on mirrored disks that are internal to Oracle Database Appliance. During the initial deployment, you can either create a database or you can defer database creation to a later time.

Options:

- **Enterprise Edition:** Oracle Database 18c Enterprise Edition (no automated failover), with the following characteristics:
  - Single-instance Oracle Database Enterprise Edition home
  - Oracle Database software installation on both nodes
- **Oracle Real Application Clusters (Oracle RAC) One Node:** Oracle RAC One Node 18c, with the following characteristics:
  - Oracle RAC One Node has a designated Oracle Database Appliance home node
  - Oracle RAC One Node software is installed on both servers
  - Automated failover is configured

- Enterprise Edition license is required
- Oracle RAC One Node license on each server is required  
Exception: If you designate one server as a backup server, then you can use that server without a license, in accordance with the 10-day rule.
- **Oracle RAC:** Oracle Real Application Clusters 18c, with the following characteristics:
  - Oracle RAC home
  - Oracle RAC software is installed on both servers
  - Enterprise Edition license is required
  - Oracle RAC license on each server is required (not eligible for the 10-day rule)

 **Note:**

For information about the 10-day rule, see the *Oracle Software Investment Guide* at <https://www.oracle.com/corporate/pricing/>.

## Selecting Database Shapes for Oracle Database Appliance

Oracle Database Appliance software includes preconfigured templates, known as shapes, that incorporate Oracle best practices with optimization for different classes of databases.

Because of differences in CPU counts, memory size, and other resources available with different Oracle Database Appliance models, some shapes are not supported on all models.

Each Oracle Database shape has different workload profile and performance characteristics:

- Memory requirements, which are calculated from the System Global Area (SGA), and Program Global Area (PGA) sizes
- Processing requirements, which are calculated from the number of processes
- Logging requirements, which are based on log buffer size, and online redo log size

Oracle Database Appliance shapes are tuned for the size of each database instance workload and are designed to run on a specific number of cores.

 **Note:**

Oracle strongly recommends that you use the Oracle Database Appliance shapes. These shapes implement best practices, and are configured specifically for Oracle Database Appliance.

## Calculating Required Cores

After you select templates for your planned Oracle Database, identify your workload type, and determine the total number of CPUs that you require to support the templates.

Oracle Database Appliance templates are configured and tuned for specific types of Oracle Database workloads:

- Generic templates
- Online analytic transaction templates (OLTP)
- Decision support services templates (DSS)
- In-Memory database templates

These templates are designed to run on a specific number of cores. Caging ensures that each database workload is restricted to the set of cores allocated by the template, enabling multiple databases to run concurrently with no performance degradation, up to the capacity of Oracle Database Appliance. You can select database template sizes larger than your current needs to provide for planned growth, which you accommodate later by adjusting System Global Area (SGA) and Program Global Area (PGA) sizes, as well as the number of cores.

## Selecting Operating System Groups and Users

Determine how you want to configure your operating system groups and users and whether or not you want to allow operating system role separation.

### About Operating System Groups and Users

Role separation enables you to configure groups and users to provide separate groups for operating system authentication.

Without role separation, a single user owns all of the Oracle installations. All of the databases are installed under a single user. Role separation enables you to have separate users for Oracle and Oracle Clusterware. You can install multiple databases without sharing operating system authentication for system privileges. In addition, each Oracle software installation is owned by a separate installation owner, to provide operating system user authentication for modifications to Oracle Database binaries.

#### Note:

Any Oracle software owner can start and stop all databases and shared Oracle Grid Infrastructure resources, such as Oracle Automatic Storage Management (Oracle ASM) or Virtual IP (VIP). The job role separation configuration enables database security, it does not restrict user roles in starting and stopping various Oracle Clusterware resources.

With Oracle Grid Infrastructure role separation, separate operating system groups provide operating system authentication for Oracle ASM system privileges for storage tier administration. This operating system authentication is separated from Oracle Database operating system authentication. In addition, the Oracle Grid Infrastructure

installation owner provides operating system user authentication for modifications to Oracle Grid Infrastructure binaries.

You can configure the appliance with one of four combinations of operating system users, groups, and roles. The default users are the Oracle Database installation owner (`oracle`) and Oracle Grid Infrastructure installation owner (`grid`). The default groups are `oinstall`, `dbaoper`, `dba`, `asmadmin`, `asmoper`, and `asmdba`.

### Default Configuration: Two Users with Six Groups

The default configuration is a combination of two operating system roles for users with six groups.

To configure two users, `oracle` user with the Oracle User (`oracleUser`) role and the `grid` user with the `gridUser` role, allow operating system role separation.

To configure six groups, `oinstall`, `dbaoper`, `dba`, `asmadmin`, `asmoper`, and `asmdba`, do not select the option to customize users and groups.

 **Note:**

When you select the default configuration in the Web Console, the users and groups do not appear in the interface.

### Two Custom Users with Six Custom Groups

You can customize the configuration to create two custom users and six custom groups.

To configure two users, allow operating system role separation. The users are populated with the default values, `oracle` and `grid`, which you can edit.

To configure six groups, select the option to customize users and groups. The groups are populated with the default values, which you can edit. The default groups are `oinstall`, `dbaoper`, `dba`, `asmadmin`, `asmoper`, and `asmdba`.

The figure shows an example of a custom configuration with the default values populated.

**Figure 2-1 Two Custom Users with Six Custom Groups**

### Single Custom User with Six Custom Groups

You can customize the configuration to create a single operating system database user and with six custom groups. The database user can deploy both the grid infrastructure and RDBMS (relational database management system) stacks. You can edit the user name and user ID and you can customize the group names and IDs. Use this option when you deploy SAP.

To configure a single `oracle` database user with the Oracle User (`oracleUser`) role, do not allow OS role separation.

To configure six groups, select the option to customize users and groups. The following default groups are populated: `oinstall`, `dbaoper`, `dba`, `asmadmin`, `asmoper`, and `asmdba`. You can customize the groups.

### Single User with Two Groups

To configure a single `oracle` user with the Oracle User (`oracleUser`) role, do not allow OS role separation.

To configure two groups, `oinstall` and `dba`, do not select the option to customize users and groups.

## Gathering System Requirement Information

Use these checklists to collect information before deploying Oracle Database Appliance.

- [List of Information You Need Before Deployment](#)  
Collect storage and network information required to prepare for deploying Oracle Database Appliance.



- [Checklist for System Details](#)  
Use the checklist to gather system information that you need to obtain for Oracle Database Appliance. Record the values for your system.
- [Checklist for Custom Network Address Configuration](#)  
Use the checklist to identify the IP addresses required for Oracle Database Appliance.

## List of Information You Need Before Deployment

Collect storage and network information required to prepare for deploying Oracle Database Appliance.

Review your security requirements for `root` passwords, determine your storage requirements and network administration requirements, and complete any required configuration before your Oracle Database Appliance hardware is delivered.

### Security Requirements

- What root password should you use for Oracle Database Appliance? Root passwords should comply with your system security requirements.
- Secure operating systems are an important basis for general system security. Ensure that your operating system deployment is in compliance with common security practices.

### Storage Administration Requirements

Storage administration is integrated into Oracle Database Appliance. No additional storage configuration is required.

Oracle Database Appliance includes integrated storage for operational files (operating system, Oracle Grid Infrastructure home, Oracle Database homes, tools), user data (database files), and log files (database redo logs). Operational files are stored on mirrored internal system disks in each server.

Data and database redo log files are stored on shared disks:

- On Oracle Database Appliance X5-2, data files are stored in the storage shelf and the optional storage expansion shelf. Database redo log files are stored on solid-state drives (SSDs) in the storage shelf, and on the optional storage expansion shelf.

Oracle Database Appliance X5-2 contains four 400 GB SSDs, which are configured as an ASM disk group, using ACFS for an additional database cache. Also, on Oracle Database Appliance X5-2, four 200 GB SSDs are used for attribute caching, in addition to the database redo logs.

 **Note:**

Oracle Database Appliance X5-2 ships with 4 TB shared disks. Disk hardware capacity is measured using the formula that 1 KB equals 1,000 bytes; software storage requirements are based on 1 KB equals 1,024 bytes. This difference of 24 bytes means that a disk that has a rated capacity of 4 TB actually has about 3.725 TB of available space for software storage.

## Network Administration Requirements

Ensure that the names and addresses that you provide for network configuration are configured in your Domain Name System (DNS) servers. With Patch Set 1 and later, the addresses that you provide are configured in the `/etc/hosts` file to provide IP name and address resolution, even if a DNS server is not available.

If you are deploying Oracle Database Appliance X5-2 or X4-2, then you have the option to connect either to a copper, or to a fiber public network. To connect to a fiber network on Oracle Database Appliance X5-2, you must also replace the InfiniBand cards with 10 GbE SFP+ fiber cards. Ensure that your network planning is based on the correct type of public network.

Oracle recommends that you resolve addresses using a DNS server, so that you can use Single Client Access Names (SCANs). Having a single name to access the cluster enables the client to use the EZConnect client and the simple JDBC thin URL to access any Oracle Database running in the cluster, independent of the active servers in the cluster. The SCAN provides load-balancing and failover for client connections to these databases. The SCAN works as a cluster alias for Oracle Databases in the cluster.

If you deploy without using a DNS server, then you can add a DNS server later, and add SCANs. If you add SCANs, then you must specify additional VIP addresses for those SCANs.

A correctly configured Oracle Database Appliance requires at least six public addresses on the same subnet for the nodes:

- A public IP name and address for each node
- A virtual IP name and address for each node
- Two addresses that resolve to the SCAN for the cluster

All names must conform to the RFC 952 standard, which permits alphanumeric characters and hyphens ("-"), but does not allow underscores ("\_").

Provide an IP address for the public interface for each node. This interface is `bond0`, or `Eth1` on Oracle Database Appliance Virtualized Platform, (a bond of `Eth2` and `Eth3`), which is used for the host IP address for the node.

If you select a Custom installation, then provide names and addresses for the following optional interfaces that you need:

- `bond1` (Ethernet bond): This applies to all Oracle Database Appliance platforms.
- `bond2` (Ethernet bond): This applies only to Oracle Database Appliance Version 1.
- `xbond0` (for high capacity transfers, such as backups): This applies only to Oracle Database Appliance Version 1.

Use `bond1` and `bond2` for management, backup, disaster recovery, or other options where you require a network interface. Be prepared to provide a netmask and a gateway for each interface, as both are required when you configure network connections for Oracle Database Appliance.

Also determine answers to the following questions:

- Do you have a Network Time Protocol (NTP) service configured for each server, so that the local system time for each server is synchronized?

If you have NTP servers, and you want to synchronize time between Oracle Database Appliance nodes using NTP, then be prepared to provide the addresses for the servers. If you do not provide addresses for NTP servers, then Oracle Grid Infrastructure software configures time synchronization between nodes using Cluster Time Synchronization Service (CTSS).

- Do you want to plug in the public IP address cables to redundant switches, so that you can avoid a single point of failure for Oracle Database Appliance? Oracle recommends that you use redundant switches for High Availability.

### IP Address Questions to Ask Your Network Administrator

Confirm with your network administrator that the IP addresses that you configure for Oracle Database Appliance meet these three criteria:

1. They are static IP addresses.
2. They are on the same subnet as all other IP addresses, virtual IP (VIP) addresses (used for Oracle Real Application Clusters communication), and SCAN addresses.
3. They include the following:
  - One public IP address configured on the DNS server for each node and resolvable to that node before installation.
  - A VIP address for each node configured on the DNS server that is not currently in use.
  - SCANS for Oracle Database Appliance with the following characteristics:
    - Configured on the DNS server before installation, so that the two IP addresses are associated with the name provided as the SCAN, and both addresses are returned in random order to the requester by the DNS server
    - Configured on the DNS server before installation to resolve to addresses that are not currently in use
    - Have names that do not begin with a numeral

#### **Caution:**

Do not change the IP addresses and subnet for the private network.

#### **Note:**

Configuring SCANS in a Network Information Service (NIS) is not supported.

### Additional Information

See *Oracle Database Appliance Owner's Guide* for information about replacing the InfiniBand cards with 10 GbE SFP+ fiber cards. For a comprehensive introduction to SCANS, see "Oracle Single Client Access Name (SCAN)", a technical paper on Oracle Technology, and *Oracle Grid Infrastructure Installation Guide for Linux*.

**Related Topics**

- [Oracle Grid Infrastructure Installation Guide for Linux](#)

## Checklist for System Details

Use the checklist to gather system information that you need to obtain for Oracle Database Appliance. Record the values for your system.

**Table 2-1 Checklist for System Configuration Information for Oracle Database Appliance**

System Information	Description
Oracle Database Appliance System Name	<p>Provide the name for the cluster running on Oracle Database Appliance. This name is also used as the default root word for Oracle Database Appliance network addresses. The name must be unique across your enterprise, must be at least one character long and no more than 13 characters in length, must be alpha-numeric, cannot begin with a numeral, and may contain hyphens (-). Underscore characters ( <code>_</code> ) are not allowed.</p> <p>The name you choose will become the default first part of the names for the following items. The default (generated names) can be changed.</p> <ul style="list-style-type: none"> <li>• Oracle ILOM host names for Nodes 1 and 2 (<i>systemname1-ilom</i> and <i>systemname2-ilom</i> respectively)</li> <li>• SCAN host name (<i>systemname-scan</i>)</li> <li>• Node 0 and Node 1 Public IP addresses (<i>systemname1</i> and <i>systemname2</i> respectively)</li> <li>• Node 0 and Node 1 Virtual IP addresses (<i>systemname1-vip</i> and <i>systemname2-vip</i> respectively)</li> </ul> <p>The name should comply with the host name specifications described in the RFC 952 standard.</p>
Type of Configuration	<p>Typical, which has the most default values.</p> <p>Custom (recommended by Oracle), which allows you to override default values for any or all of the following:</p> <ul style="list-style-type: none"> <li>• Database block size, language, territory, backup file location, or disk redundancy level for the DATA and RECO disk groups</li> <li>• Oracle Integrated Lights Out Manager (Oracle ILOM) server</li> <li>• Oracle Auto Service Request (Oracle ASR) configuration</li> <li>• Oracle Cloud File System mount point and file system size</li> <li>• Network Time Protocol (NTP) service server</li> </ul>
Mode	Bare metal or virtualized platform
Region	Select the region where you plan to operate the Oracle Database Appliance system.
Timezone	Select the time zone where you plan to operate the Oracle Database Appliance system.
Initial Database Details (if you want to create one during deployment)	<ul style="list-style-type: none"> <li>• Database name</li> <li>• Normal or container database</li> <li>• Class (database template)</li> <li>• Database language</li> <li>• Database deployment (Oracle Enterprise Edition single instance, Oracle RAC One Node, or Oracle RAC)</li> <li>• (Container databases only) Data file size, in gigabytes (GB)</li> </ul>
Root password	You are prompted to provide a root password for the system. Ensure that the root password you provide is in compliance with common security practices.

 **Note:**

Oracle recommends that you use all lowercase characters for the host name. The names are generated from the system name. For example, if you use `mssystem` as the name of your system, then the derived host names are `mssystem0` and `mssystem1`; the derived host virtual IP names are `mssystem0-vip` and `mssystem1-vip`; and the ILOM names are `mssystem0-ilom` and `mssystem1-ilom`.

## Checklist for Custom Network Address Configuration

Use the checklist to identify the IP addresses required for Oracle Database Appliance.

 **Note:**

Oracle does not recommend changing the default Host Private Address. You cannot change the private network after deploying the appliance.

**Table 2-2 Default IP Address Requirements for Oracle Database Appliance**

Type of IP	IP Address Default Values	Your Values As Applicable
Client Access Network	No default	No default
Additional Network	No default	No default
Oracle Integrated Lights Out Manager (ILOM)	No default	No default
Host Private Addresses	InfiniBand has bonded interface <code>ibbond0</code> . The system configures <code>icbond0</code> on non-InfiniBand High-Availability systems. The subnet <code>192.168.16.0/24</code> is configured.	Not applicable: the private addresses are defined before deployment and should not be changed

# 3

## Readying Oracle Database Appliance for Deployment

Complete these tasks to prepare to deploy Oracle Database Appliance.

Topics:

- [About Interconnect Cabling](#)  
Interconnect is reserved for Oracle Grid Infrastructure (GI) and Oracle Relational Database Management System (RDBMS).
- [Attaching Supplied Cables for Oracle Database Appliance](#)  
If you are using Oracle Database Appliance with a single storage shelf, attach the interconnect cables.
- [Attaching a Storage Expansion Shelf to Oracle Database Appliance](#)  
Review these topics to install and cable a storage expansion shelf for Oracle Database Appliance.
- [Attaching Peripheral Devices](#)  
Complete this task if you have direct access to Oracle Database Appliance and you intend to use a locally connected monitor, keyboard and mouse.
- [Attaching Power Cords and Initializing Components](#)  
Attach power cords for Oracle Database Appliance.
- [Powering On Oracle Database Appliance the First Time](#)  
Use this procedure to power on Oracle Database Appliance.
- [Defining Your Public Network Interface Type](#)  
Understand how you can define the public network interface type before deploying the appliance.
- [Configuring Oracle Integrated Lights Out Manager](#)  
Configure Oracle Integrated Lights Out Manager (Oracle ILOM) to manage Oracle Database Appliance independent of the operating system.

### About Interconnect Cabling

Interconnect is reserved for Oracle Grid Infrastructure (GI) and Oracle Relational Database Management System (RDBMS).

Oracle GI includes Oracle Clusterware, Oracle Automatic Storage Management (Oracle ASM), and Oracle Restart. Even if you do not use Oracle Real Application Clusters (RAC), Oracle Database Appliance uses the interconnect for RAC ASM and Oracle GI.

 **Note:**

Do not use interconnect for other applications.

When you power on Oracle Database Appliance for the first time, the system automatically defines your public network interface based on the interconnect. If you use the InfiniBand cards, then the InfiniBand network is used for the interconnect. If you ordered the configuration that contains the 10GbE SFP+ (fiber) cards instead of InfiniBand cards, then the onboard 10GBase-T (Copper) ports are used for the interconnect.

## Attaching Supplied Cables for Oracle Database Appliance

If you are using Oracle Database Appliance with a single storage shelf, attach the interconnect cables.

Topics:

- [Attaching Cables for Oracle Database Appliance X5-2](#)  
Use the diagram in this topic to understand how to attach cable connections between ports on Oracle Database Appliance model X5-2 with a single storage shelf:
- [Attaching Cables for Oracle Database Appliance Models X4-2](#)  
Use the diagram in this topic to understand how to attach cable connections between ports on Oracle Database Appliance model X4-2.
- [Cabling Oracle Database Appliance to Connect to Fiber Public Networks \(Optional\)](#)  
You can configure X5-2 appliances to use fiber connections for the public network.

### Attaching Cables for Oracle Database Appliance X5-2

Use the diagram in this topic to understand how to attach cable connections between ports on Oracle Database Appliance model X5-2 with a single storage shelf:

**Figure 3-1 Interconnects and Cables for a Single Storage Shelf on Oracle Database Appliance X5-2**

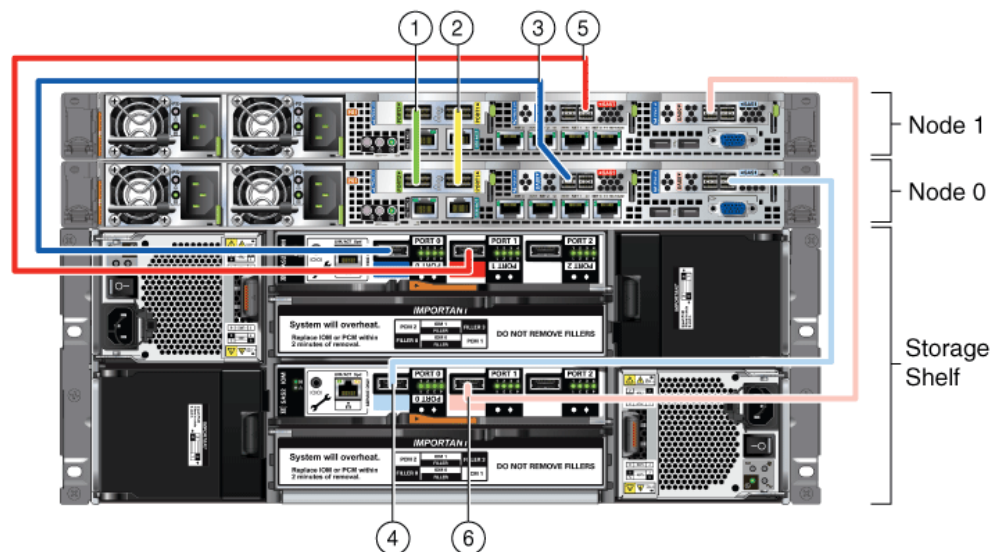

**Table 3-1 Description of Callouts for Cabling Oracle Database Appliance X5-2 With Single Storage Shelf**

Callout Number	Description
1	Green InfiniBand Cable (Oracle Database Appliance X5-2) <ul style="list-style-type: none"> <li>From: Node 0, PCIe slot 1, PORT2</li> <li>To: Node 1, PCIe slot 1, PORT2</li> </ul>
2	Yellow InfiniBand Cable (Oracle Database Appliance X5-2) <ul style="list-style-type: none"> <li>From: Node 0, PCIe slot 1, PORT1</li> <li>To: Node 1, PCIe slot 1, PORT1</li> </ul>
3	Dark blue SAS cable: <ul style="list-style-type: none"> <li>From: Node 0, PCIe slot 2, SAS0</li> <li>To: Storage shelf, top I/O port 0</li> </ul>
4	Light blue SAS cable: <ul style="list-style-type: none"> <li>From: Node 0, PCIe slot 3, SAS1</li> <li>To: Storage shelf, bottom I/O port 0</li> </ul>
5	Dark red SAS cable: <ul style="list-style-type: none"> <li>From: Node 1, PCIe slot 2, SAS1</li> <li>To: Storage shelf, top I/O port 1</li> </ul>
6	Light red SAS cable: <ul style="list-style-type: none"> <li>From: Node 1, PCIe slot 3, SAS0</li> <li>To: Storage shelf, bottom I/O port 1</li> </ul>

 **Note:**

The back panel of each node contains three PCIe generation 3 terminal slots, with two sockets in each slot. The PCIe slots are labeled **X PCIe3**, where **X** is the PCIe slot number.

## Attaching Cables for Oracle Database Appliance Models X4-2

Use the diagram in this topic to understand how to attach cable connections between ports on Oracle Database Appliance model X4-2.

The following figure illustrates the cable connections between ports on Oracle Database Appliance model X4-2 in a single storage shelf.



**Figure 3-2 Interconnects and Cables for Single Storage Shelf on Oracle Database Appliance X4-2**

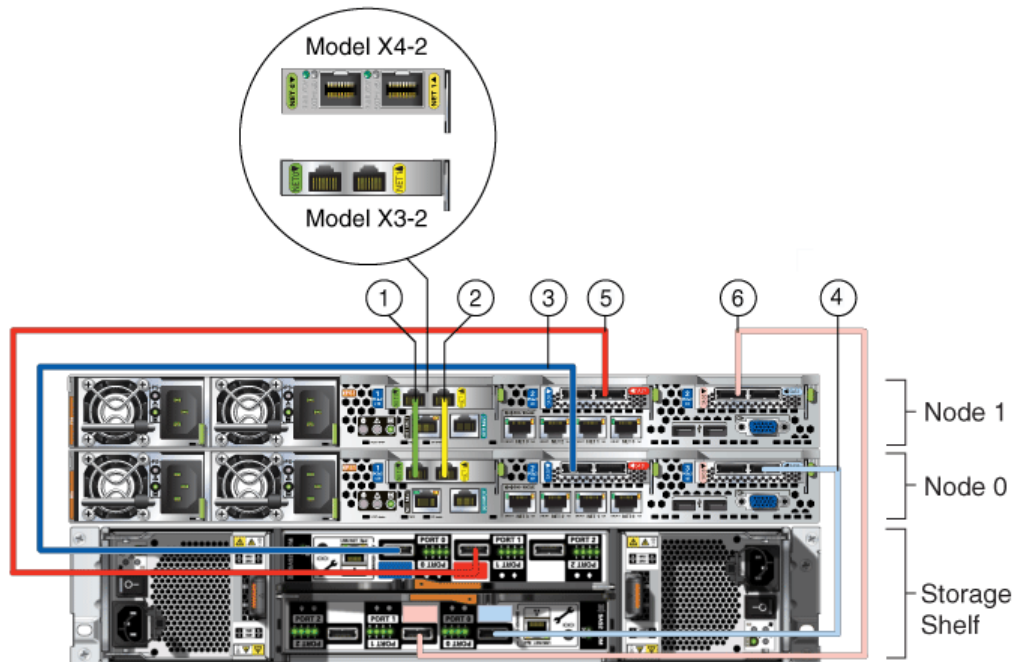

**Table 3-2 Description of Callouts for Cabling Oracle Database Appliance X4-2 With Single Storage Shelf**

Callout Number	Description
1	Green-labelled twinax cable (Oracle Database Appliance X4-2): <ul style="list-style-type: none"> <li>From: Node 0, PCIe slot 1, NET0</li> <li>To: Node 1, PCIe slot 1, NET0</li> </ul>
2	Yellow-labeled twinax cable (Oracle Database Appliance X4-2) <ul style="list-style-type: none"> <li>From: Node 0, PCIe slot 1, NET1</li> <li>To: Node 1, PCIe slot 1, NET1</li> </ul>
3	Dark blue SAS cable: <ul style="list-style-type: none"> <li>From: Node 0, PCIe slot 2, SAS0</li> <li>To: Storage shelf, top I/O port 0</li> </ul>
4	Light blue SAS cable: <ul style="list-style-type: none"> <li>From: Node 0, PCIe slot 3, SAS1</li> <li>To: Storage shelf, bottom I/O port 0</li> </ul>
5	Dark red SAS cable: <ul style="list-style-type: none"> <li>From: Node 1, PCIe slot 2, SAS1</li> <li>To: Storage shelf, top I/O port 1</li> </ul>
6	Light red SAS cable: <ul style="list-style-type: none"> <li>From: Node 1, PCIe slot 3, SAS0</li> <li>To: Storage shelf, bottom I/O port 1</li> </ul>

**▲ Caution:**

Do not attach cables to ethernet ports in the I/O modules labeled "SERVICE ONLY" when cabling the system. These ports are intended for use by service engineers only. You must use Oracle Appliance Manager to manage Oracle Database Appliance storage.

**✎ Note:**

The back panel of each node contains three PCIe generation 3 terminal slots, with two sockets in each slot. The PCIe slots are labeled **X PCIe3**, where **X** is the PCIe slot number.

## Cabling Oracle Database Appliance to Connect to Fiber Public Networks (Optional)

You can configure X5-2 appliances to use fiber connections for the public network.

For Oracle Database Appliance X5-2 installations, if you want to use fiber connections between Oracle Database Appliance and your public network, then you must cable the interconnect by using the green and yellow copper ports (onboard ports `net0` and `net1`). The green and yellow Category 6 (Cat 6) interconnect cables for these ports ship with the base system.

For Oracle Database Appliance X5-2, if you want to use a fiber port connection, then you must replace the InfiniBand cards with 10 GbE SFP+ (fiber) cards. Fiber ports do not exist in the base configuration for X5-2. You must re-image Oracle Database Appliance X5-2 after you replace the PCIe cards. After you replace the cards, Oracle Database Appliance auto-detects the network configuration changes.

**▲ Caution:**

If you replace the InfiniBand interconnect cards on Oracle Database Appliance X5-2, then you disable the Oracle Database Appliance in-memory fault tolerance feature. Also, interconnect bandwidth is reduced from 40 GB to 10 GB. If you have Oracle RAC databases, then you may experience slower intercommunication speeds, depending on the system workload.

In the following figure, callouts 1 and 2 show how to cable the interconnect between Node 1 and Node 0 using the green and yellow copper ports (onboard ports `net0` and `net1`) to use a fiber public network. Note that the illustration shows the rear panel of an Oracle Database Appliance X4-2. The rear panel of the Oracle Database Appliance X5-2 is slightly different, but the interconnect cabling is the same.

**Figure 3-3 Interconnects When Using Fiber Connections to the Public Network on Oracle Database Appliance Models X5-2**

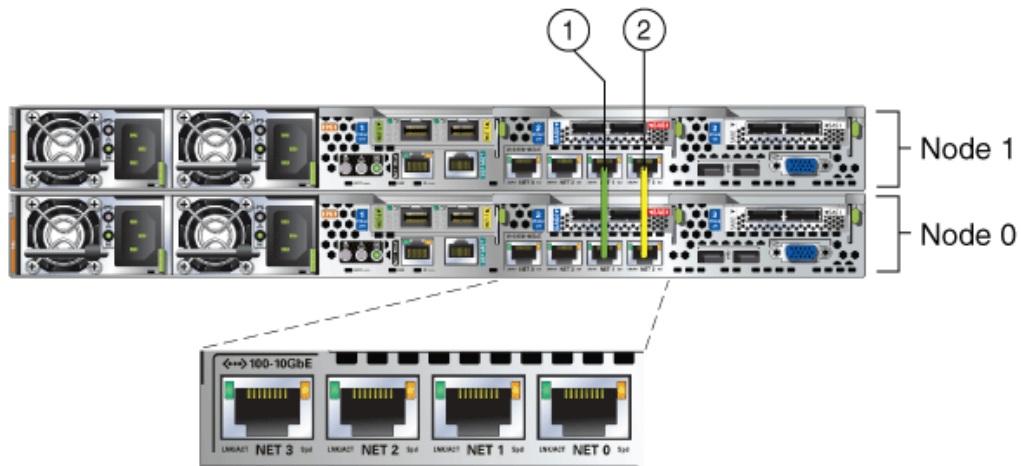

The following sections show the cabling options for 10 GbE SFP+ PCI cards.

### Fiber Cables

For optical cables, you must purchase either Short Range (SR) or Long Range (LR) SFP+ transceivers for each of the network ports, and then plug in the appropriate optical cable. Currently, Oracle sells both the SR and LR SFP+ transceivers. In addition to these transceivers, you must purchase the appropriate LC-LC terminated fiber optic cables from a third-party vendor.

Name	Oracle Sun Part Number
10 GbE Transceiver SR (SFP+)	X2129A-N
10 GbE Transceiver LR (SFP+)	X5562A-Z

### Copper Cables

You can purchase the following copper cables from Oracle Sun. These cables have built-in SFP+ connectors:

Name	Length	Oracle Sun Part Number
TwinAx 1m	1m	X2130-1M
TwinAx 3m	3 m	X2130-3M
TwinAx 5m	5m	X2130-5M

## Attaching a Storage Expansion Shelf to Oracle Database Appliance

Review these topics to install and cable a storage expansion shelf for Oracle Database Appliance.

Topics:

- [About Attaching and Cabling Storage Shelves](#)  
Review these options and best practices for adding storage shelves for Oracle Database Appliance X3-2, X4-2 and X5-2.
- [Installing and Cabling a Storage Expansion Shelf](#)  
Use this procedure to install and cable a storage expansion shelf for Oracle Database Appliance

## About Attaching and Cabling Storage Shelves

Review these options and best practices for adding storage shelves for Oracle Database Appliance X3-2, X4-2 and X5-2.

### Storage Shelf Options for Oracle Database Appliance X3-2, X4-2 and X5-2

Oracle Database Appliance models X3-2, X4-2, and X5-2 can be shipped with one or two storage shelves. You can obtain the second shelf at a later time to double your storage capacity.

If you originally deployed Oracle Database Appliance with one storage shelf, then you can add a storage expansion shelf at any time without having to shut down your databases or applications.

### Best Practice Guidelines for Adding Storage Expansion Shelves

Oracle recommends that you add a storage expansion shelf when you have relatively little activity on your databases. When the system discovers the new storage, Oracle ASM automatically rebalances the disk groups. The rebalance operation may degrade database performance until the operation completes.

#### **Caution:**

Review cabling instructions to ensure that you have carried out cabling correctly. Incorrect connections can cause data loss when adding a storage expansion shelf to Oracle Database Appliance with existing databases.

Do not attach cables to Ethernet ports in the I/O modules labeled "SERVICE ONLY" when cabling the system. These ports are intended for use by service engineers only.

## Installing and Cabling a Storage Expansion Shelf

Use this procedure to install and cable a storage expansion shelf for Oracle Database Appliance

1. Place the storage expansion shelf below your Oracle Database Appliance, if possible, or else close enough to connect the provided cables.

The storage expansion shelf normally sits at the bottom of Oracle Database Appliance, beneath the storage shelf. However, because racks should always be provisioned from the bottom up, that space may be unavailable. In that case, to avoid re-rack mounting the entire system, you can position the storage expansion shelf above the server nodes, or in a different, but adjacent, rack.

2. Install the extension storage shelf in exactly the same manner as the original storage shelf.
3. Use the figures in this topic to assist you to cable the storage expansion shelf for your Oracle Database Appliance model.

 **Caution:**

Incorrect connections can cause data loss when adding a storage expansion shelf to Oracle Database Appliance with existing databases.

4. Attach the supplied power cords. Refer to the section "Attaching Power Cords and Initializing Components" to obtain information and see figures showing how to attach power cords.

### Figures Showing How to Cable a Storage Expansion Shelf

The following figure shows you how to insert the required cables into the storage expansion shelf of Oracle Database Appliance. The cables for the two nodes and the original storage shelf are included in the illustration for reference.

The cables are color-coded. Match the colors of the labels at the ends of each cable with the colored line shown in the following illustration. Also match the cable colors to the background colors of the socket identification labels.

You can also use the callouts in the diagrams and the callout table that follows the diagrams to identify the cables and ports. Because all cables with the same terminations are interchangeable, you can ignore the color coding.

 **Note:**

The back panel of each node contains three PCIe generation 3 terminal slots, with two sockets in each slot. The PCIe slots are labeled **X PCIe3**, where **X** is the PCIe slot number. Review the callout table that follows the figures for more information.

**Figure 3-4 Cables for Storage Expansion Shelf on Oracle Database Appliance X5-2**

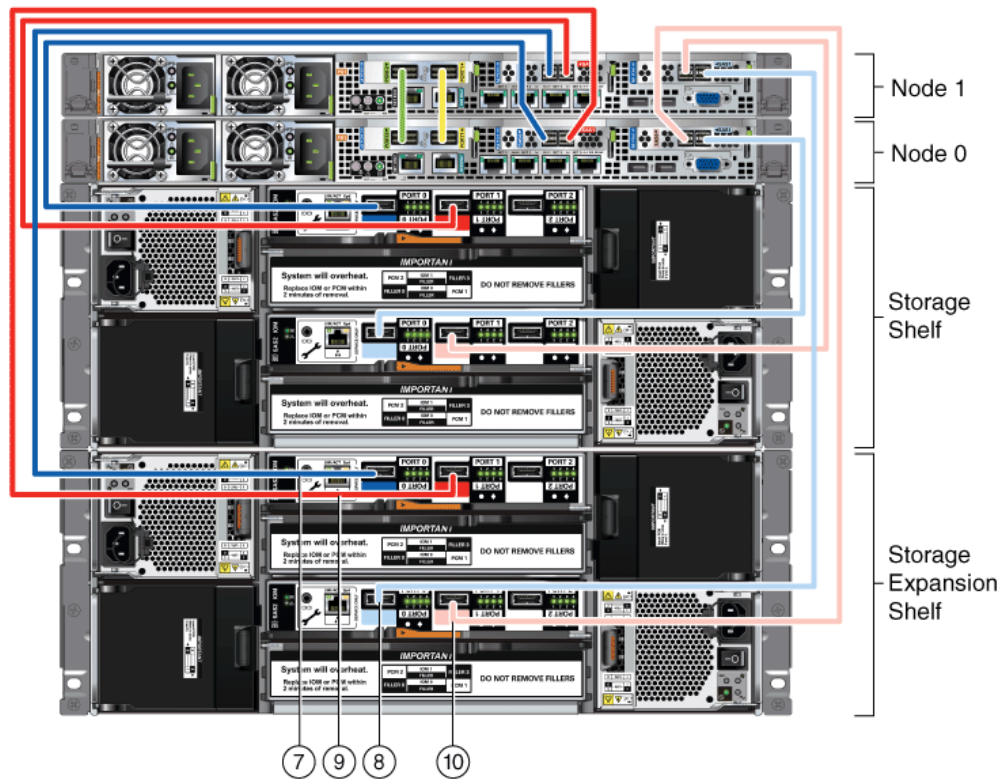

The cables identified with callout numbers in the preceding figures are included with each shipped Oracle Database Appliance storage expansion shelf. These cables are all black, but have colored labels at each end that match the references to cable colors in the text and the label colors on the back panels.

**Table 3-3 Description of Callouts for Cabling Oracle Database Appliance Storage Expansion Shelf**

Callout Number	Description
7	Dark blue SAS cable: <ul style="list-style-type: none"> <li>From: Node 1, PCIe slot 2, SAS0</li> <li>To: Storage expansion shelf, top I/O port 0</li> </ul>
8	Light blue SAS cable: <ul style="list-style-type: none"> <li>From: Node 1, PCIe slot 3, SAS1</li> <li>To: Storage expansion shelf, bottom I/O port 0</li> </ul>
9	Dark red SAS cable: <ul style="list-style-type: none"> <li>From: Node 0, PCIe slot 2, SAS1</li> <li>To: Storage expansion shelf, top I/O port 1</li> </ul>
10	Light red SAS cable: <ul style="list-style-type: none"> <li>From: Node 0, PCIe slot 3, SAS0</li> <li>To: Storage expansion shelf, bottom I/O port 1</li> </ul>

**Caution:**

Do not attach cables to Ethernet ports in the I/O modules labeled "SERVICE ONLY" when cabling the system. These ports are intended for use by service engineers only.

**See Also:**

[Attaching Power Cords and Initializing Components](#)

To review information about installing optional components for Oracle Database Appliance, see the section "Optional Component Installation" in Chapter 4 of *Oracle Database Appliance Owner's Guide*.

## Attaching Peripheral Devices

Complete this task if you have direct access to Oracle Database Appliance and you intend to use a locally connected monitor, keyboard and mouse.

Oracle Database Appliance is not equipped with human-computer interface devices, such as a monitor or keyboard. If you want to log in locally, instead of through a network, then you must attach interface devices.

Attach a monitor to the graphics card port, and attach a keyboard and a mouse to the USB ports. Refer to the figure and table to identify the ports.

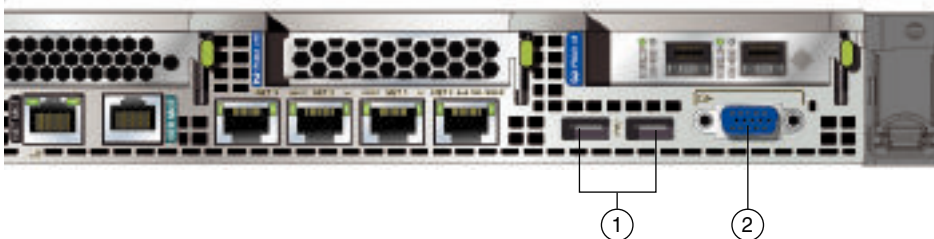

In the figure, callout 1 identifies the ports for the keyboard and mouse. Callout 2 identifies the monitor port.

**Table 3-4 Peripheral Device Connections for Oracle Database Appliance**

Callout Number	Description
1	USB ports for the keyboard and mouse
2	Graphics card port for the monitor

## Attaching Power Cords and Initializing Components

Attach power cords for Oracle Database Appliance.

### **Caution:**

Before plugging in the power cords, ensure that the electrical outlets providing the power are grounded.

If you use only a single AC circuit, then connect both power cords for each component to that circuit. If you want to maintain N+1 power supply redundancy, then use two separate AC circuits. Connect one power cord from each AC circuit into each component.

For more information about cabling with the supplied Cable Management Arm, refer to *Oracle Database Appliance Owner's Guide*.

## Powering On Oracle Database Appliance the First Time

Use this procedure to power on Oracle Database Appliance.

Before starting to power on the appliance, make sure that all of the required power cables are attached to both Oracle Database Appliance nodes, and to all storage shelves, if they are included with your appliance.

### **Note:**

After you connect power cords, the green SP OK light-emitting diode (LED) lights blink for a few minutes, and then turn to steady ON. The cooling fans also may turn on. However, these events do not indicate that the system is started. You must complete all of the steps in this section to turn on the appliance properly. Read through the entire section to understand the sequence required for initial system startup.

1. Power on the storage shelves. If attached, switch each storage shelf storage power supply On/Off switch to the On position.

Each storage shelf has two power switches on the rear panel. One switch is on the right side, and one switch is on the left side. Turn on both power switches.

The storage disks begin to initialize, which can take several minutes.

2. Check the Green SP OK LEDs on the storage shelves and the server nodes to see if they are fully initialized. When they are all fully initialized, push the recessed power button on each node to turn it on.



 **Note:**

The fully-initialized state is indicated by the green SP OK LEDs staying steadily lit. If any of the green LED lights on the server nodes and on any attached storage nodes are still blinking, then wait for them to complete their initialization steps. Do not power on the server nodes (Node 0 and Node 1) until the storage shelves are fully initialized.

Refer to the figures and to the following callout table to identify the power button and the system initialization status indicator lights:

**Table 3-5 Description of Callouts for Powering On Oracle Database Appliance**

Callout	Function
1	SP OK LED light, located on the front panel of each node.
2	Recessed On/Off power button, which is located on the front panel for each node (Node 0 and Node 1). Push this button only once. Do not repeatedly push the power button.
3	Green Power OK LED for a node, located on the node's front panel. These lights must be in the steady ON position (Green light does not blink) before you log on to the system.

**Figure 3-5 Front of Oracle Database Appliance Models X3-2, X4-2, and X5-2: Power Panel**

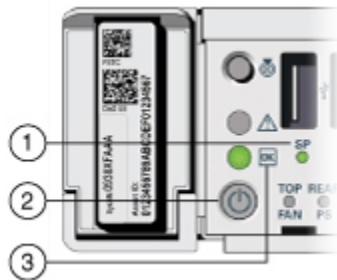

**Figure 3-6 Front of Oracle Database Appliance Version 1: Power Panel**

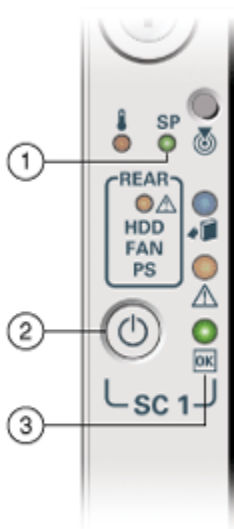

3. Wait for Oracle Database Appliance to complete startup.

 **Note:**

Do not repeatedly push the power buttons. Startup can take several minutes to complete.

Oracle Database Appliance is ready for use when the green Power OK LEDs (callout 3) on the front of both system nodes remain steadily on.

4. For X5-2, X4-2, and X3-2 models of Oracle Database Appliance: To ensure that the storage and interconnect is properly configured, log into the console as `root` and run the following `oakcli validate` command:

```
/opt/oracle/oak/bin/oakcli validate -c storagetopology
```

## Defining Your Public Network Interface Type

Understand how you can define the public network interface type before deploying the appliance.

For Oracle Database Appliance X5-2 and X6-2 High-Availability non-InfiniBand deployments, the system by default, configures the fiber cards as public network, and copper cards as private network.

Optionally, before provisioning the appliance, if you want to switch the public network to copper, then follow these steps:

1. Log into both nodes as `root`.
2. Configure the network.

For bare metal deployments, run the command on both nodes:

```
# /opt/oracle/dcs/bin/odacli configure-network -publicNet copper
```

For Virtualized Platform deployments, run the command on both nodes:

```
# oakcli configure network -publicNet copper
```

For Oracle Database Appliance X4-2, the system by default, configures the copper cards as public network, and fiber cards as private network.

Optionally, before provisioning the appliance, if you want to switch the public network to fiber, then follow these steps:

1. Log into both nodes as `root`.
2. Configure the network.

For bare metal deployments, run the command on both nodes:

```
# /opt/oracle/dcs/bin/odacli configure-network -publicNet fiber
```

For Virtualized Platform deployments, run the command on both nodes:

```
# oakcli configure network -publicNet fiber
```

## Configuring Oracle Integrated Lights Out Manager

Configure Oracle Integrated Lights Out Manager (Oracle ILOM) to manage Oracle Database Appliance independent of the operating system.

Oracle ILOM provides alternate ways to restart and troubleshoot Oracle Database Appliance.

You must set up the following items first to configure Oracle ILOM:

- A name and IP address
- A password to replace the default Oracle ILOM password
- Access to a management network, using an assigned netmask
- An Ethernet cable connected from the NET MGT port to the management network

In the default configuration, Dynamic Host Configuration Protocol (DHCP) is enabled in Oracle ILOM and the DHCP server automatically assigns network settings. To determine the IP address or host name assigned by the DHCP server, use the network tools provided with the DHCP server.

If you do not use DHCP, then use the custom option in Oracle Database Appliance Manager Configurator to assign IP addresses and host names to Oracle ILOM when you deploy your database.

 **Note:**

If you have not enabled DHCP, then you must complete Oracle Database Appliance configuration to access Oracle ILOM.

To connect to the Oracle ILOM, use one of the following two methods:

1. Log in using a web interface by completing these steps:
  - a. Using a client system's browser, enter the IP address or host name assigned by DHCP into the browser address field and press **Enter**.
  - b. At the login page, enter the default user name, `root` and the default password, `changeme`.

The Oracle ILOM web interface appears.

2. Log in using a command-line interface (CLI) by completing these steps:
  - a. Using a client system, establish a secure shell (SSH) connection by entering the following on the command line:

```
ssh -l root sp_ip_address
```

where *sp\_ip\_address* is the IP address assigned by DHCP.

- b. Enter the default user name, `root`, and the default password, `changeme`.

The Oracle ILOM CLI prompt appears.

### Troubleshooting the ILOM Configuration

If the ILOM is not working, then ensure that the ILOM NIC is enabled and that `ipv4` is enabled.

You can configure the ILOM with the IPMI tool or through the BIOS. The following describes how to use the IPMI tool:

1. Open the IPMI tool.
2. Go to `SP/network` and verify that the port is enabled:

```
cd /SP/network
```

3. If the port is not enabled, then enable the port.

```
set state=enabled
```

4. In `SP/network`, verify that `ipv4` is enabled.
  5. If `ipv6` is enabled, then disable `ipv6` and enable `ipv4`

```
# ipmitool -I open sunoem cli "set /SP/network/ipv6 state=disabled"  
# ipmitool -I open sunoem cli "set /SP/network/ipv4 state=enabled"
```

# 4

## Provisioning Oracle Database Appliance Baremetal System

Understand the process to configure Oracle Database Appliance baremetal system.

The Web Console is the preferred method of deploying your bare metal platform configuration. The Web Console provides all of the fields necessary to provision Oracle Database Appliance, including configuring the system, network, database, and Oracle Auto Service Request (Oracle ASR). If you prefer to use the command-line interface, you must create a JSON file to configure the deployment options.

- [Plumbing the Network](#)  
Plumb the Oracle Database Appliance network with the public internet protocol (IP) information assigned to a node, to enable provisioning of the Oracle Database Appliance software.
- [Verifying Cabling and Network Connections](#)  
After powering on Oracle Database Appliance, verify that the network connections are set up correctly.
- [Downloading Oracle Database Appliance Software](#)  
Download Oracle Database Appliance software and copy to a temporary location before applying updates to your appliance.
- [Installing Oracle Database Appliance Software](#)  
Install Oracle Database Appliance software, before creating the appliance.
- [Creating the Appliance](#)  
Create the appliance using the Web Console.

### Plumbing the Network

Plumb the Oracle Database Appliance network with the public internet protocol (IP) information assigned to a node, to enable provisioning of the Oracle Database Appliance software.

1. Connect to Oracle ILOM remote console, then log into Oracle Database Appliance as root.
2. Run the command `configure-firstnet` on **both** nodes.

```
# /opt/oracle/dcs/bin/odacli configure-firstnet
Using bonding public interface (yes/no) [yes]:
Select the Interface to configure the network on (btbond1) [btbond1]:
Configure DHCP on btbond1 (yes/no) [no]:
INFO: You have chosen Static configuration
Use VLAN on btbond1 (yes/no) [no]:
```

3. Complete the network configuration as prompted and configure the public network interface. Also provide the netmask and gateway IP address.

You use this network connection to transfer the software to the server node.

#### Example 4-1 Example of a Bonded Configuration

For a bonded configuration, answer `yes` to using a bonding public interface and configure the first network to use a `btbond1` interface without configuring DHCP.

```
# /opt/oracle/dcs/bin/odacli configure-firstnet
Select the Interface to configure the network on (btbond1 btbond2
sfbond1) [btbond1]:
Configure DHCP on btbond1 (yes/no) [no]:
INFO: You have chosen Static configuration
Use VLAN on btbond1 (yes/no) [no]:
Enter the IP address to configure : 10.209.13.109
Enter the Netmask address to configure : 255.255.252.0
Enter the Gateway address to configure[10.209.12.1] :
INFO: Plumbing the IPs now
INFO: Restarting the network
Shutting down interface btbond1: [ OK ]
Shutting down interface btbond2: [ OK ]
Shutting down interface p3p1: [ OK ]
Shutting down interface p3p2: [ OK ]
Shutting down interface sfbond1: [ OK ]
Shutting down loopback interface: [ OK ]
Bringing up loopback interface: [ OK ]
Bringing up interface btbond1: Determining if ip address 10.209.13.109 is
already in use for device btbond1...
[ OK ]
Bringing up interface btbond2: [ OK ]
Bringing up interface sfbond1: [ OK ]
```

#### Example 4-2 Example of a Non-Bonded Configuration

To create a non-bonded configuration and disable VLAN capabilities, answer `no` to using a bonding public interface.

```
# /opt/oracle/dcs/bin/odacli configure-firstnet
Using bonding public interface (yes/no) [yes]: no
INFO: Breaking the bonding on btbond1
INFO: remove bonding module: rmmod bonding
INFO: remove slave setup in /etc/sysconfig/network-scripts/ifcfg-em2
INFO: remove slave setup in /etc/sysconfig/network-scripts/ifcfg-em3
INFO: Restarting the network
Shutting down interface em1: [ OK ]
Shutting down loopback interface: [ OK ]
Bringing up loopback interface: [ OK ]
Bringing up interface em1: [ OK ]
Bringing up interface em2: [ OK ]
Bringing up interface em3: [ OK ]
INFO: Restarting the DCS agent
initdcsagent stop/waiting
initdcsagent start/running, process 57629
Select the Interface to configure the network on (em2 em3) [em2]:
Configure DHCP on em2 (yes/no) [no]:
INFO: You have chosen Static configuration
```

```
Enter the IP address to configure : 10.31.102.101
Enter the Netmask address to configure : 255.255.240.0
Enter the Gateway address to configure[10.31.96.1] :
INFO: Plumbing the IPs now
INFO: Restarting the network
Shutting down interface em1: [ OK ]
Shutting down interface em2: [ OK ]
Shutting down interface em3: [ OK ]
Shutting down loopback interface: [ OK ]
Bringing up loopback interface: [ OK ]
Bringing up interface em1: [ OK ]
Bringing up interface em2: Determining if ip address 10.31.102.101 is
already in use for device em2...
[ OK ]
Bringing up interface em3: [ OK ]
```

### Example 4-3 Example of Configuring VLAN

```
# /opt/oracle/dcs/bin/odacli configure-firstnet
Using bonding public interface (yes/no) [yes]:
Select the Interface to configure the network on (btbond1) [btbond1]:
Configure DHCP on btbond1 (yes/no) [no]:
INFO: You have chosen Static configuration
Use VLAN on btbond1 (yes/no) [no]:yes
Configure VLAN on btbond1, input VLAN ID [2 - 4094] 122
INFO: using network interface btbond1.122
Enter the IP address to configure : 192.0.2.24
Enter the Netmask address to configure : 192.0.2.24
Enter the Gateway address to configure[192.0.2.24] :
INFO: Restarting the network
Shutting down interface btbond1: [ OK ]
Shutting down interface em1: [ OK ]
Shutting down interface plp1: [ OK ]
Shutting down interface plp2: [ OK ]
Shutting down loopback interface: [ OK ]
Bringing up loopback interface: [ OK ]
Bringing up interface btbond1:
Determining if ip address 192.0.2.24 is already in use for device
btbond1... [ OK ]
Bringing up interface em1: [ OK ]
Bringing up interface plp1:
Determining if ip address 192.0.2.24 is already in use for device
plp1... [ OK ]
Bringing up interface plp2:
Determining if ip address 192.0.2.24 is already in use for device plp2...
[ OK ]
Bringing up interface btbond1.122:
Determining if ip address 192.0.2.24 is already in use for device
btbond1.122... [ OK ]
INFO: Restarting the DCS agent
initdcsagent stop/waiting
initdcsagent start/running, process 32104
```

## Verifying Cabling and Network Connections

After powering on Oracle Database Appliance, verify that the network connections are set up correctly.

Run the validation scripts only on Oracle Database Appliance HA models.

1. Log into the Oracle Database Appliance console and access the server node with user name as `root` and password `welcome1`.
2. Run validation scripts on both nodes, to verify cabling. For example:

```
# /opt/oracle/dcs/bin/odacli validate-storagetopology
INFO : ODA Topology Verification
INFO : Running on Node0
INFO : Check hardware type
SUCCESS : Type of hardware found : X7-2
INFO : Check for Environment(Bare Metal or Virtual Machine)
SUCCESS : Type of environment found : Bare Metal
INFO : Check number of Controllers
SUCCESS : Number of ahci controller found : 1
SUCCESS : Number of External SCSI controllers found : 2
INFO : Check for Controllers correct PCIe slot address
SUCCESS : Internal RAID controller :
SUCCESS : External LSI SAS controller 0 : 3b:00.0
SUCCESS : External LSI SAS controller 1 : 5e:00.0
INFO : Check if JBOD powered on
SUCCESS : 2JBOD : Powered-on
INFO : Check for correct number of EBODS(2 or 4)
SUCCESS : EBOD found : 4
INFO : Check for External Controller 0
SUCCESS : Cable check for port 0 on controller 0
SUCCESS : Cable check for port 1 on controller 0
SUCCESS : Overall Cable check for controller 0
INFO : Check for External Controller 1
SUCCESS : Cable check for port 0 on controller 1
SUCCESS : Cable check for port 1 on controller 1
SUCCESS : Overall Cable check for controller 1
INFO : Check for overall status of cable validation on Node0
SUCCESS : Overall Cable Validation on Node0
SUCCESS : JBOD0 Nickname set correctly
SUCCESS : JBOD1 Nickname set correctly
```

3. If there is a storage expansion shelf connected to the appliance, then power it on. Run the `storagetopology` command on both nodes to make sure the cabling is correct. For example:

```
# /opt/oracle/dcs/bin/odacli validate-storagetopology
INFO : ODA Topology Verification
INFO : Running on Node0
INFO : Check hardware type
SUCCESS : Type of hardware found : X7-2
INFO : Check for Environment(Bare Metal or Virtual Machine)
SUCCESS : Type of environment found : Bare Metal
```





```
Duplex: Full
Port: Direct Attach Copper
PHYAD: 1
Transceiver: internal
Auto-negotiation: on
Current message level: 0x00000000 (0)
Link detected: yes
```

## Downloading Oracle Database Appliance Software

Download Oracle Database Appliance software and copy to a temporary location before applying updates to your appliance.

1. Download the software files from My Oracle Support to a temporary location on an external client. Refer to the release notes for details about the software for the latest release.

For example, download the Oracle Database Appliance GI Clone for ODACLI/DCS stack (patch 27604593) and Oracle Database Appliance RDBMS Clone for ODACLI/DCS stack (patch 27604558) for 18.7:

```
p27604593_187000_Linux-x86-64.zip
p27604558_187000_Linux-x86-64.zip
```

2. Unzip the software — it contains README.html and one or more zip files for the patch.

```
unzip p27604593_187000_Linux-x86-64.zip
unzip p27604558_187000_Linux-x86-64.zip
```

The GI and RDBMS Clone files for release 18.7 are extracted.

```
odacli-dcs-18.7.0.0.0-190830-GI-18.7.0.0.zip
odacli-dcs-18.7.0.0.0-190830-DB-18.0.0.0.zip
```

3. Copy the software files from the external client to Oracle Database Appliance. Use the `scp` or `sftp` protocol to copy the bundle.

Example using `scp` command:

```
scp software_file root@oda_host:/tmp
```

Example using `sftp` command:

```
sftp root@oda_host
```

Enter the `root` password, and then copy the file.

```
put software_file
```

For example, for release 18.7:

```
put odacli-dcs-18.7.0.0.0-190830-GI-18.7.0.0.zip
put odacli-dcs-18.7.0.0.0-190830-DB-18.0.0.0.zip
```

The GI and RDBMS Clone files are copied to the temporary location on the appliance. You can update the repository, and create the appliance, as explained in the next topic.

## Installing Oracle Database Appliance Software

Install Oracle Database Appliance software, before creating the appliance.

1. Verify the current system version by running the following command on **both** nodes:

```
# /opt/oracle/dcs/bin/odacli describe-component -v
```

2. Update the repository with Oracle Grid Infrastructure and Database software.

```
[root@odal opt]# /opt/oracle/dcs/bin/odacli update-repository -f /tmp/
GI_clone_file,/tmp/DB_clone_file
```

For example, for release 18.7

```
# /opt/oracle/dcs/bin/odacli update-repository -f /tmp/odacli-
dcs-18.7.0.0.0-190830-GI-18.7.0.0.zip,/tmp/odacli-dcs-18.7.0.0.0-190830-
DB-18.0.0.0.zip
```

3. Confirm that the repository update is successful:

```
[root@odal opt]# /opt/oracle/dcs/bin/odacli describe-job -i job_ID
```

4. Delete the software zip files from the temporary location on the appliance to save space:

```
[root@odal opt]# rm software_file
rm: remove regular file software_file? y
```

You have now updated the repository with the Oracle Database Appliance software, and can create your appliance, as described in the next topic.

## Creating the Appliance

Create the appliance using the Web Console.

Ensure that ports 7070 and 7093 on the network between Oracle Database Appliance and the client machine, are open.

1. Navigate to the Web Console. You are prompted to set the password for the `oda-admin` user.

`https://ODA-host-ip-address:7093/mgmt/index.html`

2. Log into the Web Console with the new password.

When you launch the Web Console on an unconfigured appliance, the Appliance page notifies you that the appliance is not configured and provides a link to the pages needed to configure and create the appliance.

3. Click **Create Appliance**.
4. In the Create Appliance page, if you want to create the appliance from a saved configuration, click **Browse**, and select the JSON file. The information from the saved configuration file is loaded. You can retain or edit the fields. Otherwise, manually, provide the values to create the appliance.
5. In the System Information section, specify the values as follows.

- a. **Host Name:** Enter the host name.

The host name can contain alphanumeric characters and dashes (-), but cannot start with a number or dash (-) or end with dash (-). Do not exceed 30 characters.

- b. **Domain Name:** Enter the domain name.

- c. **Region:** Select the region of the world where the Oracle Database Appliance is located.

- d. **Time Zone:** Select the time zone where the Oracle Database Appliance is located.

- e. (Optional) **DNS Servers:** Enter addresses for one or more DNS servers.

- f. (Optional) **NTP Servers:** Enter addresses for one or more NTP servers.

- g. **Diskgroup Redundancy:** If there are up to two disk groups, then you can select the disk group redundancy as Normal or Flex. A quorum disk must exist, if you want to select Flex redundancy. If there are more than two disk groups, then you can select the redundancy as Normal, High, or Flex. Select **Normal**, **High**, or **Flex**, as per your deployment requirement.

The Flex parameter defines the disk group redundancy. For Oracle ASM storage, when you select Flex as the disk group redundancy, you can set the database redundancy to either Mirror or High. You can set the disk group redundancy only during appliance creation. The database redundancy can be set anytime you create the database.

The redundancy level is for DATA, RECO, and FLASH. If you select High redundancy, then DATA, RECO, and FLASH are all High redundancy. If the system has less than five (5) NVMe storage devices, then redundancy is automatically set to Normal.

If the system has more than three (3) NVMe storage devices, then you can choose the Flex redundancy option.

The redundancy level for REDO can be set to Flex, but the file groups created in REDO are all High redundancy.

- h. **Data Storage Percentage:** Enter a whole number between 10 and 90 to define the percentage of storage reserved for DATA, the remainder is

reserved for RECO. For example, if you enter 80, then 80% of the storage for DATA and 20% for RECO.

- i. **System Password and Confirm Password:** Enter the system password in both fields.

The system password is the password set for UNIX and `root` users. The password must begin with an alpha character and cannot contain quotation marks. Do not exceed 30 characters.

6. In the Network Information section, configure the primary client access network, virtual networks, and an Oracle Integrated Lights Out Manager (ILOM) network. You are only required to configure the client access network. The ILOM configuration is optional if you already configured the ILOM for the appliance and you do not need to make changes.

Specify the following, depending on whether it is a single-node or multi-node Oracle Database Appliance deployment:

- a. **Client Access Network Host Name:** For Node0, enter the host name for the primary client access network.
  - b. **Client Access Network IP Address:** For Node0, enter the IP address for the primary client access network.
  - c. **VIP Name for Node0:** Enter the name of the virtual IP network for Node0.
  - d. **VIP IP Address for Node0:** Enter the virtual IP address that resides on Node0 and is shared between the nodes.
  - e. **VIP Name for Node1:** Enter the name of the virtual IP network for Node0.
  - f. **VIP IP Address for Node1:** Enter the virtual IP address that resides on Node1 and is shared between the nodes.
  - g. (Optional) **ILOM Host Name:** Enter the name of the Oracle ILOM host for Node0 and Node1.
  - h. (Optional) **ILOM Network IP Address:** Enter the IP address for the ILOM for Node0 and Node1.
  - i. (Optional) **ILOM Network Subnet Mask:** Enter the subnet mask address for the ILOM.
  - j. (Optional) **ILOM Network Gateway:** Enter the gateway address for the ILOM.
  - k. **Client Access Network Subnet Mask:** Enter the subnet mask address for the primary client access network.
  - l. **Client Access Network Gateway:** Enter the gateway address for the primary client access network.
  - m. **Client Access Network Interface:** Enter the interface for the primary client access network.
7. Determine how you want to configure your users and groups and whether or not you want to allow operating system role separation:
    - Two users with six groups: Customize Users and Groups, select **No**. Allow OS Role Separation, select **Yes**. This is the default configuration.
    - Two customized users with six customized groups: Customize Users and Groups, select **Yes**. Allow OS Role Separation, select **Yes**.

- Single user with two groups: Customize Users and Groups, select **No**. Allow OS Role Separation, select **No**
  - Single user with six groups: Customize Users and Groups, select **Yes**. Allow OS Role Separation, select **No**. SAP deployments use this configuration.
8. Do you want to create an initial database? Select **Yes** and go to Step 9 or select **No** and go to Step 10.
  9. Enter the following information to configure an initial database:
    - a. **DB Name:** Enter a name for the database.

The name must contain alphanumeric characters and cannot exceed 8 characters.
    - b. (Optional) **DB Unique Name:** Enter a globally unique name for the database.

Databases with the same DB Name within the same domain (for example, copies of a database created for reporting or a physical standby) must have a different DB Unique Name that is unique within the enterprise. The name must contain alphanumeric, underscore ( \_ ), dollar ( \$ ), and pound ( # ) characters, but must begin with an alphabetic character. No other special characters are permitted in a database name. The unique name cannot exceed 30 characters.
    - c. **DB Version:** Select a database bundle patch number.
    - d. **CDB:** Select **Yes** or **No** to specify whether or not you want a Container Database (CDB).
    - e. **PDB Name:** Enter a name for the pluggable database (PDB).

The name must begin with an alphanumeric character. The following characters are valid: alphanumeric characters, and underscore ( \_ ).
    - f. **PDB Admin User:** Enter an Admin user name for the pluggable database (PDB).
    - g. **Database Edition:** Select the Oracle Database edition, either Standard Edition and Enterprise Edition. Your license determines which database edition you are eligible to create in the appliance.
    - h. **Password:** Provide a password for the database.
    - i. **Deployment:** Select a deployment type from the list. The options are RAC, RAC-One, or SI (single instance database). If you select a single instance database, then select the node for the SI database deployment.

If you select a single instance database, then you have the option to create the database on either Node0 or Node1. The default is Node0.
    - j. **Shape:** Select a database shape from the list.
    - k. In the **Database Class** field, select a database class from the drop-down list. If an option is not available in the list, it is not supported for the database edition on the Oracle Database Appliance or the version that you selected. The default is OLTP.
    - l. In the **Storage** field, select **ACFS** or **ASM** from the drop-down list. The default is Oracle ASM.

Only Oracle 18c, 12.2, and 12.1 databases can use Oracle ASM storage. Oracle Database 11.2 is only supported on Oracle ACFS.

- m. If you select the storage as **ASM**, and the Database Version is 12.2 or later, and you specified the disk group redundancy as **Flex**, then you can select the **Database Redundancy** value as **Mirror** or **High**.

You can choose Oracle ACFS storage for all database versions, but if you select Oracle ACFS storage, then you cannot specify the database redundancy. If your disk group redundancy is Flex, and you choose Oracle ACFS storage for the database, then the database redundancy is set to Mirror.

- n. **Data Files on Flash Storage:** Select **Yes** or **No**.

This option is only available if the HA system has HDD storage drives.

- o. **Configure EM Express:** Select **Yes** or **No**.

Select **Yes** to configure the Oracle Enterprise Manager Database Express (EM Express) console for Oracle Database 12.2.1.0 or 12.1.0.2 or the Database Control Console for Oracle Database 11.2.0.4. Selecting Yes enables you to use the console to manage the database.

- p. **Character set:** Select a character set.
- q. **National Characterset:** Select a national character set.
- r. **Language:** Select the database language.
- s. **Territory:** Select a territory or location from the list.

10. (Optional) Configure and enable Oracle ASR on the ASR page.

You can configure and enable Oracle Auto Service Request (Oracle ASR) now or later:

- To not enable Oracle ASR during deployment, select **No** and click **Submit**. After deployment, you can configure an internal Oracle ASR or register with an external Oracle ASR Manager from either the Web Console or command-line interface.
  - Internal Oracle ASR: choose to configure Oracle ASR Manager on Oracle Database Appliance or use Oracle ASR Manager configured on another server in the same network as your appliance.
  - External Oracle ASR: If you already have Oracle ASR Manager configured elsewhere, you can register Oracle Database Appliance with your existing Oracle ASR Manager.
- To enable Oracle ASR, select **Yes** and complete the fields:
  - a. **ASR User Name:** Enter the e-mail address associated with the My Oracle Support account under which the server is registered.
  - b. **Password:** Enter the password associated with the My Oracle Support account under which the server is registered.
  - c. **SNMP Version:** Select **V2** or **V3**. V3 is the default and recommended version.
  - d. **HTTP Proxy used for Upload to ASR:** Select **Yes** or **No**.
  - e. **Proxy Server Name:** If you are using a proxy for upload, enter the proxy server name.
  - f. **Proxy Port:** If you are using a proxy for upload, enter the proxy port.
  - g. **(Optional) HTTP Proxy Requires Authentication:** If you are using a proxy for upload, select **Yes** if you require authentication. If you do not require authentication, select **No**.

- h. Proxy User Name:** If you are using a proxy for upload, enter the proxy user name.
  - i. (Optional) Proxy Password:** If you are using a proxy for upload and require authentication, enter the proxy password.
- 11.** Click **Submit**. When prompted, click **Yes** to confirm that you want to start the job to deploy the appliance.
  - 12.** Verify that the appliance is deployed. Run the `odacli describe-appliance` command. For multi-node deployments, run the command on both nodes. For example:

```
[root@oda1 opt]# /opt/oracle/dcs/bin/odacli describe-appliance
Appliance Information
-----
ID: 618dfa94-35ff-4f81-8aab-e93810bc2c45
Platform: Odav6
Data Disk Count: 48
CPU Core Count: 36
Created: July 24, 2018 1:55:57 PM MDT
System Information
-----
Name: odax7-2ha
Domain Name: example.com
Time Zone: America/Denver
DB Edition: EE
DNS Servers: 192.1.1.1 192.1.1.2
NTP Servers: 192.1.1.3 192.1.1.4
Disk Group Information
-----
DG Name Redundancy Percentage
-----
Data High 80
Reco High 20
Redo High 100
Flash High 100
```

The job to create the appliance takes time to complete. To monitor the job progress, click the **Activity** tab. Click the job number to view the tasks. After deployment, the `root` and database users `SYS`, `SYSTEM`, and `PDBADMIN` are set to the system password. The `oracle` and `grid` passwords are set to the default password. Change these passwords to comply with your user security protocols.



# Provisioning an Oracle Database Appliance Virtualized Platform

Oracle Database Appliance provides you with the option to reimage the system and configure the appliance as a virtualized platform.

## Note:

You can provision Standard Edition and Standard Edition 2 Oracle Real Application Cluster (Oracle RAC) databases, but you must use Oracle VM virtualization on a virtualized platform on Oracle Database Appliance and follow the single socket per server licensing restriction. The single socket restriction means that you can use a maximum of 18 cores per server, in multiples of two. You can use the remaining cores for applications.

- [Determining if the System is Configured with a Virtualized OS Image](#)  
Before deploying a Virtualized Platform on Oracle Database Appliance, determine if the system has the Virtualized OS ISO image.
- [Setting Up the Virtualized Platform](#)  
Set up the `dom0` virtualized operating system on both nodes and configure the initial public network.
- [Installing Virtualized Platform Software and Deploying the Appliance](#)  
Deploy the `ODA_BASE` domain for a virtualized platform and then deploy the appliance.
- [Creating a Configuration File for a Virtualized Platform](#)  
If you want to use the Configurator to create a virtualized platform configuration file before your Oracle Database Appliance system is delivered, then review these topics.

## Determining if the System is Configured with a Virtualized OS Image

Before deploying a Virtualized Platform on Oracle Database Appliance, determine if the system has the Virtualized OS ISO image.

Oracle Database Appliance ships from the factory with a bare metal ISO image installed. To use the virtualization features, you must reimage the system with the Virtualized OS ISO image.

A bare metal system uses the `odacli` and `odaadmcli` commands. A virtualized system uses the `oakcli` commands.

Perform the following steps to determine if you need to re-image Oracle Database Appliance and install the Virtualization Platform ISO image:

1. Log in as `root`.

2. To verify that a system is a virtualized platform, enter the command `oakcli show env_hw`. For example:

```
# oakcli show env_hw
VM-ODA_BASE ODA X7-2-HA
```

The system is configured as a virtualized system when the command is valid and returns output that is prefixed with the string `VM-ODA_BASE`. For example, the output of the command shows that the platform is configured with a virtual machine environment (`VM-ODA_BASE`) and identifies the hardware platform.

If the system is configured as a bare metal platform, then the command `oakcli show env_hw` is invalid.

## Setting Up the Virtualized Platform

Set up the `dom0` virtualized operating system on both nodes and configure the initial public network.

You must provision the virtualized operating system image on both nodes, either at the same time, or one after another.

1. Download the Oracle Database Appliance 18.7 Virtualized OS ISO Image.
  - a. From an external client machine, log on to My Oracle Support.
  - b. Locate the patch for the Oracle Database Appliance Virtualized OS ISO Image. Refer to the *Oracle Database Appliance Release Notes* for the patch number.
  - c. Select the patch version for release 18.7.
  - d. Click **Download** to download the zip file onto your external client. Unzip the zip file onto external client to get the ISO image.
2. Open a browser and connect to Oracle Integrated Lights Out Manager (ILOM) on Node0 as root.

The Summary home page appears.

3. Launch the Remote Console.
  - a. Expand **Remote Control** in the left navigation.
  - b. Click the **Redirection** tab.
  - c. Click **Launch Remote Console**.

The state of the system determines what appears on the Console page.

4. Add the Virtualized OS ISO Image.
  - a. Click the **Devices** tab, then select **CD-ROM**.  
A file browser on the local client opens.
  - b. Browse to the Oracle Database Appliance Virtualized OS ISO Image, highlight the image, then click **Open**.
5. Configure the CD-ROM as the next boot device.
  - a. Expand **Host Management** in the left menu of the ILOM Remote Console tab.
  - b. Click **Host Control**.

- c. Select **CDROM** from the Next Boot Device menu, then click **Save**.
6. Power cycle the system.
  - a. Click **Power Control** in the **Host Management** menu.
  - b. Select **Power Cycle**.

When the node comes back after the power cycle, reimaging starts automatically.

It can take a couple of hours to reimage. The Running Post-Install scripts page is a static page and might give the impression that the reimaging process is not progressing. The post-install process during reimaging will wait until the synchronization between the partitions of the two mirrored local hard disks is complete, which can take 15 to 20 minutes to complete.

To check the progress of resynchronization, press the ALT-F2 key combination to open a second console and enter the following command:

```
# cat /proc/mdstat
```

When the resynchronization is complete, reimaging is completed and the machine restarts.

7. Repeat Steps 1 through 6 for Node1.

Reimaging is node-specific. You must reimage both nodes. You can reimage both nodes at the same time.

8. Verify that the host name in the Console is `oak1` for Node0 and `oak2` for Node1.

If the host name is something other than `oak1` or `oak2`, then reboot the node. You might need to reboot more than once.

Once the image is completed on **both** nodes, you will see the screen with `oak1` for Node0 (`sc0`).

**Note:** Ensure that you provide the node numbers for both nodes during the reboot. Specify node number 0 for the first node and node number 1 for the second node.

9. Use the command `oakcli configure firstnet` to configure a local or global network. For local network, run the command on both nodes. For global network, run the command on any one node.

The global configuration sets the initial public network for both the nodes on Oracle Database Appliance, enabling you to download the deployment software onto the appliance.

```
# oakcli configure firstnet
```

```
Configure the network for the node(s)(local, global) [global]:
```

```
The network configuration for both nodes:
```

```
Domain Name: example.com
```

```
DNS Server(s): Primary Dns Server: 192.0.2.18
```

```
                Secondary Dns Server: 192.0.2.19
```

```
                Tertiary Dns Server:
```

```
Node Name Host Name
```

```
0 node1
```

```
1 node2
```

```
Choose the network interface to configure (net1, net2) [net1]:
```

```
Configure DHCP on net1 (yes/no) [no]:
```

```
INFO: You have chosen static configuration on net1
```

```
Enter the IP address for net1 on Node 0: 192.0.2.18
```

```

Enter the IP address for net1 on Node 1: 192.0.2.19
Netmask for net1: 255.255.252.0
Gateway Address for net1 [192.0.2.18]:
INFO: Plumbing the IPs now on Node 0 ...
INFO: Restarting the network now on Node 0 ...
Determining if ip address 192.0.2.18 is already in use for device
net1...
::::::::::::::::::::::::::::::::::::::::::
INFO: Plumbing the IPs now on Node 1 ...
INFO: Restarting the network now on Node 1 ...
::::::::::::::::::::::::::::::::::::::::::

```

10. Check the IP addresses to the nodes with the command `oakcli show firstnet`. For example:

```

# oakcli show firstnet
Node: 0
Host Name: odax7-2ha-brm06-a-n0
Domain Name: example.com
Network BootProto IP Address Subnet Gateway
-----
net1 static 192.0.2.18 255.255.252.0 192.0.2.1
-----
Node: 1
Host Name: odax7-2ha-brm06-a-n1
Domain Name: example.com
Network BootProto IP Address Subnet Gateway
-----
net1 static 192.0.2.18 255.255.252.0 192.0.2.1
-----
DNS Address: 192.0.2.18,192.0.2.19

```

## Installing Virtualized Platform Software and Deploying the Appliance

Deploy the ODA\_BASE domain for a virtualized platform and then deploy the appliance.

1. Download and copy the template files to the `/OVS` directory on `dom0` (Node 0).
  - a. From an external client machine, log on to My Oracle Support and download the Oracle Database Appliance VM Template.
  - b. Select the latest version from the menu.
  - c. Click **Download** for each of the zip files to download the current Oracle Database Appliance template onto your external client.
2. Copy the template files to the `/OVS` directory on Node 0 (`oak1-dom0`).

- a. Use either a Secure Copy (scp) command or a USB storage device to copy the ODA\_BASE template from the external client to dom0 on Node 0. Use the /OVS directory on Node 0 (test0-dom0) as the target location.

 **Note:**

If you use a USB drive to transfer the file, then format it first as FAT32, ext3, or ext4. NTFS file formats are not supported.

- b. Log into dom0 as root on Node 0 of Oracle Database Appliance. Remain logged in to dom0 while you complete the remaining steps in this task.
- c. From the /OVS directory, use the unzip command to extract the zip files.

```
unzip p16186172_18.7.0.0.0_Linux-x86-64_1of4.zip
unzip p16186172_18.7.0.0.0_Linux-x86-64_2of4.zip
unzip p16186172_18.7.0.0.0_Linux-x86-64_3of4.zip
unzip p16186172_18.7.0.0.0_Linux-x86-64_4of4.zip
```

When extracted, you will have the following files: oda\_base\_18.7.0.0.0.gz01, oda\_base\_18.7.0.0.0.gz02, oda\_base\_18.7.0.0.0.gz03, and oda\_base\_18.7.0.0.0.gz04.

- d. Use the cat command to concatenate the files into a single file.

The file name is determined by the version. Ensure that you use the correct file name from the download. Do not change the file name.

```
cat oda_base_18.7.0.0.0.gz01 oda_base_18.7.0.0.0.gz02
oda_base_18.7.0.0.0.gz03 oda_base_18.7.0.0.0.gz04 >
oda_base_18.7.0.0.0.tar.gz
```

Make a note of the file name and location. You need to specify the following in the next step: /OVS/oda\_base\_18.7.0.0.0.tar.gz

3. (Optional) Define the virtual local area network (VLAN) and deploy ODA\_BASE from the /opt/oracle/oak/bin/ directory. When prompted, enter the absolute path and file name for the template file that you created in the previous step, core licensing, and the base domain memory allocation.

The deploy oda\_base option automatically deploys ODA\_BASE on both nodes.

Values, such as the number of available CPU cores and default memory, differ between Oracle Database Appliance Virtualized Platform hardware platforms. The following excerpt is an example that creates a VLAN named v1200 with a vlanID of 200 using the bond0 interface. The example defines 20 CPU cores, which means that 20 CPU cores are licensed on each node for a total of 40 CPU cores, and uses the default memory.

```
# /opt/oracle/oak/bin/oakcli create vlan v1200 -vlanid 200 -if bond0
Created vlan v1200
```

```
# /opt/oracle/oak/bin/oakcli deploy oda_base
Enter the template location: /OVS/oda_base_18.7.tar.gz
```

```

Core Licensing Options:
 1. 2 CPU Cores
 2. 4 CPU Cores
 3. 6 CPU Cores
 4. 8 CPU Cores
 5. 10 CPU Cores
 6. 12 CPU Cores
 7. 14 CPU Cores
 8. 16 CPU Cores
 9. 18 CPU Cores
10. 20 CPU Cores
11. 22 CPU Cores
12. 24 CPU Cores
<continued ...>
  Selection[1 .. 37] (default 74 CPU Cores): 10
INFO: Using the 20 cores
  DA base domain memory in GB(min 16, max 244)[default 244]: 244
INFO: Using default memory size i.e. 244 GB
Additional vlan networks to be assigned to oda_base ? (y/n) [n]:
INFO: Deployment in non local mode
INFO: Verifying active cores on local node
INFO: Verified active cores on local node
INFO: Verifying active cores on remote node
INFO: Verified active cores on remote node
INFO: Running the command to copy the template /OVS/
oda_base_18.7.tar.gz to remote node 1

oda_base_18.7.tar.gz    100% 7475MB 62.8MB/s   01:59
INFO: Spawned the process 17728 in the deployment node 0
INFO: Spawned the process 17729 in the node 1
INFO: Validating LSI HBA PCI Cards on node 0
INFO: Validating LSI HBA PCI Cards on node 0
INFO: Validating LSI HBA PCI Cards on node 1
INFO: Validating LSI HBA PCI Cards on node 1
INFO: Deployment in local mode
INFO: Deployment in local mode
templateBuild-2017-02-14-23-51/swap.img
templateBuild-2017-02-14-23-51/swap.img
templateBuild-2017-02-14-23-51/System.img
templateBuild-2017-02-14-23-51/System.img
templateBuild-2017-02-14-23-51/u01.img
templateBuild-2017-02-14-23-51/u01.img
INFO: Extracted the image files on node 1
INFO: The VM Configuration data is written to /OVS/Repositories/
odabaseRepo/VirtualMachines/oakDom1/vm.cfg file
INFO: Running /sbin/losetup /dev/loop0 /OVS/Repositories/odabaseRepo/
VirtualMachines/oakDom1/System.img command to mount the image file
INFO: Mount is successfully completed on /dev/loop0
INFO: Extracted the image files on node 0
INFO: Validated dom0 and odabase version
INFO: Making change to the /OVS/Repositories/odabaseRepo/
VirtualMachines/oakDom1
/tmpmnt/boot/grub/grub.conf file
INFO: Assigning IP to the second node...
INFO: The VM Configuration data is written to /OVS/Repositories/

```

```

odabaseRepo/VirtualMachines/oakDom1/vm.cfg file
INFO: Running /sbin/losetup /dev/loop0 /OVS/Repositories/odabaseRepo/
VirtualMachines/oakDom1/System.img command to mount the image file
INFO: Mount is successfully completed on /dev/loop0
INFO: Created oda base pool
INFO: Validated dom0 and odabase version
INFO: Making change to the /OVS/Repositories/odabaseRepo/
VirtualMachines/oakDom1
/tmpmnt/boot/grub/grub.conf file
INFO: Assigning IP to the first node...
INFO: Created oda base pool
INFO: Starting ODA Base...
INFO: Starting ODA Base...
Using config file "/OVS/Repositories/odabaseRepo/VirtualMachines/
oakDom1/vm.cfg"
.
Started domain oakDom1 (id=1)
INFO: Storing the odabase configuration information
Using config file "/OVS/Repositories/odabaseRepo/VirtualMachines/
oakDom1/vm.cfg"
Started domain oakDom1 (id=1)
INFO: Storing the odabase configuration information
#

```

The ODA\_BASE setup is complete.

4. Verify that your deployment of ODA\_BASE is valid and that ODA\_BASE is configured.

- Run the command `xm list` to confirm that ODA\_BASE is configured. When properly deployed, `oakDom1` appears in the output with your configured memory and vcpus.

```

# xm list
Name                               ID   Mem VCPUs
State   Time(s)
Domain-0                               0  4096   40
r----- 482672.4
oakDom1                               2 32768    4   -
b---- 132134.6

```

- Run the command `oakcli show oda_base`

```

# /opt/oracle/oak/bin/oakcli show oda_base
ODA base domain
ODA base CPU cores      :2
ODA base domain memory :32
ODA base template       :/OVS/oda_base_18.7.tar.gz
ODA base vlans          :[ 'priv1', 'net1' ]
ODA base current status :Running

```

5. (Optional) After deployment of `oda_base`, if you want to change CPU or memory of `ODA_BASE`, run `oakcli configure oda_base`:

```
# oakcli configure oda_base
Core Licensing Options:
  1. 2 CPU Cores
  2. 4 CPU Cores
  3. 6 CPU Cores
  4. 8 CPU Cores
  5. 10 CPU Cores
  6. 12 CPU Cores
  7. 14 CPU Cores
  8. 16 CPU Cores
Current CPU Cores :10
Selection[1 .. 8](default 16 CPU Cores) : 5
ODA base domain memory in GB(min 16, max 244)(Current Memory
160G)[default 160] : 100
Additional vlan networks to be assigned to oda_base ? (y/n) [n]: n
Vlan network to be removed from oda_base ? (y/n) [n]: n
```

To ensure your changes are reflected in the system, run the `oakcli restart oda_base` command.

6. Connect to `ODA_BASE` using `vncviewer` or `vncsession` using the `dom0` host name and port 5900 (`test0-dom0:5900`).
7. Use the `oakcli configure firstnet` to configure an initial public network on the first node (Node 0) to complete the `ODA_BASE` deployment.
- ssh to 192.168.16.27 from `test0-dom0`
  - Log in as `root` user.
  - Run the command `oakcli configure firstnet` from the `/opt/oracle/oak/oakcli` directory. Enter the `ODA_BASE` (Node 0) network information.

The command uses an interactive script and prompts you for the information needed to configure the network. Enter values based on your environment requirements.

When prompted to configure the network nodes, select the `local` option that configures the network on the logged-on node.

Configure `net1` as the network interface.

```
# /opt/oracle/oak/bin/oakcli configure firstnet
Select the Interface to configure the network on (eth1 eth2) [eth1]:
Configure DHCP on eth1 (yes/no) [no]:
INFO: You have chosen Static configuration
Enter the IP address to configure : ip_odabase_node
Enter the Netmask address to configure : ip_netmask
Enter the Gateway address to configure : ip_gateway
```

The IP address is plumbed and the network is restarted on the local node.



8. Check the firmware versions on both nodes with the following command:

```
[root@test0 ~]# oakcli show version -detail
```

9. If all the component versions are not either up-to-date or at a higher version, then unpack the patch bundle on both nodes.

```
[root@test0 tmp]# oakcli unpack -package patch_number
```

10. Use the `oakcli update` command to update the server components such as disks, ILOM, BIOS, and firmware.

```
[root@test0 tmp]# oakcli update -patch release_number --server
INFO: DB, ASM, Clusterware may be stopped during the patch if required
INFO: Both Nodes may get rebooted automatically during the patch if
required
Do you want to continue: [Y/N]?: y
INFO: User has confirmed for the reboot
INFO: Patch bundle must be unpacked on the second Node also before
applying the patch
Did you unpack the patch bundle on the second Node? : [Y/N]? : y
INFO: All the VMs except the oda_base will be shutdown forcefully if
needed
Do you want to continue : [Y/N]? : y
INFO: Running pre-install scripts
INFO: Running prepatching on node 0
INFO: Running prepatching on node 1
oakcli update -patch release_number --storage
[root@test0 ~]# oakcli update -patch release_number --storage
WARNING: OAKD is not running in foreground mode.
INFO: Cannot determine if VMs or shared repos are running.
INFO: Patching may not shutdown all VMs/repos before patching
Do you want to continue: [Y/N]?: y
INFO: Proceeding with patching...
INFO: DB, ASM, Clusterware may be stopped during the patch if required
INFO: Both Nodes may get rebooted automatically during the patch if
required
Do you want to continue: [Y/N]?: y
INFO: User has confirmed for the reboot
Please enter the 'root' password :
Please re-enter the 'root' password:
INFO: Setting up the SSH
.....Completed
INFO: Running pre-install scripts
.....Completed
INFO: Running prepatching on node 0
INFO: Running prepatching on node 1
INFO: Completed pre-install scripts
INFO: Shared Storage components need to be patched
INFO: Patching storage on node 192.168.16.28
```

11. After the firmware patching is completed, confirm that all appropriate components are updated

```
# oakcli show version -detail
```

12. Deploy the Oracle Grid Infrastructure and Oracle Database software on the appliance.

- Start the X server, and navigate to the `/opt/oracle/oak/bin` directory and execute the command `oakcli deploy` to start the Oracle Database Appliance Manager Configurator.

```
# startx
# /opt/oracle/oak/bin/oakcli deploy
The Oracle Appliance Manager Welcome window is displayed.
```

13. Click **Next** on the Oracle Appliance Manager Welcome window.

14. Complete the Configuration Type.

- If you want to use a configuration file that you created earlier with this version of the Configurator, then click **Browse** and locate the file on your client. Click **Next**.
- If you do not have a configuration file, select the **Custom** configuration type and select the hardware model from the menu. Click **Next**.

15. Enter or review the configuration details for your system, network, and database information. For details, see “Running the Standalone Oracle Database Appliance Configurator”.
16. On the Summary page, review your configuration options and deploy your configuration.

- a. (Optional) Click **Save** to save the configuration file.
- b. Click **Install** to deploy the configuration.

The deployment can take an hour to complete. Monitor the install progress. When the deployment is complete, go to the next step.

17. Validate the deployment by executing the `oakcli show version -detail` command on ODA\_BASE (Node 0).

```
# /opt/oracle/oak/bin/oakcli show version -detail
```

The output displays the System Version, Component Name, Installed Version, and Supported Version for each of the components.

18. If you configured ASR, then verify the deployment, by running the following the command on **Node0**:

```
# oakcli test asr
```

## Creating a Configuration File for a Virtualized Platform

If you want to use the Configurator to create a virtualized platform configuration file before your Oracle Database Appliance system is delivered, then review these topics.

- [About the Standalone Oracle Database Appliance Configurator](#)  
Use the standalone Oracle Database Appliance Configurator to create an Oracle Database Appliance Virtualized Platform offline deployment plan and validate your network settings before the actual deployment.
- [Running the Standalone Oracle Database Appliance Configurator](#)  
Download and run the standalone Oracle Database Appliance Configurator to create a configuration file for the Oracle Database Appliance Virtualization Platform.

## About the Standalone Oracle Database Appliance Configurator

Use the standalone Oracle Database Appliance Configurator to create an Oracle Database Appliance Virtualized Platform offline deployment plan and validate your network settings before the actual deployment.

If you prefer to configure your system at the time you deploy the virtualized platform, then you can wait and use the online Configurator that is part of virtualization image for Oracle Database Appliance.

The standalone Oracle Appliance Manager Configurator is a Java-based tool that enables you to generate your virtualized platform deployment plan and validate your network settings before the actual deployment. If you want to use this tool before deployment, then you must download and run the Configurator on a local client system. The local client can be a Linux, UNIX, MAC, or Windows system, and must be on the same network as the appliance.

The Configurator provides two types of configuration: Typical and Custom. The **Typical** configuration is recommended in most cases. Choose the **Custom** configuration option if you want to configure additional or alternate network interfaces, or if you want to override the default values for one or more of the following:

- Database block size, language, territory, backup file location, or disk redundancy level for the DATA and RECO disk groups
- Oracle Integrated Lights Out Manager (Oracle ILOM) server.
- Oracle Auto Service Request (Oracle ASR) configuration. You can configure Oracle ASR after deployment.
- Oracle Cloud File System mount point and file system size. Configure a Cloud FS if you want a non-database file location accessible by both nodes.
- Network Time Protocol service server.

To see the default values for your version of Oracle Database Appliance software before choosing the **Typical** or **Custom** option, run the Configurator using the **Custom** option.

Oracle recommends that you use the Network Validation page in the Configurator to test your network settings. To test the network settings, you must run the Configurator on a client server that is connected to same network subnet that you intend to use for Oracle Database Appliance. If you do not do this, then the validation fails, regardless of whether or not you have completed required configuration.

At the end of an offline Configurator session, you can save your deployment plan in a configuration file. You can use the Configurator to edit your settings. When you are ready to deploy Oracle Database Appliance, copy this configuration file to the appliance, and run the online Oracle Appliance Manager Configurator to import and deploy your saved plan. You can also print the file's content and use the printout to review your configuration entries for deployment planning purposes and as a checklist for setting up your external network configuration.

## Running the Standalone Oracle Database Appliance Configurator

Download and run the standalone Oracle Database Appliance Configurator to create a configuration file for the Oracle Database Appliance Virtualization Platform.

In most cases, Oracle recommends that you select the typical configuration. Select the custom option if you want to configure additional or alternate network interfaces, or if you want to override the default values. To see the default values for your version of Oracle Database Appliance software before choosing the **Typical** or **Custom** option, run the Configurator using the **Custom** option.

The steps described here enable you to create a typical virtualized platform configuration file.

1. Download the standalone Oracle Database Appliance Manager Configurator software to a client.
  - a. Go to the following URL <http://www.oracle.com/technetwork/database/database-appliance/overview/index.html>
  - b. Click the **Downloads** tab.
  - c. Review the License Agreement, then select **Accept License Agreement**.
  - d. Download the latest version of the Oracle Database Appliance Manager Configurator zip file to a client.
  - e. Extract the files from the zip.

2. Start the Configurator using the command `config.bat` on a Windows client, or the command `./config.sh` on a Linux or UNIX client. When the Oracle Database Appliance Manager Welcome page appears, click **Next**.
3. Select the **Custom** configuration type and select the hardware model from the menu. Click **Next**.

The **Browse** option is not useful during the initial run, because there are no configuration files to load. If you have an existing configuration file created with this version of the Configurator that you want to load and edit, then click **Browse** and locate the file on your client.

4. On the System Information page, provide the system name, and select the correct value from the lists for your region and time zone. In the **New Root Password** and **New Root Password (confirm)** fields, enter a new password for the `root` user. Click **Next**.

The password is encrypted in the configuration file. It is temporarily decrypted to reset the password during deployment.

5. On the Network Information page, provide your domain name, DNS server addresses, public and VIP addresses for your two nodes, SCAN name and addresses, and netmask and Gateway addresses. Click **Next**.

As you enter data on this page, some fields are automatically filled with values derived from earlier entries. For example, if the address that you provide for the Node 0 public IP address is 192.0.2.18, then the default node addresses generate as follows:

- Node 0 public IP address: 192.0.2.18
- Node 1 public IP address: 192.0.2.19
- Node 0 virtual IP (VIP) address: 192.0.2.20

- Node 1 virtual IP (VIP) address: 192.0.2.21
  - SCAN addresses (two addresses resolving to the SCAN VIP name): 192.0.2.22, 192.0.2.23
6. (Optional) On the Database Information page, determine if you want to create an initial database.
- If you do not want to configure an initial database, then click **Next**. Go to Step 7.
  - If you want to configure an initial database, select the check box for **Create Initial Database**, complete the fields, then click **Next**.

To configure an initial database, provide the following database details:

- **Database Name.** Enter a name for the database.
  - **Is Container Database.** The default is **false**. If you leave the default value, then the Configurator builds a non-container database.
  - **Database Type.** The default type is **OLTP**. You can also select **DSS**, or select **In-Memory**.
  - **Database Class.** Select the database class that you want to deploy. Not all options are available for all models of Oracle Database Appliance; the default class is **odb-06**.
  - **Database Language.** The default language is **AMERICAN**
  - **Database Deployment.** Select one of the following, where **RAC** is the default:
    - Oracle RAC
    - Oracle RAC One Node
    - Oracle Database Enterprise Edition (no Oracle RAC)
  - **Data File Size (GB).** If you indicate that you want to build a container database, then provide a database data file size in the final field on this page. (This field does not accept input unless the **Is Container Database selection** is **True**.)
  - **Data Files on Flash Storage.** This option is only available if you have configured for High-Capacity storage.
7. On the Network Validation page, validate your network settings and save the validation output in a file, or bypass the validation step, then click **Next** to go to the next step.

The following options are available:

- Click **Run Validations** to perform network validation.

 **Note:**

Oracle recommends that you validate your network before you use the configuration file to configure an appliance. However, you must run Oracle Database Appliance Manager Configurator on a server attached to the network subnet that is configured for your appliance. If you do not do this, then the validation fails, regardless of whether or not you have completed required configuration.

- Click **Save Validation Output** to save the validation output. If the validation fails, it is useful to save the output to review with your network administrator later.
- Select **Skip Network Validations** to by-pass the validation step. If the network validation fails, and you want to continue with the configuration, then select this option.

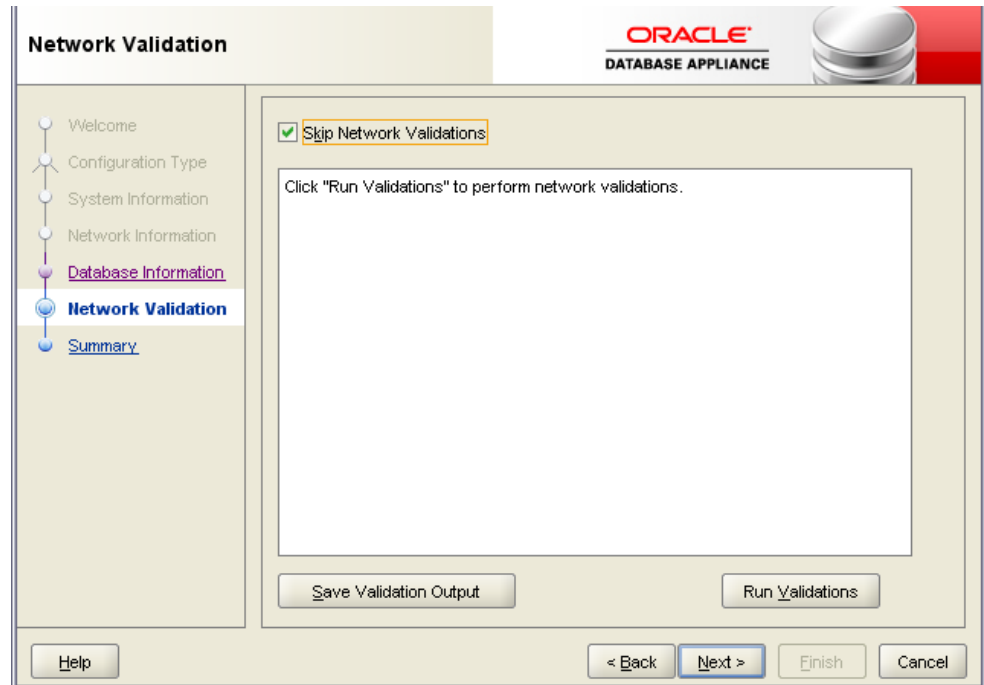

8. On the Summary page, review the configuration options that you have selected. Click **Save** to save the configuration file. Click **Finish**.

Note the name and location of the configuration file. You can copy this configuration file to your Oracle Database Appliance for deployment. If you need to make corrections before deployment, then rerun the standalone Oracle Database Appliance Manager Configurator, load your configuration file, make the changes, and save the file again.

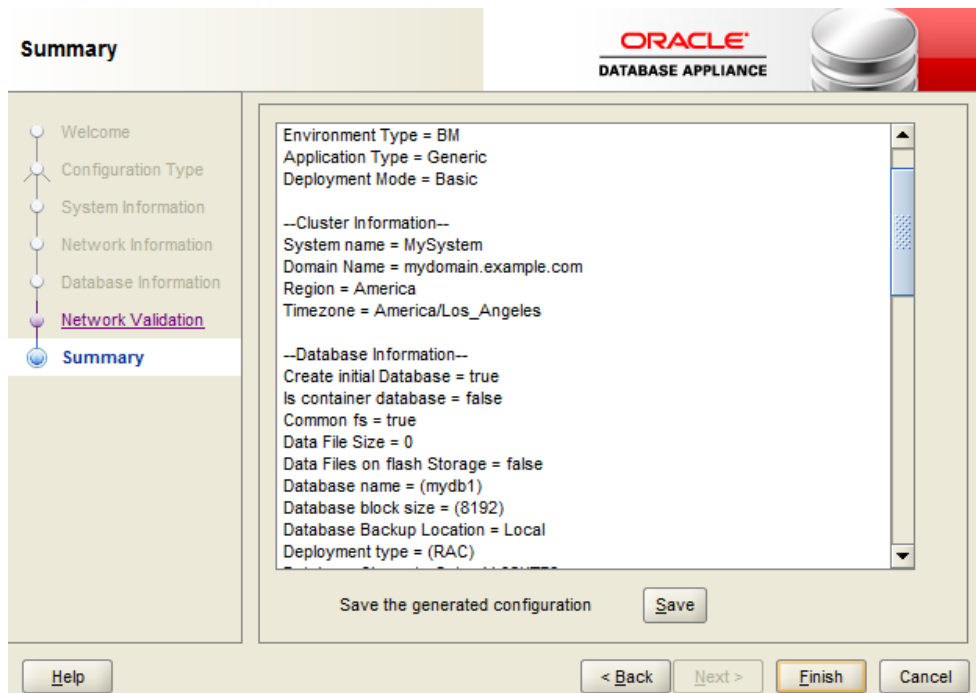

If you are running the Configurator on Oracle Database Appliance, and you have completed the preliminary steps to configure your initial network and install the software or deploy ODA\_BASE, then you can click **Install** to deploy the configuration.



# 6

## Oracle Database Appliance Postinstallation Tasks

Complete these administrative tasks after you have deployed software, but before the system is operational.

- [Configuring CPU Core Count](#)  
Oracle Database Appliance is delivered with all cores on each server enabled. Follow this procedure to reduce the number of cores, if required.
- [Securing Oracle ILOM Service Processors](#)  
Change the Oracle ILOM default password after completing Oracle Database Appliance deployment.
- [Changing Oracle Database Appliance Passwords](#)  
After deploying your appliance, ensure that you change the following passwords for securing your system.

### Configuring CPU Core Count

Oracle Database Appliance is delivered with all cores on each server enabled. Follow this procedure to reduce the number of cores, if required.

1. To reduce the number of cores, run the following command on Node 0 only:  
Set the cores in multiples of 2, for example, 12:

```
[root@oak1 opt]# /opt/oracle/dcs/bin/odacli update-cpucore --cores 12
```

2. Check if the job completed successfully:

```
[root@oak1 opt]# /opt/oracle/dcs/bin/odacli describe-job -i job_ID
```

3. Verify that the core count is updated on both nodes:

```
[root@oak1 opt]# /opt/oracle/dcs/bin/odacli describe-cpucore
```

### Securing Oracle ILOM Service Processors

Change the Oracle ILOM default password after completing Oracle Database Appliance deployment.

Do not change the default password until after you have completed software deployment on the Oracle Database Appliance.

### Changing Oracle ILOM Password from the Console

1. In the Oracle ILOM console, from the **Administration** menu, select **User Management**, and then navigate to the **User Accounts** subtab.
2. Select **root** user and click **Edit**.
3. Change the `root` user password.

### Changing Oracle ILOM Password Using CLI Commands

1. Connect to the Oracle ILOM console through SSH:

```
# ssh -l root SP-ipaddr
```

2. Set the new password:

```
# set /SP/users/root password=new_password
Changing password for user /SP/users/root/password...
Enter new password again: *****
New password was successfully set for user /SP/users/root
```

## Changing Oracle Database Appliance Passwords

After deploying your appliance, ensure that you change the following passwords for securing your system.

### Changing the Oracle Installation Owner Passwords

During deployment, the `root` and database users `SYS`, `SYSTEM` and `PDBADMIN` are set to the system password. After deployment, the `oracle` and `grid` passwords are also set to the system password. Change the passwords to comply with your enterprise user security protocols. Refer to the *Oracle Database Appliance Security Guide* and *Oracle Database Security Guide* for information about the required configuration and best practices to secure database systems.

### Changing the `oda-admin` User Password through the Command-Line

1. Log in to the appliance as `root`.
2. Run the `odacli-adm set-credential` command to reset the password. Enter the new password when prompted.

```
# odacli-adm set-credential --password --username oda-admin
Agent password: new password
```

### Changing the `oda-admin` User Password through the Web Console

1. Log into the Web Console using the user name `oda-admin`.
2. Click **About**, then **User Settings** in the upper right corner of the Web Console.
3. Enter the password in the Password field and the Password Confirmation field, then click **Submit**.

A confirmation message is displayed.

4. Click **About**, then click **Sign Out**.
5. Log back into the Web Console with the new password.

 **Note:**

The `oda-admin` password expiration period is 90 days.

---

# Patching Oracle Database Appliance

To keep Oracle Database Appliance running with the latest software, check for and apply Oracle Database Appliance patch bundles when they are released.

- [About Patching Oracle Database Appliance](#)  
Use the Oracle Database Appliance Patch Bundle to patch your appliance.
- [About Patching Pre-Checks](#)  
Patching pre-checks are designed to detect problems that might be encountered during patching and flag those issues.
- [Running Patching Pre-Checks Before Applying Patches](#)  
After updating the repository with patches, use the pre-checks to reduce potential update problems, and then apply patches.
- [Patching Oracle Database Appliance Bare Metal Systems Using the Command-Line](#)  
Follow these steps to apply patches to your Oracle Database Appliance bare metal deployment and existing Oracle Database homes, using CLI commands.
- [Patching Oracle Database Appliance Using the Web Console](#)  
Upload the Oracle Database Appliance Server Patch to the patch repository, deploy the patch bundle using the Web Console, and then update the DCS agent and components using CLI commands.
- [Updating Oracle Database Appliance Repository with Database Clone Files Using the CLI](#)  
Follow these steps to update the Oracle Database Appliance repository with Oracle Database clone files for the latest release using CLI commands.
- [Patching Existing Database Homes to the Latest Release Using the Web Console](#)  
Use the Web Console to patch database homes to the latest release.
- [Patching Oracle Database Appliance Virtualized Platform](#)  
Follow these steps to apply patches to Oracle Database Appliance OAKCLI Virtualized Platform using CLI commands.
- [Patching Trace File Analyzer \(TFA\) Collector](#)  
Trace File Analyzer (TFA) Collector simplifies diagnostic data collection on Oracle Cluster Ready Services (CRS), Oracle Grid Infrastructure, and Oracle RAC systems.
- [Verifying That HAIP is Disabled After Patching to Release 18.7](#)  
After patching to Oracle Database Appliance release 18.7, verify that High-Availability IP (HAIP) is disabled.
- [Applying Additional Patches and Updates](#)  
Configure additional patch repositories and patch your operating system and databases to ensure that your deployment has the latest updates and security fixes.
- [About Upgrading to a Different Database Home](#)  
Understand how to upgrade to a different database home using either the Web Console or `odacli` commands.

# About Patching Oracle Database Appliance

Use the Oracle Database Appliance Patch Bundle to patch your appliance.

Patches offer new features and may improve the functionality of existing features.

## About Oracle Database Appliance Patch Bundles

The Oracle Database Appliance Patch Bundle contains the latest patches for DCS Admin, DCS Components, OAK, Oracle Grid Infrastructure, Oracle Database homes, enhancements, and fixes.

The Oracle Database Appliance Release Notes include information about the latest Oracle Database Appliance patch bundle and a list of component versions in the patch bundle. Oracle recommends updating the appliance with the latest Oracle Database Appliance software version to take advantage of new features, fixes, and the latest supported component versions. See the Oracle Database Appliance Release Notes for the upgrade paths.

### **Caution:**

Do not patch Oracle Database Appliance using individual patches for Oracle Grid Infrastructure or Oracle Linux. Also do not use individual infrastructure patches, such as firmware patches. You must only use Oracle Database Appliance patches. If you use patches that are not intended for Oracle Database Appliance, or if you use OPatch, or a similar patching tool, then Oracle Database Appliance inventory is not updated, and you cannot complete future patch updates. If you apply out-of-cycle Oracle Database Release Update (RU), then ensure that you follow the recommendations described in the Readme for the RU.

The patch bundle provides all relevant patches for the entire system, including the following:

- BIOS
- Hardware drivers
- Hardware Management Pack (HWM) and firmware drivers for various components
- Oracle Appliance Manager
- Oracle Linux
- Oracle VM Server
- Java Development Kit (JDK)
- Oracle Integrated Lights Out Manager (Oracle ILOM)
- Oracle Database Bundle Patch (BP), Oracle Database Patch Set Update (PSU), and Oracle Database Release Update (RU)
- Oracle Auto Service Request (Oracle ASR)
- Oracle Grid Infrastructure
- Oracle Intelligent Platform Management Interface (Oracle IPMI)

- Network Card Patches for relevant hardware models

### About Updating Oracle Linux RPMs

While not recommended, you can update some Oracle Linux RPMs for database nodes. Do not update or customize Oracle Linux kernel, Oracle Optimal Flexible Architecture, Oracle InfiniBand, or related software. Other software may be installed, updated, or customized. However, the Oracle Database Appliance update may not carry newer version dependencies of customized components. Therefore, you might be required to remove and subsequently reapply site-specific changes to successfully update Oracle Database Appliance in the future.

#### **Caution:**

For database nodes, do not update the following:

- Oracle Linux Kernel (kernel\*)
- Oracle Optimal Flexible Architecture (ofa\*)
- Oracle InfiniBand-related packages (ofed\*)

For storage, do not apply any RPM updates.

### About Using a Different Version of Java Development Kit (JDK)

Oracle Database Appliance depends on a specific version of JDK. If you want to use a different version of JDK for a specific application, then install it in a different directory and only point to it for that application.

## About Patching Pre-Checks

Patching pre-checks are designed to detect problems that might be encountered during patching and flag those issues.

The pre-checks view the state of the appliance, including the version and hardware specific upgrades, verify that the necessary conditions and checks are complete before attempting an upgrade, and identify conditions that might cause an upgrade to fail. You can avoid potential patching problems by correcting the conditions and resolving the issues before applying the patch.

The pre-checks commands are available on Oracle Database Appliance release 12.2.1.2.0 or later. Update the DCS agent to support the pre-checks commands.

#### **Note:**

Patching pre-checks are available only when patching ODA CLI stack. If you are patching and migrating from OAK CLI to ODA CLI stack for bare metal system, then follow the procedure in the topic *Patching Oracle Database Appliance Bare Metal Systems Using the Command-Line*. For patching Virtualized Platform, see the topic *Patching Oracle Database Appliance Virtualized Platform*.

## Components Verified by Patching Pre-Checks

Check	Component Verified
System patching pre-checks	<p>Checks that the agent is online on all nodes</p> <p>Checks that there is sufficient space for the update</p> <p>Validates the minimum agent version and validates the patching tag</p> <p>Confirms that a valid patch is in the repository and calculates the patch bundle md5 checksum</p>
Server patching pre-checks	<p>Confirms that Oracle Grid Infrastructure patch is installed</p> <p>Confirms that Oracle Clusterware is running on all nodes</p> <p>Performs a check for required components using <code>opatch prereq checkcomponents</code></p> <p>Analyzes the patch using <code>opatchauto</code></p> <p>Performs a patch conflict check</p> <p>Checks the available disk space</p> <p>Confirms that the yum repository directory exists</p> <p>Performs a <code>yum check</code> and <code>yum check-update</code></p> <p>Performs a test (dry run) <code>yum update</code> to check for dependencies in the RPMs</p>
DBHome patching pre-checks	<p>Confirms that the Oracle Grid Infrastructure is installed</p> <p>Confirms that Oracle Clusterware is running on all nodes</p> <p>Confirms that the Oracle Grid Infrastructure is upgraded before upgrading other components</p> <p>Validates that there is sufficient space available in local mount</p> <p>Performs a check for required components using <code>opatch prereq checkcomponents</code></p> <p>Analyzes the patch using <code>opatchauto</code></p> <p>Performs a patch conflict check and determines if a rollback of database patches is required</p>
Storage pre-checks	<p>Validates storage patch location and tag</p> <p>Validates Oracle ASM disk groups status</p>

## Running Patching Pre-Checks Before Applying Patches

After updating the repository with patches, use the pre-checks to reduce potential update problems, and then apply patches.

### Note:

Follow the procedure in this topic only when patching ODACLI stack. If you are patching and migrating from OAKCLI to ODACLI stack for bare metal system, then follow the procedure in the topic *Patching Oracle Database Appliance Bare Metal Systems Using the Command-Line*. For patching Virtualized Platform, see the topic *Patching Oracle Database Appliance Virtualized Platform*.

Before running the patching pre-checks, ensure that the `dcs-agent` is updated.

1. Run the `create-prepatchreport` command to generate a pre-check report.

```
odacli create-prepatchreport -s -v release_number
```

2. Run the `describe-prepatchreport` command to display the pre-check report.

```
odacli describe-prepatchreport -i job_ID
```

## Patching Oracle Database Appliance Bare Metal Systems Using the Command-Line

Follow these steps to apply patches to your Oracle Database Appliance bare metal deployment and existing Oracle Database homes, using CLI commands.

To patch your Oracle Database Appliance deployment and your existing database homes to the current release, you must download the Oracle Database Appliance Server Patch and update the repository. To patch your existing databases to the latest release, you do **not** need the Oracle RDBMS clone files for the release. Download Oracle RDBMS clone files for a release only if you want to create new database homes for that release.

Follow these steps to apply patches to your Oracle Database Appliance and update existing database homes:

1. Download the Oracle Database Appliance Server Patch for the ODACLI/DCS stack (patch 30217856) from My Oracle Support to a temporary location on an external client. Refer to the release notes for details about the software for the latest release.

For example, download the server patch for 18.7:

```
p30217856_187000_Linux-x86-64_1of3.zip
p30217856_187000_Linux-x86-64_2of3.zip
```



To patch your deployment to release 18.7, you need to download only the two files mentioned above. The third file `p30217856_187000_Linux-x86-64_3of3.zip` is required only if you want to patch the databases to release 11.2.0.4.190416, or 12.1.0.2.190416, or 12.2.0.1.190416, or 18.6.0.0.190416.

2. Unzip the software — it contains `README.html` and one or more zip files for the patch.

```
unzip p30217856_187000_Linux-x86-64_1of3.zip
unzip p30217856_187000_Linux-x86-64_2of3.zip
```

The zip file contains the following software files:

```
oda-sm-18.7.0.0.0-190911-server1of2.zip
oda-sm-18.7.0.0.0-190911-server2of2.zip
```

3. Copy all the software files from the external client to Oracle Database Appliance. For High-Availability deployments, copy the software files to only one node. The software files are copied to the other node during the patching process. Use the `scp` or `sftp` protocol to copy the bundle.

Example using `scp` command:

```
# scp software_file root@oda_host:/tmp
```

Example using `sftp` command:

```
# sftp root@oda_host
```

Enter the `root` password, and copy the files.

```
put software_file
```

4. Update the repository with the server software:

```
# /opt/oracle/dcs/bin/odacli update-repository -f /tmp/
software_file1,/tmp/software_file2,/tmp/software_file3
```

For example, for 18.7:

```
# /opt/oracle/dcs/bin/odacli update-repository -f /tmp/oda-
sm-18.7.0.0.0-190911-server1of2.zip,/tmp/oda-sm-18.7.0.0.0-190911-
server2of2.zip
```

5. Confirm that the repository update is successful:

```
[root@odal opt]# /opt/oracle/dcs/bin/odacli describe-job -i job_ID
```

6. Update the DCS agent:

```
[root@odal opt]# /opt/oracle/dcs/bin/odacli update-dcsagent -v
18.7.0.0.0
```

This command also updates Oracle Trace File Analyzer (TFA) and ORAchk Health Check Tool.

**7. Update DCS admin:**

```
[root@odal opt]# /opt/oracle/dcs/bin/odacli update-dcsadmin -v 18.7.0.0.0
```

**8. Update the DCS components:**

```
[root@odal opt]# /opt/oracle/dcs/bin/odacli update-dcscomponents -v 18.7.0.0.0
```

This command updates the DCS components such as Zookeeper.

**9. Apply the server update:**

```
[root@odal opt]# /opt/oracle/dcs/bin/odacli update-server -v version
```

For example, for 18.7:

```
[root@odal opt]# /opt/oracle/dcs/bin/odacli update-server -v 18.7.0.0.0
```

**Note:** If you applied the server updates, before updating the DCS admin and DCS components, then run the `odacli update-dcsadmin` and `odacli update-dcscomponents` commands immediately after applying the server update.

**10. Confirm that the server update is successful:**

```
[root@odal opt]# /opt/oracle/dcs/bin/odacli describe-job -i job_ID
```

**11. Update the storage components.**

Specify the `-rolling` option to patch shared disks in a rolling fashion.

```
[root@odal opt]# /opt/oracle/dcs/bin/odacli update-storage -v version --rolling
```

For example, for 18.7:

```
[root@odal opt]# /opt/oracle/dcs/bin/odacli update-storage -v 18.7.0.0.0 --rolling
```

**12. To patch existing Database Homes to release 18.7:**

**a. Run the patching pre-checks and review the prepatch report. For example:**

```
[root@odal opt]# /opt/oracle/dcs/bin/odacli create-prepatchreport --dbhome --dbhomeid DB_Home_ID -v release_number  
[root@odal opt]# odacli describe-prepatchreport -i Job_ID
```

```
[root@odal opt]# /opt/oracle/dcs/bin/odacli create-prepatchreport --dbhome --dbhomeid 7c67c5b4-f585-4ba9-865f-c719c63c0a6e -v 18.7.0.0.0
```

```
[root@odal opt]# odacli describe-prepatchreport -i
39ef1eeb-70d3-47ad-b3f5-48960ca0607b
```

**b.** Update the database home to the latest release:

```
[root@odal opt]# /opt/oracle/dcs/bin/odacli update-dbhome --
dbhomeid DB_Home_ID -v release_number
```

For example, for 18.7:

```
[root@odal opt]# /opt/oracle/dcs/bin/odacli update-dbhome --
dbhomeid 7c67c5b4-f585-4ba9-865f-c719c63c0a6e -v 18.7.0.0.0
```

**13.** Confirm that the patch jobs are successful:

```
[root@odal opt]# /opt/oracle/dcs/bin/odacli list-jobs
```

**14.** Delete the software zip files from the temporary location on the appliance to save space:

```
[root@odal opt]# rm software_file
rm: remove regular file software_file? y
```

**Related Topics**

- [Patching Existing Database Homes to the Latest Release Using the Web Console](#)  
Use the Web Console to patch database homes to the latest release.

**Related Topics**

- [Oracle Database Appliance Release Notes](#)

## Patching Oracle Database Appliance Using the Web Console

Upload the Oracle Database Appliance Server Patch to the patch repository, deploy the patch bundle using the Web Console, and then update the DCS agent and components using CLI commands.

**Updating the Patch Repository Using the Web Console**

1. Download the Oracle Database Appliance patches from My Oracle Support and save them in a directory on the appliance. See the *Oracle Database Appliance Release Notes* for a list of available patches and links to download the patches.
2. Log into the Web Console with the `oda-admin` user name and password.

```
https://Node0-host-ip-address:7093/mgmt/index.html
```

3. Click **Patch Manager**.
4. In the Update Patch Repository page, enter the absolute file path and patch name, then click **Update Repository** to start the update repository job. You can list more

than one file to update to the repository with a comma separated list, without spaces, or you can update each file, one at a time.

5. Click **Activity** to monitor the progress. When the job completes successfully, the Patch Repository is updated.

### Running Patching Prechecks and Patching Agent, Server, and Storage Using the Web Console

#### Note:

If your appliance has two nodes, you have the option to update both nodes at the same time or individually. If you update nodes individually, then update Node0 before updating Node1.

1. Do not have any jobs running or pending during the update window.
2. Click the **Appliance** tab, and then click **Patch Manager** in the Web Console.
3. Wait for the Component Details to load. If you just updated the Patch Repository, click **Refresh** in the Component Details section of the page.

After the patch is uploaded to the Patch Repository, the Component Details on the page are updated with the Installed Version and Available Version for each component.

4. Select **Precheck**, click **Update Components**, then click **Submit** to verify the patches in the repository and check for conflicts.

When the job finishes, go to the next step. Click **Activity** for job status.

5. On the Patch Manager page, click **Refresh** to refresh the Component Details. Select **Update Server**, click **Update Components**, then click **Submit** to begin the job to patch the server components.

For multi-node systems, select the node to update: All Nodes (default), Node0, or Node1.

The DCS agent is automatically updated whenever the Server or Storage components are updated.

When the job finishes, go to the next step. Click **Activity** for job status.

6. On the Patch Manager page, click **Refresh** to refresh the Component Details. Select **Update Storage**, click **Update Components**, then click **Submit** to begin the job to patch the storage components.

For multi-node systems, select the node to update: All Nodes (default), Node0, or Node1.

For high-availability environment, you can select the **Rolling** check box to perform rolling patching of storage components.

7. Click **Activity** to monitor the progress, and verify that the job completes successfully.

All patching-related information is logged in the `dcs-agent` log file at `/opt/oracle/dcs/log/dcs-agent.log`.

## Updating the DCS Admin and DCS Components After Patching

After patching your appliance using the Web Console, you must update the DCS admin and DCS components manually, through CLI commands.

Follow these steps:

1. Update DCS admin:

```
[root@oda1 opt]# /opt/oracle/dcs/bin/odacli update-dcsadmin -v
18.7.0.0.0
```

2. Confirm that the update is successful:

```
[root@oda1 opt]# /opt/oracle/dcs/bin/odacli describe-job -i job_ID
```

3. Update the DCS components:

```
[root@oda1 opt]# /opt/oracle/dcs/bin/odacli update-dcscomponents -v
18.7.0.0.0
```

## Updating Oracle Database Appliance Repository with Database Clone Files Using the CLI

Follow these steps to update the Oracle Database Appliance repository with Oracle Database clone files for the latest release using CLI commands.

To create new databases of a specific release version, you must update the Oracle Database Appliance repository with the RDBMS Clone files for a release. Follow these steps to update the repository with Oracle Database clone files for the latest release.

1. Download the RDBMS Clone software file for a release, for example, `p27604558_187000_Linux-x86-64.zip`, and extract the RDBMS Clone software:

For example, download the server patch for 18.7:

```
unzip /tmp/p27604558_187000_Linux-x86-64.zip
odacli-dcs-18.7.0.0.0-190830-DB-18.0.0.0.zip
```

2. Copy all the software files from the external client to Oracle Database Appliance. For High-Availability deployments, copy the software files to only one node. The software files are copied to the other node during the patching process. Use the `scp` or `sftp` protocol to copy the bundle.

Example using `scp` command:

```
# scp software_file root@oda_host:/tmp
```

Example using `sftp` command:

```
# sftp root@oda_host
```

Enter the `root` password, and copy the files.

```
put software_file
```

3. Update the repository with latest release database software:

```
[root@odal opt]# /opt/oracle/dcs/bin/odacli update-repository -f /tmp/odacli-dcs-db-clone-file.zip/
```

For example, for 18.7:

```
[root@odal opt]# /opt/oracle/dcs/bin/odacli update-repository -f /tmp/odacli-dcs-18.7.0.0.0-190830-DB-18.0.0.0.zip
```

Follow the same steps to update the repository with the RDBMS Clone software for other supported database versions such as 12.2, 12.1, and so on.

4. Confirm that the repository update is successful:

```
[root@odal opt]# /opt/oracle/dcs/bin/odacli list-jobs
[root@odal opt]# /opt/oracle/dcs/bin/odacli describe-job -i job_ID
```

5. Delete the software zip files from the temporary location on the appliance to save space:

```
[root@odal opt]# rm software_file
rm: remove regular file software_file? y
```

## Patching Existing Database Homes to the Latest Release Using the Web Console

Use the Web Console to patch database homes to the latest release.

### Note:

Follow the procedure in this topic only when patching ODA CLI stack. For patching Virtualized Platform, see the topic *Patching Oracle Database Appliance Virtualized Platform*.

Before patching the database home, upload the RDBMS Clone Files for the database version, to the repository. See *Updating Oracle Database Appliance Repository with Database Clone Files Using the CLI* for the procedure to update the repository with the latest RDBMS Clone Files.

1. Log into the Web Console with the `oda-admin` user name and password.

```
https://Node0-host-ip-address:7093/mgmt/index.html
```

2. Click the **Database** tab, and then click **Patch** on the left pane.

3. Click Patch, and then select the Action as **Precheck** to run pre-checks before patching the database.  
Click **Activity** for job status.
4. On the Patch page, for the database to be patched, click **View** and select **Pre-patch reports** to view the pre-check report. Fix any errors, and then select Action as **Apply** to patch the database.
5. Verify that the patching job completes successfully.

#### Related Topics

- [Patching Oracle Database Appliance Bare Metal Systems Using the Command-Line](#)  
Follow these steps to apply patches to your Oracle Database Appliance bare metal deployment and existing Oracle Database homes, using CLI commands.

#### Related Topics

- [Oracle Database Appliance Release Notes](#)

## Patching Oracle Database Appliance Virtualized Platform

Follow these steps to apply patches to Oracle Database Appliance OAKCLI Virtualized Platform using CLI commands.

1. Download the Oracle Database Appliance Server Patch for OAK Stack and Virtualized Platforms (patch 30217863) from My Oracle Support to a temporary location on an external client. Refer to the *Oracle Database Appliance Release Notes* for 18.7, for details about the software for the latest release.

For example, download the Oracle Database Appliance Server Patch for OAK Stack and Virtualized Platform for 18.7:

```
p30217863_187000_Linux-x86-64_1of3.zip
p30217863_187000_Linux-x86-64_2of3.zip
```

To patch your deployment to release 18.7, you need to download only the two files mentioned above. The third file `p30217863_187000_Linux-x86-64_3of3.zip` is required only if you want to patch the databases to release 11.2.0.4.190416, or 12.1.0.2.190416, or 12.2.0.1.190416, or 18.6.0.0.190416.

2. Copy the software files from the external client to Oracle Database Appliance. For two-node systems, ensure that you copy the software files to ODA\_BASE on **both** nodes. Use the `scp` or `sftp` protocol to copy the bundle.

Example using `scp` command:

```
scp software_file root@oda_host:/tmp
```

Example using `sftp` command:

```
sftp root@oda_host
```

Enter the `root` password, and copy the files.

```
put software_file
```

**3. Update the repository with the server software:**

```
[root@odal opt]# oakcli unpack -package path_to_patch_file
```

For example, for 18.7:

```
# oakcli unpack -package /tmp/p30217863_187000_Linux-x86-64_1of3.zip  
# oakcli unpack -package /tmp/p30217863_187000_Linux-x86-64_2of3.zip
```

**4. Apply the server update:**

```
[root@odal opt]# /opt/oracle/oak/bin/oakcli update -patch version --  
server
```

For example, for 18.7:

```
[root@odal opt]# /opt/oracle/oak/bin/oakcli update -patch 18.7.0.0.0 --  
server
```

**5. Update the storage components.**

```
[root@odal opt]# /opt/oracle/oak/bin/oakcli update -patch version --  
storage
```

For example, for 18.7:

```
[root@odal opt]# /opt/oracle/oak/bin/oakcli update -patch 18.7.0.0.0 --  
storage
```

**6. To update the Oracle Database Appliance repository with RDBMS Clone files for a release, for example, 18.7:**

- a.** Download the RDBMS Clone software file `p28864456_187000_Linux-x86-64.zip` to `/tmp` location and unpack the RDBMS Clone file software:

```
oakcli unpack -package /tmp/p28864456_187000_Linux-x86-64.zip
```

- b.** Update the repository with latest release database software:

```
[root@odal opt]# /opt/oracle/oak/bin/oakcli update -patch version --  
database
```

For example, for 18.7:

```
[root@odal opt]# /opt/oracle/oak/bin/oakcli update -patch  
18.7.0.0.0 --database
```



- c. Follow the same steps to update the repository with the RDBMS Clone software for other supported database versions such as 18.4, 12.2, 12.1, and so on.
7. Verify that the updates are applied.

```
[root@odal opt]# /opt/oracle/oak/bin/oakcli show version -detail
```

8. Delete the software zip files from the temporary location on the appliance to save space:

```
[root@odal opt]# rm software_file
rm: remove regular file software_file? y
```

9. Enable the discovery of repositories from ODA\_BASE.

```
[root@odal opt]# oakcli enable startrepo -node 0
[root@odal opt]# oakcli enable startrepo -node 1
```

## Patching Trace File Analyzer (TFA) Collector

Trace File Analyzer (TFA) Collector simplifies diagnostic data collection on Oracle Cluster Ready Services (CRS), Oracle Grid Infrastructure, and Oracle RAC systems.

Patch Trace File Analyzer (TFA) Collector to ensure that it contains the latest RPMs, and your deployment runs the latest diagnostic data collection version. If you are deploying Oracle Database Appliance for the first time, then TFA is installed with the new release in the location `/opt/oracle/tfa/tfa_home`.

Patch Trace File Analyzer (TFA) Collector as follows:

1. Log in to Oracle Database Appliance as a root user.
2. Download the latest `dc-agent` patch from My Oracle Support.
3. Update the patch repository.

```
odacli update-repository -fileName patch bundle
```

4. If you are patching Oracle Database Appliance with the latest patch release, then run the following command, before applying the Oracle Database Appliance patch.

```
# odacli update-dcsagent -v version
```

To patch TFA to 18.7 release, run the following command, to patch both the DCS agent and Trace File Analyzer (TFA) Collector:

```
# odacli update-dcsagent -v 18.7.0.0.0
```

The existing TFA version is deinstalled from the Grid home and then the `dcagent` is patched.

## Verifying That HAIP is Disabled After Patching to Release 18.7

After patching to Oracle Database Appliance release 18.7, verify that High-Availability IP (HAIP) is disabled.

When you patch your deployment to Oracle Database Appliance release 18.7, a network bond is created between two private networks during the patching process. You can verify that HAIP is disabled.

Component Check and Command	Expected Value Before Patching	Expected Value After Patching
Check private networks: #ifconfig	Displays the network interfaces information and contains one or two interfaces plumbed with 192.168.16.24/25 or 192.168.17.24/25.	Displays one interface which is bonded or plumbed with 192.168.16.24/25.
Check cluster_interconnect interfaces: # oifcfg getif	Displays two physical ethernet interfaces. Before patching, if there is already a bond between the private interfaces, then bond is not created.	Displays one bonded interface which is configured as cluster_interconnect.
Check HAIP resource in CRS	Run the command <code>crsctl status resource -t -init</code> and in the command output, check for the status of resource <code>ora.cluster_interconnect.haip</code> . Resource status is set to running.	Run the command <code>crsctl status resource -t -init</code> . The command output states that the resource <code>ora.cluster_interconnect.haip</code> does not exist in the location <code>/u01/app/18.0.0.0/grid/bin/crsctl</code> .

## Applying Additional Patches and Updates

Configure additional patch repositories and patch your operating system and databases to ensure that your deployment has the latest updates and security fixes.

- [Enabling Kernel Updates](#)  
Oracle Ksplice enables you to update your systems with the latest kernel security and bug fix updates.
- [Adding Repositories for Patch Updates](#)  
Add patch repositories to update operating system RPMs.
- [Applying Out-of-Cycle Database Patches](#)  
The out-of-cycle patching feature enables administrators to patch databases in the Oracle Database Appliance deployment with the latest Oracle Database Release Update, outside of the Oracle Database Appliance releases.

## Enabling Kernel Updates

Oracle Ksplice enables you to update your systems with the latest kernel security and bug fix updates.

You can download and install the latest Oracle Ksplice updates (uptrack-updates) with either the local ULN repository or ULN channel.

Follow these steps to install Oracle Ksplice:

1. Register your server with Unbreakable Linux Network (ULN). By default, you are registered for the Oracle Linux Latest channel for your operating system and hardware.
2. Log in to Unbreakable Linux Network:  
<https://linux.oracle.com>
3. Ensure that you have access to the Internet on the server where you want to use Ksplice. For example, if you are using a proxy server, then set the proxy server and port values in the shell with commands similar to the following:

```
# export http_proxy=http://proxy.company.com:port
# export https_proxy=http://proxy.company.com:port
```

4. Register the server:

```
# uln_register
```

5. Set up the local repository as described in the Oracle Ksplice user documentation. This enables you to download the latest Ksplice update packages at regular intervals without requiring a direct connection to the Oracle Utrack server or to ULN.
6. To update a system to a specific effective kernel version, install the uptrack-updates package for the current kernel.

```
yum -y install uptrack-updates-'uname -r'
```

You can also download the uptrack-updates RPM from the Ksplice channel and install the RPM manually. For example:

```
# rpm -Uvh uptrack-
updates-4.1.12-124.20.3.el6uek.x86_64-20190305-0.noarch.rpm
```

### See Also:

*Oracle Linux Ksplice User's Guide* for information about configuring Oracle Ksplice at:

[https://docs.oracle.com/cd/E37670\\_01/E39380/html/ksplice-enhanced-offline.html](https://docs.oracle.com/cd/E37670_01/E39380/html/ksplice-enhanced-offline.html)

## Adding Repositories for Patch Updates

Add patch repositories to update operating system RPMs.

Patching of operating system is included in the Oracle Database Patch Bundle. If you want to update other RPMs, then you can configure any private or public repository. Oracle public YUM channels are already configured by default. Add operating system RPM repositories as follows:

1. Run the following command to add a repository:

```
# odacli update-agentconfig-parameters -n OSPatchRepos -v 'http://
public-yum.oracle.com/repo/OracleLinux/OL6/latest/$basearch/' -a
```

Provide the public location within quotation marks("")

For adding RPMs stored on a local disk:

```
# odacli update-agentconfig-parameters -n OSPatchRepos -v /tmp/OSimage/
OL6.9_x86_64 -a
```

2. List all repositories:

```
odacli list-agentconfig-parameters -n OSPatchRepos
```

3. When you update the server, the operating system patching job uses all repositories to update the operating system RPMs.

```
odacli update-server -v 18.7.0.0.0
```

## Applying Out-of-Cycle Database Patches

The out-of-cycle patching feature enables administrators to patch databases in the Oracle Database Appliance deployment with the latest Oracle Database Release Update, outside of the Oracle Database Appliance releases.

You can apply Oracle Database Release Update (RU) patches manually using OPatch. Refer to the relevant section in this topic to run the OPatch for your database version.



### Note:

The OPatch commands and procedures described in this topic are examples, and may need modifications based on a specific Oracle Database Release Update (RU). Always refer to the Readme of the Oracle Database Release Update (RU) for additional commands and steps.

 **Note:**

It is strongly recommended that you patch your deployment through the Oracle Database Appliance releases, whenever possible.

 **Note:**

You can apply out-of-cycle patches to both baremetal and Virtualized Platform deployments using this procedure.

**Using OPatchauto to Manually Patch Oracle Database Release 12c and Later**

1. Confirm that the `dcs-agent` and other components are updated to the latest release.

```
# odacli describe-component
# odacli list-dbhomes
```

2. Update OPatch to the latest version, if available:

- a. Download the latest OPatch version from My Oracle Support.
- b. Copy the files to the local host and extract them to the `ORACLE_HOME/OPatch` directory.
- c. Update the OPatch tool as `oracle` user.

```
/bin/rm -rf $ORACLE_HOME/OPatch/
su - oracle -c /usr/bin/unzip -q -o OPatch_zip_location/
p6880880_122010_Linux-x86-64.zip -d $ORACLE_HOME
```

3. Download the latest database patches from My Oracle Support and copy the files to the local host.

```
scp patchfilename root@hostname:directory
```

4. Unzip patches to an empty directory, for example, `/tmp/patchesDir` as `oracle` user.

This creates sub directories under `/tmp/patchesDir` with bug numbers. If the patch you are applying is a Release Update (RU), then the patch directory has multiple sub-directories.

```
/usr/bin/unzip -o location_of_patches/p29301631_180000_Linux-x86-64.zip
-d /tmp/patchesDir
```

5. For Oracle Database Appliance High-Availability deployments, set up SSH Keys for secure connection.
6. Analyze the patches.

```
$ORACLE_HOME/OPatch/patchauto apply directory_with_patches_extracted -
analyze -oh $ORACLE_HOME -log /tmp/patchAutoAnalyzePatch.log
```

7. As root user, apply the patches.

```
$ORACLE_HOME/OPatch/opatchauto apply directory_to_extract_patches -
oh $ORACLE_HOME -inplace
```

8. When patching is completed on both nodes, run `utlrp.sql` and `catcon.pl` scripts to recompile invalid objects in the database.
9. Update the registry to ensure that system component values are registered.

```
# odacli update-registry -n dbhome -f
```

#### Using OPatch to Manually Patch Oracle Database Release 11.2.0.4

1. Confirm that the `dcs-agent` and other components are updated to the latest release.

```
# odacli describe-component
# odacli list-dbhomes
```

2. Update OPatch to the latest version, if available:

- a. Download the latest OPatch version from My Oracle Support.
- b. Copy the files to the local host and extract them to the `ORACLE_HOME/OPatch` directory.
- c. Update the OPatch tool as oracle user.

```
/bin/rm -rf $ORACLE_HOME/OPatch
su - oracle -c /usr/bin/unzip -q -o OPatch_zip_location/
p29141056_112040_Linux-x86-64.zip -d $ORACLE_HOME
```

3. Download the latest database patches from My Oracle Support and copy the files to the local host. Unzip the database patches to an empty directory, for example, `/tmp/patchesDir` as oracle user.

This creates sub directories under `/tmp/patchesDir` with bug numbers. If the patch you are applying is an Oracle Database Release Update (RU), then the patch directory has multiple sub-directories.

```
su - oracle -c '/usr/bin/unzip -o p29141056_112040_Linux-x86-64.zip -
d /tmp/patchesDir'
```

4. Delete bug#2015 if it exists in the inventory.

- a. Check if bug#2015 exists in the inventory:

```
su - oracle
export ORACLE_HOME=path_to_the_11.2.0.4_ORACLE_HOME
$ORACLE_HOME/OPatch/patch lspatches | grep -i "OCW" | cut -d ';' -
f1
```

- b.** The command returns a bug number, for example, 28729234. Navigate to the inventory:

```
cd $ORACLE_HOME/inventory/oneoffs/bug# from above command/etc/config
```

- c.** Check if `inventory.xml` contains a string such as `'bug number="2015"'`. If no match is found, then no action is required, and you can continue with step 6 in this procedure.

```
grep 'bug number="2015"' inventory.xml
echo $? ( the command returns 0, if match found )
```

- d.** Take a backup of `inventory.xml`.

```
cp inventory.xml inventory.xml.$(date +%Y%m%d-%H%M)
```

- e.** Delete entry like `<bug number="2015" ...>` from `inventory.xml`.

```
sed '/bug number="2015"/d' inventory.xml
```

- 5.** Run prechecks using the `opatch` command for every patch.

```
su - oracle -c '$ORACLE_HOME/OPatch/opatch prereq CheckComponents -
ph /tmp/patchesDir/29301631 -oh $ORACLE_HOME'
su - oracle -c '$ORACLE_HOME/OPatch/opatch prereq
CheckConflictAgainstOH -ph /tmp/patchesDir/29301631 -oh $ORACLE_HOME'
```

Run both commands for all the sub patches also. If there are any conflicting bugs, then rollback the one-off patches.

- 6.** Apply the patch using the `opatch auto` command.

```
$ORACLE_HOME/OPatch/opatch auto /tmp/patchesDir/29301631 -
oh $ORACLE_HOME -ocmrf /opt/oracle/dcs/rdbaas/config/default-ocm.rsp
```

- 7.** Verify that the database is up and running after applying the patch.

```
/u01/app/18.0.0.0/grid/bin/crsctl status resource ora.on6i.db -n
patched_db
```

- 8.** Run `catbundle.sql` on all databases in this home.

```
su oracle
export ORACLE_HOME=ORACLE_HOME
export ORACLE_HOME=ORACLE_SID
$ORACLE_HOME/bin/sqlplus "/ as sysdba" @$ORACLE_HOME/rdbms/
admin/catbundle.sql
@$ORACLE_HOME/rdbms/admin/catbundle.sql
```

# About Upgrading to a Different Database Home

Understand how to upgrade to a different database home using either the Web Console or `odacli` commands.

## Prerequisites for Upgrading Database Homes

You can upgrade database homes of the following releases:

- Oracle Database 12.2 to 18c
- Oracle Database 12.1 to 18c
- Oracle Database 11c to 18c
- Oracle Database 12.1 to 12.2
- Oracle Database 11c to 12.2
- Oracle Database 11c to 12.1

Before upgrading to a different database home, upload the RDBMS Clone Files for the database version, to the repository, and then create the database home. See *Patching Oracle Database Appliance Using the CLI* for the procedure to update the repository with the latest RDBMS Clone Files.

## About Upgrading Database Homes Using the Web Console

Follow these steps to upgrade to a different database home using the Web Console.

1. Log into the Web Console with the `oda-admin` user name and password.

```
https://Node0-host-ip-address:7093/mgmt/index.html
```

2. Click the **Database** tab, and then select a database, click **Actions**, and then click **Upgrade**.
3. Verify that the database upgrade job completes successfully.

## About Upgrading Database Homes Using the Command-Line Interface

Run the following command to upgrade to a different database home using the CLI:

```
odacli upgrade-database -i Comma separated list of database ids -from  
source dbhome id -to destination dbhome id [-j] [-h]
```

For more information about the options for the `upgrade-database` command, see the chapter *Oracle Database Appliance Command-Line Interface*.

## Related Topics

- [odacli upgrade-database](#)  
Use the `odacli upgrade-database` command to upgrade a database from a supported release.



### Related Topics

- [odacli upgrade-database](#)  
Use the `odacli upgrade-database` command to upgrade a database from a supported release.

# 8

## Re-imaging Oracle Database Appliance

Bare metal operating system re-imaging installs Oracle Database Appliance operating system software on the local (boot) drive.

Bare Metal is a non-virtualized Oracle Database Appliance configuration. Oracle Database Appliance ships from the factory with a bare metal configuration, default ISO image and Appliance Manager installed. Use the OS ISO Image to restore the OS to the "shipped from factory" state. Use only when necessary. Reimaging does not patch the firmware or update the component versions; it only re-images the local system disk from an operating system perspective. After imaging is completed, redeploy the End User image, then restore from backup, as needed.

- [Cleaning Up Incomplete or Failed Installations](#)  
Use the Oracle Database Appliance cleanup deploy utility, `/opt/oracle/oak/onecmd/cleanup.pl` to uninstall Oracle Database Appliance components.
- [Restoring an Oracle Database Appliance Baremetal System](#)  
Re-image Oracle Database Appliance to perform a bare metal restore of Oracle Database Appliance.
- [Performing Secure Erase of Data on Storage Disks](#)  
With this release, you can securely erase data from storage devices. Running the secure erase tool deletes the data on the storage disk permanently.

### Related Topics

- [Errors when re-imaging Oracle Database Appliance](#)  
Understand how to troubleshoot errors that occur when re-imaging Oracle Database Appliance.

## Cleaning Up Incomplete or Failed Installations

Use the Oracle Database Appliance cleanup deploy utility, `/opt/oracle/oak/onecmd/cleanup.pl` to uninstall Oracle Database Appliance components.

### About the Cleanup Utility

Use the cleanup deploy utility to do the following:

- Uninstall Oracle Auto Service Request (Oracle ASR)
- Uninstall Oracle Trace File Analyzer (TFA)
- Uninstall Oracle ORAchk Health Check Tool
- Uninstall Oracle Grid Infrastructure and the Oracle stack
- Reset or delete the Oracle Linux udev rules
- Delete users and groups that were created when the appliance was created.

The script removes the firstnet config and the client access VLAN UNIX\_DB, but does not delete any other VLANs. The script also resets any disabled CPU cores and enables all of the cores.

The cleanup utility runs in two modes: default and force mode. In the default mode, the commands used as part of cleanup do not use the force option. The ASM disk status is changed from MEMBER to FORMER, but ASM header on the disk is not erased. The default mode can be used only for cleaning up or re-provisioning of the same system.



**Note:**

For High-Availability systems, run the cleanup utility on both nodes sequentially. Ensure that the cleanup utility has completed on the first node, and then start the process on the second node.

**Running the Cleanup Utility for a Baremetal Deployment**

```
# perl cleanup.pl [-griduser grid_user]  
[-dbuser db_user] [-groups comma separated list of groups]  
[-erasedata] [f]
```

When the *grid\_user* and *db\_user* are the same (*roleSeparation=false*), you must run the script for each user (*-gridUser* and *-dbUser*).

**Table 8-1 Command Options for Cleanup Utility**

Option	Description
<i>grid_user</i>	Describes the Oracle Grid Infrastructure user name. The default user is <i>grid</i> .
<i>db_user</i>	Describes the database user name. The default user is <i>oracle</i> Example with <i>grid</i> and <i>oracle</i> users:  cleanup.pl -griduser oracle -dbuser oracle
<i>groups</i>	Describes the comma-separated list of groups. The default groups are <i>oinstall,dba,asmadmin,asmoper,asmdba</i> .
<i>erasedata</i>	Completely erases all disks on system. It is mandatory to run this option if intention of cleanup is to reuse or move these disks on other systems. Example of secure erase:  cleanup.pl -erasedata
<i>cleanDefNet</i>	Cleans up the default public network.

**Table 8-1 (Cont.) Command Options for Cleanup Utility**

Option	Description
checkHeader	Checks for OAK/ASM header on disks after successfully running the cleanup script. Use this to validate if the OAK/ASM header was erased by the cleanup script or not. Example of checking disk header:  cleanup.pl -checkHeader
f	In the force mode, all commands use the force option. The ASM disk header is erased. The oakd header on the disk is erased in both default and force modes. Example of default mode:  cleanup.pl  Example of force mode:  cleanup.pl -f

### Running the Cleanup Script for a Virtualized Platform Deployment

Use this cleanup deploy script tool to clean up a Virtualized Platform deployment on Oracle Database Appliance.

Run the following command from dom0 on Node 0 to remove ODA\_BASE and the initial network configuration.

```
/opt/oracle/oak/tools/cleanOdabase.py
```

## Restoring an Oracle Database Appliance Baremetal System

Re-image Oracle Database Appliance to perform a bare metal restore of Oracle Database Appliance.

Bare metal restore uses Oracle Integrated Lights Out Manager (ILOM) to re-image the Oracle Database Appliance node. The ILOM must be configured before performing a bare metal restore or re-image. Generally, the ILOM is configured as part of readying for deploying Oracle Database Appliance.

Download the Oracle Database Appliance Bare Metal ISO image to your local machine before you launch the ILOM console.

Follow these steps to re-image your appliance. For Oracle Database Appliance High-Availability deployment, follow these steps on **both** nodes.

1. Open a browser and connect to Oracle Integrated Lights Out Manager (ILOM) on Node 0 as root.

`https://ilom-ip-address`

2. Launch the Remote Console.
  - a. Expand **Remote Control** in the left navigation.
  - b. Click the **Redirection** tab.
  - c. Click **Launch** for the Remote Console in the Actions menu.

The state of the system determines what appears on the Console page.
3. Add the image.
  - a. Click the **KVMS** tab, then select **Storage**.
  - b. Click **Add**.
  - c. Browse to the Oracle Database Appliance Bare Metal ISO Image, highlight the image, then click **Select**.
  - d. Click **Connect**.

The mounting of the ISO image is successful when the **Connect** button changes to a **Disconnect** button.
  - e. Click **OK**

The CD-ROM icon in the top right corner is highlighted.
4. Configure the CD-ROM as the next boot device.
  - a. Expand **Host Management** in the left menu of the ILOM Remote Console tab.
  - b. Click **Host Control**.
  - c. Select **CDROM** from the Next Boot Device menu, then click **Save**.
5. Power cycle the node.
  - a. Click **Power Control** in the **Host Management** menu.
  - b. Select **Power Cycle** , then click **Save**.

When the node comes back after the power cycle, re-imaging starts automatically. The Oracle Linux page appears, followed by the Running Post-Install scripts page.

The Running Post-Install scripts page is a static page and might give the impression that the re-imaging process is not progressing. The post-install process during re-imaging will wait until the synchronization between the partitions of the two mirrored local hard disks is complete, which can take 15 to 20 minutes to complete.

To check the progress of re-synchronization, press the ALT-F2 key combination to open a second console and enter the following command:

```
# cat /proc/mdstat
```

When the re-synchronization is complete, re-imaging is completed and the machine restarts.

After the machine restarts, the system is ready for you to deploy the Oracle software on the appliance to create an Oracle Database Appliance bare metal platform.

## Performing Secure Erase of Data on Storage Disks

With this release, you can securely erase data from storage devices. Running the secure erase tool deletes the data on the storage disk permanently.

You may want to consolidate storage disks between appliances. For example, you can use X7-2 disks on X6-2 models, and may want to consolidate all X6-2 disks on one system, and use all new X7-2 storage disks on another system. In such cases, use secure erase to erase headers from disks before re-imaging the disks, since the storage disks across the appliances may have different partition ratios.

 **Note:**

Running the secure erase tool removes data from storage disks permanently. If you have any data on the disk, then take a backup of your storage disk before running the secure erase tool.

Follow the steps to run the secure erase tool:

1. Stop `oakd` and the database and Oracle Grid Infrastructure before running the secure erase tool.

On bare metal systems, run the command:

```
# odaadmcli stop oak
```

On Virtualized Platforms:

```
# oakcli stop oak
```

To stop Oracle Clusterware resources:

```
# crsctl stop crs -f
```

2. Run the secure erase tool:

```
# /opt/oracle/oak/bin/odaeraser.py
```

3. You can also run the secure erase tool when running the cleanup tool:

```
# cleanup.pl -erasedata
```

### Example 8-1 Options for the Secure Erase Tool

Option	Description
-a, --all	Erases all disks. For example:  # /opt/oracle/oak/bin/odaeraser.py --all

Option	Description
<code>--disk disk1,disk2</code>	Erases specified disks. For example:  <pre># /opt/oracle/oak/bin/odaeraser.py --disk e0_pd_00,e0_pd_01</pre>
<code>--dryrun</code>	Runs the tool in the test mode
<code>--type HDD SSD NVMe</code>	Erases the type of disk specified
<code>-v, --verbose</code>	Displays verbose output
<code>-h, --help</code>	Displays all CLI options for the tool

# 9

## Managing Oracle Databases

Manage the Oracle Databases on your Oracle Database Appliance. For an Oracle Database Appliance Virtualized Platform, see the `oakcli` commands for managing the databases.

- [About Administrative Groups and Users on Oracle Database Appliance](#)  
Oracle Database Appliance Web Console deployment creates operating system groups and users whose members are granted system administration privileges on the appliance.
- [About Data Migration Options for Oracle Database Appliance](#)  
Oracle Database Appliance supports the use of standard Oracle Database loading and migration tools.
- [Working with Databases](#)  
Use the Web Console to display a list of databases, database details, and create and delete databases. You can use CLI commands to manage your databases.
- [Working with Database Homes](#)  
Use the Web Console to display a list of database homes, details, and create and delete database homes.
- [Migrating Databases](#)  
Review these topics to learn how to prepare for and migrate an entire database to your Oracle Database Appliance.
- [About Managing Multiple Database Instances Using Instance Caging](#)  
Use instance caging to manage your system resources on Oracle Database Appliance.
- [Oracle EM Express and DB Console](#)  
You can use Oracle Enterprise Manager Database Express (EM Express), or the Database Control Console (DB Console) to manage your database.

### About Administrative Groups and Users on Oracle Database Appliance

Oracle Database Appliance Web Console deployment creates operating system groups and users whose members are granted system administration privileges on the appliance.

During configuration, two administrative accounts are created for Oracle Database Appliance: the user `grid`, with a user ID (UID) of 1001, and the user `oracle`, with a UID of 1000. The user `grid` is the Oracle Grid Infrastructure installation owner. The user `oracle` is the Oracle Database installation owner, and the owner of all Oracle Database homes (Oracle homes). By default, these users are members of operating system groups whose members are granted privileges to start up and administer Oracle Database and Oracle Automatic Storage Management.



The following table describes the Oracle system privileges groups, and information about the operating system authentication groups:

**Table 9-1 Operating System Groups and Users on Oracle Database Appliance**

Oracle System Privileges	Group Name	Group ID (GID)	<i>grid</i> is a member	<i>oracle</i> is a member
Oracle Inventory group (OINSTALL)	oinstall	1001	yes (primary group)	yes (primary group)
OSOPER for dbaoper group	dbaoper	1002	yes	yes
OSDBA group	dba	1003	no	yes
OSASM Group for Oracle ASM	asmadmin	1004	yes	no
OSOPER for ASM group	asmoper	1005	yes	no
OSDBA for ASM group	asmdba	1006	yes	yes

To change the Group Name and GID from the default values on Oracle Database Appliance bare metal platforms, change the default values from the Web Console during the deployment. If you create an initial database during deployment, then the password for the SYS and SYSTEM users is the Master Password that you set in the Web Console.

To change the Group Name and GID from the default values on the Oracle Database Appliance Virtualized Platform, use the `-advance` parameter with the command `oakcli deploy`. If you create an initial database during deployment, then the password for the SYS and SYSTEM users is the ROOT password from the Configurator.



**Note:**

Change the password for both users as soon as possible after configuration to prevent unauthorized access to your database using these privileged accounts.

## About Data Migration Options for Oracle Database Appliance

Oracle Database Appliance supports the use of standard Oracle Database loading and migration tools.

If you are loading data or migrating data from an existing database to Oracle Database Appliance, then you can use the standard Oracle Database loading and migration tools. These tools include the following:

- Oracle GoldenGate
- SQL\*Loader
- Oracle Data Pump

- transportable tablespaces
- RMAN

You can also use the RMAN utility to back up and recover databases on Oracle Database Appliance.

## Working with Databases

Use the Web Console to display a list of databases, database details, and create and delete databases. You can use CLI commands to manage your databases.

### Note:

Oracle Database Appliance release 18.7 enables unified auditing for databases created in new database homes. Unified audit trail captures audit information and places them in one location and in one format. This consolidated view enables auditors to co-relate audit information from different components. Having a single audit trail also improves management and security of the audit trail. For more information about unified audit trail for Oracle Database, see *Oracle Database Security Guide*.

- [Viewing Databases](#)  
Use the Oracle Appliance Manager Web Console to display a list of Oracle databases and database details, create, upgrade, and delete a database in Oracle Database Appliance.
- [Creating a Database](#)  
Use the Oracle Appliance Manager Web Console to create a database in Oracle Database Appliance.
- [Creating a Database Instance](#)  
Create an instance only database from the command-line interface.
- [Cloning a Database from Backup](#)  
Use the Web Console to clone a database from a backup.
- [Cloning an Oracle ACFS Database Using the Web Console](#)  
Create a database from an existing Oracle ACFS database using the Web Console.
- [Cloning an Oracle ACFS Database Using Command Line Interface](#)  
Create a database from an existing Oracle ACFS database using CLI commands.
- [Upgrading a Database](#)  
Use the Oracle Appliance Manager Web Console to upgrade an Oracle database to a different database home version.
- [Deleting a Database](#)  
Use the Oracle Appliance Manager Web Console to delete an Oracle database.

## Viewing Databases

Use the Oracle Appliance Manager Web Console to display a list of Oracle databases and database details, create, upgrade, and delete a database in Oracle Database Appliance.

On the Oracle Database Appliance Virtualized Platform, see the command `oakcli list databases`.

1. Log into the Web Console:

```
https://host name or ip-address:7093/mgmt/index.html
```

2. Click the **Database** tab.

The screenshot shows the Oracle Database Appliance Web Console interface. The 'Database' tab is selected, displaying a list of databases. The interface includes a search bar, a sort dropdown set to 'Created: New to Old', and a 'Create Database' button. The database list is as follows:

Database Name	ID	Created	CDB	DB Version	Shape	Storage	Actions
<a href="#">clonedb</a>	19b58021-5726-4029-83c9-9530dc720b96	Fri Oct 05 2018 9:37:06 AM	true	18.3.0.0.180717	odb1s	ACFS	Actions
<a href="#">testdb18</a>	4c0c1240-be0d-495b-b665-c2340297e721	Fri Oct 05 2018 9:25:23 AM	false	18.3.0.0.180717	odb4	ASM	Actions
<a href="#">cdbcscf</a>	58efc217-8bad-415e-affd-0aeacc3f755	Tue Oct 02 2018 7:46:36 AM	true	18.3.0.0.180717	odb1s	ACFS	Actions
<a href="#">cdb18asm</a>	1d123775-d0c0-4379-9597-6826f2baf076	Tue Oct 02 2018 7:11:33 AM	true	18.3.0.0.180717	odb1	ASM	Actions
<a href="#">testdb</a>	ca0ca63e-49d5-4797-a845-af433ab0f79c	Tue Oct 02 2018 6:17:53 AM	true	18.3.0.0.180717	odb4	ASM	Actions

3. (Optional) Click the database name, in blue font, to display more details about the database.
4. (Optional) Click **Actions** next to a database entry to view more details, upgrade or delete the database.

## Creating a Database

Use the Oracle Appliance Manager Web Console to create a database in Oracle Database Appliance.

Ensure that the repository is updated with the RDBMS Clone files for a database version, before creating the database as described in *Updating Oracle Database Appliance Repository with Database Clone Files Using the CLI*.

The Web Console provides a quick and easy method of creating new databases. The Create New Database page in the Web Console is populated with default options for most of the configuration options. Drop-down lists enable you to quickly view and select from a list of available options. You can use the drop-down list to create a new database Oracle Database Home (ORACLE\_HOME) for the database or select an existing ORACLE\_HOME that you created earlier.

Oracle Database 18.7 is supported on both Oracle Automatic Storage Management (Oracle ASM) and Oracle ASM Cluster file system (ACFS). When databases are

created in Oracle ACFS, each database is configured with its own Oracle ACFS file system for the datafiles and uses the following naming convention: `/u02/app/db user/oradata/db unique name`. The default size of this mount point is 100 GB.

The fields in the Web Console adjust, depending on the database version you select. Follow these steps to create a database:

1. Log into the Web Console:

`https://host-ip-address:7093/mgmt/index.html`

2. Click the **Database** tab.
3. Click **Create Database** to display the Create Database page.
4. Select **Create Database** on the Create Database page.
5. Enter the following information on the Create Database page to configure the database:

- a. In the **DB Name** field, enter a name for the database. The name *db1* appears in the field as an example of a database name, but the field is not populated. You must enter a name.

The name must contain lowercase alphanumeric characters and cannot exceed 8 characters. The Oracle system identifier (SID) is always set to the database name.

- b. (Optional) In the **DB Unique Name** field, enter a name to define a unique name for the database.
- c. In the **Use Existing DB Home** field, select **Yes** or **No**.
- d. In the **DB Version** field, select a database bundle patch number from the drop-down list.

Available database versions with available clones appear in the list in descending order. Supported versions that are not available in the repository appear in light gray font at the bottom of the list. Search is available for the list. To add a supported version to the repository, download the RDBMS clone file and update the repository.

- e. For the **CDB** option on Oracle Database version 18.7, select **Yes** or **No**, depending on whether or not you want the database to be a container database (CDB). The default is **Yes**.

- f. In the **PDB Name** field, enter a name for the pluggable database (PDB).

Alphanumeric characters and underscore (`_`) are valid. The name must begin with an alphanumeric character and cannot exceed 30 characters. The name *pdb1* appears in the field in italic text as an example, but it is not populated. You must enter a name.

- g. In the **PDB Admin User** field, enter a name.

The field shows *pdbadmin* as an example, you must enter a name. Alphanumeric characters and underscore (`_`) are valid.

- h. In the Database Edition field, enter the edition for which you have a license, either **Enterprise Edition** or **Standard Edition**.

- i. In the **Shape** field, select a database shape from the drop-down list. The shape determines the number of cores and total memory allocated to the database. The default is odb1 (1 Core, 8 GB Memory).

- j. In the **Database Class** field, select a database class from the drop-down list. If an option is not available in the list, it is not supported for the database edition on the Oracle Database Appliance or the version that you selected. The default is OLTP.
  - k. In the **Storage** field, select **ACFS** or **ASM** from the drop-down list. The default is Oracle ASM.
  - l. If you select the storage as **ASM**, and the Database Version is 12.2 or later, and the disk group redundancy was set to **Flex** during the appliance creation, then you can select the **Database Redundancy** value as **Mirror** or **High**.  
  
You can choose Oracle ACFS storage for all database versions, but if you select Oracle ACFS storage, then you cannot specify the database redundancy. If your disk group redundancy is Flex, and you choose Oracle ACFS storage for the database, then the database redundancy is set to Mirror.
  - m. For the **Configure EM Express** or **Configure EM Console** option, select **Yes** or **No**. The default is **No**.  
  
Select **Yes** to configure the Oracle Enterprise Manager Database Express (EM Express) console for Oracle Database 18.7. Selecting **Yes** enables you to use the console to manage the database.
  - n. In the **Password** field, enter the password for the SYS, SYSTEM, and PDB Admin.  
  
The password must begin with an alpha character and cannot exceed 30 characters. Quotation marks are not allowed.
  - o. In the Confirm Password field, enter the password again to confirm.
  - p. In the **Characteraset** field, select an option from the drop-down list. The default is AL32UTF8.
  - q. In the **National Characteraset** field, select an option from the drop-down list. The default is AL16UTF16.
  - r. In the **Language** field, select a database language from the drop-down list. The default is American.
  - s. In the **Territory** field, select a territory or location for the database from the drop-down list. The default is America.
6. Click **Create**. When prompted, click **Yes** to confirm that you want to start the job to create the database.

The job is submitted and a confirmation page appears with a link to the job. Click the link to view the job progress, tasks, and status.  
After you close the Job confirmation page, you can click the **Activity** tab to monitor the job progress. Click the job number to view the tasks and status details. Click **Refresh** to refresh the page.

## Creating a Database Instance

Create an instance only database from the command-line interface.

### Note:

If you provisioned the appliance without creating an initial database, then you must create a Oracle home. If the version of the database home is different from the migrated database, create a database home for the migrated database. You might want to create a database home specifically for the migrated database.

This example creates an instance only database named `PRODDB` with database version 18.7 and a new database home.

1. Use the `odacli list-dbhomes` command to display a list of database homes and verify that a database home exists for the database version.

Note the ID if you want to use an existing database home or if you want to get more details. Use the `odacli describe-dbhomes` command to get greater details about a specific database home.

```
# odacli list-dbhomes
ID                               Name                               DB Version
-----
b727bf80-c99e-4846-ac1f-28a81a725df6 OraDB12102_home1 18.7.0.0.0

(continued)
Home Location
-----
/u01/app/orauser/product/18.0.0.0/dbhome_1
```

2. Create a database home if a database home does not exist for the database version.

If you want to create a database home for specifically for the migrated database, you can use the `odacli create-dbhome` command, or you can create the database home when you create the database. The example creates a database home for database version 18.7.0.0.0.

```
# odacli create-dbhome -v 18.7.0.0.0
```

3. Create an instance only database. You can use an existing database home ID or you can create a database home when creating the database.

To create an instance only database named `PRODDB` with database version 18.7.0.0.0 that uses an existing database home with ID `b727bf80-c99e-4846-ac1f-28a81a725df6`:

```
# odacli create-database -n PRODDB -v 18.7.0.0.0 -io -m -dh b727bf80-
c99e-4846-ac1f-28a81a725df6
```

To create an instance only database named `PRODDB` with database version `18.7.0.0.0` and a database home:

```
# odacli create-database -n PRODDB -v 18.7.0.0.0 -io -m
```

## Cloning a Database from Backup

Use the Web Console to clone a database from a backup.

When you backup a database in Oracle Database Appliance, a backup report is created. Save the backup report as a JSON file and you can use the file to create a database on the same appliance, or a different appliance.

The following are the prerequisites to cloning a database from a backup:

1. The source database backup location must be Object Store or External FRA (Network File System).
2. If you use Object Store backup location, then obtain Object Store Credentials for the host.
3. If you use an External FRA (Network File System) backup location, then obtain the Network File System (NFS) mount point location.
4. Create a backup policy using the object store credentials or NFS mount point as the backup destination.
5. Attach the backup policy to the database that you want to backup.
6. Create a manual backup of the database and save the backup report generated when the backup completes.

Follow these steps to create a database from backup:

1. Log into the Web Console:  

```
https://host-ip-address:7093/mgmt/index.html
```
2. Click the **Database** tab.
3. Click **Create Database** to display the Create Database page.
4. Click **Clone Database from Backup**, then click **Next** to display the Clone Database from Backup page.
5. Select the Backup Destination from which you want to create the database. If your backup destination is ObjectStore:
  - a. Select Backup Destination as **ObjectStore**.
  - b. Select your **Object Store Credential Name**.
  - c. Enter the password in the **Backup Encryption Passwords** field and the **Confirm Backup Encryption Passwords** field.

If your backup destination is Network File System (NFS):

- a. Select Backup Destination as **External FRA**.
- b. Specify the **External FRA Mount Point**.
- c. Enter the password in the **Backup Encryption Passwords** field and the **Confirm Backup Encryption Passwords** field.

6. Click **Browse** and select the backup report from which you want to create the database.

When the backup report is loaded, additional fields appear on the page and are populated based on the backup report. You can edit some of the fields.

7. In the **DB Name** field, enter a name for the database.

The name must contain lowercase alphanumeric characters and cannot exceed 8 characters. The Oracle system identifier (SID) is always set to the database name.

8. Enter the password in the **SYS User Password** field and the **Confirm SYS User Password** field.

9. Click **Create**.

10. Click **Yes** to confirm that you want to clone a database from the selected Object Store or External FRA.

When you submit the job, the job ID and a link to the job appears. Click the link to display the job status and details.

11. Validate that the job completed. You can track the job in the **Activity** tab in the Web Console, or run the command `odacli describe-job` with the job ID.

```
# odacli describe-job -ijobId
```

## Cloning an Oracle ACFS Database Using the Web Console

Create a database from an existing Oracle ACFS database using the Web Console.

Cloning enables to:

- Create a database from another database without bringing down the source database
- Create multiple databases from a gold image, thus ensuring standardized mass deployments
- Optimize space utilization, by use of Oracle ACFS snapshots in cloning
- Create different types of databases, from a single source database type. For example, you can create single-instance databases, Oracle RAC databases, or Oracle RAC One Node databases from any type of source database
- Depending on the available memory and CPU cores, specify a supported database shape such as `odb1s`, `odb2`, and so on, to create any class of database from any source database.

Follow these steps to create a database from an existing Oracle ACFS database:

1. Log into the Web Console:

```
https://host-ip-address:7093/mgmt/index.html
```

2. Click the **Database** tab.
3. Click **Create Database** to display the Create Database page.
4. Click **Clone a Database**, then click **Next** to display the Clone Database page.
5. Select the **Source Database** from which you want to create the database.
6. Select the **Database Shape** (template) for your new database. The database shape you select determines the total memory allocated to the database.



7. In the **DB Name** field, enter a name for the database.  
The name must contain lowercase alphanumeric characters and cannot exceed 8 characters. The Oracle system identifier (SID) is always set to the database name.
8. Specify the **DB Unique Name** for the database. If the database unique name is not provided, then the name of the database is set to the database name.
9. Enter the password in the **SYS User Password** field and the **Confirm SYS User Password** field.
10. Optionally, specify the **TDE Wallet Password**.
11. Click **Create**.
12. Click **Yes** to confirm that you want to clone a database from the selected source database.  
When you submit the job, the job ID and a link to the job appears. Click the link to display the job status and details.
13. Validate that the job completed. You can track the job in the **Activity** tab in the Web Console, or run the command `odacli describe-job` with the job ID.

```
# odacli describe-job -i jobId
```

## Cloning an Oracle ACFS Database Using Command Line Interface

Create a database from an existing Oracle ACFS database using CLI commands.

Cloning enables to:

- Create a database from another database without bringing down the source database
- Create multiple databases from a gold image, thus ensuring standardized mass deployments
- Optimize space utilization, by use of Oracle ACFS snapshots in cloning
- Create different types of databases, from a single source database type. For example, you can create single-instance databases, Oracle RAC databases, or Oracle RAC One Node databases from any type of source database
- Depending on the available memory and CPU cores, specify a supported database shape such as `odb1s`, `odb2`, and so on, to create any class of database from any source database.

Following are the prerequisites to clone a database:

- Ensure that Oracle Clusterware is running on all nodes, and the source database is up and running.
- The source database must use Oracle ACFS storage.
- The source database must not be a multitenant container databases (CDBs)
- The source database must be the primary database.
- The source database must be in the OPEN state.
- The source database must not be in backup mode.
- The source database must be in archive mode.

Follow this procedure to clone a database:

- Run the `odacli clone-database` command.

```
odacli clone-database --databaseUniqueName --dbname --dbshape --dbtype |
SI --json
--sourcedbname --syspassword --tdepasword
```

Specify the unique name of the database, the name for the new database, the database shape, the type of database, the source database name, password for SYS user, and the TDE Wallet password. For information about all the command options, see the *ODA CLI Command Reference* chapter.

### Related Topics

- [odacli clone-database](#)  
Use the `odacli clone-database` command to clone a new database from a source database.

## Upgrading a Database

Use the Oracle Appliance Manager Web Console to upgrade an Oracle database to a different database home version.

Before upgrading to a different database home, you must upload the RDBMS database version to the repository and create the database home.

1. Log into the Web Console:  
`https://host name or ip-address:7093/mgmt/index.html`
2. Click the **Database** tab.
3. Click **Actions** next to the database that you want, then select **Upgrade**.
4. Select the destination database home version from the list of available versions, then click **Upgrade**.

## Deleting a Database

Use the Oracle Appliance Manager Web Console to delete an Oracle database.

1. Log into the Web Console:  
`https://host name or ip-address:7093/mgmt/index.html`
2. Click the **Database** tab.
3. Click **Actions** next to the database that you want, then select **Delete**.
4. Confirm the action.

## Working with Database Homes

Use the Web Console to display a list of database homes, details, and create and delete database homes.

- [About Managing Multiple Oracle Homes on Oracle Database Appliance](#)  
Create and manage one or more Oracle home directories and Oracle databases on Oracle Database Appliance.
- [Viewing Database Homes](#)  
Use the Web Console to display a list of database homes and database home details, including databases associated with a DB home.
- [Creating a Database Home](#)  
Use the Web Console to create database homes in Oracle Database Appliance.
- [Deleting a Database Home](#)  
Use the Web Console to delete an Oracle database home.

## About Managing Multiple Oracle Homes on Oracle Database Appliance

Create and manage one or more Oracle home directories and Oracle databases on Oracle Database Appliance.

Oracle home is the directory in which you install Oracle Database binaries, and from which Oracle Database runs. Oracle Database Appliance supports multiple Oracle homes, including support of different release Oracle Database homes. You can create multiple Oracle databases on a given Oracle home. Use Oracle Appliance Manager Web Console to create and manage multiple Oracle homes and databases on Oracle Database Appliance. Oracle Database Appliance Manager automatically creates an Oracle Database Oracle home that is compliant with Oracle's Optimal Flexible Architecture (OFA) standards.

Check the *Oracle Database Appliance Release Notes* to obtain information about the specific Oracle software releases supported for your Oracle Database Appliance platform.

When you use ODA CLI commands to create multiple homes on Oracle Database Appliance, the commands start the Oracle Home cloning process. In Oracle Database Appliance deployments, the user `oracle` is the default software installation owner.

You can use the Web Console or the command-line interface to create and manage databases.

Use ODA CLI commands to create, list, describe, and delete databases on Oracle Database Appliance. The `odacli create-database` command enables you to create a database with minimal user input. When you run this command without any additional options, the command creates a new database home (`ORACLE_HOME`). You can create a database in an existing home by using the `--dbhomeid` option. To find the `dbhomeid`, use the `odacli list-dbhomes` command.

Alternatively, you can use the Web Console to create list, describe and delete databases and database homes. You can display a list of all Database Homes that includes the database home name, ID, version, the date and time that the database home was created and the location on the same page. You can also create and delete database homes on the Web Console.

**▲ Caution:**

Do not apply Oracle Database patches directly to Oracle Databases on Oracle Database Appliance. Only use Oracle Database Appliance patch bundles, which are tested to work across the whole software stack. If a one-off database patch is required, it may be applied to the Oracle Home. When you apply the Oracle Database Appliance patch bundle, it may cause a conflict during future patching events and you might need to roll back and then re-apply the patch.

## Viewing Database Homes

Use the Web Console to display a list of database homes and database home details, including databases associated with a DB home.

1. Log in to the Web Console:

```
https://ip-address:7093/mgmt/index.html
```

2. Click the **Database** tab.
3. Click **Database Home** on the left menu to view all database homes. The name, ID, version, location and date and time stamp of when the database home was created appears on the page.
4. (Optional) Click **Actions** next to a database home entry, then **View Databases** to see the databases that are associated with the database home.

## Creating a Database Home

Use the Web Console to create database homes in Oracle Database Appliance.

Before you can create a database home, the Oracle Database Appliance RDBMS Clone file image must be in the repository. Follow these steps to create a database home:

1. Log in to the Web Console:

```
https://ip-address:7093/mgmt/index.html
```

2. Click the **Database** tab, then click **Database Home**.
3. Click **Create Database Home**.
4. Select a database version from the list of available versions, then select the database edition, either **Enterprise Edition** or **Standard Edition**, per your licensing agreement.
5. Click **Create**. When prompted, click **Yes** to confirm that you want to start the job.

## Deleting a Database Home

Use the Web Console to delete an Oracle database home.

You can delete a database home (DB Home) if it is not associated with any databases.

1. Log into the Web Console:

```
https://host name or ip-address:7093/mgmt/index.html
```

2. Click the **Database** tab.
3. Click **Database Home** on the left menu to view all database homes. The name, ID, version, location and date and time stamp of when the database home was created appears on the page.
4. Click **Actions** next to a database home entry, then **Delete**, and then confirm the action to delete a database home.

## Migrating Databases

Review these topics to learn how to prepare for and migrate an entire database to your Oracle Database Appliance.

- [About Migrating Databases](#)  
You can migrate an entire active container database (CDB) or non-CDB database to an Oracle Database Appliance machine by using the RMAN duplicate command.
- [Configuring a Static Listener](#)  
Configure a static listener before you duplicate a database.
- [Migrating a Database](#)  
Use the `RMAN Duplicate` command to migrate the entire database to the appliance.
- [Registering a Database](#)  
Use the `odacli register-database` command to register the migrated database with the appliance.

## About Migrating Databases

You can migrate an entire active container database (CDB) or non-CDB database to an Oracle Database Appliance machine by using the RMAN duplicate command.

When using RMAN Duplicate, ensure to have network connectivity from source and target databases:

- Source database: The existing database to be migrated.
- Target database: The new database created on an Oracle Database Appliance environment.

If you do not have network connectivity between the source and the target environments, you can use the offline migration method. Offline migration uses RMAN backup sets for duplication, which does not require connectivity to the primary database.

At a high level, the procedure involves the following steps:

1. **Deploy or update Oracle Database Appliance to the latest version.**  
Confirm that the provisioning completed successfully. On bare metal systems, use the command `odacli list-jobs` and the command `odacli describe-job` to verify the status.
2. **Create an instance only database from the command-line interface.**

- On bare metal systems, use the command `odacli create-database` with the `instanceonly` flag on an Oracle Database Appliance machine. The new database is the target database.

Creating an instance only database also creates the following:

- ACFS Filesystem used to store the database files
  - Directory structures that are required by the database instance/`rman duplicate` command
  - Password file for the SYS user
3. **Configure a static listener.**
  4. **Migrate the existing database to the target database using the backup and restore operations.**
  5. **Register the migrated database with the appliance.**

#### Note:

You can only migrate and register a database of the same storage type. For example, to migrate and register an Oracle ACFS database, you must create an Oracle ACFS database and then migrate and register it. Similarly, to migrate an Oracle ASM database, you must create an Oracle ASM database and then migrate it.

## Configuring a Static Listener

Configure a static listener before you duplicate a database.

The static listener is only required when using RMAN Duplicate command.

Perform the following steps to manually configure the `listener.ora` file:

1. Log in as a grid user.
2. Navigate to `/u01/app/18.0.0.0/grid/network/admin/` directory.
3. Edit the default `listener.ora` file and append the static database entry.

```
SID_LIST_LISTENER=
  (SID_LIST=
    (SID_DESC=
      (GLOBAL_DBNAME=db_unique_name with domain)
      (ORACLE_HOME=db home)
      (SID_NAME=db unique name)
      (ENVS="TNS_ADMIN=database home/network/admin"))
    )
```

For example, the following file is edited for an 18.7.0.0.0 database named `PRODDB` in the `example.com` domain:

```
SID_LIST_LISTENER=
  (SID_LIST=
    (SID_DESC=
```

```
(GLOBAL_DBNAME=PRODDB.example.com)
(ORACLE_HOME=/u01/app/oracle/product/18.0.0.0/dbhome_2)
(SID_NAME=PRODDB)
(ENVS="TNS_ADMIN=/u01/app/oracle/product/18.0.0.0/
dbhome_2/network/admin"))
)
```

4. Save the file.
5. Restart the listener.

```
srvctl stop listener -l listener
srvctl start listener -l listener
```

## Migrating a Database

Use the `RMAN Duplicate` command to migrate the entire database to the appliance.

Before migrating the database, verify that a network connection exists between the source and destination databases.

1. Verify that the `sysdba` connection to the auxiliary database is working. Use the password that you defined when you created the database with the `--instanceonly` flag.

```
sqlplus sys/password@hostname:PORT/GLOBAL_DBNAME as sysdba << EOF
select 1 from dual;
exit;
EOF
```

The following example uses the `Welcome_12` password for `myhost` on port 1521 for `PRODDB.example.com`.

```
sqlplus sys/Welcome_12@myhost:1521/PRODDB.example.com as sysdba << EOF
select 1 from dual;
exit;
EOF
```

2. As oracle user, set the `ORACLE_HOME` and `ORACLE_SID` environment variables.

```
ORACLE_HOME=path of Oracle Home against which the AUX DB is created
ORACLE_SID=database unique name
```

3. Display a list of all database storage configured on the appliance and database storage identifiers (ID).

Use the `odacli list-dbstorages` to display the storage IDs for all configured filesystems.

```
# odacli list-dbstorages
ID Type                               DBUnique Name                               Status
-----
```

```
68d13446-f26c-49ee-ab75-a393732aa88a   Asm       rdbl      Configured
ff2023d9-338d-4cff-8bb4-e73a89e32ce4   Acfs      PRODDB    Configured
```

4. Display the database storage details, including the DATA, RECO and REDO locations, for each database storage ID.

For example, use the `odacli describe-dbstorage` command to display information about the ACFS storage for ID 9fe39332-cc1a-4b4b-8393-165524a6ef6b.

```
# odacli describe-dbstorage -i ff2023d9-338d-4cff-8bb4-e73a89e32ce4
DBStorage details
-----
ID: ff2023d9-338d-4cff-8bb4-e73a89e32ce4
DB Name: PRODDB
DBUnique Name: PRODDB
DB Resource ID: c5b77384-634e-4dc8-b10b-fa2831d2c59b
Storage Type: Acfs
DATA Location: /u02/app/oracle/oradata/PRODDB
RECO Location: /u03/app/oracle/fast_recovery_area/
REDO Location: /u03/app/oracle/redo/
State: ResourceState(status=Configured)
Created: June 22, 2019 12:07:12 PM SGT
UpdatedTime: June 22, 2019 12:26:39 PM SGT
```

5. Duplicate the database.

Use the RMAN duplicate database command to duplicate the database.

```
rman target sys/Welcome__12@source database hostname:PORT
(Continued)
/Service Name auxiliary sys/Welcome_12@Hostname of the target database:
1521/service name
RUN {
SET NEWNAME FOR DATABASE TO NEW;
duplicate target database to PRODDB from active database
SPFILE
SET cluster_database 'false'
SET audit_file_dest '/u01/app/oracle/admin/PRODDB/adump'
SET db_create_file_dest '/u02/app/oracle/oradata/PRODDB'
SET db_create_online_log_dest_1 '/u03/app/oracle/redo'
SET db_recovery_file_dest '/u03/app/oracle/fast_recovery_area'
SET control_files '/tmp/control_PRODDB.ctl' nofilenamecheck;
}
```

## Registering a Database

Use the `odacli register-database` command to register the migrated database with the appliance.

The `dbclass`, `dbshape`, `servicename` and `password` are mandatory for registering the database. The `dbclass` and `dbshape` determine the `sga_target` and `pga_target` settings. The database `init.ora` parameters are reset as part of the `odacli register-database` command. Review the `init.ora` parameters after registration and ensure that the parameters set correctly.



 **Note:**

The `odacli register-database` command is supported only for primary database of type single-instance.

Follow these steps to register a database:

1. If you have Oracle Database version 12.1 with SQL patches, ensure that the `sqlpatches` are in the Oracle Database Appliance environment. If the patches are not in the environment, copy the `$OH/sqlpatch` directories from the source database home to the `$OH` in Oracle Database Appliance before executing the `odacli register-database` command

The `odacli register-database` command invokes the `datapatch` utility for applying the post patch SQLs. If the source database has any `sqlpatches` applied that are not present in the Oracle Database Appliance environment, then the `datapatch` will fail.

2. If you have Oracle Database version 11.2 with SQL patches, you must roll back any patches applied to the source database that are not part of the installed Oracle Database Bundle patch (BP).
3. Register the database with Oracle Database Appliance.

```
odacli register-database -c OLTP -s odbl -sn proddb.example.com -p
Password for SYS:
```

```
{
  "jobId" : "317b430f-ad5f-42ae-bb07-13f053d266e2",
  "status" : "Created",
  "message" : null,
  "reports" : [ ],
  "createTimestamp" : "August 08, 2018 05:55:49 AM EDT",
  "description" : "Database service registration with
                  db service name: proddb.example.com",
  "updatedAt" : "August 08, 2018 05:55:49 AM EDT"
}
rpandrap: ]# odacli describe-job -i "317b430f-ad5f-42ae-
bb07-13f053d266e2"
```

Job details

```
-----
ID: 317b430f-ad5f-42ae-bb07-13f053d266e2
Description: Database service registration with
             db service name: proddb.example.com
Status: Success
Created: November 23, 2018 5:55:49 AM EDT
Message:
```

Task Name	Start Time
restore control file	November 23, 2018 5:55:49 AM EDT
move spfile to right location	November 23, 2018 5:56:08 AM EDT
register DB with clusterware	November 23, 2018 5:56:13 AM EDT
reset db parameters	November 23, 2018 5:57:05 AM EDT
Running DataPatch	November 23, 2018 5:57:36 AM EDT

```
(Continued)
End Time                               Status
-----
November 23, 2018 5:56:08 AM EDT      Success
November 23, 2018 5:56:13 AM EDT      Success
November 23, 2018 5:57:05 AM EDT      Success
November 23, 2018 5:57:36 AM EDT      Success
November 23, 2018 5:57:49 AM EDT      Success
```

4. Use the `odacli list-databases` command to view the registered database.

## About Managing Multiple Database Instances Using Instance Caging

Use instance caging to manage your system resources on Oracle Database Appliance.

Oracle Database provides a method for managing CPU allocations on a multi-CPU server that runs multiple database instances. This method is called instance caging. Instance caging uses an initialization parameter to limit the number of CPUs that an instance can use simultaneously.

Instance caging and Oracle Database Resource Manager (the Resource Manager) work together to support your desired service levels across multiple instances. Consolidation can minimize idle resources, maximize efficiency, and lower costs.

Oracle Database Appliance templates are already tuned for the size of each database instance workload. They are designed to run on a specific number of cores. Instance caging ensures that each database workload is restricted to the set of cores allocated by the template, enabling multiple databases to run concurrently with no performance degradation, up to the capacity of Oracle Database Appliance. You can select database template sizes larger than your current needs to provide for planned growth.

### Note:

Oracle strongly recommends that you use the Oracle Database Appliance templates, because they implement best practices and are configured specifically for Oracle Database Appliance.

The Oracle Database Appliance Manager interface refers to the database sizing templates as database classes.

By default, instance caging is not enabled on Oracle Database Appliance. To enable instance caging, set the initialization parameter, `RESOURCE_MANAGER_PLAN`, for each database on Oracle Database Appliance. The parameter specifies the plan to be used by the Resource Manager for the current instance. Setting this parameter directs the Resource Manager to allocate core resources among databases. If a plan is not specified with this parameter, then the Resource Manager and instance caging are not enabled.

Instance caging allocation of core resources is enabled in accordance with the Oracle Database Appliance database template size that you select for each database. The `CPU_COUNT` initialization parameter is set in the template. Use the `CPU_COUNT` setting that matches the size of each database to consolidate, and follow the standard instructions for configuring instance caging.

## Oracle EM Express and DB Console

You can use Oracle Enterprise Manager Database Express (EM Express), or the Database Control Console (DB Console) to manage your database.

The EM Express console is available for Oracle Database 18c, 12.2.0.1, and 12.1.0.2. The DB Console is available for Oracle Database 11.2.0.4. Both consoles are web-based tools for managing Oracle Databases.

The EM Express console provides the following features:

- Support for basic administrative tasks, such as storage and user management
- Comprehensive solutions for performance diagnostics and tuning
- Performance advisors in a graphic user interface
- Oracle Database utilities in a graphic user interface, such as SQL\*Loader and Oracle Recovery Manager (RMAN)

EM Express is built inside the database server and cannot perform actions outside the database.

# 10

## Managing Storage

You can add storage to fully populate the base storage shelf and add a storage expansion shelf to your Oracle Database Appliance.

- [About Managing Storage](#)  
You can add storage at any time without shutting down your databases or applications.
- [Preparing for Storage Expansion](#)  
Review and perform these best practices before adding storage to the base shelf or adding the expansion shelf.

### About Managing Storage

You can add storage at any time without shutting down your databases or applications.

Oracle Database Appliance uses raw storage to protect data in the following ways:

- Flash or Fast Recovery Area (FRA) backup. Flash or fast recovery area is a storage area (directory on disk or Oracle ASM diskgroup) that contains redo logs, control file, archived logs, backup pieces and copies, and flashback logs.
- Mirroring. Double or triple mirroring provides protection against mechanical issues.

The amount of available storage is determined by the location of the FRA backup (external or internal) and if double or triple mirroring is used.

Oracle Database Appliance uses storage shelves, a base shelf and an optional storage expansion shelf. You can expand the base storage by adding a pack of solid-state drives (SSDs) to fully populate the base storage. You can further expand the storage by adding a second storage shelf. External NFS storage is supported for online backups, data staging, or additional database files.

 **Note:**

You must fully populate the base storage shelf before adding the expansion shelf.

When you add storage, Oracle Automatic Storage Management (Oracle ASM) automatically rebalances the data across all of the storage including the new drives. Rebalancing a disk group moves data between disks to ensure that every file is evenly spread across all of the disks in a disk group and all of the disks are evenly filled to the same percentage. Oracle ASM automatically initiates a rebalance after storage configuration changes, such as when you add disks.

## About Expanding Storage

If you need additional storage after fully populating the base shelf, you can add a storage expansion shelf. The expansion shelf is hot-pluggable, enabling you to expand storage without database downtime. After cabling and powering up the expansion shelf, the system automatically configures Oracle ASM storage and data is automatically distributed to the new shelf.

### Note:

The process of rebalancing the data might impact performance until the new storage is correctly balanced across all drives. If possible, add a storage expansion shelf during a non-peak or non-production time period to minimize the performance impact of the automatic storage balancing.

The addition of the storage expansion shelf includes checks across both nodes. It is important to confirm that SSH does work across the nodes and all users can connect as expected using their shared password.

The following are the high level steps to expand storage:

1. Review the Oracle Database Appliance storage options.
2. Prepare for a storage upgrade by running checks to verify that the configuration is ready before adding storage to the base shelf or adding the expansion shelf.
3. Add storage if the base configuration is not full.
4. Add the storage expansion shelf, then log in to each server node and validate the cabling. After you confirm that the cabling is correct, power on the shelf and validate the storage.

### Caution:

Review cabling instructions carefully to ensure that you have carried out cabling correctly. Incorrect connections can cause data loss when adding a storage expansion shelf to Oracle Database Appliance with existing databases.

## Preparing for Storage Expansion

Review and perform these best practices before adding storage to the base shelf or adding the expansion shelf.

1. Update Oracle Database Appliance to the latest Patch Bundle before expanding storage.

2. Confirm both nodes are at the same version and patch bundle level for software and firmware.

```
# odaadmcli show version -detail
```

```
# odaadmcli inventory -q
```

 **Note:**

If oakd is not running in the foreground mode, on either node, fix the problem before adding storage.

3. Check the disk health of the existing storage disks.

Run the check on both nodes and use the default checks option to check the NetworkComponents, OSDiskStorage, SharedStorage, and SystemComponents.

```
# odaadmcli validate -d
```

4. Run the `odaadmcli show diskgroup` command on each node to display and review Oracle Automatic Storage Management (Oracle ASM) disk group information. Verify that all disks are listed, are online, and are in a good state.

```
# odaadmcli show diskgroup data
```

```
# odaadmcli show diskgroup reco
```

```
# odaadmcli show diskgroup redo
```

5. Confirm Oracle ASM and CRS health on both nodes.

Run the `odaadmcli orachk` command on each node. If there is a problem connecting to either node, then check the `/etc/bashrc` file and remove (or remark out) any values in the profile for root, oracle, grid users.

Run `odaadmcli orachk` on Node 0:

```
# odaadmcli orachk
```

```
...
```

```
Checking Status of Oracle Software Stack - Clusterware, ASM, RDBMS
```

```
. . . . .
```

```
-----
-
Oracle Stack Status
-----
-
Host Name CRS Installed ASM HOME RDBMS Installed CRS UP ASM UP RDBMS UP DB Instance Name
-----
-
odax3rml Yes No Yes No No No No .....
```

```
-
```

```
...
```

Run `odaadmcli orachk` on Node 1:

```
# odaadmcli orachk
...

Checking Status of Oracle Software Stack - Clusterware, ASM, RDBMS

-----
-
Oracle Stack Status
-----
-
Host Name CRS Installed  ASM HOME   RDBMS Installed  CRS UP   ASM UP   RDBMS UP DB Instance Name
-----
-
odax3rm2   Yes           Yes           Yes           Yes     Yes     Yes     b22S2 b23S2
b24S2
-----
-
...
```

6. Confirm communications between the nodes and that SSH is working using the same password for `oracle`, `root`, and `grid`.

From each node:

- a. `ssh` to both nodes.
  - b. Ping both nodes.
7. Confirm there is at least 10 GB of space available on each node.

```
[root@oda]# df -h
```

```
[root@odb]# df -h
```

# 11

## Backup, Restore and Recover Databases

Review backup, restore, and recovery operations for your databases.

- [About Database Backup and Recovery Options](#)  
Backup your databases in Oracle Database Appliance and use the restore and recover features to restore a database to the same or another system or to recover database files.
- [Creating a Mount Point for NFS Backup Location](#)  
Create a mount point for the Network File System (NFS) location, to set up the NFS backup and recovery option.
- [Configuring Agent Proxy Settings for Object Store Access](#)  
If the Object Store IP address is accessible only through proxy setup by the Oracle Database Appliance server, then define the proxy setting for the agent, so that the agent can access the Object Store.
- [Creating a Database Backup Policy](#)  
Understand how to create a policy to backup a database to an internal or external Oracle Fast Recovery Area (FRA) location or to the Object Store using the Web Console.
- [Updating a Database with a Backup Policy](#)  
Attach a backup policy to a database to define the database backup attributes and destination.
- [Updating a Database Backup Policy](#)  
Use the Web Console to update the recovery window, change the ObjectStore Credential, or change the crosscheck option for a database backup policy.
- [Backing Up a Database Using the Web Console](#)  
Apply a backup policy to a database, create a manual backup, update a database backup schedule, or update an archive log backup.
- [Viewing Backup Reports](#)  
Understand how you can use the Web Console to view backup reports.
- [Recovering a Database Using the Web Console](#)  
Understand the recovery options available for recovering a database.
- [Deleting a Backup Using the Web Console](#)  
Use the Web Console to delete database backups.
- [Deleting a Backup Policy](#)  
Use the Web Console to delete a database backup policy.
- [Using the CLI to Backup, Restore, and Recover](#)  
Use the command-line interface to backup, restore, and recover databases.

### About Database Backup and Recovery Options

Backup your databases in Oracle Database Appliance and use the restore and recover features to restore a database to the same or another system or to recover database files.



It is important to create a backup recovery strategy to protect the databases in Oracle Database Appliance from data loss due to a physical problem with a disk that causes a failure of a read from or write to a disk file that is required to run the database, or due to user error. The backup feature provides the ability to PITR restore the database. You can create a backup policy in the Web Console or from the command-line interface.

The following backup options are available:

- Backup to an Oracle Fast Recovery Area (FRA) disk (Internal FRA)
- Backup to Oracle Cloud Infrastructure Object Storage (Oracle Object Storage)
- Backup to a Network File System (NFS) location (External FRA)

You can use the backup, restore, and recovery features with databases that have backup policy attached to them in the system. You can choose to manage your backups, and set up your backup, restore, and recovery option.

The backup feature enables you to create a backup policy with your backup parameters, including backup level and location. For new and existing databases, you can create and attach a backup policy to a database to perform a daily backup. Once a backup policy is attached to a database, the `dcS-agent` schedules daily automatic backups for the database. It also schedules archivelog backups for the database. By default, the frequency of the archivelog backup is 30 minutes. The default schedule is a level 0 backup every Sunday and a level 1 backup Monday through Saturday. You can edit or disable the schedule.

The `dcS-agent` generates and saves a backup report for each backup. The backup report contains the metadata required to recover or restore a database.



#### Note:

You cannot backup databases that use Transparent Data Encryption (TDE).

Recovering a database in Oracle Database Appliance is a full or whole database recovery using RMAN. You can recover from a Backup Report, a point-in-time (PITR), a System Change Number (SCN), or from the latest backup. For recovery of data block, tablespaces, data files, PDBs, see the *Oracle Database Backup and Recovery Reference Guide*.

### Backup Policy

The backup policy defines the backup details. When you create a backup policy, you define the destination for the database backups, either Internal FRA (Disk) or External FRA (NFS location), or Cloud Object Storage, and you define the recovery window.

If you use the Oracle Object Storage for backup and recovery, you must have an ObjectStore Resource ID or Name.

You can assign the backup policy to the database when you create the database. You can attach a backup policy to an existing database or update a backup policy.

### Backup Levels

The backup policy that you create defines the backup level:

- **Level 0:** The backup captures all blocks in the datafile. By default, level 0 backups occur every Sunday. You can customize your backup settings through the Web Console or the command-line. A level 0 backup is a full backup and is used as the parent for a level 1 backup.
- **Level 1:** The backup is an incremental backup that captures only those blocks that change between backups in each datafile. By default, a level 1 backup occurs daily, Monday through Saturday, and captures images of each block in a datafile that changed. Level 1 backups are differential backups. The backup includes blocks from the most recent previous level 1 or level 0 backup.
- **LongTerm:** The backup is a long-term, or archival backup. Use LongTerm to create a backup that is all-inclusive and exempt from the backup retention policy. The backup is all-inclusive because every file needed to restore and recover the database is backed up to a single location. The backup is exempt from the retention policy that is defined in the recovery window. For long term backups, you must use non-FRA locations for backup destinations using the backup policy options.
- **Archivelog:** This is a backup of all archivelogs not yet backed up to the backup destination, such as Internal FRA, External FRA (NFS location), or Object Store.

The AutoScheduler creates a level 0 backup on Level 0 Backup Day, by default, on Sunday, and level 1 on the remaining days of the week. You can display a list of scheduled backups, edit your backup schedule, or disable a scheduled backup. It also creates archivelogs backup for the database with a default frequency of 30 minutes.

### Backup to Disk

When you backup to disk, you are using the Oracle Fast Recovery Area (FRA) of the disk. FRA is a storage directory that allows backup and recovery operations on Oracle databases. The directory contains archived redo logs, backup pieces and copies, and the control file.

Advantages to backing up to disk are as follows:

- Quick recovery from backups stored on disk
- Automate management of recovery related files (like archived logs)

#### Note:

When you backup to disk, data is not encrypted and passwords are not allowed. In addition, backup to disk requires a lot of disk space (up to two to three times the size of the database).

The following is a high-level overview of the workflow for backup and recovery when using a disk:

1. Create a backup policy to define the backup location (disk) and recovery window for the disk destination.
2. Create a database and attach the backup policy to the database. When the backup policy is associated with a database, archivelog backups and database backups are automatically created.
3. Manage obsolete backups.

4. Recover the database from a backup on the disk.

### Backup to External FRA (Network File System)

Specifying a Network File System (NFS) location for backups, enables you to safely and securely store or retrieve a database backup at any time.

The advantages of using NFS backup location are:

- With NFS, you can access remote files, locally, by mounting local file systems on a network.
- Provides a centralized backup location, without requiring manual refresh.
- Supports enhanced security options using firewalls and Kerberos.
- Support for encrypted backups using passwords. You optionally, set the backup password, and provide the same during restore operation.

The following is a high-level overview of the workflow for backup and recovery when using an NFS location:

1. Create a mount point for the NFS location.

The mount point must be accessible from both nodes. The `oracle` user must have read/write permissions to the NFS location. If the request is being made to a remote server, ensure that it is running. See *Creating a Mount Point for NFS Backup Location* for the procedure to create a mount point.

2. Create a backup policy specifying the NFS location, and the recovery window for NFS destination.
3. Associate the database with this backup policy, either during database creation, or by updating the backup policy for the database.
4. Backups are automatically scheduled, and you can also run manual backups. You can specify manual backup options in the Web Console or using ODA CLI commands.
5. Manage obsolete backups.
6. Restore from backup. When you save your backups to NFS, you can restore the database to the same system or to a different system.
7. Recover the database from a backup on NFS.

### Backup to Oracle Object Storage

Oracle Object Storage is a highly secure, scalable storage platform that enables you to safely and securely store or retrieve a database backup at any time. Data and the associated metadata are stored as an object in a logical container (bucket). Oracle Database Appliance creates a Backup Report and a unique ID to identify each backup.

Oracle Object Storage is tightly integrated with Oracle Cloud Infrastructure Identity and Access Management. The data, user-defined metadata associated with the data, and encryption keys are automatically encrypted using 256-bit Advanced Encryption Standard (AES- 256). The encryption keys are rotated frequently and cannot be disabled. By default, only authenticated users that have explicitly been granted access to specific resources can access data stored in Oracle Object Storage. Data is uploaded and downloaded over SSL endpoints using the HTTPS protocol.

When you backup to Oracle Object Storage, you are using your backup policy and your Oracle ObjectStoreSwift credentials. The credentials are stored in an encrypted Oracle wallet. You can attach the credentials to one or more backup policies.

 **Note:**

Credentials are validated when you create the backup policy that uses Oracle Object Storage. The credentials are not validated against the URL and tenancy.

Advantages to using Oracle Object Storage are as follows:

- Backups are encrypted using the password for non-TDE databases.

 **Note:**

Save the password that you use during backups in a safe location, you must provide the password during recovery operations.

- Quick recovery from backups. With the Oracle Object Storage, you can safely and securely use the Web Console to store or retrieve data directly from within the cloud platform, at any time.
- Automate management of recovery related files (like archived logs)
- Oracle Object Storage is not directly accessed by the operating system, instead it uses APIs to access the storage at the application level.

The following is a high-level overview of the workflow for backup and recovery when using Oracle Object Storage:

1. Create an Object Store object with your credentials.
2. Create a backup policy to define the backup location (Object Store), Object Store Credentials Name, the container (bucket) name where you want to store backups, and the recovery window.
3. Create a database and attach the backup policy either as a part of creating the database, or update the database with backup policy after creating the database. When the backup policy is associated with a database, backups are automatically created.
4. Manage obsolete backups.
5. Restore from backup. When you save your backups to Oracle Object Storage, you can restore the database to the same system or to a different system.
6. Recover the database from a backup on Oracle Object Storage.

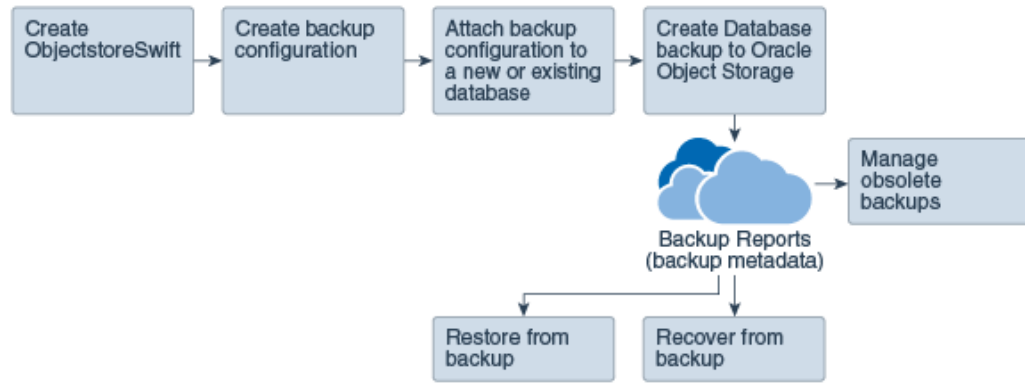

**Note:**

Before you can use this backup option, you must create an Oracle Cloud Infrastructure Object Storage account. When you create the account, you define the account credentials, end point URL, and bucket. Go to the [Oracle Store](#) and sign up for Oracle Cloud Infrastructure Object Storage.

### Backup Reports

A backup report is generated for each backup and is similar to, but does not replace, a recovery catalog. The report contains the Oracle Database Appliance information and metadata needed to restore or recover a database. The Backup Report is designed to keep track of all of the information required to restore or recover a database.

The following is an example of a level 1 backup report:

```

{
  "id" : "2d82460c-d648-4e75-8c7d-72cc90bc442a",
  "dbResId" : "b5fc646e-01a6-4c8b-8286-7633346c4329",
  "tag" : null,
  "dbId" : "2717054291",
  "dbName" : "HRDbO",
  "dbUniqueName" : "HRDbOu",
  "backupType" : "REGULAR-L1",
  "keepDays" : null,
  "backupLocation" : "https://swiftobjectstorage.us-phoenix-1.oraclecloud.com/v1/dbaasimage/backupbucket",
  "cfBackupHandle" : "c-2717054291-20171108-04",
  "spfBackupHandle" : "c-2717054291-20171108-04",
  "pitrTimeStamp" : "November 08, 2017 12:43:14 PM UTC",
  "pitrSCN" : "1175058",
  "resetLogsTimeStamp" : "November 08, 2017 09:55:34 AM UTC",
  "resetLogsSCN" : "1112268",
  "oraHomeVersion" : "12.2.0.1.170814 (26723265, 26609817)",
  "sqlPatches" : "25811364,26609817",
  "backupLogLoc" : "https://swiftobjectstorage.us-phoenix-1.oraclecloud.com/v1/dbaasimage/backupbucket/scaoda702c1n1/rmanlog/HRDbOu/2717054291/2017-11-08/rman_backup_2017-11-08_12-42-41.0545.log",
  "tdeWalletLoc" : null,
  "dbConfigLoc" : "https://swiftobjectstorage.us-phoenix-1.oraclecloud.com/v1/dbaasimage/backupbucket/scaoda702c1n1/dbconfig/HRDbOu/2717054291/2017-11-08/DBCONFIG_TAG20171108T124407_2017-11-08_12-44-07.0533.tar.gz",
  "name" : "Backup_Report_HRDbO",
  "createTime" : "November 08, 2017 12:42:08 PM UTC",
  "state" : {
    "status" : "CONFIGURED"
  },
  "updatedAt" : "November 08, 2017 12:44:12 PM UTC",
  "backupReportLogDetail" : "https://swiftobjectstorage.us-phoenix-1.oraclecloud.com/v1/dbaasimage/backupbucket/scaoda702c1n1/rmandetaillogreport/HRDbOu/2717054291/2017-11-08/rman_list_backup_detail_2017-11-08_12-44-04.0362.log",
  "dbInfo" : {
    "dbClass" : "OLTP",
    "dbType" : "RAC",
    "dbShape" : "odbl",
    "dbEdition" : "EE",
    "dbStorage" : "ASM"
  },
  "dbDataSize" : "1542M",
}

```

```
"dbRedoSize" : "16403M"  
}
```

## About Recovery Options

The recovery in Oracle Database Appliance always performs a full database restore or recover. The recovery options are LATEST, PITR, SCN, and BackupReport.

The following types of recovery are available:

- **LATEST:** Performs a complete recovery (valid backups and all required archived logs and online redo logs must be available)
- **PITR:** Point-in-Time Recovery that performs a recovery to a specified timestamp within the current incarnation of database
- **SCN:** SCN-based recovery that performs a recovery is an incomplete recovery to a specified SCN within the current incarnation of database.
- **BackupReport:** Performs a recovery based on the Backup Report SCN. The BackupReport option is similar to SCN, except that the recovery uses the Backup Report SCN instead of a specified SCN.

## Point-in-Time Database Recovery

Point-in-Time Recovery (PITR) recovers the database to a specific point-in-time. You must use specify the timestamp for this type of recovery.

A point-in-time recovery is often used for the following situations:

- You want to recover the database to an SCN before a user or administrative error.
- Complete database recovery failed because all necessary archived redo logs were not available.
- A database upgrade fails.
- You are creating a test database or a reporting database from production database backups.

## System Change Number Recovery

A system change number (SCN) is a stamp that defines a committed version of a database at a point in time. Oracle assigns every committed transaction a unique SCN. You can recover a database to the latest time or to an SCN.

The database is restored from backups created before the target time, and then applies incremental backups and logs to re-create all changes between the time of the data file backups and the end point of recovery. When the end point is specified as an SCN, the database applies the redo logs and stops after each redo thread or the specified SCN, whichever occurs first. When the end point is specified as a time, the database internally determines a suitable SCN for the specified time and then recovers to this SCN.

SCN is a primary mechanism to maintain data consistency in Oracle database. With each execution, there is an increase in the count of the SCN. The following are some examples of areas that use SCN:

1. **Redo records.** Every redo record has an SCN version of the redo record in the redo header (redo records can have non-unique SCN). Given redo records from two threads (as in the case of RAC), recovery will order them in SCN order, essentially maintaining a strict sequential order.

2. Data block. Every data block has block SCN (block version). In addition to that, a change vector in a redo record also has expected block SCN. This means that a change vector can be applied to one and only version of the block. Code checks if the target SCN in a change vector is matching with the block SCN before applying the redo record. If there is a mismatch, corruption errors are thrown.
3. Read consistency. Every query has query environment which includes an SCN at the start of the query. A session can see the transactional changes only if that transaction commit SCN is lower than the query environment SCN.
4. Commit. Every commit generates an SCN (commit SCN) that marks a transaction boundary. Group commits are possible too.

### Obsolete Database Backups

It is important to remove older backups once they become obsolete. The type of backup and the recovery window that you define in the database backup policy determines when database backups become obsolete.

For level 0 and level 1 backups, run the command `odacli delete-backup` for a given Database Resource Identifier to delete obsolete backups based on the defined recovery window.

For Longterm backups, provide the corresponding backup report as an input and use the command `odacli delete-backup` to delete the backups from Oracle Object Storage.

Typically, older level 0 and level 1 database backups are considered obsolete and deleted based on the defined recovery window, as follows:

- Disk: 1-14 days
- Object Storage: 1-31 days

## Creating a Mount Point for NFS Backup Location

Create a mount point for the Network File System (NFS) location, to set up the NFS backup and recovery option.

Follow these steps to create a mount point for the NFS location:

1. Follow these steps on the source machine:
  - a. Create a sharable location on the source machine and give full permissions to this directory.

```
# mkdir /tmp/nfs_test  
chmod 777 /tmp/nfs_test
```

- b. Add entries in the `/etc/exports` file in the format `shared_location destination_IPs (permissions)`.

For example:

```
# cat /etc/exports  
/tmp/nfs_test 192.0.2.1(rw, sync)  
/tmp/nfs_test 192.0.2.2(rw, sync)
```

- c. Restart the NFS server on the host.

```
service nfs restart
```

- d. Check the export list for the entries.

```
# showmount -e
Export list for oda1:
/tmp/nfs_test 192.0.2.1,192.0.2.2
```

2. Follow these steps on the client machine:

- a. Create a client location on the client machine as the `oracle` user.

```
# sudo -E -u oracle mkdir /tmp/client_location
```

- b. Mount this location with the source location in the format `mount_server:source_folder client_location`.

```
# mount 192.0.2.3:/tmp/nfs_test /tmp/client_location
```

- c. Check if the mount details are correct:

```
# mount
192.0.2.3:/tmp/nfs_test on /tmp/client_location type nfs
(rw,vers=4,addr=192.0.2.3,clientaddr=192.0.2.2)
```

Specify this NFS location in the backup configuration, either through the Web Console or CLI commands.

### Related Topics

- [Preparing for Database Backup to NFS Location](#)  
Use the command-line interface to create a policy to backup a database to an External FRA (NFS Location).

## Configuring Agent Proxy Settings for Object Store Access

If the Object Store IP address is accessible only through proxy setup by the Oracle Database Appliance server, then define the proxy setting for the agent, so that the agent can access the Object Store.

To create a backup policy that uses Object Store location, the agent must be able to access the Object Store URL.

1. Define the `HttpProxyHost` and `HttpProxyPort` settings in the `update-agentconfigParameters` command.

```
# odacli update-agentConfigParameters -n HttpProxyHost -v www-proxy.test.com -n HttpProxyPort -v 80 -u
```

```
Job details
```

```
-----
ID: 0b0cbf9b-b0ab-4523-a096-5da4e48fc825
Description: Update agent configuration parameter values
[HttpProxyHost, HttpProxyPort]
```



```
Status: Created
Created: October 23, 2018 4:56:53 PM IST
Message:
```

```
Task Name Start Time End Time Status
-----
```

For more information about the `agentconfigParameters` command usage, see the Oracle Database Appliance Command-Line Interface.

**2. Verify that the update succeeded:**

```
# odacli describe-job -i 0b0cbf9b-b0ab-4523-a096-5da4e48fc825
```

```
Job details
-----
ID: 0b0cbf9b-b0ab-4523-a096-5da4e48fc825
Description: Update agent configuration parameter values
[HttpProxyHost, HttpProxyPort]
Status: Success
Created: October 23, 2018 4:56:53 PM IST
Message:
```

```
Task Name Start Time End Time Status
```

**3. Run the `list-agentconfigParameters` command to view the changes in the proxy settings:**

```
# odacli list-agentConfigParameters
```

```
Name Value Description Updated
-----
HttpProxyHost www-proxy.test.com October 23, 2018 4:56:53 PM IST
HttpProxyPort 80 October 23, 2018 4:56:53 PM IST
HttpsProxyHost Https proxy server host October 23, 2018 12:23:21 AM IST
HttpsProxyPort Https proxy server port October 23, 2018 12:23:21 AM IST
OSPatchRepos Repo list for OS patching October 23, 2018 12:23:21 AM IST
```

You can now use the Web Console or the command-line interface to create a backup policy to use the ObjectStore location for backup.

**Related Topics**

- [odacli update-agentconfig-parameters](#)  
Use the `odacli update-agentconfig-parameters` command to modify configuration variables used by the appliance.
- [odacli list-agentconfig-parameters](#)  
Use the `odacli list-agentconfig-parameters` command to list configuration variables used by the appliance.

## Creating a Database Backup Policy

Understand how to create a policy to backup a database to an internal or external Oracle Fast Recovery Area (FRA) location or to the Object Store using the Web Console.

The backup policy defines the backup, including the location where you want to store the backups and the recovery window. Backup to disk requires a lot of disk space (up to two to three times the size of the database).

Follow these steps to create a backup policy from the Web Console:

1. Click the **Database** tab in the Web Console.
2. Click **Backup Policy** in the left navigation to display a list of backup policies.
3. Click **Create Backup Policy**.
4. Enter a name for the backup policy and select the number of days for the recovery window. Select **Enable Crosscheck** to determine if the files on the disk on in the media management catalog correspond to data in the RMAN repository. Select one of the following as the backup destination:
  - To backup to disk, select **Internal FRA** as the backup destination.
  - To backup to the cloud, select **ObjectStore** as the backup destination. If you have more than one Object Store, then select the Object Store Credential Name from the list. Enter a name in the Container Name field.
  - To backup to an NFS location, select **External FRA** as the backup destination, and specify the NFS mount point location.
  - To not define a destination, select **None**.

The Backup Policy name must begin with an alpha character and contain only alphanumeric characters.

The following figure shows the Create Backup Policy page.

The screenshot shows the 'Create Backup Policy' page in the Oracle Database Appliance Web Console. The page has a navigation menu on the left with 'Backup Policy' selected. The main content area contains a form with the following fields and options:

- Backup Policy Name \***: Text input field with the value 'Backup\_Policy'.
- Backup Destination**: A dropdown menu with options: External FRA, Internal FRA, External FRA, ObjectStore, and None.
- External FRA Mount Point \***: Text input field.
- Recovery Window (days) \***: A spinner control set to '1'.
- Enable Crosscheck**: A checked checkbox.

Below the 'Enable Crosscheck' checkbox, there is a note: "Select Enable Crosscheck to determine if files on disk or in the media management catalog correspond to data in the RMAN repository." At the bottom right of the form, there are '< Cancel' and 'Create >' buttons.

5. Click **Create**. Click **Yes** to confirm that you want to create the backup policy.  
A link to the job appears. When the job completes successfully, the backup configuration is ready.

Update an existing database to attach the backup configuration to the database using the ID or Name. When you attach the backup configuration to a database, the `dcs-agent` schedules daily automatic backups for the database.

## Updating a Database with a Backup Policy

Attach a backup policy to a database to define the database backup attributes and destination.

1. In the Web Console, click the **Database** tab, then select a database from the list.
2. In the Database Information page, click **Apply Backup Policy**.

If the action is disabled, then you must create a backup policy.

3. Select a backup policy from the list of available backup policies, and provide the **Backup Encryption Password**. Click **Apply**.
4. Expand the **Actions** menu, then click **View** to display the Database Information page.

The details include whether or not Auto Backup is enabled, the Backup Destination, and options to create a backup, enable or disable automatic backups, update the database, and archive log backup schedule.

5. (Optional) Click **Manual Backup** to create a single backup. Click **Update Database Backup Schedule** to schedule automatic backups. Click **Update Archive Log Backup Schedule** to schedule archive log backups.
6. Click the **Activity** tab to check the job status.

When the job completes successfully, the backup policy is associated with the database.

## Updating a Database Backup Policy

Use the Web Console to update the recovery window, change the ObjectStore Credential, or change the crosscheck option for a database backup policy.

Crosscheck determines if the files on the disk on in the media management catalog correspond to data in the RMAN repository.

1. Click the **Database** tab in the Web Console.
2. Click **Backup Policy** in the left navigation to display a list of backup policies.
3. Expand the **Actions** menu for a backup policy, then click **Update**.
4. To change the recovery window, use the up or down arrow to change the number of days.
5. To enable or disable the crosscheck, select or deselect **Enable Crosscheck**.
6. Click **Update**. Click **Yes** to confirm that you want to update the backup policy.

A link to the job appears. When the job completes successfully, the backup configuration is ready.

## Backing Up a Database Using the Web Console

Apply a backup policy to a database, create a manual backup, update a database backup schedule, or update an archive log backup.

You can use the Web Console or the command-line interface to create a database backup. In the command-line interface, use the command `odacli create-backup` for a specified Database.

Before creating a database backup, you must have a backup policy. The backup policy defines the recovery window and the backup destination. You must associate a backup policy with the database, otherwise you cannot create backups.

Follow these steps to backup a database from the Web Console:

1. In the Web Console, click the **Database** tab.
2. Click a database name to select a database from the list.
3. Review the database information, including the backup policy name and destination details. To select a backup policy for the database, click **Apply Backup Policy**. Select a policy and specify the **Backup Encryption Password**.
4. Click **Manual Backup**, **Update Database Backup Schedule** or **Update Archive Log Backup Schedule**.

If the action is disabled, then apply a backup policy.

5. Click **Yes** to confirm the job.

A link to the job appears. When the job completes successfully, the backup is ready. A list of backups appears at the bottom of the page.

## Viewing Backup Reports

Understand how you can use the Web Console to view backup reports.

A report is generated when a database backup is performed. The backup report lists the type, location, and date and timestamp of the backup.

1. In the Web Console, click the **Database** tab, then click the database name in the list of databases.

Information about the database appears on the Database Information page.

2. Scroll to the bottom of the page to view a list of Backups.
3. Click the Job ID for a backup to view the Backup Report and more details about the backup.

## Recovering a Database Using the Web Console

Understand the recovery options available for recovering a database.

1. In the Web Console, click the **Database** tab, then select a database from the list.
2. On the Database Information page, click **Recover**.
3. On the Recover Database page, select any of the following recovery options:

**Recover Full Database to the specified Backup:** Select the existing backup from which you want to recover the database

**Recover Full Database to the Latest:** Select this option to recover the database from the last known good state, with the least possible data loss.

**Recover Full Database to the specified Timestamp:** Specify the timestamp to recover the database.

**Recover Full Database to the System Change Number (SCN):** Specify the SCN of the backup from which you want to recover the database.

4. Specify and confirm the **Backup Encryption Password**.
5. Click the **Activity** tab to check the job status.

When the job completes successfully, the database is recovered as per the specified recovery options.

## Deleting a Backup Using the Web Console

Use the Web Console to delete database backups.

You can delete Level-0, Level-1, and Archive Log backups anytime. To delete long term backups, you must check the Backup Report for the database to determine when the backup is obsolete.

1. Click the **Database** tab in the Web Console.
2. Click the database name, in blue font, to display more details about the database for which you want to delete the backup.
3. Click **Delete Backups** .
4. Select the Backup type you want to delete, whether Level-0, Level-1, and Archive Log backup or long Term backup, then click **Start**. Click **Yes** to confirm that you want to delete the backup.

A link to the job appears. When the job completes successfully, the backup is deleted.

## Deleting a Backup Policy

Use the Web Console to delete a database backup policy.

1. Click the **Database** tab in the Web Console.
2. Click **Backup Policy** in the left navigation to display a list of backup policies.
3. Expand the **Actions** menu for a backup policy, then click **Delete**. Click **Yes** to confirm that you want to delete the backup policy.

A link to the job appears. When the job completes successfully, the backup policy is deleted.

## Using the CLI to Backup, Restore, and Recover

Use the command-line interface to backup, restore, and recover databases.

- [Preparing for Database Backup to Disk](#)  
Use the command-line interface to create a policy to backup a database to the Oracle Fast Recovery Area (FRA) of a disk.
- [Preparing for Database Backup to NFS Location](#)  
Use the command-line interface to create a policy to backup a database to an External FRA (NFS Location).
- [Preparing for Database Backup to Oracle Cloud](#)  
Create a backup configuration to backup a database to Oracle Cloud Infrastructure Object Storage.
- [Backing Up a Database with the CLI](#)  
Create a level 0, level 1, LongTerm database backup, or archivelog backup with the command-line interface.
- [Recovering a Database with the CLI](#)  
Recover the database to the system using a Backup Report, point-in-time recovery (PITR), a system change number (SCN), or from the latest backup time.
- [Restoring a Database with the CLI](#)  
Restore a database to a system from Oracle Object Storage using a Backup Report and the command-line interface.
- [Deleting Backups with the CLI](#)  
Delete older, obsolete level 0, level 1 and long term backups.

## Preparing for Database Backup to Disk

Use the command-line interface to create a policy to backup a database to the Oracle Fast Recovery Area (FRA) of a disk.

You can create a backup policy using the Web Console or the command-line interface. Most of the backup and recovery commands enable you to provide either a resource name or resource ID to identify the database.

Backup to disk or the **Backup to Internal FRA** option in the Web Console, requires a lot of disk space (up to two to three times the size of the database).

Follow these steps to create a backup policy through the command-line interface:

1. Create a BackupConfig object (backup configuration) using the command `odacli create-backupconfig`.

The backup configuration defines the backup, including the location where you want to store the backups and the recovery window.

The following example creates a backup configuration named `mkgldailydisk` with a backup to disk and a 1 day recovery window.

```
# odacli create-backupconfig -d Disk -n mkgldailydisk -w 1
```

2. Check the job status.

```
# odacli list-jobs
```

When the job completes successfully, the backup configuration is ready.

3. Update an existing database to attach the backup configuration to the database using the ID or Name.

When you attach the backup configuration to a database, the `dc-agent` schedules daily automatic backups for the database.

The following example uses the Database Resource ID and Backup Configuration ID:

```
# odacli update-database -i d3c4d8f6-5eb7-4f9e-ab27-7bdd5013ac90 -bi 9d942e0a-ba00-4cbc-9bfb-0de83ed279e5 -bp
```

The following example uses the Database Resource Name, `mydb` and the Backup Configuration Name, `mydb`:

```
# odacli update-database -in mydb -bin mybcfg -bp
```

You can create manual backups or scheduled backups to disk.

## Preparing for Database Backup to NFS Location

Use the command-line interface to create a policy to backup a database to an External FRA (NFS Location).

You can create a backup policy using the Web Console or the command-line interface. Most of the backup and recovery commands enable you to provide either a resource name or resource ID to identify the database.

Backup to NFS location or the **Backup to External FRA** option in the Web Console, requires creation of an NFS mount point.

Follow these steps to create a backup policy through the command-line interface:

1. Create a BackupConfig object (backup configuration) using the command `odacli create-backupconfig`.

The backup configuration defines the backup, including the location where you want to store the backups and the recovery window.

The following example creates a backup configuration named `mkg1dailydiskwith` a backup to `disk` and a 1 day recovery window.

```
# odacli create-backupconfig -d NFS -n mkg1dailynfs -c absolute-path-to-parent-directory-for-NFS-destination -w 1
```

2. Check the job status.

```
# odacli list-jobs
```

When the job completes successfully, the backup configuration is ready.

3. (Optional) Update an existing database to attach the backup configuration to the database using the ID or Name.

When you attach the backup configuration to a database, the `dc-agent` schedules daily automatic backups for the database.

The following example uses the Database Resource ID and Backup Configuration ID:

```
# odacli update-database -i d3c4d8f6-5eb7-4f9e-ab27-7bdd5013ac90 -bi
9d942e0a-ba00-4cbc-9bfb-0de83ed279e5 -bp
```

The following example uses the Database Resource Name, `mydb` and the Backup Configuration Name, `mydb`:

```
# odacli update-database -in mydb -bin mybcfg -bp
```

You can create manual backups or scheduled backups to NFS location.

### Related Topics

- [Creating a Mount Point for NFS Backup Location](#)  
Create a mount point for the Network File System (NFS) location, to set up the NFS backup and recovery option.

## Preparing for Database Backup to Oracle Cloud

Create a backup configuration to backup a database to Oracle Cloud Infrastructure Object Storage.

Before you can backup to Oracle Object Storage, you must sign up for an Oracle Cloud Infrastructure Object Storage account and know your Oracle Object Storage credentials. When you create an Oracle ObjectStoreSwift object, the command creates and stores the credential details in the system and stores the password in an encrypted Oracle wallet. The Oracle wallet contains your tenant name, user name, and defines the end point URL.

Go to the Oracle Store to sign up for Oracle Cloud Infrastructure Object Storage.

1. Create an Oracle ObjectStoreSwift object using the command `create-objectstoreswift`. If you already have an Oracle wallet for Oracle Database Appliance, skip to Step 2.

```
# odacli create-objectstoreswift -e swift end point URL -n Object
Store Swift name [-p] swiftpassword -t Object Store tenant name -u
Object Store user name
```

For example:

```
# odacli create-objectstoreswift -e https://
swiftobjectstorage.r1.oracleiaas.com/v1 -n ossn1 -t mytenant -u
user.name@example.com -p
```

The output includes an `objectstoreswift` Resource ID to identify an ObjectStoreSwift credential.

2. Create a BackupConfig object (backup configuration) using the command `odacli create-backupconfig`.



The backup configuration defines the backup, including the location (container) where you want to store the backups, the recovery window, and the credentials that are defined in your encrypted Oracle wallet.

The following example creates a backup configuration named `hr_7d_cloud` with a backup to the `ObjectStore`. The following backup parameters are defined: the container is `hr_bucket`, `crosscheck` is not enabled, the recovery window is 7 days, and the `ObjectStoreSwift` Resource ID is provided, which attaches the Oracle Wallet and credentials to the backup configuration.

```
# odacli create-backupconfig -n hr_7d_cloud -d ObjectStore -w 7 -o
b974f006-5503-4949-ab6c-6f1a56e4ac37 -c hr_bucket -no-cr
```

 **Note:**

If the `ObjectStoreSwift` Object was not created with valid credentials, then creating the backup configuration will fail.

3. Check the job status.

```
# odacli list-jobs
```

When the job completes successfully, the backup configuration is ready. When you create a new database, you have the option to associate the database with a backup configuration.

4. (Optional) Update an existing database to attach the backup configuration to the database.

When you attach the backup configuration to a database, the `dcs-agent` schedules daily automatic backups for the database.

```
# odacli update-database -i e3c4d8f6-5eb7-4f9e-ab27-7bdd5013ac10 -bi
7d942e0a-ba00-4cbc-9bfb-0de83ed279e5 -bp
```

You can create manual backups outside of scheduled backups, view backup reports, or disable automatic backups.

## Backing Up a Database with the CLI

Create a level 0, level 1, LongTerm database backup, or archivelog backup with the command-line interface.

You can create a database backup in the Web Console or with the command-line interface. When you attach a backup configuration object to a database, the `dcs-agent` automatically schedules daily backups for the database. The day and time are based on the Oracle Database Appliance time zone. The `AutoSchedule` triggers a level 0 Backup every Sunday, a level 1 the other 6 days of the week, and an archivelog backup every 30 minutes. Use the command `odacli update-schedule` to disable or change the scheduled backup time.

To create a Long Term database backup, or a level 0 or level 1 backup outside of the automatic backups, use the command `odacli create-backup`.

 **Note:**

To recover a database, there must be a level 0 backup taken, so that the backup report contains information about the base backup. Restoring a database to the same system with a different DB Name and DB Unique Name or to another system does not always require a long term database backup report. You can use archivelog, or level 0, or level 1 backup reports as well. If you use the archivelog backup report, a prior database backup must exist. To restore a database to another system, you must have a long term database backup in Oracle Object Storage.

1. Verify that a backup configuration object is associated with the database.
2. Create a single backup, outside of the automatic backups, by using the command `odacli create-backup`.

Use the Database Resource ID to identify the database to backup, specify the type of backup, and use a tag to create a name for the backup. You can use up to 30 alphanumeric characters for the backup name tag. If you do not select a backup type (level 0, level 1, LongTerm, or archivelog backup), a level 1 backup is performed. For example, create a level 0 backup named `2018Jan02_HRLevel10` for resource ID `20576eb1-bc32-4e34-bf97-fda0b60ca15b`

```
# odacli create-backup -i 20576eb1-bc32-4e34-bf97-fda0b60ca15b -bt
Regular-L0 -t 2018Jan02_HRLevel10
```

When the job finishes, a backup report is generated for the backup. The report contains all of the metadata required to recover a database.

3. (Optional) Display a list of backup reports.

```
# odacli list-backupreports
```

4. (Optional) Display a list of all scheduled backups.

```
# odacli list-schedules
```

## Recovering a Database with the CLI

Recover the database to the system using a Backup Report, point-in-time recovery (PITR), a system change number (SCN), or from the latest backup time.

Recovering a database in Oracle Database Appliance is a full RMAN database recovery.

Recovering from a backup report requires JSON input for the backup report.

1. Display a list of backup reports and locate the latest Backup Report for the database and save the Backup Report ID.

```
# odacli list-backupreports
```

2. Use the Backup Report ID to display the details of the Backup Report. Determine how you want to recover the database: PITR, SCN, or Latest and locate the needed information in the Backup Report.

```
# odacli describe-backupreport -i 2d82460c-d648-4e75-8c7d-72cc90bc442a
{
  "id" : "2d82460c-d648-4e75-8c7d-72cc90bc442a",
  "dbResId" : "b5fc646e-01a6-4c8b-8286-7633346c4329",
  "tag" : null,
  "dbId" : "2717054291",
  "dbName" : "ExampleDB",
  "dbUniqueName" : "ExampleDBu",
  "backupType" : "REGULAR-L1",
  "keepDays" : null,
  "backupLocation" : "https://swiftobjectstorage.example.com/v1/
dbaasimage/backupbucket",
  "cfBackupHandle" : "c-2717054291-20180108-04",
  "spfBackupHandle" : "c-2717054291-20180108-04",
  "pitrTimeStamp" : "January 08, 2018 12:43:14 PM UTC",
  "pitrSCN" : "1175058",
  "resetLogsTimeStamp" : "January 08, 2018 09:55:34 AM UTC",
  "resetLogsSCN" : "1112268",
  "oraHomeVersion" : "12.2.0.1.170814 (26723265, 26609817)",
  "sqlPatches" : "25811364,26609817",
  "backupLogLoc" : "https://swiftobjectstorage.example.com/v1/
dbaasimage/backupbucket/system_namecln1/
rmanlog/ExampleDBu/2717054291/2018-01-08/
rman_backup_2018-01-08_12-42-41.0545.log",
  "tdeWalletLoc" : null,
  "dbConfigLoc" : "https://swiftobjectstorage.example.com/v1/dbaasimage/
backupbucket/system_namecln1/
dbconfig/ExampleDBu/2717054291/2018-01-08/
DBCONFIG_TAG20180108T124407_2018-01-08_12-44-07.0533.tar.gz",
  "name" : "Backup_Report_ExampleDB",
  "createTime" : "January 08, 2018 12:42:08 PM UTC",
  "state" : {
    "status" : "CONFIGURED"
  },
  "updatedAt" : "January 08, 2018 12:44:12 PM UTC",
  "backupReportLogDetail" : "https://swiftobjectstorage.example.com/v1/
dbaasimage/backupbucket/system_namecln1/
rmandetaillogreport/ExampleDBu/2717054291/2018-01-08/
rman_list_backup_detail_2018-01-08_12-44-04.0362.log",
  "dbInfo" : {
    "dbClass" : "OLTP",
    "dbType" : "RAC",
    "dbShape" : "odbl",
    "dbEdition" : "EE",
    "dbStorage" : "ASM"
  },
  "dbDataSize" : "1542M",
  "dbRedoSize" : "16403M"
}
```

3. To recover from a backup report, based on PITR, identify the database ID and the backup report for recovery.

In the following example, the JSON input file for the backup report is `backupreport.json`.

```
# odacli recover-database -i b5fc646e-01a6-4c8b-8286-7633346c4 -br
backupreport.json -p
```

4. To recover based on PITR, identify the database ID and the date and time stamp for recovery.

```
# odacli recover-database -i b5fc646e-01a6-4c8b-8286-7633346c4 -t PITR -
r 01/08/2018 12:57:33 -p
```

5. To recover based on SCN, identify the database ID and the SCN number.

```
# odacli recover-database -i b5fc646e-01a6-4c8b-8286-7633346c4 -t SCN -
s 392375947
```

6. To recover based on the latest backup, identify the database ID and use the Latest option.

```
# odacli recover-database -i b5fc646e-01a6-4c8b-8286-7633346c4 -t
Latest -p
```

7. Validate that the job completed. You can track the job in the **Activity** tab in the Web Console, or run the command `odacli describe-job` with the job ID.

```
# odacli describe-job -i jobId
```

When the job completes successfully, the recovery is complete.

## Restoring a Database with the CLI

Restore a database to a system from Oracle Object Storage using a Backup Report and the command-line interface.

When you restore a database, environment and validation checks and setup tasks are performed. Restoring a database requires a number of tasks and configuration details, such as creating database storage, Oracle Home, recreating the control file, registering the database, and establishing RMAN restore and recovery. An Oracle Database Appliance backup report is generated for each backup and contains the metadata required to restore a database. The report is designed to help you to quickly and efficiently restore a database.

You can restore a database from one appliance to another appliance, or to the same appliance when the source database is deleted:

- To restore to a different system, copy the backup report generated by the command `odacli create-backup` to the other machine's `\bin` folder and use the command `odacli irestore-database` with the backup report.
- To restore to the same system, delete the source database and use the backup report generated by the command `odacli create-backup`.

To restore a database to another system, you must have a database backup report in Oracle Object Storage, valid credentials in an Oracle wallet (ObjectStoreSwift), the Swift Object Store credential ID, and the SYS user password.

Follow these steps to restore a database using the command-line (CLI):

1. Display a list of backup reports and locate the latest Backup Report in Oracle Object Storage for the database and save the Backup Report ID.

```
# odacli list-backupreports
```

2. Use the Backup Report ID to display the details of the Backup Report.

```
# odacli describe-backupreport -i 2d82460c-d648-4e75-8c7d-72cc90bc442a
{
  "id" : "2d82460c-d648-4e75-8c7d-72cc90bc442a",
  "dbResId" : "b5fc646e-01a6-4c8b-8286-7633346c4329",
  "tag" : null,
  "dbId" : "2717054291",
  "dbName" : "ExampleDB",
  "dbUniqueName" : "ExampleDBu",
  "backupType" : "REGULAR-L1",
  "keepDays" : null,
  "backupLocation" : "https://swiftobjectstorage.example.com/v1/dbaasimage/backupbucket",
  "cfBackupHandle" : "c-2717054291-20180108-04",
  "spfBackupHandle" : "c-2717054291-20180108-04",
  "pitrTimeStamp" : "January 08, 2018 12:43:14 PM UTC",
  "pitrSCN" : "1175058",
  "resetLogsTimeStamp" : "January 08, 2018 09:55:34 AM UTC",
  "resetLogsSCN" : "1112268",
  "oraHomeVersion" : "12.2.0.1.170814 (26723265, 26609817)",
  "sqlPatches" : "25811364,26609817",
  "backupLogLoc" : "https://swiftobjectstorage.example.com/v1/dbaasimage/backupbucket/system_namecn1/
rmanlog/ExampleDBu/2717054291/2018-01-08/rman_backup_2018-01-08_12-42-41.0545.log",
  "tdeWalletLoc" : null,
  "dbConfigLoc" : "https://swiftobjectstorage.example.com/v1/dbaasimage/backupbucket/system_namecn1/
dbconfig/ExampleDBu/2717054291/2018-01-08/
DBCONFIG_TAG20180108T124407_2018-01-08_12-44-07.0533.tar.gz",
  "name" : "Backup_Report_ExampleDB",
  "createTime" : "January 08, 2018 12:42:08 PM UTC",
  "state" : {
    "status" : "CONFIGURED"
  },
  "updatedTime" : "January 08, 2018 12:44:12 PM UTC",
  "backupReportLogDetail" : "https://swiftobjectstorage.example.com/v1/dbaasimage/backupbucket/
system_namecn1/
rmandetaillogreport/ExampleDBu/2717054291/2018-01-08/
rman_list_backup_detail_2018-01-08_12-44-04.0362.log",
  "dbInfo" : {
    "dbClass" : "OLTP",
    "dbType" : "RAC",
    "dbShape" : "odbl",
    "dbEdition" : "EE",
    "dbStorage" : "ASM"
  },
  "dbDataSize" : "1542M",
  "dbRedoSize" : "16403M"
}
```

3. (Optional) If you need to generate a new backup report, use the command `odacli create-backup`.

```
# odacli create-backup
```

4. Locate the Swift Object Store credential ID for the database backup.

```
# odacli list-objectstoreswifts
```

5. Save the backup report as a JSON file in a folder in the `\bin` directory on the appliance. For example, `backupreport.json`.
6. Restore the database to the system using the JSON file in the command `odacli irestore-database`.

Run the command, then enter the SYS user password when prompted.

```
# odacli irestore-database -r backupreport.json -oid Object Store ID -m
```

7. Validate that the job completed. You can track the job in the **Activity** tab in the Web Console, or run the command `odacli describe-job` with the job ID.

```
# odacli describe-job -i jobId
```

## Deleting Backups with the CLI

Delete older, obsolete level 0, level 1 and long term backups.

For level 0 and level 1 backups, the recovery window defined in the Backup Configuration determines when the backup is obsolete. The ranges are as follows:

- Backup to disk: between 1 and 14 days
- Backup to the Oracle Object Storage: between 1 and 31 days

For Long Term backups to the Oracle Object Storage, view the Backup Report for a database to determine when the backup is obsolete. To delete Long Term Backup, the Database Resource ID or Database name and the Backup Report are required.

Follow these steps to delete database backups using `odacli` commands:

1. Display a list of all backup reports.

```
# odacli list-backupreports
```

2. Obtain the Database ID and type of backup.

```
# odacli describe-backupreport -i Backup Report ID
```

3. To delete obsolete level 0 and level 1 backups, use the Database ID or Database Name to delete the backup.

```
# odacli delete-backup -i 20576eb1-bc32-4e34-bf97-fda0b60ca15b
```

4. To delete Long Term backups, use the Backup Report and a JSON file to delete the backup.

In the following example, the JSON input file for the backup report is `backupreport.json`.

```
# odacli delete-backup -i 20576eb1-bc32-4e34-bf97-fda0b60ca15b -br  
backupreport.json
```

# 12

## Managing an Oracle Database Appliance Virtualized Platform

Review the concepts and procedures for Oracle Database Appliance Virtualized Platform.

These topics provides a conceptual overview of the Oracle Database Appliance Virtualized Platform architecture, and procedures for how to deploy a guest virtual machine, manage high availability, manage CPU pools, and configure network settings for Oracle Database Appliance Virtualized Platform. Learn about resizing your Oracle Database domain (ODA\_BASE), a privileged virtual machine.

- [About Oracle Database Appliance Virtualized Platform](#)  
You can use Oracle VM to optimize your system resource use for databases and applications.
- [Oracle Database Appliance Virtualized Platform Architecture](#)  
Review these topics to understand Oracle Database Appliance Virtualized Platform, and how you can use it to optimize system resource use.
- [About Network Infrastructure and VLANs on Oracle Database Appliance Virtualized Platform](#)  
Oracle Database Appliance Virtualized Platform supports multiple VLANs on the same network port or bond.
- [Configuring Additional Networks on Virtualized Platform](#)  
Use the `oakcli configure additionalnet` command to create additional networks.
- [How to Create and Manage Shared Repositories](#)  
These topics describe how to use OAKCLI to create and manage shared repositories on Oracle Database Appliance Virtualized Platform.
- [How to Manage Virtual Disks in Shared Repositories](#)  
These topics describe how to use OAKCLI to create, view, clone, attach, and delete virtual disks on Oracle Database Appliance Virtualized Platform.
- [How to Manage Virtual Machine Templates](#)  
These topics describe how to use OAKCLI to import, configure, modify and check virtual machine templates on Oracle Database Appliance Virtualized Platform.
- [How to Create Clones and Snap Clones of a Template](#)  
Review these topics for an overview of clones and snap clones, and for procedures to use to create clones.
- [How to Manage Virtual Machines on Oracle Database Appliance Virtualized Platform](#)  
Review these topics for an overview of virtual machines, and for procedures to create and manage virtual machines.
- [How to Create Driver Domain Virtual Machines](#)  
Use driver domain virtual machines to improve performance.

- [How to Manage High Availability on Oracle Database Appliance Virtualized Platform](#)  
Use the `oakcli configure vm` command to configure high availability services for your virtual machines.
- [How to Manage CPU Pools on Oracle Database Appliance Virtualized Platform](#)  
These topics describe how to use OAKCLI to create and manage CPU pools on Oracle Database Appliance Virtualized Platform.

## About Oracle Database Appliance Virtualized Platform

You can use Oracle VM to optimize your system resource use for databases and applications.

You can deploy a virtualized platform on Oracle Database Appliance. The virtual platform is based on Oracle VM. With Oracle Database Appliance Virtualized Platform, you can use the capabilities of Oracle VM to effectively allocate resources to databases and applications running on the same physical Oracle Database Appliance. Rather than simply disabling unnecessary server cores, you can use the excess capacity to host other workloads. This enables consolidation of both databases and applications, while retaining the ease of deployment and management associated with Oracle Database Appliance.

Oracle Database Appliance Virtualized Platform is supported on all versions of Oracle Database Appliance hardware. All templates and operating systems supported by Oracle VM are also supported on Oracle Database Appliance Virtualized Platform. Supported operating systems include Linux, Windows, and Solaris x86.



### Note:

All new systems are currently shipped from the factory with the nonvirtualized ISO image

If you are currently on the nonvirtualized deployment of Oracle Database Appliance, and you want to use Oracle Database Appliance as a virtualized platform, then you must reimage the servers with the Oracle Database Appliance Virtualized Platform ISO image.

### Why Virtualize?

Oracle Appliance Manager (oakcli) makes it easy to setup and manage the virtualized environment with little virtualization expertise. With the Virtualized Platform deployment, you can consolidate entire multi-tier environments within a single Oracle Database Appliance system.

The following are some of the advantages of deploying Oracle Database Appliance with the Virtualized Platform option:

- Deploy database and applications in a single hardware environment.
- Use the pre-configured VM application templates to rapidly deploy database and applications.
- Run the database in a virtual machine (ODA\_BASE) with direct access to storage (for native performance).



- Control licensed CPUs by configuring ODA\_BASE domain with the required number of CPU cores (and memory).
- Use your CPU cores (and memory) efficiently. CPU cores not assigned to the ODA\_BASE domain are not wasted and are available for use by other, non-database virtual machines.
- Use virtual local area networks (VLANs) to provide separate networks to different virtual machines.
- Use shared repository to grow storage for the virtual machine (VM) repository.
- Improves data center efficiency by increasing space utilization and reducing energy consumption and cooling costs.

## Oracle Database Appliance Virtualized Platform Architecture

Review these topics to understand Oracle Database Appliance Virtualized Platform, and how you can use it to optimize system resource use.

- [About Oracle Database Appliance Virtualized Platform Architecture](#)  
Review this topic to understand how Oracle Database Appliance Virtualized Platform works with Oracle Database Appliance hardware.
- [About Virtual Machines and Oracle Database Appliance Virtualized Platforms](#)  
Oracle Database Appliance Virtualized Platform is designed to run and deploy virtual machines to manage system resources.

## About Oracle Database Appliance Virtualized Platform Architecture

Review this topic to understand how Oracle Database Appliance Virtualized Platform works with Oracle Database Appliance hardware.

Oracle Database Appliance Virtualized Platform provides virtualization technology that enables multiple isolated databases and applications to share the same physical server. The Oracle Database Appliance Virtualized Platform ISO image is engineered specifically to leverage the Oracle Database Appliance hardware capabilities.

The Oracle Database Appliance Virtualized Platform architecture uses the virtual machine components shown in the following illustration:

**Figure 12-1 Oracle Database Appliance Virtualized Platform Architecture**

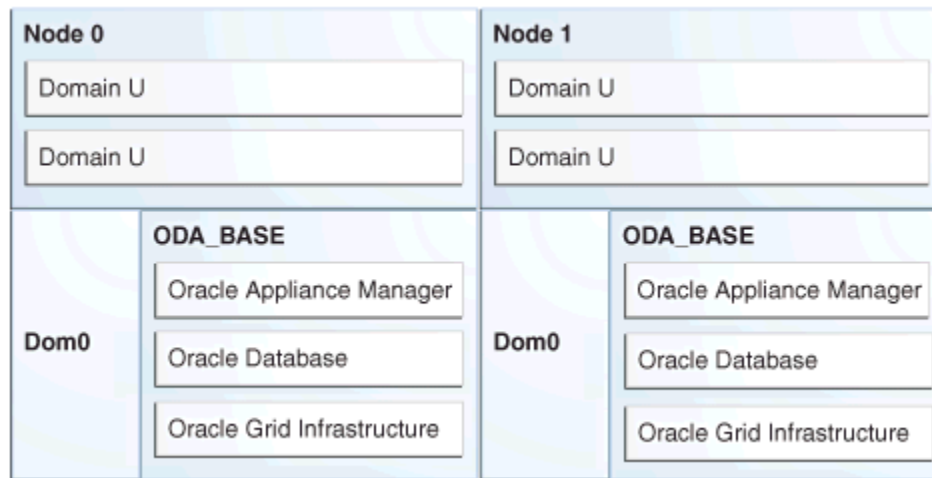

- **Oracle Database Appliance Base Domain (ODA\_BASE):** A privileged virtual machine domain, specifically for databases, that provides database performance similar to bare metal deployments. A PCI pass-through driver provides ODA\_BASE direct access to the shared storage.
- **Domain 0 (Dom0):** Default domain that initiates Oracle Database Appliance Virtualized Platform provisioning processes and hosts virtual machine templates. Most of the responsibility of hardware detection in an Oracle Database Appliance Virtualized Platform environment is passed to the management domain, referred to as domain zero (or Dom0). On x86-based servers, the Dom0 kernel is actually a small-footprint Linux kernel with support for a broad array of devices, file systems, and software RAID and volume management. In Oracle Database Appliance Virtualized Platform, Dom0 provides access to much of the system hardware, creating, deleting and controlling guest operating systems, and presenting those guests with a set of common virtual hardware.
- **Guest Domains (Domain U):** Virtual machines that are provisioned to host non-database workloads, such as applications and middleware. Guest operating systems each have their own management domain, called a *user domain*, abbreviated to "Domain U". These domains are unprivileged domains that have no direct access to the hardware or to the device drivers. Each Domain U starts after Dom0 is running on Oracle Database Appliance Virtualized Platform.

## About Virtual Machines and Oracle Database Appliance Virtualized Platforms

Oracle Database Appliance Virtualized Platform is designed to run and deploy virtual machines to manage system resources.

Configure virtual machines on Oracle Database Appliance Virtualized Platform to manage your application use of shared repository resources, such as the CPU pool, memory, and other shared resources.

## Virtual Machine Templates

Virtual machines can be created from a template or assembly containing preconfigured virtual machines. The creation of a virtual machine from a template is based on cloning: the template is imported as an archive, unpacked, and stored as a virtual machine configuration file with disk images. These disk images are cloned to create a new instance in the form of a virtual machine. In the same way, an existing virtual machine can be cloned to create a new virtual machine, or cloned to create a new template.

## Virtual Machine Assemblies

Virtual machine assemblies are often described as a template of a group of virtual machines, or a collection of virtual machine templates. An assembly can contain a single virtual machine or a collection of virtual machine templates.

## Domains, Guests and Virtual Machines

The terms *domain*, *guest*, and *virtual machine* are often used interchangeably, but they have subtle differences. A *domain* is a configurable set of resources, including memory, virtual CPUs, network devices, and disk devices, in which virtual machines run. A *guest* is a virtualized operating system running within a domain. Multiple guests can run on the same instance of Oracle Database Appliance Virtualized Platform, each within its own domain. A *virtual machine* is granted virtual resources, and can be started, stopped, and restarted independently.

## Virtual Disks

In addition to virtual machines, you can create virtual disks in shared repositories. Virtual disks provide additional storage options for virtual machines by enabling you to attach additional block storage to your virtual machines. Similarly, you can detach the storage if you no longer need the additional space. You can use virtual disks to expand existing file system storage inside the virtual machine by extending the storage volume onto a virtual disk, or by creating a new file system on a virtual disk. Your virtual disks can also share multiple virtual machines running on the same shared repository.

A *driver domain* is a user domain that has special privileges and responsibilities for a particular piece of hardware. When you use the driver domain option, the newly created virtual disks are mounted directly from ODA\_BASE to a guest virtual machine. The option improves performance by enabling guest virtual machines to use ODA\_BASE instead of Dom0 to access virtual disks. The driver domain option is available beginning with release 12.1.2.7.0 and is supported with Oracle Linux, Windows, and Oracle Solaris x86 guest operating systems. Live migration of driver domain virtual machines is not supported.

## Shared Repositories

A *shared repository* is a central location for storing resources that are essential to creating and managing virtual machines. These resources include virtual machine templates and assemblies, ISO files (virtual DVD images), virtual machine configuration files, and virtual disks. Shared repositories are configured on an Oracle Automatic Storage Management Cluster File System (Oracle ACFS) and then presented to the Oracle Database Appliance nodes that need access to those resources. Oracle Database Appliance Virtualized Platform uses shared repositories to optimize available disk space usage in the environment, and for easy reallocation of

virtual machines if a physical server fails. The virtual machine files can be stored on shared disks, providing shared storage for the virtual machines. Additionally, you can configure CPU pools and a resizable Oracle Database domain (ODA\_BASE) to ensure that the virtual machines do not consume cycles from each other or from your assigned database CPU cores.

- The shared disks on Oracle Database Appliance Virtualized Platform are connected directly to ODA\_BASE.
- ODA\_BASE contains three shared repositories named `fs1`, `fs2`, and `fs3`.
- Each shared repository is an Oracle ACFS in ODA\_BASE created on top of the Oracle Automatic Storage Management (Oracle ASM) disk group (DATA or RECO) chosen by the user when creating the shared repository.
- The process that creates a shared repository also performs a network file system (NFS) export of the shared repository to the respective `Dom0` by using the private network.
- The export enables shared storage for the virtual machine files.

**Figure 12-2 Architecture Overview of Oracle Database Appliance Virtualized Platform Shared Repositories**

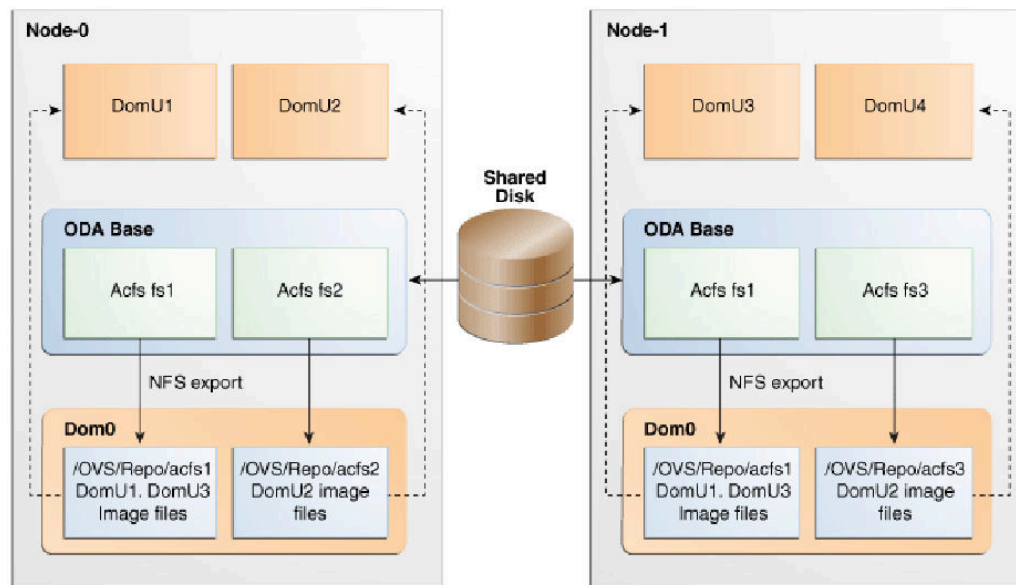

With the configuration shown in the illustration, you can:

- Create multiple repositories.
- Mount these repositories either on the nodes where the virtual machine needs to run (such as `fs2` and `fs3` in the illustration), or on both the nodes (such as `fs1` in the illustration).
- Create one or more virtual machines or virtual machine templates on the shared repositories.
- Use OAKCLI commands to create and manage shared repositories, virtual disks, and their virtual machines, and the underlying architecture shown in the illustration.

 **Note:**

Virtual machine (VM) repositories on Oracle Database Appliance can only be on the boot drives or an Oracle Database Appliance shared storage shelf. External storage cannot be used for VM shared repositories on Oracle Database Appliance.

## About Network Infrastructure and VLANs on Oracle Database Appliance Virtualized Platform

Oracle Database Appliance Virtualized Platform supports multiple VLANs on the same network port or bond.

Virtual local area networks (VLANs) are multiple logical networks that are created from a single physical network switch port. VLANs provide network security isolation for multiple workloads that share a common network. For example, application, backup, and management networks. Each VLAN acts as an independent logical network operating with other VLANs over the same physical connection. This means that virtual machines deployed on different networks, connected through the same Oracle VM Server port (or bond), can have traffic directed to different VLANs.

The physical ports in the system at deployment (either copper or fiber) are bonded as `bond0` in single node platforms and `bond1` in high-availability platforms. The VLAN is created on `bond0` or `bond1` to `bond6`, if they are available.

The network interfaces differ, depending on your Oracle Database Appliance hardware. In all cases, connections to user domains are through the selected interfaces. A switch that supports tagged VLANs uses VLAN IDs to identify the packet, including to which network the packet belongs.

### Configuration Overview of Oracle Database Appliance Virtual Machine Local Area Networks

To specify which network you want to use to access a virtual machine, you employ network infrastructure components of Oracle Database Appliance Virtualized Platform. Oracle Database Appliance Virtualized Platform manages all of the high-level network infrastructure components for you by pre-creating the bridges for all networks. The front-end point for accessing a virtual machine is one of the bridges defined for `Dom0`.

When you configure a virtual machine, you define which network the virtual machine should use by identifying the related bridge.

For example, to connect a virtual machine named `myvm1` to the `net1` network, you would use the following command:

```
oakcli modify vm myvm1 -addnetwork net1
```

The illustration "Basic Virtual Machine Local Area Network" shows a typical Oracle Database Appliance local area network configuration that results from this virtual machine network configuration:

Figure 12-3 Basic Virtual Machine Local Area Network

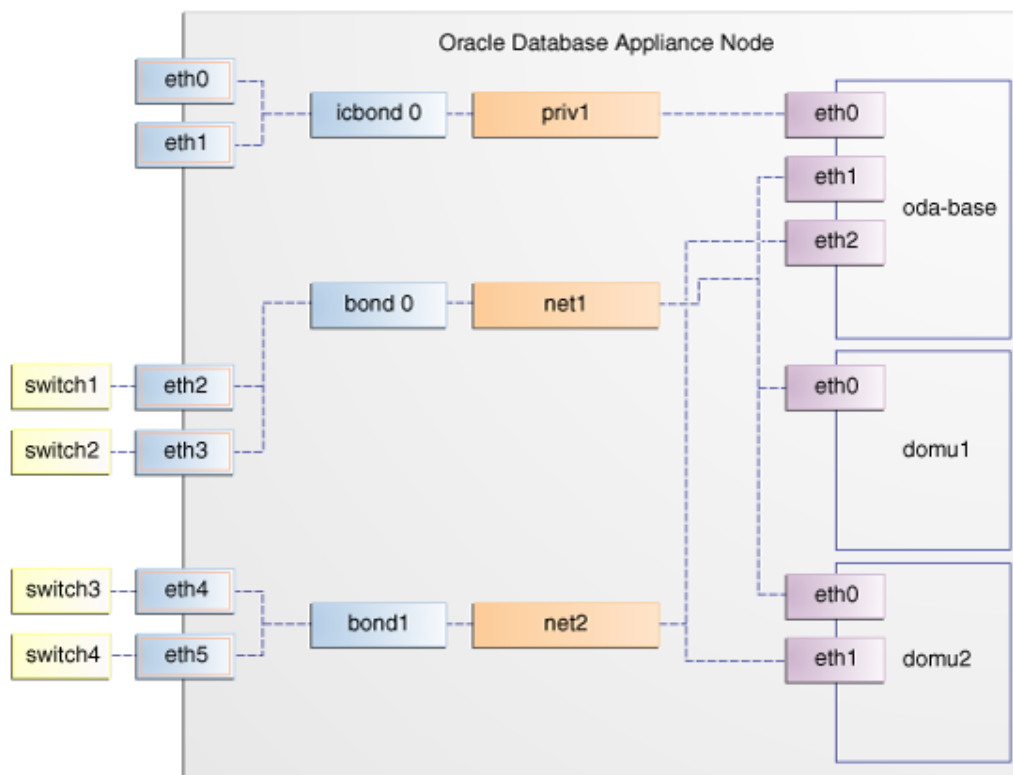

You assign default VLANs to ODA\_BASE during the installation and configuration of Oracle Database Appliance Virtualized Platform. The figure "Oracle Database Appliance Virtualized Platform with Virtual Local Area Networks" shows a typical Oracle Database Appliance configuration using VLANs. The illustration shows the same configuration as in "Basic Virtual Machine Local Area Networks," but with three tagged VLANs added for backups (backup), for applications (application), and for management (mgnt).

**Figure 12-4 Oracle Database Appliance Virtualized Platform with Virtual Local Area Networks**

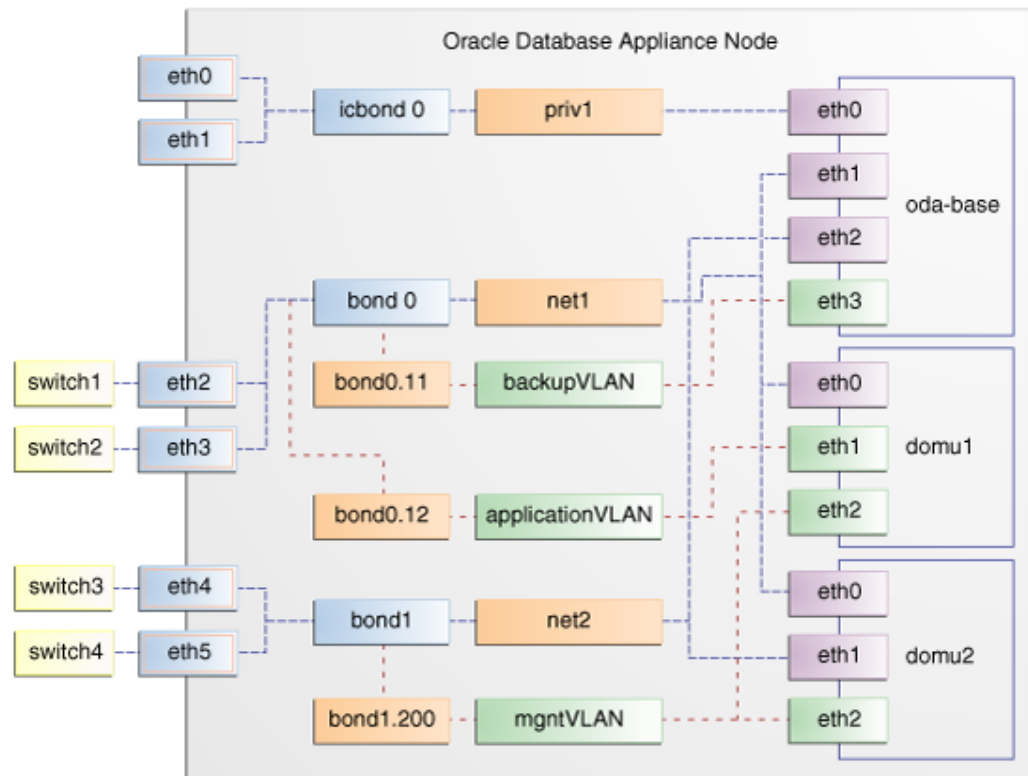

## Configuring Additional Networks on Virtualized Platform

Use the `oakcli configure additionalnet` command to create additional networks.

The `oakcli configure additionalnet` command runs an interactive script that requires you to provide the interface name, DHCP [Y/N], IP address, and netmask.

### Example of Creating an Additional Network

When you run the command on `Dom0`, the interface name expects a net name. If you run the command on `Dom1`, then the interface name expects an `eth` name.

```
oakcli configure additionalnet
```

### Related Topics

- [oakcli configure additionalnet](#)  
Use the `oakcli configure additionalnet` command to configure any unconfigured public networks in bare metal, Domain 0, and ODA\_BASE.

## How to Create and Manage Shared Repositories

These topics describe how to use OAKCLI to create and manage shared repositories on Oracle Database Appliance Virtualized Platform.

- [Creating a Shared Repository](#)  
Use the `oakcli create repo` command to create a shared repository on Oracle Database Appliance Virtualized Platforms.
- [Showing the Status of Shared Repositories](#)  
Use the `oakcli show repo` command to display information about virtual machine repositories on Oracle Database Appliance Virtualized Platforms.
- [Starting a Shared Repository](#)  
Use the `oakcli start repo` command to start a virtual machine and assign it to a shared repository on Oracle Database Appliance Virtualized Platforms.
- [Stopping a Shared Repository](#)  
Use the `oakcli stop repo` command to command to stop a shared repository on a node on Oracle Database Appliance Virtualized Platforms.
- [Deleting a Shared Repository](#)  
Use the `oakcli delete repo` command to delete a shared repository on Oracle Database Appliance Virtualized Platforms.
- [Increasing the Size of a Shared Repository](#)  
Use the `oakcli configure repo` command to increase the size of a shared repository on Oracle Database Appliance Virtualized Platforms.

### Creating a Shared Repository

Use the `oakcli create repo` command to create a shared repository on Oracle Database Appliance Virtualized Platforms.

When you run the `oakcli create repo` command, you identify the repository name using the option `repo`, you identify the disk group that you want to use for its storage (DATA or RECO) using the option `-dg`, and you identify the size of the repository in gigabytes or megabytes (the default size unit is gigabytes) using the `-size` option.

Other Oracle Appliance Manager shared repository commands, including commands to show and to stop (dismount) existing repositories, are similar to those used for nonshared repositories. Unlike the default repositories, which are permanent, you can delete a shared repository that has no active (mounted) virtual machines.

#### Example of Creating a Shared Repository

The following command creates a shared repository named `repo1` in the ASM DATA disk group (`data`) with 30 gigabytes of available storage:

```
oakcli create repo repo1 -dg data -size 30
```



## Showing the Status of Shared Repositories

Use the `oakcli show repo` command to display information about virtual machine repositories on Oracle Database Appliance Virtualized Platforms.

To see all repositories, omit the repository name and node number. To see a specific shared repository, include the repository name and node number.

### Example 12-1 Example of Showing the Status of All Shared Repositories

To show the status of all shared repositories, use the `oakcli show repo` command:

```
oakcli show repo
NAME                TYPE          NODENUM  FREE SPACE  STATE
----                -
odarepo1            local         0         N/A         N/A
odarepo2            local         1         N/A         N/A
repo1               shared        0         68.25%     ONLINE
repo1               shared        1         68.25%     ONLINE
repo2               shared        0         N/A         OFFLINE
repo2               shared        1         89.83%     ONLINE
```

### Example 12-2 Example of Showing the Status of a Selected Shared Repository

To display information for a particular node in a shared repository, specify the repository name and node number as part of the command syntax. In the following example, information is displayed for Node 1 in the `repo1` shared repository:

```
oakcli show repo repo1 -node 1

Resource: repo1_1
  AutoStart      : restore
  DG             : DATA
  Device         : /dev/asm/repo1-286
  ExpectedState  : Online
  FreeSpace      : 87.703125M
  MountPoint     : /u01/app/repo1
  Name           : repo1_0
  Node           : all
  RepoType       : shared
  Size           : 30720
  State          : Online
  Version        : 2
```

## Starting a Shared Repository

Use the `oakcli start repo` command to start a virtual machine and assign it to a shared repository on Oracle Database Appliance Virtualized Platforms

Before you can assign a virtual machine to a shared repository, use the `oakcli start repo` command to start the repository and make the storage available. Note that the `oakcli start repo` command will also start any virtual machines assigned to the repository that are defined to be automatically started.

You must have a repository already configured. Identify the repository that you start by using the option `repo name`, where `name` is the repository name. Identify the name of the node on which the repository is located by using the option `-node nodename`, where `nodename` is the name of the node on which the repository is located.

### Example 12-3 Example of Starting a Shared Repository

This command starts the shared repository named `repo1` on Node 1:

```
oakcli start repo repo1 -node 1
```

## Stopping a Shared Repository

Use the `oakcli stop repo` command to command to stop a shared repository on a node on Oracle Database Appliance Virtualized Platforms.

Identify the repository that you want to stop by using the `repo reponame` option, where `reponame` identifies the repository that you want to stop. Identify the node on which the repository that you want to stop is running by using the `-node number` option where `number` is the node number that you want to stop.

#### Note:

Do not issue an `oakcli stop repo` command while virtual machines are still active in the repository for the selected node.

### Example 12-4 Example of Stopping a Shared Repository

The following example stops the shared repository named `repo1` on Node 0:

```
oakcli stop repo repo1 -node 0
```

## Deleting a Shared Repository

Use the `oakcli delete repo` command to delete a shared repository on Oracle Database Appliance Virtualized Platforms.

Identify the repository that you want to delete by using the `repo reponame` option, where `reponame` identifies the repository that you want to delete.

#### Note:

The shared repository that you want to delete must be offline (stopped) on both nodes before you attempt to delete it.

### Example 12-5 Example of Deleting a Shared Repository

The following command deletes the shared repository named `repo1` on both nodes:

```
oakcli delete repo repo1
```

## Increasing the Size of a Shared Repository

Use the `oakcli configure repo` command to increase the size of a shared repository on Oracle Database Appliance Virtualized Platforms.

Identify the repository that you want to expand by using the `-repo reponame` option, where `reponame` identifies the repository that you want to expand. Use the option `-incsize size` to specify the size of the increase that you want to configure, where `size` is the size (in gigabytes) that you want to add to the configured size.

### Example 12-6 Example of Increasing the Size of a Shared Repository

The following command increases the size of the shared repository `repol` by 2 gigabytes:

```
# oakcli configure repo repol -incsize 2G
```

```
Configured Shared Repo : repol with new size 3712.0.
```

## How to Manage Virtual Disks in Shared Repositories

These topics describe how to use OAKCLI to create, view, clone, attach, and delete virtual disks on Oracle Database Appliance Virtualized Platform.

- [Creating a Virtual Disk for Use in a Shared Repository](#)  
Use the command `oakcli create vdisk` to create a virtual disk within a shared repository on Oracle Database Appliance Virtualized Platforms.
- [Viewing Information About Virtual Disks](#)  
Use the command `oakcli show vdisk` to view information about virtual disks on Oracle Database Appliance Virtualized Platforms.
- [Cloning Virtual Disks](#)  
Use the `oakcli clone vdisk` command to create clones of virtual disks on Oracle Database Appliance Virtualized Platforms.
- [Attaching a Virtual Disk to a Virtual Machine](#)  
Use the `oakcli modify vm` command to attach a virtual disk to a virtual machine on Oracle Database Appliance Virtualized Platforms.
- [Deleting a Virtual Disk](#)  
Use the `oakcli delete vdisk` command to remove a virtual disk from a shared repository on Oracle Database Appliance Virtualized Platforms.

## Creating a Virtual Disk for Use in a Shared Repository

Use the command `oakcli create vdisk` to create a virtual disk within a shared repository on Oracle Database Appliance Virtualized Platforms.

The command `oakcli create vdisk` defines the size of the virtual disk, the shared repository in which that disk is created, defines the unique name for that disk within that shared repository, and defines if the disk is used for one virtual machine, or can be shared by multiple virtual machines.

The name of the vdisk you create is defined by the command `oakcli create vdisk name`, where `name` is the name of the vdisk you create. Identify the repository in which you create the vdisk by using the `-repo reponame` option, where `reponame` identifies

the repository where you want to create the vdisk. Use the option `-size sizeG` to specify the vdisk size (in gigabytes), where `sizeG` is the size (in gigabytes) that you want to add to the configured size. If you want to configure the vdisk as a shared disk, then use the option `-type shared` to designate the vdisk as a shared disk.

### Example 12-7 Example of Creating a Shared Virtual Disk

This example creates a virtual disk named `sdisk1` in the `repo2` shared repository that is 1 gigabyte in size, and that virtual machines can share:

```
oakcli create vdisk sdisk1 -repo repo2 -size 1G -type shared
```

## Viewing Information About Virtual Disks

Use the command `oakcli show vdisk` to view information about virtual disks on Oracle Database Appliance Virtualized Platforms.

You can use `oakcli show vdisk` by itself to see information about all of your configured virtual disks. To see information about an individual virtual disk, enter the command `oakcli show vdisk diskname -repo reponame`, where `diskname` is the name of the disk that you want to check, and `reponame` is the name of the shared repository where the virtual disk is located.

### Example 12-8 Example of Displaying the Information for All Vdisks

This example displays information about all virtual disks configured on an Oracle Database Appliance:

```
# oakcli show vdisk
```

NAME	SIZE	TYPE	REPOSITORY
----	----	----	-----
myvdisk	10G	local	vdiskrepo
newv	1G	local	vdiskrepo

### Example 12-9 Example of Displaying Information for a Single Vdisk

This example displays information for the virtual disk named `myvdisk1`:

```
# oakcli show vdisk myvdisk1
Resource: myvdisk_vdiskrepo
  Name      : myvdisk_vdiskrepo
  RepoName  : vdiskrepo
  Size      : 10G
  Type      : local
  VmAttached : 0
```

## Cloning Virtual Disks

Use the `oakcli clone vdisk` command to create clones of virtual disks on Oracle Database Appliance Virtualized Platforms.

The command `oakcli clone vdisk` defines the size of the virtual disk, the shared repository in which that disk is created, defines the unique name for that disk within

that shared repository, and defines if the disk is used for one virtual machine, or can be shared by multiple virtual machines.

The name of the vdisk you create is defined by the command `oakcli clone vdisk name`, where *name* is the name of the vdisk you create. Identify the repository in which you create the vdisk by using the `-repo reponame` option, where *reponame* is the name of the repository where the original vdisk is located. Use the option `-src sourcevdiskname`, where *sourcevdiskname* is the name of the virtual disk that you are cloning. Add the option `-h` to display help for this command.

 **Note:**

Once the virtual disk is attached to a virtual machine, the system administrator should perform normal disk addition tasks for the given operating system to make the newly added storage available to the virtual machine.

### Syntax

```
oakcli clone vdisk name -repo reponame -src sourcevdiskname [-h]
```

### Example 12-10 Example of Cloning a Virtual Disk

This example clones a virtual disk named `my_vdisk2` from an existing virtual disk named `vdisk1` that is stored in the repository named `vrep01`:

```
oakcli clone vdisk my_vdisk2 -repo vrep01 -src vdisk1
```

## Attaching a Virtual Disk to a Virtual Machine

Use the `oakcli modify vm` command to attach a virtual disk to a virtual machine on Oracle Database Appliance Virtualized Platforms.

The command `oakcli modify vm name` enables you to modify a virtual machine, where *name* is the name of the virtual machine that you want to modify. To attach a disk to a virtual machine, use the option `-attachvdisk vdiskname`, where *vdiskname* is the name of the virtual disk that you want to attach to the virtual machine.

### Example 12-11 Example of Attaching a Virtual Disk To a Virtual Machine

This example attaches the virtual disk named `sdisk1` to the virtual machine named `myol6u_test`:

```
oakcli modify vm myol6u_test -attachvdisk sdisk1
```

## Deleting a Virtual Disk

Use the `oakcli delete vdisk` command to remove a virtual disk from a shared repository on Oracle Database Appliance Virtualized Platforms.

The command `oakcli delete vdisk vdiskname` removes a virtual disk, where *vdiskname* is the name of the virtual disk that you want to remove. The option `-repo`

*reponame* indicates the shared repository on which the virtual disk is located, where *reponame* is the name of the shared repository.

### Example 12-12 Example of Deleting a Virtual Disk from a Shared Repository

This example removes a virtual disk named `t2g` from the shared repository named `repoprod1`:

```
oakcli delete vdisk t2g -repo repoprod1
```

## How to Manage Virtual Machine Templates

These topics describe how to use OAKCLI to import, configure, modify and check virtual machine templates on Oracle Database Appliance Virtualized Platform.

- [About Managing Virtual Machine Templates](#)  
Import and configure virtual machine templates as the source for the virtual machines deployed on Oracle Database Appliance Virtualized Platform.
- [Listing Virtual Machine Templates](#)  
Use the `oakcli show vmtemplate` command to display virtual machine template details.
- [Importing Virtual Machine Templates](#)  
Use the `oakcli import vmtemplate` command to import virtual machine templates and assemblies on Oracle Database Appliance Virtualized Platforms.
- [Configuring a Virtual Machine Template](#)  
Use the `oakcli configure vmtemplate` command to configure a virtual machine template on Oracle Database Appliance Virtualized Platform.
- [Showing Configured Values for a Virtual Machine Template](#)  
Use the `oakcli show vmtemplate` command to show values for the configurable options in a virtual machine template.
- [Modifying a Virtual Machine Template Configuration](#)  
Use the `oakcli modify vmtemplate` command to modify a virtual machine template.
- [Removing a Virtual Machine Template](#)  
Use the `oakcli delete vmtemplate` command to remove a virtual machine template.

## About Managing Virtual Machine Templates

Import and configure virtual machine templates as the source for the virtual machines deployed on Oracle Database Appliance Virtualized Platform.

If you have created shared repositories, then import templates into one of those shared repositories. If you have not created shared repositories, then import templates into the local repository on one of the local nodes.

You can import assemblies that contain one or more templates. When you import a template or assembly into a shared repository, select a node that you want to perform the operation. Select the node carefully to avoid overloading the node. After you create the repository, the repository becomes available to both nodes, regardless of which node performs the import.

Templates imported into local nodes use the repository name supplied in the import command to identify the node that completes the import, and that provides the storage. On Node 0, the local repository is named `odarepo1` and on Node 1, the local repository is named `odarepo2`. If you want to import a template to both local repositories, then you must provide a different template name when you import the template into the second node.

 **Note:**

You cannot create or clone templates directly on Oracle Database Appliance Virtualized Platform, you must use the Oracle VM templates that are available in Oracle Software Delivery.

If you import an assembly that contains more than one template, then the command automatically modifies the template name that you provide, so that all template names remain unique. The first template you import has the number "1" appended to the name. The second template as the number "2" appended, and additional templates have 3, 4, 5 and so on appended in sequence.

After you import a virtual machine template, you can customize the template using OAKCLI commands.

 **Note:**

Find virtual machine templates at the following URL:

<http://edelivery.oracle.com/linux>.

## Listing Virtual Machine Templates

Use the `oakcli show vmtemplate` command to display virtual machine template details.

The `oakcli show vmtemplate` command displays the name and repository for each virtual machine template as well as the default number of CPUs and default amount of memory that Oracle Database Appliance Virtualized Platform would assign to a virtual machine created from the template.

### Example

Display information about the `sample1_odarepo1` virtual template:

```
oakcli show vmtemplate sample_odarepo1
Resource: sample1_odarepo1
      CPUPriority      :      100
      Disks            :      |file:/OVS/Repositories/odarepo1/Te
                          mplates/otml_sample1_odarepo1/Syste
                          m.img,xvda,w||file:/OVS/Repositorie
                          s/odarepo1/Templates/otml_sample1_o
                          darepo1/u01.img,xvdb,w|
      Domain          :      XEN_PVM
```

```

Keyboard      :      en-us
MaxMemory    :      2048
MaxVcpu      :      2
Memory       :      2048
Mouse        :      OS_DEFAULT
Name         :      sample1_odarepo1
Networks     :      |bridge=priv1||bridge=net1||bridge=
                net2|
NodeNum      :      0
OS           :      OL_5
ProcessorCap :      100
RepoName     :      odarepo1
Vcpu        :      2

```

## Importing Virtual Machine Templates

Use the `oakcli import vmtemplate` command to import virtual machine templates and assemblies on Oracle Database Appliance Virtualized Platforms.

You import virtual machine templates and assemblies contained in an external repository assembly file. Use the name of the shared repository and include a clause to identify the node where you want to import a template or an assembly.

You can import virtual machine templates and assemblies directly from a remote repository using a URL to identify the source of the files. You can choose to use a remote copy command to copy files from the remote repository into your `Dom0 /OVS` directory, and then import the files using the path and names to identify the downloaded files.



### Note:

When importing templates or assemblies to a local repository, do not use the `-node` option. The target node is implicit in the name of the repository.

### Syntax

```
oakcli import vmtemplate vmtemplatename -files image_files | -assembly assembly_file
-repo repo_name [- node 0 | 1 ]
```

### Example 12-13 Example of Importing Virtual Machine Templates from an External Repository Assembly File

Use the `oakcli import vmtemplate vmtemplatename -assembly assembly_file -repo repo_name` command to import virtual machine templates contained in an external template repository assembly file.

This example imports the template in an external template repository assembly file located at the URL `'http://example.com/assemblies/OEL6/`



OVM\_OL6U1\_x86\_PVHVM.ova' to a new template named OL6U1 in a new repository named odarepol:

```
oakcli import vmtemplate OL6U1 -assembly 'http://example.com/assemblies/OEL6/OVM_OL6U1_x86_PVHVM.ova' -repo odarepol
```

Note the single quotation marks that enclose the URL.

#### Example 12-14 Example of Importing a Virtual Machine Template from Dom0

Use this command syntax to import a virtual machine template from the /OVS file system on Dom0:

```
oakcli import vmtemplate vmtemplatename -files image_files -repo repo_name
```

This example imports the virtual machine template named OVM\_OL5U7\_X86\_64\_PVM\_10GB.tgz from the /OVS directory in Dom0 into the odarepol repository. The template is assigned the name OL5U7:

```
oakcli import vmtemplate OL5U7 -files /OVS/OVM_OL5U7_X86_64_PVM_10GB.tgz -repo odarepol
```

#### Example 12-15 Example of Importing a Virtual Machine Template Using an External Repository URL

Use the command `oakcli import vmtemplate vmtemplatename -files image_files -repo repo_name` to import a virtual machine template file from an external template repository.

This example imports a virtual machine template named OVM\_OL5U7\_X86\_64\_PVM\_10GB.tgz from an external template repository at the URL 'http://example.com/assemblies/OEL6/OVM\_OL6U1\_x86\_PVHVM.tgz'. Note the single quotation marks that enclose the URL. The template is assigned the name OL5U7, and is imported into the odarepol repository:

```
oakcli import vmtemplate OL5U7 -files 'http://example.com/assemblies/OEL6/OVM_OL6U1_x86_PVHVM.tgz' -repo odarepol
```

## Configuring a Virtual Machine Template

Use the `oakcli configure vmtemplate` command to configure a virtual machine template on Oracle Database Appliance Virtualized Platform.

The values become the default values for any virtual machine cloned from this template. You can change any or all of them later with the `oakcli configure vm` command.

#### Example

Set values for the virtual machine template named `myol5u7_10gb`:

```
oakcli configure vmtemplate myol5u7_10gb -vcpu 2 -maxvcpu 4 -cpucap 40 -memory 1536M -maxmemory 2G -os OTHER_LINUX
```

- `-vcpu 2` sets the number of CPUs to be assigned when the virtual machine starts up to 2.
- `-maxvcpu 4` sets the maximum number of CPUs that can be assigned to the virtual machine to 4.
- `-cpucap 40` sets the maximum percentage of a CPU's capacity that can be assigned to the virtual machine to 40%.
- `-memory 1536M` sets the amount of memory to be assigned when the virtual machine starts up to 1536 MB.
- `-maxmemory 2G` sets the maximum amount of memory that can be assigned to the virtual machine to 2 GB.
- `-os OTHER_LINUX` sets `OTHER_LINUX` as the operating system used by the virtual machine.

## Showing Configured Values for a Virtual Machine Template

Use the `oakcli show vmtemplate` command to show values for the configurable options in a virtual machine template.

### Example

Display information about the `sample1_odarepo1` virtual template:

```
oakcli show vmtemplate sample_odarepo1
Resource: sample1_odarepo1
  CPUPriority      :      100
  Disks            :      |file:/OVS/Repositories/odarepo1/Te
                    |mplates/otml_sample1_odarepo1/Syste
                    |m.img,xvda,w||file:/OVS/Repositorie
                    |s/odarepo1/Templates/otml_sample1_o
                    |darepo1/u01.img,xvdb,w|
  Domain          :      XEN_PVM
  Keyboard        :      en-us
  MaxMemory       :      2048
  MaxVcpu         :      2
  Memory          :      2048
  Mouse           :      OS_DEFAULT
  Name            :      sample1_odarepo1
  Networks        :      |bridge=priv1||bridge=net1||bridge=
                    |net2|
  NodeNum         :      0
  OS              :      OL_5
  ProcessorCap    :      100
  RepoName        :      odarepo1
  Vcpu            :      2
```

## Modifying a Virtual Machine Template Configuration

Use the `oakcli modify vmtemplate` command to modify a virtual machine template.

After you import a virtual machine template to a storage repository, examine the template configuration parameters with the `oakcli show vmtemplate` command. If you need to reconfigure the template for specific requirements, then use the `oakcli configure vmtemplate` command. This is useful if you plan to deploy multiple virtual machines with the same characteristics from a single template. If you will be deploying

only one virtual machine or many virtual machines but with different characteristics, then set required values in the virtual machines with the `oakcli configure vm` command after you deploy the template.

When you are satisfied with the configuration of your virtual machine template, use the `oakcli modify` command to assign a new network to the virtual machine template.

### Example

Replace the network assigned to the `gc_11g` virtual machine template with the `net1` network:

```
oakcli modify vmtemplate gc_11g -addnetwork net1
```

## Removing a Virtual Machine Template

Use the `oakcli delete vmtemplate` command to remove a virtual machine template.

If you no longer need a template that you previously stored, then you can remove the template from the repository.

### Example

Remove the virtual machine template named `my016u_15gb3` from Oracle Database Appliance Virtualized Platform:

```
oakcli delete vmtemplate my016u_15gb3
```

## How to Create Clones and Snap Clones of a Template

Review these topics for an overview of clones and snap clones, and for procedures to use to create clones.

- [About Creating Clones and Snap Clones of a Template](#)  
You can create, or *clone*, virtual machines from imported templates (or assemblies) or from an existing virtual machine on Oracle Database Appliance Virtualized Platforms.
- [Cloning a Template With OAKCLI](#)  
Use the `oakcli clone vm` command to clone virtual machines that have attached virtual disks on Oracle Database Appliance Virtualized Platforms.
- [Creating a Snap Clone from a Template With OAKCLI](#)  
Use the `oakcli clone vm` command to create a snap clone of a virtual machine template on Oracle Database Appliance Virtualized Platforms.
- [Creating a Snap Clone of an Existing Virtual Machine With OAKCLI](#)  
Use the `oakcli clone vm` command to create a snap clone of an existing virtual machine on Oracle Database Appliance Virtualized Platforms.

## About Creating Clones and Snap Clones of a Template

You can create, or *clone*, virtual machines from imported templates (or assemblies) or from an existing virtual machine on Oracle Database Appliance Virtualized Platforms.

Clones and snap clones can be an effective way to provision and clone new databases for test and development systems. They are much more efficient to create than using RMAN scripts, or other cloning approaches.

You can create virtual machines that are a complete clone of the template or assembly, or you can create virtual machines that are snap clones. Snap clones contain only the metadata defined for the virtual machine.

Creating snap clones is a very fast operation compared to cloning the entire template or assembly. However, if you update the contents of a snap clone, then review your space requirements. Unless your changes to the snap clone are carried out on shared virtual disks, you require additional storage on your system for the clone to retain both the original content, as well as changed content.

## Cloning a Template With OAKCLI

Use the `oakcli clone vm` command to clone virtual machines that have attached virtual disks on Oracle Database Appliance Virtualized Platforms.

When you clone virtual machines with attached virtual disks, a clone of a virtual machine contains the contents of virtual disks attached locally, but does not contain contents of virtual disks attached in shared mode. If needed, you can clone the virtual disks required by a cloned virtual machine in a separate step.

Use the command `oakcli clone vm` to create a virtual machine from a virtual machine template. Use the `-repo name` option to provide the name of the shared repository, where *name* is the name of the repository. Use the `-node number` option to identify the node on which you want to perform the cloning process, where *number* is the number of the node.

### Note:

The `-node` option identifies the node where the cloning activity is carried out. The node value does not assign the default startup node for the virtual machine. You can set the startup assignment with the command `oakcli configure vm`.

### Example 12-16 Example of Creating a Virtual Machine Clone from a Virtual Machine Template

This example creates a virtual machine named `myo16u_test` from the virtual machine template named `myo16u_15gb1`, which is located in a shared repository named `repo2` on Node 0:

```
oakcli clone vm myo16u_test -vmtemplate myo16u_15gb1 -repo repo2 -node 0
```

## Creating a Snap Clone from a Template With OAKCLI

Use the `oakcli clone vm` command to create a snap clone of a virtual machine template on Oracle Database Appliance Virtualized Platforms.

Use the `-vmtemplate name` option to provide the name of the virtual machine template that you want to clone, where `name` is the name of the template. Use the `-snap` option to designate that you want to create a snap clone.

### **Example 12-17 Example of Creating a Snap Clone From a Virtual Machine Template**

This example creates a snap clone named `myol15u_snap` from the virtual machine template named `myol15u`:

```
oakcli clone vm myol15u_snap -vmtemplate myol15u -snap
```

## Creating a Snap Clone of an Existing Virtual Machine With OAKCLI

Use the `oakcli clone vm` command to create a snap clone of an existing virtual machine on Oracle Database Appliance Virtualized Platforms.

Use the `-vm name` option to provide the name of the virtual machine that you want to clone, where `name` is the name of the virtual machine. Use the `-snap` option to designate that you want to create a snap clone.

### **Example 12-18 Example of Creating a Snap Clone From an Existing Virtual Machine**

This example creates a snap clone named `myol15u_test1` from a virtual machine named `myol15u_test`:

```
oakcli clone vm myol15u_test1 -vm myol15u_test1 -snap
```

## How to Manage Virtual Machines on Oracle Database Appliance Virtualized Platform

Review these topics for an overview of virtual machines, and for procedures to create and manage virtual machines.

- [About Managing Virtual Machines on Oracle Database Appliance Virtualized Platform](#)  
Deploy virtual machines on Oracle Database Appliance Virtualized Platform to run other workloads that are independent of databases running in ODA\_BASE
- [Listing the Virtual Machines in Your Repositories](#)  
Use the `oakcli show vm` command to display details for all of your existing virtual machines or to display details of a specific virtual machine.
- [Creating a Virtual Machine](#)  
Create a virtual machine by cloning an imported template, cloning an assembly that contains configured virtual machines, or cloning an existing virtual machine.

- [Configuring a Virtual Machine](#)  
Use the `oakcli configure vm` command to configure a virtual machine on Oracle Database Appliance Virtualized Platform.
- [Starting and Stopping a Virtual Machine](#)  
Use the `oakcli start vm` command to start a virtual machine on Oracle Database Appliance Virtualized Platform and use the `oakcli stop vm` command to stop a virtual machine.
- [Externally Configuring a Virtual Machine](#)  
You can initially configure your virtual machines externally without connecting to the virtual machine console by using Oracle VM Guest Additions by passing key-value pairs to the virtual machine.
- [Opening a Virtual Machine Console for a Virtual Machine](#)  
Use the `oakcli show vmconsole` command to open a virtual machine console window for an active virtual machine
- [Creating an Image for a New Virtual Machine](#)  
Use the `oakcli clone vm` command to create an image for a new virtual machine on Oracle Database Appliance Virtualized Platform.
- [Setting Up a Virtual Machine for Access from eth0 Using an IP Address](#)  
Configure a network device (`eth0`) with an IP address for a virtual machine.
- [Adding or Removing a Virtual Disk to or from a Virtual Machine](#)  
Use the `oakcli modify vm` command to add or remove a virtual disk (`vdisk`) from a virtual machine.
- [Removing a Virtual Machine from a Shared Repository](#)  
Use the `oakcli delete vm` command to delete the virtual machine and reclaim its storage and resources.
- [Performing a Live Migration for an Oracle Database Appliance Virtual Machine](#)  
If your system meets requirements for live migration, then you can use the `oakcli migrate vm` command to migrate a virtual machine from the currently running node to another node.

## About Managing Virtual Machines on Oracle Database Appliance Virtualized Platform

Deploy virtual machines on Oracle Database Appliance Virtualized Platform to run other workloads that are independent of databases running in ODA\_BASE

Use OAKCLI commands to create and manage virtual machines, including starting and stopping them, and opening consoles for graphical user interface (GUI) access.

### Note:

You can use a Virtual Network Computing (VNC) session to open a GUI console for a virtual machine.

You can reconfigure an active virtual machine. However, your changes do not take effect until you stop and restart the virtual machine. You can display high-level information about all of your virtual machines, or display detailed information about the

configuration of single virtual machines. When you no longer have use for a particular virtual machine, delete the virtual machine to regain storage.

 **Note:**

Do not modify the default settings for the following parameters in the guest virtual machine:

- `xen_blkfront.max`: Max Indirect Descriptors, default 32
- `xen_blkback.max_ring_page_order`: Shared Ring Page Order, default 0

## Listing the Virtual Machines in Your Repositories

Use the `oakcli show vm` command to display details for all of your existing virtual machines or to display details of a specific virtual machine.

The command displays the name, the repository, and the current state (online or offline) for each virtual machine. The output also contains the default number of CPUs and default amount of memory that Oracle Database Appliance Virtualized Platform will assign to each virtual machine.

- Use the `oakcli show vm` command to display the virtual machine names, memory and vCPU allocations, status, virtual disks, and repository name for all virtual machines.

```
oakcli show vm
```

NAME REPOSITORY	MEMORY	VCPU	STATE
----	-----	----	-----
-----			
sample5_odarepo1 odarepo1	2048	2	OFFLINE
sample6_odarepo1 odarepo2	2048	2	OFFLINE
test1_odarepo1 odarepo1	2048	2	OFFLINE
test2_odarepo2 odarepo2	2048	2	OFFLINE
vm1_odarepo1 odarepo1	4096	4	ONLINE
vm2_odarepo2 odarepo2	2048	2	OFFLINE
win_vm1 odarepo1	1500	1	ONLINE

- Use the `oakcli show vm virtual machine name` command to display information about a specific virtual machine.

For example, use the following command to display details about the `vm1_odarepo1` virtual machine:

```
oakcli show vm vm1_odarepo1
Resource: vm1_odarepo1
      AutoStart      :      restore
      CPUPriority    :      100
      Disks          :      |file:/OVS/Repositories/odarepo1/Vi
                          rtualMachines/vm1_odarepo1/System.i
                          mg,xvda,w||file:/OVS/Repositories/o
                          darepo1/VirtualMachines/vm1_odarepo
                          1/u01.img,xvdb,w|
      Domain         :      XEN_PVM
      ExpectedState  :      online
      FailOver       :      false
      IsSharedRepo   :      false
      Keyboard       :      en-us
      MaxMemory      :      3000
      MaxVcpu        :      4
      Memory         :      4096
      Mouse          :      OS_DEFAULT
      Name           :      vm1_odarepo1
      Networks       :      |mac=00:21:F6:00:00:E4|
      NodeNum        :      0
      NodeNumStart   :
      OS             :      OL_5
      PrivateIP      :      None
      ProcessorCap   :      100
      RepoName       :      odarepo1
      State          :      Online
      TemplateName   :      otml_sample1_odarepo1
      Vcpu           :      4
      cpupool        :      twocpu
      vncport        :      5901
```

## Creating a Virtual Machine

Create a virtual machine by cloning an imported template, cloning an assembly that contains configured virtual machines, or cloning an existing virtual machine.

A virtual machine is a software emulation of a computer system that is granted virtual resources, and can be started, stopped, and restarted independently.

When you clone a template, the template is imported as an archive, unpacked, and stored as a virtual machine configuration file with disk images. The disk images are cloned to create a new instance in the form of a virtual machine.

Instead of creating a complete clone of a template or assembly, you can create a snap clone, which contains only the metadata defined for the virtual machine.

### Related Topics

- [How to Create Clones and Snap Clones of a Template](#)  
Review these topics for an overview of clones and snap clones, and for procedures to use to create clones.



## Configuring a Virtual Machine

Use the `oakcli configure vm` command to configure a virtual machine on Oracle Database Appliance Virtualized Platform.

Include a `-prefnode` clause, to identify the node where you want the virtual machine to run by default and a `-failover` clause to indicate if you want the virtual machine to use the other node when the preferred node is not available (either at startup or while already active).

If you reconfigure a virtual machine that is currently running, then your changes do not take effect until you stop and restart the virtual machine.

**Table 12-1 Parameters Available for Configuring a Virtual Machine**

Parameter	Description
<code>-vcpu 2</code>	Sets two (2) as the number of CPUs to be assigned to the virtual machine when started
<code>-cpuprio 150</code>	Sets the CPU access priority to 150
<code>-cpucap 20</code>	Sets the maximum percentage of a CPU's capacity that will be assigned to the virtual machine to 20%
<code>-memory 1G</code>	Sets the amount of memory assigned when the virtual machine starts to 1 GB
<code>-cpupool linpool</code>	Specifies <code>linpool</code> as the CPU pool to be assigned to the virtual machine
<code>-keyboard en-us</code>	Defines the keyboard type used to access the virtual machine as <code>en-us</code>
<code>-mouse USB_MOUSE</code>	Defines the mouse type used to access the virtual machine as a USB mouse

These values will override values assigned to these same parameters in the virtual machine template from which this virtual machine was derived. The virtual machine will use default values for parameters that are not defined in either the parent template or in a configuration command.

 **Note:**

CPU capacity is controlled by the CPU pool assigned to a virtual machine by either the `-cpupool` parameter or by the `default_unpinned_pool` (if the virtual machine is not configured with a `-cpupool` parameter). Values for `-vcpu` and `-maxvcpu` parameters that are larger than the number of CPUs in the assigned CPU pool are ignored.

Use the `oakcli configure` command and parameters to configure the virtual machine:

```
# oakcli modify vm vmname parameters
```

### Example 12-19 Example of Configuring a Virtual Machine

Set values for specific resources in the virtual machine named `myol15u`:

```
oakcli configure vm myol15u
-vcpu 2 -cpuprio 150 -cpucap 20 -memory 1G
-cpupool linpool -keyboard en-us -mouse USB_MOUSE
```

## Starting and Stopping a Virtual Machine

Use the `oakcli start vm` command to start a virtual machine on Oracle Database Appliance Virtualized Platform and use the `oakcli stop vm` command to stop a virtual machine.

### Note:

If you reconfigure a virtual machine that is currently running, then your changes will not be effective until you stop and restart the virtual machine.

## Externally Configuring a Virtual Machine

You can initially configure your virtual machines externally without connecting to the virtual machine console by using Oracle VM Guest Additions by passing key-value pairs to the virtual machine.

Use the `oakcli modify vm -s` command to pass parameters to the virtual machine:

```
# oakcli modify vm vmname -s 'key1:value1;key2:value2...'
```

The following example has two value pairs:

```
oakcli modify vm vmol6u3 -s 'com.oracle.linux.network.device.
0:eth0;com.oracle.linux.network.ipaddr.0:192.1.2.18'
```

### Note:

- For more information about Oracle VM Guest Additions, see "Using the Oracle VM Guest Additions" in the *Oracle VM Utilities Guide for x86* at [http://docs.oracle.com/cd/E35328\\_01/E35333/html/vmutl-guestadd.html](http://docs.oracle.com/cd/E35328_01/E35333/html/vmutl-guestadd.html).
- Refer to the whitepaper *Oracle Database Appliance: Automated Virtual Machine Provisioning* for more information.

### Related Topics

- <http://www.oracle.com/technetwork/database/database-appliance/overview/oda-automatedvmprovisioning-2348232.pdf>

## Opening a Virtual Machine Console for a Virtual Machine

Use the `oakcli show vmconsole` command to open a virtual machine console window for an active virtual machine

If the console does not display correctly, then close the console, set the `DISPLAY` environment variable to an appropriate value for your monitor, and then rerun the `oakcli show vmconsole` command.

You can also configure your virtual machine (using `oakcli modify vm` command with the `-s` parameter) to allow access from the OAKCLI command line instead of a graphical user interface (GUI) virtual machine console.

Use the `oakcli show vmconsole vm name` to open a console for a virtual machine. For example, use the following command to open a console for the virtual machine named `vm1_odarepol`:

```
oakcli show vmconsole vm1_odarepol
```

## Creating an Image for a New Virtual Machine

Use the `oakcli clone vm` command to create an image for a new virtual machine on Oracle Database Appliance Virtualized Platform.

By default, the image inherits the content and configuration information from the template or from the virtual machine that you are cloning and resides in the same repository as the source. Unless you are using local repositories for your virtual machines, include the `-node` clause in the `oakcli clone` command to identify the node that should run the cloning process. To create a snap clone, which will only contain the configuration metadata, include the `-snap` clause in the `oakcli clone` command.

## Setting Up a Virtual Machine for Access from eth0 Using an IP Address

Configure a network device (`eth0`) with an IP address for a virtual machine.

The following set of commands configures the virtual machine `vmol6u3` (which has `ovmd`) with the IP address `192.168.16.51` for the `eth0` interface and sets the root password.

```
oakcli clone vm vmol6u3 -vmtemplate ol6u3 -repo shrepo -node 0
oakcli modify vm vmol6u3 -addnetwork priv1
oakcli start vm vmol6u3
oakcli modify vm vmol6u3 -s 'com.oracle.linux.network.device.0:eth0'
oakcli modify vm vmol6u3 -s 'com.oracle.linux.network.onboot.0:yes'
oakcli modify vm vmol6u3 -s 'com.oracle.linux.network.bootproto.0:static'
oakcli modify vm vmol6u3 -s 'com.oracle.linux.network.ipaddr.0:192.168.16.51'
oakcli modify vm vmol6u3 -s 'com.oracle.linux.network.netmask.0:255.255.255.0'
oakcli modify vm vmol6u3 -s 'com.oracle.linux.root-password:password'
```

## Adding or Removing a Virtual Disk to or from a Virtual Machine

Use the `oakcli modify vm` command to add or remove a virtual disk (vdisk) from a virtual machine.

Do not use the `-attachvdisk` or the `-detachvdisk` option with the `-addnetwork`, `-deletenetwork`, or `-s key:value` pair parameters.

- To attach a virtual disk to a virtual machine, use the `oakcli modify vm vm_name` command with the `-attachvdisk` clause that names the virtual disk.

```
oakcli modify vm vm_name -attachvdisk vdisk_name
```

- To detach a virtual disk from a virtual machine, use the `oakcli modify vm vm_name` command with the `-detachvdisk` clause that names the virtual disk.

```
oakcli modify vm vm_name -detachvdisk vdisk_name
```

## Removing a Virtual Machine from a Shared Repository

Use the `oakcli delete vm` command to delete the virtual machine and reclaim its storage and resources.

When you no longer have use for a particular virtual machine, delete the machine. When deleting the machine, you can specify the Oracle Database Appliance node from which you want to remove the virtual machine. If this optional parameter is not included, then the virtual machine is removed from both nodes.

- Delete the virtual machine from Node 1.

For example, run the following command to delete the `ovu22` virtual machine from Node 1.

```
oakcli delete vm ovu22 -server 1
```

- Delete the virtual machine from both nodes.

For example, run the following command to delete the `ovu22` virtual machine from both nodes.

```
oakcli delete vm ovu22
```

## Performing a Live Migration for an Oracle Database Appliance Virtual Machine

If your system meets requirements for live migration, then you can use the `oakcli migrate vm` command to migrate a virtual machine from the currently running node to another node.

Live Migration refers to the process of moving a running virtual machine between physical machines without disconnecting the client or application running in the virtual

machine. Memory, storage, and network connectivity of the virtual machine are transferred from the original host machine to the destination.

You must meet the following requirements before performing a live migration:

- The virtual machine must be on a shared repository and the repository must be online on both nodes.
- The virtual machine must be running.
- The destination host must have the required resources (memory, CPUs and so on) for successful migration.
- The destination host must have a CPU pool with the same name as the CPU pool of the virtual machine that is being migrated.

Use the `oakcli migrate vm vmname` command to migrate a virtual machine from the currently running node to another node. *vmname* is the name of the virtual machine to be migrated.

When you run this command, the virtual machine must be online and corresponding, and the shared repository must be online on both nodes. If a virtual machine is in the migration process, then OAKCLI will display the virtual machine state as `MIGRATING`.

### Example 12-20 Example of Migrating a Virtual Machine from the Currently Running Node to Another Node

This example migrates a virtual machine named `myvm1`

```
# oakcli migrate vm myvm1
```

## How to Create Driver Domain Virtual Machines

Use driver domain virtual machines to improve performance.

- [About Driver Domain Virtual Machines](#)  
Use driver domain virtual machines to improve performance by enabling guest virtual machines (VMs) to use `ODA_BASE` instead of `Dom0` to access virtual disks.
- [Creating a Driver Domain Virtual Machine from a Template](#)  
Create a driver domain virtual machine from a virtual machine template.
- [Converting a Virtual Machine to a Driver Domain Virtual Machine](#)  
Convert a guest virtual machine to a driver domain virtual machine to improve performance.
- [Converting a Root Disk to a Driver Domain Disk](#)  
Set up your guest virtual machine (guest VM) root disk as a driver domain and create a new disk as the boot driver.

## About Driver Domain Virtual Machines

Use driver domain virtual machines to improve performance by enabling guest virtual machines (VMs) to use `ODA_BASE` instead of `Dom0` to access virtual disks.

A *driver domain* is a user domain that has special privileges and responsibilities for a particular piece of hardware. When you use the driver domain option, the newly created virtual disks are mounted directly from `ODA_BASE` to a guest virtual machine.

The option improves I/O performance by enabling guest virtual machines to use `ODA_BASE` instead of `Dom0` to access virtual disks.

The driver domain functionality applies to non-system disks. Once a virtual machine is created in driver domain mode, any new vDisks are added in driver domain mode. Newly created virtual disks are mounted directly from `ODA_BASE` to a guest virtual machine. To determine if a virtual machine is configured in driver domain mode, use the `oakcli show vm vmname` command. When the virtual machine is in driver mode, the output for the `DriverDomain` attribute is `TRUE`.

The virtual disk and `vm.cfg` files are stored in the following directories:

- `Dom0: /Repositories/vm_repo_name/.ACFS/snaps/vm_name/VirtualMachines/vm_name`
- `ODA_BASE: /app/sharedrepo/vm_repo_name/.ACFS/snaps/vm_name/VirtualMachines/vm_name`

The driver domain only works when you add virtual disks to a guest virtual machine. When a virtual machine is in driver domain mode, the corresponding virtual machine configuration file, `vm.cfg`, has the following disk entries:

When `-driverdomain` is specified, the cloned virtual machine is configured with the driver domain. The corresponding virtual machine configuration file, `vm.cfg`, has the following disk entries:

```
disk = [u'file:/OVS/Repositories/repo5/.ACFS/snaps/vm10/
VirtualMachines/
vm10/System.img,xvda,w',
u'file:/u01/app/sharedrepo/repo5/.ACFS/snaps/
vm10/VirtualMachines/vm10/u01.img,xvdb,w,oakDom1' ]
```

All disks, with the exception of the `xvda` boot disk, have the path from `oakDom1`, that is `odabase`.

The following guest operating systems are supported for driver domain virtual machines:

- Oracle Linux with the latest Unbreakable Enterprise Kernel 2 (UEK2) or Unbreakable Enterprise Kernel 3 (UEK3).
- Microsoft Windows with Oracle VM Windows PV Driver 3.4.2. Oracle VM Windows PV Driver 3.4.2 release is available for download on My Oracle Support as patch number 23346086.
- Oracle Solaris 11.3 or higher x86.

## Creating a Driver Domain Virtual Machine from a Template

Create a driver domain virtual machine from a virtual machine template.

Several options are available to create, or import, a template that you will use to create the clone. Determine the virtual machine template you want, the method to import the template, and the naming convention for the template.

This example imports a virtual machine template from `Dom0` and uses the template to create a driver domain virtual machine. The virtual machine image is named

myol6u\_test myol6u\_ol5u7\_vm\_alpha from the virtual machine template named myol6u\_15gb1 (OL5U7), which is stored in the shared repository named repo2 (odarepo1) on Node 0 in driver domain mode.

1. Use the `oakcli import vmtemplate` command to import a virtual machine template and name the template.

For example, import virtual machine template `OVM_OL5U7_X86_64_PVM_10GB.tgz` from the `/OVS` directory in Dom0 into the `odarepo1` shared repository on Node 0 in driver domain mode and name the template file `OL5U7`.

```
oakcli import vmtemplate OL5U7 -files /OVS/  
OVM_OL5U7_X86_64_PVM_10GB.tgz -repo odarepo1
```

2. Use the `oakcli clone vm` command to create a clone that uses the driver domain.

For example, create a virtual machine image named `vm1_ol5u7` from the virtual machine template named `OL5U7`, which is stored in the shared repository named `odarepo1` on Node 0:

clone virtual machine

```
oakcli clone vm vm1_ol5u7 -vmtemplate OL5U7 -repo odarepo1 -node 0 -  
driverdomain
```

3. Run the `oakcli show vm` command to confirm that the virtual machine is configured in driver domain mode.

When the virtual machine is in driver mode, the output for the `DriverDomain` attribute is `TRUE`.

```
oakcli show vm vm1_ol5u7
```

4. Use the `oakcli start vm` command to start the virtual machine.

For example, start the virtual machine named `vm1_ol5u7` on Node 0.

```
oakcli start vm vm1_ol5u7 -node 0
```

## Converting a Virtual Machine to a Driver Domain Virtual Machine

Convert a guest virtual machine to a driver domain virtual machine to improve performance.

You can clone an existing virtual machine that uses Dom0 to create a clone virtual machine that uses the driver domain `ODA_BASE` instead of Dom0.

In this example, virtual machine `vm-dom0_ol5u7` is on Dom0 and is not a driver domain virtual machine. The example creates a clone virtual machine named `vm-dd1_ol5u7` that uses the driver domain `ODA_BASE`.

1. Use the `oakcli stop` command to shut down the virtual machine.

For example, stop the virtual machine named `vm-dom0_ol5u7`. Shutting down the virtual machine ensures that there is consistent data from the virtual machine (vm) and virtual disks (vdisks)

```
oakcli stop vm vm2_ol5u7 -force
```

2. Detach the virtual disk (vdisk) from `vm-dom0_ol5u7`
3. Use the `oakcli clone vm` command to clone a new virtual machine from the original.

Create a new virtual machine named `vm-dd1_ol5u7` from the original virtual machine named `vm-dom0_ol5u7`. Use the `-snap` option to create a snapshot of the source virtual machine. Because the original virtual machine is not a driver domain machine, use the `-force` and `-driverdomain` options to create a clone virtual machine that does use the driver domain.

```
oakcli clone vm vm-dd1_ol5u7 -vm vm-dom0_ol5u7 -snap -force -driverdomain
```

4. Attach the virtual disk (vdisk) that you detached from the source virtual machine in Step 2 to the new driver domain virtual machine.

Attaching the vdisk ensures that the `vm.cfg` has the disk information with the driver domain feature.

5. Verify that `oakDom1` is the vdisk in the new `vm.cfg`.
6. Run the `oakcli show vm` to confirm that the newly created virtual machine is configured in driver domain mode.

When the virtual machine, `vm-dd1_ol5u7`, is in driver domain mode, the output for the `DriverDomain` attribute is `TRUE`.

```
oakcli show vm vm-dd1_ol5u7
```

7. Use the `oakcli start vm` command to start the virtual machine.

For example, start the virtual machine named `vm-dd1_ol5u7` on Node 0.

```
oakcli start vm vm-dd1_ol5u7 -node 0
```

## Converting a Root Disk to a Driver Domain Disk

Set up your guest virtual machine (guest VM) root disk as a driver domain and create a new disk as the boot driver.

This example clones an existing guest virtual machine as a driver domain guest VM and then uses the `OL6U7_x86_64_PVHVM` template to create a guest VM and create a new disk for the boot driver.

Using the driver domain improves the guest VM disk IO performance; however, the driver domain is not applicable for a guest VM virtual disk that is a boot disk. Because the boot disk is generally the root disk, you must create a new disk to be the boot driver.

You can create a guest virtual machine by cloning an existing guest, or use one of the templates, such as `OL6U7_x86_64_PVHVM` or `OVM_OL5U7_X86_64_PVM_10GB.tgz`, that are available in the `/OVS` directory in `Dom0`.

Using driver domains requires at least Oracle Database Appliance version 12.1.2.7.0.



In this example, the following is the layout of disks in the original OL6U7 virtual machine:

```
- boot/root disk '/dev/xvda' (echo -e "p" | fdisk /dev/xvda):
Device Boot Start End Blocks Id System
/dev/xvda1 * 2 503 514048 83 Linux
/dev/xvda2 504 11264 11019264 83 Linux
/dev/xvda3 11265 15360 4194304 82 Linux swap / Solaris
- u01 disk '/dev/xvdb' (echo -e "p" | fdisk /dev/xvdb):
Device Boot Start End Blocks Id System
/dev/xvdb1 1 13054 104856223+ 83 Linux
```

The `/etc/fstab` is as follows:

```
# cat /etc/fstab
UUID=b072e1e9-05a9-4544-a4dd-b15ba49cea2f / ext4 defaults 1 1
UUID=301e09e2-78e4-47d6-b501-d4f1098b419d /boot ext4 defaults 1 2
UUID=39e5a125-ald8-48f4-9e81-f9e89b4dd51b swap swap defaults 0 0
tmpfs /dev/shm tmpfs defaults 0 0
devpts /dev/pts devpts gid=5,mode=620 0 0
sysfs /sys sysfs defaults 0 0
proc /proc proc defaults 0 0
UUID=770078eb-c083-4d52-81bf-e026ab3f3fa7 /u01 ext4 defaults 1 2
```

The `df -h` is as follows:

```
# df -h
Filesystem Size Used Avail Use% Mounted on
/dev/xvda2 11G 814M 8.9G 9%
/tmpfs 3.9G 0 3.9G 0% /dev/shm
/dev/xvda1 479M 51M 399M 12% /boot
/dev/xvdb1 92G 55G 33G 63% /u01
```

### 1. Clone a guest VM as a driver domain guest VM.

You can use one of the following commands to clone a virtual machine:

- `oakcli clone vm vm_name -vmtemplate template_name -repo repo_name [-node 0|1] [-driverdomain]`
- `oakcli clone vm vm_name -vmtemplate src_vmtempl_name -snap [-driverdomain]`
- `oakcli clone vm vm_name -vm src_vm_name -snap [-force] [-driverdomain]`

#### Note:

You must stop the virtual machine before taking a snapshot.

For example, create a driver domain guest VM named `OL6U7` from the `OL6U7_x86_64_PVHVM` source VM template. Use the `-snap` option to designate that you want to create a snapshot of the source virtual machine and the –

`driverdomain` option to indicate that the new virtual machine will use the driver domain.

```
oakcli clone vm OL6U7 -vm OL6U7_x86_64_PVHVM -snap -driverdomain
```

## 2. Create a new boot virtual disk.

```
dd if=/dev/zero of=/u01/app/sharedrepo/repo name/.ACFS/snaps/vm_name/
VirtualMachines/vm_name/virtual diskfile name.img oflag=direct count=0
bs=1M seek=new size in MB
```

For example, create a 500 MB boot virtual disk named `newboot` for the OL6U7 virtual machine that is in the `odarepo1` repository:

```
# dd if=/dev/zero of=/u01/app/sharedrepo/odarepo1/.ACFS/snaps/OL6U7/
VirtualMachines/OL6U7/newboot.img oflag=direct count=0 bs=1M seek=500
```

## 3. Edit the `vm.cfg` file to attach the new boot disk to your guest VM.

### a. Navigate to the `vm.cfg` file.

```
/u01/app/sharedrepo/vm repo/.ACFS/snaps/vm name/VirtualMachines/vm
name/vm.cfg
```

For example, the OL6U7 virtual machine is in the `odarepo1` repository:

```
/u01/app/sharedrepo/odarepo1/.ACFS/snaps/OL6U7/VirtualMachines/
OL6U7/vm.cfg
```

### b. Add the new disk entry on the disk parameter.

```
disk = ['file:virtual disk file path,virtual device,r/w option']
```

For example, add the `newboot` virtual disk for the OL6U7 virtual machine, which is in the `odarepo1` repository.

```
disk =
[u'file:/OVS/Repositories/odarepo1/.ACFS/snaps/OL6U7/
VirtualMachines/OL6U7/15f96d92a66c4b808035116ab6348d0d.img,xvda,w',
u'file:/u01/app/sharedrepo/odarepo1/.ACFS/snaps/oakvdk_ol6u7_u01/
VirtualDisks/oakvdk_ol6u7_u01,xvdb,w,oakDom1',
u'file:/u01/app/sharedrepo/odarepo1/.ACFS/snaps/
oakvdk_ol6u7_bootdisk/VirtualDisks/
oakvdk_ol6u7_bootdisk,xvdc,w,oakDom1']
(...)
```

The following example shows the `newboot` virtual disk:

```
disk =
[u'file:/OVS/Repositories/odarepo1/.ACFS/snaps/OL6U7/
VirtualMachines/OL6U7/15f96d92a66c4b808035116ab6348d0d.img,xvda,w',
u'file:/u01/app/sharedrepo/odarepo1/.ACFS/snaps/oakvdk_ol6u7_u01/
```

```
VirtualDisks/oakvdk_ol6u7_u01,xvdb,w,oakDom1',
u'file:/OVS/Repositories/odarepo1/.ACFS/snaps/OL6U7/VirtualMachines/
OL6U7/newboot.img,xvdc,w' ]
(...)
```

#### 4. Stop and restart your guest VM.

```
oakcli stop vm vm_name
oakcli start vm vm_name
```

For example, stop and restart the OL6U7 guest.

```
oakcli stop vm OL6U7oakcli start vm OL6U7
```

The new disks are available to the guest VM after the restart.

#### 5. Create a disk partition on the new boot driver.

A new empty virtual disk appears as an `/dev/xvdc` device.

```
# dmesg |grep xvdc
blkfront: xvdc: flush diskcache: enabled; persistent grants: enabled;
indirect descriptors: enabled;
xvdc: unknown partition table
```

Use the `fdisk` command to partition the disk and make the partition bootable.

```
echo -e "n\np\n1\n\n\nnt\n83\na\n1\n\nw" | fdisk /dev/xvdc
Device      Boot Start End Blocks Id System
/dev/xvdc1 *          1  63  506016 83 Linux
```

#### 6. Format the new boot disk partition `/dev/xvdc1`.

```
mkfs.ext4 /dev/xvdc1
```

#### 7. Setup and mount the new boot disk partition and get the single blockID.

```
mkdir /virtual diskfile namemount /dev/xvdc1 /virtual diskfile name
```

##### a. Setup and mount the new boot disk.

```
mkdir /virtual diskfile namemount /dev/xvdc1 /virtual diskfile name
```

For example, make a directory and mount the `newboot` boot disk:

```
mkdir /newbootmount /dev/xvdc1 /newboot
```

##### b. Get the single blockID.

```
# blkid /dev/xvdc1/dev/xvdc1: UUID="3d7a177b-0fa0-4212-9c0c-
c5554bb1817a" TYPE="ext4"
```

**8. Copy the original boot content to the new boot disk.**

```
cp -dpR /boot/* /virtual diskfile name
```

For example, for the disk named `newboot`:

```
cp -dpR /boot/* /newboot
```

**9. Make the new boot partition the active boot partition**

```
umount /virtual diskfile nameumount /bootmount /dev/xvdc1 /boot
```

```
umount /newbootumount /bootmount /dev/xvdc1 /boot
```

**10. Setup Grub in the new boot disk.**

Use the `grub` or `grub2` command, where `/dev/xvdc` is the new boot disk device.

- If you are using Oracle Linux 6U7, use `grub`:

```
# grub
grub> device (hd0) /dev/xvdc
grub> root (hd0,0)
grub> setup (hd0)
```

- If you are using Oracle Linux 7u2, use `grub2`:

```
# grub2-mkconfig -o /boot/grub2/grub.cfg
# grub2-install /dev/xvdc
```

The following example uses `grub`:

```
# grub
Probing devices to guess BIOS drives. This may take a long time.
GNU GRUB version 0.97 (640K lower / 3072K upper memory)
[ Minimal BASH-like line editing is supported. For the first word, TAB
lists possible command completions. Anywhere else TAB lists the possible
completions of a device/filename.]
grub> device (hd0) /dev/xvdc
device (hd0) /dev/xvdc
grub> root (hd0,0)
root (hd0,0)
Filesystem type is ext2fs, partition type 0x83
grub> setup (hd0)
setup (hd0)
Checking if "/boot/grub/stage1" exists... no
Checking if "/grub/stage1" exists... yes
Checking if "/grub/stage2" exists... yes
Checking if "/grub/e2fs_stage1_5" exists... yes
Running "embed /grub/e2fs_stage1_5 (hd0)"... 27 sectors are embedded.
succeeded
Running "install /grub/stage1 (hd0) (hd0)1+27 p (hd0,0)/grub/stage2 /
grub/grub.conf"... succeeded
```

```
Done.
grub> quit
quit
```

The following example uses grub2:

```
# grub2-mkconfig -o /boot/grub2/grub.cfg
Generating grub configuration file ...
Found linux image: /boot/vmlinuz-3.10.0-327.3.1.el7.x86_64
Found initrd image: /boot/initramfs-3.10.0-327.3.1.el7.x86_64.img
Found linux image: /boot/vmlinuz-3.8.13-118.2.1.el7uek.x86_64
Found initrd image: /boot/initramfs-3.8.13-118.2.1.el7uek.x86_64.img
Found linux image: /boot/vmlinuz-0-
rescue-8f9df86c6d4c4640a01315a3aa93790e
Found initrd image: /boot/initramfs-0-
rescue-8f9df86c6d4c4640a01315a3aa93790e.img
done

# grub2-install /dev/xvdc
Installing for i386-pc platform.
Installation finished.
No error reported.
```

#### 11. Edit /etc/fstab with the new boot device.

```
UUID=b072e1e9-05a9-4544-a4dd-b15ba49cea2f / ext4 defaults 1 1
#UUID=301e09e2-78e4-47d6-b501-d4f1098b419d /boot ext4 defaults 1 2
<<--- Original boot device
UUID=3d7a177b-0fa0-4212-9c0c-c5554bb1817a /boot ext4 defaults 1 2

UUID=39e5a125-ald8-48f4-9e81-f9e89b4dd51b swap swap defaults 0 0
tmpfs /dev/shm tmpfs defaults 0 0
devpts /dev/pts devpts gid=5,mode=620 0 0
sysfs /sys sysfs defaults 0 0
proc /proc proc defaults 0 0

UUID=770078eb-c083-4d52-81bf-e026ab3f3fa7 /u01 ext4 defaults 1 2
```

#### 12. Edit the vm.cfg file and make the new boot virtual disk the first disk on the list.



#### Note:

The driver domain device use the following root path /u01/app/sharedrepo. The boot disk root path is /OVS/Repositories.

The entries in the disk section of the vm.cfg file will look something like the following:

```
u'file:/OVS/Repositories/rcrepo/.ACFS/snaps/OL6U7/VirtualMachines/
OL6U7/15f96d92a66c4b808035116ab6348d0d.img,xvda,w',
<<--- original boot/root disk
```

```

u'file:/u01/app/sharedrepo/rcrepo/.ACFS/snaps/oakvdk_ol6u7_u01/
VirtualDisks/oakvdk_ol6u7_u01,xvdb,w,oakDom1',
<<-- original u01 disku'file:/OVS/Repositories/rcrepo/.ACFS/snaps/OL6U7/
VirtualMachines/OL6U7/newboot.img,xvdc,w'
<<-- new boot disk

```

Move the new boot virtual disk, `newboot`, to the first disk on the list.

```

u'file:/OVS/Repositories/rcrepo/.ACFS/snaps/OL6U7/VirtualMachines/OL6U7/
newboot.img,xvda,w'
<<-- new boot disk
u'file:/u01/app/sharedrepo/rcrepo/.ACFS/snaps/OL6U7/VirtualMachines/
OL6U7/15f96d92a66c4b808035116ab6348d0d.img,xvdb,w,oakDom1
<<-- original boot/root disku'file:/u01/app/sharedrepo/rcrepo/.ACFS/
snaps/oakvdk_ol6u7_u01/VirtualDisks/oakvdk_ol6u7_u01,xvdc,w,oakDom1'
<<-original u01 disk

```

The new boot device (`xvdc`) becomes the first device (not driver domain) and `xvda` is the second domain driver device.

The following is an example of the `vm.cfg` before the edit:

```

# cat vm.cfg
vif = ['type=netfront,bridge=net1']
name = 'OL6U7'
extra = 'NODENAME=OL6U7'
builder = 'hvm'
cpus =
'24,25,26,27,28,29,30,31,32,33,34,35,36,37,38,39,40,41,42,43,44,45,46,47
,48,49,50,51,52,53,54,55,56,57,58,59,60,61,62,63,64,65,6
vcpus = 2
memory = 8192
cpu_cap = 0
vnc = 1
serial = 'pty'
disk =
[u'file:/OVS/Repositories/rcrepo/.ACFS/snaps/OL6U7/VirtualMachines/
OL6U7/15f96d92a66c4b808035116ab6348d0d.img,xvda,w',
u'file:/u01/app/sharedrepo/rcrepo/.ACFS/snaps/oakvdk_ol6u7_u01/
VirtualDisks/oakvdk_ol6u7_u01,xvdb,w,oakDom1',
u'file:/OVS/Repositories/rcrepo/.ACFS/snaps/OL6U7/VirtualMachines/OL6U7/
newboot.img,xvdc,w']
maxvcpus = 2
maxmem = 8192

```

The following is an example of the `vm.cfg` after the edit, where the new boot device (`xvdc`) is the first device and `xvda` is the driver domain device:

```

# cat vm.cfg
vif = ['type=netfront,bridge=net1']
name = 'OL6U7'
extra = 'NODENAME=OL6U7'
builder = 'hvm'

```

```
cpus =
'24,25,26,27,28,29,30,31,32,33,34,35,36,37,38,39,40,41,42,43,44,45,46,47
,48,49,50,51,52,53,54,55,56,57,58,59,60,61,62,63,64,65,6
vcpus = 2
memory = 8192
cpu_cap = 0
vnc = 1
serial = 'pty'
disk =[
[u'file:/OVS/Repositories/rcrepo/.ACFS/snaps/OL6U7/VirtualMachines/
OL6U7/newboot.img,xvda,w',
u'file:/u01/app/sharedrepo/u'file:/u01/app/sharedrepo/rcrepo/.ACFS/
snaps/oakvdk_ol6u7_u01/VirtualDisks/oakvdk_ol6u7_u01,xvdc,w,oakDom1' ]
maxvcpus = 2
maxmem = 8192
```

### 13. Stop and restart the guest VM

```
oakcli stop vm vm_name
oakcli start vm vm_name
```

```
oakcli stop vm OL6U7
oakcli start vm OL6U7
```

### 14. Check the layout of the new disks.

The layout should be similar to the following:

```
# df -h
Filesystem Size Used Avail Use% Mounted on/dev/xvdb2 11G 814M 8.9G 9% /
tmpfs 3.9G 0 3.9G 0% /dev/shm
/dev/xvda1 471M 51M 391M 12% /boot
/dev/xvdc1 92G 55G 33G 63% /u01
```

The swap device is now under the driver domain: /dev/xvdb

```
# swapon -s
Filename      Type      Size      Used Priority
/dev/xvdb3   partition 4194300 0      -1
```

### 15. (Optional) Synchronize the oakcli virtual machine inventory with the `vm.cfg` file.

When you edit the `vm.cfg` file, the `oakcli show vm vm_name` output displays incorrect information about the disk. You can create a temporary duplicate (snapshot) of the virtual machine to fix the output.

```
oakcli stop vm vm_name
oakcli clone vm tmp_vm_name -vm vm_name -snap -driverdomain
oakcli delete vm vm_name
oakcli clone vm vm_name -vm tmp_vm_name -snap -driverdomain
oakcli delete vm tmp_vm_name
```

 **Note:**

Stop the virtual machine before taking a snapshot.

For example, create a temporary clone called `tmp_OL6U7` of the virtual machine `OL6U7` using the `-snap` and `-driverdomain` options. Delete the virtual machine `OL6U7`, and then use the temporary clone to create a new clone. Delete the temporary virtual machine.

```
oakcli stop vm OL6U7
oakcli clone vm tmp_OL6U7 -vm OL6U7 -snap -driverdomain
oakcli delete vm OL6U7
oakcli clone vm OL6U7 -vm tmp_OL6U7 -snap -driverdomain
oakcli delete vm tmp_OL6U7
```

 **Note:**

The `oakcli clone vm` command creates a duplicate (snapshot) of the VDisks that are attached to the guest VM. Use the `oakcli delete vdisk` command to remove the orphan VDisks.

Run the `oakcli show vm vm_name` command to verify that the `oakcli` virtual machine inventory is in sync with the `vm.cfg` file.

```
# oakcli show vm OL6U7
The Resource is : OL6U7
AutoStart : restore
CPUPriority : 100
Disks : |file:/OVS/Repositories/rcrepo/.ACF
S/snaps/OL6U7/VirtualMachines/OL6U7
/newboot.img,xvda,w||file:/u01/app/
sharedrepo/rcrepo/.ACFS/snaps/OL6U7
/VirtualMachines/OL6U7/15f96d92a66c
4b808035116ab6348d0d.img,xvdb,w,oak
Dom1|
Domain : XEN_PVM
DriverDomain : True
ExpectedState : offline
FailOver : false
IsSharedRepo : true
Keyboard : en-us
MaxMemory : 8192M
MaxVcpu : 2
Memory : 8192M
Mouse : OS_DEFAULT
Name : OL6U7
Networks : |type=netfront,bridge=net1|
NodeNumStart : 0
OS : OL_5
PrefNodeNum : 0
```



```
PrivateIP : None
ProcessorCap : 0
RepoName : rcrepo
State : Offline
TemplateName : tmp_OL6U7
VDisks : |oakvdk_snap_3_ol6u7_u01_rcrepo|
Vcpu : 2
cpupool : default-unpinned-pool
```

## How to Manage High Availability on Oracle Database Appliance Virtualized Platform

Use the `oakcli configure vm` command to configure high availability services for your virtual machines.

A system that is highly available is designed to provide uninterrupted computing services during essential time periods, during most hours of the day, and during most days of the week throughout the year. Reliability, recoverability, timely error detection, and continuous operations are primary characteristics of a highly available solution. Two essential parts of high availability are automatic restart and failover.

Unless you are using local repositories, you can set high availability options for your virtual machines. High availability options identify the node where the virtual machine should be started by default and whether the virtual machine should be failed over to the other node. Failover can occur if the node where the virtual machine is already running fails or if the preferred node is not available when the virtual machines attempt to start.

### Configuring Automatic Restart for High Availability

A virtual machine automatically restarts after a hardware or software failure or whenever your database host computer restarts. Use the `oakcli configure vm` command to start a virtual machine on a preferred node by using the `-prefnode` option.

### Configuring Failover for High Availability

Configuring failover provides high availability by enabling a virtual machine to restart on the other node after an unplanned failure, without requiring manual intervention. Use the command `oakcli configure vm` with the `-failover` option to configure fail over from one node to another.

## How to Manage CPU Pools on Oracle Database Appliance Virtualized Platform

These topics describe how to use OAKCLI to create and manage CPU pools on Oracle Database Appliance Virtualized Platform.

- [About Managing CPU Pools for Resource Allocation](#)  
Use CPU pools to cage and manage resource allocations to workloads for virtual machines on Oracle Database Appliance Virtualized Platforms.

- [About Over-Subscribed CPU Pools](#)  
Configure virtual machines so that they do not subscribe to more CPU resources than the resources available in CPU pools.
- [Creating a New CPU Pool on Oracle Database Appliance Virtualized Platform Nodes](#)  
Use the command `oakcli create cpupool` to create a CPU pool.
- [Showing the CPU Pools Configured on Oracle Database Appliance Virtualized Platform Nodes](#)  
Use the command `oakcli show cpupool` command to display the CPUs assigned to each defined CPU pool.
- [Changing the Number of CPUs Assigned to a CPU Pool on Oracle Database Appliance Virtualized Platform Nodes](#)  
Use the `oakcli configure cpupool` command to change the number of CPUs assigned to a CPU pool.
- [Assigning a Virtual Machine to a CPU Pool on Oracle Database Appliance Virtualized Platform](#)  
Use the command `oakcli configure vm` to assign a virtual machine to a CPU pool.

## About Managing CPU Pools for Resource Allocation

Use CPU pools to cage and manage resource allocations to workloads for virtual machines on Oracle Database Appliance Virtualized Platforms.

Workloads are isolated by creating CPU pools and assigning (pinning) virtual machines to a specific CPU pool. When you pin a virtual machine to a CPU pool, you ensure that the virtual machine uses CPUs in only that CPU pool.

When you initially configure Oracle Database Appliance Virtualized Platform, a default-unpinned-pool is created on each node. The size of this pool depends on the hardware model.

When you create the ODA\_BASE domain, a new CPU pool is created on both nodes. The pool is named `odaBaseCpuPool`. The CPUs required for this pool are removed from the default-unpinned-pool. ODA\_BASE is the only domain allowed to use the CPUs in the `odaBaseCpuPool`. When you start other virtual machines, the virtual machines run on CPUs that are left in the default-unpinned-pool, effectively removing ODA\_BASE from the work being done by other virtual machines.

You can also cage groups of virtual machines by creating additional CPU pools. These additional pools enable you to pin a virtual machine, or a set of virtual machines, to its own CPU pool. Virtual machines running in a specific CPU pool do not share CPU cycles with virtual machines running in other CPU pools. Define as many CPU pools as you want, up to the number of available CPUs on your system.

If your application requirements change over time, then Oracle recommends that you resize, add, or drop CPU pools as needed to make the best use of your resources. You may also want to resize ODA\_BASE. However, if you want to resize ODA\_BASE, then you must use a special command that also updates your Oracle Database Appliance Virtualized Platform license.

**Example 12-21 Example of Showing CPU Pools on a Node**

A CPU pool can have a different size on each node (except for the `odaBaseCpuPool`), as shown by the following `oakcli show cpupool` commands, one for each node:

```
oakcli show cpupool -node 0
      Pool                               Cpu List
default-unpinned-pool [14, 15, 16, 17, 18, 19, 20, 2
                               1, 22, 23]
      twocpu                               [12, 13]
odaBaseCpuPool [0, 1, 2, 3, 4, 5, 6, 7, 8, 9,
                               10, 11]
```

```
oakcli show cpupool -node 1
      Pool                               Cpu List
default-unpinned-pool [12, 13, 14, 15, 16, 17, 18, 1
                               9, 20, 21, 22, 23]
odaBaseCpuPool [0, 1, 2, 3, 4, 5, 6, 7, 8, 9,
                               10,11]
```

## About Over-Subscribed CPU Pools

Configure virtual machines so that they do not subscribe to more CPU resources than the resources available in CPU pools.

A CPU resource can belong to one, and only one, CPU pool. You can assign multiple virtual machines to a CPU pool. A CPU pool becomes oversubscribed when the virtual machines that are active in the pool require more CPUs than you configured for the pool. For example, if a CPU pool has four CPUs, then you can start two virtual machines that are defined to use four CPUs each. In this case, the CPU pool is oversubscribed, because each of the four CPUs is supporting two virtual machines.

If you stop one of those virtual machines, but start another one that requires two CPUs, then the CPU pool is still oversubscribed. This is because two of the CPUs are supporting both virtual machines. When oversubscribing a CPU pool, assess the performance of the virtual machines in that pool. Reassign one or more virtual machines to a different CPU pool if sharing an oversubscribed pool degrades performance to unacceptable levels.

## Creating a New CPU Pool on Oracle Database Appliance Virtualized Platform Nodes

Use the command `oakcli create cpupool` to create a CPU pool.

Manage resource use by creating CPU pools, and then assign these resources to virtual machines.

**Example 12-22 Example of Creating a New CPU Pool on Oracle Database Appliance Virtualized Platform Nodes**

This example creates a CPU pool named `winpool` that is allocated 4 CPUs on Node 0:

```
oakcli create cpupool winpool -numcpu 4 -node 0
```

## Showing the CPU Pools Configured on Oracle Database Appliance Virtualized Platform Nodes

Use the command `oakcli show cpupool` command to display the CPUs assigned to each defined CPU pool.

You can use `oakcli show cpupool` to display any virtual machines assigned to each CPU pool.

### **Example 12-23 Example of Showing CPUs Assigned to Defined CPU Pools on Oracle Database Appliance Virtualized Platform Nodes**

This `oakcli show cpupool` example shows the CPUs assigned to each defined CPU pool on Node 0:

```
oakcli show cpupool -node 0
```

## Changing the Number of CPUs Assigned to a CPU Pool on Oracle Database Appliance Virtualized Platform Nodes

Use the `oakcli configure cpupool` command to change the number of CPUs assigned to a CPU pool.

An Oracle VM Server can belong to only one virtual pool. However, you can change the resources allocated to a virtual pool to increase the CPU resources available to the virtual machine.

### **Example 12-24 Example of Changing the Number of CPUs Assigned to a CPU Pool on Oracle Database Appliance Virtualized Platform Nodes**

This `oakcli configure cpupool` example changes the number of CPUs assigned to the CPU pool named `linpool` on Node 1. After the command runs, the new number of CPU resources assigned to the CPU are six.

```
oakcli configure cpupool linpool -numcpu 6 -node 1
```

## Assigning a Virtual Machine to a CPU Pool on Oracle Database Appliance Virtualized Platform

Use the command `oakcli configure vm` to assign a virtual machine to a CPU pool.

Review the availability of CPU pools on nodes as part of your placement policy for virtual machines on Oracle Database Appliance Virtualized Platforms.

If your virtual machine is assigned to a specific CPU pool, and the virtual machine is allowed to fail over, then the virtual machine attempts to use the same CPU pool on the secondary node. If the CPU pool exists on the other node, but the CPU pool is a different size, then the performance of your virtual machine can be affected when it runs on the secondary node. If the assigned CPU pool does not exist on the secondary node, then the virtual machine cannot fail over.

 **Note:**

Do not manage `odaBaseCpuPool` by using `oakcli cpupool` commands. Instead, use commands that configure `ODA_BASE`, as discussed in "How to Resize ODA\_BASE."

**Example 12-25 Example of Assigning a Virtual Machine to a CPU Pool on Oracle Database Appliance Virtualized Platform**

This `oakcli configure vm example` pins the virtual machine named `wintest` to the CPU pool named `winpool`:

```
oakcli configure vm wintest -cpupool winpool
```

# 13

## Oracle Database Appliance Command-Line Interface

The command-line interface has different classes of tools to manage Oracle Database Appliance.

- [About Oracle Database Appliance Command-Line Interface](#)  
Three classes of tools are available to perform deployment, lifecycle management, and system administration on Oracle Database Appliance.
- [Managing ODACLI Privileges and Security with SUDO](#)  
Oracle Appliance Manager command-line utility requires `root` system privileges for most administration actions. You may want to use SUDO as part of your system auditing and security policy.
- [odacli Network Commands](#)  
Use the `odacli network` commands to list and describe network interfaces.
- [odacli Apply Patch and Update Commands](#)  
Use the commands `odacli update` and `apply patch` to apply patches and update the appliance.
- [odacli Appliance Commands](#)  
Use the `odacli appliance` commands to perform lifecycle activities for the appliance.
- [odacli Backup and Recovery Commands](#)  
Use the `odacli backup` and `recover` commands to backup to and restore from Oracle Cloud Infrastructure Object Storage or disk.
- [odacli CPU Core Commands](#)  
Use the CPU Core commands to enable CPU cores and display current and historical CPU core configurations.
- [odacli Database Commands](#)  
Use the `odacli database` commands to perform database lifecycle operations.
- [odacli DBHome Commands](#)  
Use the `odacli DBHome` commands to manage database Home operations.
- [odacli Database Storage Commands](#)  
Use the Database Storage commands to list, describe, create, and delete Oracle database storage.
- [odacli Job Commands](#)  
Use the `odacli list-jobs` and `odacli describe-job` commands to display job details.
- [Log Commands](#)  
Use the `odacli log` commands to specify the options to collect and delete logs.
- [odacli Oracle Auto Service Request Commands](#)  
Use the Oracle Auto Service Request (Oracle ASR) commands to configure, update, test, and delete Oracle ASR on the system.

- [odacli OS Commands](#)  
Use the `odacli` OS commands to list and update operating system (OS) parameters.
- [odaadmcli Hardware Monitoring Commands](#)  
Use the `hardware monitoring` commands to display hardware configurations.
- [Storage Commands](#)  
Understand the commands to perform storage operations and diagnostics.

## About Oracle Database Appliance Command-Line Interface

Three classes of tools are available to perform deployment, lifecycle management, and system administration on Oracle Database Appliance.

The command-line interface (CLI) is an alternative to Oracle Database Appliance Web Console for some appliance configuration and patching tasks, database management, and job activity.

Oracle Database Appliance uses a role-based command-line interface. Use the `odacli` commands to perform lifecycle management tasks and the `odaadmcli` commands to perform storage and hardware monitoring maintenance. Many tasks related to managing Oracle Databases are also required with databases on Oracle Database Appliance. Tasks common to Oracle Database generally are described in the Oracle Database documentation library. However, to simplify tasks, use the Oracle Database Appliance command-line interface. The `odacli` and `odaadmcli` utilities combine the capabilities of the `SYS` database administrator role and the operating system Superuser (`root` user). Always perform administrative tasks using the Oracle Database Appliance Web Console or CLI utilities.

The following classes of commands are available:

- **Deployment and Configuration:** Use the deployment and configuration commands as part of the initial deployment of the appliance and to configure CPU cores.
- **Lifecycle management:** Use `odacli` commands to perform database and system administration tasks for the appliance. The `odacli` commands are the primary interface to perform life cycle activities for the appliance.
- **Administration:** Use `odaadmcli` commands to perform hardware administration tasks for the appliance. The `odaadmcli` commands are the interface for infrequent administration activities needed to manage appliance hardware components, storage, and VLAN.

You can perform the following deployment and configuration tasks:

- Configure the first network in the appliance
- Unzip and copy the Oracle Database Appliance software to the correct locations
- Set the number of CPU Cores for the system

You can perform the following appliance lifecycle tasks with `odacli` commands:

- Create and describe the appliance
- Create, list, describe, and delete databases
- Create, list, describe, and delete Oracle Database Homes
- Create, list, and describe the networks

- List and describe the jobs

You can perform the following appliance administration tasks with `odaadmcli` commands:

- Show storage, disks, diskgroups, and controllers
- Display storage diagnostics for disks and NVMe Express (NVMe)s
- Locate disks
- Show server, memory, processor, power, cooling, and network details

Depending on your version of Oracle Appliance Manager and your hardware, some of the `odacli` commands may not be available to you. To see which commands are supported on your version of Oracle Appliance Manager and your hardware, run the `odacli help` command: `odacli -h`.

### Command-Line Interface Syntax

The command-line interface commands and parameters are case-sensitive.

An `odacli` or `odaadmcli` command uses the following command syntax:

```
odacli command [options]
```

- *command* is an action you want to perform on the appliance. For example: `odacli list-networks` or `odacli describe-jobs`.
- *options* are optional parts of the `odacli` command. Options can consist of one or more options that extend the use of the `odacli` command carried out on an object. Options include additional information about the action that you want to perform on the object. Option names are preceded with a dash. Some options require the name of an object for the command to perform the action that you want to carry out. If an option is preceded with an \* (asterisk), this information is required to submit the command. When appending `-j` to the `odacli` command, the output is returned in JSON format. The help option (`-h`) is an option that is available with almost all commands. When you include the `-h` option, you can obtain additional information about the command that you want to perform.

#### Example 13-1 Command-Line Interface Syntax

```
# odacli create-database -h

Usage: create-database [options]
Options:
* --adminpassword, -m
    Password for SYS,SYSTEM and PDB Admin
--backupconfigid, -bi
    Backup Config ID
--cdb, -c
    Create Container Database (Inverse option: --no-cdb/-no-c)
--characterset, -cs
    Character Set (default:AL32UTF8)          Default: AL32UTF8
--databaseUniqueName, -u
    database unique name
--dbclass, -cl
    Database Class EE: OLTP/DSS/IMDB, SE: OLTP    Default: OLTP
```



```

--dbconsole, -co
    Enable Database Console (Inverse option: --no-dbconsole/-no-co)
--dbhomeid, -dh
    Database Home ID (Use Existing DB Home)
--dblanguage, -l
    Database Language (default:AMERICAN)          Default: AMERICAN
* --dbname, -n
    Database Name
--dbshape, -s
    Database Shape{odbls,odbl,odb2,etc.}          Default: odbl
--dbstorage, -r
    Database Storage {ACFS|ASM}                    Default: ACFS
--dbterritory, -dt
    Database Territory (default:AMERICA)          Default: AMERICA
--dbtype, -y
    Database Type: SI                               Default: SI
--help, -h
    get help
--instanceonly, -io
    Create Instance Only (For Standby)
--json, -j
    json output
--nlscharacteraset, -ns
    NLS Character Set (default:AL16UTF16)          Default: AL16UTF16
--no-cdb, -no-c
    Won't create Container Database (Inverse option: --cdb/-c)
--no-dbconsole, -no-co
    Disable Database Console (Inverse option: --dbconsole/-co)
--pdbadmin, -d
    Pluggable Database Admin User
--pdbname, -p
    Pluggable Database Name
--version, -v
    Database Version

```

### Oracle Database Appliance Manager Command-Line Interface Help

Run the `-h` command to see the usage information for all commands available for your Oracle Database Appliance. For example:

```
odacli -h
```

Run `odacli command -h` or `odacliadm command -h` to see detailed help about a specific command. For example, to see detailed help for the `odacli describe-dbhome` command, use the following:

```
odacli describe-dbhome -h
```

## Managing ODACLI Privileges and Security with SUDO

Oracle Appliance Manager command-line utility requires `root` system privileges for most administration actions. You may want to use SUDO as part of your system auditing and security policy.

For most tasks, Oracle recommends that you log in as `root` to use the Oracle Appliance Manager command-line interface on Oracle Database Appliance. If you are not logged in as `root`, then you cannot carry out most actions on the appliance. For example, if you are not logged in as `root`, then you can view storage information, but you cannot modify the storage.

### Allowing Root User Access Using SUDO

In environments where system administration is handled by a different group than database administration, or where security is a significant concern, you may want to limit access to the `root` user account and password. SUDO enables system administrators to grant certain users (or groups of users) the ability to run commands as `root`, while logging all commands and arguments as part of your security and compliance protocol.

A SUDO security policy is configured by using the file `/etc/sudoers`. Within the `sudoers` file, you can configure groups of users and sets of commands to simplify and audit server administration with SUDO commands.

#### **Caution:**

Configuring SUDO to allow a user to perform any operation is equivalent to giving that user `root` privileges. Consider carefully if this is appropriate for your security needs.

#### **See Also:**

The SUDO man pages for more information about configuring and using SUDO:

<http://www.sudo.ws/sudo.html>

### Example 13-2 SUDO Example 1: Allow a User to Perform Any ODACLI Operation

This example shows how to configure SUDO to enable a user to perform any ODACLI operation. You do this by adding lines to the commands section in the `/etc/sudoers` file:

```
## The commands section may have other options added to it.  
##  
Cmd_Alias ODACLI_CMDS=/opt/oracle/dcs/bin/odacli *  
jdoe ALL = ODACLI_CMDS
```

In this example, the user name is `jdoe`. The file parameter setting `ALL= ODACLI_CMDS` grants the user `jdoe` permission to run all `odacli` commands that are defined by the command alias `ODACLI_CMDS`. After configuration, you can copy one `sudoers` file to multiple hosts. You can also create different rules on each host.

 **Note:**

Before database creation, you must set up user equivalency with SSH for the root user on each server. If you do not set up user equivalency and configure SSH on each server, then you are prompted to provide the root password for each server during database creation.

After you configure the `sudoer` file with the user, the user `jdooe` can run the set of `odacli` commands configured with the command alias `ODACLI_CMDS`. For example:

```
odacli create-database --dbname newdb -m
Password for SYS,SYSTEM and PDB Admin:
```

Job details

```
-----
ID: 1bc31577-f910-4d3f-b6ff-8e3fccd30141
Description: Database service creation with db name: newdb
Status: Created
Created: November 30, 2018 9:23:57 AM PST
Message:
```

Task Name Start Time End Time Status

### Example 13-3 SUDO Example 2: Allow a User to Perform Only Selected ODACLI Operations

To configure SUDO to allow a user to perform only selected ODACLI operations, add lines to the commands section in the `/etc/sudoers` file as follows:

```
## DCS commands for oracle user
Cmnd_Alias DCSCMDS = /opt/oracle/dcs/bin/odacli describe-appliance
oracle ALL=          DCSCMDS
```

```
$ sudo /opt/oracle/dcs/bin/odacli describe-appliance
```

Appliance Information

```
-----
ID: a977bb04-6cf0-4c07-8e0c-91a8c7e7ebb8
Platform: OdaliteL
Data Disk Count: 6
CPU Core Count: 20
Created: October 24, 2017 6:51:52 AM HDT
```

System Information

```
-----
Name: rwsodal001
Domain Name: example.com
Time Zone: America/Adak
DB Edition: EE
DNS Servers: 10.200.76.198 10.200.76.199 192.0.2.254
```

```
NTP Servers: 10.200.0.1 10.200.0.2
```

#### Disk Group Information

DG Name	Redundancy	Percentage
Data	Normal	90
Reco	Normal	10

In this example, the user `jdoue2` tries to run the `sudo odacli list-databases` command, which is not part of the set of commands that is configured for that user. SUDO prevents `jdoue2` from running the command.

```
[jdoue2@servernode1 ~]$ sudo /opt/oracle/dcs/bin/odacli list-databases
```

```
Sorry, user jdoue2 is not allowed to execute '/opt/oracle/dcs/bin/odacli list-databases' as root on servernode1.
```

## odacli Network Commands

Use the `odacli network` commands to list and describe network interfaces.

- [odacli configure-firstnet](#)  
Use the command `configure-firstnet` to configure the first network in the appliance after racking and connecting the power and network cables.
- [odacli list-networks](#)  
Use the `odacli list-networks` command to display networks.
- [odacli describe-network](#)  
Use the `odacli describe-network` command to display the details of a specific network.
- [odacli create-network](#)  
Use the `odacli create-network` command to create a network.
- [odacli configure-network](#)  
Use the `odacli configure-network` command to configure a network.
- [odacli update-network](#)  
Use the `odacli update-network` command to update an existing network configuration.
- [odacli delete-network](#)  
Use the command `odacli delete-network` to delete a network.
- [odacli describe-networkinterface](#)  
Use the `odacli describe-networkinterface` command to display the details of any network interface.
- [odacli list-networkinterfaces](#)  
Use the `odacli list-networkinterfaces` command to display network interfaces.

## odacli configure-firstnet

Use the command `configure-firstnet` to configure the first network in the appliance after racking and connecting the power and network cables.

### File Path

```
/opt/oracle/dcs/bin/odacli
```

### Syntax

```
# /opt/oracle/dcs/bin/odacli configure-firstnet
```

### Usage Notes

This command ensures that the system is available in the network, enabling you to manage the deployment through the Oracle Appliance Manager Web Console.

- Bonded network configuration: Bonded dual-ported interface. With the bonded configuration, you can only enable one of the interfaces. The bonded configuration supports VLANs. The bonded network configuration uses `btbond1`. Default setting.
- Non-bonded network configuration: Two separate physical network interfaces, this configuration does not support VLANs. The non-bonded network configuration uses `em2` and `em3` as public interfaces.
- To change a non-bonded network configuration to a bonded configuration, run the Oracle Database Appliance Cleanup Script and redeploy the appliance.

### Example 13-4 Configuring the First Network as a Bonded Network

Configure the first network to use a `btbond1` interface without configuring DHCP. Complete the IP address, netmask address, and gateway address.

Values that you need to provide are shown in *italic font*, with the exception of the `net1` gateway address; the program obtains the gateway IP address. The program derives this gateway address using the network information you provided for the other IP addresses. Accept this value, unless your network administrator provides an alternative gateway address that is different from the default that the appliance command-line interface detects.

The following is an example of the command on a single node platform:

```
# /opt/oracle/dcs/bin/odacli configure-firstnet

Select the Interface to configure the network on (btbond1): btbond1
Configure DHCP on btbond1 (yes/no): no
INFO: You have chosen Static configuration
Enter the IP address to configure: 10.1.10.2
Enter the Netmask address to configure: 255.255.255.0
Enter the Gateway address to configure: 10.1.10.1
INFO: Plumbing the IPs now
INFO: Restarting the network
Shutting down interface btbond1: bonding: btbond1: Removing slave em2.
bonding: btbond1: releasing active interface em2
bonding: btbond1: making interface em3 the new active one.
```

```
bonding: btbond1: Removing slave em3.  
bonding: btbond1: releasing active interface em3  
:~::~~::~~::
```

### Example 13-5 Configuring the First Network as a Non-Bonded Network

The following is an example of a non-bonded configuration. For a non-bonded configuration, answer `no` to using a bonding public interface.

```
# /opt/oracle/dcs/bin/odacli configure-firstnet  
Using bonding public interface (yes/no) [yes]: no  
INFO: Breaking the bonding on btbond1  
INFO: remove bonding module: rmmod bonding  
INFO: remove slave setup in /etc/sysconfig/network-scripts/ifcfg-em2  
INFO: remove slave setup in /etc/sysconfig/network-scripts/ifcfg-em3  
INFO: Restarting the network  
Shutting down interface em1: [ OK ]  
Shutting down loopback interface: [ OK ]  
Bringing up loopback interface: [ OK ]  
Bringing up interface em1: [ OK ]  
Bringing up interface em2: [ OK ]  
Bringing up interface em3: [ OK ]  
INFO: Restarting the DCS agent  
initdcsagent stop/waiting  
initdcsagent start/running, process 57629  
Select the Interface to configure the network on (em2 em3) [em2]:  
Configure DHCP on em2 (yes/no) [no]:  
INFO: You have chosen Static configuration  
Enter the IP address to configure : 10.31.102.101  
Enter the Netmask address to configure : 255.255.240.0  
Enter the Gateway address to configure[10.31.96.1] :  
INFO: Plumbing the IPs now  
INFO: Restarting the network  
Shutting down interface em1: [ OK ]  
Shutting down interface em2: [ OK ]  
Shutting down interface em3: [ OK ]  
Shutting down loopback interface: [ OK ]  
Bringing up loopback interface: [ OK ]  
Bringing up interface em1: [ OK ]  
Bringing up interface em2: Determining if ip address 10.31.102.101 is  
already in use for device em2...  
[ OK ]  
Bringing up interface em3: [ OK ]
```

## odacli list-networks

Use the `odacli list-networks` command to display networks.

### File Path

```
$ORACLE_HOME/opt/oracle/dcs/bin/odacli
```

## Syntax

```
odacli list-networks [-j] [-h]
```

## Parameters

Parameter	Description
--json, -j	(Optional) Displays JSON output.
--help, -h	(Optional) Displays help for using the command.
--nodeNumber, -u	(Optional) Displays the network interface information for the specified node. By default, the node number is always the first node (Node0).

### Example 13-6 Displaying a List of Networks

Use the `odacli list-networks` command to display a list of networks:

```
# odacli list-networks
ID                               Name                               NIC
InterfaceType
IP Address      Subnet Mask      Gateway      VlanId
-----
93c07043-3002-494a-8fa0-f3ae932fb4c5  Private-network  ibbond0
BOND
192.168.16.25      255.255.255.0
```

## odacli describe-network

Use the `odacli describe-network` command to display the details of a specific network.

### File Path

```
$ORACLE_HOME/opt/oracle/dcs/bin/odacli
```

## Syntax

To display the details of a specific network:

```
odacli describe-network -i id [-j][-u][-h]
```

## Parameters

Parameter	Description
--id, -i	Identifies the network ID. Use the <code>odacli list-networks</code> command to obtain the id.
--json, -j	(Optional) Displays JSON output.
--help, -h	(Optional) Displays help for using the command.

Parameter	Description
<code>--nodeNumber, -u</code>	(Optional) Displays the network interface information for the specified node. By default, the node number is always the first node (Node0).

### Example 13-7 Displaying Network Details

Enter the following command to display the details of network ID 93c07043-3002-494a-8fa0-f3ae932fb4c5:

```
# odacli describe-network -i 93c07043-3002-494a-8fa0-f3ae932fb4c5 -u 1
```

Network details

```
-----
                ID: 93c07043-3002-494a-8fa0-f3ae932fb4c5
                Name: Private-network
                NIC: ibbond0
InterfaceType: BOND
                IP Address: 192.168.16.25
                Subnet Mask: 255.255.255.0
                Gateway:
                VlanId:
                Type: Private
                Default: false
                Created: November 18, 2018 10:54:16 PM PST
```

## odacli create-network

Use the `odacli create-network` command to create a network.

### File Path

```
$ORACLE_HOME/opt/oracle/dcs/bin/odacli
```

### Syntax

```
odacli create-network [-d|-no-d] -n interface -p ipaddress
-w {Public|Dataguard|Database|Management|Backup|Other} -s subnetmask -g
gateway[-h] [-j] VLAN [-p]
```

### Parameters

Parameter	Description
<code>--defaultnetwork, -d</code>	Identifies the default network.
<code>--gateway, -g</code>	Defines the network gateway. The gateway is required for the default network.
<code>--help, -h</code>	(Optional) Displays help for using the command.
<code>--interface, -n</code>	Defines the name of the network interface.
<code>--ipaddress, -p</code>	Defines the network IP address.



Parameter	Description
--json, -j	(Optional) Displays JSON output.
--networktype, -w	Defines the type of network. Options are: {Public Dataguard Database Management Backup Other}. The default is Other.
--no-defaultnetwork, no-d	Identifies a network as not the default network. Use --defaultnetwork -d to identify a default network.
subnetmask, -s	Defines the Network Subnet Mask.
VLAN, -p	Add VLAN as a new network.

### Usage Notes

Network of `public` type can only be defined when deploying the appliance or when running `odacli configure-firstnet` during initial provisioning.

Use this command to create an additional network not done in `create-appliance`.

You are only allowed to create a network on the bond interface.

### Example 13-8 Creating a Network

The following example creates a new network, `sfpbond1`, with IP address `192.0.2.15`. The network is an additional network that uses subnet mask `255.255.255.0` and is not a default network.

```
# odacli create-network -n sfpbond1 -p 192.0.2.15 -w Backup -s
255.255.255.0 -no-d
```

### Example 13-9 Creating a VLAN Network

```
odacli create-network -u 0 -n btbond1 -t VLAN -p 192.0.2.1 -m vlan123
-w Database -s 255.255.255.0 -g 192.0.2.1 -v 123
```

```
odacli create-network -u 1 -n btbond1 -t VLAN -p 192.0.2.1 -m vlan123
-w Database -s 255.255.255.0 -g 192.0.2.1 -v 123
```

## odacli configure-network

Use the `odacli configure-network` command to configure a network.

### File Path

```
/opt/oracle/dcs/bin/odacli
```

### Syntax

To configure a network:

```
odacli configure-network -publicNet [copper|fiber] -changeNetCard [-j] [-h]
```

## Parameters

Parameter	Description
--json, -j	(Optional) Displays JSON output.
-publicNet [copper fibre]	Switches the public network interface from copper to fibre or fibre to copper.
-changeNetCard	Configures the network after replacing a network card.
--help, -h	(Optional) Displays help for using the command.

## Usage Notes

You cannot modify the public and private interfaces after the system is deployed.

The `-publicNet` and `-changeNetCard` options cannot be used together. You can specify either one at a time.

### Example 13-10 Configuring the network after changing a network card

```
# odacli configure-network -changeNetCard
```

### Example 13-11 Changing a Network Interface

```
# odacli configure-network -publicNet copper/fiber
```

## odacli update-network

Use the `odacli update-network` command to update an existing network configuration.

### File Path

```
$ORACLE_HOME/opt/oracle/dcs/bin/odacli
```

### Syntax

To update a network:

```
odacli update-network -i id [-p IP address]
[-w [Public|Dataguard|Backup|Other]] [-s network subnet mask]
[-g network gateway] [-j] [-h]
```

## Parameters

Parameter	Description
--id, -i	Defines the network identity.
--gateway, -g	(Optional) Defines the network gateway.
--ipaddress, -p	(Optional) Defines the network IP address.
--json, -j	(Optional) Displays JSON output.

Parameter	Description
<code>--networktype, -w [Public Dataguard Backup Other]</code>	(Optional) Defines the type of network.
<code>subnetmask, -s</code>	(Optional) Defines the Network Subnet Mask.
<code>--help, -h</code>	(Optional) Displays help for using the command.

### Usage Notes

You cannot modify the Public and Private-interfaces after the system is deployed.

The system has both SFP+ and 10GBaseT bonded pairs, which means that one of them is used for the public, and you can configure the other after deployment if you want additional connectivity. For example, if you want a backup network.

### Example 13-12 Updating a Network

The following example updates network ID 192.0.0.2 and designates the network as a backup network:

```
# odacli update-network -i 192.0.0.2 -w Backup
```

## odacli delete-network

Use the command `odacli delete-network` to delete a network.

### File Path

```
$ORACLE_HOME/opt/oracle/dcs/bin/odacli
```

### Syntax

To delete a network:

```
odacli delete-network -i id [-j] [-h]
```

### Parameters

Parameter	Description
<code>--id, -i</code>	Defines the network identity.
<code>--json, -j</code>	(Optional) Displays JSON output.
<code>--help, -h</code>	(Optional) Displays help for using the command.

### Usage Notes

You cannot delete the Public-network or Private-network after the system is deployed.

**Example 13-13 Deleting a Network**

The following example deletes a backup network with a network ID of 55db39db-d95c-42c5-abbd-b88eb99b83ec.

```
# odacli delete-network -i 55db39db-d95c-42c5-abbd-b88eb99b83ec

"jobId" : "c26d217e-419b-4a91-8680-7b06bcfe9828",
"status" : "Running",
"message" : null,
"reports" : [ {
  "taskId" : "TaskSequential_137",
  "taskName" : "deleting network",
  "taskResult" : "Running",
  "startTime" : "May 18, 2019 23:14:32 PM EDT",
  "endTime" : "May 18, 2019 23:14:32 PM EDT",
  "status" : "Running",
  "taskDescription" : null,
  "parentTaskId" : "TaskSequential_135",
  "jobId" : "c26d217e-419b-4a91-8680-7b06bcfe9828",
  "tags" : [ ],
  "reportLevel" : "Info",
  "updatedAtTime" : "May 18, 2019 23:14:32 PM EDT"
},{
  "taskId" : "TaskZJsonRpcExt_142",
  "taskName" : "Setting up Network",
  "taskResult" : "Network setup success",
  "startTime" : "May 18, 2019 23:14:32 PM EDT",
  "endTime" : "May 18, 2019 23:14:32 PM EDT",
  "status" : "Success",
  "taskDescription" : null,
  "parentTaskId" : "TaskParallel_141",
  "jobId" : "c26d217e-419b-4a91-8680-7b06bcfe9828",
  "tags" : [ ],
  "reportLevel" : "Info",
  "updatedAtTime" : "May 18, 2019 23:14:32 PM EDT" } ],
"createTimestamp" : "May 18, 2019 23:14:32 PM EDT",
"description" : "Network service delete",
"updatedAtTime" : "May 18, 2019 23:14:32 PM EDT"
}
```

## odacli describe-networkinterface

Use the `odacli describe-networkinterface` command to display the details of any network interface.

**File Path**

```
$ORACLE_HOME/opt/oracle/dcs/bin/odacli
```

## Syntax

To display the details of a specific network interface:

```
odacli describe-networkinterface -i id [-j][-h][-u]
```

## Parameters

Parameter	Description
--id, -i	Identifies the network interface ID. Use the <code>odacli list-networks</code> command to obtain the <code>id</code> .
--json, -j	(Optional) Displays JSON output.
--help, -h	(Optional) Displays help for using the command.
--nodeNumber, -u	(Optional) Displays the network interface information for the specified node. By default, the node number is always the first node (Node0).

## Usage Notes

By default, this command always displays the network interface description of the first node (Node0). To display the description of another node, specify the node number option (-u).

### Example 13-14 Displaying Network Details

Enter the following command to display the details of network interface with ID `fe1bf0a7-f56e-44cd-9a84-f374c0aa4b61`:

```
# /opt/oracle/dcs/bin/odacli describe-networkinterface
-i fe1bf0a7-f56e-44cd-9a84-f374c0aa4b61 -u 1
```

Network Interface details

```
-----
                ID: fe1bf0a7-f56e-44cd-9a84-f374c0aa4b61
                Name: eth2
                NIC: eth2
                Type: PHYSICAL
                Members: eth2
Slave Interface: true
                Created: October 16, 2018 1:16:59 PM PDT
```

## odacli list-networkinterfaces

Use the `odacli list-networkinterfaces` command to display network interfaces.

### File Path

```
$ORACLE_HOME/opt/oracle/dcs/bin/odacli
```

## Syntax

```
odacli list-networkinterfaces [-j] [-h] [-u]
```

## Parameters

Parameter	Description
--json, -j	(Optional) Displays JSON output.
--help, -h	(Optional) Displays help for using the command.
--nodeNumber, -u	(Optional) Displays the network interface information for the specified node. By default, the node number is always the first node (Node0).

### Example 13-15 Displaying a List of Network Interfaces

Use the `odacli list-networkinterfaces` command to display a list of network interfaces:

```
# odacli list-networkinterfaces -u 1
ID                                     Name
NIC          Type
-----
d5907a23-1c5d-48c7-8d47-2c188ed43ddd  bond0
bond0          BOND
4f7ea558-9a43-42a9-8e08-6bfd3a33229  bond1
bond1          BOND
743ced8d-bbe5-4987-b316-5fdf95d5e60b  eth0
eth0          PHYSICAL
a4121f9e-e694-4852-a521-44efc6ef3fde  eth1
eth1          PHYSICAL
c62c5f04-aa93-4783-a3a7-275bf9fab2d9  eth2
eth2          PHYSICAL
bda21dad-5c1c-4073-89e5-798b8fce8533  eth3
eth3          PHYSICAL
0141f1ac-5c34-4393-8b99-76094b6f795c  ib0
ib0          PHYSICAL
e8cb138a-087f-4739-bb8d-90b1d903aeb6  ib1
ib1          PHYSICAL
a31cfd63-fb90-4cbb-a2fb-382c5e33983b  ibbond0
ibbond0      BOND
```

## odacli Apply Patch and Update Commands

Use the commands `odacli update` and `apply patch` to apply patches and update the appliance.

- [odacli describe-component](#)  
Use the `odacli describe-component` command to display the installed version and the latest available version for each component.

- [odacli describe-latestpatch](#)  
Use the `odacli describe-latestpatch` command to display a list of the latest supported patch versions for each component.
- [odacli create-prepatchreport](#)  
Use the `odacli create-prepatchreport` command to run pre-checks for patching.
- [odacli describe-prepatchreport](#)  
Use the `odacli describe-prepatchreport` command to display the pre-check report, with a list of pre-checks run with status and comments.
- [odacli list-prepatchreports](#)  
Use the `odacli list-prepatchreports` command to display all pre-check reports, with a list of pre-checks run with status and comments.
- [odacli cleanup-patchrepo](#)  
Use the `odacli cleanup-patchrepo` command to delete obsolete or old patches from the repository.
- [odacli list-availablepatches](#)  
Use the `odacli list-availablepatches` command to display all available patches for Oracle Database Appliance.
- [odacli delete-prepatchreport](#)  
Use the `odacli delete-prepatchreport` command to delete any pre-check report.
- [odacli list-agentconfig-parameters](#)  
Use the `odacli list-agentconfig-parameters` command to list configuration variables used by the appliance.
- [odacli update-agentconfig-parameters](#)  
Use the `odacli update-agentconfig-parameters` command to modify configuration variables used by the appliance.
- [odacli update-dbhome](#)  
Use the `odacli update-dbhome` command to update a specific RDBMS Home to the latest patch bundle version.
- [odacli update-dcsadmin](#)  
Use the `odacli update-dcsadmin` command to update the DCS admin components for Zookeeper upgrade.
- [odacli update-dcscomponents](#)  
Use the `odacli update-dcscomponents` command to update the DCS components such as the DCS agent and Zookeeper.
- [odacli update-dcsagent](#)  
Use the `odacli update-dcsagent` command to update the agent.
- [odacli update-registry](#)  
Use the `odacli update-registry` command to update the registry of components when you apply patches manually.
- [odacli update-repository](#)  
Use the `odacli update-repository` command to update the repository with the new Oracle Database Appliance software.

- [odacli update-server](#)  
Use the `odacli update-server` command to update the operating system, firmware, Oracle Appliance Kit, Oracle Clusterware, and all other infrastructure components.
- [odaadmcli orachk](#)  
Use the `odaadmcli orachk` command to check configuration settings for Oracle Database Appliance components.
- [odacli update-storage](#)  
Use the `odacli update-storage` command to update the storage.

## odacli describe-component

Use the `odacli describe-component` command to display the installed version and the latest available version for each component.

If there are multiple DB Homes installed in Oracle Database Appliance, then the output will display the version details for each of the installed homes. You can use this command to check the component version after applying a patch.

### File Path

```
/opt/oracle/dcs/bin/odacli
```

### Syntax

```
odacli describe-component [-d][-j][-h][-s][-v]
```

### Parameters

Parameter	Description
<code>--dbhomes, -d</code>	(Optional) Lists the database home versions and available versions.
<code>--help, -h</code>	(Optional) Displays help for using the command.
<code>--json, -j</code>	(Optional) Displays JSON output. The default is false.
<code>--local</code>	(Optional) Describes the components for the local node. Use to display details on the local node of multi-node high availability (HA) systems. This option is not needed to display component details on single node systems.
<code>--node, -v</code>	(Optional) Describes the components for a specific node on multi-node high availability (HA) systems. This option is not needed to display component details on single node systems. {0 1}
<code>--server, -s</code>	(Optional) Lists the server components and versions and the available versions to which you can patch them.

### Usage Notes

Use the `odacli describe-component` command to get component details. On a multi-node environment, the command provides details across all nodes. Use the `--node` or `--local` option to get component details for a specific node.



**Example 13-16 Displaying Patch Details for Components for Oracle Database Appliance Release 18.718.5**

```

System Version
-----
18.7.0.0.0

System node Name
-----
node1

Local System Version
-----
18.7.0.0.0

Component                               Installed Version   Available
Version
-----
OAK                                       18.7.0.0.0         up-to-date

GI                                       18.7.0.0.190716   up-to-date

DB {
 [ OraDB11204_home1,OraDB11204_home2 ]  11.2.0.4.190716   up-to-date
 [ OraDB12102_home1,OraDB12102_home2 ]  12.1.0.2.190716   up-to-date
 [ OraDB12201_home1,OraDB12201_home2 ]  12.2.0.1.190716   up-to-date
 [ OraDB18000_home1,OraDB18000_home2 ]  18.7.0.0.190716   up-to-date
}

DCSAGENT                               18.7.0.0.0         up-to-date

ILOM                                     4.0.4.40.r130348   up-to-date

BIOS                                     41060300           up-to-date

OS                                       6.10               up-to-date

FIRMWARECONTROLLER                     13.00.00.00        up-to-date

FIRMWAREEXPANDER                        0306               up-to-date

FIRMWAREDISK {
 [ c0d0,c0d1 ]                          0112               0121
 [ c1d0,c1d1,c1d2,c1d3,c1d4,c1d5,c1d6,  A38K               up-to-date
 c1d7,c1d8,c1d9,c1d10,c1d11,c1d12,c1d13,
 c1d14,c2d0,c2d1,c2d2,c2d3,c2d4,c2d5,
 c2d6,c2d7,c2d8,c2d9,c2d10,c2d11,c2d12,
 c2d13,c2d14 ]
 [ c1d15,c1d16,c1d17,c1d18,c1d19,c1d20,  A122               up-to-date
 c1d21,c1d22,c1d23,c2d15,c2d16,c2d17,
 c2d18,c2d19,c2d20,c2d21,c2d22,c2d23 ]
}

ASR                                       18.3.1             up-to-date

```

```

System node Name
-----
node2

Local System Version
-----
18.7.0.0.0

Component                               Installed Version   Available
Version
-----
OAK                                       18.7.0.0.0         up-to-date

GI                                       18.7.0.0.190716   up-to-date

DB {
 [ OraDB11204_home1,OraDB11204_home2 ] 11.2.0.4.190716   up-to-date
 [ OraDB12102_home1,OraDB12102_home2 ] 12.1.0.2.190716   up-to-date
 [ OraDB12201_home1,OraDB12201_home2 ] 12.2.0.1.190716   up-to-date
 [ OraDB18000_home1,OraDB18000_home2 ] 18.7.0.0.190716   up-to-date
}

DCSAGENT                                18.7.0.0.0         up-to-date

ILOM                                     4.0.4.40.r130348   up-to-date

BIOS                                     41060300           up-to-date

OS                                       6.10               up-to-date

FIRMWARECONTROLLER                     13.00.00.00        up-to-date

FIRMWAREEXPANDER                        0306               up-to-date

FIRMWAREDISK {
 [ c0d0,c0d1 ]                          0112               0121
 [ c1d0,c1d1,c1d2,c1d3,c1d4,c1d5,c1d6,  A38K               up-to-date
 c1d7,c1d8,c1d9,c1d10,c1d11,c1d12,c1d13,
 c1d14,c2d0,c2d1,c2d2,c2d3,c2d4,c2d5,
 c2d6,c2d7,c2d8,c2d9,c2d10,c2d11,c2d12,
 c2d13,c2d14 ]
 [ c1d15,c1d16,c1d17,c1d18,c1d19,c1d20,  A122               up-to-date
 c1d21,c1d22,c1d23,c2d15,c2d16,c2d17,
 c2d18,c2d19,c2d20,c2d21,c2d22,c2d23 ]
}

```

### Example 13-17 List DB Home Details

```
# odacli describe-component -d
```

System Version

-----

18.7.0.0.0

System node Name

-----

node1

Local System Version

-----

18.7.0.0.0

Component  
Version

Installed Version

Available

-----

DB

12.2.0.1.190716

up-to-date

System node Name

-----

node2

Local System Version

-----

18.7.0.0.0

Component  
Version

Installed Version

Available

-----

DB

12.2.0.1.190716

up-to-date

### Example 13-18 List the Server Components and Versions

```
# odacli describe-component -s
```

System Version

-----

18.7.0.0.0

System node Name

-----

node1

Local System Version

-----

18.7.0.0.0

Component  
Version

Installed Version

Available

-----

OAK

18.7.0.0.0

up-to-date

GI

18.7.0.0.190716

up-to-date

```

ILOM                                4.0.4.38.r130206    up-to-date
BIOS                                52010400           up-to-date
OS                                  6.10               up-to-date

System node Name
-----
node2

Local System Version
-----
18.7.0.0.0

Component                               Installed Version   Available
Version
-----
OAK                                     18.7.0.0.0         up-to-date
GI                                      18.7.0.0.190716   up-to-date
ILOM                                    4.0.4.38.r130206   up-to-date
BIOS                                    52010400           up-to-date
OS                                       6.10               up-to-date

```

## odacli describe-latestpatch

Use the `odacli describe-latestpatch` command to display a list of the latest supported patch versions for each component.

### File Path

```
$ORACLE_HOME/opt/oracle/dcs/bin/odacli
```

### Syntax

```
odacli describe-latestpatch [-h]
```

### Parameters

Parameter	Description
<code>--help, -h</code>	(Optional) Displays help for using the command.
<code>--json, -j</code>	(Optional) Displays JSON output. The default is false.

### Example 13-19 Listing the Latest Supported Versions

```
# odacli describe-latestpatch
```

componentType	availableVersion
gi	18.7.0.0.190716
db	18.7.0.0.190716
db	12.2.0.1.190716
db	12.1.0.2.190716
db	11.2.0.4.190716
oak	18.7.0.0.0
asr	18.3.1
ilom	3.0.16.22.f.r100119
ilom	4.0.2.31.r126282
ilom	4.0.4.41.r130359
ilom	4.0.4.37.r130617
ilom	4.0.0.24.r121140
ilom	4.0.4.40.r130348
ilom	4.0.4.38.r130206
os	6.10
bios	17140300
bios	30150300
bios	25080100
bios	41060300
bios	38130200
bios	39090000
bios	52010400
firmwareexpander	0342
firmwareexpander	001e
firmwareexpander	0306
firmwaredisk	a901
firmwaredisk	0r3q
firmwaredisk	a29a
firmwarecontroller	11.05.03.00
firmwarecontroller	qdv1rf30
firmwarecontroller	vdv1ry03
firmwarecontroller	20.08.01.14
firmwarecontroller	2.11.1280
firmwarecontroller	13.00.00.00
firmwarecontroller	4.650.00-7176
firmwarecontroller	kpyair3q
dcsagent	18.7.0.0.0
firmwaredisk	a7e0
firmwaredisk	a4c0
firmwaredisk	a72a
firmwaredisk	a880
firmwaredisk	a122
firmwaredisk	a38k
firmwaredisk	c122
firmwaredisk	944a
firmwaredisk	9440
firmwaredisk	e12b
firmwaredisk	5g08
firmwaredisk	a902
firmwaredisk	a140
firmwaredisk	sa03
firmwaredisk	0b25
firmwaredisk	sf04

```
firmwaredisk    c38k
firmwaredisk    a3a0
firmwaredisk    pd51
firmwaredisk    m554
firmwaredisk    0121
firmwaredisk    xc311102
```

## odacli create-prepatchreport

Use the `odacli create-prepatchreport` command to run pre-checks for patching.

Patching pre-checks help identify and remedy any problems before attempting to patch, and ensure all components are ready for updates.

### File Path

```
$ORACLE_HOME/opt/oracle/dcs/bin/odacli
```

### Syntax

```
odacli create-prepatchreport -v -s
```

### Parameters

Parameter	Description
<code>--dbhome, -d</code>	(Optional) Specifies the database home component for running the pre-checks.
<code>--dbhomeid, -i</code>	(Optional) Specifies the IDs of the database homes for running the pre-checks.
<code>--help, -h</code>	(Optional) Displays help for using the command.
<code>--json, -j</code>	(Optional) Displays JSON output. The default is false.
<code>--local, -l</code>	(Optional) Runs patch pre-checks only on the local node.
<code>--node, -n</code>	(Optional) Runs patch pre-checks on specified nodes.
<code>--server, -s</code>	(Optional) Specify this option to run the patch pre-checks for the server components.
<code>--version, -v</code>	(Optional) Specifies the version for running the pre-checks.

### Usage Notes

Use the `odacli create-prepatchreport` command to generate a pre-check report. Use the `--node` or `--local` option to run the patch pre-checks on specific nodes or the local node.

### Example 13-20 Creating Pre-Check Report

```
# odacli create-prepatchreport -v 18.7 -s
Job details
```

```
-----
ID: e54ff307-84d1-40e4-b604-4b3e47f315de
Description: Run pre-checks for patching
```

```

                Status: Created
                Created: May 18, 2018 6:14:18 AM GMT
                Message:
Task Name      Start Time      End Time      Status
-----
-----

```

## odacli describe-prepatchreport

Use the `odacli describe-prepatchreport` command to display the pre-check report, with a list of pre-checks run with status and comments.

Patching pre-checks help identify and remedy any problems before attempting to patch, and ensure all components are ready for updates.

### File Path

`$ORACLE_HOME/opt/oracle/dcs/bin/odacli`

### Syntax

```
odacli describe-prepatchreport -i
```

### Parameters

Parameter	Description
<code>--help, -h</code>	(Optional) Displays help for using the command.
<code>--json, -j</code>	(Optional) Displays JSON output. The default is false.
<code>--jobid, -i</code>	Specifies the Job ID for the pre-check report.

### Usage Notes

Use the `odacli describe-prepatchreport` command to display the pre-check report.

### Example 13-21 Displaying the Patch Pre-Checks Report

```

# odacli describe-prepatchreport -i 39ef1eeb-70d3-47ad-b3f5-48960ca0607b
Patch pre-check report
-----
                Job ID: 39ef1eeb-70d3-47ad-b3f5-48960ca0607b
                Description: Pre-Check report for patching [GI, ILOM, OS]
                Status: COMPLETED
                Result: One or more pre-checks failed for [GI]
Node Name
-----
node n1
Pre-Check      Status
Comments
-----
-----
__OS__

```

Validate patching tag 12.2.1.2.0	Success	Validated patching tag:
Is patch location available available	Success	Patch location is
Verify OS patch available	Success	There are no packages for an
update __ILOM__		
Validate patching tag 12.2.1.2.0	Success	Validated patching tag:
Is patch location available available	Success	Patch location is
Checking Ilom patch Version versions	Success	Successfully verified the
Patch location validation location	Success	Successfully validated
__GI__		
Is clusterware running running	Success	Clusterware is
Validate patching tag 12.2.1.2.0	Success	Validated patching tag:
Validate available space u01	Success	Validated free space under /
Is system provisioned provisioned	Success	Verified system is
Validate minimum agent version current	Success	GI patching enabled in DCSAGENT
version		
Validate GI patch metadata encountered:	Failed	Internal error patchmetadata for missing target version for
12.2.1.2.0		
GI.		
Is patch location available available	Success	Patch location is
Patch location validation encountered:	Failed	Internal error specified
location		
Patch verification Unable	Failed	Internal error encountered: to get patch number on n1.
node		
Opatch updation opatch in	Success	Successfully updated the GiHome /u01/app/12.2.0.1/grid
on		
Patch conflict check encountered:	Failed	node n1 Internal error



Invalid patch location in  
metadata.

### Example 13-22 Example of a Successful Patch Pre-Checks Report

```
# odacli describe-prepatchreport -i aec9373c-96aa-43ce-9aae-8091ec9cd4eb
Patch pre-check report
```

```
-----
Job ID: aec9373c-96aa-43ce-9aae-8091ec9cd4eb
Description: Pre-Check report for patching [DB]
Status: COMPLETED
Result: All pre-checks succeeded
Node Name
-----
node1
Pre-Check          Status
Comments
-----
  _DB_
Validate patching tag          Success  Validated patching tag:
12.2.1.2.0
Validate available space      Success  Validated free space
required
                                         under /
u01
Is system provisioned          Success  Verified system is
provisioned
Is patch location available    Success  Patch location is
available
Validate minimum agent version Success  Validated minimum agent
version
Verify DBHome patch tag        Success  Verified DB Home patch
tag
Is GI upgraded                  Success  Validated GI is
upgraded
Patch location validation      Success  Successfully validated
location
Patch verification             Success  Patch 26710464 not applied on
DB
home
Is patch rollback required     Success  No DB patch is required to
rollback
Opatch updation                Success  Successfully updated the
opatch in
DbHome
Patch conflict check           Success  No patch conflicts found on
DBHome
```

## odacli list-prepatchreports

Use the `odacli list-prepatchreports` command to display all pre-check reports, with a list of pre-checks run with status and comments.

Patching pre-checks help identify and remedy any problems before attempting to patch, and ensure all components are ready for updates.

### File Path

```
/opt/oracle/dcs/bin/odacli
```

### Syntax

```
odacli list-prepatchreports [-h] [-j]
```

### Parameters

Parameter	Description
<code>--help, -h</code>	(Optional) Displays help for using the command.
<code>--json, -j</code>	(Optional) Displays JSON output. The default is false.

### Usage Notes

Use the `odacli list-prepatchreports` command to display all pre-check reports.

### Example 13-23 Displaying All Patch Pre-Checks Reports

```
# odacli list-prepatchreports
ID      Description      Created              Status
-----
8a8a14b5-1b5e-4eeb-8ba9-c8136fb4eea1    Patch pre-checks for [DB]: DbHome
is OraDB12102_home1
May 16, 2018 7:00:56 PM PDT              Running
2c9a747d-a452-4e48-bcab-9c7cd9f5f35b    Patch pre-checks for
[STORAGE]
May 16, 2018 6:53:23 PM PDT              Success
f3b9c7c1-3061-4577-848d-645669d71f72    Patch pre-checks for [OS, ILOM,
GI]
May 16, 2018 7:00:56 PM PDT              Running
```

## odacli cleanup-patchrepo

Use the `odacli cleanup-patchrepo` command to delete obsolete or old patches from the repository.

### File Path

```
$ORACLE_HOME/opt/oracle/dcs/bin/odacli
```

### Syntax

```
odacli cleanup-patchrepo [-cl clones] | [-v version [-comp component]] [-l local|-n NodeID]
```

### Parameters

Parameter	Description
<code>--clones, -cl</code>	Specifies the option to clean up clone files (DB and GI) from the repository <code>/opt/oracle/oak/pkgrepos/orapks/clones/</code> .
<code>--version, -v</code>	Defines the Oracle Database Appliance release you want to delete. For example, 12.2.1.4.0.
<code>--component, -comp</code>	A comma-separated list of components as <code>{DB,GI}</code> to cleanup for a specific Oracle Database Appliance patch version. The default is both <code>{DB,GI}</code> .
<code>--local, -l</code>	(Optional) Cleans up the repository on the local node.
<code>--node, -n</code>	(Optional) Cleans up the repository on the specified nodes.
<code>--help, -h</code>	(Optional) Displays help for using the command.
<code>--json, -j</code>	(Optional) Displays JSON output.

### Usage Notes

- Use the command to free up space in the patch repository.
- This command does not delete the current patches or latest installed patch repository.

### Example 13-24 Deleting RDBMS and GI components for a specific release

```
# odacli cleanup-patchrepo -cl -comp db,gi -v 12.2.1.4.0
{
  "jobId" : "d915ffc0-c7f6-49cf-8ddd-ab5d2ad9072f",
  "status" : "Created",
  "message" : null,
  "reports" : ,
  "createTimestamp" : "April 17, 2019 06:44:28 AM UTC",
  "resourceList" : ,
  "description" : "Cleanup patchrepos",
  "updatedAtTime" : "April 17, 2019 06:44:28 AM UTC"
```

### Example 13-25 Deleting Clone Files

```
# odacli cleanup-patchrepo -cl
{
  "jobId" : "5d8549a2-1a5e-4b4f-9867-clf671c659c4",
  "status" : "Created",
  "message" : null,
  "reports" : ,
  "createTimestamp" : "April 17, 2019 06:43:45 AM UTC",
  "resourceList" : ,
  "description" : "Cleanup patchrepos",
  "updatedAtTime" : "April 17, 2019 06:43:45 AM UTC"
}
```

## odacli list-availablepatches

Use the `odacli list-availablepatches` command to display all available patches for Oracle Database Appliance.

### File Path

`$ORACLE_HOME/opt/oracle/dcs/bin/odacli`

### Syntax

`odacli list-availablepatches [-h] [-j]`

### Parameters

Parameter	Description
<code>--help, -h</code>	(Optional) Displays help for using the command.
<code>--json, -j</code>	(Optional) Displays JSON output. The default is false.

### Usage Notes

Use the `odacli list-availablepatches` command to display all available patches for Oracle Database Appliance.

### Example 13-26 Displaying All Patch Pre-Checks Reports

```
# odacli list-availablepatches
latest Patch Version
-----
18.3.0.0.0

Available Patches   Db Version
-----
18.3.0.0.0          12.2.0.1.180717, 12.1.0.2.180717, 11.2.0.4.180717
```

## odacli delete-prepatchreport

Use the `odacli delete-prepatchreport` command to delete any pre-check report.

### File Path

`/opt/oracle/dcs/bin/odacli`

### Syntax

```
odacli delete-prepatchreport -i Report ID
```

### Parameters

Parameter	Description
<i>Report ID</i>	Describes the ID of the report to be deleted.
<code>--help, -h</code>	(Optional) Displays help for using the command.

### Usage Notes

Use the `odacli delete-prepatchreport` command to delete pre-check reports.

### Example 13-27 Deleting A Patch Pre-Checks Report

```
# odacli delete-prepatchreport -i 741f635b-7c75-4832-8813-782367f1e6fd
```

## odacli list-agentconfig-parameters

Use the `odacli list-agentconfig-parameters` command to list configuration variables used by the appliance.

### File Path

``${ORACLE_HOME}/opt/oracle/dcs/bin/odacli`

### Syntax

```
odacli list-agentconfig-parameters [-h] [-j] [-n]
```

### Parameters

Parameter	Description
<code>--help, -h</code>	(Optional) Displays help for using the command.
<code>--json, -j</code>	(Optional) Displays JSON output. The default is false.

Parameter	Description
--name, -n	Specifies the name of the parameter.

### Usage Notes

Use the `odacli list-agentconfig-parameters` command to list configuration variables used by the appliance.

### Example 13-28 Example Command

```
./odacli list-agentconfig-parameters -n HttpProxyPort
```

```

Name          Value          Description      Updated
-----
HttpProxyPort Http proxy server port   June 24, 2018 4:14:10 AM
UTC
./odacli list-agentconfig-parameters
Name          Value          Description      Updated
-----
HttpProxyHost  Http proxy server host   June 24, 2018 4:14:10 AM UTC
HttpProxyPort  Http proxy server port   June 24, 2018 4:14:10 AM
UTC
HttpsProxyHost  Https proxy server host   June 24, 2018 4:14:10 AM
UTC
HttpsProxyPort  Https proxy server port   June 24, 2018 4:14:10 AM
UTC
OSPatchRepos  Repo list for OS patching June 24, 2018 4:14:10 AM UTC

```

### Related Topics

- [Configuring Agent Proxy Settings for Object Store Access](#)  
If the Object Store IP address is accessible only through proxy setup by the Oracle Database Appliance server, then define the proxy setting for the agent, so that the agent can access the Object Store.

## odacli update-agentconfig-parameters

Use the `odacli update-agentconfig-parameters` command to modify configuration variables used by the appliance.

### File Path

`$ORACLE_HOME/opt/oracle/dcs/bin/odacli`

### Syntax

```
odacli update-agentconfig-parameters
```

### Parameters

Parameter	Description
<code>--help, -h</code>	(Optional) Displays help for using the command.
<code>--append, -a</code>	(Optional) Appends the parameter values. For example, <code>-n p1 -v v1 -n p2 -v v2 -a</code> . The default is false.
<code>--comment, -c</code>	(Optional) Specifies the comment for the parameter.
<code>--description, -d</code>	(Optional) Specifies the description of the parameter.
<code>--json, -j</code>	(Optional) Displays JSON output. The default is false.
<code>--name, -n</code>	Specifies the name of the parameter. Provide multiple parameter values in the format <code>-n p1 -v v1 -n p2 -v v2</code> .
<code>--reset, -r</code>	Resets the parameter to the default value. For example: <code>-n p1 -n p2 -r</code> . The default is false.
<code>--update, -u</code>	Replaces the parameter with the specified value. For example: <code>-n p1 -v v1 -n p2 -v v2 -u</code> . The default is false.
<code>--value, -v</code>	Specifies the value of the parameter. Provide multiple parameter values in the format <code>-n p1 -v v1 -n p2 -v v2</code> .

### Usage Notes

Use the `odacli update-agentconfig-parameters` command to modify configuration variables used by the appliance. The supported configuration parameters are `HttpsProxyHost`, `HttpsProxyPort`, and `OSPatchRepos`.

Multiple values can be specified. For High-Availability models, the command sets the parameter values on both nodes in the cluster.

**Example 13-29 Setting Multiple Parameters**

```
# odacli update-agentconfig-parameters -n HttpsProxyPort -v 80 -d "Http
proxy port"
-n HttpsProxyPort -v 80 -d "Https proxy port" -u

update-agentconfig-parameters -n HttpsProxyPort -n HttpProxyPort -r

update-agentconfig-parameters -n HttpsProxyHost -v 90 -a

update-agentconfig-parameters -n OSPatchRepos -v
```

**Related Topics**

- [Configuring Agent Proxy Settings for Object Store Access](#)  
If the Object Store IP address is accessible only through proxy setup by the Oracle Database Appliance server, then define the proxy setting for the agent, so that the agent can access the Object Store.

## odacli update-dbhome

Use the `odacli update-dbhome` command to update a specific RDBMS Home to the latest patch bundle version.

**File Path**

```
/opt/oracle/dcs/bin/odacli
```

**Syntax**

```
odacli update-dbhome -i dbhomeid -v version [-j] [-h] [-v]
```

**Parameters**

Parameter	Description
<code>--dbhomeid, -i</code>	Defines the Oracle Database Home to update.
<code>--help-h</code>	(Optional) Displays help for using the command.
<code>--json, -j</code>	(Optional) Displays JSON output. The default is false.
<code>--precheck, -p</code>	Analyzes the patch.
<code>--version, -v</code>	Defines the Oracle Database Appliance version to update. For example, 12.2.1.1.

**Usage Notes**

- The `update-dbhome` command applies the latest release update (RU) for Oracle Database home.
- To be updated with the latest patches, the database must be running.



- Only databases in the `Configured` status are updated. Use the `odacli list-database` command to see a list of configured databases. Databases in any other status are skipped during the update.

### Example 13-30 Updating an Oracle Database Home

To apply the latest patch bundle to update an Oracle Database:

```
# odacli update-dbhome -i ad6c7326-e460-411e-94df-230dedbef743 -v
18.7.0.0.0
```

## odacli update-dcsadmin

Use the `odacli update-dcsadmin` command to update the DCS admin components for Zookeeper upgrade.

### File Path

```
$ORACLE_HOME/opt/oracle/dcs/bin/odacli
```

### Syntax

```
odacli update-dcsadmin -v version [-j] [-h]
```

### Parameters

Parameter	Description
<code>--version, -v</code>	Defines the Oracle Database Appliance version after update.
<code>--help, -h</code>	(Optional) Displays help for using the command.
<code>--json, -j</code>	(Optional) Displays JSON output.

### Usage Notes

The `update-dcsadmin` command sets up the `dcsadmin` and other components. Run the `update-dcsadmin` command only after you update the DCS agent.

### Example 13-31 Updating DCS Admin

```
# odacli update-dcsadmin -v 18.7.0.0.0
{
  "jobId" : "4c238b93-e641-4f9d-9f86-93d0574dd234",
  "status" : "Created",
  "message" : null,
  "reports" : [ ],
  "createTimestamp" : "July 12, 2019 03:11:53 AM UTC",
  "resourceList" : [ ],
  "description" : "DcsAdmin patching",
  "updatedAt" : "July 12, 2019 03:11:53 AM UTC"
}
```

## odacli update-dcscomponents

Use the `odacli update-dcscomponents` command to update the DCS components such as the DCS agent and Zookeeper.

### File Path

```
$ORACLE_HOME/opt/oracle/dcs/bin/odacli
```

### Syntax

```
odacli update-dcscomponents -v version [-j] [-h]
```

### Parameters

Parameter	Description
<code>--version, -v</code>	Defines the Oracle Database Appliance version after update.
<code>--help, -h</code>	(Optional) Displays help for using the command.
<code>--json, -j</code>	(Optional) Displays JSON output.

### Usage Notes

The `update-dcscomponents` command sets up the `dcscomponents` such as Zookeeper.

### Example 13-32 Updating DCS Components

```
# odacli update-dcscomponents -v 18.7.0.0.0
{
  "jobId" : "4c238b93-e641-4f9d-9f86-93d0574dd234",
  "status" : "Created",
  "message" : null,
  "reports" : [ ],
  "createTimestamp" : "July 12, 2019 03:11:53 AM UTC",
  "resourceList" : [ ],
  "description" : "DcsComponents patching",
  "updatedAt" : "July 12, 2019 03:11:53 AM UTC"
}
```

## odacli update-dcsagent

Use the `odacli update-dcsagent` command to update the agent.

### File Path

```
$ORACLE_HOME/opt/oracle/dcs/bin/odacli
```

## Syntax

```
odacli update-dcsagent -v version [-j] [-h]
```

## Parameters

Parameter	Description
--version, -v	Defines the Oracle Database Appliance version after update.
--help, -h	(Optional) Displays help for using the command.
--json, -j	(Optional) Displays JSON output.

## Usage Notes

The `update dcsagent` command updates the `dcs-agent` to the RPM package that is located in the *location* and restarts the `dcs-agent`. After the update is applied, the agent automatically restarts. It will take a few minutes to reconnect to the `dcs-agent`. Wait until the agent shuts down and completes restarting before performing any tasks.



### Note:

Before updating the agent, ensure that you do not have any jobs running or pending during the update window.

## Example 13-33 Updating the Agent

To update the `dcs-agent` to version 18.7:

```
# odacli update-dcsagent -v 18.7
{
  "jobId" : "77e454d3-eb68-4130-a247-7633f8d6192b",
  "status" : "Created",
  "message" : null,
  "reports" : [ ],
  "createTimestamp" : "May 18, 2019 14:09:24 PM CST",
  "description" : "DcsAgent patching",
  "updatedAtTime" : "May 18, 2019 14:09:24 PM CST"
}
```

## odacli update-registry

Use the `odacli update-registry` command to update the registry of components when you apply patches manually.

### File Path

```
$ORACLE_HOME/opt/oracle/dcs/bin/odacli
```

## Syntax

```
odacli update-registry -n component [-f] [-j] [-h]
```

## Parameters

Parameter	Description
--component, -n	Defines the Oracle Database Appliance component for the registry update. The values can be <code>system {gihome, dbnode, sysinstance}</code> or <code>all {dbhome, db, dbstorage, asr}</code> . You can also specify the individual component to be refreshed. <b>Note:</b> Refresh system components before you refresh all components.
-f	(Optional) Forces the refresh of the specified component even if it already exists in the appliance registry metadata.
--help, -h	(Optional) Displays help for using the command.
--json, -j	(Optional) Displays JSON output.

## Usage Notes

The `update-registry` command updates the registry of components when you apply patches manually..

### Example 13-34 Updating the Registry with the -force option

```
# odacli update-registry -n system
DCS-10112:Specified components are already discovered.
```

Using force flag option to rediscover and update the sytem components though it already exists in appliance registry

```
# odacli update-registry -n system -f
```

Job details

```
-----
                ID: 752b56d8-2bcd-4a29-ab96-196925fc5c13
        Description: Discover System Components : system
           Status: Created
          Created: July 31, 2019 1:02:51 PM UTC
          Message:
```

```
Task Name Start Time End Time Status
-----
```

```
-----
-----
```

```
# odacli describe-job -i 752b56d8-2bcd-4a29-ab96-196925fc5c13
```

Job details

```
-----
                ID: 752b56d8-2bcd-4a29-ab96-196925fc5c13
```

```
Description: Discover System Components : system
Status: Success
Created: July 31, 2019 1:02:51 PM UTC
Message:
```

```
Task Name Start Time End Time Status
-----
-----
Rediscover SysInstance July 31, 2019 1:02:51 PM UTC July 31, 2019 1:03:24
PM UTC Success
Rediscover DBNode July 31, 2019 1:03:24 PM UTC July 31, 2019 1:03:24 PM
UTC Success
Rediscover GiHome July 31, 2019 1:03:24 PM UTC July 31, 2019 1:03:26 PM
UTC Success
```

## odacli update-repository

Use the `odacli update-repository` command to update the repository with the new Oracle Database Appliance software.

### Prerequisites

Before updating the repository, you must upload the Oracle Database Appliance software to the appliance. If the patch contains more than one zip file, then extract and concatenate the zip files before updating the repository.

### File Path

```
/opt/oracle/dcs/bin/odacli
```

### Syntax

To unpack and copy the patch bundle to the correct locations in the file system:

```
odacli update-repository -f filename [-j] [-h]
```

### Parameters

Parameter	Description
<code>--filename, -f</code>	Defines the zip filename of patch bundle or RDBMS clones downloaded from My Oracle Support. Provide a comma-separated list of absolute file paths of the end user and patch bundles.
<code>--json, -j</code>	(Optional) Displays JSON output. The default is false.
<code>--help, -h</code>	(Optional) Displays help for using the command.

### Usage Notes

- Before updating the repository, ensure that you do not have any jobs running or pending during the update window.
- Upload the patches to `dom0` on Node0. On multi-node systems, the DCS-Agent copies the patch to Node1 and updates the patch repository on both nodes.

### Example 13-35 Updating the Repository

The server patch zip file is located in the `/u01/tmpdir` directory. The following example updates the repository with the latest server patch and then lists the job to verify that the update is successful:

```
# /opt/oracle/dcs/bin/odacli update-repository -f /tmp/oda-
sm-18.7.0.0.0-190911-server1of2.zip,/tmp/oda-sm-18.7.0.0.0-190911-
server2of2.zip
{
  "jobId" : "d3510276-da05-447b-990e-6d30964f8f79",
  "status" : "Created",
  "message" : "/u01/tmpdir/oda-sm-12.2.1.1.0-171031-server.zip",
  "reports" : [ ],
  "createTimestamp" : "May 18, 2019 14:13:45 AM CST",
  "description" : "Repository Update",
  "updatedAtTime" : "May 18, 2019 14:13:45 AM CST"
}
[root@oak1 tmpdir]# ./odacli list-jobs
# odacli list-jobs
ID                               Description
Created                           Status
-----
6f27a29a-959f-44e1-b984-7473e3c918ad  Server Patching   May 18, 2019
14:19:05 AM CST   Success
```

## odacli update-server

Use the `odacli update-server` command to update the operating system, firmware, Oracle Appliance Kit, Oracle Clusterware, and all other infrastructure components.

### File Path

```
/opt/oracle/dcs/bin/odacli
```

### Syntax

```
odacli update-server -v version [-j] [-h]
```

### Parameters

Parameter	Description
<code>--precheck, -p</code>	Analyzes the patch.

Parameter	Description
--version, -v	Defines the version to update.
--local, -l	Updates the server on the local node of multi-node high availability (HA) systems. This option is not needed for single-node systems.
--json, -j	(Optional) Displays JSON output. The default is false.
--help, -h	(Optional) Displays help for using the command.

### Usage Notes

The `update-server` command applies the patches to various infrastructure components and Oracle Clusterware.

After the update is applied, the agent automatically restarts. It will take a few minutes to reconnect to the server. Wait until the agent shuts down and completes restarting before performing any tasks. Allow at least two (2) minutes before running the next command.

#### Note:

Before updating the server, ensure that you do not have any jobs running or pending during the update window.

### Example 13-36 Updating the Server

Run the `odacli update-server` command to update the server to 18.7.0.0.0. On a multi-node HA system, you must run the command on both nodes to update the server version.

```
# odacli update-server -v 18.7.0.0.0
{
  "jobId" : "6f27a29a-959f-44e1-b984-7473e3c918ad",
  "status" : "Created",
  "message" : "Success of Server Update may trigger reboot of node after
4-5 minutes.
Please wait till node restart",
  "reports" : [ ],
  "createTimestamp" : "May 18, 2019 14:13:45 PM CST",
  "resourceList" : [ ],
  "description" : "Server Patching",
  "updatedAt" : "May 18, 2019 14:13:45 PM CST"
}
```

## odaadmcli orachk

Use the `odaadmcli orachk` command to check configuration settings for Oracle Database Appliance components.

### File Path

```
/opt/oracle/dcs/bin/odaadmcli
```

### Syntax

To perform diagnostic checks of components:

```
odaadmcli orachk [-h]
```

### Parameters

Parameter	Description
<code>--help, -h</code>	(Optional) Displays help for using the command.
Components such as <code>-a</code> , <code>-acchk</code> , <code>-applypatch</code> , <code>-autostop</code>	(Optional) Specifies the comma-separated list of components for which you want to collect data. Specify the component to be checked in the command. For example: <pre># odaadmcli orachk -a</pre>
<code>--verbose</code>	Displays detailed message.

### Usage Notes

The `odaadmcli orachk` command invokes `orachk` from the directory `opt/oracle.SupportTools/orachk`.

#### Example 13-37 Running `odaadmcli orachk`

```
[root@oak bin] # ./odaadmcli orachk
INFO: 2019-09-04 16:41:26: Running orachk under /opt/oracle.SupportTools/orachk
```

#### Example 13-38 Running `odaadmcli orachk` for a component

```
[root@oak bin] # ./odaadmcli orachk -a
INFO: 2019-09-19 10:45:16: Running orachk under /usr/bin/orachk
Checking ssh user equivalency settings on all nodes in cluster for root
```

## odacli update-storage

Use the `odacli update-storage` command to update the storage.

### File Path

```
/opt/oracle/dcs/bin/odacli
```



## Syntax

```
odacli update-storage -v version [-h] [-j] [-r]
```

## Parameters

Parameter	Description
--version, -v	Defines the version to update.
--json, -j	(Optional) Displays JSON output. The default is false.
--help, -h	(Optional) Displays help for using the command.
--rolling, -r	(Optional) Enables to patch shared disks in rolling fashion without stopping Oracle Clusterware. The shared disks must be online.

## Usage Notes

### Example 13-39 Updating the Storage

```
# odacli update-storage -v 18.7.0.0.0
```

# odacli Appliance Commands

Use the `odacli appliance` commands to perform lifecycle activities for the appliance.

- [odacli create-appliance](#)  
Use the `odacli create-appliance` command in a JSON file format to provision Oracle Database Appliance.
- [odacli describe-appliance](#)  
Use the `odacli describe-appliance` command to display appliance details.
- [odacli describe-system](#)  
Use the `odacli describe-system` command to display details about components installed on the system.
- [odacli list-featuretracking](#)  
Use the `odacli list-featuretracking` command to display the latest feature tracking report.
- [odacli-adm set-credential](#)  
Use the `odacli-adm set-credential` command to change the `oda-admin` user credentials.

## odacli create-appliance

Use the `odacli create-appliance` command in a JSON file format to provision Oracle Database Appliance.

### File Path

```
$ORACLE_HOME/opt/oracle/dcs/bin/odacli
```

### Syntax

To view help for the `odacli create-appliance` command:

```
odacli create-appliance -r requestjson [-j] [-h]
```

#### Note:

The `odacli create-appliance` command only supports a JavaScript Object Notation (JSON) file format. An example JSON files and a readme are available in an appendix in this document and in the `/opt/oracle/dcs/sample` directory.

### Parameters

Parameter	Description
<code>--requestjson, -r</code>	JSON input for appliance creation.
<code>--json, -j</code>	(Optional) Displays JSON output.
<code>--help, -h</code>	(Optional) Displays help for using the command.

## odacli describe-appliance

Use the `odacli describe-appliance` command to display appliance details.

### File Path

```
$ORACLE_HOME/opt/oracle/dcs/bin/odacli
```

### Syntax

```
odacli describe-appliance [-d|-b][-j][-h]
```

### Parameters

Parameter	Description
<code>--details, -d</code>	(Optional) Displays the agent CLI build details.
<code>--help, -h</code>	(Optional) Displays help for using the command.

Parameter	Description
--json, -j	(Optional) Displays JSON output.
--bom, -b	(Optional) Displays BOM information.

### Example 13-40 Displaying Appliance Details

```
# odacli describe-appliance -d

Appliance Information
-----
ID: 78e9a6b8-c4f8-42b2-9e72-7d23c2636544
Platform: OdaliteL
Data Disk Count: 6
CPU Core Count: 20
Created: May 18, 2019 5:14:41 AM EST

System Information
-----

Name: rwsoda6f002
Domain Name: example.com
Time Zone: America/New_York
DB Edition: EE
DNS Servers: 10.204.32.1
NTP Servers: 10.68.0.41 10.68.0.42

Disk Group Information
-----
DG Name      Redundancy    Percentage
-----
Data         High          80
Reco         High          20
```

## odacli describe-system

Use the `odacli describe-system` command to display details about components installed on the system.

### File Path

```
$ORACLE_HOME/opt/oracle/dcs/bin/odacli
```

### Syntax

To list jobs and view job details and status:

```
odacli describe-system [-h] [-b] [-d] [-j]
```

## Parameters

Parameter	Description
--json, -j	(Optional) Displays JSON output.
--help, -h	(Optional) Displays help for using the command.
--bom, -b	(Optional) Displays the bill of materials for the installed components on the appliance.
--details, -d	(Optional) Display on the command-line, the details of all installed components on the appliance.

## Usage Notes

Do not provide both options `-b` and `-d` at the same time, in the command.

### Example 13-41 Example Command to View the Bill of Materials from the Command Line for Bare Metal Deployments

```
# odacli describe-system -b
ODA Components Information
-----
Component Name          Component
Details
-----
-----
NODE                      Name : rwsoda6m003
                          Domain Name :
                          Time Stamp : July 29, 2018 7:00:12 PM UTC

RPMS                      Installed RPMS : acl-2.2.49-7.el6_9.1.x86_64,
                          aide-0.14-11.el6.x86_64,
                          alsa-lib-1.1.0-4.el6.x86_64,
                          at-3.1.10-49.el6.x86_64,
                          atk-1.30.0-1.el6.x86_64,
                          attr-2.4.44-7.el6.x86_64,
                          audit-2.4.5-6.el6.x86_64,
                          audit-
                          libs-2.4.5-6.el6.x86_64,
                          audit-libs-
                          python-2.4.5-6.el6.x86_64,
                          augeas-
                          libs-1.0.0-10.el6.x86_64,
                          authconfig-6.1.12-23.el6.x86_64,
                          avahi-
                          libs-0.6.25-17.el6.x86_64,
                          b43-
                          openfwf-5.2-10.el6.noarch,
                          basesystem-10.0-4.0.1.el6.noarch,
```

```
bash-4.1.2-48.el6.x86_64,  
bc-1.06.95-1.el6.x86_64,  
bind-  
bind-  
libs-9.8.2-0.62.rc1.el6_9.5.x86_64,  
utils-9.8.2-0.62.rc1.el6_9.5.x86_64,  
binutils-2.20.51.0.2-5.47.el6_9.1.x86_64,  
biosdevname-0.7.2-1.el6.x86_64,  
utils-1.2-10.el6.x86_64,  
bridge-  
busybox-1.15.1-21.el6_6.x86_64,  
bzip2-1.0.5-7.el6_0.x86_64,  
bzip2-  
libs-1.0.5-7.el6_0.x86_64,  
ca-  
certificates-2017.2.14-65.0.1.el6_9.noarch,  
cairo-1.8.8-6.el6_6.x86_64,  
celt051-0.5.1.3-0.el6.x86_64,  
checkpolicy-2.0.22-1.el6.x86_64,  
chkconfig-1.3.49.5-1.el6.x86_64,  
clog-  
ppl-0.15.7-1.2.el6.x86_64,  
compat-  
libcap1-1.10-1.x86_64,  
compat-libstdc+  
+-33-3.2.3-69.el6.x86_64,  
compat-  
readline5-5.2-17.1.el6.x86_64,  
compat-sap-c+  
+-4.8.2-16.el6.x86_64,  
ConsoleKit-0.4.1-6.el6.x86_64,  
ConsoleKit-  
libs-0.4.1-6.el6.x86_64,  
ConsoleKit-  
x11-0.4.1-6.el6.x86_64,  
coreutils-8.4-46.0.1.el6.x86_64,  
coreutils-  
libs-8.4-46.0.1.el6.x86_64,  
cpupowerutils-1.3-2.el6.x86_64,  
cpuspeed-1.5-22.0.1.el6.x86_64,  
cpio-2.10-13.el6.x86_64,  
cpp-4.4.7-18.el6.x86_64,  
cracklib-2.8.16-4.el6.x86_64,  
cracklib-
```

```

dicts-2.8.16-4.el6.x86_64,
crash-7.1.4-1.0.1.el6_7.x86_64,
crda-3.13_2015.10.22-3.el6.x86_64,
createrepo-0.9.9-27.el6_9.noarch,
cronie-1.4.4-16.el6_8.2.x86_64,
anacron-1.4.4-16.el6_8.2.x86_64,
luks-1.2.0-11.el6.x86_64,
libs-1.2.0-11.el6.x86_64,
libs-1.4.2-78.el6_9.x86_64,
....
....
....
cronie-
crontabs-1.10-33.el6.noarch,
cryptsetup-
cryptsetup-luks-
cups-

```

## odacli list-featuretracking

Use the `odacli list-featuretracking` command to display the latest feature tracking report.

### File Path

```
$ORACLE_HOME/opt/oracle/dcs/bin/odacli
```

### Syntax

Use the `odacli list-featuretracking` command to display the latest feature tracking report.

```
odacli list-featuretracking [-h] [-j]
```

### Parameters

Parameter	Description
<code>--json, -j</code>	(Optional) Displays JSON output.
<code>--help, -h</code>	(Optional) Displays help for using the command.

### Example 13-42 Example Command to View the Features Report from the Command Line

```
# odacli list-featuretracking
DCS Feature Tracking Report
```

Last collection date: 10/26/18 15:35  
Report version: 1.0

-----  
DCS Feature Usage Summary

Detected Feature Name Usages	Total Samples	Last Usage Time	Currently Used
-----			
Object Store			TRUE
12	12	10/26/18 15:35	
Automatic Service Request (ASR)			FALSE
0	12		
Storage Expansion Shelf			FALSE
0	12		

-----  
DCS High Water Mark Statistics

Measured Feature Name Mark	Category	High Water
-----		
Maximum usage of CPU		8.12
%	DCS Agent	
Maximum usage of Memory		437.12
MB	DCS Agent	
Maximum number of threads		
150	DCS Agent	
Maximum number of open file descriptors		
257	DCS Agent	
Maximum number of Databases		
1	Database	
Maximum number of EE Databases		
1	Database	
Maximum number of SE Databases		
0	Database	
Maximum number of CDBs		
1	Database	
Maximum number of non-CDBs		
0	Database	
Maximum number of RAC Databases		
1	Database	
Maximum number of RAC One Databases		
0	Database	
Maximum number of Single Instance Databases		
0	Database	
Maximum number of PDBs		
0	Database	
Maximum number of Datafiles		
7	Database	
Maximum number of Database Homes		

1	Database	
Maximum number of Flashback Databases		
0	Database	
Maximum size of a Database		6.40
GB	Database	
Minimum Database version		
18.0.0.0.0	Database	
Maximum Database version		
18.0.0.0.0	Database	
Maximum number of Backups		
12	Database	
Maximum number of NFS Backups		
0	Database	
Maximum number of Object Store Backups		
12	Database	
Maximum number of Disk Backups		
0	Database	
Maximum number of Regular-L0 Backups		
0	Database	
Maximum number of Regular-L1 Backups		
1	Database	
Maximum number of ArchiveLog Backups		
9	Database	
Maximum number of Longterm Backups		
2	Database	
Maximum interval between Database Backups		0 Day(s),
01:01:06	Database	
Maximum number of Object Store tenants		
1	Object Store	
Maximum number of enabled CPU cores		
12	Server	
Maximum number of disks		
24	Storage	
Maximum number of ASM Disks Groups		
3	Storage	
Maximum size of ASM Disk Groups		11.46
TB	Storage	
Maximum usage of ASM Disk Groups		1.70
%	Storage	
Maximum number of ASM Disks Groups with redundancy 'NORMAL'		
0	Storage	
Maximum number of ASM Disks Groups with redundancy 'HIGH'		
3	Storage	
Maximum number of ASM Disks Groups with redundancy 'EXTERN'		
0	Storage	
Maximum number of ASM Disks Groups with redundancy 'FLEX'		
0	Storage	
Maximum ASM Disk Groups compatibility		
18.0.0.0.0	Storage	
Minimum ASM Disk Groups compatibility		
18.0.0.0.0	Storage	
Maximum number of non-ACFS file systems		
4	Storage	
Maximum size of non-ACFS file systems		98.31
GB	Storage	



Maximum usage of non-ACFS file systems	82.71
% Storage	
Maximum number of ACFS file systems	
1 Storage	
Maximum size of ACFS file systems	5.00
GB Storage	
Maximum usage of ACFS file systems	12.19
% Storage	

## odacli-adm set-credential

Use the `odacli-adm set-credential` command to change the `oda-admin` user credentials.

### Syntax

To reset the `oda-admin` user credentials in interactive mode:

```
odacli-adm set-credential --password --username username [-j] [-h]
```

### Parameters

Parameter	Description
<code>--password, -p</code>	Agent password. The Agent password is needed to access the Oracle Appliance Manager Web Console.
<code>--username, -u</code>	User name required to access the Oracle Appliance Manager Web Console. The default user name is <code>oda-admin</code> .
<code>--json, -j</code>	(Optional) Displays JSON output.
<code>--help, -h</code>	(Optional) Displays help for using the command.

### Usage Notes

Only `root` user can reset the `oda-admin` user credentials.

#### Example 13-43 Resetting the oda-admin Password in Interactive Mode

To reset the `oda-admin` user password to a new password in interactive mode:

```
# odacli-adm set-credential --password --username oda-admin
Agent password: password
```

## odacli Backup and Recovery Commands

Use the `odacli backup` and `recover` commands to backup to and restore from Oracle Cloud Infrastructure Object Storage or disk.

Topics:

- [odacli create-backup](#)  
Use the command `odacli create-backup` to create a Level 0, Level 1, archivelog, or Longterm backup.

- [odacli create-backupconfig](#)  
Use the command `odacli create-backupconfig` to create a backup configuration.
- [odacli create-objectstoreswift](#)  
Use the command `odacli create-objectstoreswift` to create and store the Oracle credential details required to backup to Oracle Object Store.
- [odacli delete-backup](#)  
Use the command `odacli delete-backup` to delete backups.
- [odacli delete-backupconfig](#)  
Use the command `odacli delete-backupconfig` to delete a backup configuration.
- [odacli delete-objectstoreswift](#)  
Use the command `odacli delete-objectstoreswift` to delete the credentials for the ObjectStore account.
- [odacli describe-backupreport](#)  
Use the command `odacli describe-backupreport` to display details of a specific backup report.
- [odacli describe-schedule](#)  
Use the command `odacli describe-schedule` to display details for a specific schedule.
- [odacli irestore-database](#)  
Use the command `odacli irestore-database` to restore a database from one system to other system from ObjectStore based on a LongTerm BackupReport.
- [odacli list-backupreports](#)  
Use the command `odacli list-backupreports` to display a list of all backup reports.
- [odacli list-backupconfigs](#)  
Use the command `odacli list-backupconfig` to list all backup configurations.
- [odacli list-objectstoreswifts](#)  
Use the command `odacli list-objectstoreswifts` to display a list of credentials for the ObjectStore account.
- [odacli list-schedules](#)  
Use the command `odacli list-schedules` to display a list of the scheduled backups.
- [odacli recover-database](#)  
Use the `odacli recover-database` command to recover or restore a database from backup.
- [odacli update-backupconfig](#)  
Use the command `odacli update-backupconfig` to update a backup configuration.
- [odacli update-database](#)  
Use the command `odacli update-database` to associate a backup configuration to a database.

- [odacli update-objectstoreswift](#)  
Use the command `odacli update-objectstoreswift` to change the credentials for the ObjectStore account.
- [odacli update-schedule](#)  
Use the command `odacli update-schedule` to update the schedule for a database, or to disable the database backup schedule.

## odacli create-backup

Use the command `odacli create-backup` to create a Level 0, Level 1, archive log, or Longterm backup.

### File Path

`$ORACLE_HOME/opt/oracle/dcs/bin/odacli`

### Syntax

```
odacli create-backup -iDatabase Resource ID [-bt] [-c] [-h] [-j] [-k] [-t]
```

### Parameters

Parameter	Description
<code>--backupType, -bt {Regular-L0 Regular-L1 Longterm archivelog}</code>	Defines the type of backup. The options are not case sensitive.
<code>--component, -c {Database}</code>	(Optional) Defines the component. Database is the only supported option.
<code>--dbid, -i</code>	Defines the Database Resource ID.
<code>--help, -h</code>	(Optional) Displays help for using the command.
<code>--json, -j</code>	(Optional) Displays JSON output. The default is false.
<code>--keepDays, -k</code>	Defines the Keep Days. For Longterm Backup Type only.
<code>--tag, -t</code>	Defines the name of the backup. A tag is alphanumeric, up to 30 characters. Required for Longterm Backup Type.

### Usage Notes

- Use the command `odacli create-backup` for a specified Database Resource ID and provide a tag for the backup name. Use up to 30 alphanumeric characters for the backup name tag. Three types of backups are available:
  - Level 0: An RMAN incremental backup that backs up all data blocks in the data files being backed up. An incremental backup at level 0 is identical in content to a full backup, but unlike a full backup, the level 0 backup is part of an incremental backup strategy.
  - Level 1: An RMAN incremental backup that includes only those blocks that have been changed since the "parent" backup was taken. A parent backup

- can be either a level 0 or a level 1 backup. If you do not select a backup type (level 0, level 1, or LongTerm), a level 1 backup is performed.
- Longterm: Longterm backups are only available when backing up to Oracle Cloud Infrastructure Object Storage (Oracle Object Storage).
  - Archivelog: This option is used to perform backup of all archivelogs not yet backed up to the backup destination, such as Internal FRA, External FRA (NFS location), or Object Store.
  - This command creates a Backup Report with a Resource ID. To get the ID, use the command `odacli describe-job -i job_id-j` and look for the `resourceId` attribute in `resourceList`.

#### Example 13-44 Create a Manual Database Backup

Create a long term backup that is kept for 90 days and named q12018HR.

```
# odacli create-backup -i Database Resource ID -bt Longterm -c database
-k 90 -t q12018HR
```

#### Example 13-45 Create a Level 0 Database Backup

Create a Level 0 backup named 2017Dec22ProductionLevel0 for resource ID 20576eb1-bc32-4e34-bf97-fda0b60ca15b

```
# odacli create-backup -i20576eb1-bc32-4e34-bf97-fda0b60ca15b -bt Regular-
L0 -t 2017Dec22ProductionLevel0
```

## odacli create-backupconfig

Use the command `odacli create-backupconfig` to create a backup configuration.

### File Path

```
$ORACLE_HOME/opt/oracle/dcs/bin/odacli
```

### Syntax

```
odacli create-backupconfig -n backup configuration name -d
backup destination{Disk|ObjectStore|NFS|None} [-c] [-cr] [-h] [-j] [-no-
cr] [-o][-w]
```

### Parameters

Parameter	Description
<code>--backupdestination, -d {Disk ObjectStore NFS None}</code>	Defines the backup destination. The options are not case sensitive.
<code>--container, -c</code>	(Optional) Defines the object store container.
<code>--crosscheck, -cr</code>	(Optional) Enable crosscheck.
<code>--help, -h</code>	(Optional) Displays help for using the command.

Parameter	Description
<code>--json, -j</code>	(Optional) Displays JSON output. The default is false.
<code>--name, -n</code>	Defines the backup configuration name.
<code>--no-crosscheck, -no-cr</code>	(Optional) Disable crosscheck.
<code>--objectstoreswiftId, -o</code>	(Optional) Defines the swift object store credential ID.
<code>--recoverywindow, -wDisk: {1-14}   ObjectStore: {1-31}</code>	(Optional) Defines the Recovery Window in days. {1-14} days for Disk and {1-31} days for Object Storage in the cloud.

### Usage Notes

- The recovery window that is defined in the backup configuration determines when backups are considered obsolete. The following are guidelines:
  - Disk: 1-14 days
  - Object Storage: 1-31 days

#### Example 13-46 Create a Backup Configuration for Disk

Create a backup configuration named `production` that backs up to disk with a 14 day recovery window.

```
# odacli create-backupconfig -d Disk -n production -w 14
```

#### Example 13-47 Create a Backup Configuration for NFS Location

Create a backup configuration named `production` that backs up to NFS with a 2 day recovery window.

```
odacli create-backupconfig -d NFS -n NfsPolicy1 -c /tmp/Nfsbackps -w 2
```

## odacli create-objectstoreswift

Use the command `odacli create-objectstoreswift` to create and store the Oracle credential details required to backup to Oracle Object Store.

### File Path

```
/opt/oracle/dcs/bin/odacli
```

### Syntax

```
# odacli create-objectstoreswift -e swift end point URL [-h] [-j] -n  
Object Store Swift name [-p] swiftpassword -t Object Store tenant name -u  
Object Store user name
```

## Parameters

Parameter	Description
--endpointurl, -e	Defines the swift end point URL.
--help, -h	(Optional) Displays help for using the command.
--json, -j	(Optional) Displays JSON output. The default is false.
--name, -n	Defines the Object Store Swift name.
--swiftpassword, -p	(Optional) Defines the Object Store Swift password.
--tenantname, -t	Defines the Object Store Swift tenant name.
--username, -u	Defines the Object Store Swift user name.

## Usage Notes

The command creates and stores the Oracle Cloud Infrastructure Object Storage credential details in the system and stores the password in an encrypted Oracle wallet. You can attach the credentials to one or more backup configurations.

The credentials are validated during the command `odacli create-backupconfig` with `objectstore` as the destination. The credentials are not validated against endpoint URL and tenancy.

## odacli delete-backup

Use the command `odacli delete-backup` to delete backups.

### File Path

`$ORACLE_HOME/opt/oracle/dcs/bin/odacli`

### Syntax

```
odacli delete-backup -iDatabase Resource ID [-br] [-h] [-j]
```

## Parameters

Parameter	Description
--backupreport, -br	(Optional) Defines the backup report. To delete a Long Term backup, use a JSON input file for the backupreport.
--dbid, -i	Defines the Database Resource Identifier (ID). To delete a level 0 or level 1 backup, use the database resource ID.
--help, -h	(Optional) Displays help for using the command.
--json, -j	(Optional) Displays JSON output. The default is false.

### Usage Notes

- Delete older, obsolete level 0 and level 1 backups with the Database Resource ID. The recovery window that is defined in the backup configuration determines when backups are considered obsolete.
- Delete long term backups from Oracle Object Storage by using a JSON file with the `--backupreport` option.
- To locate the database ID, view the databases in the Web Console or use the command `odacli list-databases`.

#### Example 13-48 Delete a Level 0 or Level 1 Backup

```
# odacli delete-backup -i20576eb1-bc32-4e34-bf97-fda0b60ca15b
```

#### Example 13-49 Delete a Long Term Backup Report

Delete a Long Term backup using a JSON input file for the Backup Report. In this example, `backupreport.json` is the JSON input for the `backupreport`.

```
# odacli delete-backup -i 20576eb1-bc32-4e34-bf97-fda0b60ca15b -br
backupreport.json
```

## odacli delete-backupconfig

Use the command `odacli delete-backupconfig` to delete a backup configuration.

### File Path

```
$ORACLE_HOME/opt/oracle/dcs/bin/odacli
```

### Syntax

```
odacli delete-backupconfig -i backup configuration id [-h] [-j]
```

### Parameters

Parameter	Description
<code>--help, -h</code>	(Optional) Displays help for using the command.
<code>--id, -i</code>	Defines the Backup Config identifier (ID).
<code>--json, -j</code>	(Optional) Displays JSON output. The default is false.

### Usage Notes

You cannot delete a backup configuration if it is attached to a database.

**Example 13-50 Deleting a Backup Configuration**

Delete a backup configuration named `production` that backs up to disk with a 14 day recovery window.

```
# odacli delete-backupconfig -d Disk -n production -w 14
```

## odacli delete-objectstoreswift

Use the command `odacli delete-objectstoreswift` to delete the credentials for the ObjectStore account.

**File Path**

```
$ORACLE_HOME/opt/oracle/dcs/bin/odacli
```

**Syntax**

```
# odacli delete-objectstoreswift [-h] [-j] -i Object Store Swift id
```

**Parameters**

Parameter	Description
<code>--help, -h</code>	(Optional) Displays help for using the command.
<code>--json, -j</code>	(Optional) Displays JSON output. The default is false.
<code>--objectstoreswiftid, -i</code>	Defines the Object Store Swift identifier (ID).

**Usage Notes**

You cannot delete the Object Store credentials if they are attached to a backup configuration.

**Example 13-51 Deleting the Oracle Object Store Credentials**

```
# odacli delete-objectstoreswift -i Object Store Swift id
```

## odacli describe-backupreport

Use the command `odacli describe-backupreport` to display details of a specific backup report.

**File Path**

```
$ORACLE_HOME/opt/oracle/dcs/bin/odacli
```

**Syntax**

```
odacli describe-backupreport [-h] [-j] [-i]
```



**Parameters**

Parameter	Description
--help, -h	(Optional) Displays help for using the command.
--json, -j	(Optional) Displays JSON output. The default is false.
--id, -i	Defines the backup report ID.

**Example 13-52 Display Details of a Specific Backup Report**

```
# odacli describe-backupreport -i 2d82460c-d648-4e75-8c7d-72cc90bc442a
{
  "id" : "2d82460c-d648-4e75-8c7d-72cc90bc442a",
  "dbResId" : "b5fc646e-01a6-4c8b-8286-7633346c4329",
  "tag" : null,
  "dbId" : "2717054291",
  "dbName" : "ExampleDB",
  "dbUniqueName" : "ExampleDBu",
  "backupType" : "REGULAR-L1",
  "keepDays" : null,
  "backupLocation" : "https://swiftobjectstorage.example.com/v1/dbaasimage/
backupbucket",
  "cfBackupHandle" : "c-2717054291-20180108-04",
  "spfBackupHandle" : "c-2717054291-20180108-04",
  "pitrTimeStamp" : "January 08, 2018 12:43:14 PM UTC",
  "pitrSCN" : "1175058",
  "resetLogsTimeStamp" : "January 08, 2018 09:55:34 AM UTC",
  "resetLogsSCN" : "1112268",
  "oraHomeVersion" : "12.2.0.1.170814 (26723265, 26609817)",
  "sqlPatches" : "25811364,26609817",
  "backupLogLoc" : "https://swiftobjectstorage.example.com/v1/dbaasimage/
backupbucket/scaoda702c1n1/rmanlog/ExampleDBu/2717054291/2018-01-08/
rman_backup_2018-01-08_12-42-41.0545.log",
  "tdeWalletLoc" : null,
  "dbConfigLoc" : "https://swiftobjectstorage.example.com/v1/dbaasimage/
backupbucket/scaoda702c1n1/dbconfig/ExampleDBu/2717054291/2018-01-08/
DBCONFIG_TAG20180108T124407_2018-01-08_12-44-07.0533.tar.gz",
  "name" : "Backup_Report_ExampleDB",
  "createTime" : "January 08, 2018 12:42:08 PM UTC",
  "state" : {
    "status" : "CONFIGURED"
  },
  "updatedAtTime" : "January 08, 2018 12:44:12 PM UTC",
  "backupReportLogDetail" : "https://swiftobjectstorage.example.com/v1/
dbaasimage/backupbucket/scaoda702c1n1/rmandetaillogreport/ExampleDBu/
2717054291/2018-01-08/
rman_list_backup_detail_2018-01-08_12-44-04.0362.log",
  "dbInfo" : {
    "dbClass" : "OLTP",
    "dbType" : "RAC",
    "dbShape" : "odbl",
    "dbEdition" : "EE",
    "dbStorage" : "ASM"
  }
}
```

```

    },
    "dbDataSize" : "1542M",
    "dbRedoSize" : "16403M"
  }
}

```

## odacli describe-schedule

Use the command `odacli describe-schedule` to display details for a specific schedule.

### File Path

```
$ORACLE_HOME/opt/oracle/dcs/bin/odacli
```

### Syntax

```
# odacli describe-schedule [-h] [-j] [-i]
```

### Parameters

Parameter	Description
<code>--help, -h</code>	(Optional) Displays help for using the command.
<code>--json, -j</code>	(Optional) Displays JSON output. The default is false.
<code>--scheduleid, -id</code>	Defines the schedule with an identifier (ID).

### Example 13-53 Display Schedule Details

```
# odacli describe-schedule -i scheduleid
```

## odacli irestore-database

Use the command `odacli irestore-database` to restore a database from one system to other system from ObjectStore based on a LongTerm BackupReport.

### File Path

```
$ORACLE_HOME/opt/oracle/dcs/bin/odacli
```

### Syntax

```
odacli irestore-database -iDatabase Resource ID [-bp] [-r] [-cl] [-co]
[-s] [-dr] [-y] [-h] [-j] [-c] [-oid] [-tp] [-tf] [-bl] [-rDBID]
```

## Parameters

Parameter	Description
<code>--backupPassword(s), -bp</code>	(Optional) Defines the RMAN password for recovery. You can provide more than one password, but the passwords must be separated by a comma(,).
<code>--backupReport, -r</code>	JSON input for a backup report.
<code>--dbClass, -cl {EE: OLTP/DSS/IMDB, SE: OLTP}</code>	(Optional) Defines the Database class.
<code>--dbConsoleEnable, -co</code>	(Optional) Enables the Database Console.
<code>--dbShape, -s {odb1,odb2, and so on}</code>	(Optional) Defines the database shape.
<code>--dbStorage, -dr {ACFS ASM}</code>	(Optional) Defines the database storage. Database Storage {ACFS ASM} (non case-sensitive). The default is ASM.
<code>--dbType, -y</code>	(Optional) Defines the type of database. The default is single instance (SI).
<code>--help, -h</code>	(Optional) Displays help for using the command.
<code>--json, -j</code>	(Optional) Displays JSON output. The default is false.
<code>--noOfRmanChannels, -c</code>	(Optional) Defines the number of RMAN channels (parallelism) Default: SE Edition: 1, Other Enterprise Editions: 5
<code>--objectStoreId, -oid</code>	Defines the Swift Object Store credential ID
<code>--sysPassword, -m</code>	Defines the password for the SYS user.
<code>--tdePassword, -tp</code>	(Optional) Defines the password for the TDE Wallet.
<code>--tdefilesLocation, -tf</code>	(Optional) Identifies the TDE Wallet location in Objectstore.
<code>--backuplocation, -bl</code>	(Optional) Specifies the NFS or local directory path where backups are available.
<code>--dbRedundancy, -rd</code>	Specifies the database redundancy value, that is, {HIGH MIRROR}. To specify the dbRedundancy option, at least one disk group of FLEX redundancy must exist, and dbStorage must be ASM, and the dbVersion or dbHomeVersion must later than 12.1. If the disk group redundancy is FLEX, then the default dbRedundancy value is MIRROR. The precedence logic for setting the dbRedundancy is: <ol style="list-style-type: none"> <li>1. dbRedundancy that is specified in the <code>irestore-database</code> command.</li> <li>2. dbRedundancy in the backup report</li> <li>3. If the disk group redundancy is FLEX, then the default dbRedundancy value is MIRROR.</li> </ol>
<code>-rDBID</code>	Enables target database to run in the same system as source database.

## Usage Notes

- The command `odacli irestore-database` restores a database to a system using the Backup Report of a long term backup that is in the Oracle Object Store.

You can restore a database from one appliance to another appliance, or to the same appliance after the source database is deleted.

- An Oracle wallet (ObjectStoreSwift credentials) must be created to access the backups in Oracle Object Store. This command performs the environment checks, validation checks, and tasks needed to restore a database to an Oracle Database Appliance system.

#### Example 13-54 Restoring a Database to the Same System

Run the command `odacli irestore-database` with the backup report. Enter the SYS user password when prompted.

```
# odacli irestore-database -r backupreport.json -oid Object Store ID -m
```

#### Example 13-55 Restoring a Database to a Different System

To restore to a different system, copy the backup report to the other machine's `\bin` folder (or provide the complete path to the backup report), then run the command `odacli irestore-database` with the backup report. Enter the SYS user password when prompted.

```
# odacli irestore-database -r backupreport.json -oid Object Store ID -m
```

## odacli list-backupreports

Use the command `odacli list-backupreports` to display a list of all backup reports.

#### File Path

```
$ORACLE_HOME/opt/oracle/dcs/bin/odacli
```

#### Syntax

```
# odacli list-backupreports [-h] [-j]
```

#### Parameters

Parameter	Description
<code>--help, -h</code>	(Optional) Displays help for using the command.
<code>--json, -j</code>	(Optional) Displays JSON output. The default is false.

#### Usage Notes

Displays a list of all database backup reports generated from the command `odacli create-backup`.

#### Example 13-56 Display a List of all Backup Reports

```
# odacli list-backupreports
```

## odacli list-backupconfigs

Use the command `odacli list-backupconfig` to list all backup configurations.

### File Path

`$ORACLE_HOME/opt/oracle/dcs/bin/odacli`

### Syntax

```
odacli list-backupconfig [-h] [-j]
```

### Parameters

Parameter	Description
<code>--help, -h</code>	(Optional) Displays help for using the command.
<code>--json, -j</code>	(Optional) Displays JSON output. The default is false.

### Example 13-57 Displaying a List of Backup Configuration

Display a list of backup configurations.

```
# odacli list-backupconfig -d Disk -n production -w 14
```

## odacli list-objectstoreswifts

Use the command `odacli list-objectstoreswifts` to display a list of credentials for the ObjectStore account.

### File Path

`$ORACLE_HOME/opt/oracle/dcs/bin/odacli`

### Syntax

```
# odacli list-objectstoreswifts [-h] [-j]
```

### Parameters

Parameter	Description
<code>--help, -h</code>	(Optional) Displays help for using the command.
<code>--json, -j</code>	(Optional) Displays JSON output. The default is false.

**Example 13-58 Displaying a List of ObjectStore Swift Credentials**

```
# odacli list-objectstoreswifts
```

## odacli list-schedules

Use the command `odacli list-schedules` to display a list of the scheduled backups.

**File Path**

```
$ORACLE_HOME/opt/oracle/dcs/bin/odacli
```

**Syntax**

```
# odacli list-schedules [-h] [-j]
```

**Parameters**

Parameter	Description
<code>--help, -h</code>	(Optional) Displays help for using the command.
<code>--json, -j</code>	(Optional) Displays JSON output. The default is false.

**Usage Notes**

The command lists all of the schedules in the system, including database backup schedules and some internal maintenance schedules.

**Example 13-59 Display a List of Scheduled Database Backups**

Display a list of all scheduled database backups and details.

```
# odacli list-schedules
```

## odacli recover-database

Use the `odacli recover-database` command to recover or restore a database from backup.

**File Path**

```
$ORACLE_HOME/opt/oracle/dcs/bin/odacli
```

**Syntax**

```
odacli recover-database -iDatabase Resource ID [-br] [-i] [-h]
[-j] [-r] [-t] [-p] [-s] [-in]
```

## Parameters

Parameter	Description
<code>--backupReport, -br{Regular-L0 Regular-L1 Longterm}</code>	(Optional) JSON input for a backup report.
<code>--dbName, -in</code>	Defines the Database Name.
<code>--dbid, -i</code>	Defines the Database Resource ID.
<code>--help, -h</code>	(Optional) Displays help for using the command.
<code>--json, -j</code>	(Optional) Displays JSON output. The default is false.
<code>--recoveryTimeStamp, -r</code>	(Optional) Defines the date and time of the backup. The Recovery Timestamp (in format mm/dd/yyyy hh:mm:ss) is required when the recovery is a point in time recovery (PITR).
<code>--recoverytype, -t {Latest PITR SCN}</code>	(Optional) Defines the recovery type. Do not provide the recovery type if you define the Backup Report.
<code>--rmanrecoverypassword(s), -p</code>	(Optional) Defines the password for recovery. You can provide more than one password, but the passwords must be within single quote separated by comma(.).
<code>--scn, -s</code>	(Optional) Defines the SCN recovery type. Required when the RecoveryType is SCN.

## Usage Notes

Recovers a database to the latest, a point in time recovery (PITR), or System Change Number (SCN) as input. You can also recover a database from a Backup Report provided as JSON input file.

This command performs various environment and validation checks in order to attempt to ensure that recovery of database is successful. If backups are in ObjectStore, the RMAN recovery passwords are needed to recover the database. This includes RMAN restore and recovery.

This command always performs a full RMAN database restore and recovery. This command is most useful when there is a complete database loss or when the majority of the database files are lost. If you do not require a full RMAN restore, you can perform a manual recovery. For example, a single data file loss or control file loss.

### Example 13-60 Recovering a Database to a Point-in-Time

```
# odacli recover-database -i b5fc646e-01a6-4c8b-8286-7633346c4 -t PITR -r
11/08/2017 12:57:33 -p
```

### Example 13-61 Recovering a Database to the Latest

```
# odacli recover-database -i b5fc646e-01a6-4c8b-8286-7633346c4 -t Latest -p
```

### Example 13-62 Recovering a Database to an SCN

```
# odacli recover-database -i b5fc646e-01a6-4c8b-8286-7633346c4 -t SCN -s
392375947
```

## odacli update-backupconfig

Use the command `odacli update-backupconfig` to update a backup configuration.

### File Path

```
$ORACLE_HOME/opt/oracle/dcs/bin/odacli
```

### Syntax

```
odacli update-backupconfig -n backup configuration name
-d backup destination{Disk|ObjectStore|None} [-c] [-cr] [-h] [-j] [-no-cr]
[-o][-w]
```

### Parameters

Parameter	Description
--backupdestination, -d{Disk ObjectStore None}	Defines the backup destination. The options are not case sensitive
--container, -c	(Optional) Defines the object store container.
--crosscheck, -cr	(Optional) Enable Crosscheck.
--help, -h	(Optional) Displays help for using the command.
--json, -j	(Optional) Displays JSON output. The default is false.
--name, -n	Defines the backup configuration name.
--no-crosscheck, -no-cr	(Optional) Disable crosscheck.
--objectstoreswiftId, -o	(Optional) Defines the swift object store credential ID.
--recoverywindow, -w Disk: {1-14} ObjectStore: {1-30}	(Optional) Defines the Recovery Window in days. {1-14} days for Disk and {1-30} days for Object store.

### Usage Notes

- The recovery window that is defined in the backup configuration determines when backups are considered obsolete. The following are guidelines:
  - Disk: 1-14 days
  - ObjectStore in Casper: 1-30 days

### Example 13-63 Revise a Backup Configuration for Disk

Create a backup configuration named `production` that backs up to disk with a 14 day recovery window.

```
# odacli update-backupconfig -d Disk -n production -w 14
```



## odacli update-database

Use the command `odacli update-database` to associate a backup configuration to a database.

### File Path

`$ORACLE_HOME/opt/oracle/dcs/bin/odacli`

### Syntax

```
odacli update-database [-bi] [-i] [-h] [-j] [-bp] [-in] [-bin] [-id] [-lb] [-no-bkp]
```

### Parameters

Parameter	Description
<code>--backupconfigid, -bi</code>	(Optional) Defines the Backup Config ID.
<code>--backupconfigname, -bin</code>	(Optional) Defines the Backup Config Name.
<code>--dbid, -i</code>	Defines the Database Resource ID.
<code>--dbName, -in</code>	Defines the Database Name.
<code>--help, -h</code>	(Optional) Displays help for using the command.
<code>--json, -j</code>	(Optional) Displays JSON output. The default is false.
<code>--bkuppassword, -bp</code>	(Optional) Defines the RMAN backup encryption password.
<code>--databaseid, -id</code>	(Optional) Defines the database identifier stored in database file headers.
<code>--levelzerobackupday, -lb</code>	(Optional) Specifies the Level zero Backup Day. For example, Monday Tuesday Wednesday... Sunday
<code>--no-backup, -no-bkp</code>	(Optional) Disables database backups. This command also removes the database backup and archivelog backup schedulers. To enable database backups again, you must update the database with a backupconfig object.

### Usage Notes

For backup to the Oracle Object Store, you can set an RMAN backup password. The password is encrypted and stored in an Oracle wallet. The password is used when using the command `odacli create-backup` to create a database backup.

### Example 13-64 Associating a Backup Configuration with a Database

```
# odacli update-database -i database resource ID -bi backup configuration ID
```

**Example 13-65 Updating an Existing Database Using the Resource ID**

Update an existing database to attach the backup configuration to the database using the Database Resource ID.

```
# odacli update-database -i d3c4d8f6-5eb7-4f9e-ab27-7bdd5013ac90 -bi
9d942e0a-ba00-4cbc-9bfb-0de83ed279e5 -bp
```

**Example 13-66 Updating an Existing Database Using the Resource Name**

Update an existing database to attach the backup configuration to the database using the Database Resource Name.

In the following example, the Database Resource Name is `mydb`:

```
# odacli update-database -in mydb -bi 9d942e0a-ba00-4cbc-9bfb-0de83ed279e5
-bp
```

In the following example, the Database Resource Name is `mydb` and the backup configuration name is `mybcfg`:

```
# odacli update-database -in mydb -bin mybcfg -bp
```

## odacli update-objectstoreswift

Use the command `odacli update-objectstoreswift` to change the credentials for the ObjectStore account.

**File Path**

```
$ORACLE_HOME/opt/oracle/dcs/bin/odacli
```

**Syntax**

```
# odacli update-objectstoreswift [-h] [-j] -i Object Store Swift id [-p]
swift password [-u] Object Store user name
```

**Parameters**

Parameter	Description
<code>--help, -h</code>	(Optional) Displays help for using the command.
<code>--json, -j</code>	(Optional) Displays JSON output. The default is false.
<code>--objectstoreswiftid, -i</code>	Defines the Object Store Swift identifier (ID).
<code>--swiftpassword, -p</code>	(Optional) Defines the Object Store Swift password.
<code>--username, -u</code>	(Optional) Defines the Object Store Swift user name.

## Usage Notes

Use this command to update the password when it is changed for an ObjectStore account. The command updates the Oracle ObjectStore credential details in the system and stores the password in an encrypted Oracle wallet.

The credentials are validated during the command `odacli update-backupconfig` with `objectstore` as the destination. The credentials are not validated against endpoint URL and tenancy.

### Example 13-67 Changing the Oracle Casper ObjectStore Password

```
# odacli update-objectstoreswift -i Object Store Swift id -p swift
password
```

### Example 13-68 Changing the Oracle ObjectStore User Name

```
# odacli update-objectstoreswift -i Object Store Swift id -u Object Store
user name
```

## odacli update-schedule

Use the command `odacli update-schedule` to update the schedule for a database, or to disable the database backup schedule.

### File Path

```
$ORACLE_HOME/opt/oracle/dcs/bin/odacli
```

### Syntax

```
# odacli update-schedule [-x] [-t] [-d] [-e] [-h] [-j] [-id]
```

### Parameters

Parameter	Description
<code>--cronExpression, -x</code>	(Optional) Defines the date and time for the update.
<code>--description, -t</code>	(Optional) Provides a description for the update schedule.
<code>--disable, -d</code>	(Optional) Disables the schedule.
<code>--enable, -e</code>	(Optional) Enables a disabled schedule.
<code>--help, -h</code>	(Optional) Displays help for using the command.
<code>--json, -j</code>	(Optional) Displays JSON output. The default is false.
<code>--scheduleid, -id</code>	Defines the schedule with an identifier (ID).

### Usage Notes

Backups incur overhead on the system. When possible, do not schedule backups to run when users are trying to access data.

Use a utility, such as [www.croncronmaker.com](http://www.croncronmaker.com), to generate a valid cron expression.

### Example 13-69 Change What Time the Backup Occurs

Edit the cron expression to change the time of scheduled backups for a given schedule ID.

```
# odacli update-schedule -i scheduleid -x "0 0 13 1/1 * ? *" -e
```

### Example 13-70 Disable Scheduled Database Backups

```
# odacli update-schedule -i scheduleid -d
```

## odacli CPU Core Commands

Use the CPU Core commands to enable CPU cores and display current and historical CPU core configurations.

- [odacli list-cpucores](#)  
Use the `odacli list-cpucores` command lists the history of core configuration changes in the system.
- [odacli describe-cpucore](#)  
Use the `odacli describe-cpucore` command to display the current core configuration and the modification date and time.
- [update-cpucore](#)  
Use the `odacli update-cpucore` command to enable the number of CPU cores in the system.

## odacli list-cpucores

Use the `odacli list-cpucores` command lists the history of core configuration changes in the system.

### File Path

```
$ORACLE_HOME/opt/oracle/dcs/bin/odacli
```

### Syntax

```
odacli list-cpucores [-h]
```

### Parameters

Parameter	Description
--help, -h	(Optional) Displays help for using the command.

**Example 13-71 Displaying a List of Cores**

```
# odacli list-cpucores
```

Node	Cores	Modified	Job Status
0	10	July 22, 2016 12:06:08 PM SGT	Configured
0	8	July 25, 2016 9:39:59 AM SGT	Configured

## odacli describe-cpucore

Use the `odacli describe-cpucore` command to display the current core configuration and the modification date and time.

**File Path**

```
/opt/oracle/dcs/bin/odacli
```

**Syntax**

```
odacli describe-cpucore [-h]
```

**Parameters**

Parameter	Description
<code>--help, -h</code>	(Optional) Displays help for using the command.

**Example 13-72 Displaying the Current Core Configuration**

```
# odacli describe-cpucore
```

Node	Cores	Modified	Job Status
0	8	July 25, 2016 9:39:59 AM SGT	Configured

## update-cpucore

Use the `odacli update-cpucore` command to enable the number of CPU cores in the system.

**File Path**

```
/opt/oracle/dcs/bin/odacli
```

**Syntax**

```
odacli update-cpucore -c cores [-h]
```

## Parameters

Parameter	Description
<code>--cores, -c</code>	Defines the number of cores to be enabled in the system.
<code>--help, -h</code>	(Optional) Displays help for using the command.

## Usage Notes

- The number of cores you enable must be a multiple of 2.
- After the initial configuration, you cannot reduce the number of cores. You can only increase the number of cores.

### Example 13-73 Enabling CPU Cores

The following command enables 8 CPU cores.

```
# odacli update-cpucore -c 8

{
  "jobId" : "2807f6ae-3ba5-48a5-8941-b8b365d89d24",
  "status" : "Created",
  "message" : null,
  "reports" : [ ],
  "createTimestamp" : 1469410799194,
  "description" : "CPU cores service update",
  "updatedAtTime" : 1469410799194
}
```

# odacli Database Commands

Use the `odacli` database commands to perform database lifecycle operations.

- [odacli list-databases](#)  
Use the `odacli list-databases` command to list all databases on the appliance.
- [odacli describe-database](#)  
Use the `odacli describe-database` command to display database details.
- [odacli create-database](#)  
Use the `odacli create-database` command to create a new database.
- [odacli clone-database](#)  
Use the `odacli clone-database` command to clone a new database from a source database.
- [odacli modify-database](#)  
Use the `odacli modify-database` command to move a database from one database home to another database home of the same base version, or resize the database, or move and resize databases in the same operation.

- [odacli register-database](#)  
Use the `odacli register-database` command to register a migrated database with the appliance.
- [odacli upgrade-database](#)  
Use the `odacli upgrade-database` command to upgrade a database from a supported release.
- [odacli delete-database](#)  
Use the `odacli delete-database` command to delete a database.

## odacli list-databases

Use the `odacli list-databases` command to list all databases on the appliance.

### File Path

`$ORACLE_HOME/opt/oracle/dcs/bin/odacli`

### Syntax

To display a list of all databases:

```
odacli list-databases [-h]
```

### Parameters

Parameter	Description
<code>--help, -h</code>	(Optional) Displays help for using the command.

### Example 13-74 Displaying a List of Databases

Display a list of databases:

```
# odacli list-databases
```

```
ID                               DB Name    DB Version  CDB
-----
ad6c7326-e460-411e-94df-230dedbef743  rdb121a    18.7.0.0.0  true
fb4d02f3-2413-47ca-8584-a768e23ec2e7  ee12db     18.7.0.0.0  false
```

(Continued)

```
Class  Shape  Storage  Status
-----
OLTP   odb1   ACFS     Configured
IMDB   odb1   ASM      Configured
```

## odacli describe-database

Use the `odacli describe-database` command to display database details.

### File Path

`$ORACLE_HOME/opt/oracle/dcs/bin/odacli`

## Syntax

To display database details:

```
odacli describe-database -i dbid [-h] [-j]
```

## Parameters

Parameter	Description
--dbid, -i	Identifies the database home identifier (ID) to display. Use the <code>odacli list-databases</code> command to obtain the dbid.
--json, -j	(Optional) Displays JSON output.
--help, -h	(Optional) Displays help for using the command.

### Example 13-75 Displaying Database Details

Display information for database named `ac48e0d2-a7b0-4ffd-a27e-f8e42b028c5f` :

```
# odacli describe-database -i ac48e0d2-a7b0-4ffd-a27e-f8e42b028c5f

Database details
-----
ID: ac48e0d2-a7b0-4ffd-a27e-f8e42b028c5f
Description: rdb1
DB Name: rdb1
DB Version: 18.7.0.0.0
DBID: 1339792271
CDB: true
PDB Name: rlpdb1
PDB Admin User Name: pdbadmin
Class: OLTP
Shape: odb2
Storage: ASM
CharacterSet: DbCharacterSet(characterSet=AL32UTF8,
nlsCharacterSet=AL16UTF16, dbTerritory=AMERICA, dbLanguage=AMERICAN)
Home ID: fe87f30c-b810-45d1-8b96-13996ad7a255
Console Enabled: true
Created: May 18, 2019, 2016 6:21:14 PM
```

## odacli create-database

Use the `odacli create-database` command to create a new database.

### File Path

```
$ORACLE_HOME/opt/oracle/dcs/bin/odacli
```



## Syntax

```
odacli create-database -n database_name -m -cs characterset -cl {OLTP|DSS|
IMDB}
-l dblanguage -s dbshape -r {ACFS|ASM} -dt dbterritory
-y dbtype -ns nationalcharacterset -d pdbadmin -p pdbname -v version
[-u databaseUniqueName] [-dh Database Home ID] [-c|-no-c] [-co|-no-co]
[-bi backupconfigid] [-io] [-dn] [-j] [-h] [-rd]
```

## Parameters

Parameter	Description
--adminpassword, -m	Defines the password for SYS, SYSTEM, and PDB Admin. Use this option to specify the password interactively. When using this option, do not enter the password in the command-line.
--backupconfigid, -bi	(Optional) Defines the backup configuration identifier for future use.
--cdb, -c	(Optional) Creates the database as a container database. Use the -c flag to create a container database and use the -no-c flag to create a non-CDB database. The default is -no-c.
--characterset, -cs	Defines the character set. The default is AL32UTF8.
--databaseUniqueName, -u	(Optional) Defines a unique name for the database.
--dbdomainname, -dn	Defines the database domain name.
--dbclass, -cl {OLTP DSS IMDB}	Defines the database class. The default is OLTP. The options are as follows: <ul style="list-style-type: none"> <li>Enterprise Edition: OLTP, DSS, or IMDB.</li> <li>Standard Edition: OLTP</li> </ul>
--dbconsole, -co	(Optional) Enables the Database Console. Use the -no-co flag to disable the Database Console. If not selected, the default is no database console.
--dbhomeid, -dh	(Optional) Identifies the existing Database Home ID.
--dblanguage, -l	Defines the database language. The default language is AMERICAN.
--dbname, -n	Defines the name given to the new database (dbname.)
--dbshape, -s	Identifies the database shape (template) and determines the total memory allocated to the database. For example, odb1 and odb2. The default is odb1. You cannot specify the database shape when you create a instance-only database.
--dbstorage, -r {ACFS ASM}	Defines the Database Storage, either Oracle ACFS or Oracle ASM. The default value is Oracle ASM.
--dbterritory, -dt	Defines the database territory. The default territory is AMERICA.
--dbtype, -y [SI]	Defines the database type. The default database type is SI.

Parameter	Description
<code>--help, -h</code>	(Optional) Displays help for using the command.
<code>--instanceonly, -io</code>	(Optional) Creates a database instance, password file and also the underlying Oracle ACFS mount point. You can use the instance as an auxiliary instance for RMAN duplicate.
<code>--json, -j</code>	(Optional) Displays JSON output.
<code>--nationalcharacter set, -ns</code>	Defines the NLS National Character Set. The default is AL16UTF16.
<code>--no-cdb, -no-c</code>	(Optional) Creates a database that is <i>not</i> a container database. Use this flag when you want to create a non-CDB database. Use the <code>-c</code> flag to create a container database.
<code>--no-dbconsole, -no-co</code>	(Optional) Disables Database Console. Use the <code>-co</code> flag to enable Database Console.
<code>--pdbadmin, -d</code>	Defines the Pluggable Database (PDB) Admin User.
<code>--pdbname, -p</code>	Defines the Pluggable Database (PDB) name. The default value is <code>pdb1</code> .
<code>--version, -v</code>	Defines the database bundle patch number. To install the latest bundle patch for a release, specify the release version.  To specify a specific supported bundle, use the 5 digit format. For example, 12.1.0.2.170814 or 11.2.0.4.170814.
<code>--dbRedundancy, -rd</code>	Specifies the database redundancy value, that is, {HIGH   MIRROR}. To specify the <code>dbRedundancy</code> option, at least one disk group of FLEX redundancy must exist, and <code>dbStorage</code> must be ASM, and the <code>dbVersion</code> or <code>dbHomeVersion</code> must later than 12.1.

### Usage Notes

- If the disk group redundancy is FLEX, then the default `dbRedundancy` value is MIRROR.
- Flash cache is disabled by default.
- You cannot mix Oracle Database Standard Edition and Enterprise Edition databases on the same appliance.
- Use the `--cdb` or `--no-cdb` flag to indicate whether or not the database is a container database. When neither flag is specified, the default database created is a non-CDB database.
- When `--dbhomeid` is not provided, the `create-database` command creates a new Oracle Database Home.
- When `--dbhomeid` is provided, the `create-database` command creates the database using the existing Oracle Home. Use the `odacli list-dbhomes` command to obtain the `dbhomeid`.
- When you use the command to create an instance-only database, then you cannot specify the database shape (template).

- When you specify both the `--version` and the `--dbhomeid`, the version is ignored and the database is created against the existing database home.
- Oracle Database 12.1 or later is supported on both Oracle Automatic Storage Management (Oracle ASM) and Oracle ASM Cluster file system (ACFS). The default is Oracle ASM.
- Oracle Database 11.2 is only supported on Oracle ACFS.
- When databases are created in Oracle ACFS, each database is configured with its own Oracle ACFS file system for the datafiles and uses the following naming convention: `/u02/app/db user/oradata/db unique name`. The default size of this mount point is 100 GB.

 **Note:**

Oracle recommends not sharing the mount point across different databases.

- Online logs are stored in the `/u03/app/db user/redo/` directory.
- Oracle Fast Recovery Area (FRA) is located in the `/u03/app/db user/fast_recovery_area` directory.
- Use the following option to specify the `adminpassword`:
  - Interactive mode: Use the `-m` option and enter the password when prompted.
- For the version, you can specify the database version, such as 18.7.0.0, 18.5.0.0, 12.2.0.1, 12.1.0.2 or 11.2.0.4, or you can use a 5 digit format to specify a specific patch bundle version. If you use the database version without specifying the bundle patch number, the latest bundle patch is used.

 **Note:**

Oracle Database 11.2.0.4.160419 is not supported. Attempts to create an Oracle Database 11.2 against an 11.2.0.4.160419 database home will fail.

### Example 13-76 Creating a Database in Interactive Mode

This example creates a 18.7.0.0.0 OLTP container database named `hrdb` with shape `odb2` and enables you to provide the password interactively.

 **Note:**

To provide a password interactively, use the `-m` option, but do not provide the password until prompted.

```
# odacli create-database -n hrdb -c -m -cl OLTP -s odb2 -p pdb1
```

```
Password for SYS,SYSTEM and PDB Admin:
{
```

```

    "jobId" : "f12485f2-dcbe-4ddf-aeel-de24d37037b6",
    "status" : "Created",
    "message" : null,
    "reports" : [ ],
    "createTimestamp" : "May 18, 2019 03:54:03 AM EDT",
    "description" : "Database service creation with db name: hrdb",
    "updatedAt" : "May 18, 2019 03:54:03 AM EDT"
  }

```

### Example 13-77 Creating a Database Against a Different Version

Either of the following statements creates a database against a home with Oracle Database Bundle (170718) applied:

```

# odacli create-database -m -n hrmsdb1 -v 18.7.0.0.0
# odacli create-database -m -n hrmsdb2 -v 18.7.0.0.190716

```

The following statement creates a new database against a home with a specific Oracle Database Bundle:

```

# odacli create-database -m -n hrmsdb3 -v 18.7.0.0.190716

```

## odacli clone-database

Use the `odacli clone-database` command to clone a new database from a source database.

### File Path

```
/opt/oracle/dcs/bin/odacli
```

### Syntax

```
odacli clone-database [-u] [-n] [-s] [-y|SI|RAC|RACONE] [-j] [-f] [-m] [-p] [-h]
```

### Parameters

Parameter	Description
<code>--databaseUniqueName, -u</code>	(Optional) Defines a unique name for the database. If the <code>--databaseUniqueName</code> option is not provided, then the name of the database is set to the <code>--dbname</code> value.
<code>--dbname, -n</code>	Defines the name given to the new database (dbname.)
<code>--dbshape, -s</code>	Identifies the database shape (template) and determines the total memory allocated to the database. For example, odb1 and odb2. The default is odb1.

Parameter	Description
<code>--dbtype, -y [SI]</code>	Defines the database type. The default database type is the source database type, if the option is not specified.
<code>--help, -h</code>	(Optional) Displays help for using the command.
<code>--json, -j</code>	(Optional) Displays JSON output.
<code>--sourcedbname, -f</code>	Specifies the name of the source database
<code>--syspassword, -m</code>	Specifies the password for the SYS user.
<code>--tdepassword, -p</code>	Specifies the password for the source TDE Wallet.

### Usage Notes

- The source database must be up and running.
- The source database must use Oracle ACFS storage.
- The source database must not be a multitenant container database (CDB)

### Example 13-78 Cloning a Database

The following example creates a clone database `snap1` from source database `acfsdb1`.

```
# /opt/oracle/dcs/bin/odacli clone-database -n snap1 -u snaplu -f acfsdb1 -
hm password
```

### Related Topics

- [Cloning an Oracle ACFS Database Using Command Line Interface](#)  
Create a database from an existing Oracle ACFS database using CLI commands.

## odacli modify-database

Use the `odacli modify-database` command to move a database from one database home to another database home of the same base version, or resize the database, or move and resize databases in the same operation.

### File Path

```
$ORACLE_HOME/opt/oracle/dcs/bin/odacli
```

### Syntax

```
odacli modify-database [-i] [-dh] [-cl] [-s] [-h] [-j]
```

### Parameters

Parameter	Description
<code>--databaseid, -i</code>	Defines the Database ID.
<code>--destdbhomeid, -dh</code>	Defines the destination database home ID.

Parameter	Description
<code>--dbClass, -cl</code>	Defines the database class. The default is OLTP. The options are as follows: <ul style="list-style-type: none"> <li>Enterprise Edition: OLTP, DSS, or IMDB</li> <li>Standard Edition: OLTP</li> </ul>
<code>--dbShape, -s</code>	Identifies the database shape (template) and determines the total memory allocated to the database. For example, odb1 and odb2. The default is odb1. You cannot specify the database shape for an instance-only database.
<code>--help, -h</code>	(Optional) Displays help for using the command.
<code>--json, -j</code>	(Optional) Displays JSON output.

### Example 13-79 Moving a Database from one Oracle home to another

```
# ./odacli modify-database -i database_ID -dh destination_database_home_ID
```

### Example 13-80 Modifying the Database Shape (Template) and Database Class

```
# ./odacli modify-database -s database_shape -cl database_class
odacli modify-database -i 1941d594-c777-4eca-9fce-18b778d5c153 -s odb2 -cl
DSS
{
  "jobId" : "833d43a7-bcc6-48a7-9f98-b42ffdab3fe1",
  "status" : "Created",
  "message" : null,
  "reports" : [ ],
  "createTimestamp" : "August 26, 2019 06:48:58 AM UTC",
  "resourceList" : [ ],
  "description" : "modify-database service with db ids: 1941d594-
c777-4eca-9fce-18b778d5c153",
  "updatedAt" : "August 26, 2019 06:48:58 AM UTC"
}
```

### Example 13-81 Moving and Resizing a Database

```
[root@oak1 ~]# odacli modify-database -i f903c7e2-4376-4160-
b989-9222936f4f58 -dh 6a9d4497-c9dd-43f8-baf4-4e3df1ceb27e -s odb2 -cl DSS
{
  "jobId" : "5eff7912-9ff1-420c-9429-9fb21cab800c",
  "status" : "Created",
  "message" : null,
  "reports" : [ ],
  "createTimestamp" : "September 13, 2019 06:45:10 AM UTC",
  "resourceList" : [ ],
  "description" : "modify-database service with db ids: f903c7e2-4376-4160-
b989-9222936f4f58",
  "updatedAt" : "September 13, 2019 06:45:10 AM UTC"
}
```

## odacli register-database

Use the `odacli register-database` command to register a migrated database with the appliance.

### File Path

```
$ORACLE_HOME/opt/oracle/dcs/bin/odacli
```

### Syntax

```
odacli register-database -c {OLTP|DSS|IMDB} -s dbshape -t dbtypeSI  
-o hostname -sn servicename -p syspassword[-bi backupconfigid] [-co|-no-  
co] [-h][-j]
```

### Parameters

Parameter	Description
<code>--backupconfigid, -bi</code>	(Optional) Defines the backup configuration identifier for future use.
<code>--dbclass, -c {OLTP DSS IMDB}</code>	Defines the database class. The database class setting determines the database SGA memory and instance PGA memory configuration. The options are as follows: <ul style="list-style-type: none"> <li>Enterprise Edition: OLTP, DSS, or IMDB.</li> <li>Standard Edition: OLTP</li> </ul>
<code>--dbconsole, -co</code>	(Optional) Enables the Database Console. Use the <code>-no-co</code> flag to disable the Database Console. If not selected, the default is no Database Console.
<code>--dbshape, -s</code>	Identifies the database shape (template) and determines the total memory allocated to the database. For example, <code>odb1</code> and <code>odb2</code> . The default is <code>odb1</code> .
<code>--dbtype, -t [SI]</code>	Defines the type of database. Only single-instance databases can be registered.
<code>--help, -h</code>	(Optional) Displays help for using the command.
<code>--hostname, -o</code>	Defines the host name. Default: local host name
<code>--json, -j</code>	(Optional) Displays JSON output.
<code>--no-dbconsole, -no-co</code>	(Optional) Disables Database Console. Use the <code>-co</code> flag to enable Database Console.
<code>--servicename, -sn</code>	Defines the Database Service Name. Using this service name, the EZCONNECT String is derived for connecting to the database. For example, <code>hostname:port/servicename</code> . The Port number is the port configured for the listener, as part of the deployment.

Parameter	Description
<code>--syspassword, -p</code>	Defines the proxy user password for SYS.
<code>--tdeWalletPassword, -tp</code>	Defines the password for TDE Wallet.

### Usage Notes

#### Note:

It is a good practice to use Easy Connect (EZCONNECT) to test the database connectivity before registering the database. Log in as the `sys` user and enter the following command:

```
sqlplus sys/password@//hostname:1521/service name
```

- The `odacli register-database` command is supported only on the primary database.
- The migrated database is registered with the listener configured during the provisioning of the appliance. The migrated database must be in read-write or read-only mode for the registration to succeed.
- The `register-database` command validates the datafile and log file locations and moves the `controlfile` and `spfile` to the correct locations.
- The following are the minimum compatible parameters set, based on the database version:
  - Oracle Database 18c : 18.3.0.0
  - Oracle Database 12c : 12.1.0.2
  - Oracle Database 11g : 11.2.0.4
- Some `init.ora` parameters are set, or reset, as part of the registration. Review the parameter changes before and after registration.
 

The following are examples of changes implemented as part of registration:

  - The `memory_target` is reset.
  - The `sga_target/pga_aggregate_target/log_buffer/inmemory_size` is configured based on the database class and database shape settings used during registration.
  - The registration process sets, or resets, the recommended appliance-specific parameters.
- The database being registered must use Oracle Managed Files and the file location must match the DATA Location, REDO Location and RECO Location of the `odacli describe-dbstorage` command.
- As part of the registration process, the database is registered with Oracle Clusterware. Only the primary database is registered with Oracle Clusterware.



**Example 13-82 Registering a Migrated Database**

The following is the syntax to register a single instance OLTP database that is using shape odbl.

```
odacli register-database -c OLTP -s odbl -sn crmdb.example.com -p
Password for SYS:
{
  "jobId" : "317b430f-ad5f-42ae-bb07-13f053d266e2",
  "status" : "Created",
  "message" : null,
  "reports" : [ ],
  "createTimestamp" : "May 18, 2019 05:55:49 AM EDT",
  "description" : "Database service registration with db service name:
crmdb.example.com",
  "updatedAtTime" : "May 18, 2019 05:55:49 AM EDT"
}
rpandrap: ]# odacli describe-job -i "317b430f-ad5f-42ae-bb07-13f053d266e2"
```

Job details

```
-----
                        ID: 317b430f-ad5f-42ae-bb07-13f053d266e2
Description: Database service registration with db service
name: crmdb.example.com
                Status: Success
                Created: May 18, 2019 5:55:49 AM EDT
                Message:
```

Task Name	Start Time
restore control file	May 18, 2019 5:55:49 AM EDT
move spfile to right location	May 18, 2019 5:56:08 AM EDT
register DB with clusterware	May 18, 2019 5:56:13 AM EDT
reset db parameters	May 18, 2019 5:57:05 AM EDT
Running DataPatch	May 18, 2019 5:57:36 AM EDT

(Continued)

End Time	Status
May 18, 2019 5:56:08 AM EDT	Success
May 18, 2019 5:56:13 AM EDT	Success
May 18, 2019 5:57:05 AM EDT	Success
May 18, 2019 5:57:36 AM EDT	Success
May 18, 2019 5:57:49 AM EDT	Success

## odacli upgrade-database

Use the `odacli upgrade-database` command to upgrade a database from a supported release.

**File Path**

```
$ORACLE_HOME/opt/oracle/dcs/bin/odacli
```

## Syntax

To upgrade an Oracle Database:

```
odacli upgrade-database -i Comma separated list of database ids -from  
source dbhome id -to destination dbhome id [-j] [-h]
```

## Parameters

Parameter	Description
--databaseids, -i	(Optional) Defines the Database IDs to upgrade. You can use a comma separated list of database IDs.
--destDbHomeId, -to	The DB HOME ID of the destination database home.
--sourceDbHomeId, -from	The DB HOME ID of the source database home.
--json, -j	(Optional) Displays JSON output. The default is false.
--help, -h	(Optional) Displays help for using the command.

## Usage Notes

You have the following options for defining the databases to upgrade:

- When you define a single database ID, only the database of the source database home is upgraded.
- When you define more than one database ID, only those databases of the source database home are upgraded.
- When you do not define a database ID, all of the databases under the source database home are upgraded.

You can upgrade databases of the following releases:

- Oracle Database 12.2 to 18c
- Oracle Database 12.1 to 18c
- Oracle Database 11c to 18c
- Oracle Database 12.1 to 12.2
- Oracle Database 11c to 12.2
- Oracle Database 11c to 12.1

### Example 13-83 Upgrading an Oracle Database

In this example, a single database is upgraded. Use the command `odacli list-databases` to display the database ID, then use the command `odacli upgrade-databases` to upgrade the 11.2.0.4 database. After the upgrade is complete, you can run the command `odacli list-databases` again to verify the upgrade.

```
# odacli list-databases
```

ID	DB Name	DB Version	CDB
ad6c7326-e460-411e-94df-230dedbef743	rdb121a	11.2.0.4	true
fb4d02f3-2413-47ca-8584-a768e23ec2e7	ee12db	12.1.0.2	false

```
(Continued)
Class   Shape   Storage  Status
-----
OLTP    odbl      ACFS     Configured
IMDB    odbl      ASM      Configured

# odacli upgrade-database -i ad6c7326-e460-411e-94df-230dedbef743 -from fa4321f5-0543-477d-
bb54-a429dcc8ee8d -to d752df28-ecdd-4af4-9454-38085ea17f8b
{
  "jobId" : "1bbe8boe-acb0-4296--9c8b-473b69da0c18",
  "status" : "Created",
  "message" : null,
  "reports" : [ ],
  "createTimestamp" : "October 24, 2017 03:54:03 AM EDT",
  "description" : "Database service upgrade with db ids: [ad6c7326-
e460-411e-94df-230dedbef743]",
  "updatedAtTime" : "October 24, 2017 03:54:03 AM EDT"
}

# odacli list-databases

ID                                     DB Name   DB Version  CDB
-----
ad6c7326-e460-411e-94df-230dedbef743  rdb121a   12.1.0.2    true
fb4d02f3-2413-47ca-8584-a768e23ec2e7  ee12db    12.1.0.2    false

(Continued)
Class   Shape   Storage  Status
-----
OLTP    odbl      ACFS     Configured
IMDB    odbl      ASM      Configured
```

### Related Topics

- [About Upgrading to a Different Database Home](#)  
Understand how to upgrade to a different database home using either the Web Console or odacli commands.

## odacli delete-database

Use the `odacli delete-database` command to delete a database.

### File Path

```
/opt/oracle/dcs/bin/odacli
```

### Syntax

To delete a database:

```
odacli delete-database -i dbid [-h] [-j] [-fd]
```

## Parameters

Parameter	Description
--dbid, -i	Identifies the database home identifier (ID) to display. Use the <code>odacli list-databases</code> command to obtain the --dbid.
--force, -fd	(Optional) Forces the delete operation.
--help, -h	(Optional) Displays help for using the command.
--json, -j	(Optional) Displays JSON output.

## Usage

### Note:

The `delete-database` command deletes the database, the file system, and the underlying `advm` volumes assigned to the database. For example, deleting a database named `hrdb` also deletes the file system `/u02/app/oracle/oradata/hrdb`. Do not keep any other files on this database file location.

### Example 13-84 Deleting a Database Named `hrmsdb`

In this example we want to delete a database named `hrmsdb`. Before we can delete the database, we need to know the database home identifier (*dbid*). This example shows how to run the `odacli list-databases` command to list the databases and their associated *dbid*, then how to delete database `hrmsdb`.

```
# odacli list-databases

ID                               DB Name  DB Version  CDB
Class
-----
-----
a3f4a6c0-a0c9-4c79-bad7-898afcf9de46  hrmsdb  12.1.0.2    true  OLTP
7e28bf52-1a09-49fd-9391-841838d2c42f  crmdb   12.1.0.2    false OLTP

(continued)
Shape      Storage  Status
-----
odbl       ACFS     Configured
odbl       ACFS     Configured

# odacli delete-database -i a3f4a6c0-a0c9-4c79-bad7-898afcf9de46
```

## odacli DBHome Commands

Use the `odacli DBHome` commands to manage database Home operations.

- [odacli list-dbhomes](#)  
Use the `odacli list-dbhomes` command to display a list of Oracle Home directories.
- [odacli describe-dbhome](#)  
Use the `odacli describe-dbhome` command to display Oracle Database Home details.
- [odacli create-dbhome](#)  
Use the `odacli create-dbhome` command to create an Oracle Database Home.
- [odacli delete-dbhome](#)  
Use the `odacli delete-dbhome` command to delete database home that is not associated with a database.

## odacli list-dbhomes

Use the `odacli list-dbhomes` command to display a list of Oracle Home directories.

### File Path

`$ORACLE_HOME/opt/oracle/dcs/bin/odacli`

### Syntax

To display a list of Oracle Home directories:

```
odacli list-dbhomes [-h] [-j]
```

### Parameters

Parameter	Description
<code>--help,-h</code>	(Optional) Displays help for using the command.
<code>--json,-j</code>	(Optional) Displays JSON output.

### Example 13-85 Displaying a List of Oracle Home Directories

Run the following command to display a list of Oracle Home directories:

```
# odacli list-dbhomes

ID                               Name                               DB Version
-----
b727bf80-c99e-4846-ac1f-28a81a725df6 OraDB12102_home1 12.1.0.2

(continued)
Home Location
-----
/u01/app/orauser/product/12.1.0.2/dbhome_1
```

## odacli describe-dbhome

Use the `odacli describe-dbhome` command to display Oracle Database Home details.

### File Path

`$ORACLE_HOME/opt/oracle/dcs/bin/odacli`

### Syntax

To display details about Oracle Database Home:

```
odacli describe-dbhome -i dbhomeid [-h] [-j] [-v]
```

### Parameters

Parameter	Description
<code>-i <i>dbhomeid</i></code>	Identifies the database home ID. Use the <code>odacli list-dbhomes</code> command to get the <i>dbhomeid</i> .
<code>--help, -h</code>	(Optional) Displays help for using the command.
<code>--json, -j</code>	(Optional) Displays JSON output. The default is false.
<code>-v<i>dbversion</i></code>	(Optional) Identifies the Database Home Version. Use the <code>odacli list-dbhomes -v</code> command to get the <i>dbversion</i> .

### Example 13-86 Displaying Oracle Database Home Details

The following output is an example of using the display Oracle Database Home details command:

```
# odacli describe-dbhome -i b727bf80-c99e-4846-ac1f-28a81a725df6

DB Home details
-----
                ID: b727bf80-c99e-4846-ac1f-28a81a725df6
                Name: OraDB12102_home1
                Version: 12.1.0.2
Home Location: /u01/app/orauser/product/12.1.0.2/dbhome_1
                Created: Jun 2, 2016 10:19:23 AM
```

## odacli create-dbhome

Use the `odacli create-dbhome` command to create an Oracle Database Home.

### File Path

`$ORACLE_HOME/opt/oracle/dcs/bin/odacli`

## Syntax

To create an Oracle Database Home:

```
odacli create-dbhome -v version [-j] [-h]
```

## Parameters

Parameter	Description
-v <i>version number</i>	Defines the database bundle patch number.
--json, -j	(Optional) Displays JSON output.
--help, -h	(Optional) Displays help for using the command.

## Usage Notes

For the version number, you can specify the database version, such as 18.7.0.0, 18.5.0.0, 12.2.0.1, 12.1.0.2 or 11.2.0.4, or you can use a 5 digit format to specify a specific patch bundle version. For example, 18.7.0.0.190716. If you use the database version without specifying the bundle patch number, then the latest bundle patch is used.



### Note:

Oracle Database 11.2.0.4.160419 is not supported. Attempts to create an Oracle Database 11.2 against an 11.2.0.4.160419 database home will fail.

## Example 13-87 Creating an Oracle Database Home

The following example creates an Oracle Database Home version 18.7.0.0.190716.

```
# odacli create-dbhome -v 18.7.0.0.190716
```

## odacli delete-dbhome

Use the `odacli delete-dbhome` command to delete database home that is not associated with a database.

### File Path

```
$ORACLE_HOME/opt/oracle/dcs/bin/odacli
```

### Syntax

```
odacli delete-dbhome -i [-h]
```

## Parameters

Parameter	Description
<code>--id, -i</code>	Identifies the database home using a database identifier (ID).
<code>--help, -h</code>	(Optional) Displays help for using the command.

## Usage Notes

- Use the `odacli list-dbhomes` command to locate the identifier.
- To delete, or uninstall, a database home (dbhome), there must not be any associated databases in the dbhome.
- Use the `odacli delete-database` command to delete an existing database.

### Example 13-88 Deleting an Empty Database Home

```
# odacli delete-dbhome -i 0ce547ca-3df2-4178-a7e6-eeefa613aeab4
```

## odacli Database Storage Commands

Use the Database Storage commands to list, describe, create, and delete Oracle database storage.

- [odacli list-dbstorages](#)  
Use the `odacli list-dbstorages` command to display a list of all of the database storage configured in the appliance.
- [odacli describe-dbstorage](#)  
Use the `odacli describe-dbstorage` command to display storage configuration details.
- [odacli create-dbstorage](#)  
Use the `odacli create-dbstorage` command to create the file system for database migrations.
- [odacli delete-dbstorage](#)  
Use the `odacli delete-dbstorage` command to delete database storage that is not associated with a database.
- [odacli describe-dgstorage](#)  
Use the `odacli describe-dgstorages` command to display the disk group information.
- [odacli list-dgstorages](#)  
Use the `odacli list-dgstorages` command to display the disk group information.



## odacli list-dbstorages

Use the `odacli list-dbstorages` command to display a list of all of the database storage configured in the appliance.

### File Path

```
$ORACLE_HOME/opt/oracle/dcs/bin/odacli
```

### Syntax

```
# odacli list-dbstorages [-h]
```

### Parameters

Parameter	Description
<code>--help, -h</code>	(Optional) Displays help for using the command.

### Usage Notes

This command displays a list of all of the filesystems that are configured with the `create-database` command and the `create-dbstorage` command.

### Example 13-89 Displaying a List of all Database Storage

```
# odacli list-dbstorages
```

ID	Type	DBUnique	Name	Status
9fe39332-cc1a-4b4b-8393-165524a6ef6b	Acfs		rdb121a	Configured
4f2a1b59-ca66-4d80-951c-425ab7b0acae	Asm		ee12db	Configured
0266edac-c729-4539-861f-3f3d543be9e4	Acfs		db12SE	Configured

## odacli describe-dbstorage

Use the `odacli describe-dbstorage` command to display storage configuration details.

### File Path

```
$ORACLE_HOME/opt/oracle/dcs/bin/odacli
```

### Syntax

```
odacli describe-dbstorage -i [-j] [-h]
```

## Parameters

Parameter	Description
--id, -i	Identifies the database storage.
--json, -j	(Optional) Displays JSON output. The default is false.
--help, -h	(Optional) Displays help for using the command.

## Usage Notes

- Use the `odacli list-dbstorages` command to get the database storage identifier (ID).
- The DATA Location corresponds to the `init.ora` parameter `db_create_file_dest`.
- RECO Location corresponds to the `init.ora` parameter `db_recovery_file_dest`
- REDO Location corresponds to the `init.ora` parameter `db_create_online_log_dest_1`

### Example 13-90 Displaying Database Oracle ACFS Storage Details

The following example displays Oracle ASM Cluster file system (ACFS) storage details:

```
# odacli describe-dbstorage -i 9fe39332-cc1a-4b4b-8393-165524a6ef6b

DBStorage details
-----
ID: 9fe39332-cc1a-4b4b-8393-165524a6ef6b
DB Name: rdb121a
DBUnique Name: rdb121a
DB Resource ID: ad6c7326-e460-411e-94df-230dedbef743
Storage Type: Acfs
DATA Location: /u02/app/oracle/oradata/rdb121a
RECO Location: /u03/app/oracle/fast_recovery_area/
REDO Location: /u03/app/oracle/redo/
State: ResourceState(status=Configured)
Created: July 22, 2016 12:07:12 PM SGT
UpdatedTime: July 22, 2016 12:26:39 PM SGT
```

### Example 13-91 Displaying Database Oracle ASM Storage Details

The following example displays Oracle Automatic Storage Management (Oracle ASM) storage details:

```
# odacli describe-dbstorage -i 4f2a1b59-ca66-4d80-951c-425ab7b0acae

DBStorage details
-----
ID: 4f2a1b59-ca66-4d80-951c-425ab7b0acae
```

```

DB Name: ee12db
DBUnique Name: ee12db
DB Resource ID: fb4d02f3-2413-47ca-8584-a768e23ec2e7
Storage Type: Asm
DATA Location: DATA
RECO Location: RECO
REDO Location: RECO
State: ResourceState(status=Configured)
Created: July 22, 2016 1:13:51 PM SGT
UpdatedTime: July 22, 2016 1:13:52 PM SGT

```

## odacli create-dbstorage

Use the `odacli create-dbstorage` command to create the file system for database migrations.

### File Path

```
$ORACLE_HOME/opt/oracle/dcs/bin/odacli
```

### Syntax

```
odacli create-dbstorage -n dbname -s dataSize -u databaseUniqueName -r
[ASM|ACFS] [-h]
```

### Parameters

Parameter	Description
<code>--dbname, -n</code>	Defines the name of the database.
<code>--dataSize, -s</code>	(Optional) Defines the size, in gigabytes (GB), of the filesystem for storing database files and temp files. The default is: 100 GB The minimum size is 10 GB. When entering the size, do not include GB. For example, for 50 GB, use 50.
<code>--databaseUniqueName, -u</code>	(Optional) Defines a unique name for the database. Specify only if the database unique name is different than the database name. The command creates the following mount point: <code>/u02/app/oracle/oradata/db unique name</code>
<code>--dbstorage, -r [ASM ACFS]</code>	(Optional) Defines the type of database storage, either ASM or ACFS. When you select ASM, the command only creates the supporting directory structure for storing non-database files. The default is: ASM
<code>--help, -h</code>	(Optional) Displays help for using the command.

### Usage Notes

- The `odacli create-dbstorage` command registers the storage metadata with the Appliance Manager.

- Oracle Database is supported on both Oracle Automatic Storage Management (Oracle ASM) and Oracle ASM Cluster file system (ACFS). The default is Oracle ASM.
- When you create ACFS database storage, the command creates a separate ACFS file system and creates the directory structure for other database files, such as archives and online logs.
- When you create ASM database storage, the command only creates the corresponding directories for non-database files.

### Example 13-92 Creating Database Storage

The following statement creates 50 GB ACFS database storage for the APPSDB database.

```
# odacli create-dbstorage -n APPSDB -s 50 -r ACFS
{
  "jobId" : "fc6bf8fd-60c2-44f3-b8b7-efd0e9a2149f",
  "status" : "Created",
  "message" : null,
  "reports" : [ ],
  "createTimestamp" : "August 09, 2016 06:19:35 AM WSST",
  "description" : "Database storage service creation with db name:
APPSDB",
  "updatedAtTime" : "August 09, 2016 06:19:35 AM WSST"
}
```

## odacli delete-dbstorage

Use the `odacli delete-dbstorage` command to delete database storage that is not associated with a database.

### File Path

`$ORACLE_HOME/opt/oracle/dcs/bin/odacli`

### Syntax

```
odacli delete-dbstorage -i [-h]
```

### Parameters

Parameter	Description
<code>--id, -i</code>	Identifies the database storage using a database identifier (ID).
<code>--help, -h</code>	(Optional) Displays help for using the command.

### Usage Notes

- You can only use the `delete-dbstorage` when the storage is not associated with any databases.
- Use the `delete-database` command to delete an existing database.

- Use the `list-dbstorages` command to locate the identifier.

### Example 13-93 Deleting Empty Database Storage

```
# odacli delete-dbstorage -i 9fe39332-cc1a-4b4b-8393-165524a6ef6b
```

## odacli describe-dgstorage

Use the `odacli describe-dgstorages` command to display the disk group information.

### File Path

```
$ORACLE_HOME/opt/oracle/dcs/bin/odacli
```

### Syntax

```
odacli describe-dgstorage -d diskgroup -h
```

### Parameters

Parameter	Description
<code>--diskgroup, -d</code>	Specifies the disk group for which information is displayed.
<code>--help, -h</code>	(Optional) Displays help for using the command.

### Usage Notes

This command displays the storage information for all the databases backed by a disk group, for each disk group present in the system.

### Example 13-94 Displaying Disk Group Storage

```
# odacli list-dgstorages -r redundancy
Diskgroup storage details
```

```
-----
-----
```

```
Diskgroup: DATA
```

```
Redundancy: extern|normal|high|flex
```

```
Physical Free Space: wGB
```

```
Physical Total Space: xGB
```

```
Database Unique Name: rdbx
```

```

Location: /u02/app/test/test1/rdbx
Used Space: dGB (acfsutil.total -
acfsutil.freespace)
Free Space: dGB (acfsutil.freespace)

Database Unique Name: rdby

Location: +DATA/rdby
Used Space: zGB (v$asm_file.bytes)
Free Space: xGB (PhyFree/redundancy)
Physical Space:
vGB(v$asm_diskgroup.total_mb)
Physical Used : wGB (v$asm_file.space)
Physical Free :
uGB(v$asm_diskgroup.free_mb)
Physical Reserved : uGB(Lookup Table)

Diskgroup: RECO

Redundancy: normal|high|flex

Physical Free Space: wGB

Physical Total Space: xGB

Database Unique Name: rdbx

Location: /u02/app/test/

fast_recovery_area

Used Space: dGB (acfsutil.total -
acfsutil.freespace)
Free Space: dGB (acfsutil.freespace)

Database Unique Name: rdby

Location: +DATA/rdby
Used Space: zGB (v$asm_file.bytes)
Free Space: xGB (PhyFree/redundancy)
Physical Space:

```

```
vGB(v$asm_diskgroup.total_mb)
Physical Used : wGB (v$asm_file.space)
Physical Free :
uGB(v$asm_diskgroup.free_mb)
Physical Reserved : uGB(Lookup Table)
```

## odacli list-dgstorages

Use the `odacli list-dgstorages` command to display the disk group information.

### File Path

```
$ORACLE_HOME/opt/oracle/dcs/bin/odacli
```

### Syntax

```
odacli list-dgstorages -r redundancy -h
```

### Parameters

Parameter	Description
<code>--redundancy, -r</code>	Specifies the disk group redundancy.
<code>--help, -h</code>	(Optional) Displays help for using the command.

### Usage Notes

- The command displays the storage-related information for all the disk groups present in the system.
- The redundancy option is valid only for FLEX disk groups. For all disk groups that are not FLEX, logical free space is calculated using the redundancy obtained from `v$asm_diskgroup` rather than the CLI option.
- Redundancy option can take the values EXTERN | NORMAL | HIGH. Use any of these options to specify the redundancy for FLEX disk groups.
- In the example below, Physical Total Space is the total space in the disk group. (`V$ASM_DISKGROUP.total_mb`) Physical Reserved Space is the reserved space required to handle disk failures. Physical Free Space is the free space in the disk group. (`V$ASM_DISKGROUP.free_mb`) Logical Free Space is the logical free space in the disk group. (`V$ASM_DISKGROUP.free_mb / redundancy`)

This command displays the storage information for all the databases backed by a disk group, for each disk group present in the system.

### Example 13-95 Displaying Disk Group Storage

```
# odacli list-dgstorages -r redundancy
Diskgroup Redundancy Physical Total Space Physical Reserved Space
Physical Free Space Logical Free
Space
```

```

-----
-----
DATA          FLEX          xGB
yGB
          zGB          uGB

REDO          HIGH          xGB
yGB
          zGB          uGB

RECO          NORMAL        xGB
yGB
          zGB          uGB

```

## odacli Job Commands

Use the `odacli list-jobs` and `odacli describe-job` commands to display job details.

- [odacli list-jobs](#)  
Use the `odacli list-jobs` command to display a list of jobs, including the job IDs, status, and the job created date and time stamp.
- [odacli describe-job](#)  
Use the `odacli describe-job` command to display details about a specific job, including the job ID, status, tasks, and the job created date and time stamp.
- [odacli list-scheduled-executions](#)

## odacli list-jobs

Use the `odacli list-jobs` command to display a list of jobs, including the job IDs, status, and the job created date and time stamp.

### File Path

```
$ORACLE_HOME/opt/oracle/dcs/bin/odacli
```

### Syntax

To list jobs and view job details and status:

```
odacli list-jobs [-j] [-h] [-o] [-f] [-t] [-hd] [-tl] [-k] [-s]
```

### Parameters

Parameter	Description
<code>--json, -j</code>	(Optional) Displays JSON output.
<code>--help, -h</code>	(Optional) Displays help for using the command.



---

Parameter	Description
<code>--for, -o</code>	<p>(Optional) Describes a job created on a specific date. In the format YYYY-MM-DD, such as 2018-01-01 .</p> <p>Example:</p> <pre># odacli list-jobs -o 2018-08-09</pre>
<code>--from, -f</code>	<p>(Optional) Describes a job created since a specific date. In the format YYYY-MM-DD or YYYY-MM-DD HH:mm:ss, such as 2018-01-01 or 2018-01-01 01:00:00.</p> <p>Examples:</p> <pre># odacli list-jobs -f 2018-08-27 # odacli list-jobs -f "2018-08-27 03:00:00"</pre>
<code>--head, -hd</code>	<p>(Optional) Describes the maximum number of older jobs to be displayed, values can be 1 to 200.</p> <p>Example:</p> <pre>odacli list-jobs -hd 10</pre>
<code>--to, -t</code>	<p>(Optional) Describes a job created ahead of a specific date. In the format YYYY-MM-DD or YYYY-MM-DD HH:mm:ss, such as 2018-01-01 or 2018-01-01 01:00:00.</p> <p>Example:</p> <pre># odacli list-jobs -t 2018-08-07</pre>
<code>--tail, -tl</code>	<p>(Optional) Describes the maximum number of latest jobs to be displayed, values can be 1 to 200.</p> <p>Example:</p> <pre># odacli list-jobs -tl 10</pre>
<code>--keyword, -k</code>	<p>(Optional) Specifies the keyword that the job description contains.</p> <p>Example:</p> <pre># odacli list-jobs -k OraDB</pre>

---

Parameter	Description
--status, -s	(Optional) Specifies the status of the job, such as Created, Scheduled, Running, Failure, Success, InternalError. Example:  # odacli list-jobs -s Failure

### Example 13-96 Displaying a List of Jobs

To display a list of jobs:

```
# odacli list-jobs

ID                               Description                               Created
-----
a6084067-72a1-4625-bea7-efd Provisioning service creation Jun 2, 2018
10:19:23 AM

(Continued)
Status
-----
Success
```

### Example 13-97 Displaying Specified Number of Older Jobs

To display a specified number of older jobs:

```
# odacli list-jobs -hd 5
ID Description Created Status
---
643c6186-a667-43d7-847f-d756a96fa072 Create detailed Backup Report
August 5, 2018 12:36:26 AM UTC Success
f29cb82c-6150-487d-aaff-52d65f6ab972 Create recovery-pitr : time
'08/05/2018 07:16:12'
for db : igIyoz August 5, 2018 1:01:39 AM UTC Success
cfe19337-ab2f-4ef3-85b5-24601ba31be2 Create detailed Backup Report
August 5, 2018 1:17:46 AM UTC Success
3749b5e2-240e-4df5-b3c1-32d345243b25 Create detailed Backup Report
August 5, 2018 2:01:07 AM UTC Success
64828852-bb16-4f06-aca9-4bdf9fe7b6f2 Create regular-5 Backup with TAG-
id5UNjBZ8HN2FYL
for Db:igIyoz August 5, 2018 2:14:19 AM UTC Success
```

### Example 13-98 Displaying Jobs in a Date Range

To display jobs created within a time frame:

```
# ./odacli list-jobs -f 2018-08-07 -t 2018-08-08
ID Description Created Status
```

```
--- --- ---
1fc5ef97-a9db-49b2-9664-7c551bd005f4 Authentication key update for
test_user August 7, 2018 12:56:58 AM UTC Success
e24f86cf-bb2e-4ebe-84e0-da5cedb27ad4 Provisioning service creation August
7, 2018 1:00:54 AM UTC Success
7f67efd6-cce5-47b4-8dc4-fdb732491f99 CPU cores service update August 7,
2018 1:41:05 AM UTC Success
0ae9a312-bac8-43be-8a64-5a12c24c2a02 SSH keys update August 7, 2018
1:42:59 AM UTC Success
af41fdc1-87ff-46cd-bc41-26615e115ae7 SSH key delete August 7, 2018 1:44:56
AM UTC Success
79e4cbb0-b474-48ab-9e04-d3d602bc0ed2 DcsCli patching August 7, 2018
1:50:18 AM UTC Success
edd55e7d-f81f-4a10-942d-1121aef0bff3 DcsCli patching August 7, 2018
1:50:32 AM UTC Success
acc22c60-3476-4566-8faa-4d36b116eded create backup
config:aaaaaaaaaaaaaaaaaaaaaaaaaaaaaaaa August 7, 2018 2:01:46 AM UTC Success
d89efedf-9110-429a-a3b2-ccd6a53f8564 Database Home OraDB12201_home2
creation with version :12.2.0.1 August 7, 2018 2:36:05 AM UTC Success
2a5532ae-41fa-47c2-bc90-010a5f26d6b2 Database service creation with db
name: my122 August 7, 2018 3:52:38 AM UTC Success
c4e533e9-c596-478f-92db-2f11f1384075 Discover Components : all August 7,
2018 4:07:09 AM UTC Success
149e89b5-27d3-4c7c-9c03-f029ca3dd495 Discover Components : all August 7,
2018 4:08:45 AM UTC Success
21d4c37b-49ad-48dd-aldb-1f25d9288312 Database Home OraDB11204_home1
creation with version :11.2.0.4 August 7, 2018 4:19:32 AM UTC Success
b61dbbca-edc1-4a4a-9db2-82b0bdcb64e6 Database service deletion with db
name: myTestDb with id : 6400c81d-5837-480c-b4a1-7c01591ee144 August 7,
2018 4:24:50 AM UTC Success
d4a104df-5796-4e37-9173-82f0e263d642 create backup config:bkfgd August 7,
2018 4:28:54 AM UTC Success
a121d40b-f33b-47a4-8fc6-4e3b84173f44 Database service creation with db
name: my112 August 7, 2018 6:51:13 PM UTC Success
42dd661f-9ba0-4877-ace9-39d3f212c071 Discover Components : all August 7,
2018 7:12:56 PM UTC Success
2f648f5a-c9c5-42ec-adb0-98cf6497c89e Discover System Components : system
August 8, 2018 3:28:12 AM UTC Success
a5755f43-509d-4d4c-b7ef-9f99660c4de7 DB Home Patching: Home Id is
97df26b3-42f2-4189-805b-82d1b38737d0 August 8, 2018 3:52:08 AM UTC Success
79b0e697-065f-4630-a524-8d072a4e139a Database Home OraDB12102_home1
creation with version :12.1.0.2 August 8, 2018 4:34:30 AM UTC Success
112b75bc-3512-4c28-a479-3e0317eb0dc4 Database service creation with db
name: mynew121 August 8, 2018 8:02:51 AM UTC Failure
09f56fb0-1e91-4b02-a9b8-5add11a8da32 Database service creation with db
name: my121a August 8, 2018 9:13:01 AM UTC Success
5633ded9-07ea-4bf9-9533-31eb65789fe7 Database service deletion with db
name: mynew121 with id : 24be4362-16c8-476f-903a-f6f2ef59f5e4 August 8,
2018 9:24:31 AM UTC Success
458dlc45-02dc-456c-ae88-5da613faaa66 Database service creation with db
name: mynew121 August 8, 2018 9:27:31 AM UTC Success
f178f378-a9d7-4d5c-b6f5-6f62ea4e05bb Database service deletion with db
name: myTestDb with id : ef50387b-0c62-4446-b210-f8d070e2a043 August 8,
2018 9:40:43 AM UTC Success
7fab740f-a711-466a-ba6d-dd5643374c28 Database service deletion with db
```

```
name: myTestDb with id : 6632a083-558a-4eb4-8c2b-af0710179980 August 8,
2018 9:41:04 AM UTC Success
3121529d-2b9d-4bbe-bf58-996c2cf46996 Database service creation with db
name: mydss August 8, 2018 9:42:06 AM UTC Success
3d0a9261-19d7-42bb-8b92-00fcc4f8c41e Discover Components : db August 8,
2018 10:17:22 AM UTC Success
```

## odacli describe-job

Use the `odacli describe-job` command to display details about a specific job, including the job ID, status, tasks, and the job created date and time stamp.

### File Path

```
$ORACLE_HOME/opt/oracle/dcs/bin/odacli
```

### Syntax

To view a specific job, status, and tasks:

```
odacli describe-job -i jobid [-j] [-h]
```

### Parameters

Parameter	Description
<code>--jobid, -i <i>jobid</i></code>	Identifies the job. To get the job identifier (jobid), run the <code>list-jobs</code> command.
<code>--json, -j</code>	(Optional) Displays JSON output.
<code>--help, -h</code>	(Optional) Displays help for using the command.

### Example 13-99 Displaying Details for a Job

To display details of a specific job with jobid `02df22c8-c21f-4162-8265-97f7826c243a`:

```
# odacli describe-job -i 02df22c8-c21f-4162-8265-97f7826c243a
```

## odacli list-scheduled-executions

Use the command `odacli list-scheduled-executions` to display a list of jobs that were executed.

### File Path

```
$ORACLE_HOME/opt/oracle/dcs/bin/odacli
```

### Syntax

```
odacli list-scheduled-executions [-j] [-h]
```

## Parameters

Parameter	Description
--help, -h	(Optional) Displays help for using the command.
--json, -j	(Optional) Displays JSON output. The default is false.

### Example 13-100 Displaying a List of Scheduled and Executed Jobs

Display a list of scheduled tasks, the status, and the date and time that the task was executed. In the following example, three (3) scheduled tasks were executed. One task, Schedule ID 04b5750c-0d13-42cf-aba3-85416e8edafb, was executed twice.

```
# odacli list-scheduled-executions

ID                               ScheduledId
JobId
-----
9890508c-ff6d-4307-972f-7962ec390871  04b5750c-0d13-42cf-
aba3-85416e8edafb
10a33e08-695c-4d13-b970-7dc7215f3cdd
7ee1e2aa-80a8-4297-97f7-365b84bcce4d
4a9e9796-4bed-4df7-af1e-de49362dda97  04b5750c-0d13-42cf-aba3-85416e8edafb

(Continued)
Status   Executed Time
-----
Executed February 4, 2018 12:00:00 AM UTC
Executed February 4, 2018 12:00:00 AM UTC
Executed February 5, 2018 12:00:00 AM UTC
```

To learn more about a scheduled backup, run the command `odacli list-schedules`. The output displays the ID, name, description, and schedule for each task.

```
# odacli list-schedules

ID                               Name
Description
-----
d136cc72-4a80-4ab8-9f1e-120b995b2794  metastore maintenance
internal metastore maintenance
04b5750c-0d13-42cf-aba3-85416e8edafb  AgentState metastore cleanup
internal agentstateentry metastore maintenance
7ee1e2aa-80a8-4297-97f7-365b84bcce4d  backupreport maintenance
backup reports deletion

(Continued)
CronExpression                    Disabled
-----
0 0 0 1/1 * ? *                  true
0 0 0 1/1 * ? *                  false
0 0 0 1/3 * ? *                  false
```

# Log Commands

Use the `odacli log` commands to specify the options to collect and delete logs.

- [odaadmcli manage diagcollect](#)  
Use the `odaadmcli manage diagcollect` command to collect diagnostic logs for Oracle Database Appliance components.
- [odacli list-logspaceusage](#)  
Use the `odacli list-logspaceusage` command to display the log file usage.
- [odacli create-logcleanjob](#)  
Use the `odacli create-logcleanjob` command to create a job to purge log files for a specified time period.
- [odacli list-logcleanjobs](#)  
Use the `odacli list-logcleanjobs` command to list the jobs to purge log files.
- [odacli describe-logcleanjob](#)  
Use the `odacli describe-logcleanjob` command to describe a log cleanup job.
- [odacli create-auto-logclean-policy](#)  
Use the `odacli create-auto-logclean-policy` command to create a policy for a job to automatically purge log files for a specified time period when certain criteria are met.
- [odacli list-auto-logclean-policy](#)  
Use the `odacli list-auto-logclean-policy` command to list the jobs to purge log files.

## odaadmcli manage diagcollect

Use the `odaadmcli manage diagcollect` command to collect diagnostic logs for Oracle Database Appliance components.

### File Path

`$ORACLE_HOME/opt/oracle/dcs/bin/odaadmcli`

### Syntax

To collect diagnostic logs for components:

```
odaadmcli manage diagcollect [-h] [--dataMask] [--dataSanitize] [--fromTime] [--toTime] [--Components]
```

### Parameters

Parameter	Description
<code>--help, -h</code>	(Optional) Displays help for using the command.
<code>--dataMask</code>	(Optional) Masks sensitive data. The default is No.

Parameter	Description
<code>--dataSanitize</code>	(Optional) Sanitizes (redacts) sensitive data. The default is No.
<code>--fromTime</code>	(Optional) Specifies the time from when you want to collect data. The timestamp formats can be of the type: <code>mon/dd/yyyy hh:mm:ss</code> , or <code>yyyy-mm-dd hh:mm:ss</code> , or <code>yyyy-mm-ddThh:mm:ss</code> , or <code>yyyy-mm-dd</code> .
<code>--toTime</code>	(Optional) Specifies the time till when you want to collect data. The timestamp formats can be of the type: <code>mon/dd/yyyy hh:mm:ss</code> , or <code>yyyy-mm-dd hh:mm:ss</code> , or <code>yyyy-mm-ddThh:mm:ss</code> , or <code>yyyy-mm-dd</code> .
<code>--Components</code>	(Optional) Specifies the comma-separated list of components for which you want to collect data. The supported values are:  all, ips, oda, odalite, dcs, odabackup, odapatching, odadataguard, odaprovisioning, odaconfig, odasystem, odastorage, database, asm, crsclient, dbclient, dbwlm, tns, rhp, procinfo, afd, crs, cha, wls, emagent, oms, ocm, emplugins, em, acfs, install, cfgtools, os, ashhtml, ashtext, awrhtml, awrtext
<code>--verbose</code>	Displays detailed message.

### Usage Notes

The following types of sensitive information can be redacted using the `--dataMask` or the `--dataSanitize` option:

- Host names
- IP addresses
- Database names
- Tablespace names
- Service names
- Ports
- Operating System user names

For example, when the `--dataMask` option is used, all instances of a sensitive name such as a database name called "payrolldb" are replaced with "\*\*\*\*\*" in the TFA collection.

For example, when the `--dataSanitize` option is used, all instances of a sensitive name such as a database name called "payrolldb" are replaced with another string, such as "oCjIN7F8P", in the TFA collection.

**Example 13-101 Masking Sensitive Data in Log Collection**

```
# /opt/oracle/oak/bin/odaadmcli manage diagcollect --dataMask
DataMask is set as true
TFACTL command is: /opt/oracle/tfa/tfa_home/bin/tfactl
Data mask is set.
Collect data within last 12 hours as default
Please wait for several minutes for the collection to complete.
```

## odacli list-logspaceusage

Use the `odacli list-logspaceusage` command to display the log file usage.

**File Path**

```
$ORACLE_HOME/opt/oracle/dcs/bin/odacli
```

**Syntax**

To list jobs and view job details and status:

```
odacli list-logspaceusage [-c] [-h]
```

**Parameters**

Parameter	Description
<code>--components, -c</code>	Describes the list of components delimited by comma. The values can be <code>gi   database   dcs</code> . For example, <code>gi,dcs</code> .
<code>--help, -h</code>	(Optional) Displays help for using the command.

**Example 13-102 Displaying a List of Logs**

To display log file space usage for a list of components:

```
odacli list-logspaceusage
Timestamp: July 25, 2018 7:31:39 PM UTC

-----

Component      Size(MB)  Partition                               LogUsagePercentage
PartitionFreePercentage

-----
-----

dcs      477.00      /dev/mapper/VolGroupSys-LogVolOpt 0.79
81.00
```



```
gi 1863.68      /dev/mapper/VolGroupSys-LogVolU01 1.85
86.00
```

## odacli create-logcleanjob

Use the `odacli create-logcleanjob` command to create a job to purge log files for a specified time period.

### File Path

```
$ORACLE_HOME/opt/oracle/dcs/bin/odacli
```

### Syntax

To list jobs and view job details and status:

```
odacli create-logcleanjob [-h] [-c] [-o] [-u]
```

### Parameters

Parameter	Description
<code>--help, -h</code>	(Optional) Displays help for using the command.
<code>--components, -c</code>	(Optional) Specifies the list of components, separated by comma. The values are <code>gi   database   dcs</code> . For example, <code>gi, dcs</code> .
<code>--olderthan, -o</code>	(Optional) Cleans logs older than specified time interval. Default is 30 if it is not specified.
<code>--unit, -u</code>	(Optional) Unit for the <code>--olderthan</code> parameter. Default is <code>Day</code> if it is not specified.

### Example 13-103 Creating Jobs to Purge Logs

To create jobs to purge logs:

```
# odacli create-logcleanjob
Job details
-----
                ID:  e03d90b5-41dd-45e0-8b7a-1480d6d7f86f
Description:  log file cleanup
                Status:  Created
                Created:  July 25, 2018 8:06:56 PM UTC
                Message:
```

```

Task Name      Start Time End Time      Status
-----
# ./odacli describe-job -i e03d90b5-41dd-45e0-8b7a-1480d6d7f86f

Job details
-----

                ID: e03d90b5-41dd-45e0-8b7a-1480d6d7f86f
Description:    log file cleanup
Status:        Success
Created:       July 25, 2018 8:06:56 PM UTC
Message:

```

```

Task Name      Start Time      End Time      Status
-----
Clean TFA logs  July 25, 2018 8:06:56 PM UTC July 25, 2018 8:06:59 PM
UTC Success
Clean DCS logs  July 25, 2018 8:06:56 PM UTC July 25, 2018 8:06:56 PM
UTC Success

```

## odacli list-logcleanjobs

Use the `odacli list-logcleanjobs` command to list the jobs to purge log files.

### File Path

```
$ORACLE_HOME/opt/oracle/dcs/bin/odacli
```

### Syntax

To list jobs and view job details and status:

```
odacli list-logcleanjobs [-h]
```

### Parameters

Parameter	Description
--help, -h	(Optional) Displays help for using the command.

**Example 13-104 Listing Jobs to Purge Logs**

To list jobs to purge logs:

```
# odacli list-logcleanjobs
JobId    Files Deleted    Size Freed    Component    Top Path    TimeStamp
-----
-----a8ef8315-02e8-4979-
ab1f-30251818c6eb 0    0 bytes gi    /u01/app/12.2.0.1/grid July 25, 2018
7:45:10 PM UTC

e03d90b5-41dd-45e0-8b7a-1480d6d7f86f 0 0 bytes  gi    /u01/app/12.2.0.1/
grid July 25, 2018 8:06:59 PM UTC

e03d90b5-41dd-45e0-8b7a-1480d6d7f86f 0 0 bytes dcs    /opt/oracle/dcs/log
July 25, 2018 8:06:56 PM UTC
-----
```

## odacli describe-logcleanjob

Use the `odacli describe-logcleanjob` command to describe a log cleanup job.

**File Path**

```
$ORACLE_HOME/opt/oracle/dcs/bin/odacli
```

**Syntax**

To list jobs and view job details and status:

```
odacli describe-logcleanjob [-h]
```

**Parameters**

Parameter	Description
<code>--help, -h</code>	(Optional) Displays help for using the command.
<code>--jobid, -i</code>	Displays the summary of the log cleanup with the specified job ID.

**Example 13-105 Displaying Log Cleanup Jobs**

To display log cleanup jobs:

```
# odacli describe-logcleanjob -i e03d90b5-41dd-45e0-8b7a-1480d6d7f86f
JobId    Files Deleted    Size Freed    Component    Top Path    TimeStamp
-----
-----
e03d90b5-41dd-45e0-8b7a-1480d6d7f86f 0 0 bytes dcs    /opt/oracle/dcs/log
```

July 25, 2018 8:06:56 PM UTC

e03d90b5-41dd-45e0-8b7a-1480d6d7f86f 0 0 bytes gi /u01/app/12.2.0.1/grid  
July 25, 2018 8:06:59 PM UTC

## odacli create-auto-logclean-policy

Use the `odacli create-auto-logclean-policy` command to create a policy for a job to automatically purge log files for a specified time period when certain criteria are met.

### File Path

`$ORACLE_HOME/opt/oracle/dcs/bin/odacli`

### Syntax

To list jobs and view job details and status:

```
odacli create-auto-logclean-policy [-h] [-c] [-o] [-u] [-uMB] [-f] [-uPer]
```

### Parameters

Parameter	Description
<code>--help, -h</code>	(Optional) Displays help for using the command.
<code>--components, -c</code>	(Optional) Specifies the list of components, separated by comma. The values are <code>gi   database   dcs</code> . For example, <code>gi   dcs</code> .
<code>--olderthan, -o</code>	(Optional) Cleans logs older than specified time interval. Default is 30 if it is not specified.
<code>--olderThanUnit, -u</code>	(Optional) Unit for the <code>--olderthan</code> parameter. Default is <code>Day</code> if it is not specified.
<code>--freeSpaceBelowPercentage, -f</code>	Starts purge when free disk space is below the specified number of percentage of the total partition size. Valid range is 20-50. Default is 20.
<code>--usageOverMB, -uMB</code>	Starts purge when log usage is over the specified number of MB. Valid range is 10%-50% of partition size.
<code>--usageOverPercentage, -uPer</code>	Starts purge when log usage is over the specified number of percentage of total partition space. Valid range is 10-50.

### Example 13-106 Creating Automatic Jobs to Purge Logs

To create a policy for automatic jobs to purge logs:

```
# odacli create-auto-logclean-policy -c 'dcs' -o 30 -uPer 30
Component UsageOverPercentage freeSpaceBelowPercentage UsageOverMB
```

```

OlderThan  OlderThanUnit
-----
-----
dcs        30          20
0          30          Day

```

## odacli list-auto-logclean-policy

Use the `odacli list-auto-logclean-policy` command to list the jobs to purge log files.

### File Path

`$ORACLE_HOME/opt/oracle/dcs/bin/odacli`

### Syntax

To list jobs and view job details and status:

```
odacli list-auto-logclean-policy [-h] [-c]
```

### Parameters

Parameter	Description
<code>--help, -h</code>	(Optional) Displays help for using the command.
<code>--components, -c</code>	(Optional) Specifies the list of components, separated by comma. The values are <code>gi</code>   <code>database</code>   <code>dcs</code> For example, <code>gi,dcs</code> .

### Example 13-107 Listing Jobs to Purge Logs

To list jobs to purge logs:

```

# odacli list-auto-logclean-policy
Component UsageOverPercentage freeSpaceBelowPercentage UsageOverMB
OlderThan OlderThanUnit
-----
-----
gi        40          20
0        60          Day

database  40          20
0        60          Day

dcs       30          20
0        30          Day

```

## odacli Oracle Auto Service Request Commands

Use the Oracle Auto Service Request (Oracle ASR) commands to configure, update, test, and delete Oracle ASR on the system.

- [odacli configure-asr](#)
- [odacli update-asr](#)
- [odacli describe-asr](#)
- [odacli test-asr](#)
- [odacli delete-asr](#)

### odacli configure-asr

Use the `odacli configure-asr` command to configure Oracle Auto Service Request (Oracle ASR) after deploying the appliance.

#### File Path

```
$ORACLE_HOME/opt/oracle/dcs/bin/odacli
```

#### Syntax

```
odacli configure-asr -u username -a asrpassword [-r proxyserver] [-t proxyport]
[-y proxyuser] [-ppwd proxypassword] [-s snmpversion] -i[asrip] -e
[internal|external] [-j] [-h]
```

#### Parameters

Parameter	Description
<code>--asrip, -i</code>	(Optional) Identifies the external Oracle ASR Manager IP address.
<code>--asrpassword, -a</code>	Defines the My Oracle Support password associated with the user name. Use this option to specify the password interactively. When using this option, do not enter the password in the command-line.
<code>--asrtype, -e {internal   external}</code>	Defines the Oracle ASR Configuration Type. The default is internal.
<code>--help, -h</code>	(Optional) Displays help for using the command.
<code>--json, -j</code>	(Optional) Displays JSON output.
<code>--proxypassword, -ppwd</code>	(Optional) Defines the proxy user password.
<code>--proxyport, -t</code>	(Optional) Defines the proxy server port.
<code>--proxyserver, -r</code>	(Optional) Defines the Proxy Server Address.
<code>--proxyuser, -y</code>	(Optional) Defines the proxy user name needed to authenticate the proxy server.

Parameter	Description
--snmpversion, -s [V3]	(Optional) Defines Simple Network Management Protocol (SNMP) Version 3.
--username, -u	Defines the Oracle ASR user name. The user name is the My Oracle Support user name under which the server is registered.

### Usage Notes

All log files for Oracle ASR are located in the `/var/opt/asrmanager/log/` directory.

To configure an external Oracle ASR Manager, you must define the Oracle ASR Configuration Type as external (`-e external`). For example, `odacli configure-asr -e external -i 198.51.100.1`

### Example 13-108 Configuring Oracle ASR with a Proxy Server

This example configures Oracle ASR for user name `scott.tiger@example.com`. A proxy server, `www-proxy.example.com`, and port 80 are defined.

```
# odacli configure-asr -u john.smithl@example.com -a -t 80 -r www-
proxy.example.com
Asr User password:
```

Job details

```
-----
ID: d99559b6-d98d-4cb7-b44d-8577cab26667
Description: Configure ASR
Status: Created
Created: August 9, 2016 6:12:19 AM WSSST
Message:
```

```
Task Name          Start Time          End Time          Status
-----
```

### Example 13-109 Configuring an External Oracle ASR

This example configures Oracle Database Appliance to use an external Oracle ASR instance at IP address 10.20.30.40.

```
# odacli configure-asr --asrip 10.20.30.40 --asrtype External
{
  "jobId" : "ea054a2f-d18d-4253-83bc-b57434e3598e",
  "status" : "Created",
  "message" : "Please run the script '/tmp/activateExternalAssets.pl' on
the ASRManager host once the current job is successful.",
  "reports" : [ ],
  "createTimestamp" : "November 20, 2016 22:12:34 PM EST",
  "description" : "Configure ASR",
  "updatedAtTime" : "November 20, 2016 22:12:34 PM EST"
}
```

When the job completes successfully, run the `/tmp/activateExternalAssets.pl` script on the Oracle ASR Manager host.

## odacli update-asr

Use the `odacli update-asr` command to make changes to Oracle Auto Service Request (Oracle ASR) configuration details after deploying the appliance.

### File Path

`$ORACLE_HOME/opt/oracle/dcs/bin/odacli`

### Syntax

```
update-asr -u username -a asrpassword [-r proxyserver] [-t proxyport] [-y proxyuser [-ppwd proxypassword] [-s snmpversion] -i[asrip] -e [internal|external] [-j] [-h]
```

### Parameters

Parameter	Description
<code>--asrip, -i</code>	(Optional) Identifies the external Oracle ASR Manager IP address.
<code>--asrpassword, -a</code>	Defines the My Oracle Support password associated with the user name. Use this option to specify the password interactively. When using this option, do not enter the password in the command-line.
<code>--asrtype, -e [internal   external]</code>	Defines the Oracle ASR Configuration Type. The default is internal.
<code>--help, -h</code>	(Optional) Displays help for using the command.
<code>--json, -j</code>	(Optional) Displays JSON output.
<code>--proxypassword, -ppwd</code>	(Optional) Defines the proxy user password.
<code>--proxyport, -t</code>	(Optional) Defines the proxy server port.
<code>--proxyserver, -r</code>	(Optional) Defines the Proxy Server Address.
<code>--proxyuser, -y</code>	(Optional) Defines the proxy user name needed to authenticate the proxy server.
<code>--snmpversion, -s [v3]</code>	(Optional) Defines Simple Network Management Protocol (SNMP) Version 3.
<code>--username, -u</code>	Defines the Oracle ASR user name. The user name is the My Oracle Support user name under which the server is registered.

### Usage Notes

- Enter the password during Oracle ASR configuration.
- All log files for Oracle ASR are located in the `/var/opt/asrmanager/log/` directory.



- You cannot use the `update-asr` command to change the Oracle ASR type. For example, from internal to external. To change the Oracle ASR type, delete the existing configuration using the `odacli delete-asr` and then re-configure Oracle ASR using the `odacli configure-asr` command.
- To configure an external Oracle ASR Manager, you must define the Oracle ASR Configuration Type as external (`-e external`). For example, `odacli update-asr -e external -i 198.51.100.1`

### Example 13-110 Updating Oracle ASR with a New Proxy Server

This example updates Oracle ASR for user name `scott.tiger@example.com`. The password is not defined in the command-line. You are prompted to enter the password during configuration. The proxy server is updated to `www-proxy2.example.com`.

```
# odacli update-asr -u scott.tiger@example.com --asrpassword --proxyserver
www-proxy2.example.com --proxyport 80
Asr User password:
```

Job details

```
-----
ID: 79cb2baa-1644-45c5-a004-a303e3111807
Description: Update ASR
Status: Created
Updated: July 15, 2016 9:53:54 AM PST
Message:
```

Task Name	Start Time	End Time	Status
-----			

## odacli describe-asr

Use the `odacli describe-asr` command to display Oracle Auto Service Request (Oracle ASR) configuration details.

### File Path

`$ORACLE_HOME/opt/oracle/dcs/bin/odacli`

### Syntax

```
describe-asr [-h]
```

### Parameters

Parameter	Description
<code>--help, -h</code>	(Optional) Displays help for using the command.

### Example 13-111 Displaying Oracle ASR Details

```
# odacli describe-asr
```

ASR details

```

-----
ID: e841d74a-687b-4e87-9548-1baa2090d48e
Name: UserName: scott.tiger@example.com
ProvyServerName: www-proxy.example.com
ProxyPort: 80
ProxyUserName:
SnmpVersion: V3
State: N/A
Created: July 15, 2016 8:53:54 AM PST
Updated: July 15, 2016 8:53:54 AM PST

```

## odacli test-asr

Use the `odacli test-asr` command to test the Oracle Auto Service Request (Oracle ASR) configuration.

### File Path

```
$ORACLE_HOME/opt/oracle/dcs/bin/odacli
```

### Syntax

```
# odacli test-asr [-h]
```

### Parameters

Parameter	Description
--help, -h	(Optional) Displays help for using the command.

### Usage Notes

This command internally invokes the SNMP test trap by invoking `/SP/alertmgmt/rules/1 testrule=true`.

### Example 13-112 Testing the Oracle ASR Configuration

```
# odacli test-asr
```

```
Job details
```

```

-----
ID: ec6783f4-551d-4686-ab1b-22e2d9e59c98
Description: Test ASR
Status: Created
Created: July 25, 2016 9:03:15 AM SGT
Message:

```

```

Task Name          Start Time          End Time
Status
-----
-----

```

## odacli delete-asr

Use the `odacli delete-asr` command to remove the Oracle Auto Service Request (Oracle ASR) configuration from the system.

### File Path

```
$ORACLE_HOME/opt/oracle/dcs/bin/odacli
```

### Syntax

```
# odacli delete-asr [-h]
```

### Parameters

Parameter	Description
<code>--help, -h</code>	(Optional) Displays help for using the command.

### Example 13-113 Deleting Oracle ASR From the System

```
# odacli delete-asr
{
  "jobId" : "5d70bd17-ec4a-48da-8196-1364105db99d",
  "status" : "Running",
  "message" : null,
  "reports" : [ ],
  "createTimestamp" : 1469409622451,
  "description" : "Delete ASR",
  "updatedAtTime" : 1469409622458
}
```

## odacli OS Commands

Use the `odacli OS` commands to list and update operating system (OS) parameters.

- [odacli list-osconfigurations](#)  
Use the command `odacli list-osconfigurations` to display the current HugePage and memlock values and view suggested values based on the total available space.
- [odacli update-osconfigurations](#)  
Use the command `odacli update-osconfigurations` to update the HugePage and memlock values.

## odacli list-osconfigurations

Use the command `odacli list-osconfigurations` to display the current HugePage and memlock values and view suggested values based on the total available space.

### File Path

```
$ORACLE_HOME/opt/oracle/dcs/bin/odacli
```

### Syntax

```
odacli list-osconfigurations [-h] [-j]
```

### Parameters

Parameter	Description
<code>--help, -h</code>	(Optional) Displays help for using the command.
<code>--json, -j</code>	(Optional) Displays JSON output. The default is false.

### Usage Notes

The command displays the configured values for HugePage and memlock from the `/etc/sysctl.conf` and `/etc/security/limits.conf` files. Based on the total available space, suggested values are calculated for the parameters.

### Example 13-114 Displaying a List of Configured and Suggested Memlock and HugePage Configurations

```
# odacli list-osconfigurations
```

Parameter	User	ConfiguredValue	SuggestedValue
Memlock	grid	295971180KB	289034355KB
Memlock	oracle	295971180KB	289034355KB
HugeSpace	default	101430MB	101161MB

## odacli update-osconfigurations

Use the command `odacli update-osconfigurations` to update the HugePage and memlock values.

### File Path

```
$ORACLE_HOME/opt/oracle/dcs/bin/odacli
```

## Syntax

```
odacli update-osconfigurations [-h] [-hs] [-j] [-m]
```

## Parameters

Parameter	Description
--help, -h	(Optional) Displays help for using the command.
--hugespace, -hs	(Optional) Updates the HugePage value.
--json, -j	(Optional) Displays JSON output. The default is false.
--memlock, -m	(Optional) Updates the memlock value.

## Usage Notes

The command updates memlock in the `/etc/security/limits.conf` file and HugePage in the `/etc/sysctl.conf` file with the suggested values.

You can update memlock or hugepage. If no option is provided, then both parameters are updated to the suggested values.

### Example 13-115 Updating the HugePage and Memlock Parameters to the Suggested Values

```
odacli update-osconfigurations
{
  "jobId" : "954cf7a5-9cad-451c-8820-3140a716af26",
  "status" : "Created",
  "message" : "Successfully submitted a request to configure OS
parameters.",
  "reports" : [ ],
  "createTimestamp" : "February 06, 2018 00:03:51 AM MST",
  "resourceList" : [ ],
  "description" : "Configuring OS Parameter",
  "updatedAtTime" : "February 06, 2018 00:03:51 AM MST"
}
[root@rwsoda6s002 ~]# odacli describe-job -i
"954cf7a5-9cad-451c-8820-3140a716af26"
Job details
-----
ID: 954cf7a5-9cad-451c-8820-3140a716af26
Description: Configuring OS Parameter
Status: Success
Created: February 6, 2018 12:03:51 AM MST
Message:
Task Name          Start Time          End Time
Status
-----
Setting up memlock. February 6, 2018 12:03:51 AM MST February 6, 2018 12:03:51 AM MST
Success
Setting up HugeSpace February 6, 2018 12:03:51 AM MST February 6, 2018 12:03:51 AM MST
Success
```

# odaadmcli Hardware Monitoring Commands

Use the `hardware monitoring` commands to display hardware configurations.

- [odaadmcli show cooling](#)  
Use the `odaadmcli show cooling` command to show cooling details.
- [odaadmcli show env\\_hw](#)  
Use the `odaadmcli show env_hw` command to display information about the environment and hardware.
- [odaadmcli show fs](#)  
Use the `odaadmcli show fs` command to display filesystem details.
- [odaadmcli show memory](#)  
Use the `odaadmcli show memory` command to display memory details.
- [odaadmcli show network](#)  
Use the `odaadmcli show network` command to show network details.
- [odaadmcli show power](#)  
Use the `odaadmcli show power` command to display power supply details.
- [odaadmcli show processor](#)  
Use the `odaadmcli show processor` command to display processor details.
- [odaadmcli show server](#)  
Use the `odaadmcli show server` command to display server details.

## odaadmcli show cooling

Use the `odaadmcli show cooling` command to show cooling details.

### File Path

```
$ORACLE_HOME/opt/oracle/dcs/bin/odaadmcli
```

### Syntax

To show cooling details:

```
odaadmcli show cooling [-h]
```

### Parameters

Parameter	Description
<code>--help, -h</code>	(Optional) Displays help for using the command.

## odaadmcli show env\_hw

Use the `odaadmcli show env_hw` command to display information about the environment and hardware.

### File Path

```
$ORACLE_HOME/opt/oracle/dcs/bin/odaadmcli
```

### Syntax

To display environment and hardware details:

```
odaadmcli show env_hw [-h]
```

### Parameters

Parameter	Description
<code>--help, -h</code>	(Optional) Displays help for using the command.

### Example 13-116 Displaying Environment and Hardware Details

To display the hardware details, enter the command `odaadmcli show env_hw`. The results show a bare metal Oracle Database Appliance system.

```
# odaadmcli show env_hw  
  
BM ODA_Lite X7-2 Medium
```

## odaadmcli show fs

Use the `odaadmcli show fs` command to display filesystem details.

### File Path

```
$ORACLE_HOME/opt/oracle/dcs/bin/odaadmcli
```

### Syntax

To display filesystem details:

```
odaadmcli show fs [-h]
```

### Parameters

Parameter	Description
<code>--help, -h</code>	(Optional) Displays help for using the command.

### Example 13-117 Displaying Filesystem Details

```
# odaadmcli show fs
```

Type	Total Space	Free Space	Total DG Space	Free DG Space
ext3	30237M	7763M	-	-
ext3	484M	416M	-	-
ext3	60475M	38149M	-	-
ext3	100793M	22060M	-	-
acfs	102400M	102158M	4894016M	2418668M
acfs	102400M	100501M	4894016M	2418668M
acfs	102400M	100601M	4894016M	2418668M

(Continued)

Diskgroup	Mount Point
	/
	/boot
	/opt
	/u01
DATA	/u02/app/oracle/oradata/ACFSDB1
DATA	/u02/app/oracle/oradata/ACFSDB2
DATA	/u02/app/oracle/oradata/EE12NCDB

## odaadmcli show memory

Use the `odaadmcli show memory` command to display memory details.

### File Path

`$ORACLE_HOME/opt/oracle/dcs/bin/odaadmcli`

### Syntax

To show memory details:

```
odaadmcli show memory [-h]
```

### Parameters

Parameter	Description
<code>--help, -h</code>	(Optional) Displays help for using the command.

### Example 13-118 Display Memory Details

```
# odaadmcli show memory
```

NAME	HEALTH	HEALTH_DETAILS	PART_NO.	SERIAL_NO.
DIMM_0	OK	-	3A4K40BB1-CRC	00CE01154602EADA96
DIMM_11	OK	-	3A4K40BB1-CRC	00CE01154602EADADA
DIMM_3	OK	-	3A4K40BB1-CRC	00CE01154602EADBC7



```
DIMM_8    OK        -                3A4K40BB1-CRC        00CE01154602EADBA0
```

(Continued)

LOCATION	MANUFACTURER	MEMORY_SIZE	CURR_CLK_SPEED	ECC_Errors
P0/D0	Samsung	32 GB	2400 MHz	0
P0/D1	Samsung	32 GB	2400 MHz	0
P0/D3	Samsung	32 GB	2400 MHz	0
P0/D8	Samsung	32 GB	2400 MHz	0

## odaadmcli show network

Use the `odaadmcli show network` command to show network details.

### File Path

```
$ORACLE_HOME/opt/oracle/dcs/bin/odaadmcli
```

### Syntax

To show network details:

```
odaadmcli show network [-h]
```

### Parameters

Parameter	Description
<code>--help, -h</code>	(Optional) Displays help for using the command.

### Example 13-119 Showing Network Details

```
# odaadmcli show network
NAME           HEALTH HEALTH_DETAILS LOCATION PART_NO MANUFACTURER
MAC_ADDRESS LINK_DETECTED DIE_TEMP

Ethernet_NIC_0    OK      -                NET0      i210      INTEL
00:10:E0:DD:9D:14 no (em1) N/A

Ethernet_NIC_1    OK      -                NET1      X710/X557-AT Intel
3C:FD:FE:78:93:92 no (p2p3) N/A

Ethernet_NIC_2    OK      -                NET2      X710/X557-AT Intel
3C:FD:FE:78:93:91 yes (p2p2) N/A

Ethernet_NIC_3    OK      -                NET3      X710/X557-AT Intel
3C:FD:FE:78:93:90 yes (p2p1) N/A

Ethernet_NIC_4    OK      -                NET4      BCM57414 Broadcom
B0:26:28:3F:D8:B8 yes (p7p2) N/A

Ethernet_NIC_5    OK      -                NET5      X710/X557-AT Intel
3C:FD:FE:78:93:93 no (p2p4) N/A

Ethernet_NIC_6    OK      -                NET6      BCM57414 Broadcom
B0:26:28:3F:D8:B0 yes (p7p1) N/A
```

## odaadmcli show power

Use the `odaadmcli show power` command to display power supply details.

### File Path

```
$ORACLE_HOME/opt/oracle/dcs/bin/odaadmcli
```

### Syntax

Run this command on the master node, to display power supply details on Oracle Database Appliance High-Availability (HA) models:

```
odaadmcli show power [-h]
```

### Parameters

Parameter	Description
<code>--help, -h</code>	(Optional) Displays help for using the command.

### Example 13-120 Displaying Power Supply Details

```
# odaadmcli show power
```

NAME	HEALTH	HEALTH_DETAILS	PART_NO.	SERIAL_NO.
Power_Supply_0	OK	-	7079395	476856Z+1514CE056G

(Continued)

LOCATION	INPUT_POWER	OUTPUT_POWER	INLET_TEMP	EXHAUST_TEMP
PS0	Present	112 watts	28.000 degree C	34.938 degree C

## odaadmcli show processor

Use the `odaadmcli show processor` command to display processor details.

### File Path

```
$ORACLE_HOME/opt/oracle/dcs/bin/odaadmcli
```

### Syntax

To show processor details:

```
odaadmcli show processor [-h]
```

### Parameters

Parameter	Description
<code>--help, -h</code>	(Optional) Displays help for using the command.

**Example 13-121 Displaying Processor Details**

```
# odaadmcli show processor

NAME          HEALTH HEALTH_DETAILS PART_NO. LOCATION MODEL
CPU_0        OK      -              060F P0 (CPU 0) Intel(R) Xeon(R) CPU
E5-2630

(Continued)
MAX_CLK_SPEED TOTAL_CORES  ENABLED_CORES
2.200 GHz      10           10
```

**odaadmcli show server**

Use the `odaadmcli show server` command to display server details.

**File Path**

```
$ORACLE_HOME/opt/oracle/dcs/bin/odaadmcli
```

**Syntax**

To show server details:

```
odaadmcli show server [-h]
```

**Parameters**

Parameter	Description
<code>--help, -h</code>	(Optional) Displays help for using the command.

**Example 13-122 Displaying Server Details**

```
# odaadmcli show server

Power State : On
Open Problems : 0
Model : ORACLE SERVER X7-2
Type : Rack Mount
Part Number : 7320190
Serial Number : 1605NM10JJ
Primary OS : Not Available
ILOM Address : 10.209.8.215
ILOM MAC Address : 00:10:E0:95:98:F0
Description : Oracle Database Appliance X7-2 Small 1606NM1s02
Locator Light : Off
Actual Power Consumption : 135 watts
Ambient Temperature : 24.250 degree C
Open Problems Report : System is healthy
```

## Storage Commands

Understand the commands to perform storage operations and diagnostics.

- [odaadmcli expand storage](#)  
Use the `odaadmcli expand storage` command to expand storage.
- [odaadmcli show disk](#)  
Use the `odaadmcli show disk` command to display the status of a single disk or of all disks on the system.
- [odaadmcli show diskgroup](#)  
Use the `odaadmcli show diskgroup` command to list configured diskgroups or display a specific diskgroup configuration.
- [odaadmcli show controller](#)  
Use the `odaadmcli show controller` command to display details of the controller.
- [odaadmcli show raidsyncstatus](#)  
Use the `odaadmcli show raidsyncstatus` command to display the RAID SYNC status.
- [odaadmcli show storage](#)  
Use the `odaadmcli show storage` command to show the storage controllers, expanders, and disks.
- [odaadmcli stordiag](#)  
Use the `odaadmcli stordiag` command to collect detailed information for each disk or NVMe.
- [odaadmcli power disk](#)  
Use the `odaadmcli power disk` command to power a disk on or off.
- [odacli validate-storagetopology](#)  
Use the `odacli validate-storagetopology` command to check the cable connections between the system controllers and the storage shelf, as well as the cable connection to the storage expansion shelf (if one is installed).

### odaadmcli expand storage

Use the `odaadmcli expand storage` command to expand storage.

#### File Path

```
ORACLE_HOME/opt/oracle/dcs/bin/odaadmcli
```

#### Syntax

```
odaadmcli expand storage -ndisk number of disks to be added -  
enclosure {0/1} [-h]
```

## Parameters

Parameter	Description
<code>--enclosure {0 1}</code>	Defines the JBOD or shelf number. The base storage shelf is 0. The storage expansion shelf is 1.  This option is only available for multi-node platforms. It is not supported on Oracle Database Appliance single node platforms.
<code>--help, -h</code>	(Optional) Displays help for using the command.
<code>-ndisk</code>	Defines the number of disks to be added in the enclosure.

## Usage Notes

On high-availability (HA) Oracle Database Appliance hardware models, run the command only on the master node.

Various storage options are available. On multi-node platforms, the base storage is SSD and you can choose to add either SSD or HDD disks. When adding a storage expansion shelf, all disks must be the same type (you cannot combine SSD and HDD disks).

### Note:

In addition to reviewing the `expand storage` command, it is important to follow the procedures for adding storage. Cabling validation and disk placement is important. In some cases, you must move disks to different slots to successfully expand storage.

## odaadmcli show disk

Use the `odaadmcli show disk` command to display the status of a single disk or of all disks on the system.

### File Path

```
$ORACLE_HOME/opt/oracle/dcs/bin/odaadmcli
```

### Syntax

To display the status of all disks on the system:

```
odaadmcli show disk [-h]
```

To display the status of a single disk:

```
odaadmcli show disk disk_name [-h]
```

**Parameters**

Parameter	Description
<i>disk_name</i>	(Optional) Define the disk resource name. The resource name format is <code>pd_[0..3]</code> .
<code>--help, -h</code>	(Optional) Displays help for using the command.

**Example 13-123 Displaying the Status of All Disks**

To display the status of all the disks on the system:

```
# odaadmcli show disk
NAME          PATH          TYPE      STATE      STATE_DETAILS
pd_00        /dev/nvme0n1 NVD       ONLINE     Good
pd_01        /dev/nvme1n1 NVD       ONLINE     Good
```

**Example 13-124 Displaying the Status of a Single Disk**

To display the status of a disk named `pd_00`:

```
# odaadmcli show disk pd_00

The Resource is : pd_00
ActionTimeout : 1500
ActivePath : /dev/nvme0n1
  AsmDiskList : |data_00||reco_00|
AutoDiscovery : 1
AutoDiscoveryHi : |data:80:NVD||reco:20:NVD|
CheckInterval : 300
ColNum : 0
CriticalWarning : 0
DependListOpr : add
  Dependency : |0|
DiskId : 360025380144d5332
DiskType : NVD
Enabled : 1
ExpNum : 19
HbaPortNum : 10
IState : 0
Initialized : 0
IsConfigDepende : false
  ModelNum : MS1PC2DD3ORA3.2T
  MonitorFlag : 1
MultiPathList : |/dev/nvme0n1|
Name : pd_00
NewPartAddr : 0
OSUserType : |userType:Multiuser|
PlatformName : X7_1_LITE_S
PrevState : Invalid
PrevUsrDevName :
SectorSize : 512
SerialNum : S2LHNAAH000001
```

```

Size : 3200631791616
SlotNum : 0
SmartDiskWarnin : 0
SmartTemperatur : 37
State : Online
StateChangeTs : 1465263789
StateDetails : Good
TotalSectors : 6251233968
TypeName : 0
UsrDevName : NVD_S00_S2LHNAAH101026
VendorName : Samsung
gid : 0
  mode : 660
uid : 0

```

## odaadmcli show diskgroup

Use the `odaadmcli show diskgroup` command to list configured diskgroups or display a specific diskgroup configuration.

### File Path

```
$ORACLE_HOME/opt/oracle/dcs/bin/odaadmcli
```

### Syntax

To list configured diskgroups:

```
odaadmcli show diskgroup [-h]
```

To display DATA configurations:

```
odaadmcli show diskgroup [DATA] [-h]
```

To display RECO configurations:

```
odaadmcli show diskgroup [RECO] [-h]
```

### Parameters

Parameter	Description
DATA	(Optional) Displays the DATA diskgroup configurations.
RECO	(Optional) Displays the RECO diskgroup configurations.
--help, -h	(Optional) Displays help for using the command.

### Example 13-125 Listing All Diskgroups

```
# odaadmcli show diskgroup
```

```

DiskGroups
-----

```

```
DATA
RECO
```

### Example 13-126 Displaying DATA Configurations

```
# odaadmcli show diskgroup DATA

ASM_DISK  PATH                                DISK  STATE  STATE_DETAILS
data_00   /dev/NVD_S00_S2LHNAAH101026p1  pd_00 ONLINE Good
data_01   /dev/NVD_S01_S2LHNAAH101008p1  pd_01 ONLINE Good
```

## odaadmcli show controller

Use the `odaadmcli show controller` command to display details of the controller.

### File Path

```
$ORACLE_HOME/opt/oracle/dcs/bin/odaadmcli
```

### Syntax

To display details of the controller:

```
odaadmcli show controller id [-h]
```

### Parameters

Parameter	Description
<code>controller_id, <i>id</i></code>	Defines the controller.
<code>--help, -h</code>	(Optional) Displays help for using the command.

### Example 13-127 Showing Controller Details

```
# odaadmcli show controller 1
Controller [1] information:
sun-controller-id = nvme:1b:00.00
sun-id = nvme:1b:00.00
sun-controller-manufacturer = Samsung
pci-vendor-id = 0x0000144d
sun-controller-model = 0xa821
pci-device-id = 0x0000a821
sun-controller-type = NVMe
sun-card-manufacturer = Sun Microsystems
pci-subvendor-id = 0x0000108e
sun-card-model = 0xa803
pci-subdevice-id = 0x0000a803
pci-address = 1b:00.0
sun-version-firmware = KPYA7R3Q
sun-serial-number = S2LHNAAH101008
sun-product-name = MS1PC2DD3ORA3.2T
```



```
pci-slot-number = 11
nvme-power-control = 1
sun-nac-name = /SYS/DBP/NVME1
```

## odaadmcli show raidsyncstatus

Use the `odaadmcli show raidsyncstatus` command to display the RAID SYNC status.

### File Path

```
$ORACLE_HOME/opt/oracle/dcs/bin/odaadmcli
```

### Syntax

To display the status of RAID SYNC:

```
odaadmcli show raidsyncstatus [-h]
```

### Parameters

Parameter	Description
<code>--help, -h</code>	(Optional) Displays help for using the command.

### Example 13-128 Displaying the RAID SYNC Status

To display the RAID SYNC details and status:

```
# odaadmcli show raidsyncstatus

Raid Type  Raid Device  Raid Status  maintainPdFailHistory  Rebuildrate
H/W Raid   /dev/sda    Optimal      ON                       30%
```

## odaadmcli show storage

Use the `odaadmcli show storage` command to show the storage controllers, expanders, and disks.

### File Path

```
$ORACLE_HOME/opt/oracle/dcs/bin/odaadmcli
```

### Syntax

To display the storage controllers, expanders, and disks:

```
odaadmcli show storage [-h]
```

To show storage errors:

```
odaadmcli show storage -errors [-h]
```

## Parameters

Parameter	Description
--errors	(Optional) Shows storage errors.
--help, -h	(Optional) Displays help for using the command.

### Example 13-129 Displaying Storage Devices

The following example displays details about the storage devices on an appliance.

```
# odaadmcli show storage

==== BEGIN STORAGE DUMP =====
Host Description: Oracle Corporation:ORACLE SERVER X6-2
Total number of controllers: 2
  Id = 0
  Pci Slot = 10
  Serial Num = S2LHNAAH101026
  Vendor = Samsung
  Model = MS1PC2DD3ORA3.2T
  FwVers = KPYA7R3Q
  strId = nvme:19:00.00
  Pci Address = 19:00.0

  Id = 1
  Pci Slot = 11
  Serial Num = S2LHNAAH101008
  Vendor = Samsung
  Model = MS1PC2DD3ORA3.2T
  FwVers = KPYA7R3Q
  strId = nvme:1b:00.00
  Pci Address = 1b:00.0

Total number of expanders: 0
Total number of PDs: 2
  /dev/nvme0n1 Samsung NVD 3200gb slot: 0 pci : 19
  /dev/nvme1n1 Samsung NVD 3200gb slot: 1 pci : 1

==== END STORAGE DUMP =====
```

## odaadmcli stordiag

Use the `odaadmcli stordiag` command to collect detailed information for each disk or NVMe.

### File Path

```
$ORACLE_HOME/opt/oracle/dcs/bin/odaadmcli
```

**Syntax**

To collect storage diagnostics for disks and NVMe Express (NVMe):

```
odaadmcli stordiag n [-h]
```

**Parameters**

Parameter	Description
-n <i>disk_name</i>	Defines the disk resource name. The resource name format is <code>pd_[0..3]</code> .
--help, -h	(Optional) Displays help for using the command.

**Example 13-130 Displaying NVMe Details**

To display detailed information for NVMe `pd_00`:

```
# odaadmcli stordiag pd_00
```

## odaadmcli power disk

Use the `odaadmcli power disk` command to power a disk on or off.

**File Path**

```
$ORACLE_HOME/opt/oracle/dcs/bin/odaadmcli
```

**Syntax**

To power a disk on or off:

```
odaadmcli power disk {on|off|status} disk_name [-h]
```

**Parameters**

Parameter	Description
<i>disk_name</i>	Defines the disk resource name. The resource name format is <code>pd_[0..3]</code> .
{on off status}	Power on a disk, power off a disk, display status.
--help, -h	(Optional) Displays help for using the command.

**Example 13-131 Powering a Disk Off**

This example shows how to power off a disk.

```
# odaadmcli power disk off pd_00
Disk 'pd_00' is already part of ASM

Are you sure you want to power OFF the disk?: 'pd_00'?
[yes/no]:
```

```
yes  
Powered OFF pd_00
```

### Example 13-132 Checking the Disk Status

This example shows how to get the status of disk pd\_00.

```
# odaadmcli power disk status pd_00  
The disk is powered ON
```

## odacli validate-storagetopology

Use the `odacli validate-storagetopology` command to check the cable connections between the system controllers and the storage shelf, as well as the cable connection to the storage expansion shelf (if one is installed).

Oracle recommends that you run the `odacli validate-storagetopology` command before deploying the system to ensure that the cabling is correct. This will avoid and prevent problems during deployment due to incorrect or missing cable connections. If the cabling is not correct, you will see errors in your output.

### File Path

```
$ORACLE_HOME/opt/oracle/dcs/bin/odacli
```

### Syntax

```
odacli validate-storagetopology [-h]
```

### Parameters

Parameter	Description
<code>--help, -h</code>	(Optional) Displays help for using the command.

# Oracle Appliance Manager Command-Line Interface for Virtualization

Oracle Appliance Manager Command-Line Interface (OAKCLI) is a command-line interface (CLI) for Oracle VM Server (Xen hypervisor technology virtualization) on Oracle Database Appliance virtualized platform. Only use the `oakcli` commands on an Oracle Database Appliance virtualized platform.

- [About the Oracle Appliance Manager Command-line Interface \(OAKCLI\)](#)  
The `oakcli` commands are the primary method for performing database and system administration on Oracle Database Appliance, and on Oracle Database Appliance Virtualized Platform.
- [Managing OAKCLI Privileges and Security with SUDO](#)  
Oracle Appliance Manager command-line utility requires `root` system privileges for most administration actions. You may want to use SUDO as part of your system auditing and security policy.
- [oakcli add disk -local](#)  
Use the `oakcli add disk -local` command to add a local disk to the system after physically replacing a failed disk.
- [oakcli configure commands](#)  
Use the `oakcli configure` commands to configure components on Oracle Database Appliance.
- [oakcli copy](#)  
Use the `oakcli copy` command to prepare a copy of the configuration file for use during the configuration of Oracle Database Appliance.
- [oakcli create commands](#)  
Use the `oakcli create` commands to create components on Oracle Database Appliance.
- [oakcli delete commands](#)  
Use the `oakcli delete` commands to delete components from Oracle Database Appliance.
- [oakcli deploy](#)  
Use the command `oakcli deploy` to deploy Oracle Grid Infrastructure for a cluster on Oracle Database Appliance.
- [oakcli expand storage](#)  
Use the `oakcli expand storage` command to configure the solid-state drives (SSDs) for data storage into the existing base configuration to fully populate the base storage shelf.
- [oakcli diskwritecache](#)  
Use the `oakcli diskwritecache` command to locate disks with write cache enabled and to disable disk write cache for those disks.

- [oakcli locate disk](#)  
Use the `oakcli locate disk` command to locate the physical disk that is associated with a named Oracle ASM disk by turning the disk's LED light on or off.
- [oakcli manage diagcollect](#)  
Use the `oakcli manage diagcollect` command to collect diagnostic information about Oracle Database Appliance for troubleshooting purposes, and for working with Oracle Support Services.
- [oakcli describe-system](#)  
Use the `oakcli describe-system` command to display details about components installed on the system.
- [oakcli modify database](#)  
Use the `oakcli modify database` command to modify the database type or size class for a named database.
- [oakcli orachk](#)  
Use the `oakcli orachk` command to audit configuration settings with the ORAchk utility.
- [oakcli reconfigure osparams](#)  
Use the `oakcli reconfigure osparams` command to adjust the kernel parameters based on the available RAM after you upgrade memory or DIMM.
- [oakcli resize dbstorage](#)  
Use the `oakcli resize dbstorage` command to resize the space used for a storage structure that was created for the purpose of migrating databases from Oracle ASM to Oracle ACFS.
- [oakcli restart oda\\_base](#)  
Use the `oakcli restart oda_base` command to stop and restart ODA\_BASE on the local node.
- [oakcli show commands](#)  
Use the `oakcli show commands` to display the status of Oracle Database Appliance components.
- [oakcli start commands](#)  
Use the `oakcli start commands` to start a virtual machine, to start a shared repository on a node, or to start ODA\_BASE on the local node.
- [oakcli stop command](#)  
Use the `oakcli stop command` to stop a virtual machine, to stop a shared repository on a node, or to stop ODA\_BASE on the local node.
- [oakcli stordiag](#)  
Use the `oakcli stordiag` command to run diagnostic tests on a disk in the storage shelf or storage expansion shelf.
- [oakcli test asr](#)  
Use the `oakcli test asr` command to send a test trap to determine if Oracle Auto Service Request (Oracle ASR) is configured and working correctly.
- [oakcli unpack](#)  
Use the `oakcli unpack` command to unpack packages into the Oracle Appliance Manager repository.
- [oakcli update](#)  
Use the `oakcli update` command to apply Oracle Database Appliance patches.

- [oakcli update-cpucore](#)  
Use the `oakcli update-cpucore` command to enable a specified number of licensed CPU cores for Oracle Database Appliance.
- [oakcli upgrade](#)  
Use the `oakcli upgrade` command to upgrade the Oracle Database software on Oracle Database Appliance.
- [oakcli validate](#)  
Validates the state of an Oracle Database Appliance or the viability of an operating system patch.
- [oakcli Virtual Disk Commands](#)  
Use the `oakcli virtual disk (vdisk)` commands to manage virtual disks on Oracle Database Appliance virtualized platform.
- [oakcli Virtual Machine Commands](#)  
Use the `oakcli virtual machine` commands to list and manage virtual machines (VMs).
- [oakcli Virtual Machine Template Commands](#)  
Use the `oakcli Virtual Machine template` commands to list and manage virtual machine (VM) templates.
- [oakcli VLAN Management Commands for Virtual Platform](#)  
Use the `oakcli VLAN` commands to list and manage virtual local area networks (VLANs) on an Oracle Database Appliance virtualized platform.

## About the Oracle Appliance Manager Command-line Interface (OAKCLI)

The `oakcli` commands are the primary method for performing database and system administration on Oracle Database Appliance, and on Oracle Database Appliance Virtualized Platform.

You can perform the following tasks with OAKCLI commands:

- List the hardware components
- Validate and diagnose the hardware components
- Install and upgrade software
- Apply software patches
- Create and drop databases
- Install and uninstall Oracle Homes
- Deploy and manage virtual machines
- Test Oracle Auto Service Request (Oracle ASR)
- Enable CPU cores

Depending on your version of Oracle Appliance Manager and your hardware, some of the OAKCLI commands may not be available to you. To see which OAKCLI commands are supported on your version of Oracle Appliance Manager and your hardware, run the help command for OAKCLI: `oakcli -h`

## OAKCLI Command Location and Path Configuration

The Oracle Appliance Manager command-line interface is in the following directory:

```
/opt/oracle/oak/bin/oakcli
```

Configure the `root` user account on your Oracle Database Appliance servers to have the `PATH` variable defined to search for `oakcli` commands in the path `/opt/oracle/oak/bin/oakcli`.

## OAKCLI Syntax

Oracle Appliance Manager command-line interface commands and parameters are case-insensitive.

An `oakcli` command uses the following command syntax:

```
oakcli command object [options]
```

- *command* is an action you want to perform on the appliance. For example: `show`, `locate`, `apply`.
- *object* is the target or object on which the `oakcli` command performs the operation. For example, you issue a command to create or configure a disk, or a controller, or perform other system or software administration. You can also use object abbreviations.
- *options* are optional parts of the `oakcli` command. Options can consist of one or more options that extend the use of the `oakcli` command carried out on an object. Options include additional information about the action that you want to perform on the object. Option names are preceded with a dash. Many options require the name of an object for the command to perform the action that you want to carry out. The help option (`-h`) is an option that is available with every command. When you include the `-h` option, you can obtain additional information about the command that you want to perform.

## Oracle Appliance Manager Command-Line Interface Help

Run the following command to see the usage information for all `oakcli` commands available for your Oracle Database Appliance:

```
oakcli -h
```

Run the following command to see detailed help about a specific `oakcli` command:

```
oakcli command -h
```

Run the following command to see detailed help about a specific `oakcli` command carried out on an object, and the options that are available for you to use with that object.

```
oakcli command object -h
```



# Managing OAKCLI Privileges and Security with SUDO

Oracle Appliance Manager command-line utility requires `root` system privileges for most administration actions. You may want to use SUDO as part of your system auditing and security policy.

For most tasks, Oracle recommends that you log in as `root` to use the Oracle Appliance Manager command-line interface on Oracle Database Appliance. If you are not logged in as `root`, then you cannot carry out most actions on the appliance. For example, if you are not logged in as `root`, then you can view storage information, but you cannot modify the storage.

## Allowing Root User Access Using SUDO

In environments where system administration is handled by a different group than database administration, or where security is a significant concern, you may want to limit access to the `root` user account and password. SUDO enables system administrators to grant certain users (or groups of users) the ability to run commands as `root`, while logging all commands and arguments as part of your security and compliance protocol.

A SUDO security policy is configured by using the file `/etc/sudoers`. Within the `sudoers` file, you can configure groups of users and sets of commands to simplify and audit server administration with SUDO commands.

### Caution:

Configuring SUDO to allow a user to perform any operation is equivalent to giving that user `root` privileges. Consider carefully if this is appropriate for your security needs.

## SUDO Example 1: Allow a User to Perform Any OAKCLI Operation

This example shows how to configure SUDO to enable a user to perform any OAKCLI operation. You do this by adding lines to the commands section in the `/etc/sudoers` file:

```
## The commands section may have other options added to it.
##
Cmd_Alias OAKCLI_CMDS=/opt/oracle/oak/bin/oakcli *
jdoe ALL = OAKCLI_CMDS
```

In this example, the user name is `jdoe`. The file parameter setting `ALL= OAKCLI_CMDS` grants the user `jdoe` permission to run all `oakcli` commands that are defined by the command alias `OAKCLI_CMDS`. After configuration, you can copy one `sudoers` file to multiple hosts. You can also create different rules on each host.

 **Note:**

Before database creation, you must set up user equivalency with SSH for the root user on each server. If you do not set up user equivalency and configure SSH on each server, then you are prompted to provide the root password for each server during database creation.

After you configure the `sudoer` file with the user, the user `jdoe` can run the set of `oakcli` commands configured with the command alias `OAKCLI_CMDS`. For example:

```
$ sudo oakcli create database -db newdb

INFO: 2015-08-05 14:40:55: Look at the logfile '/opt/oracle/oak/log/
scaoda1011/tools/12.1.2.4.0/createdb_newdb_91715.log' for more details

INFO: 2015-08-05 14:40:59: Database parameter file is not provided. Will
be using default parameters for DB creation
Please enter the 'SYSASM' password:
Please re-enter the 'SYSASM' password:

INFO: 2015-08-05 14:41:10: Installing a new home: OraDb12102_home3
at /u01/app/oracle/product/12.1.0.2/dbhome_3

Please select one of the following for Database type [1 .. 3]:
1    => OLTP
2    => DSS
3    => In-Memory
```

**SUDO Example 2: Allow a User to Perform Only Selected OAKCLI Operations**

To configure SUDO to allow a user to perform only selected OAKCLI operations, add lines to the commands section in the `/etc/sudoers` file as follows:

```
## oakcli commands
Cmdnd_Alias OAKENV = /opt/oracle/oak/bin/oakcli show env_hw
Cmdnd_Alias OAKVER = /opt/oracle/oak/bin/oakcli show version
oracle ALL= OAKENV,OAKVER
```

The following are sample outputs for the commands:

```
$ sudo /opt/oracle/oak/bin/oakcli show env_hw
VM-ODA_BASE ODA X6-2-HA

$ sudo /opt/oracle/oak/bin/oakcli show version
Version
-----
12.2.1.2.0
```

In this example, the user `jdoe2` tries to run the `oakcli show databases` command, which is not part of the set of commands that is configured for that user. Sudo prevents `jdoe2` from running the command.

```
$ sudo /opt/oracle/oak/bin/oakcli show databases
Sorry, user oracle is not allowed to execute '/opt/oracle/oak/bin/oakcli
show databases' as root on servernode1.
```

#### See Also:

The SUDO man pages for more information about configuring and using SUDO:

<http://www.sudo.ws/sudo.html>

## oakcli add disk -local

Use the `oakcli add disk -local` command to add a local disk to the system after physically replacing a failed disk.

### Syntax

```
oakcli add disk -local
```

### Usage Notes

- You cannot add more than two disks per node.
- You must remove the failed drive and replace it with a new drive before running the `oakcli add disk -local` command.
- The new disk must be inserted into the slot before you run this command.
- The `oakcli add disk -local` command is supported only on bare metal deployments. It is not supported on virtualized configurations.

## oakcli configure commands

Use the `oakcli configure` commands to configure components on Oracle Database Appliance.

- [oakcli configure additionalnet](#)  
Use the `oakcli configure additionalnet` command to configure any unconfigured public networks in bare metal, Domain 0, and ODA\_BASE.
- [oakcli configure asr](#)  
Use the `oakcli configure asr` command to configure Oracle Auto Service Request (Oracle ASR) on Oracle Database Appliance.
- [oakcli configure cpupool](#)  
Use the `oakcli configure cpupool` command to configure a CPU pool on one Oracle Database Appliance Virtualized Platform node.

- [oakcli configure firstnet](#)  
Use the `oakcli configure firstnet` command to configure an initial network on Oracle Database Appliance that enables you to download deployment software.
- [oakcli configure network](#)  
Use the `oakcli configure network` command to configure the network after either replacing a network card or swapping the public network from copper to fiber and vice versa. The meaning of the command changes depending on which parameter you use.
- [oakcli configure oda\\_base](#)  
Use the `oakcli configure oda_base` command to change the CPU core count assigned to ODA\_BASE, add or remove virtual local area networks assigned to ODA\_BASE, and adjust resource allocation among user domains and between ODA\_BASE and other user domains.
- [oakcli configure repo](#)  
Use the `oakcli configure repo` command to increase the size of a shared repository.

## oakcli configure additionalnet

Use the `oakcli configure additionalnet` command to configure any unconfigured public networks in bare metal, Domain 0, and ODA\_BASE.

### Syntax

```
oakcli configure additionalnet [-h]
```

### Parameter

`-h` displays online help for using the command.

### Usage Notes

The `oakcli configure additionalnet` command automatically detects any unconfigured networks and runs an interactive script that guides you through how to configure the network. The script requires the following input:

- Interface name
- DHCP [Y/N]
- IP
- Netmask

#### Note:

If you are running the command on a bare metal deployment, then the interface name expects a bond name. If you are running the command on Dom0, then the interface name expects a net name. If you are running the command on Dom1, then the interface name expects an eth name.

## Related Topics

- [Configuring Additional Networks on Virtualized Platform](#)  
Use the `oakcli configure additionalnet` command to create additional networks.

## oakcli configure asr

Use the `oakcli configure asr` command to configure Oracle Auto Service Request (Oracle ASR) on Oracle Database Appliance.

### Syntax

```
oakcli configure asr [-h]
```

### Parameter

`-h` displays help for using the command.

### Usage Notes

- The `oakcli configure asr` command initiates an interactive script that requests the following information to implement Oracle ASR on Oracle Database Appliance:
  - Action to be performed (setup internal, setup external, deinstall, or reconfigure Oracle ASR Manager)
  - PROXY server name, port, user ID, and password
  - Oracle ASR user ID and password
  - Oracle ASR Manager IP and port
- You can configure Oracle ASR on Oracle Database Appliance to use its own ASR Manager (**internal Oracle ASR**) or use Oracle ASR Manager configured on another server in the same network as your appliance (**external Oracle ASR**). If you already have Oracle ASR Manager configured in your environment, you can register Oracle Database Appliance with your existing Oracle ASR Manager.

#### Note:

With an internal Oracle ASR Manager, an alert is not sent when the server goes down. If a critical event occurs on Oracle Database Appliance with an external Oracle ASR Manager, then an alert can still be sent to Oracle.

### Configuring Oracle ASR

```
# oakcli configure asr
```

```
INFO : Logging all actions in /opt/oracle/oak/onecmd/tmp/  
scaoda1011-20150805153300.log and traces in /opt/oracle/oak/onecmd/tmp/  
scaoda1011-20150805153300.trc
```

```
Please enter
```

```
1 to setup Internal ASR
```

```

2 to setup External ASR
3 to Deinstall ASR
0 to Exit

```

```

[1]:INFO : Logging all actions in /opt/oracle/oak/onecmd/tmp/
scaoda1011-20150805153300.log and traces in /opt/oracle/oak/onecmd/tmp/
scaoda1011-20150805153300.trc

```

## oakcli configure cpupool

Use the `oakcli configure cpupool` command to configure a CPU pool on one Oracle Database Appliance Virtualized Platform node.

### Syntax

```
oakcli configure cpupool poolname -numcpu cpu_count -node nodenum [-h]
```

### Parameters

Parameter	Description
<i>poolname</i>	Unique name for the CPU pool
-numcpu <i>cpu_count</i>	Number of CPUs for the CPU pool
-node <i>nodenum</i>	Node where the CPU pool will be created (0 or 1)
-h	(Optional) Display help for using the command.

### Configuring a CPU Pool

Configure a CPU pool named `twonode` with two cores on Node 1 of Oracle Database Appliance Virtualized Platform:

```
oakcli configure cpupool twonode -numcpu 2 -node 1
```

## oakcli configure firstnet

Use the `oakcli configure firstnet` command to configure an initial network on Oracle Database Appliance that enables you to download deployment software.

### Syntax

```
oakcli configure firstnet
```

### Example

The `oakcli configure firstnet` command creates an initial network on a new Oracle Database Appliance using an interactive script. The following example shows how to configure the initial network on a bare metal Oracle Database Appliance:

```

# oakcli configure firstnet
Select the interface to configure network on [bond0 bond1 bond2 xbond0]:bond0
Configure DHCP on bond0?(yes/no):no
INFO: Static configuration selected
Enter the IP address to configure:192.0.2.18
Enter the netmask address to configure:255.255.252.0

```

```

Enter the gateway address to configure:192.0.2.1
Plumbing the IPs now
Restarting the network
::::::::::::::::::

```

 **Note:**

Oracle recommends using the `oakcli configure firstnet` command only one time on Oracle Database Appliance. Subsequent use after configuring the initial network can cause unpredictable changes to your network settings.

## oakcli configure network

Use the `oakcli configure network` command to configure the network after either replacing a network card or swapping the public network from copper to fiber and vice versa. The meaning of the command changes depending on which parameter you use.

### Syntax

```
oakcli configure network [-changeNetCard|-publicNet][-h]
```

### Parameters

Parameter	Description
-changeNetCard	Configures the network card after it has been replaced. You must run the <code>oakcli configure network -changeNetCard</code> command on each node if the network card was replaced. This parameter is supported on all Oracle Database Appliance hardware models. This command must be executed from Dom0 on virtualized platforms.
-publicNet	Configures the network after you have swapped the public network from copper to fiber and vice versa. The option can be copper or fiber. You must run the <code>oakcli configure network -publicNet</code> command on each node, and this requires the stack to be down. The stack includes GI and RDBMS. If you are using Oracle Database Appliance Virtualized Platform, the virtual machines must be down. The virtual machines may need some configuration changes, especially if they are using VLANs. This parameter is supported on Oracle Database Appliance X4-2-HA, X5-2-HA non-InfiniBand network, and X6-2-HA non-InfiniBand network.
-h	(Optional) Display help for using the command.

## oakcli configure oda\_base

Use the `oakcli configure oda_base` command to change the CPU core count assigned to ODA\_BASE, add or remove virtual local area networks assigned to

ODA\_BASE, and adjust resource allocation among user domains and between ODA\_BASE and other user domains.

You must restart the domain for the resource allocation change to take effect.

### Syntax

```
oakcli configure oda_base
```

### Examples

Here are examples of how to use the `oakcli configure oda_base` command.

#### Changing the CPU Core Count in ODA\_BASE

Change the CPU core count from six to eight in ODA\_BASE:

```
# oakcli configure oda_base
Core Licensing Options:
  1. 2 CPU Cores
  2. 4 CPU Cores
  3. 6 CPU Cores
  4. 8 CPU Cores
  5. 10 CPU Cores
  6. 12 CPU Cores
Current CPU Cores      :6
Selection[1 : 6](default 12 CPU Cores) : 4
ODA base domain memory in GB(min 8, max 88)(Current Memory 64G)[default
32]      :
INFO: Using default memory size i.e. 32 GB
Additional vlan networks to be assigned to oda_base? (y/n) [n]:
Vlan network to be removed from oda_base (y/n) [n]
INFO: Node 0:Configured oda base pool
INFO: Node 1:Configured oda base pool
INFO: Node 0:ODA Base configured with new memory
INFO: Node 0:ODA Base configured with new vcpus
INFO: Changes will be incorporated after the domain is restarted on Node 0
INFO: Node 1:ODA Base configured with new memory
INFO: Node 1:ODA Base configured with new vcpus
INFO: Changes will be incorporated after the domain is restarted on Node 1
```

#### Changing the Amount of Memory Allocated to ODA\_BASE

1. Log in to Dom0.
2. Execute the `oakcli configure oda_base` command and change the configuration.
3. Restart ODA\_BASE.

#### Assigning VLANs to ODA\_BASE

1. Log in to Dom0.
2. Execute the `oakcli configure oda_base` command.
3. Change the setting for Additional vlan networks to be assigned to `oda_base? (y/n)` to **y**.
4. Follow the prompts to assign additional VLANs to ODA\_BASE.
5. Restart ODA\_BASE.



## oakcli configure repo

Use the `oakcli configure repo` command to increase the size of a shared repository.

### Syntax

```
oakcli configure repo reponame -incsize size [M|G] [-h]
```

Parameter	Description
<code>reponame</code>	Name of the shared repository
<code>size</code>	Number that can be followed by M to define the size as megabytes or by G to define as size as gigabytes
<code>-h</code>	(Optional) Display help for using the command.

### Increasing the Size of a Shared Repo

Increase the size of the `repo1` shared repository by 2 gigabytes:

```
# oakcli configure repo repo1 -incsize 2G
```

Configured Shared Repo : `repo1` with new size 3712.0.

## oakcli copy

Use the `oakcli copy` command to prepare a copy of the configuration file for use during the configuration of Oracle Database Appliance.

### Syntax

```
oakcli copy -conf absolute_conf_file [-h]
```

### Parameters

Parameter	Description
<code>-conf <i>absolute_conf_file</i></code>	Specifies the full path name of the configuration file
<code>-h</code>	(Optional) Display help for using the command.

### Example 14-1 Preparing a Copy of the Configuration File

If you created a configuration file previously and copied this file to Oracle Database Appliance, then prepare the configuration file to be used during the configuration process. For example, if you copied the file `myserver1.conf` to `/tmp`, then enter the following command:

```
oakcli copy -conf /tmp/myserver1.conf
```

## oakcli create commands

Use the `oakcli create` commands to create components on Oracle Database Appliance.

- [oakcli create cpupool](#)  
Use the command `oakcli create cpupool` to create a CPU pool on one Oracle Database Appliance Virtualized Platform node.
- [oakcli create database](#)  
Use the `oakcli create database` command to create additional databases on Oracle Database Appliance.
- [oakcli create dbhome](#)  
Use the `oakcli create dbhome` command to create a new database home on Oracle Database Appliance.
- [oakcli create dbstorage](#)  
Use the `oakcli create dbstorage` command to create a storage structure for migrating databases from Oracle ASM to Oracle ACFS.
- [oakcli create db\\_config\\_params](#)  
Use the `oakcli create db_config_params` command to generate a database configuration file.
- [oakcli create repo](#)  
Use the `oakcli create repo` command to create a new shared repository on Oracle Database Appliance Virtualized Platform.
- [oakcli create snapshotdb](#)  
Use the `oakcli create snapshotdb` command to create a snapshot database from an existing database.

## oakcli create cpupool

Use the command `oakcli create cpupool` to create a CPU pool on one Oracle Database Appliance Virtualized Platform node.

### Syntax

```
oakcli create cpupool poolname -numcpu cpu_count -node nodenum [-h]
```

### Parameters

Parameter	Description
<i>poolname</i>	Uniquely names the CPU pool
-numcpu <i>cpu_count</i>	Defines the number of CPUs for the CPU pool
-node <i>nodenum</i>	Defines the node where the CPU pool will be created (0 or 1)
-h	(Optional) Display help for using the command.

### Example

Create a CPU pool with two CPUs on Node 1 of Oracle Database Appliance Virtualized Platform:

```
oakcli create cpupool twonode -numcpu 2 -node 1
```

## oakcli create database

Use the `oakcli create database` command to create additional databases on Oracle Database Appliance.

When you run the command `oakcli create database`, the command prompts you for further inputs.

### Note:

Do not use Oracle Database Configuration Assistant (DBCA) to create databases on Oracle Database Appliance. Only use Oracle Appliance Manager for database configuration. Deploying Oracle Database instances using Oracle Appliance Manager ensures that these databases are properly configured, optimized, and supported on Oracle Database Appliance.

### File Path

`$ORACLE_HOME/directory_name`

### Syntax

```
oakcli create database -db db_name [[[-oh home] | [-version version]] [-  
params params_file] [-storage asm] [-cdb]][h]
```

### Parameters

Parameter	Description
<code>-cdb</code>	(Optional) Creates the database as a container database.
<code>-db <i>db_name</i></code>	Name of the database that you want to create.
<code>-oh <i>home</i></code>	(Optional) Name of an existing Oracle home to use when creating the database. By default, the command creates a new database home.
<code>-params <i>params_file</i></code>	(Optional) Name of the configuration file. By default, Oracle Database Appliance uses the default configuration file.
<code>-storage [ASM ACFS]</code>	(Optional) Creates an Oracle 12c database with the specified storage, either Oracle Automatic Storage Management (Oracle ASM) or Oracle Automatic Storage Management Cluster File System (Oracle ACFS). Oracle ASM storage is the default storage.
<code>-version <i>version</i></code>	(Optional) Version of the database that you want to create. By default, Oracle Database Appliance uses the highest version that you have downloaded.
<code>-h</code>	(Optional) Display help for using the command.

## Usage Notes

- Flash cache is disabled and cannot be enabled.
- The `-oh` and the `-version` parameters are mutually exclusive. Attempting to use both in the same command will generate an error.
- When a database is created without identifying an Oracle home, a new Oracle home is created using a standard naming convention (for example, OraDb11204\_home3). The number at the end of the name is incremented by one for each new home created with the same version number.
- On Oracle Database Appliance hardware models, the minimum supported Oracle Database release is 11.2.0.4. Oracle Database 11.2.0.3.x is not supported.
- When you upgrade the database, infrastructure, and Oracle Grid Infrastructure, you must specify an existing home to create a new database.
- If you try to create a database using the option `-version version` before downloading and unpacking the specific version database clone files, then the command will fail.
- You can create configuration files with the `oakcli create db_config_params` command.
- The prompt "Do you want to keep the data files on FLASH storage: [ Y | N ]" is only shown if you choose the OLTP database type and if there is some free space available on flash storage.
- Beginning with Oracle Database 12c release 1 (12.1.0.2), you can create an Oracle Database in Oracle ASM. Oracle ASM is the default storage.

## Examples

This section shows different scenarios for using the command `oakcli create database`.

### Example 14-2 Creating a New Database Showing Prompts

When you run the command `oakcli create database`, you are prompted for several inputs.

The following command creates a database named `mydb` using an existing Oracle home named `OraDb12102_home1`:

```
# oakcli create database -db DBPROD

INFO: 2017-07-25 19:21:16: Please check the logfile
'/opt/oracle/oak/log/ODADBI1/tools/12.2.1.1.0/createdb_DBPROD_29285.log'
for more details
INFO: 2017-07-25 19:21:24: Database parameter file is not provided.
Will be using default parameters for DB creation

Please enter the 'SYSASM' password:
Please re-enter the 'SYSASM' password:

INFO: 2017-07-25 19:21:35: Installing a new Home : OraDb12102_home2 at
/u01/app/oracle/product/12.1.0.2/dbhome_2
```

```

Please select one of the following for Database type [1 .. 3] :
1  => OLTP
2  => DSS
3  => In-Memory
1
The selected value is : OLTP

1 => EE : Enterprise Edition
2 => RACONE
3 => RAC1
3
Selected value is : RAC

Specify the Database Class (1. odb-01 '1 core, 8 GB memory' 2.Others)
[1]
:2

Please select one of the following for Database Class [1 .. 10]:
1  => odb-01s ( 1 cores , 4 GB memory)
2  => odb-01 ( 1 cores , 8 GB memory)
3  => odb-02 ( 2 cores , 16 GB memory)
4  => odb-04 ( 4 cores , 32 GB memory)
5  => odb-06 ( 6 cores , 48 GB memory)
6  => odb-08 ( 8 cores , 64 GB memory)
7  => odb-10 ( 10 cores , 80 GB memory)

```

**Example 14-3 Creating a New Database in an Existing Oracle Home**

Create a database called `sales1` in `OraDb11204_home2`:

```
oakcli create database -db sales1 -oh OraDb11204_home2
```

**Example 14-4 Creating a New Database from a Template**

Create a database called `sales2` from the `salesdbtemplate.bconf` file (by appending the default file extension to the file name provided). This example also creates a new Oracle home:

```
oakcli create database -db sales2 -params salesdbtemplate
```

## oakcli create dbhome

Use the `oakcli create dbhome` command to create a new database home on Oracle Database Appliance.

**Syntax**

```
oakcli create dbhome [-version version] [-h]
```

## Parameters

Parameter	Description
-version <i>version</i>	(Optional) Version that you want to install. If this is not provided, then Oracle Database Appliance uses the latest available version.
-h	(Optional) Display help for using the command.

## Creating a Database Home

Create a database home called `sales1` using Oracle Database version 12.1.0.2.4.

```
oakcli create dbhome -version 12.1.0.2.4
```

## oakcli create dbstorage

Use the `oakcli create dbstorage` command to create a storage structure for migrating databases from Oracle ASM to Oracle ACFS.

### Syntax

```
oakcli create dbstorage -db db_name [-cdb][-h]
```

### Parameters

Parameter	Description
-db <i>db_name</i>	Sets up the required Oracle ACFS storage structure for the database to be created called <i>db_name</i>
-cdb	Must be passed if you are creating a multitenant container database
-h	(Optional) Display help for using the command.

### Example

The `oakcli create dbstorage` command requests user input to determine the size of the storage structure to create, as shown in this example:

```
# oakcli create dbstorage -db sales

Please enter the 'root' password :
Please re-enter the 'root' password:

Please enter the 'oracle' password :
Please re-enter the 'oracle' password:

Please enter the 'SYSASM' password:
Please re-enter the 'SYSASM' password:

Specify the Database Class (1. odb-01 '1 core, 8 GB memory' 2. Others) [1]:2

Please select one of the following for Database Class [1 .. 8] :
1 => odb-01s ( 1 cores , 4 GB memory)
2 => odb-01 ( 1 cores , 8 GB memory)
```

```

3 => odb-02 ( 2 cores , 16 GB memory)
4 => odb-04 ( 4 cores , 32 GB memory)
5 => odb-06 ( 6 cores , 48 GB memory)
6 => odb-12 ( 12 cores , 96 GB memory)
7 => odb-16 ( 16 cores , 128 GB memory)
8 => odb-24 ( 24 cores , 192 GB memory)

```

```

Selected value is: odb-01s ( 1 cores , 4 GB memory)
...

```

## oakcli create db\_config\_params

Use the `oakcli create db_config_params` command to generate a database configuration file.

The configuration file is created in `/opt/oracle/oak/install/dbconf` and is given the default extension `.dbconf`.

### Syntax

```
oakcli create db_config_params -conf filename [-h]
```

### Parameters

Parameter	Description
<code>-conf filename</code>	Name you want to give to the configuration file, without its path name.
<code>-h</code>	(Optional) Display help for using the command

### Example

Create the database parameter file: `/opt/oracle/oak/install/dbconf/newconf.dbconf`:

```
# oakcli create db_config_params -conf newconf
```

```
Please select one of the following for Database Block Size [1 .. 4]:
```

```

1 ==> 4096
2 ==> 8192
3 ==> 16384
4 ==> 32768
2

```

```
Selected value is: 8192
```

```
Specify the Database Language (1. AMERICAN 2. Others) [1]:
```

```
Selected value is: AMERICAN
```

```
Specify the Database Characterset (1. AL32UTF8 2. Others) [1]:2
```

```
Please select one of the following for Database Characterset [0 .. 10] :
```

```

0 => Others
1 => AL32UTF8
2 => AR8ADOS710
3 => AR8ADOS710T
4 => AR8ADOS720
5 => AR8ADOS720T
6 => AR8APTEC715

```

```

7 => AR8APTEC715T
8 => AR8ARABICMACS
9 => AR8ASMO708PLUS
10 => AR8ASMO8X
1
Selected value is: AL32UTF8

Specify the Database Territory (1. AMERICA 2. Others) [1]:2

Please select one of the following for Database Territory [0 .. 10] :
0 => Others
1 => ALBANIA
2 => ALGERIA
3 => AMERICA
4 => ARGENTINA
5 => AUSTRALIA
6 => AUSTRIA
7 => AZERBAIJAN
8 => BAHRAIN
9 => BANGLADESH
10 => BELARUS
3
Selected value is: AMERICA

Specify the Component Language (1. en 2. Others) [1]:2

Please select one of the following for Component Language [0 .. 10] :
0 => Others
1 => en : English
2 => fr : French
3 => ar : Arabic
4 => bn : Bengali
5 => pt_BR : Brazilian Portuguese
6 => bg : Bulgarian
7 => fr_CA : Canadian French
8 => ca : Catalan
9 => hr : Croatian
10 => cs : Czech
1
Selected value is: en
Successfully generated the Database parameter file 'newconf'

```

## oakcli create repo

Use the `oakcli create repo` command to create a new shared repository on Oracle Database Appliance Virtualized Platform.

### Syntax

```
oakcli create repo repo_name -size size [M|G] -dg DATA|RECO [-h]
```

### Parameters

Parameter	Description
<i>repo_name</i>	Name assigned to the shared repository
-size <i>size</i> [M G]	Amount of storage to be assigned to the shared repository. It can be defined in megabytes with the M option or in gigabytes with the G option.



Parameter	Description
-dg DATA RECO	Oracle ASM disk group in which the shared repository is to be stored, either the DATA+ disk group or the RECO+ disk group, selected by using the DATA or RECO option respectively
-h	(Optional) Display help for using the command.

### Usage Notes

- The `-size` parameter requires a whole number for size.
- The minimum value for `size` is 500 when M is used or 1 when G is used for the sizing unit.
- The default unit for `size` is G (gigabytes).
- A shared repository should only be used for the virtual machine and not as a file staging area. Avoid copying or moving files into a shared repository.

### Example

Create a 25-gigabyte shared repository named `repoprod1` in the DATA+ disk group:

```
oakcli create repo repoprod1 -dg DATA -size 25
```

## oakcli create snapshotdb

Use the `oakcli create snapshotdb` command to create a snapshot database from an existing database.

### Syntax

```
oakcli create snapshotdb [-db snap_dbname -from dbname] | [-h]
```

### Parameters

Parameter	Description
-db <i>snap_dbname</i>	Name of the snapshot database to be created
-from <i>source_dbname</i>	Name of the source database
-h	(Optional) Display help for using the command

### Example

Create a new snapshot database, name `snapprod`, from the database named `prod`:

```
oakcli create snapshotdb -db snapprod -from prod
```

## oakcli delete commands

Use the `oakcli delete` commands to delete components from Oracle Database Appliance.

- [oakcli delete cpupool](#)  
Use the `oakcli delete cpupool` command to delete a CPU pool from one Oracle Database Appliance Virtualized Platform node.
- [oakcli delete database](#)  
Use the `oakcli delete database` command to delete a database from Oracle Database Appliance.
- [oakcli delete db\\_config\\_params](#)  
Use the `oakcli delete db_config_params` command to delete a database configuration file.
- [oakcli delete dbhome](#)  
Use the `oakcli delete dbhome` command to delete a database home from Oracle Database Appliance.
- [oakcli delete dbstorage](#)  
Use the `oakcli delete dbstorage` command to delete a storage structure that was created for the purpose of migrating databases from Oracle ASM to Oracle ACFS.
- [oakcli delete repo](#)  
Use the `oakcli delete repo` command to delete a shared repository.

## oakcli delete cpupool

Use the `oakcli delete cpupool` command to delete a CPU pool from one Oracle Database Appliance Virtualized Platform node.

### Syntax

```
oakcli delete cpupool poolname -node nodenum [-h]
```

### Parameters

Parameter	Description
<i>poolname</i>	Name of the CPU pool to be deleted
-node <i>nodenum</i>	Node from which the CPU pool will be deleted (0 or 1)
-h	(Optional) Display help for using the command.

### Example

Delete the CPU pool named *twonode* from Node 1 of Oracle Database Appliance Virtualized Platform:

```
oakcli delete cpupool twonode -node 1
```

## oakcli delete database

Use the `oakcli delete database` command to delete a database from Oracle Database Appliance.

### Syntax

```
oakcli delete database -db db_name [-h]
```

**Parameters**

Parameter	Description
<i>db_name</i>	Name of the database that you want to delete
-h	(Optional) Display help for using the command

**Example**

Delete the database named `sales1`:

```
oakcli delete database -db sales1
```

## oakcli delete db\_config\_params

Use the `oakcli delete db_config_params` command to delete a database configuration file.

**Syntax**

```
oakcli delete db_config_params -conf filename [-h]
```

**Parameters**

Parameter	Description
<i>-conf filename</i>	Name of the configuration file that you want to remove, without its path name
-h	(Optional) Display help for using the command

## oakcli delete dbhome

Use the `oakcli delete dbhome` command to delete a database home from Oracle Database Appliance.

**Syntax**

```
oakcli delete dbhome -oh oracle_home [-h]
```

**Parameters**

Parameter	Description
<i>-oh oracle_home</i>	The database home to be uninstalled
-h	(Optional) Display help for using the command.

**Example**

Delete a database home called `ora11_1`:

```
oakcli delete dbhome -oh ora11_1
```

## oakcli delete dbstorage

Use the `oakcli delete dbstorage` command to delete a storage structure that was created for the purpose of migrating databases from Oracle ASM to Oracle ACFS.

For example, run this command if you created a storage structure using `create dbstorage` that is no longer required.

### Syntax

```
oakcli delete dbstorage -db db_name [-cdb] [-h]
```

### Parameters

Parameter	Description
<code>db <i>db_name</i></code>	Name of the database structure to be deleted
<code>-cdb</code>	Must be passed if you are deleting a multitenant container database
<code>-h</code>	(Optional) Display help for using the command

### Example

Delete the `sales` storage structure:

```
oakcli delete dbstorage -db sales
```

## oakcli delete repo

Use the `oakcli delete repo` command to delete a shared repository.

### Syntax

```
oakcli delete repo repository_name [-h]
```

### Parameter

Parameter	Description
<code><i>repository_name</i></code>	The name of the shared repository to be deleted
<code>-h</code>	(Optional) Display help for using the command.

### Example

Delete the `testrepo01` shared repository:

```
oakcli delete repo testrepo01
```

The command will not succeed if `testrepo01` is active on one or both nodes.

## oakcli deploy

Use the command `oakcli deploy` to deploy Oracle Grid Infrastructure for a cluster on Oracle Database Appliance.

### Syntax

```
oakcli deploy [-config] [-conf config_file] [-advance][-h]
```

### Parameters

Parameter	Description
<code>-config</code>	(Optional) Run the Oracle Appliance Manager Configurator.
<code>-conf <i>config_file</i></code>	(Optional) Preload the configuration stored in the named configuration file, <i>config_file</i> .
<code>-advance</code>	(Optional) Perform the deployment, or run the Oracle Appliance Manager Configurator, in advance mode. Use this option to launch Oracle Appliance Manager and change the default user ID or group user ID.
<code>-h</code>	(Optional) Display help for using the command.

### Usage Notes

When defining the user ID and the group ID, it is a best practice to use different values.

### Examples

Use these examples to understand how to use the command `oakcli deploy`.

#### Example 14-5 Deploying the Complete Oracle Database Appliance

```
oakcli deploy
```

#### Example 14-6 Running the Configurator

```
oakcli deploy -config
```

#### Example 14-7 Running the Offline Configurator with Advance Mode

To run the offline Configurator with advance mode, update the `config.sh` file and add `-advance`.

```
# cat config.sh
#!/bin/sh
java
-Djava.util.logging.config.file=onecommand.properties
-jar onecommand.jar config -advance
# sh ./config.sh
```

#### Example 14-8 Preloading an Existing Configuration File

Preload the configuration stored in the configuration file `MYCONFIG-VM`:

```
oakcli deploy -conf myconfig -vm_file
```

### Example 14-9 Changing a User Group Name or ID

You can change the following group user names or IDs on the User Group Information page: GI User, DB User, Install Group, DBA Group, DBA Oper Group, ASM DBA Group, ASM Oper Group, and ASM Admin Group.

1. Run the Configurator or Offline Configurator in `-advance` mode.
2. Select **Custom** to display the User Group Information page.
3. Change the group name or ID, then click **Next**.
4. Click **Finish**.

### Example 14-10 Viewing the Log File

The command `oakcli deploy` creates a log file that is prepended with the character string `STEP*`. The log file is stored in the following location:

```
/opt/oracle/oak/onecmd/tmp/
```

## oakcli expand storage

Use the `oakcli expand storage` command to configure the solid-state drives (SSDs) for data storage into the existing base configuration to fully populate the base storage shelf.

### File Path

```
/opt/oracle/oak/bin/oakcli
```

### Syntax

```
oakcli expand storage [-h]
```

### Parameters

Parameter	Description
-h	(Optional) Display help for using the command.

### Usage Notes

After all disks are inserted into the slots, execute the `oakcli expand storage` command on both nodes. First on the master node and then wait for 30 seconds and execute from the slave nodes. It takes about 10 to 12 minutes to add all of the disks.

Review the procedure for how to add the storage shelf for detailed steps on how to add the disks, the timing needed to avoid flooding disk events, and the steps to validate that all disks are online and are in a good state.

### Example 14-11 Expanding Storage

```
# oakcli expand storage
```

```

Precheck passed.
Successfully formatted 1.6TB SSD disks...
Check the progress of expansion of storage by executing 'oakcli show disk'
Waiting for expansion to finish ...

```

## oakcli diskwritecache

Use the `oakcli diskwritecache` command to locate disks with write cache enabled and to disable disk write cache for those disks.

Enabled write caches should be disabled as soon as downtime for Oracle Database Appliance can be scheduled. During the downtime, use this command with the `disable` option for each disk, in turn, that has an enabled write cache.

### Syntax

```
oakcli diskwritecache [disable disk_name | enable disk_name | status ] [-h]
```

### Parameters

Parameter	Description
disable <i>disk_name</i>	(Optional) Disable disk write cache for named disk.
enable <i>disk_name</i>	(Optional) Enable disk write cache for named disk.
status	(Optional) Show the write cache status of all disks.
-h	(Optional) Display help for using the command.

### Example 14-12 Displaying the Write Cache Status of Disks

Show the write cache status of all disks:

```
oakcli diskwritecache status
```

## oakcli locate disk

Use the `oakcli locate disk` command to locate the physical disk that is associated with a named Oracle ASM disk by turning the disk's LED light on or off.

### Syntax

```
oakcli locate disk diskname [on|off][-h]
```

### Parameters

Parameter	Description
<i>diskname</i>	Name of the Oracle ASM disk to locate
on	(Optional) Turns on the LED of the named disk
off	(Optional) Turns off the LED of the named disk
-h	(Optional) Display help for using the command.

**Example 14-13 Locating an Oracle ASM Disk by Turning on the Disk's LED**

Turn on the LED of the Oracle ASM disk named `disk pd_23`:

```
oakcli locate disk pd_23 on
```

## oakcli manage diagcollect

Use the `oakcli manage diagcollect` command to collect diagnostic information about Oracle Database Appliance for troubleshooting purposes, and for working with Oracle Support Services.

### Syntax

```
oakcli manage diagcollect [--all | --crs [--crshome crs_home_dir]
(continued)
[--core] | --install | --chmos [--incidenttime time] [--incidentduration time]
(continued)
|--adr adr_location [--afterdate date]
(continued)
[--aftertime time] [--beforetime time] ]
[excl comp1,comp2,...] [--clean] [--storage][-h]
```

### Parameters

Parameter	Description
<code>--all</code>	Collect all of the diagnostic information excluding Automatic Diagnostic Repository (ADR) and Cluster Health Monitor. This is the default option.
<code>--crs</code>	Collect Oracle Clusterware diagnostic information.
<code>--crshome <i>crs_home_dir</i></code>	Specifies the location of the Oracle Clusterware home directory
<code>--core</code>	Package core files with the Oracle Clusterware diagnostic data.
<code>--install</code>	Collect the installation logs when the installation failed before running the script <code>root.sh</code> .
<code>--adr <i>adr_location</i></code>	Collect diagnostic information for ADR, where <i>adr_location</i> specifies the location of the ADR information.
<code>--afterdate <i>date</i></code>	Collect archives from the specified date. Specify the date in the <code>mm/dd/yyyy</code> format.
<code>--aftertime <i>time</i></code>	Collect the archives after the specified time. Enter the time using the format <code>YYYYMMDDHHMMSS24</code> . Supported only with the <code>-adr</code> parameter.
<code>--beforetime <i>time</i></code>	Collect the archives before the specified time. Enter the time using the format: <code>YYYYMMDDHHMMSS24</code> . Supported only the with the <code>-adr</code> parameter.
<code>--chmos</code>	Collect Cluster Health Monitor data.



Parameter	Description
<code>--incidenttime <i>time</i></code>	Collect Cluster Health Monitor data from the specified time. Enter the time using the format: YYYYMMDDHHMMSS24. If you do not use the <code>--incidenttime</code> parameter, then the command collects data for the past 24 hours.
<code>--incidentduration <i>time</i></code>	Collect Cluster Health Monitor data for the duration after the specified time. Enter the time using the format: HH:MM. If you do not specify a duration, then the command collects all Cluster Health Monitor data after the specified incident time.
<code>--excl [<i>comp1,comp2...</i>]</code>	Exclude the specified component logs. Valid components are: acfs, invt, sys, ocr, crs, home, and base.
<code>--clean</code>	Remove the diagnosability information gathered by this command.
<code>--storage</code>	Collect all of the logs for any storage issues. The logs can be used when you are experiencing any problems with storage and need support to diagnose the logs.
<code>--h</code>	(Optional) Display help for using the command.

## oakcli describe-system

Use the `oakcli describe-system` command to display details about components installed on the system.

### File Path

```
/opt/oracle/oak/bin/oakcli
```

### Syntax

```
oakcli describe-system
```

### Usage Notes

The command describes the system components such as node information, installed RPMs, Oracle Grid Infrastructure version and patches, Database home details and stores the information in a file.

### Example 14-14 Example Command to View the Bill of Materials from the Command Line for Virtualized Platforms Deployments

```
# oakcli describe-system
```

```
Output : ./oakcli describe-system
```

```
Generating a list of BOM component...
```

```
Output file is : /opt/oracle/oak/Inventory/
oda_bom_20180821022110.log
```

# oakcli modify database

Use the `oakcli modify database` command to modify the database type or size class for a named database.

## Syntax

```
oakcli modify database -db db name [-dbtypeOLTP/DSS/in-Memory] [-to dbSizeclass]
```

## Parameters

Parameter	Description
-db <i>db-name</i>	Identifies the database being modified.
-dbtype <code>OLTP/DSS/in-Memory</code>	(Optional) Changes the database type. The parameter <code>dbtype</code> takes one of the following three options: <ul style="list-style-type: none"><li>OLTP: Online transaction processing</li><li>DSS: Decision support system</li><li>in-Memory: Oracle Database In-Memory</li></ul>
-to <i>dbclass</i>	(Optional) Changes the database size class.
-h	(Optional) Displays help for using the command.

## Usage Notes

### Note:

When you resize the database, the redo log file size is not modified automatically. Change the size of the redo log manually to the size that you require for your applications.

### Example 14-15 Modifying the Database Type

Here are examples of how to use the `oakcli modify database` command.

Change the database type assigned to the database `dbhome_1` to a DSS database:

```
oakcli modify database DB dbhome_1 -dbtype DSS
```

### Example 14-16 Modifying the Database Size

Change the database size for the database named `dbhome_1` to a 6-core CPU Oracle Database Appliance DSS database template:

```
oakcli modify database dbhome_1 -to odb-06
```

## oakcli orachk

Use the `oakcli orachk` command to audit configuration settings with the ORAchk utility.

### Syntax

```
oakcli orachk [-a|-b|-v|-h|-p|-f|-m[-u -o][o]-c -t][-clusternodes |-
localonly][-debug][-dbnames | -dbnone|-dball][upgrade]listlist
```

### Parameters

Parameter	Description
-a	Perform a best practice check and recommended patch check.
-b	Perform a best practice check only without the recommended patch check.
-v	Display version.
-h	Display command usage (help).
-p	Perform patch check only.
-f	Run the command offline.
-m	Exclude checks for Maximum Availability scorecards.
-u -o	Perform check on pre-upgrade best practices (-u -o pre) or on post-upgrade best practices (-u -o post).
-o	As an argument to an option, if -o is followed by v, V, Verbose, or VERBOSE, output will display checks that pass on the display. Without the -o option, only failures will display on the screen.
-c	Determines granularity of information displayed on the screen. For use only when working with Oracle Support Services.
-clusternodes <i>list</i>	<i>list</i> is a comma-delimited list containing the names of the nodes where the command should run.
-localonly	Run the command only on the local node.
-debug	Creates a debug log.
-dbnames <i>list</i>	<i>list</i> is a comma-delimited list containing the names of the subset of databases on which the command should run.
-dbnone	Skip all database-related checks on all databases without prompting to select which database to skip.
-dball	Run all database-related checks on all databases without prompting to select which databases to check.
-upgrade	Force upgrade of the version of the ORAchk utility being run.

### Usage Notes

- The command offers multiple options that are generic to the ORAchk command when run on servers other than the Oracle Database Appliance server. You can find details about these options by running the command `oakcli orachk -h`. The options are grouped into the following categories, but this document does not list the options for each category:

- Report Options
- Auto Restart Options
- Daemon Options
- Profile Run Options
- For more information about ORAchk, see My Oracle Support note 1268927.2, "ORAchk Health Checks for the Oracle Stack" at <https://support.oracle.com/rs?type=doc&id=1268927.2>

## oakcli reconfigure osparams

Use the `oakcli reconfigure osparams` command to adjust the kernel parameters based on the available RAM after you upgrade memory or DIMM.

After you change or expand memory on Oracle Database Appliance, use the `oakcli reconfigure osparams` command to display the current configuration and suggested values for `memlock` and `vm.nr_hugepages`. When prompted, answer `yes` or `no` to change the value to the suggested value.

### Syntax

```
oakcli reconfigure osparams [-h]
```

### Parameters

Parameter	Description
-h	(Optional) Displays help for using the command.

### Usage Notes

After you change or expand memory on Oracle Database Appliance, use this command to update the kernel parameters.



#### Note:

When adjusting the settings, ensure that you make the changes on both nodes.

### Example 14-17 Viewing the Current and Suggested Kernel Parameters

In this example, the output displays the configured and suggested values for `memlock` and `vm.nr_hugepages`. When prompted, enter `no` for both parameters to view, but not implement the suggested values.

```
# oakcli reconfigure osparams
Configured value for memlock is: 11000000
Suggested value for memlock is: 11000000
Do you want to use suggested value of memlock?: yes/no
no
User entered no, not updating kernel.memlock
```

```
Configured value for vm.nr_hugepages is: 2048
Suggested value for vm.nr_hugepages parameter is: 4150
Do you want to update to suggested value?: yes/no
no
User entered no, not updating kernel.vm.nr_hugepages
```

### Example 14-18 Reconfiguring the Kernel Based on Available RAM

In this example, the output displays the configured and suggested values for `memlock` and `vm.nr_hugepages`. The `memlock` value does not require changing. A new value is suggested for `vm.nr_hugepages`. When prompted, enter `yes` to update to the suggested value.

#### Note:

You must adjust the value on both nodes.

```
# oakcli reconfigure osparams
Configured value for memlock is: 193000000
Suggested value for memlock is: 193000000
Configured and suggested values are same
Configured value for vm.nr_hugepages is: 67815
Suggested value for vm.nr_hugepages parameter is: 67748
Do you want to update to suggested value?: yes/no
yes
```

## oakcli resize dbstorage

Use the `oakcli resize dbstorage` command to resize the space used for a storage structure that was created for the purpose of migrating databases from Oracle ASM to Oracle ACFS.

You can check the current space usage using `oakcli show fs` and then add space using `oakcli resize dbstorage`.

#### Note:

You cannot decrease the size of the space used for Oracle ACFS.

### Syntax

```
oakcli resize dbstorage -data size -reco size -redo size -db db_name [-h]
```

### Parameters

Parameter	Description
<code>-data <i>size</i></code>	Extendable size in GB for the DATA volume.

Parameter	Description
<code>-reco size</code>	Extendable size in GB for the REDO volume.
<code>-redo size</code>	Extendable size in GB for the RECO volume.
<code>-db db_name</code>	Database for which these volumes must be resized.
<code>-h</code>	(Optional) Display help for using the command.

**Example 14-19 Increasing the Size of the DATA Volume**

Increase the size of the volume by 10 GB on the DATA volume:

```
oakcli resize dbstorage -data 10
```

## oakcli restart oda\_base

Use the `oakcli restart oda_base` command to stop and restart ODA\_BASE on the local node.

Use this command only when you are not concerned about the current status of ODA\_BASE, because it performs a forced shutdown. You must run this command from Dom0. Typically, if ODA\_BASE needs to be restarted, then you must restart it on both nodes.

**Syntax**

```
oakcli restart oda_base [-h]
```

The ODA\_BASE that you want to restart is on the same node as the Dom0 from which you run this command.

**Parameter**

(Optional) `-h` displays help for using the command.

## oakcli show commands

Use the `oakcli show` commands to display the status of Oracle Database Appliance components.

The `oakcli show` commands display status information for the node where you run the command. To see the list of components available on the current node, use the help option: `oakcli show -h`:

 **Note:**

Depending on your model and version of Oracle Database Appliance software, the `oakcli show` command options may differ from the ones shown in this section and explained in the following sections. To obtain an annotated list of components available on your system, run the command `oakcli show -h`.

- [oakcli show asr](#)  
Use the `oakcli show asr` command to display your Oracle Auto Service Request configuration details.
- [oakcli show cooling](#)  
Use the `oakcli show cooling` command to display the status of the cooling units.
- [oakcli show controller](#)  
Use the `oakcli show controller` command to display information about the disk controllers.
- [oakcli show cpupool](#)  
Use the `oakcli show cpupool` command to display core allocations to virtual machine mappings.
- [oakcli show databases](#)  
Use the `oakcli show databases` command to display information about each existing database, including database name, database type, database home name and location, and database version.
- [oakcli show db\\_config\\_params](#)  
Use the `oakcli show db_config_params` command to display configuration file names and parameters.
- [oakcli show dbhomes](#)  
Use the `oakcli show dbhomes` command to display information about each existing Oracle database home, including home name, home location, and database version.
- [oakcli show dbstorage](#)  
Use the `oakcli show dbstorage` command to display database storage information for databases created on Oracle Automatic Storage Management Cluster File System (Oracle ACFS).
- [oakcli show disk](#)  
Use the `oakcli show disk` command to display disk information.
- [oakcli show diskgroup](#)  
Use the `oakcli show diskgroup` command to display Oracle Automatic Storage Management (Oracle ASM) disk group information.
- [oakcli show enclosure](#)  
Use the `oakcli show enclosure` command to display information about the storage enclosure subsystem on the node where the command is executed.
- [oakcli show env\\_hw](#)  
Use the `oakcli show env_hw` command to display the environment type and hardware version of the current node.

- [oakcli show expander](#)  
Use the `oakcli show expander` command to display information about a SAS expander.
- [oakcli show ismaster](#)  
Use the `oakcli show ismaster` command to determine which node is the master node.
- [oakcli show fs](#)  
Use the `oakcli show fs` command to display all database and cloudfs file systems created on ASM Cluster File System (ACFS) in addition to the local file systems on the Oracle Database Appliance node.
- [oakcli show memory](#)  
Use the `oakcli show memory` command to display information about memory modules.
- [oakcli show network](#)  
Use the `oakcli show network` command to display information about the network subsystem.
- [oakcli show power](#)  
Use the `oakcli show power` command to display information about the power supply subsystem.
- [oakcli show processor](#)  
Use the `oakcli show processor` command to display information about CPU processors.
- [oakcli show raidsyncstatus](#)  
Use the `oakcli show raidsyncstatus` command to display the status of the RAID rebuild after a failed local disk is replaced.
- [oakcli show repo](#)  
Use the `oakcli show repo` command to display information about virtual machine repositories.
- [oakcli show server](#)  
Use the `oakcli show server` command to display information about the server subsystem.
- [oakcli show storage](#)  
Use the `oakcli show storage` command to display information about the storage for controllers, expanders, and disks.
- [oakcli show validation storage](#)  
Use the `oakcli show validation storage` command to show whether validation storage is enabled or disabled.
- [oakcli show validation storage errors](#)  
Use the `oakcli show validation storage errors` command to show hard storage errors.
- [oakcli show validation storage failures](#)  
Use the `oakcli show validation storage failures` command to show soft validation errors. A typical soft disk error would be an invalid version of the disk firmware.
- [oakcli show version](#)  
Use the `oakcli show version` command to display the applied patch versions for Oracle Database Appliance software and firmware.



## oakcli show asr

Use the `oakcli show asr` command to display your Oracle Auto Service Request configuration details.

### Syntax

```
oakcli show asr [-h]
```

### Parameters

(Optional) `-h` displays the help for using this command.

## oakcli show cooling

Use the `oakcli show cooling` command to display the status of the cooling units.

### Syntax

```
oakcli show cooling [-h]
```

### Parameters

(Optional) `-h` displays the help for using this command.

### Example

Display the cooling unit information for the node where the command is executed:

```
# oakcli show cooling
NAME   HEALTH HEALTH_DETAILS LOCATION FAN % FAN SPEED
Fan_0  OK      -              FM0     30 % 6300 RPM
Fan_1  OK      -              FM0     19 % 3800 RPM
Fan_10 OK      -              FM2     34 % 6600 RPM
Fan_11 OK      -              FM2     23 % 4100 RPM
Fan_12 OK      -              FM3     32 % 6300 RPM
Fan_13 OK      -              FM3     22 % 3900 RPM
Fan_14 OK      -              FM3     24 % 4700 RPM
Fan_15 OK      -              FM3     14 % 2500 RPM
Fan_2  OK      -              FM0     29 % 6400 RPM
Fan_3  OK      -              FM0     18 % 3700 RPM
Fan_4  OK      -              FM1     32 % 6400 RPM
Fan_5  OK      -              FM1     20 % 3700 RPM
Fan_6  OK      -              FM1     33 % 6400 RPM
Fan_7  OK      -              FM1     22 % 3800 RPM
Fan_8  OK      -              FM2     33 % 6400 RPM
Fan_9  OK      -              FM2     22 % 3900 RPM
```

## oakcli show controller

Use the `oakcli show controller` command to display information about the disk controllers.

### Syntax

```
oakcli show controller controller_id [-h]
```

### Parameters

Parameter	Description
<i>controller_id</i>	Specifies the controller for which to display information
-h	(Optional) Display help for using the command.

### Displaying Disk Controller Details

Display details of controller 0:

```
oakcli show controller 0
```

## oakcli show cpupool

Use the `oakcli show cpupool` command to display core allocations to virtual machine mappings.

### Syntax

```
oakcli show cpupool -node nodenum
```

*nodenum* is the number of the Oracle Database Appliance node that you want to examine, either 0 or 1.

### Displaying Core Mapping for Node 0

Display the core mapping information for Node 0:

```
# oakcli show cpupool -node 0
      Pool          Cpu List          VM List
default-unpinned-pool  [14, 15, 16, 17,
['test1_odarepol', 'sample5_odarepol',
      18, 19, 20, 21,
'vm_very_long_name_sample1_odarepol',
      22, 23]          'win_vm1']
      twocpu          [12, 13]          ['vm1_odarepol']
      odaBaseCpuPool  [0, 1, 2, 3, 10
      , 11]          ['oakDom1']
```

## oakcli show databases

Use the `oakcli show databases` command to display information about each existing database, including database name, database type, database home name and location, and database version.

### Syntax

```
oakcli show databases [-h]
```

### Parameters

Parameter	Description
-h	(Optional) Displays help for using the command.

### Usage Notes

On Oracle Database Appliance, the minimum supported Oracle Database release is 11.2.0.4. Oracle Database 11.2.0.3.x is not supported.

### Example 14-20 Displaying Database Details

```
# oakcli show databases
Name Type Storage HomeName HomeLocation
Version
-----
-----
omydb RAC ACFS OraDb12102_home1 /u01/app/oracle/product/12.1.0.2/dbhome_1
12.1.0.2.160719(23054246,23054327)
orcl RAC ACFS OraDb12102_home1 /u01/app/oracle/product/12.1.0.2/dbhome_1
12.1.0.2.160719(23054246,23054327)
```

### Example 14-21 Displaying Database Details for Four Databases

```
#oakcli show databases

Name Type Storage HomeName HomeLocation Version
-----
db1 RAC ACFS OraDb12102_home1 /u01/app/oracle/product/12.1.0.2/dbhome_1 12.1.0.2.5(21359755,21359758)
db2 SINGLE ACFS OraDb12102_home2 /u01/app/oracle/product/12.1.0.2/dbhome_2 12.1.0.2.5(21359755,21359758)
db3 RACOneNode ACFS OraDb12102_home3 /u01/app/oracle/product/12.1.0.2/dbhome_3 12.1.0.2.5(21359755,21359758)
db4 RAC ACFS OraDb12102_home4 /u01/app/oracle/product/12.1.0.2/dbhome_4 12.1.0.2.5(21359755,21359758)
```

## oakcli show db\_config\_params

Use the `oakcli show db_config_params` command to display configuration file names and parameters.

The command searches for files with the extension `.dbconf` located in the `/opt/oracle/oak/install/dbconf` directory.

## Syntax

```
oakcli show db_config_params [-conf filename] [-detail] [-h]
```

## Parameters

Parameter	Description
-conf <i>filename</i>	(Optional) Name of configuration file to be displayed. If not included, then the command displays all configuration files.
-detail	(Optional) Display the parameter values stored in the configuration file or files.
-h	(Optional) Display help for using the command.

## Displaying the Default Database Configuration Parameters

Display the default database configuration parameter values stored in the configuration file or files:

```
# oakcli show db_config_params -detail
Available DB configuration files are:
  Default
  DATABASE_BLOCK_SIZE      => 8192
  DATABASE_LANGUAGE        => AMERICAN
  DATABASE_CHARACTERSET    => AL32UTF8
  DATABASE_TERRITORY       => AMERICA
  COMPONENT_LANGUAGES     => en
```

## oakcli show dbhomes

Use the `oakcli show dbhomes` command to display information about each existing Oracle database home, including home name, home location, and database version.

## Syntax

```
oakcli show dbhomes [-detail] [-h]
```

## Parameters

Parameter	Description
-detail	(Optional) Include a list of databases associated with each home.
-h	(Optional) Display help for using the command.

## Usage Notes

On Oracle Database Appliance, the minimum supported Oracle Database release is 11.2.0.4. Oracle Database 11.2.0.3.x is not supported.

**Example 14-22 Displaying DB Home Details**

```
# oakcli show dbhomes

Oracle Home Name      Oracle Home version      Home
Location
-----
OraDb12102_home1     12.1.0.2.160719(23054246,23054327) /u01/app/oracle/
product/12.1.0.2/dbhome_1
```

**Example 14-23 Displaying DB Home Details**

```
# oakcli show dbhomes -detail

Oracle HomeName      Oracle Home Version      Oracle HomeLocation      Database Name      Database Type
-----
OraDb11204_home1     11.2.0.4.8(21352635,21352649) /u01/app/oracle/product/11.2.0.4/dbhome_1 no DB      available
OraDb12102_home1     12.1.0.2.5(21359755,21359758) /u01/app/oracle/product/12.1.0.2/dbhome_1 one43     RACOneNode
OraDb12102_home1     12.1.0.2.5(21359755,21359758) /u01/app/oracle/product/12.1.0.2/dbhome_1 ee120     SINGLE
OraDb12102_home1     12.1.0.2.5(21359755,21359758) /u01/app/oracle/product/12.1.0.2/dbhome_1 one311    RACOneNode
OraDb12102_home1     12.1.0.2.5(21359755,21359758) /u01/app/oracle/product/12.1.0.2/dbhome_1 ee311     SINGLE
OraDb12102_home1     12.1.0.2.5(21359755,21359758) /u01/app/oracle/product/12.1.0.2/dbhome_1 rac311    RAC
OraDb12102_home1     12.1.0.2.5(21359755,21359758) /u01/app/oracle/product/12.1.0.2/dbhome_1 ee43      SINGLE
OraDb12102_home1     12.1.0.2.5(21359755,21359758) /u01/app/oracle/product/12.1.0.2/dbhome_1 one120    RACOneNode
OraDb12102_home1     12.1.0.2.5(21359755,21359758) /u01/app/oracle/product/12.1.0.2/dbhome_1 odacn     RAC
OraDb12102_home1     12.1.0.2.5(21359755,21359758) /u01/app/oracle/product/12.1.0.2/dbhome_1 rac43     RAC
OraDb12102_home1     12.1.0.2.5(21359755,21359758) /u01/app/oracle/product/12.1.0.2/dbhome_1 rac120    RAC
```

## oakcli show dbstorage

Use the `oakcli show dbstorage` command to display database storage information for databases created on Oracle Automatic Storage Management Cluster File System (Oracle ACFS).

All non-cdb databases are listed together, because they share a common set of volumes. Each CDB database is listed separately.

**Syntax**

```
oakcli show dbstorage [-db] db_name[-h]
```

**Parameters**

Parameter	Description
-db <i>dbname</i>	(Optional) Display the name of the database for the storage information.
-h	(Optional) Display help for using the command.

**Usage Notes****Example 14-24 Oracle Database Appliance with Non-CDB Databases**

Here is an example of the `oakcli show dbstorage` command output for an Oracle Database Appliance. The output includes only non-CDB databases. Half of the

available disk group storage is allocated to Oracle ACFS, except for the FLASH disk group. In the FLASH disk group, all storage is allocated to Oracle ACFS.

```
# oakcli show dbstorage
```

All the DBs with DB TYPE as non-CDB share the same volumes

DB_NAMES	DB_TYPE	Filesystem	Size	Used	Available	AutoExtend	Size	DiskGroup
db1, db2, db3, db4	non-CDB	/u01/app/oracle/oradata/datastore	62G	27.26G	34.74G	6G		REDO
		/u02/app/oracle/oradata/datastore	3730G	7.86G	3722.14G	373G		DATA
		/u02/app/oracle/oradata/flashdata	558G	205.25G	352.75G	55G		FLASH
		/u01/app/oracle/fast_recovery_area/datastore	4958G	21.05G	4936.95G	495G		RECO

## oakcli show disk

Use the `oakcli show disk` command to display disk information.

### Syntax

```
oakcli show disk [-shared | -local | -shared_disk_name | -asm [-all]][-h]
```

### Parameters

Parameter	Description
<code>-local</code>	(Optional) Display information for all of the local disks.
<code>-shared</code>	(Optional) Display information for all of the shared disks.
<code>-shared_disk_name</code>	(Optional) Display information for only the specified shared disk.
<code>-asm</code>	(Optional) Displays information for an assembly.
<code>-all</code>	(Optional) Display complete details of the selected disk or disks.
<code>-h</code>	(Optional) Display help for using the command.

### Usage Notes

- Running the command with no parameters is identical to running the `oakcli show disk -shared` command.
- The `-all` parameter produces valid output only when used with the `shared_disk_name` parameter. All other parameters are optional and cannot be combined with other parameters.

#### Example 14-25 Displaying Information About the Local Disks

```
oakcli show disk -local
```

#### Example 14-26 Displaying Information About the Shared Disks

```
oakcli show disk -shared
```

**Example 14-27 Displaying Information About a Specific Shared Disk**

Display information about the shared disk named `pd_01`:

```
oakcli show disk -shared pd_01
```

## oakcli show diskgroup

Use the `oakcli show diskgroup` command to display Oracle Automatic Storage Management (Oracle ASM) disk group information.

**Syntax**

```
oakcli show diskgroup [disk_group_name][-h]
```

**Parameters**

Parameter	Description
<i>disk_group_name</i>	(Optional) The name of an Oracle ASM disk group for which complete details should be displayed. If you do not specify this parameter, then information for all of the Oracle ASM disk groups is displayed.
-h	(Optional) Display help for using the command.

## oakcli show enclosure

Use the `oakcli show enclosure` command to display information about the storage enclosure subsystem on the node where the command is executed.

**Syntax**

```
oakcli show enclosure [-h]
```

**Parameter**

-h displays help for using the command.

## oakcli show env\_hw

Use the `oakcli show env_hw` command to display the environment type and hardware version of the current node.

**Syntax**

```
oakcli show env_hw [-h]
```

**Parameter**

(Optional) -h displays help for using the command.

## Displaying the Environment and Hardware for a Virtualized Platform

Show the environment type and hardware model when logged in to ODA\_BASE on Oracle Database Appliance Virtualized Platform:

```
oakcli show env_hw
VM-ODA_BASE ODA X7-2
```

## oakcli show expander

Use the `oakcli show expander` command to display information about a SAS expander.

### Syntax

```
oakcli show expander [expander_id] [-h]
```

### Parameter

Parameter	Description
<i>expander_id</i>	(Optional) Identifies the specific SAS expander
-h	(Optional) Display help for using the command.

## oakcli show ismaster

Use the `oakcli show ismaster` command to determine which node is the master node.

### File Path

```
/opt/oracle/oak/bin/oakcli
```

### Syntax

```
oakcli show ismaster [-h]
```

### Parameters

Parameter	Description
-h	(Optional) Display help for using the command.

### Example 14-28 Determining Which Node is the Master Node

```
# oakcli show ismaster
```



## oakcli show fs

Use the `oakcli show fs` command to display all database and cloudfs file systems created on ASM Cluster File System (ACFS) in addition to the local file systems on the Oracle Database Appliance node.

### Syntax

```
oakcli show fs [-h]
```

### Parameter

(Optional) `-h` displays help for using the command.

## oakcli show memory

Use the `oakcli show memory` command to display information about memory modules.

### Syntax

```
oakcli show memory [-h]
```

### Parameter

(Optional) `-h` displays help for using the command.

## oakcli show network

Use the `oakcli show network` command to display information about the network subsystem.

### Syntax

```
oakcli show network
```

### Parameter

(Optional) `-h` displays help for using the command.

## oakcli show power

Use the `oakcli show power` command to display information about the power supply subsystem.

### Syntax

```
oakcli show power [-h]
```

**Parameter**

(Optional) `-h` displays help for using the command.

**Example 14-29 Displaying Power Supply Information**

Display the power supply information of the node where the command is executed:

```
# oakcli show power

NAME                HEALTH HEALTH_DETAILS PART_NO. SERIAL_NO.        LOCATION
INPUT_POWER OUTPUT_POWER INLET_TEMP      EXHAUST_TEMP
Power_Supply_0 OK        -                7047410 476856F+1242CE0020 PS0
Present            113 watts  33.250 degree C 36.688 degree C
Power_Supply_1 OK        -                7047410 476856F+1242CE004J PS1
Present            89 watts  37.000 degree C 39.438 degree C
```

## oakcli show processor

Use the `oakcli show processor` command to display information about CPU processors.

**Syntax**

```
oakcli show processor [-h]
```

**Parameter**

(Optional) `-h` displays help for using the command.

**Displaying CPU Processor Information**

Display the CPU processor information of the node where the command is executed:

```
# oakcli show processor

NAME HEALTH HEALTH_DETAILS PART_NO. LOCATION
MODEL                MAX_CLK_SPEED TOTAL_CORES ENABLED_CORES

CPU_0 OK        -                060D      P0 (CPU 0)
Intel(R) Xeon(R) CPU E5-2690 2.900 GHZ      8          8
CPU_1 OK        -                060D      P1 (CPU 1)
Intel(R) Xeon(R) CPU E5-2690 2.900 GHZ      8          8
```

## oakcli show raidsyncstatus

Use the `oakcli show raidsyncstatus` command to display the status of the RAID rebuild after a failed local disk is replaced.

 **Note:**

The `show raidsyncstatus` command is only supported on a bare metal platform; it is not supported on the virtualized platform. For general RAID information, use the `oakcli show iraid` command.

### Syntax

```
oakcli show raidsyncstatus [-h]
```

### Parameter

(Optional) `-h` displays help for using the command.

## oakcli show repo

Use the `oakcli show repo` command to display information about virtual machine repositories.

### Syntax

```
oakcli show repo [reponame -node 0|1] [-h]
```

### Parameters

Parameter	Description
<i>reponame</i>	[Optional] Identifies a specific repository name
<i>-node</i>	[Optional] Identifies the node number 0 or 1
<i>-h</i>	[Optional] Display help for using the command.

To see all repositories, omit the repository name and node number. To see a specific shared repository, include the repository name and node.

### Examples

Here are examples of how to use the `oakcli show repo` command.

#### Example 14-30 Displaying the Available Virtual Machine Repositories

Display the virtual machine repositories on Oracle Database Appliance Virtualized Platform nodes:

```
# oakcli show repo
      NAME      REPOTYPE  NODENUM
odarepo1  local    0
```

```

odarepo2 local 1
repo1 shared 0
repo1 shared 1

```

### Example 14-31 Displaying Details About a Specific Shared Repository

Display information about the repository named `repo1` on Node 1:

```

# oakcli show repo repo1 -node 1

Resource: repo1_1
  AutoStart      : restore
  DG             : DATA
  Device        : /dev/asm/repo1-286
  ExpectedState  : Online
  MountPoint    : /u01/app/repo1
  Name          : repo1_0
  Node          : all
  RepoType      : shared
  Size         : 102400
  State        : Online

```

## oakcli show server

Use the `oakcli show server` command to display information about the server subsystem.

### Syntax

```
oakcli show server [-h]
```

### Parameter

(Optional) `-h` displays help for using the command.

## oakcli show storage

Use the `oakcli show storage` command to display information about the storage for controllers, expanders, and disks.

### Syntax

```
oakcli show storage -errors [-h]
```

### Parameters

Parameter	Description
<code>-errors</code>	Display detailed information about reported errors.
<code>-h</code>	(Optional) Display help for using the command.

## oakcli show validation storage

Use the `oakcli show validation storage` command to show whether validation storage is enabled or disabled.

### Syntax

```
oakcli show validation storage [-h]
```

### Parameter

(Optional) `-h` displays help for using the command.

### Example 14-32 Determining if Storage Validation is Enabled

```
# oakcli show validation storage
Enabled
```

## oakcli show validation storage errors

Use the `oakcli show validation storage errors` command to show hard storage errors.

Hard errors include having the wrong type of disk inserted into a particular slot, an invalid disk model, or an incorrect disk size.

### Syntax

```
oakcli show validation storage errors [-h]
```

### Parameter

(Optional) `-h` displays help for using the command.

## oakcli show validation storage failures

Use the `oakcli show validation storage failures` command to show soft validation errors. A typical soft disk error would be an invalid version of the disk firmware.

### Syntax

```
oakcli show validation storage failures [-h]
```

### Parameter

(Optional) `-h` displays help for using the command.

## oakcli show version

Use the `oakcli show version` command to display the applied patch versions for Oracle Database Appliance software and firmware.

### Syntax

```
oakcli show version [-detail] [-h]
```

Parameter	Description
-detail	(Optional) Display detailed version information.
-h	(Optional) Display help for using the command.

### Usage Notes

When you apply the patch and then run the command `oakcli show version -detail`, the output shows the installed version and that the supported versions are `Up-to-date` for each component. If you unpack the patch bundle (`oakcli unpack -pack`) and then run the command `oakcli show version -detail` before applying the patch, the output shows `No-update` in the Supported Version column.



#### Note:

After unpacking the patch bundle, but before applying the patch, use the `oakcli update -patch version --verify` command to verify the contents of the patch instead of issuing `oakcli show version -detail`.

### Displaying the Oracle Database Appliance Version

This is an example of how to determine if all of the components are successfully updated after applying the 12.1.2.10.0 patch. You can also view the applied patch version information for the software and firmware on Oracle Database Appliance. All components are successfully updated when `Up-to-date` appears in the Supported Version column.

```
# oakcli show version -detail

Mon Feb 13 03:31:48 PST 2017
Reading the metadata. It takes a while...
System Version   Component Name           Installed Version         Supported Version
-----
12.1.2.10.0

Controller_INT   4.230.40-3739           Up-to-date
Controller_EXT   09.00.00.00             Up-to-date
Expander         0291                    Up-to-date
SSD_SHARED {
  [ c2d20,c2d21,c2d22,  A29A                    Up-to-date
  c2d23 ]
  [ c2d0,c2d1,c2d2,c2d  A29A                    Up-to-date
```

```

3,c2d4,c2d5,c2d6,c2d
7,c2d8,c2d9,c2d10,c2
d11,c2d12,c2d13,c2d1
4,c2d15,c2d16,c2d17,
c2d18,c2d19 ]
}

SSD_LOCAL          0R3Q          Up-to-date
ILOM                3.2.8.24 r114611      Up-to-date
BIOS                38070000             Up-to-date
IPMI                1.8.12.4            Up-to-date
HMP                 2.3.5.2.8           Up-to-date
OAK                 12.1.2.10.0         Up-to-date
OL                  6.8                  Up-to-date
GI_HOME             12.1.0.2.170117(2473
                    2082,24828633)
DB_HOME             12.1.0.2.170117(2473
                    2082,24828633)

```

### Related Topics

- [oakcli update](#)

Use the `oakcli update` command to apply Oracle Database Appliance patches.

## oakcli start commands

Use the `oakcli start` commands to start a virtual machine, to start a shared repository on a node, or to start ODA\_BASE on the local node.

- [oakcli start oda\\_base](#)

Use the `oakcli start oda_base` command to start ODA\_BASE on the local node.

- [oakcli start repo](#)

Use the `oakcli start repo` command to start a shared repository on a node.

## oakcli start oda\_base

Use the `oakcli start oda_base` command to start ODA\_BASE on the local node.

### Syntax

```
oakcli start oda_base [-h]
```

### Parameter

(Optional) `-h` displays help for using the command.

**Example 14-33 Starting ODA\_BASE on the Local Node**

Connect to Dom0 on the desired node and enter the following command to start ODA\_BASE on that node:

```
oakcli start oda_base
```

## oakcli start repo

Use the `oakcli start repo` command to start a shared repository on a node.

**Syntax**

```
oakcli start repo repo_name [-node node_number] [-h]
```

**Parameters**

Parameter	Description
<i>repo_name</i>	<i>repo_name</i> is the name of the shared repository to be started.
-node <i>node_number</i>	Specifies the node on which to start the shared repository. <i>node_number</i> is the number of the node where it is to be started, either 0 or 1. If -node is not specified, the shared repository is started on both nodes.
-h	(Optional) Displays help for using the command.

**Example 14-34 Starting a Shared Repository on Node 0**

Start the shared repository named `repo1` on Node 0:

```
oakcli start repo repo1 -node 0
```

## oakcli stop command

Use the `oakcli stop` command to stop a virtual machine, to stop a shared repository on a node, or to stop ODA\_BASE on the local node.

**Syntax**

```
oakcli stop [vm vm_name [-force] | repo repo_name [-node node_number] |  
oda_base ] [-h]
```

**Parameters**

Parameter	Description
vm <i>vm_name</i>	<i>vm_name</i> is the name of the virtual machine to be stopped.
-force	(Optional) forces the virtual machine to stop.
repo <i>repo_name</i>	<i>repo_name</i> is the name of the shared repository to be stopped.



Parameter	Description
<code>-node node_number</code>	<code>node_number</code> is the number of the node where the shared repository is to be stopped, either 0 or 1. The <code>-node</code> parameter is only valid when stopping a virtual machine on a shared repository. If <code>-node</code> is not specified, the shared repository is stopped on both nodes.
<code>oda_base</code>	Stops ODA_BASE on the local node
<code>-h</code>	(Optional) Displays help for using the command.

### Examples

Here are examples of how to use the `oakcli stop` command.

#### Example 14-35 Forcing a Virtual Machine to Stop

Force the virtual machine named `vm1_odarepo1` to stop:

```
oakcli stop vm vm_odarepo1 -force
```

#### Example 14-36 Stopping a Shared Repository

Stop the shared repository named `repo1` on Node 0:

```
oakcli stop repo repo1 -node 0
```

#### Example 14-37 Stopping the Local ODA\_Base

Connect to Dom0 on the desired node and enter the following command to stop ODA\_BASE on that node:

```
oakcli stop oda_base
```

## oakcli stordiag

Use the `oakcli stordiag` command to run diagnostic tests on a disk in the storage shelf or storage expansion shelf.

The tool produces a list of 14 disk checks for each node.

### Syntax

```
oakcli stordiag resource_type [n] [-h]
```

### Parameters

Parameter	Description
<code>resource_type</code>	Prefix that depends on the configuration. See "Usage Notes."
<code>n</code>	(Optional) Disk number (starting with 0 and increasing to one less than the number of disks)

Parameter	Description
-h	(Optional) Display help for using the command.

### Usage Notes

Select the value for *resource\_type* based from one of the following options:

- On Oracle Database Appliance Version 1, use *d*.
- On Oracle Database Appliance with a single storage shelf, use *pd\_*.
- On Oracle Database Appliance with an expansion storage shelf, use *e0\_pd\_* for a disk in the storage shelf and use *e1\_pd\_* for a disk in the expansion storage shelf.

For Oracle Database Appliance systems that have internal storage, use the format *d[.]* to identify the disk to be diagnosed. For Oracle Database Appliance systems that have connected a storage shelf (and optional storage expansion shelf), use the format *e[0..1] pd\_[0..23]* to identify the disk to be diagnosed.

### Example 14-38 Running Diagnostic Tests on a Disk in the Expansion Storage Shelf

Runs the diagnostic tests on disk 3 in the expansion storage shelf:

```
# oakcli stordiag e1_pd_3
Node Name : hr0
Test : Diagnostic Test Description

  1 : OAK Check
      NAME          PATH          TYPE          STATE
STATE_DETAILS
      pd_03         /dev/sdw     HDD           ONLINE        Good

  2 : ASM Check
. . .
<output truncated>
```

## oakcli test asr

Use the `oakcli test asr` command to send a test trap to determine if Oracle Auto Service Request (Oracle ASR) is configured and working correctly.

The command returns a success message if Oracle ASR is functioning properly.

### Syntax

```
oakcli test asr [-h]
```

### Parameter

(Optional) `-h` displays help for using the command.

## Usage Notes

Run the command on both nodes. The Oracle ASR logs are always on the node where the ASR Manager is installed, which is the master node.

# oakcli unpack

Use the `oakcli unpack` command to unpack packages into the Oracle Appliance Manager repository.

## Syntax

```
oakcli unpack -package absolute_package_name
```

## Parameters

Parameters	Description
<i>absolute_package_name</i>	Identifies the package to be unpacked using the package's full absolute path and file name
-h	(Optional) Display help for using the command.

### Example 14-39 Unpacking Packages into the Oracle Appliance Manager Repository

Unpack the `p13982331_23000_Linux-86-62.zip` package, which was previously copied to `/tmp` on the current node, into the node's Oracle Appliance Manager command-line interface repository:

```
oakcli unpack -package /tmp/p13982331_23000_Linux-86-62.zip
```

# oakcli update

Use the `oakcli update` command to apply Oracle Database Appliance patches.

You can apply patches using the patch bundle and use the `--local` patching option to patch components one node at a time without impacting the other node. This reduces the downtime when applying the patch.

### Note:

If you want to update only the Oracle Database software, use the `oakcli upgrade` command.

## Syntax

```
oakcli update -patch version [--server | --storage | --database] [--local]
[--noreboot] | [--clean] | [--verify][-h]
```

## Parameters

Parameter	Description
- <i>patch version</i>	Patch version that you want to install. For example: 18.7.
--server	Contains the patches previously obtained in earlier releases from the Infrastructure (infra) and Grid Infrastructure (gi) patch updates.
--storage	Contains only patches for shared storage components.
--database	(Optional) Patches Oracle database homes.
--local	Patches the component only on the local node. By default, this is set to false.
--noreboot	(Optional) Node is not rebooted after patching.
--clean	(Optional) Cleans up all temporary files on the local node.
--verify	(Optional) Lists the patchable components on the node.
-h	(Optional) Display help for using the command.

## Usage Notes

After unpacking the patch bundle, but before applying the patch, verify the contents of the patch for the release.

When patching a virtualized platform, the `--local` option is supported, when Oracle Grid Infrastructure upgrade is not required. For example, after applying the patch for Oracle Database Appliance 18.7, Oracle Grid Infrastructure is upgraded to 18.0.0.0. The `--local` option then works.

```
# oakcli update -patch 18.7.0.0.0 --server --local
INFO: Local patch is running on the Node <0>
INFO: *****
INFO: ** Please do not patch both nodes simultaneously **
INFO: *****
INFO: DB, ASM, Clusterware may be stopped during the patch if required
INFO: Local Node may get rebooted automatically during the patch if
necessary
```

### Example 14-40 Verify the Contents of a Patch Bundle

Display the installed version and the version available in the 18.7 release patch bundle for each of the components on the node. When the latest supported version is installed, `Up-to-date` appears in the Proposed column.

```
# oakcli update -patch 18.7.0.0.0 --verify

INFO: 2017-02-13 14:20:37: Reading the metadata file now...

Patch Version      Component Name      Installed Version    Proposed
-----
Controller_INT     4.230.40-3739      Up-to-date
Controller_EXT     09.00.00.00        10.00.00.00
Expander           0291                Up-to-date

SSD_SHARED {
  [ c2d20,c2d21,c2d22,      A29A                Up-to-date
```

```

c2d23 ]

[ c2d0,c2d1,c2d2,c2d
3,c2d4,c2d5,c2d6,c2d
7,c2d8,c2d9,c2d10,c2
d11,c2d12,c2d13,c2d1
4,c2d15,c2d16,c2d17,
c2d18,c2d19 ]

}

SSD_LOCAL      0R3Q      Up-to-date
ILOM            3.2.7.26.a r112632 3.2.8.24 r114611
BIOS           38050100      38070000

IPMI           1.8.12.4      Up-to-date
HMP            2.3.5.2.5      2.3.5.2.8

OAK            12.2.1.4      18.7
OL             6.8      Up-to-date
GI_HOME        12.1.0.2.161018(2400 12.1.0.2.170117(2473
6101,23854735) 2082,24828633)
DB_HOME        12.1.0.2.160719(2305 12.1.0.2.170117(2473
4246,23054327) 2082,24828633)
ASR            5.5.1      Up-to-date

```

### oakcli update -patch Command Examples

Update the appliance with the 18.7 patch:

```
oakcli update -patch 18.7.0.0.0
```

Patch the Oracle Database homes on both nodes:

```
oakcli update -patch 18.7.0.0.0 --database
```

## oakcli update-cpucore

Use the `oakcli update-cpucore` command to enable a specified number of licensed CPU cores for Oracle Database Appliance.

### Prerequisites

If all cores are not enabled, you can enable multiples of 2 licensed CPU cores up to the maximum number of cores.

### File Path

```
/opt/oracle/oak/bin/oakcli
```

### Syntax

```
oakcli update-cpucore -cores number of cores per server [-h]
```

## Parameters

Parameter	Description
-cores	Defines the number of cores to enable per server, in multiples of 2. To enable all available cores, specify All instead of the number of cores.
-h	(Optional) Display help for using the command.

## Usage Notes

- This command applies only to bare metal deployments. It is not available on an Oracle Database Appliance Virtualized Platform.
- The number of licensed cores you enable must be a multiple of 2, up to the maximum number of cores.
- After the initial configuration, you cannot reduce the number of cores. You can purchase additional cores and increase the number of cores, up to the maximum number of cores for the hardware model.

### Example 14-41 Enabling 12 CPU Cores for Oracle Database Appliance

The following command enables 12 CPU cores on an Oracle Database Appliance system.

```
# oakcli update-cpucore -cores 12

Please enter the 'root' password:
Please re-enter the 'root' password:
Setting up SSH .....Completed
INFO : Running as root: /usr/bin/ssh -l root 192.0.2.1 /etc/rc.d/rc3.d/S90cpu-core
INFO : Running as root: /usr/bin/ssh -l root 192.0.2.1 /etc/rc.d/rc3.d/S90cpu-core
```

### Example 14-42 Enabling All CPU Cores for Oracle Database Appliance

The following command enables all cores on an Oracle Database Appliance system.

```
# oakcli update-cpucore -cores All

Please enter the 'root' password:
Please re-enter the 'root' password:
Setting up SSH .....Completed
INFO : Running as root: /usr/bin/ssh -l root 192.0.2.1 /etc/rc.d/rc3.d/S90cpu-core
INFO : Running as root: /usr/bin/ssh -l root 192.0.2.1 /etc/rc.d/rc3.d/S90cpu-core
```

## oakcli upgrade

Use the `oakcli upgrade` command to upgrade the Oracle Database software on Oracle Database Appliance.

For patching Oracle Database Appliance itself, use the `oakcli update` command.

### Syntax

```
oakcli upgrade database [-db db_names | -from source_home] -to destination_home
```

### Parameters

Parameter	Description
-db <i>db_names</i>	Specifies the name or names (in a comma-delimited list) of the database or databases you want to upgrade
-from <i>source_home</i>	Specifies the current Oracle Database home of the databases you are upgrading
-to <i>destination_home</i>	Specifies the Oracle Database home containing the version to which you want to upgrade the databases
-h	(Optional) Display help for using the command.

### Usage Notes

- You must include either a `-db` parameter or a `-from` parameter.
- Running the command with a `-db` parameter upgrades only the named databases, regardless of their current Oracle Database homes. If you include a `-from` parameter in addition to a `-db` parameter, then the command ignores the `-from` parameter. That is, the command upgrades named databases from other homes and ignores the databases in the named home if they are not listed in the `-db` parameter.
- Running the command without a `-db` parameter will upgrade all of the databases in the named Oracle Database home.
- You must always provide a `-to` parameter that names an existing Oracle Database home.

### Example

Upgrade an Oracle 11.2.0.3.1 database named `tpcc` from Oracle Database 11.2.0.3.1 to Oracle Database 12.1.0.2 using the Oracle Database home directory `OraDb12102_home1`:

```
oakcli upgrade database -db tpcc -to OraDb12102_home1
```

# oakcli validate

Validates the state of an Oracle Database Appliance or the viability of an operating system patch.

## Syntax

```
oakcli validate [[-V | -l | -h]] | [[-v][-f output_file] [-a | -d | -c checklist][-ver patch_version]]
```

## Parameters

Parameter	Description
-V	Display the version of oakValidation.
-l	List the items that can be checked (and their descriptions).
-h	(Optional) Display help for using the command.
-v	Show verbose output (must be used with a parameter that generates a validation report).
-f <i>output_file</i>	Send output to a file with a fully qualified file name, <i>output_file</i> , instead of to the screen (stdout).
-a	Run all system checks, including DiskCalibration. Oracle recommends that you use this command to validate system readiness before deployment. Do not run oakcli validate with this option on a busy production system, because the DiskCalibration system check can cause performance issues.
-d	Run only the default checks. The default checks are NetworkComponents, OSDiskStorage, SharedStorage, and SystemComponents.  The NetworkComponents validation check is not available on Oracle Database Appliance V1.
-c <i>checklist</i>	Run the validation checks for the items identified in <i>checklist</i> , a comma-delimited list. Use this parameter to check either a single item or subset of items.
-c ospath	Run the validation checks for the patch version identified in <i>patch_version</i> .
-ver <i>patch_version</i>	Report any reasons for not being able to patch Oracle Database Appliance with the patch named in <i>patch_version</i> .

## Listing All Checks and Their Descriptions

```
# oakcli validate -l

Checkname -- Description
=====
*SystemComponents -- Validate system components based on ilom sensor data
readings
*OSDiskStorage -- Validate OS disks and filesystem information
*SharedStorage -- Validate Shared storage and multipathing information
DiskCalibration -- Check disk performance with orion
*NetworkComponents -- Validate public and private network components
```



```
*StorageTopology -- Validate external JBOD connectivity
asr -- Validate asr components based on asr config file and ilom sensor
data readings
```

\* -- These checks are also performed as part of default checks

## Running All Checks

Enter the following command to run all checks:

```
# oakcli validate -a
```

## Validating Storage Cable Connections

Check the cable connections between the system controllers and the storage shelf, as well as the cable connection to the storage expansion shelf (if one is installed):

```
# oakcli validate -c storagetopology
```

Oracle recommends that you run the `oakcli validate -c StorageTopology` command *before* deploying the system. This will avoid and prevent problems during deployment due to wrong or missing cable connections. The output shown in the following example reports a successful configuration. If the cabling is not correct, you will see errors in your output.

```
# oakcli validate -c storagetopology
It may take a while. Please wait...
INFO : ODA Topology Verification
INFO : Running on Node0
INFO : Check hardware type
SUCCESS : Type of hardware found : X4-2
INFO : Check for Environment(Bare Metal or Virtual Machine)
SUCCESS : Type of environment found : Virtual Machine(ODA BASE)
SUCCESS : Number of External LSI SAS controller found : 2
INFO : Check for Controllers correct PCIe slot address
SUCCESS : External LSI SAS controller 0 : 00:15.0
SUCCESS : External LSI SAS controller 1 : 00:16.0
INFO : Check if powered on
SUCCESS : 1 : Powered-on
INFO : Check for correct number of EBODS(2 or 4)
SUCCESS : EBOD found : 2
INFO : Check for External Controller 0
SUCCESS : Controller connected to correct ebod number
SUCCESS : Controller port connected to correct ebod port
SUCCESS : Overall Cable check for controller 0
INFO : Check for External Controller 1
SUCCESS : Controller connected to correct ebod number
SUCCESS : Controller port connected to correct ebod port
SUCCESS : Overall Cable check for controller 1
INFO : Check for overall status of cable validation on Node0
SUCCESS : Overall Cable Validation on Node0
INFO : Check Node Identification status
SUCCESS : Node Identification
SUCCESS : Node name based on cable configuration found : NODE0
INFO : Check Nickname
SUCCESS : Nickname set correctly : Oracle Database Appliance - E0
INFO : The details for Storage Topology Validation can also be found in log
file=/opt/oracle/oak/log/<hostname>/storagetopology/
StorageTopology-2014-07-03-08:57:31_7661_15914.log
```

## Validating Oracle ASR

Enter the following syntax to validate your Oracle ASR configuration:

```
# oakcli validate -c asr
INFO: oak Asr information and Validations
RESULT: /opt/oracle/oak/conf/asr.conf exist
RESULT: ASR Manager ip:10.139.154.17
RESULT: ASR Manager port:1162
SUCCESS: ASR configuration file validation successfully completed
RESULT: /etc/hosts has entry 141.146.156.46 transport.oracle.com
RESULT: ilom alertmgmt level is set to minor
RESULT: ilom alertmgmt type is set to snmptrap
RESULT: alertmgmt snmp_version is set to 2c
RESULT: alertmgmt community_or_username is set to public
RESULT: alertmgmt destination is set to 10.139.154.17
RESULT: alertmgmt destination_port is set to 1162
SUCCESS: ilom snmp configuration for asr set correctly
RESULT: notification trap configured to ip:10.139.154.17
RESULT: notification trap configured to port:1162
SUCCESS: Asr notification trap set correctly
INFO: IP_ADDRESS HOST_NAME SERIAL_NUMBER ASR PROTOCOL SOURCE PRODUCT_NAME
INFO: -----
-----
10.170.79.98 oda-02-c 1130FMW00D Enabled SNMP ILOM SUN FIRE X4370 M2 SERVER
10.170.79.97 oda-01-c 1130FMW00D Enabled SNMP ILOM SUN FIRE X4370 M2 SERVER
INFO: Please use My Oracle Support 'http://support.oracle.com' to view the
activation status.
SUCCESS: asr log level is already set to Fine.
RESULT: Registered with ASR backend.
RESULT: test connection successfully completed.
RESULT: submitted test event for asset:10.139.154.17
RESULT: bundle com.sun.svc.asr.sw is in active state
RESULT: bundle com.sun.svc.asr.sw-frag is in resolved state
RESULT: bundle com.sun.svc.asr.sw-rulesdefinitions is in resolved state
RESULT: bundle com.sun.svc.ServiceActivation is in active state
SUCCESS: ASR diag successfully completed
```

## Checking the Viability of a Patch

Use the `oakcli validate ospatch -ver patch_version` command to report any reasons for not being able to patch Oracle Database Appliance with the patch named in *patch\_version*. Run this command before you attempt to patch Oracle Database Appliance to determine if it will succeed or if you need to make changes before applying the patch.

```
# oakcli validate -c ospatch -ver 12.1.2.5.0
INFO: Validating the OS patch for the version 12.1.2.5.0
WARNING: 2015-10-10 06:30:32: Patching sub directory /opt/oracle/oak/pkgrepos/
orapkgs/OEL/5.10/Patches/5.10.1 is not existing
INFO: 2015-10-10 06:30:32: May need to unpack the Infra patch bundle for the
version: 12.1.2.5.0
ERROR: 2015-10-10 06:30:32: No OS patch directory found in the repository
```

## Validating Hardware System and Network Components

The following command runs system checks to validate hardware system components and Oracle Database Appliance network components:

```
# oakcli validate -c SystemComponents,NetworkComponents
```

## oakcli Virtual Disk Commands

Use the oakcli virtual disk (vdisk) commands to manage virtual disks on Oracle Database Appliance virtualized platform.

- [oakcli create vdisk](#)  
Use the `oakcli create vdisk` command to create a new virtual disk in a shared repository on Oracle Database Appliance Virtualized Platform.
- [oakcli clone vdisk](#)  
Use the `oakcli clone vdisk` command to create clones of virtual disks.
- [oakcli delete vdisk](#)  
Use the `oakcli delete vdisk` command to delete a virtual disk from a shared repository on Oracle Database Appliance Virtualized Platform.
- [oakcli show vdisk](#)  
Use the `oakcli show vdisk` command to display information about virtual disks on Oracle Database Appliance Virtualized Platform.

### oakcli create vdisk

Use the `oakcli create vdisk` command to create a new virtual disk in a shared repository on Oracle Database Appliance Virtualized Platform.

#### Syntax

```
oakcli create vdisk vdisk_name -repo repository_name -size size -type shared|local -sparse [-h]
```

#### Parameters

Parameter	Description
<code>vdisk_name</code>	Name assigned to the virtual disk that is unique within the name repository
<code>-repo repository_name</code>	Name of the shared repository where the virtual disk will be created and from which it will acquire its storage
<code>-size size</code>	Amount of storage to be assigned from the shared repository to the shared disk. The default unit is G (for gigabytes) and the minimum size is 500 M (for megabytes)
<code>-type shared   local</code>	Sets the option of allowing the virtual disk to be shared by more than one virtual machine ( <code>shared</code> ) or used by only one virtual machine ( <code>local</code> )
<code>-sparse</code>	Creates a sparse vdisk
<code>-h</code>	(Optional) Display help for using the command.

#### Example

Create a virtual disk named `t2g` in the shared repository named `repoprod1` for use by only one virtual machine at a time in that repository. Assign the `t2g` virtual disk 2 GB in the `repoprod1` shared repository.

```
oakcli create vdisk t2g -repo repoprod1 -type local -size 2G
```

## oakcli clone vdisk

Use the `oakcli clone vdisk` command to create clones of virtual disks.

### Syntax

```
oakcli clone vdisk new_vdisk_name -repo repo_name -src source_vdisk_name [-h]
```

### Parameters

Parameter	Description
<i>new_vdisk_name</i>	Name given to the clone virtual disk
<i>repo_name</i>	Name of the repository source for the virtual disk being cloned
<i>source_vdisk_name</i>	Name of the virtual disk being cloned
-h	(Optional) Display help for using the command.

### Usage

The virtual disk and `vm.cfg` files are stored in the following directories:

- Dom0: `/Repositories/vm_repo_name/.ACFS/snaps/vm_name/VirtualMachines/vm_name`
- ODA\_BASE: `/app/sharedrepo/vm_repo_name/.ACFS/snaps/vm_name/VirtualMachines/vm_name`

### Example 14-43 Cloning a Virtual Disk

Clone a virtual disk named `my_vdisk2` from an existing virtual disk named `vdisk1` that is stored in the repository named `vrep01`:

```
oakcli clone vdisk my_vdisk2 -repo vrep01 -src vdisk1
```

## oakcli delete vdisk

Use the `oakcli delete vdisk` command to delete a virtual disk from a shared repository on Oracle Database Appliance Virtualized Platform.

### Syntax

```
oakcli delete vdisk vdisk_name -repo repository_name [-h]
```

### Parameters

Parameter	Description
<i>vdisk_name</i>	Name assigned to the virtual disk
-repo <i>repository_name</i>	Name of the shared repository where the virtual disk was created

Parameter	Description
-h	(Optional) Display help for using the command.

**Example**

Remove a virtual disk named `t2g` from the shared repository named `repoprod1`:

```
oakcli delete vdisk t2g -repo repoprod1
```

## oakcli show vdisk

Use the `oakcli show vdisk` command to display information about virtual disks on Oracle Database Appliance Virtualized Platform.

**Syntax**

```
oakcli show vdisk [vdisk_name -repo repository_name] [-h]
```

**Parameters**

Parameter	Description
<code>vdisk_name</code>	(Optional) Display information for just one virtual disk.
<code>-repo repository_name</code>	Required parameter if a virtual disk is specified in the command
-h	(Optional) Display help for using the command.

**Examples**

Here are examples of how to use the `oakcli show vdisk` command.

**Example 14-44 Displaying Information for All Virtual Disks**

Display information about all virtual disks on Oracle Database Appliance Virtualized Platform:

```
# oakcli show vdisk
```

```

NAME                SIZE  TYPE  REPOSITORY
myvdisk             10G  local vdiskrepo
newv                 1G   local vdiskrepo
```

**Example 14-45 Displaying Information for a Single Virtual Disk**

Display information for the virtual disk named `myvdisk1`:

```
# oakcli show vdisk myvdisk1
Resource: myvdisk_vdiskrepo
Name      : myvdisk_vdiskrepo
RepoName  : vdiskrepo
Size      : 10G
```

```
Type          : local
VmAttached    : 0
```

## oakcli Virtual Machine Commands

Use the oakcli virtual machine commands to list and manage virtual machines (VMs).

- [oakcli clone vm](#)  
Use the `oakcli clone vm` command to create clones and snap clones of virtual machines.
- [oakcli configure vm](#)  
Use the `oakcli configure vm` command to configure a virtual machine on Oracle Database Appliance Virtualized Platform and to increase or decrease resource allocation to user domains.
- [oakcli delete vm](#)  
Use the `oakcli delete vm` command to delete a virtual machine.
- [oakcli migrate vm](#)  
Use the `oakcli migrate vm` command to migrate a currently running virtual machine to another node.
- [oakcli modify vm](#)  
Use the `oakcli modify vm` command to modify an existing virtual machine.
- [oakcli show vm](#)  
Use the `oakcli show vm` command to display information about virtual machines.
- [oakcli show vmconsole](#)  
Use the `oakcli show vmconsole` command to open a GUI virtual machine console to manage a specific virtual machine.
- [oakcli start vm](#)  
Use the `oakcli start vm` command to start a virtual machine on a node.

### oakcli clone vm

Use the `oakcli clone vm` command to create clones and snap clones of virtual machines.

#### Syntax

To create a virtual machine from a template:

```
oakcli clone vm vm_name -vmtemplate template_name -repo repo_name [-node 0/1] [-driverdomain]
```

To create a snapshot clone of an existing virtual machine:

```
oakcli clone vm vm_name -vm src_vm_name -snap [-force] [-driverdomain]
```

To create a virtual machine snapshot from a template:

```
oakcli clone vm <vm_name> -vmtemplate src_vmtmpl_name -snap [-driverdomain]
```

### Parameters

Parameter	Description
-vm <i>vm_name</i>	Identifies the name given to the new cloned virtual machine.
-vmtemplate <i>template_name</i>	Identifies the name of the template containing the virtual machine that you want to clone.
-repo <i>repo_name</i>	Identifies the name of the repository that contains the template being cloned.
-node <i>0   1</i>	Identifies the Oracle Database Appliance node that contains the shared repository from which the virtual machine is to be cloned.
-vm <i>src_name</i>	Identifies the name of the virtual machine that is to be cloned.
-snap	(Optional) Creates a snapshot of the source virtual machine or virtual machine template.
-driverdomain	(Optional) Creates the virtual machine with the driver domain option.  The driver domain option improves performance by enabling guest virtual machines to use ODA_BASE instead of Dom0 to access virtual disks. Newly created virtual disks are mounted directly from ODA_BASE to a guest virtual machine.
-force	(Optional) When cloning a source virtual machine, the -force option enables you to make a change from the source virtual machine. For example, if the source file does not use a driver domain, you can use -force -driverdomain to create a clone virtual machine that does use the driver domain.
-h	(Optional) Displays help for using the command.

### Usage Notes

- The -node parameter must be used when you clone from a shared repository. The -node parameter is invalid for non-shared repositories.
- The virtual disk and vm.cfg files are stored in the following directories:
  - Dom0: /Repositories/*vm\_repo\_name*/.ACFS/snaps/*vm\_name*/VirtualMachines/*vm\_name*
  - ODA\_BASE: /app/sharedrepo/*vm\_repo\_name*/.ACFS/snaps/*vm\_name*/VirtualMachines/*vm\_name*
- Live migration of driver domain virtual machines is not supported.
- The driver domain option is supported with the following guest operating systems:
  - Oracle Linux with the latest Unbreakable Enterprise Kernel 2 (UEK2), Unbreakable Enterprise Kernel 3 (UEK3), or Unbreakable Enterprise Kernel Release 4 (UEK R4).
  - Microsoft Windows with Oracle VM Windows PV Driver 3.4.1. Oracle VM Windows PV Driver 3.4.1 release is available for download on My Oracle Support as patch number 23346086.

- Oracle Solaris 11.3 or higher x86.
- The driver domain only works when you add virtual disks to a guest virtual machine. When `-driverdomain` is specified, the cloned virtual machine is in driver domain mode. The corresponding virtual machine configuration file, `vm.cfg`, has the following disk entries:

When `-driverdomain` is specified, the cloned virtual machine is in driver domain mode. The corresponding virtual machine configuration file, `vm.cfg`, has the following disk entries:

```
disk = [u'file:/OVS/Repositories/repo5/.ACFS/snaps/vm10/
VirtualMachines/
vm10/System.img,xvda,w',
u'file:/u01/app/sharedrepo/repo5/.ACFS/snaps/
vm10/VirtualMachines/vm10/u01.img,xvdb,w,oakDom1']
```

All disks, with the exception of the `xvda` boot disk, have the path from `oakDom1`, that is `odabase`.

- The driver domain functionality applies to non-system disks. Once a virtual machine is created in driver domain mode, any new vDisks are added in driver domain mode.
- To determine if a virtual machine is configured in driver domain mode, use the `oakcli show vm vmname` command. When the virtual machine is in driver mode, the output for the `DriverDomain` attribute is `TRUE`.

#### Example 14-46 Creating a Virtual Machine Image

Create a virtual machine image named `myol6u_test` from the virtual machine template named `myol6u_15gb1`, which is stored in the shared repository named `repo2` on Node 0:

```
# oakcli clone vm myol6u_test -vmtemplate myol6u_15gb1 -repo repo2 -node 0
```

#### Example 14-47 Creating a Virtual Machine Image in Driver Domain Mode

Create a virtual machine image named `myol6u_test` from the virtual machine template named `myol6u_15gb1`, which is stored in the shared repository named `repo2` on Node 0 in driver domain mode:

```
# oakcli clone vm myol6u_test -vmtemplate myol6u_15gb1 -repo repo2 -node 0
-driverdomain
```

## oakcli configure vm

Use the `oakcli configure vm` command to configure a virtual machine on Oracle Database Appliance Virtualized Platform and to increase or decrease resource allocation to user domains.

You must restart the domain for the resource allocation change to take effect.



## Syntax

```
oakcli configure vm name [-vcpu cpucount -maxvcpu maxcpu -cpuprio priority
-cpucap cap -memory memsize -maxmemory max_memsize -os sys -keyboard lang -mouse
mouse_type -domain dom -network netlist -autostart astart -disk disks -bootoption
bootstrap -cpupool pool -prefnode 0|1 -failover true|false][-h]
```

## Parameters

Parameter	Description
<code>name</code>	The name assigned to the virtual machine.
<code>-vcpu <i>cpucount</i></code>	Number of nodes assigned to the virtual machine. The range is 1 to 72. This number depends on your Oracle Database Appliance configuration
<code>-maxvcpu <i>maxcpu</i></code>	Maximum number of CPUs that the virtual machine can consume. The range is 1 to 72. This number depends on your Oracle Database Appliance configuration.
<code>-cpuprio <i>priority</i></code>	Priority for CPU usage, where larger values have higher priority. The range is 1 to 65535.
<code>-cpucap <i>cap</i></code>	Percentage of a CPU the virtual machine can receive. The range is 10 to 100.
<code>-memory <i>memsize</i></code>	Amount of memory given to the virtual machine: (1 to 248)G to (1to 760G) or (1 to 253952)M to (1 to 778240)M, based on RAM. The default is M.
<code>-maxmemory <i>max_memsize</i></code>	Maximum amount of memory allowed for the virtual machine: (1 to 248)G to (1 to 760)G or (1-253952)M to (1-778240)M, based on RAM. The default is M.
<code>-os <i>sys</i></code>	Operating system used by the virtual machine (WIN_2003, WIN_2008, WIN_7, WIN_VISTA, OTHER_WIN, OL_4, OL_5, OL_6, RHL_4, RHL_5, RHL_6, LINUX_RECOVERY, OTHER_LINUX, SOLARIS_10, SOLARIS_11, OTHER_SOLARIS, or NONE)
<code>-keyboard <i>lang</i></code>	Keyboard used by virtual machine (en-us, ar, da, de, de-ch, en-gb, es, et, fi, fo, fr, fr-be, fr-ca, hr, hu, is, it, ja, lt, lv, mk, nl, n--be, no, pl, pt, pt-br, ru, sl, sv, th, or tr)
<code>-mouse <i>mouse_type</i></code>	Mouse type used by the virtual machine (OS_DEFAULT, PS2_MOUSE, USB_MOUSE, or USB_TABLET)
<code>-domain <i>dom</i></code>	Domain type from the following options: <ul style="list-style-type: none"> <li>• Hardware virtualized guest (XEN_HVM) <ul style="list-style-type: none"> <li>- The kernel or operating system is not virtualization-aware and can run unmodified.</li> <li>- Device drivers are emulated.</li> </ul> </li> <li>• Para virtualized guest (XEN_PVM) <ul style="list-style-type: none"> <li>- The guest is virtualization-aware and is optimized for a virtualized environment.</li> <li>- PV guests use generic, idealized device drivers.</li> </ul> </li> <li>• Hardware virtualized guest (XEN_HVM_PV_DRIVERS) <ul style="list-style-type: none"> <li>The PV drivers are hypervisor-aware and significantly reduce the overhead of emulated device input/output.</li> </ul> </li> <li>• Hardware virtualized guest (UNKNOWN)</li> </ul>
<code>-network <i>netlist</i></code>	MAC address and list of networks used by the virtual machine
<code>-autostart <i>astart</i></code>	Startup option for virtual machine (always, restore, or never)

Parameter	Description
<code>-disk disks</code>	List of disks (slot, disktype, and content) used by virtual machine
<code>-bootoption bootstrap</code>	Boot option used to bootstrap the virtual machine (PXE, DISK, or CDROM)
<code>-cpupool pool</code>	Named CPU pool assigned to the virtual machine
<code>-prefnode 0 1</code>	Preferred node on which the virtual machine will attempt to start (Node 0 or Node 1). This parameter is only valid for virtual machines created in shared repositories.
<code>-failover true  false</code>	Allow (use the keyword "true") or disallow (use the keyword "false") the virtual machine to start or restart on a node other than the node defined by the <code>-prefnode</code> parameter. This parameter is only valid for virtual machines created in shared repositories.
<code>-h</code>	(Optional) Display help for using the command.

### Usage Notes

- All of the parameters, except for *name*, are optional.
- You must include at least one optional parameter for the command to work.
- When you create a virtual machine, select the Processor Cap as a percentage, between 10 and 100%. The default is 100%. This value is then converted to a CPU utilization limit in the `vm.cfg` file for the virtual machine. The value set in the `vm.cfg` file limits the amount of CPU a guest is allowed to consume. If the Processor Cap is set at 100% in Oracle VM, then the value set in `vm.cfg` is 0, which means there is no limit to CPU utilization.



#### See Also:

Oracle VM release 3.1 documentation contains more information about the options in the preceding table. Access the library at the following URL:

[http://docs.oracle.com/cd/E27300\\_01](http://docs.oracle.com/cd/E27300_01)

For example, refer to 2.8. Virtual Machines for information about the the `-domain dom` options:

[http://docs.oracle.com/cd/E27300\\_01/E27309/html/vmusg-ovm-vms.html](http://docs.oracle.com/cd/E27300_01/E27309/html/vmusg-ovm-vms.html)

### Changing the Number of Virtual CPUs

This command example changes the number of virtual CPUs to 3, and changes the virtual memory size to 4 GB in a virtual machine named `odarep01`:

```
oakcli configure vm odarep01 -vcpu 3 -memory 4196
```

## oakcli delete vm

Use the `oakcli delete vm` command to delete a virtual machine.

### Syntax

```
oakcli delete vm vm_name [-server node_number] [-h]
```

### Parameters

Parameter	Description
<code>vm <i>vm_name</i></code>	(Optional) Name of the virtual machine to be deleted
<code>-server <i>node_number</i></code>	(Optional) Oracle Database Appliance node from which you want to remove the virtual machine. If this optional parameter is not included, then the virtual machine is removed from both nodes.
<code>-h</code>	(Optional) Display help for using the command.

### Example

Delete the `ovu22` virtual machine from Node 1:

```
oakcli delete vm ovu22 -server 1
```

## oakcli migrate vm

Use the `oakcli migrate vm` command to migrate a currently running virtual machine to another node.

### Syntax

```
oakcli migrate vm vmname [-h]
```

### Parameters

Parameter	Description
<code><i>vmname</i></code>	Name of the virtual machine to be migrated
<code>-h</code>	(Optional) Display help for using the command.

## oakcli modify vm

Use the `oakcli modify vm` command to modify an existing virtual machine.

### Syntax

```
oakcli modify vm vmname [-attachdisk|-deletenetworkvlanname] [-s  
key1:value1;key2:value2;...] [-addnetwork|-deletenetworkvlanname] [-h]
```

## Parameters

Parameter	Description
<code>-attachvdiskvdisk_name</code>	(Optional) Attaches the named VDisk (virtual disk) to the named virtual machine.
<code>-detachvdiskvdisk_name</code>	(Optional) Detaches the named VDisk disk from the named virtual machine.
<code>-s</code> <code>key1:value1;key2:value2;...</code>	(Optional) Identifies a message consisting of one or more semicolon separated key:value pairs to send to the ovmf utility. Each key and value is separated by a colon (:) and each key/value pair is separated from the next key/value pair by quotation marks.
<code>-addnetworkvlannname</code>	(Optional) Adds a VLAN network to the named virtual machine.
<code>-deletenetworkvlannname</code>	(Optional) Removes a VLAN network from the named virtual machine.
<code>-h</code>	(Optional) Displays help for using the command.

## Usage Notes

- Do not use the `-attachvdisk` or the `-detachvdisk` option with the `-addnetwork`, `-deletenetwork`, or `-s` parameters.
- Include only one of the `-addnetwork`, `-deletenetwork`, or `-s` parameters when you use this command.

### Example 14-48 Sending a Message to a Running Virtual Machine

Update the `root` user password for the `gc_11g` virtual machine:

```
oakcli modify vm gc_11g -s "com.oracle.linux.root-password:password"
```

## oakcli show vm

Use the `oakcli show vm` command to display information about virtual machines.

### Syntax

```
oakcli show vm [vm_name | -h]
```

### Parameters

Parameter	Description
<code>vm_name</code>	(Optional) The name of the virtual machine for which details should be displayed. If you do not specify this parameter, then information for all the virtual machines is displayed.
<code>-h</code>	(Optional) Display help for using the command.

### Usage Notes

When a virtual machine is configured in driver domain mode, the output of the `oakcli show vm vmname` command displays `TRUE` for the `DriverDomain` attribute.

## Examples

Here are examples of how to use the `oakcli show vm` command.

### Example 14-49 Displaying Details for All Virtual Machines

Display the virtual machine names, memory and vCPU allocations, status, virtual disks, and repository name for all virtual machines:

```
# oakcli show vm
```

NAME	NODENUM	MEMORY	VCPU	STATE	REPOSITORY
sample5_odarepo1	0	2048	2	OFFLINE	odarepo1
sample6_odarepo1	0	2048	2	OFFLINE	odarepo2
test1_odarepo1	0	2048	2	OFFLINE	odarepo1
test2_odarepo2	1	2048	2	OFFLINE	odarepo2
vm1_odarepo1	0	4096	4	ONLINE	odarepo1
vm2_odarepo2	1	2048	2	OFFLINE	odarepo2
win_vm1	0	1500	1	ONLINE	odarepo1

### Example 14-50 Displaying Information for a Single Virtual Machine

Display information about the `vm1_odarepo1` virtual machine:

```
oakcli show vm vm1_odarepo1
Resource: vm1_odarepo1
  AutoStart      :      restore
  CPUPriority    :      100
  Disks          :      |file:/OVS/Repositories/odarepo1/Vi
                    |rtualMachines/vm1_odarepo1/System.i
                    |mg,xvda,w||file:/OVS/Repositories/o
                    |darepo1/VirtualMachines/vm1_odarepo
                    |1/u01.img,xvdb,w|
  Domain         :      XEN_PVM
  ExpectedState  :      online
  FailOver       :      false
  IsSharedRepo   :      false
  Keyboard       :      en-us
  MaxMemory      :      3000
  MaxVcpu        :      4
  Memory         :      4096
  Mouse          :      OS_DEFAULT
  Name           :      vm1_odarepo1
  Networks       :      |mac=00:21:F6:00:00:E4|
  NodeNum        :      0
  NodeNumStart   :
  OS             :      OL_5
  PrivateIP      :      None
  ProcessorCap   :      100
  RepoName       :      odarepo1
  State          :      Online
  TemplateName   :      otml_sample1_odarepo1
  Vcpu           :      4
```

```

cpupool      :      twocpu
vncport      :      5901

```

## oakcli show vmconsole

Use the `oakcli show vmconsole` command to open a GUI virtual machine console to manage a specific virtual machine.

### Syntax

```
oakcli show vmconsole vm_name [-h]
```

### Parameters

Parameter	Description
<i>vm_name</i>	Name of the virtual machine for which you want to open a console.
-h	(Optional) Display help for using the command.

### Example 14-51 Opening a Virtual Machine Console

Open a console for the virtual machine named `vm1_odarepol`:

```
oakcli show vmconsole vm1_odarepol
```

## oakcli start vm

Use the `oakcli start vm` command to start a virtual machine on a node.

### Syntax

```
oakcli start vm vm_name [-node node_number] [-d] [-h]
```

### Parameters

Parameter	Description
<i>vm_name</i>	<i>vm_name</i> is the name of the virtual machine to be started.
-node <i>node_number</i>	Specifies the node on which to start the virtual machine. <i>node_number</i> is the number of the node where it is to be started, either 0 or 1. If -node is not specified, a virtual machine is started on both nodes.
-d	Provides details about the virtual machine starting procedure
-h	(Optional) Display help for using the command.

**Example 14-52 Starting a Virtual Machine on Node 0**

Start the virtual machine named `vm1_odarepo1` on Node 0.

```
oakcli start vm vm_odarepo1 -node 0
```

## oakcli Virtual Machine Template Commands

Use the oakcli Virtual Machine template commands to list and manage virtual machine (VM) templates.

- [oakcli configure vmtemplate](#)  
Use the `oakcli configure vmtemplate` command to configure a virtual machine template on Oracle Database Appliance Virtualized Platform.
- [oakcli delete vmtemplate](#)  
Use the `oakcli delete vmtemplate` command to delete a virtual machine template.
- [oakcli import vmtemplate](#)  
Use the `oakcli import vmtemplate` command to import virtual machine templates.
- [oakcli modify vmtemplate](#)  
Use the `oakcli modify vmtemplate` command to add networks to or delete networks from an existing virtual machine template.
- [oakcli show vmtemplate](#)  
Use the `oakcli show vmtemplate` command to display information about virtual machine templates.

### oakcli configure vmtemplate

Use the `oakcli configure vmtemplate` command to configure a virtual machine template on Oracle Database Appliance Virtualized Platform.

#### Syntax

```
oakcli configure vmtemplate name [-vcpu cpucount -maxvcpu maxcpu -cpuprio
priority -cpucap cap -memory memsize -maxmemory max_memsize -os sys -
keyboard
lang -mouse mouse_type -domain dom -network netlist -disk disks][h]
```

#### Parameters

Parameter	Description
<i>name</i>	Name assigned to the virtual machine template
-vcpu <i>cpucount</i>	Number of nodes assigned to virtual machines cloned from the template.
-maxvcpu <i>maxcpu</i>	Maximum number of CPUs that virtual machines cloned from the template can consume.
-cpuprio <i>priority</i>	Priority for CPU usage, where larger values have higher priority (1 to 256).

Parameter	Description
-cpucap <i>cap</i>	Percentage of a CPU that virtual machines cloned from the template can receive (1 to 100).
-memory <i>memsize</i>	Amount of memory given to virtual machines cloned from the template (1G to 88 G or 1M to 90112M)
-maxmemory <i>max_memsize</i>	Maximum amount of memory allowed for virtual machines cloned from the template
-os <i>sys</i>	Operating system used by virtual machines cloned from the template (WIN_2003, WIN_2008, WIN_7, WIN_VISTA, OTHER_WIN, OL_4, OL_5, OL_6, RHL_4, RHL_5, RHL_6, LINUX_RECOVERY, OTHER_LINUX, SOLARIS_10, SOLARIS_11, OTHER_SOLARIS, or NONE)
-keyboard <i>lang</i>	Keyboard used by virtual machines cloned from the template (en-us, ar, da, de, de-ch, en-gb, es, et, fi, fo, fr, fr-be, fr-ca, hr, hu, is, it, ja, lt, lv, mk, nl, n--be, no, pl, pt, pt-br, ru, sl, sv, th, or tr)
-mouse <i>mouse_type</i>	Mouse type used by virtual machines cloned from the template (OS_DEFAULT, PS2_MOUSE, USB_MOUSE, or USB_TABLET)
-domain <i>dom</i>	Domain type from the following options: <ul style="list-style-type: none"> <li>• Hardware virtualized guest (XEN_HVM) <ul style="list-style-type: none"> <li>- The kernel or operating system is not virtualization-aware and can run unmodified.</li> <li>- Device drivers are emulated.</li> </ul> </li> <li>• Para virtualized guest (XEN_PVM) <ul style="list-style-type: none"> <li>- The guest is virtualization-aware and is optimized for a virtualized environment.</li> <li>- PV guests use generic, idealized device drivers.</li> </ul> </li> <li>• Hardware virtualized guest (XEN_HVM_PV_DRIVERS) <ul style="list-style-type: none"> <li>The PV drivers are hypervisor-aware and significantly reduce the overhead of emulated device input/output.</li> </ul> </li> </ul>
-network <i>netlist</i>	MAC address and list of networks used by virtual machines cloned from the template
-disk <i>disks</i>	List of disks (slot, disktype, and content) used by virtual machines cloned from the template
-h	(Optional) Display help for using the command.

### Usage Notes

- All of the parameters, except for *name*, are optional.
- You must include at least one optional parameter for the command to work.



 **See Also::**

Oracle VM Release 3.1 documentation, which is available at the following URL:

[http://docs.oracle.com/cd/E27300\\_01](http://docs.oracle.com/cd/E27300_01) for more information about the options in the preceding table.

For example, see 2.8. Virtual Machines for details about the option `-domain dom`

[http://docs.oracle.com/cd/E27300\\_01/E27309/html/vmusg-ovm-vms.html](http://docs.oracle.com/cd/E27300_01/E27309/html/vmusg-ovm-vms.html)

**Setting Values for a Virtual Machine**

Set values for the following configuration values in the virtual machine template named `myo15u7_10gb`:

```
oakcli configure vmtemplate myo15u7_10gb
-vcpu 2 -maxvcpu 4 -cpucap 40 -memory 1536M -maxmemory 2G
-network "[ 'type=netfront,bridge=net1' ]" -os OTHER_LINUX
```

- `-vcpu 2` = Two CPUs will assigned when the virtual machine starts up
- `-maxvcpu 4` = The maximum number of CPUs that can be assigned to the virtual machine is 4.
- `-cucap 40` = The maximum percentage of a CPU's capacity that will be assigned to the virtual machine is 40%.
- `-memory 1536M` = The amount of memory assigned when the virtual machine starts up is 1536 MB.
- `-maxmemory 2G` = The maximum amount of memory that can be assigned to the virtual machine is 2 GB.
- `-network type=netfront,bridge=net1` = This is the list of networks used by virtual machines cloned from the template.
- `-os` = The operating system used by the virtual machine is OTHER\_LINUX.

## oakcli delete vmtemplate

Use the `oakcli delete vmtemplate` command to delete a virtual machine template.

**Syntax**

```
oakcli delete vmtemplate template_name [-server=node_number][-h]
```

**Parameters**

Parameter	Description
<i>template_name</i>	Name of the virtual machine template to be removed

Parameter	Description
<code>-server node_number</code>	(Optional) Oracle Database Appliance node from which you want to remove the virtual machine template. If this optional parameter is not included, then the virtual machine template is removed from both nodes.
<code>-h</code>	(Optional) Display help for using the command.

**Example**

Delete the `ovu22` virtual machine template from both nodes:

```
oakcli delete vmtemplate ovu22
```

## oakcli import vmtemplate

Use the `oakcli import vmtemplate` command to import virtual machine templates.

**Syntax**

```
oakcli import vmtemplate vmtemplatename -files image_files | -assembly
assembly_file -repo repo_name [- node 0 | 1 ][-h]
```

**Parameters**

Parameter	Description
<code>vmtemplatename</code>	Name that you want to assign to the template
<code>-files</code>	Use the <code>-files</code> option when importing one or more files that comprise a template.
<code>image_files</code>	<code>image_files</code> is one of the following: <ul style="list-style-type: none"> <li>• A single template file name</li> <li>• A comma-separated list of files that comprise a single template</li> <li>• A URL enclosed in single quotation marks that links to a template file</li> </ul>
<code>-assembly</code>	Use the <code>-assembly</code> option when importing an assembly file.
<code>assembly_file</code>	An assembly file, or a URL enclosed in single quotation marks, that links to an assembly file
<code>repo_name</code>	Name of the repository to store the template or templates that you are importing
<code>-node</code>	When you are importing to a shared repository, use the <code>-node</code> option with a value of 0 or 1 to identify the node.
<code>-h</code>	(Optional) Display help for using the command.

**Usage Notes**

- Include only one of the options, `-files` or `-assembly`, each time you run this command. You cannot include both of these options in the same statement.
- If the command imports more than one template from an assembly, then each template will automatically be given a unique name. These template names will

include the name given in the `vmtemplate vmtemplatename` clause followed by a sequence number, such as `vmtemplatename1`, `vmtemplatename2`, and `vmtemplatename3`.

- When importing into a shared repository, you must include the `-node` option with a valid node number, 0 or 1. Using the `-node` option for imports into non-shared repositories will cause the command to fail.

### Examples

Here are examples of how to use the `oakcli import vmtemplate` command.

#### Example 14-53 Importing a Virtual Machine Template from Dom0

Import the required template (`OVM_OL5U7_X86_64_PVM_10GB.tgz`) from the `/OVS` directory in Dom0 into the `odarepo1` repository and name the template file `OL5U7`:

```
oakcli import vmtemplate OL5U7 -files /OVS/OVM_OL5U7_X86_64_PVM_10GB.tgz -  
repo odarepo1
```

#### Example 14-54 Importing a Virtual Machine Template from a Remote Server

Import a template from a remote server using a URL to identify the server and the template file:

```
oakcli import vmtemplate OL5U6 -files 'http://example.com/vm-template/  
OEL-5/OVM_OL5U6_X86_64_PVM_10GB.tgz' -repo odarepo2
```

#### Example 14-55 Importing Virtual Machine Templates from an Assembly on a Remote Server

Import the templates contained in the assembly file stored on a remote server at the URL provided into the `odarepo1` repository:

```
oakcli import vmtemplate OL6U1 -assembly 'http://example.com/assemblies/  
OEL6/OVM_OL6U1_x86_PVHVM.ova' -repo odarepo1
```

#### Example 14-56 Importing Virtual Machine Templates Into a Shared Repository From an Assembly on a Remote Server

Import the templates contained in the assembly file stored on a remote server at the URL provided into a shared repository named `repo4` on Node 1:

```
oakcli import vmtemplate OL6U1 -assembly 'http://example.com/assemblies/  
OEL6/OVM_OL6U1_x86_PVHVM.ova' -repo repo4 -node 1
```

## oakcli modify vmtemplate

Use the `oakcli modify vmtemplate` command to add networks to or delete networks from an existing virtual machine template.

### Syntax

```
oakcli modify vmtemplate vmtemplatename [-addnetwork|-deletenetworkvlanname] [-h]
```

### Parameters

Parameter	Description
<code>-addnetwork<i>vlanname</i></code>	(Optional) Adds a VLAN network to the named virtual machine template
<code>-deketenetwork<i>vlanname</i></code>	(Optional) Deletes a VLAN network from the named virtual machine template
<code>-h</code>	(Optional) Displays help for using the command.

### Example 14-57 Modifying the Network Defined in a Virtual Machine Template

Replace the network assigned to the `gc_11g` virtual machine template with the `net1` network:

```
oakcli modify vmtemplate gc_11g -addnetwork net1
```

## oakcli show vmtemplate

Use the `oakcli show vmtemplate` command to display information about virtual machine templates.

### Syntax

```
oakcli show vmtemplate [vmtemplate_name | -h]
```

### Parameters

Parameter	Description
<code><i>vmtemplate_name</i></code>	(Optional) The name of the virtual template for which details should be displayed. If you do not specify this parameter, then information for all of the virtual templates is displayed.
<code>-h</code>	(Optional) Display help for using the command.

### Example 14-58 Display Information About a Virtual Template

Display information about the `sample1_odarepol` virtual template:

```
# oakcli show vmtemplate sample_odarepol
Resource: sample1_odarepol
  CPUPriority      :      100
  Disks            :      |file:/OVS/Repositories/odarepol/Te
```

```

mplates/otml_sample1_odarepol/Syste
m.img,xvda,w|file:/OVS/Repositorie
s/odarepol/Templates/otml_sample1_o
darepol/u01.img,xvdb,w|
Domain      : XEN_PVM
Keyboard    : en-us
MaxMemory   : 2048
MaxVcpu     : 2
Memory      : 2048
Mouse       : OS_DEFAULT
Name        : sample1_odarepol
Networks    : |bridge=priv1||bridge=net1||bridge=
              net2|
NodeNum     : 0
OS          : OL_5
ProcessorCap : 100
RepoName    : odarepol
Vcpu       : 2

```

## oakcli VLAN Management Commands for Virtual Platform

Use the oakcli VLAN commands to list and manage virtual local area networks (VLANs) on an Oracle Database Appliance virtualized platform.

- [oakcli create vlan](#)  
Use the `oakcli create vlan` command to create a new virtual local area network (VLAN) on an Oracle Database Appliance Virtualized Platform node.
- [oakcli delete vlan](#)  
Use the `oakcli delete vlan` command to delete a virtual local area network.
- [oakcli show vlan](#)  
Use the `oakcli show vlan` command to display information about virtual local area networks (VLANs) configured on Oracle Database Appliance.

### oakcli create vlan

Use the `oakcli create vlan` command to create a new virtual local area network (VLAN) on an Oracle Database Appliance Virtualized Platform node.

#### Syntax

```
oakcli create vlan vlan_name -vlanid tag_id -if interface_name -node 0|1 [-h]
```

#### Parameters

Parameter	Description
<i>vlan_name</i>	Name assigned to the VLAN.
-vlanid <i>tag_id</i>	Tag number, used for packet routing, from 2 to 4096 inclusive. It uniquely identifies the VLAN on a node. You assign the ID and you can use the same tag number on both nodes.
-if <i>interface_name</i>	Name of the interface on which the VLAN network is created
-node 0   1	Node on which the VLAN is created, either Node0 or Node1.

Parameter	Description
-h	(Optional) Display help for using the command.

### Usage Notes

- You can assign VLANs to ODA\_BASE during the deployment.
- The VLAN for the ODA\_BASE is created from DOM-0.
- Only execute the VLAN created in Dom-0 from Node0.
- VLAN creation in dom0 should be executed only from Node 0.

### Examples

Here are examples of how to use the `oakcli create vlan` command.

#### Creating a New VLAN

Create a VLAN named `sample10` on Node 1 using the `bond1` interface and a tag with the number 10:

```
oakcli create vlan sample10 -vlanid 10 -if bond1 -node 1
```

#### Duplicating a VLAN on the Second Node

Create a VLAN named `sample10` on Node 0:

```
oakcli create vlan sample10 -vlanid 10 -if bond1 -node 0
```

## oakcli delete vlan

Use the `oakcli delete vlan` command to delete a virtual local area network.

### Syntax

```
oakcli delete vlan vlan_name -node node_number [-h]
```

### Parameters

Parameter	Description
<code>vlan <i>vlan_name</i></code>	Name of the virtual local area network to be deleted
<code>-node <i>node_number</i></code>	Oracle Database Appliance node from which you want to remove the virtual local area network
-h	(Optional) Display help for using the command.

### Example

Delete the `sample1` virtual local area network from Node 1:

```
oakcli delete vlan sample1 -node 1
```

## oakcli show vlan

Use the `oakcli show vlan` command to display information about virtual local area networks (VLANs) configured on Oracle Database Appliance.

### Syntax

```
oakcli show vlan [-h]
```

### Parameter

(Optional) `-h` displays help for using the command.

### Example 14-59 Displaying Details of Available Virtual Area Networks (VLANs)

Display the names, tag ID numbers, networks, and node assignments for the available virtual local area networks:

```
# oakcli show vlan
```

NAME	ID	INTERFACE	NODENUM
net1	1	bond1	0
net1	1	bond1	1
net2	1	bond2	0
net2	1	bond2	1
net3	1	bond3	0
net3	1	bond3	1
net4	1	xbond0	0
net4	1	xbond0	1
priv1	1	bond0	0
priv1	1	bond0	1

# 15

## Troubleshooting Oracle Database Appliance

Understand tools you can use to validate changes and troubleshoot Oracle Database Appliance problems.

- [Viewing Component Information on the Appliance](#)  
View details of all the components installed on the appliance, and the RPM drift information.
- [Errors When Logging into the Web Console](#)  
If you have problems logging into the Web Console, then it may be due to your browser or credentials.
- [Errors when re-imaging Oracle Database Appliance](#)  
Understand how to troubleshoot errors that occur when re-imaging Oracle Database Appliance.
- [Using the Oracle ORAchk Health Check Tool](#)  
Use Oracle ORAchk Health Check Tool to audit configuration settings and check system health.
- [About Oracle Trace File Analyzer Collector](#)  
Oracle Trace File Analyzer (TFA) Collector simplifies diagnostic data collection on Oracle Grid Infrastructure and Oracle Real Application Clusters systems.
- [Running Oracle Trace File Analyzer \(TFA\) Collector Commands](#)  
Understand the installed location of `tfactl` and the options for the command.
- [Running the Disk Diagnostic Tool](#)  
Use the Disk Diagnostic Tool to help identify the cause of disk problems.
- [Running the Oracle Database Appliance Hardware Monitoring Tool](#)  
The Oracle Database Appliance Hardware Monitoring Tool displays the status of different hardware components in Oracle Database Appliance server.
- [Configuring a Trusted SSL Certificate for Oracle Database Appliance](#)  
The Web Console and DCS Controller use SSL-based HTTPS protocol for secure communication. Understand the implications of this added security and the options to configure SSL certificates.
- [Disabling the Web Console](#)  
You can also disable the Web Console. Disabling the Web Console means you can only manage your appliance through the command-line interface.
- [Preparing Log Files for Oracle Support Services](#)  
If necessary, use the command `odaadmcli manage diagcollect` to collect diagnostic files to send to Oracle Support Services.



## Viewing Component Information on the Appliance

View details of all the components installed on the appliance, and the RPM drift information.

### Viewing the Bill of Materials in the Web Console

Use the Appliance tab in the Web Console to view information about your deployment and the installed components. The Advanced Information tab displays information about the following components:

- Grid Infrastructure Version, and the home directory
- Database Version, Home location, and Edition
- Location and details about the databases configured
- All patches applied to the appliance
- Firmware Controller and Disks
- ILOM information
- BIOS version
- List of RPMs

In the List of RPMs section, click **Show** and then click **RPM Drift** to view the differences between the RPMs installed on the appliance, and the RPMs shipped in the latest Oracle Database Appliance Patch Bundle Update release.

Click **Download** to save the components report. You can use this report to help diagnose any deployment issues.

### Viewing the Bill of Materials from the Command Line

The bill of materials is also available through the command line for bare metal and virtualized platforms deployments. The information about the installed components is collected according to a set schedule, and stored in the location `/opt/oracle/dcs/Inventory/` for bare metal deployments and in the `/opt/oracle/oak/Inventory/` directory for virtualized platforms. The file is stored in the format `oda_bom_TimeStamp.json`. Use the command `describe-system` to view the bill of materials on the command line. See the *Oracle Database Command-Line Interface* chapter for command options and usage notes.

#### Example 15-1 Example Command to View the Bill of Materials from the Command Line for Bare Metal Deployments

```
# odacli describe-system -b
ODA Components Information
-----
Component Name          Comonent
Details
-----
-----
NODE                      Name : rwsoda6m003
                          Domain Name :
                          Time Stamp : July 29, 2018 7:00:12 PM UTC
```

```
RPMS                                     Installed RPMS : acl-2.2.49-7.el6_9.1.x86_64,
                                                aide-0.14-11.el6.x86_64,
                                                alsa-lib-1.1.0-4.el6.x86_64,
                                                at-3.1.10-49.el6.x86_64,
                                                atk-1.30.0-1.el6.x86_64,
                                                attr-2.4.44-7.el6.x86_64,
                                                audit-2.4.5-6.el6.x86_64,
                                                audit-
libs-2.4.5-6.el6.x86_64,
python-2.4.5-6.el6.x86_64,
libs-1.0.0-10.el6.x86_64,
authconfig-6.1.12-23.el6.x86_64,
libs-0.6.25-17.el6.x86_64,
openfwfwf-5.2-10.el6.noarch,
basesystem-10.0-4.0.1.el6.noarch,
libs-9.8.2-0.62.rc1.el6_9.5.x86_64,
utils-9.8.2-0.62.rc1.el6_9.5.x86_64,
binutils-2.20.51.0.2-5.47.el6_9.1.x86_64,
biosdevname-0.7.2-1.el6.x86_64,
utils-1.2-10.el6.x86_64,
busybox-1.15.1-21.el6_6.x86_64,
libs-1.0.5-7.el6_0.x86_64,
certificates-2017.2.14-65.0.1.el6_9.noarch,
celt051-0.5.1.3-0.el6.x86_64,
checkpolicy-2.0.22-1.el6.x86_64,
chkconfig-1.3.49.5-1.el6.x86_64,
ppl-0.15.7-1.2.el6.x86_64,
libcap1-1.10-1.x86_64,
+-33-3.2.3-69.el6.x86_64,
audit-libs-
augeas-
avahi-
b43-
bash-4.1.2-48.el6.x86_64,
bc-1.06.95-1.el6.x86_64,
bind-
bind-
bridge-
bzip2-1.0.5-7.el6_0.x86_64,
bzip2-
ca-
cairo-1.8.8-6.el6_6.x86_64,
clog-
compat-
compat-libstdc+
```

```

readline5-5.2-17.1.el6.x86_64,
+-4.8.2-16.el6.x86_64,
ConsoleKit-0.4.1-6.el6.x86_64,
libs-0.4.1-6.el6.x86_64,
x11-0.4.1-6.el6.x86_64,
coreutils-8.4-46.0.1.el6.x86_64,
libs-8.4-46.0.1.el6.x86_64,

cpupowerutils-1.3-2.el6.x86_64,
cpuspeed-1.5-22.0.1.el6.x86_64,
cracklib-2.8.16-4.el6.x86_64,
dicts-2.8.16-4.el6.x86_64,
crash-7.1.4-1.0.1.el6_7.x86_64,
crda-3.13_2015.10.22-3.el6.x86_64,
createrepo-0.9.9-27.el6_9.noarch,
cronie-1.4.4-16.el6_8.2.x86_64,
anacron-1.4.4-16.el6_8.2.x86_64,

luks-1.2.0-11.el6.x86_64,
libs-1.2.0-11.el6.x86_64,
libs-1.4.2-78.el6_9.x86_64,

....
....
....

compat-
compat-sap-c+
ConsoleKit-
ConsoleKit-
coreutils-
cpio-2.10-13.el6.x86_64,
cpp-4.4.7-18.el6.x86_64,
cracklib-
cronie-
crontabs-1.10-33.el6.noarch,
cryptsetup-
cryptsetup-luks-
cups-

```

**Example 15-2 Example Command to View the Bill of Materials from the Command Line for Virtualized Platforms**

```
# oakcli describe-system -b
```

**Example 15-3 Example Command to View the Bill of Materials Report from the Stored Location**

```
# ls -la /opt/oracle/dcs/Inventory/  
total 264  
-rw-r--r-- 1 root root 83550 Apr 26 05:41 oda_bom_2018-04-26_05-41-36.json
```

## Errors When Logging into the Web Console

If you have problems logging into the Web Console, then it may be due to your browser or credentials.

 **Note:**

Oracle Database Appliance uses self-signed certificates. Your browser determines how you log into the Web Console. Depending on the browser and browser version, you may receive a warning or error that the certificate is invalid or not trusted because it is self-signed, or that the connection is not private. Ensure that you accept the self-signed certificate for the agent and Web Console.

Follow these steps to log into the Web Console:

1. Open a browser window.
2. Go to the following URL: `https://ODA-host-ip-address:7093/mgmt/index.html`
3. Get the security certificate (or certificate), confirm the security exception, and add an exception.
4. Log in with your Oracle Database Appliance credentials.  
If you have not already set the `oda-admin` password, then a message is displayed, advising you to change the default password to comply with your system security requirements.
5. If you have not added an exception for the agent security certificate, then a message about accepting agent certificate is displayed.
6. Using a different tab in your browser, go to the following URL: `https://ODA-host-ip-address:7070/login`
7. Get the security certificate (or certificate), confirm the security exception, and add an exception.
8. Refresh the Web Console URL : `https://ODA-host-ip-address:7093/mgmt/index.html`

**Related Topics**

- <http://www.oracle.com/technetwork/indexes/products/browser-policy-2859268.html>

## Errors when re-imaging Oracle Database Appliance

Understand how to troubleshoot errors that occur when re-imaging Oracle Database Appliance.

If re-imaging Oracle Database Appliance fails, with old header issues such as errors in storage discovery, or in running GI root scripts, or disk group RECO creation, then use the force mode with `cleanup.pl`.

```
# perl cleanup.pl -f
```

To ensure that re-imaging is successful, remove the old headers from the storage disks by running the secure erase tool. Verify that the OAK/ASM headers are removed.

```
# cleanup.pl -erasedata  
# cleanup.pl -checkHeader
```

Retry the re-imaging operation.

### Related Topics

- [Re-imaging Oracle Database Appliance](#)  
Bare metal operating system re-imaging installs Oracle Database Appliance operating system software on the local (boot) drive.

## Using the Oracle ORAchK Health Check Tool

Use Oracle ORAchK Health Check Tool to audit configuration settings and check system health.

Oracle ORAchK Health Check Tool performs proactive health checks for the Oracle software stack and scans for known problems.

Oracle ORAchK Health Check Tool audits important configuration settings for Oracle RAC two-node deployments in the following categories:

- Operating system kernel parameters and packages
- Oracle Database
- Database parameters, and other database configuration settings
- Oracle Grid Infrastructure, which includes Oracle Clusterware and Oracle Automatic Storage Management

ORAchK is aware of the entire system. It checks the configuration to indicate if best practices are being followed.

### See Also:

For more information about ORAchK, see My Oracle Support note 1268927.2, "ORAchK Health Checks for the Oracle Stack" at <https://support.oracle.com/rs?type=doc&id=1268927.2>

 **Note:**

Before running ORAck, check for the latest version of ORAck, and download and install it.

### Running ORAck on Oracle Database Appliance 18.7 Baremetal Systems for New Installation

When you provision or upgrade to Oracle Database Appliance 18.7, the ORAck RPMs are installed in the directory `/opt/oracle.SupportTools/orack/`. You can verify that ORAck is installed by running the following command:

```
[root@oak bin]# rpm -q orack
orack-18.3.0_20180808-2.x86_64
```

If an older version of ORAck exists, then copy the latest version of `orack` that you downloaded from My Oracle Support into the `/opt/oracle.SupportTools/orack/` directory, and run the following command:

```
orack -upgrade
```

The command upgrades your `orack` utility to the latest version.

To run `orack`, use the following command:

```
[root@oak bin]# orack
This computer is for [S]ingle instance database or part of a [C]luster to
run
RAC database [S|C] [C]: S
orack did not find the inventory location on oak from environment. Does
oak
have Oracle software installed [y/n][n]? n
...
Detailed report (html) -
/opt/oracle.SupportTools/orack/orack_oak_091918_182425/
orack_oak_091918_182
425.html

UPLOAD [if required] -
/opt/oracle.SupportTools/orack/orack_oak_091918_182425.zip
```

### Running ORAck on Oracle Database Appliance 18.7 Virtualized Platform

When you provision or upgrade to Oracle Database Appliance 18.7, the ORAck RPMs are installed in the directory `/opt/oracle.SupportTools/orack/`.

To run `orack`, use the following command:

```
[root@oak bin]# oakcli orack
```

### Running ORAchk on Oracle Database Appliance Baremetal Systems for Releases Earlier than 18.7

1. Open the command-line interface as `root`.
2. Navigate to the ORAchk tool in the `/suptools` directory.

```
/u01/app/12.2.0.1/grid/suptools/orachk
```

3. Run the utility.

```
./orachk
```

When all checks are finished, a detailed report is available. The output displays the location of the report in an HTML format and the location of a zip file if you want to upload the report.

4. Review the Oracle Database Appliance Assessment Report and system health and troubleshoot any issues that are identified.

The report includes a summary and filters that enable you to focus on specific areas. For example, you can choose the filter to show failed checks only, show checks with a Fail, Warning, Info, or Pass status, or any combination.

## About Oracle Trace File Analyzer Collector

Oracle Trace File Analyzer (TFA) Collector simplifies diagnostic data collection on Oracle Grid Infrastructure and Oracle Real Application Clusters systems.

TFA behaves in a similar manner to the `ion` utility packaged with Oracle Clusterware. Both tools collect and package diagnostic data. However, TFA is much more powerful than `ion`, because TFA centralizes and automates the collection of diagnostic information.

TFA provides the following key benefits and options:

- Encapsulation of diagnostic data collection for all Oracle Grid Infrastructure and Oracle RAC components on all cluster nodes into a single command, which you run from a single node
- Option to "trim" diagnostic files during data collection to reduce data upload size
- Options to isolate diagnostic data collection to a given time period, and to a particular product component, such as Oracle ASM, RDBMS, or Oracle Clusterware
- Centralization of collected diagnostic output to a single node in Oracle Database Appliance, if desired
- On-Demand Scans of all log and trace files for conditions indicating a problem
- Real-Time Scan Alert Logs for conditions indicating a problem (for example, Database Alert Logs, Oracle ASM Alert Logs, and Oracle Clusterware Alert Logs)

 **See Also:**

Refer to My Oracle Support note 1513912.1 "TFA Collector - Tool for Enhanced Diagnostic Gathering" for more information. <https://support.oracle.com/rs?type=doc&id=1513912.1>

## Running Oracle Trace File Analyzer (TFA) Collector Commands

Understand the installed location of `tfactl` and the options for the command.

### About Using `tfactl` to Collect Diagnostic Information

When you provision or upgrade to Oracle Database Appliance 18.7, Oracle Trace File Analyzer (TFA) Collector is installed in the directory `/opt/oracle/tfa/tfa_home`. You can invoke the command line utility for TFA, `tfactl` from the directory `/opt/oracle/tfa/tfa_home/bin/tfactl`, or simply type `tfactl`.

You can use the following command options to run `tfactl`:

```
/opt/oracle/tfa/tfa_home/bin/tfactl diagcollect -ips|-oda|-odalite|-dcs|-odabackup|-odapatching|-odadataguard|-odaprovisioning|-odaconfig|-odasystem|-odastorage|-database|-asm|-crsclient|-dbclient|-dbwlm|-tns|-rhp|-procinfo|-afd|-crs|-cha|-wls|-emagent|-oms|-ocm|-emplugins|-em|-acfs|-install|-cfgtools|-os|-ashhtml|-ashtext|-awrhtml|-awrtext -mask -sanitize
```

**Table 15-1 Command Options for `tfactl` Tool**

Option	Description
-h	(Optional) Describes all the options for this command.
-ips	(Optional) Use this option to view the diagnostic logs for the specified component.
-oda	(Optional) Use this option to view the logs for the entire Appliance.
-odalite	(Optional) Use this option to view the diagnostic logs for the odalite component.
-dcs	(Optional) Use this option to view the DCS log files.
-odabackup	(Optional) Use this option to view the diagnostic logs for the backup components for the Appliance.
-odapatching	(Optional) Use this option to view the diagnostic logs for patching components of the Appliance.



**Table 15-1 (Cont.) Command Options for tfactl Tool**

Option	Description
-odadataguard	(Optional) Use this option to view the diagnostic logs for Oracle Data Guard component of the Appliance.
-odaprovisioning	(Optional) Use this option to view provisioning logs for the Appliance.
-odaconfig	(Optional) Use this option to view configuration-related diagnostic logs.
-odasystem	(Optional) Use this option to view system information.
-odastorage	(Optional) Use this option to view the diagnostic logs for the Appliance storage.
-database	(Optional) Use this option to view database-related log files.
-asm	(Optional) Use this option to view the diagnostic logs for the Appliance.
-crsclient	(Optional) Use this option to view the diagnostic logs for the Appliance.
-dbclient	(Optional) Use this option to view the diagnostic logs for the Appliance.
-dbwlm	(Optional) Use this option to view the diagnostic logs for the specified component.
-tns	(Optional) Use this option to view the diagnostic logs for TNS.
-rhp	(Optional) Use this option to view the diagnostic logs for Rapid Home Provisioning.
-afd	(Optional) Use this option to view the diagnostic logs for Oracle ASM Filter Driver.
-crs	(Optional) Use this option to view the diagnostic logs for Oracle Clusterware.
-cha	(Optional) Use this option to view the diagnostic logs for the Cluster Health Monitor.
-wls	(Optional) Use this option to view the diagnostic logs for Oracle WebLogic Server.
-emagent	(Optional) Use this option to view the diagnostic logs for the Oracle Enterprise Manager agent.
-oms	(Optional) Use this option to view the diagnostic logs for the Oracle Enterprise Manager Management Service.
-ocm	(Optional) Use this option to view the diagnostic logs for the specified component.
-emplugins	(Optional) Use this option to view the diagnostic logs for Oracle Enterprise Manager plug-ins.

**Table 15-1 (Cont.) Command Options for tfactl Tool**

Option	Description
-em	(Optional) Use this option to view the diagnostic logs for Oracle Enterprise Manager deployment.
-acfs	(Optional) Use this option to view the diagnostic logs for Oracle ACFS storage.
-install	(Optional) Use this option to view the diagnostic logs for installation.
-cfgtools	(Optional) Use this option to view the diagnostic logs for the configuration tools.
-os	(Optional) Use this option to view the diagnostic logs for the operating system.
-ashhtml	(Optional) Use this option to view the diagnostic logs for the specified component.
-ashtext	(Optional) Use this option to view the diagnostic logs for the Appliance.
-awrhtml	(Optional) Use this option to view the diagnostic logs for the Appliance.
-awrtxt	(Optional) Use this option to view the diagnostic logs for the specified component.
-mask	(Optional) Use this option to choose to mask sensitive data in the log collection.
-sanitize	(Optional) Use this option to choose to sanitize (redact) sensitive data in the log collection.

### Usage Notes

You can use Trace File Collector (the `tfactl` command) to collect all log files for the Oracle Database Appliance components.

The following types of sensitive information can be redacted using the `-mask` or the `-sanitize` option:

- Host names
- IP addresses
- Database names
- Tablespace names
- Service names
- Ports
- Operating System user names

For example, when the `-mask` option is used, all instances of a sensitive name such as a database name called "payrolldb" are replaced with "\*\*\*\*\*" in the TFA collection.

For example, when the `-sanitize` option is used, all instances of a sensitive name such as a database name called "payrolldb" are replaced with another string, such as "oCjIN7F8P", in the TFA collection.

## Running the Disk Diagnostic Tool

Use the Disk Diagnostic Tool to help identify the cause of disk problems.

The tool produces a list of 14 disk checks for each node. To display details, where *n* represents the disk resource name, enter the following command:

```
# odaadmcli storddiag n
```

For example, to display detailed information for NVMe `pd_00`:

```
# odaadmcli storddiag pd_00
```

## Running the Oracle Database Appliance Hardware Monitoring Tool

The Oracle Database Appliance Hardware Monitoring Tool displays the status of different hardware components in Oracle Database Appliance server.

The tool is implemented with the Trace File Analyzer collector. Use the tool both on bare-metal and on virtualized systems. The Oracle Database Appliance Hardware Monitoring Tool reports information only for the node on which you run the command. The information it displays in the output depend on the component that you select to review.

### Bare Metal Platform

You can see the list of monitored components by running the command `odaadmcli show -h`

To see information about specific components, use the command syntax `odaadmcli show component`, where *component* is the hardware component that you want to query. For example, the command `odaadmcli show power` shows information specifically about the Oracle Database Appliance power supply:

```
# odaadmcli show power
```

NAME	HEALTH	HEALTH_DETAILS	PART_NO.	SERIAL_NO.
Power_Supply_0	OK	-	7079395	476856Z+1514CE056G

(Continued)

LOCATION	INPUT_POWER	OUTPUT_POWER	INLET_TEMP	EXHAUST_TEMP
PS0	Present	112 watts	28.000 degree C	34.938 degree C

### Virtualized Platform

You can see the list of monitored components by running the command `oakcli show -h`

To see information about specific components, use the command syntax `oakcli show component`, where *component* is the hardware component that you want to query. For

example, the command `oakcli show power` shows information specifically about the Oracle Database Appliance power supply:

```
# oakcli show power
```

```
NAME           HEALTH HEALTH DETAILS PART_NO. SERIAL_NO.
Power Supply_0 OK      -             7047410 476856F+1242CE0020
Power Supply_1 OK      -             7047410 476856F+1242CE004J
```

(Continued)

```
LOCATION  INPUT      POWER OUTPUT POWER INLET TEMP  EXHAUST TEMP
PS0     Present   88 watts   31.250 degree C  34.188 degree C
PS1     Present   66 watts   31.250 degree C  34.188 degree C
```

### Note:

Oracle Database Appliance Server Hardware Monitoring Tool is enabled during initial startup of ODA\_BASE on Oracle Database Appliance Virtualized Platform. When it starts, the tool collects base statistics for about 5 minutes. During this time, the tool displays the message "Gathering Statistics..." message.

## Configuring a Trusted SSL Certificate for Oracle Database Appliance

The Web Console and DCS Controller use SSL-based HTTPS protocol for secure communication. Understand the implications of this added security and the options to configure SSL certificates.

The Web Console provides an added layer of security using certificates and encryption, when an administrator interacts with the appliance. Encryption of data ensures that:

- Data is sent to the intended recipient, and not to any malicious third-party.
- When data is exchanged between the server and the browser, data interception cannot occur nor can the data be edited.

When you connect to the Web Console through HTTPS, the DCS Controller presents your browser with a certificate to verify the identity of appliance. If the web browser finds that the certificate is not from a trusted Certificate Authority (CA), then the browser assumes it has encountered an untrusted source, and generates a security alert message. The security alert dialog boxes display because Web Console security is enabled through HTTPS and SSL, but you have not secured your Web tier properly with a trusted matching certificate from a Certificate Authority. It is possible to purchase commercial certificates from a Certificate Authority or create your own and register them with a Certificate Authority. However, the server and browser certificates must use the same public certificate key and trusted certificate to avoid the error message produced by the browser.

There are three options to configure your certificates:

- Create your own key and Java keystore, ensure it is signed by a Certificate Authority (CA) and then import it for use.
- Package an existing Privacy Enhanced Mail (PEM) format key and certificates in a new Java keystore.
- Convert an existing PKCS or PFX keystore to a Java keystore and configure it for the Web Console.

 **Note:**

For Oracle Database Appliance High-Availability hardware models, run the configuration steps on **both** nodes.

The following topics explain how to configure these options:

- [Option 1: Creating a Key and Java Keystore and Importing a Trusted Certificate](#)  
Use `keytool`, a key and certificate management utility, to create a keystore and a signing request.
- [Option 2: Packaging an Existing PEM-format Key and Certificates in a New Java Keystore](#)  
Use the OpenSSL tool to package Privacy Enhanced Mail (PEM) files in a PKCS keystore.
- [Option 3: Converting an Existing PKCS or PFX Keystore to a Java Keystore](#)  
If you have an existing PKCS or PFX keystore for your server's domain, convert it to a Java keystore.
- [Configuring the DCS Server to Use Custom Keystore](#)  
After packaging or converting your keystore into Java keystore, configure the DCS server to use your keystore.
- [Configuring the DCS Agent for Custom Certificate](#)  
After you import the certificate into the keystore, configure the DCS agent to use the same certificate.

## Option 1: Creating a Key and Java Keystore and Importing a Trusted Certificate

Use `keytool`, a key and certificate management utility, to create a keystore and a signing request.

1. Create the keystore:

```
keytool -genkeypair -alias your.domain.com -storetype jks -keystore
your.domain.com.jks -validity 366 -keyalg RSA -keysize 4096
```

2. The command prompts you for identifying data:

1. What is your first and last name? *your.domain.com*
2. What is the name of your organizational unit? *yourunit*
3. What is the name of your organization? *yourorg*
4. What is the name of your City or Locality? *yourcity*

5. What is the name of your State or Province? *yourstate*
6. What is the two-letter country code for this unit? *US*

**3. Create the certificate signing request (CSR):**

```
keytool -certreq -alias your.domain.com -file your.domain.com.csr
-keystore your.domain.com.jks -ext san=dns:your.domain.com
```

**4. Request a Certificate Authority (CA) signed certificate:**

- a. In the directory where you ran Step 1 above, locate the file *your.domain.com.csr*.

- b. Submit the file to your Certificate Authority (CA).

Details vary from one CA to another. Typically, you submit your request through a website; then the CA contacts you to verify your identity. CAs can send signed reply files in a variety of formats, and CAs use a variety of names for those formats. The CA's reply must be in PEM or PKCS#7 format.

- c. There may be a waiting period for the CA's reply.

**5. Import the CA's reply. The CA's reply will provide one PKCS file or multiple PEM files.**

- a. Copy the CA's files into the directory where you created the keystore in Step 1 above.

- b. Use keytool to export the certificate from the keystore:

```
keytool -exportcert -alias your.domain.com -file /opt/oracle/dcs/
conf/keystore-cert.crt
-keystore your.domain.name.jks
```

**6. Use keytool to import the keystore certificate and the CA reply files:**

```
keytool -importcert -trustcacerts -alias your.domain.com
-file /opt/oracle/dcs/conf/keystore-cert.crt -keystore /opt/oracle/dcs/
conf/dcs-ca-certs
```

To import PKCS file, run the command:

```
keytool -importcert -trustcacerts -alias your.domain.com -file
CAreply.pkcs -keystore /opt/oracle/dcs/conf/dcs-ca-certs
```

*CAreply.pkcs* is the name of the PKCS file provided by the CA and *your.domain.com* is the complete domain name of your server.

If the CA sent PEM files, then there may be one file, but most often there are two or three. Import the files to your keystore with commands in the order shown below, after substituting your values:

```
keytool -importcert -alias root -file root.cert.pem -keystore /opt/
oracle/dcs/conf/dcs-ca-certs -trustcacerts
keytool -importcert -alias intermediate -file
intermediate.cert.pem /opt/oracle/dcs/conf/dcs-ca-certs -trustcacerts
keytool -importcert -alias intermediat2 -file
intermediat2.cert.pem /opt/oracle/dcs/conf/dcs-ca-certs -trustcacerts
```

```
keytool -importcert -alias your.domain.com -file server.cert.pem /opt/
oracle/dcs/conf/dcs-ca-certs -trustcacerts
```

*root.cert.pem* is the name of the root certificate file and *intermediate.cert.pem* is the name of the intermediate certificate file. The root and intermediate files link the CA's signature to a widely trusted root certificate that is known to web browsers. Most, but not all, CA replies include roots and intermediates.

*server.cert.pem* is the name of the server certificate file. The file links your domain name with your public key and the CA's signature.

## Option 2: Packaging an Existing PEM-format Key and Certificates in a New Java Keystore

Use the OpenSSL tool to package Privacy Enhanced Mail (PEM) files in a PKCS keystore.

If you have an existing private key and certificates for your server's domain in PEM format, importing them into a Java keystore requires the OpenSSL tool. OpenSSL can package the PEM files in a PKCS keystore. Java keytool can then convert the PKCS keystore to a Java keystore.

1. Install OpenSSL.
2. Copy your private key, server certificate, and intermediate certificate into one directory.
3. Package the key and certificates into a PKCS keystore as follows:

```
openssl pkcs12 -export -in server.cert.pem -inkey private.key.pem -
certfile
intermediate.cert.pem -name "your.domain.com" -out your.domain.com.p12
```

*server.cert.pem* is the name of the server certificate file, *your.domain.com* is the complete domain name of your server, *private.key.pem* is the private counterpart to the public key in *server.cert.pem*, and *intermediate.cert.pem* is the name of the intermediate certificate file.

Convert the resulting PKCS keystore file, *your.domain.com.p12* into a Java keystore.

## Option 3: Converting an Existing PKCS or PFX Keystore to a Java Keystore

If you have an existing PKCS or PFX keystore for your server's domain, convert it to a Java keystore.

1. Run the command:

```
keytool -importkeystore -srckeystore your.domain.com.p12 -srcstoretype
PKCS12
-destkeystore /opt/oracle/dcs/conf/dcs-ca-certs -deststoretype jks
```

*your.domain.com.p12* is the existing keystore file and *your.domain.com* is the complete domain name of your server.

2. Configure the DCS server as explained in the topic *Configuring the DCS Server to Use Custom Keystore*.

## Configuring the DCS Server to Use Custom Keystore

After packaging or converting your keystore into Java keystore, configure the DCS server to use your keystore.

1. Login to the appliance.

```
ssh -l root oda-host-name
```

2. Generate the obfuscated keystore password:

```
java -cp /opt/oracle/dcs/bin/dcs-controller-n.n.n.-SNAPSHOT.jar
org.eclipse.jetty.util.security.Password keystore-password
```

For example:

```
[root@oda]# java -cp /opt/oracle/dcs/bin/dcs-controller-SNAPSHOT.jar
org.eclipse.jetty.util.security.Password test
12:46:33.858 [main] DEBUG org.eclipse.jetty.util.log
- Logging to Logger[org.eclipse.jetty.util.log] via
org.eclipse.jetty.util.log.Slf4jLog
12:46:33.867 [main] INFO org.eclipse.jetty.util.log
- Logging initialized @239ms to org.eclipse.jetty.util.log.Slf4jLog
test
OBF:1z0f1vu91vv11z0f
MD5:098f6bcd4621d373cade4e832627b4f6
[root@scaoda7s001 conf]#
```

Copy the password that starts with OBF:.

3. Update the DCS controller configuration file.

```
cd /opt/oracle/dcs/conf
```

Update the following parameters in `dcs-controller.json`:

```
"keyStorePath": "keystore-directory-path/your.domain.com.jks"
"trustStorePath": /opt/oracle/dcs/conf/dcs-ca-certs
"keyStorePassword": "obfuscated keystorepassword"
"certAlias": "your.domain.com"
```

4. Restart the DCS Controller.

```
initctl stop initdcscontroller
initctl start initdcscontroller
```

5. Access the Web Console at <https://oda-host-name:7093/mgmt/index.html>.



## Configuring the DCS Agent for Custom Certificate

After you import the certificate into the keystore, configure the DCS agent to use the same certificate.

1. Update the DCS agent configuration file:

```
cd /opt/oracle/dcs/conf
```

Update the following parameters in the `dcs-agent.json` file:

```
"keyStorePath": "keystore-directory-path/your.domain.com.jks"  
"trustStorePath": /opt/oracle/dcs/conf/dcs-ca-certs  
"keyStorePassword": "obfuscated keystorepassword"  
"certAlias": "your.domain.com"
```

2. Restart the DCS agent:

```
initctl stop initdcsagent  
initctl start initdcsagent
```

3. Access the agent at `https://oda-host-name:7070`.
4. Update the CLI certificates.

```
cp -f /opt/oracle/dcs/conf/dcs-ca-certs  
/opt/oracle/dcs/dcscli/dcs-ca-certs
```

5. Update the DCS command-line configuration files:

```
[root@]# cd /opt/oracle/dcs/dcscli
```

Update the following parameters in `dcscli-adm.conf` and `dcscli.conf`:

```
TrustStorePath=/opt/oracle/dcs/conf/dcs-ca-certs  
TrustStorePassword=keystore_password
```

## Disabling the Web Console

You can also disable the Web Console. Disabling the Web Console means you can only manage your appliance through the command-line interface.

1. Log in to the appliance:

```
ssh -l root oda-host-name
```

2. Stop the DCS controller. For HA systems, run the command on both nodes.

```
initctl stop initdcscontroller
```

## Preparing Log Files for Oracle Support Services

If necessary, use the command `odaadmcli manage diagcollect` to collect diagnostic files to send to Oracle Support Services.

Use the Bill Of Materials report saved in the `/opt/oracle/dcs/Inventory/` directory, to enable Oracle Support to help troubleshoot errors, if necessary.

If you have a system fault that requires help from Oracle Support Services, then you may need to provide log records to help Oracle support diagnose your issue.

You can use Trace File Collector (the `tfactl` command) to collect all log files for the Oracle Database Appliance components.

You can also collect log file information by running the command `odaadmcli manage diagcollect`. This command consolidates information from log files stored on Oracle Database Appliance into a single log file for use by Oracle Support Services. The location of the file is specified in the command output.

### **Example 15-4 Collecting log file information for a time period, masking sensitive data**

```
# odaadmcli manage diagcollect --dataMask --fromTime 2019-08-12 --toTime
2019-08-25
DataMask is set as true
FromTime is set as: 2019-08-12
ToTime is set as: 2019-08-25
TFACTL command is: /opt/oracle/tfa/tfa_home/bin/tfactl
Data mask is set.
Collect data from 2019-08-12
Collect data to 2019-08-25
```

# A

## ODACLI Command Reference for OAKCLI Migration

Use these topics as a reference to understand the equivalent OAKCLI and ODACLI commands for managing your appliance after migration from OAKCLI to ODACLI stack.

Use this conversion chart to learn how to perform a task with the corresponding odacli and oakcli commands. The topics show the task and the associated command.

- [Appliance Commands](#)  
ODACLI and OAKCLI commands for common tasks performed on the appliance.
- [Patching Commands](#)  
ODACLI and OAKCLI commands for patching the appliance.
- [Database Commands](#)  
ODACLI and OAKCLI commands for common tasks performed on the database.
- [Database Home Commands](#)  
ODACLI and OAKCLI commands for common tasks performed on the database home.
- [Database Storage Commands](#)  
ODACLI and OAKCLI commands for common tasks performed for the database storage.
- [Network Commands](#)  
ODACLI and OAKCLI commands for configuring and managing networks.
- [Storage Commands](#)  
ODACLI and OAKCLI commands for configuring and managing storage.
- [Job Commands](#)  
ODACLI and OAKCLI commands for managing jobs.
- [Hardware Monitoring Commands](#)  
ODACLI and OAKCLI commands for hardware monitoring tasks.
- [CPU Core Commands](#)  
ODACLI and OAKCLI commands for common CPU core tasks.
- [Oracle Auto Service Request \(ASR\) Commands](#)  
ODACLI and OAKCLI commands for ASR tasks.

### Appliance Commands

ODACLI and OAKCLI commands for common tasks performed on the appliance.

Task	Command to Run on the DCS Stack	Command to Run on the OAK Stack
Validate the state of an Oracle Database Appliance or the viability of an operating system patch.	Not Applicable.	<code>oakcli validate</code>
Configure the first network.	<code>odacli configure-firstnet</code>	<code>oakcli configure firstnet</code>
Create (deploy or provision) Oracle Database Appliance.	<code>odacli create-appliance</code> Requires a JSON file.	Not Applicable. The OAK stack uses the Configurator and a configuration file.
Display appliance details.	<code>odacli describe-system</code>	Not Applicable.
Prepare a copy of the configuration file for use during the configuration of Oracle Database Appliance.	Not Applicable. The DCS stack does not use a configuration file.	<code>oakcli copy</code>
Deploy Oracle Grid Infrastructure for a cluster on Oracle Database Appliance.	Not Applicable.	<code>oakcli deploy</code>
Stop and restart ODA_BASE on the local node.	Not Applicable.	<code>oakcli restart oda_base</code>
Start ODA_BASE on the local node.	Not Applicable.	<code>oakcli start oda_base</code>
Change password.	<code>odacli-adm-set-credential</code>	Not Applicable.
Audit configuration settings with the ORAchk utility.	No comparable command. Use the ORAchk utility.	<code>oakcli orachk</code> command to audit configuration settings with the ORAchk utility.
Determine the master node.	Not Applicable.	<code>oakcli show ismaster</code>
Update the HugePage and memlock values for the operating system	<code>odacli update-osconfigurations</code>	<code>oakcli reconfigure osparams</code>

## Patching Commands

ODACLI and OAKCLI commands for patching the appliance.

Task	Command to Run on the DCS Stack	Command to Run on the OAK Stack
Display the installed version and the latest available version for each component.	<code>odacli describe-component</code>	<code>oakcli show version -detail</code>
Display a list of the latest supported patch versions for each component.	<code>odacli describe-latestpatch</code>	Not Applicable.
Update a specific RDBMS Home to the latest patch bundle version.	<code>odacli update-dbhome</code>	<code>oakcli update -patch version -database</code>
Update the agent.	<code>odacli update-dcsagent</code>	Not Applicable.

Task	Command to Run on the DCS Stack	Command to Run on the OAK Stack
Update the operating system, firmware, Oracle Appliance Kit, Oracle Clusterware, and all other infrastructure components.	<code>odacli update-server</code>	<code>oakcli update -patch version --server</code>
Update the storage.	<code>odacli update-storage</code>	<code>oakcli update -patch version --storage</code>
Unpack packages into the Oracle Appliance Manager repository.	<code>odacli update-repository</code>	<code>oakcli unpack</code>
Apply Oracle Database Appliance patches.	<code>odacli update-database</code>	<code>oakcli update -patch version --database</code>

## Database Commands

ODACLI and OAKCLI commands for common tasks performed on the database.

Task	Command to Run on the DCS Stack	Command to Run on the OAK Stack
List all databases on the appliance.	<code>odacli list-databases</code>	<code>oakcli show databases</code>
Display database details.	<code>odacli describe-database</code>	<code>oakcli show databases -db</code>
Create a new database.	<code>odacli create-database</code>	<code>oakcli create database</code>
Register a migrated database with the appliance.	<code>odacli register-database</code>	Not Applicable.
Update the Transparent Data Encryption (TDE) parameters for Oracle Database Appliance.	<code>odacli update-tdekey</code>	Not Applicable.
Modify the database type or size class for a named database.	Not Applicable.	<code>oakcli modify database</code>
Upgrade a database version.	<code>odacli upgrade-database</code>	<code>oakcli upgrade</code>
Delete a database.	<code>odacli delete-database</code>	<code>oakcli delete database</code>
Delete a database configuration file.	Not Applicable.	<code>oakcli delete db_config_params</code>
Display configuration file names and parameters.	Not Applicable.	<code>oakcli show db_config_params</code>

## Database Home Commands

ODACLI and OAKCLI commands for common tasks performed on the database home.

Task	Command to Run on the DCS Stack	Command to Run on the OAK Stack
Display a list of Oracle Home directories.	<code>odacli list-dbhomes</code>	<code>oakcli show dbhomes</code>
Display Oracle Database Home details.	<code>odacli describe-dbhome</code>	<code>oakcli show dbhomes --detail</code>
Create an Oracle Database Home.	<code>odacli create-dbhome</code>	<code>oakcli create dbhome</code>
Delete database home that is not associated with a database.	<code>odacli delete-dbhome</code>	<code>oakcli delete dbhome</code>
Generate a database configuration file.	Not Applicable.	<code>oakcli create db_config_params</code>
Create a snapshot database from an existing database.	<code>odacli clone-database</code>	<code>oakcli create snapshot</code>

## Database Storage Commands

ODACLI and OAKCLI commands for common tasks performed for the database storage.

Task	Command to Run on the DCS Stack	Command to Run on the OAK Stack
List of all of the database storage configured in the appliance.	<code>odacli list-dbstorages</code>	Not Applicable.
Display storage configuration details.	<code>odacli describe-dbstorage</code>	<code>oakcli show dbstorage</code>
Create the file system for database migrations.	<code>odacli create-dbstorage</code>	<code>oakcli create dbstorage</code>
Delete database storage that is not associated with a database.	<code>odacli delete-dbstorage</code>	<code>oakcli delete dbstorage</code>
Resize the space used for a storage structure that was created for the purpose of migrating databases from Oracle ASM to Oracle ACFS.	Not Applicable.	<code>oakcli resize dbstorage</code>

## Network Commands

ODACLI and OAKCLI commands for configuring and managing networks.

Task	Command to Run on the DCS Stack	Command to Run on the OAK Stack
Display networks.	<code>odacli list-networks</code>	Not Applicable
Display the details of a specific network.	<code>odacli describe-network</code>	<code>oakcli show network</code>
Create a network.	<code>odacli create-network</code>	Not Applicable

Task	Command to Run on the DCS Stack	Command to Run on the OAK Stack
Update an existing network configuration.	<code>odacli update-network</code>	Not Applicable
Delete a network.	<code>odacli delete-network</code>	Not Applicable
Configure the network after either replacing a network card or swapping the public network from copper to fiber and vice versa.	<code>odacli configure-network</code>	<code>oakcli configure network</code>
Configure any unconfigured public networks in bare metal, Domain 0, and ODA_BASE.	Not Applicable	<code>oakcli configure additionalnet</code>
Use after replacing InfiniBand 10GbE SFP+ cards (fiber) cards and before deployment to unconfigure IB setup and configure fiber cards.	Not Applicable	<code>oakcli configure ib2fiber</code>
Create a VLAN	<code>odaadmcli create vlan</code>	Not Applicable
Delete a VLAN	<code>odaadmcli delete vlan</code>	Not Applicable
Display details about the VLAN	<code>odaadmcli show vlan</code>	Not Applicable

## Storage Commands

ODACLI and OAKCLI commands for configuring and managing storage.

Task	Command to Run on the DCS Stack	Command to Run on the OAK Stack
Check the cable connections between the system controllers and the storage shelf, as well as the cable connection to the storage expansion shelf (if one is installed).	<code>odacli validate-storagetopology</code>	Not Applicable
Expand storage.	<code>odaadmcli expand storage</code>	<code>oakcli expand storage</code>
Display the status of a single disk or of all disks on the system.	<code>odaadmcli show disk</code>	<code>oakcli show disk</code>
List configured diskgroups or display a specific Oracle Automatic Storage Management (Oracle ASM) diskgroup configuration.	<code>odaadmcli show diskgroup</code>	<code>oakcli show diskgroup</code>
Display details of the controller.	<code>odaadmcli show controller</code>	<code>oakcli show controller</code>
Display the RAID SYNC status.	<code>odaadmcli show raidsyncstatus</code>	<code>oakcli show raidsyncstatus</code>

Task	Command to Run on the DCS Stack	Command to Run on the OAK Stack
Show the storage controllers, expanders, and disks.	<code>odaadmcli show storage</code>	<code>oakcli show storage</code>
Run diagnostic tests on a disk in the storage shelf or storage expansion shelf and collect detailed information for each disk or NVMe.	<code>odaadmcli stordiag</code>	<code>oakcli stordiag</code>
Collect diagnostic logs for storage components.	<code>odaadmcli manage diagcollect</code>	<code>oakcli manage diagcollect</code>
Power a disk on or off.	<code>odaadmcli power disk</code>	
Add a local disk to the system after physically replacing a failed disk.		<code>oakcli add disk -local</code>
Locate disks with write cache enabled and to disable disk write cache for those disks.	Not Applicable	<code>oakcli diskwritecache</code>
Display information about the storage enclosure subsystem on the node where the command is executed.	<code>odaadmcli show enclosure</code>	<code>oakcli show enclosure</code>
Configure solid-state drives (SSDs) for data storage into the existing base configuration to fully populate the base storage shelf.	Not Applicable	<code>oakcli expand storage</code>
Display internal RAID and local disk information. Not applicable for High-Availability models.	<code>odaadmcli show iraid</code>	<code>oakcli show iraid</code>
Locate the physical disk that is associated with a named Oracle ASM disk by turning the disk's LED light on or off.	Not Applicable	<code>oakcli locate disk</code>
Display information about a SAS expander.	<code>odaadmcli show expander</code>	<code>oakcli show expander</code>
Show whether validation storage is enabled or disabled.	<code>odaadmcli show validation storage</code>	<code>oakcli show validation storage</code>
Show hard storage errors, such as the wrong type of disk inserted into a particular slot, an invalid disk model, or an incorrect disk size.	<code>odaadmcli show validation storage errors</code>	<code>oakcli show validation storage errors</code>
Show soft validation errors, such as an invalid version of the disk firmware.	<code>odaadmcli show validation storage failures</code>	<code>oakcli show validation storage failures</code>

## Job Commands

ODACLI and OAKCLI commands for managing jobs.



Task	Command to Run on the DCS Stack	Command to Run on the OAK Stack
Display a list of jobs, including the job IDs, status, and the job created date and time stamp.	<code>odacli list-jobs</code>	Not Applicable
Display details about a specific job, including the job ID, status, tasks, and the job created date and time stamp.	<code>odacli describe-job</code>	Not Applicable

## Hardware Monitoring Commands

ODACL and OAKCLI commands for hardware monitoring tasks.

Task	Command to Run on the DCS Stack	Command to Run on the OAK Stack
Show cooling details.	<code>odaadmcli show cooling</code>	<code>oakcli show cooling</code>
Display information about the environment and hardware.	<code>odaadmcli show env_hw</code>	<code>oakcli show env_hw</code>
Display file system details.	<code>odaadmcli show fs</code>	<code>oakcli show fs</code>
Display memory details.	<code>odaadmcli show memory</code>	<code>oakcli show memory</code>
Show network details.	<code>odaadmcli show network</code>	<code>oakcli show network</code>
Display power supply details.	<code>odaadmcli show power</code>	<code>oakcli show power</code>
Display processor details.	<code>odaadmcli show processor</code>	<code>oakcli show processor</code>
Display server details.	<code>odaadmcli show server</code>	<code>oakcli show server</code>
Display InfiniBand card and port information if InfiniBand exists in the system.	<code>odaadmcli show ib</code>	<code>oakcli show ib</code>

## CPU Core Commands

ODACL and OAKCLI commands for common CPU core tasks.

Task	Command to Run on the DCS Stack	Command to Run on the OAK Stack
Lists the history of core configuration changes in the system.	<code>odacli list-cpucores</code>	Not Applicable
Display the current core configuration and the modification date and time.	<code>odacli describe-cpucore</code>	Not Applicable
Update or enable the number of CPU cores in the system	<code>odacli update-cpucore</code>	Not Applicable
Reconfigure your Oracle Database Appliance core capacity.	Not Applicable	<code>oakcli apply</code>

Task	Command to Run on the DCS Stack	Command to Run on the OAK Stack
Adjust the kernel parameters based on the available RAM after you upgrade memory or DIMM.	Not Applicable	oakcli reconfigure osparams
Display information about how to deploy your Oracle Database Appliance cores.	Not Applicable	oakcli show core_config_key

## Oracle Auto Service Request (ASR) Commands

ODACLI and OAKCLI commands for ASR tasks.

Task	Command to Run on the DCS Stack	Command to Run on the OAK Stack
Configure Oracle Auto Service Request (Oracle ASR) after deploying the appliance.	odacli configure-asr	oakcli configure asr
Edit Oracle Auto Service Request (Oracle ASR) configuration details after deploying the appliance.	odacli update-asr	Not Applicable
Display Oracle Auto Service Request (Oracle ASR) configuration details.	odacli describe-asr	oakcli show asr
Test the Oracle Auto Service Request (Oracle ASR) configuration.	odacli test-asr	oakcli test asr
Remove the Oracle Auto Service Request (Oracle ASR) configuration from the system.	odacli delete-asr	Not Applicable

# B

## Oracle Database Appliance Software Configuration Defaults

Oracle Database Appliance software configuration defaults.

- [Directory Paths for Oracle Database Appliance](#)  
Locate the storage and mount configuration file paths for Oracle Database Appliance.
- [Location of Log Files](#)  
Log files are available for actions performed in the command-line interface and Web Console and are useful when you need to track and debug jobs.
- [Oracle Groups and User Configurations for Oracle Database Appliance](#)  
Review the groups and default users when you use the Web Console to deploy the appliance. All passwords are set to the Master password that you define during deployment.

### Directory Paths for Oracle Database Appliance

Locate the storage and mount configuration file paths for Oracle Database Appliance.

Oracle homes on Oracle Database Appliance follow Optimal Flexible Architecture guidelines.

#### Directory Paths for Oracle Database Appliance

Item	Directory Path
Grid home	<i>/u01/app/release-specific_name/gi owner</i>
Grid base	<i>/u01/app/gi owner</i>
Oracle home	<i>/u01/app/rdbms owner/product/ rdbms_version/ dbhome_home_sequence_number</i>
Oracle base	<i>/u01/app/rdbms owner</i>
Oracle Inventory	<i>/u01/app/oraInventory</i>

### Location of Log Files

Log files are available for actions performed in the command-line interface and Web Console and are useful when you need to track and debug jobs.

You can also use the Oracle Appliance Manager Web Console to view job activity, including the tasks that make up the job. The status of each task appears in the Web Console and you can drill down to get greater details.

If you log a Service Request, upload all of the logs in the `/opt/oracle/dcs/log` directory.

### Patching Log Files

All patching-related information is logged in the `dcs-agent` log file at `/opt/oracle/dcs/log/dcs-agent.log`.

### DCS Agent Log Directories

Agent-specific activities are logged in the `dcs-agent` log.

The DCS Agent, controller, and command-line interface output appears in the `/opt/oracle/dcs/log/dcs-agent.log` file.

If an error occurs in the command-line interface layer, then the output will show in the `/opt/oracle/dcs/log/dcscli.log` file first.

### Storage Logs

Storage-related activity is logged in the `oakd` log file.

```
/opt/oracle/oak/log/hostname/oak/oakd.log
```

For example, `/opt/oracle/oak/log/myhost/oak/oakd.log`

Use the `odaadmcli manage diagcollect` command to collect diagnostic logs for storage components. The files are saved in the `oakdiag` log file.

```
/opt/oracle/oak/log/hostname/oakdiag/file_name.tar.gz
```

For example, `/opt/oracle/oak/log/myhost/oakdiag/oakStorage-myhost-20161120_2217.tar.gz`

### Database Logs

Online logs are stored in the `/u03/app/db user/redo/` directory.

Oracle Fast Recovery Area (FRA) is located in the `/u03/app/db user/fast_recovery_area` directory.

Database alert logs are stored in the location `$ORACLE_BASE/diag/rdbms/database_unique_name`.

### Oracle Auto Service Request (Oracle ASR) Log Files

All log files for Oracle ASR are located in the `/var/opt/asrmanager/log/` directory.

# Oracle Groups and User Configurations for Oracle Database Appliance

Review the groups and default users when you use the Web Console to deploy the appliance. All passwords are set to the Master password that you define during deployment.

## Default Operating System Groups and User Configurations

**Table B-1 Default Operating System Groups and Users Configuration for Oracle Database Appliance**

Groups and Users	Default Value
Oracle Grid Infrastructure installation owner	grid, UID 1001
Oracle Database installation owner	oracle, UID 1000
Oracle Database system administrator	sys
Oracle Database generic administrator	system
Oracle Inventory system privileges group	oinstall, GID 1001
Oracle ASM Administrators system privileges	asmadmin, GID 1004
Oracle ASM Users system privileges	asmdba, GID 1006
Oracle ASM Operator system privileges	asmoper, GID 1005
Oracle Database Administrators system privileges	dba, GID 1003
Oracle Database Operator system privileges	dbaoper, GID 1002

### Oracle Groups and User Configurations

You can use the Web Console or the `odacli create-appliance` command and a JSON file to deploy the appliance. The following configurations are supported:

- 2 Users with 6 groups (operating system role separation)
- Single User with 6 groups (no operating system role separation)
- Single user with 2 groups (no operating system role separation)

You can customize `groupname`, `username`, and `UID`.

# Oracle Database Appliance Storage Defaults

Review this section to understand Oracle Database Appliance storage architecture and options and how to determine usable storage.

- [Database Disk Group Sizes for Oracle Database Appliance](#)  
The table in this section shows the sizes for DATA, RECO, REDO, and FLASH disk groups on various configurations of Oracle Database Appliance.
- [Usable Storage on Oracle Database Appliance X5-2](#)  
The table shows the usage storage available for various configurations of Oracle Database Appliance X5-2.
- [About Oracle Database Appliance Storage](#)  
Use Oracle Automatic Storage Management (Oracle ASM) or Oracle Automatic Storage Management Cluster File System (Oracle ACFS) for database files storage.
- [Oracle ACFS Mount Points and Storage Space](#)  
Review Oracle ASM Cluster file system (ACFS) mount points for Oracle Database Appliance.
- [Oracle ACFS Space Management](#)  
The Oracle ACFS file systems are automatically created when you create a database on Oracle Database Appliance.

## Database Disk Group Sizes for Oracle Database Appliance

The table in this section shows the sizes for DATA, RECO, REDO, and FLASH disk groups on various configurations of Oracle Database Appliance.

Each table row has values for either normal or for high redundancy levels. The disk capacities shown in the tables vary, because they are derived by converting disk hardware terabytes (based on 1 kilobyte equals 1,000 bytes) into data storage terabytes (based on 1 kilobyte equals 1,024 bytes).

The space calculated with a storage expansion shelf approximately doubles the space mentioned in these tables.



### Note:

The storage expansion shelf can only be used with Oracle Database Appliance X6-2-HA, X5-2, X4-2, and X3-2.

**Table 2 Approximate Database Disk Group Sizes for Oracle Database Appliance X5-2 and X6-2-HA**

Sizing	X5-2 (GB), 4 TB	X5-2 (GB), 8 TB	X6-2-HA (GB), 8 TB
HDD Size	3,816	7,631	7,631
Total HDD	61,056	122,096	122,096
Total SSD (REDO Disk Group)	744	744	744
Total SSD (FLASH Disk Group)	1,492	1,492	1,492
<b>Total HDD with High Redundancy</b>	20,352	40,699	40,699
<b>Total HDD with Normal Redundancy</b>	30,528	61,048	61,048
<b>DATA</b> Disk Group with <b>High</b> Redundancy - External Backup	15,315	30,626	30,626
<b>RECO</b> Disk Group with <b>High</b> Redundancy - External Backup	2,493	4,986	4,986
<b>DATA</b> Disk Group with <b>High</b> Redundancy - Local Backup	7,473	16,407	16,407
<b>RECO</b> Disk Group with <b>High</b> Redundancy - Local Backup	9,906	21,748	21,748
<b>DATA</b> Disk Group with <b>Normal</b> Redundancy - External Backup	24,513	49,220	49,220
<b>RECO</b> Disk Group with <b>Normal</b> Redundancy - External Backup	4,007	8,013	8,013
<b>DATA</b> Disk Group with <b>Normal</b> Redundancy - Local Backup	12,307	24,610	24,610
<b>RECO</b> Disk Group with <b>Normal</b> Redundancy - Local Backup	15,920	32,623	32,623
<b>REDO</b> Disk Group	248	248	248
<b>FLASH</b> Disk Group	746	746	746

 **Note:**

1. For non-CDB databases, the REDO disk group has 50% free disk space.
2. For CDB databases, an Oracle ACFS mount point is created per CDB database, based on the template log file size. If this is a Single Instance (SI) database, then multiply by 3. If the is an Oracle RAC database, then multiply by 4.
3. Accelerator volume size is 0.4% of the database DATA Oracle ACFS file system size and shared REPO Oracle ACFS file system size.

 **Note:**

High Redundancy is triple-mirroring and Normal Redundancy is double-mirroring. The REDO Disk Group is always High Redundancy. The FLASH Disk Group is always Normal Redundancy.

 **See Also:**

[Oracle Automatic Storage Management Administrator's Guide](#), "Managing Capacity in Disk Groups" for more information about determining the amount of free space in your Oracle Database Appliance disk groups for Oracle ASM. The tables in this topic only provide the raw disk information.

## Usable Storage on Oracle Database Appliance X5-2

The table shows the usage storage available for various configurations of Oracle Database Appliance X5-2.

The reserved storage is the amount of ASM storage required to maintain redundancy in the event of a disk failure. If you use the reserve storage capacity, then the system continues to run, and it is protected through ASM mirroring. However, in the event of a second disk failure, the system is then running in a non-protected and degraded mode. In this event, you must replace disks immediately. Refer to *Oracle Automatic Storage Management Administrator's Guide* for more information about ASM disk group capacity.

**Table 3 Usable Storage on Oracle Database Appliance X5-2**

Sizing	Raw Value (GB)	Reserve (GB)	Usable (GB)
<b>Total SSD</b> (REDO Disk Group) (based on an estimated 190,780 GB) See the Note.	764	191	191
<b>Total SSD</b> (FLASH Disk Group) (based on an estimated 3,816 GB)	1,528	382	573
<b>HDD Size: 8 TB</b>	7,631		
External Backup/ <b>Normal</b> Redundancy (86%/14% split)			
<b>DATA</b> Disk Group with <b>Normal</b> Redundancy - External Backup	105,003	6,563	49,220
<b>RECO</b> Disk Group with <b>Normal</b> Redundancy - External Backup	17,093	1,068	8,013
External Backup/ <b>High</b> Redundancy			
<b>DATA</b> Disk Group with <b>High</b> Redundancy - External Backup	105,003	13,125	30,626
<b>RECO</b> Disk Group with <b>High</b> Redundancy - External Backup	17,093	2,137	4,986
Internal Backup/ <b>Normal</b> Redundancy (43%/57% split)			
<b>DATA</b> Disk Group with <b>Normal</b> Redundancy - Internal Backup	52,501	3,281	24,610
<b>RECO</b> Disk Group with <b>Normal</b> Redundancy - Internal Backup	69,595	4,350	32,623
Internal Backup/ <b>High</b> Redundancy			
<b>DATA</b> Disk Group with <b>High</b> Redundancy - Internal Backup	52,501	3,281	16,407
<b>RECO</b> Disk Group with <b>High</b> Redundancy - Internal Backup	69,595	4,350	21,748



Table 3 (Cont.) Usable Storage on Oracle Database Appliance X5-2

Sizing	Raw Value (GB)	Reserve (GB)	Usable (GB)
<b>HDD Size: 4 TB</b> (Total: HDD Raw: 59,584 GB)	3,816		
External Backup/ <b>Normal</b> Redundancy (86%/14% split)			
<b>DATA</b> Disk Group with <b>Normal</b> Redundancy - External Backup	52,508	3,282	24,613
<b>RECO</b> Disk Group with <b>Normal</b> Redundancy - External Backup	8,548	534	4,007
External Backup/ <b>High</b> Redundancy			
<b>DATA</b> Disk Group with <b>High</b> Redundancy - External Backup	52,508	6564	15,315
<b>RECO</b> Disk Group with <b>High</b> Redundancy - External Backup	8,548	1,068	2,493
Internal Backup/ <b>Normal</b> Redundancy (43%/57% split)			
<b>DATA</b> Disk Group with <b>Normal</b> Redundancy - Internal Backup	26,254	1,641	12,307
<b>RECO</b> Disk Group with <b>Normal</b> Redundancy - Internal Backup	33,963	2,123	15,920
Internal Backup/ <b>High</b> Redundancy			
<b>DATA</b> Disk Group with <b>High</b> Redundancy - Internal Backup	25,621	3,203	7,473
<b>RECO</b> Disk Group with <b>High</b> Redundancy - Internal Backup	33,963	4,245	9,906

#### Related Topics

- [Administering Oracle ASM Disk Groups](#)

## About Oracle Database Appliance Storage

Use Oracle Automatic Storage Management (Oracle ASM) or Oracle Automatic Storage Management Cluster File System (Oracle ACFS) for database files storage.

Database file systems are used exclusively for storing database files, and they include a DATA file system for database data files and a RECO file system for storing archive files and backups. Oracle Database Appliance supports Oracle ACFS and Oracle ASM database file storage. You determine the type of database storage when you create the database.

#### About Oracle ASM Database Storage

With Oracle ASM, database data files are stored in DATA diskgroup. Redo and archive files are in RECO diskgroup.

#### About Oracle ACFS Database Storage

With Oracle ACFS, an Oracle ACFS file system is created from DATA diskgroup for each database to store data files, and an Oracle ACFS file system is created from RECO diskgroup for redo and fast recovery area for all databases.

# Oracle ACFS Mount Points and Storage Space

Review Oracle ASM Cluster file system (ACFS) mount points for Oracle Database Appliance.

If you select Oracle Automatic Storage Management (Oracle ASM) for database storage when you create a database, then an Oracle ASM Cluster file system (ACFS) is not created. All files are in an Oracle ASM diskgroup.

If you select Oracle ACFS for database storage, then each database has its own Oracle ACFS mount point:

- DATA diskgroup: `/u02/app/oracleuser/oradata/db_name`
- RECO diskgroup: `/u03/app/oracleuser`.

With Oracle ACFS, the following are created:

- A 100G ACFS is created from +DATA diskgroup for each database. This Oracle ACFS automatically extends the space on demand.
- A common Oracle ACFS with 25% of +RECO diskgroup is created with auto extension on. This file system is used for fast recovery area and redo logs for all databases.

**Table 4 Oracle ACFS Mount Points and Related Oracle ASM Disk Groups and Volume Information**

File System	Oracle ASM Disk Group	Oracle ASM Dynamic Volume	Mount Point
DATA	+DATA	<code>/dev/asm/datdbname-nnn</code> For example: <code>/dev/asm/datodacn-123</code>	<code>/u02/app/oracleuser/oradata/dbname</code> For example: <code>/u02/app/example/oradata/odacn</code>
RECO	+RECO	<code>/dev/asm/reco-nn</code>	<code>/u03/app/oracleuser</code> This mount point is shared by all databases for fast_recovery_area and redo logs. For fast_recovery_area, the path is: <code>/u03/app/oracleuser/fast_recovery_area/db_name</code> For redo logs, the path is: <code>/u03/app/oracleuser/redo/db_name</code>

## Example 1 Oracle ACFS Storage Space

When the Oracle ACFS file systems are created, they do not initially consume all of the storage in the appliance. Space is preserved for additional repositories, or in some cases, database files stored directly in Oracle ASM. You can check for available storage space in your file systems by running the operating system command `df -k` as shown in the following example.

```
# df -k
Filesystem                1K-blocks  Used    Available  Use%    /
Mounted on
/dev/mapper/VolGroupSys-LogVolRoot 30963708 14203568 15187276 49%    /
tmpfs                      65952292   647800  65304492
1%      /dev/shm
/dev/sda1                   495844     43872   426372   10%    /
boot
/dev/mapper/VolGroupSys-LogVolOpt 61927420 18594420 40187272 32%    /
opt
/dev/mapper/VolGroupSys-LogVolU01 103212320 49621560 48347880 51%    /
u01
/dev/asm/reco-62           76546048 1469676 75076372
2%      /u03/app/oracle
/dev/asm/datrdb2-268       104857600 3872368 100985232
4%      /u02/app/oracle/oradata/rdb2
/dev/asm/datndb11-268     104857600 247160 104610440
1%      /u02/app/oracle/oradata/ndb11
/dev/asm/datndb12-268     104857600 247160 104610440
1%      /u02/app/oracle/oradata/ndb12
```

## Oracle ACFS Space Management

The Oracle ACFS file systems are automatically created when you create a database on Oracle Database Appliance.

When you use Oracle ACFS for database storage, the following is created:

- A 100G ACFS is created from +DATA diskgroup for each database. This Oracle ACFS automatically extends the space on demand.
- A common Oracle ACFS with 25% of +RECO diskgroup is created with auto extension on. This file system is used for fast recovery area and redo logs for all databases.

When the Oracle ACFS file systems are created, they do not initially consume all of the storage in the appliance. Space is preserved for additional repositories, or in some cases, database files stored directly in Oracle ASM. You can check for available storage space in your file systems by running the operating system command `df -k` as shown in the following example.

```
# df -k
Filesystem                1K-blocks  Used    Available  Use%    /
Mounted on
/dev/mapper/VolGroupSys-LogVolRoot 30963708 14203568 15187276 49%    /
tmpfs                      65952292   647800  65304492
1%      /dev/shm
/dev/sda1                   495844     43872   426372   10%    /
boot
/dev/mapper/VolGroupSys-LogVolOpt 61927420 18594420 40187272 32%    /
opt
/dev/mapper/VolGroupSys-LogVolU01 103212320 49621560 48347880 51%    /
u01
/dev/asm/reco-62           76546048 1469676 75076372
2%      /u03/app/oracle
/dev/asm/datrdb2-268       104857600 3872368 100985232
4%      /u02/app/oracle/oradata/rdb2
/dev/asm/datndb11-268     104857600 247160 104610440
1%      /u02/app/oracle/oradata/ndb11
```

/dev/asm/datndb12-268	104857600	247160	104610440
1% /u02/app/oracle/oradata/ndb12			

# D

## Creating an Appliance Using JSON File

Understand the process to create an appliance using the command `odacli create-appliance` and view an example JSON file.

- [Loading and Saving Appliance Configurations](#)  
You can load a saved JSON file and use it to configure your appliance, and save an existing configuration as a JSON file from the Web Console.
- [Readme for the Command `odacli create-appliance`](#)  
If you want to create the appliance outside of the Web Console, then review the readme file for details on how to create a JSON file to use with the command-line interface.
- [Example JSON Files to Create a Single Node Appliance with the CLI](#)  
Follow these JSON file examples to create a JSON file to deploy a single node appliance with the command `odacli create-appliance`.
- [Example JSON File to Create a Multi-Node Appliance with the CLI](#)  
Follow the JSON file example to create a JSON file to deploy a multi-node appliance with the command `odacli create-appliance`.

## Loading and Saving Appliance Configurations

You can load a saved JSON file and use it to configure your appliance, and save an existing configuration as a JSON file from the Web Console.

### Using a Saved Configuration to Create a New Appliance in the Web Console

You can load a saved configuration from your client machine, and create a new appliance.

1. Log into the Web Console.
2. In the Create Appliance page, click **Browse** next to Load Configuration.
3. Select the JSON file from the local machine, being used to access the Web Console.
4. The appliance configuration values from the JSON file are populated in the fields on the Create Appliance page.
5. Make any changes required, and submit the request to create the appliance  
Note that for security requirements, you must enter passwords manually.

### Saving an Appliance Configuration from the Web Console

You can save an appliance configuration and use it to create another appliance.

1. Log into the Web Console.
2. If you have already configured your appliance, then in the Create Appliance page, click **Save Configuration**.

3. The configuration is saved as a JSON file on the local machine, being used to access the Web Console.

## Readme for the Command `odacli create-appliance`

If you want to create the appliance outside of the Web Console, then review the readme file for details on how to create a JSON file to use with the command-line interface.

You can use the command `odacli create-appliance` and a JSON file that includes your appliance configuration settings to deploy the appliance instead of using the Web Console.

### Note:

It is important to review the readme and the examples carefully before creating your JSON file. If you do not enter your network and Oracle ILOM information correctly based on your setup, you will lose network access to both the host and Oracle ILOM.

### Readme

The readme is located in the `/opt/oracle/dcs/sample` directory. Review the readme carefully along with the provided JSON example files. Create a JSON file with the necessary changes based on your environment and requirements.

## Example JSON Files to Create a Single Node Appliance with the CLI

Follow these JSON file examples to create a JSON file to deploy a single node appliance with the command `odacli create-appliance`.

Use the example JSON files and the information located in the readme as a template to create a file for your environment. Examples and the readme are located in the `/opt/oracle/dcs/sample` directory.

### Note:

If you do not enter your network and Oracle ILOM information correctly based on your setup, then network access is lost to both the host and Oracle ILOM.

When using the example to create your JSON file, change the definitions to match your environment. The password must meet password requirements.

### Example D-1 JSON File to Create a Single Node Oracle Database Appliance with Role Separation

The following is an example of a JSON file that creates a single node appliance on Oracle Database Appliance. The example uses role separation.

```
{
  "instance" : {
    "name" : "odambox",
    "instanceBaseName" : "odambox-c",
    "dbEdition" : "EE",
    "timeZone" : "UTC",
    "ntpServers" : ["10.0.3.14"],
    "dnsServers" : ["10.0.4.10","10.0.4.11","10.0.4.12"],
    "domainName" : "example.com",
    "isRoleSeparated" : true,
    "osUserGroup" : {
      "groups" : [ {
        "groupId" : 1001,
        "groupName" : "oinstall",
        "groupRole" : "oinstall"
      }, {
        "groupId" : 1002,
        "groupName" : "dbaoper",
        "groupRole" : "dbaoper"
      }, {
        "groupId" : 1003,
        "groupName" : "dba",
        "groupRole" : "dba"
      }, {
        "groupId" : 1004,
        "groupName" : "asmadmin",
        "groupRole" : "asmadmin"
      }, {
        "groupId" : 1005,
        "groupName" : "asmoper",
        "groupRole" : "asmoper"
      }, {
        "groupId" : 1006,
        "groupName" : "asmdba",
        "groupRole" : "asmdba"
      } ],
      "users" : [ {
        "userId" : 1000,
        "userName" : "oracle",
        "userRole" : "oracleUser"
      }, {
        "userId" : 1001,
        "userName" : "grid",
        "userRole" : "gridUser"
      } ]
    }
  },
  "nodes" : [ {
    "nodeNumber" : "0",
```

```

"nodeName" : "odambox",
"network" : [ {
  "nicName" : "btbond1",
  "ipAddress" : "10.0.1.11",
  "subNetMask" : "255.255.240.0",
  "gateway" : "10.0.0.1",
  "networkType" : [ "Public" ],
  "isDefaultNetwork" : true
},
],
"ilom" : {
  "ilomName": "odambox-c",
  "ipAddress": "10.0.2.10",
  "subNetMask": "255.255.240.0",
  "gateway": "10.0.0.1"
} ],
"grid" : {
  "diskGroup" : [ {
    "diskGroupName" : "DATA",
    "redundancy" : "NORMAL",
    "diskPercentage" : 80
  }, {
    "diskGroupName" : "RECO",
    "redundancy" : "NORMAL",
    "diskPercentage" : 20
  } ],
"scan" : {
  "scanName": "odambox-scan",
  "ipAddresses": [
    "10.0.1.11"
  ]
},
"vip": [
  {
    "nodeNumber": "0",
    "vipName": "odambox-vip",
    "ipAddress": "10.0.1.11"
  }
],
"language" : "en",
"enableAFD": "TRUE"
},
"database" : {
  "dbName" : "myTestDb",
  "databaseUniqueName": "myTestDb_sealkj",
  "dbEdition" : "EE",
  "dbVersion" : "12.2.0.1",
  "dbHomeId": null,
  "instanceOnly" : false,
  "isCdb" : true,
  "pdbName" : "pdb1",
  "pdbAdminuserName" : "pdbuser",
  "enableTDE": true,
  "adminPassword" : "password",

```



```

    "dbType" : "SI",
    "dbTargetNodeNumber" : null,
    "dbClass" : "OLTP",
    "dbShape" : "odbl",
    "dbStorage" : "ACFS",
    "dbCharacterSet" : {
      "characterSet" : "AL32UTF8",
      "nlsCharacterSet" : "AL16UTF16",
      "dbTerritory" : "AMERICA",
      "dbLanguage" : "AMERICAN"
    },
    "dbConsoleEnable" : false,
    "backupConfigId":null,
    "rmanBkupPassword": null
  },
  "asr" :{
    "asrType": "INTERNAL",
    "userName": "john.smith@example.com",
    "password": "password",
    "proxyServerName": "www-proxy.example.com",
    "proxyPort": "80",
    "proxyUserName": "proxy-user",
    "proxyPassword": "proxy-password",
    "snmpVersion": "v2"
  }
}

```

### Example D-2 JSON File to Create a Single Node Oracle Database Appliance without Role Separation

The following is an example of a JSON file that creates an Oracle Database Appliance without using role separation. This example creates two groups (oinstall and dba) and one user ("oracle").

```

{
  "instance" : {
    "name" : "odambox",
    "instanceBaseName" : "odambox-c",
    "dbEdition" : "EE",
    "timeZone" : "UTC",
    "ntpServers" : ["10.0.3.14"],
    "dnsServers" : ["10.0.4.10", "10.0.4.11", "10.0.4.12"],
    "domainName" : "example.com",
    "isRoleSeparated" : false,
    "osUserGroup" : {
      "groups" : [ {
        "groupId" : 1001,
        "groupName" : "oinstall",
        "groupRole" : "oinstall"
      }, {
        "groupId" : 1002,
        "groupName" : "dba",
        "groupRole" : "dba"
      } ],
      "users" : [ {

```

```

        "userId" : 1000,
        "userName" : "oracle",
        "userRole" : "oracleUser"
    } ]
}
},
"nodes" : [ {
    "nodeNumber" : "0",
    "nodeName" : "odambox",
    "network" : [ {
        "nicName" : "btbond1",
        "ipAddress" : "10.0.1.11",
        "subNetMask" : "255.255.240.0",
        "gateway" : "10.0.0.1",
        "networkType" : [ "Public" ],
        "isDefaultNetwork" : true
    },
    ],
    "ilom" : {
        "ilomName" : "odambox-c",
        "ipAddress" : "10.0.2.10",
        "subNetMask" : "255.255.240.0",
        "gateway" : "10.0.0.1"
    }
} ],
"grid" : {
    "diskGroup" : [ {
        "diskGroupName" : "DATA",
        "redundancy" : "NORMAL",
        "diskPercentage" : 80
    }, {
        "diskGroupName" : "RECO",
        "redundancy" : "NORMAL",
        "diskPercentage" : 20
    } ],
    "scan" : {
        "scanName" : "odambox-scan",
        "ipAddresses" : [
            "10.0.1.11"
        ]
    },
    "vip" : [
        {
            "nodeNumber" : "0",
            "vipName" : "odambox-vip",
            "ipAddress" : "10.0.1.11"
        }
    ],
    "language" : "en",
    "enableAFD" : "TRUE"
},
"database" : {
    "dbName" : "myTestDb",
    "databaseUniqueName" : "myTestDb_sealkj",
    "dbEdition" : "EE",

```

```

    "dbVersion" : "12.2.0.1",
    "dbHomeId":null,
    "instanceOnly" : false,
    "isCdb" : true,
    "pdbName" : "pdb1",
    "pdbAdminuserName" : "pdbuser",
    "enableTDE":true,
    "adminPassword" : "password",
    "dbType" : "SI",
    "dbTargetNodeNumber" : null,
    "dbClass" : "OLTP",
    "dbShape" : "odbl",
    "dbStorage" : "ACFS",
    "dbCharacterSet" : {
      "characterSet" : "AL32UTF8",
      "nlsCharacterSet" : "AL16UTF16",
      "dbTerritory" : "AMERICA",
      "dbLanguage" : "AMERICAN"
    },
    "dbConsoleEnable" : false,
    "backupConfigId":null,
    "rmanBkupPassword": null
  },
  "asr" :{
    "asrType": "INTERNAL",
    "userName":"john.smith@example.com",
    "password":"password",
    "proxyServerName":"www-proxy.example.com",
    "proxyPort":"80",
    "proxyUserName":"proxy-user",
    "proxyPassword":"proxy-password",
    "snmpVersion":"v2"
  }
}

```

## Example JSON File to Create a Multi-Node Appliance with the CLI

Follow the JSON file example to create a JSON file to deploy a multi-node appliance with the command `odacli create-appliance`.

Use the example JSON files and the information located in the readme as a template to create a file for your environment. Examples and the readme are located in the `/opt/oracle/dcs/sample` directory.

### Note:

It is important to review the readme and the examples carefully before creating your JSON file. If you do not enter your network and Oracle ILOM information correctly based on your setup, then network access is lost to both the host and Oracle ILOM.

### Example D-3 JSON File to Create a Multi-Node Oracle Database Appliance with Role Separation

The following is an example of a JSON file that creates a multi-node appliance on Oracle Database Appliance bare metal platform. The example uses role separation. When using the example to create your JSON file, change the definitions to match your environment. The password must meet password requirements.

```
{
  "instance":{
    "name":"odahabox",
    "instanceBaseName":"odahabox",
    "dbEdition":"EE",
    "timeZone":"UTC",
    "ntpServers" : ["10.0.3.14"],
    "dnsServers" : ["10.0.4.10","10.0.4.11","10.0.4.12"],
    "domainName":"example.com",
    "isRoleSeparated":true,
    "osUserGroup":{
      "groups":[
        {
          "groupId":1001,
          "groupName":"oinstall",
          "groupRole":"oinstall"
        },
        {
          "groupId":1002,
          "groupName":"dbaoper",
          "groupRole":"dbaoper"
        },
        {
          "groupId":1003,
          "groupName":"dba",
          "groupRole":"dba"
        },
        {
          "groupId":1004,
          "groupName":"asmadmin",
          "groupRole":"asmadmin"
        },
        {
          "groupId":1005,
          "groupName":"asmoper",
          "groupRole":"asmoper"
        },
        {
          "groupId":1006,
          "groupName":"asmdba",
          "groupRole":"asmdba"
        }
      ],
      "users":[
        {
          "userId":101,
          "userName":"grid",
```

```

        "userRole": "gridUser"
      },
      {
        "userId": 102,
        "userName": "oracle",
        "userRole": "oracleUser"
      }
    ]
  },
  "objectStoreCredentials": null
},
"nodes": [
  {
    "nodeNumber": "0",
    "nodeName": "odahaboxc1n2",
    "network": [
      {
        "nicName": "btbond1",
        "ipAddress": "10.31.98.133",
        "subNetMask": "255.255.240.0",
        "gateway": "10.31.96.1",
        "networkType": [
          "Public"
        ],
        "isDefaultNetwork": true
      }
    ],
    "ilom": {
      "ilomName": "odahabox2-c",
      "ipAddress": "10.31.16.140",
      "subNetMask": "255.255.240.0",
      "gateway": "10.31.16.1"
    }
  },
  {
    "nodeNumber": "1",
    "nodeName": "odahaboxc1n1",
    "network": [
      {
        "nicName": "btbond1",
        "ipAddress": "10.31.98.132",
        "subNetMask": "255.255.240.0",
        "gateway": "10.31.96.1",
        "networkType": [
          "Public"
        ],
        "isDefaultNetwork": true
      }
    ],
    "ilom": {
      "ilomName": "odahabox1-c",
      "ipAddress": "10.31.16.139",
      "subNetMask": "255.255.240.0",
      "gateway": "10.31.16.1"
    }
  }
]

```

```

    }
  ],
  "grid":{
    "diskGroup":[
      {
        "diskGroupName":"DATA",
        "redundancy":"HIGH",
        "diskPercentage":80
      },
      {
        "diskGroupName":"RECO",
        "redundancy":"HIGH",
        "diskPercentage":20
      },
      {
        "diskGroupName":"REDO",
        "redundancy":"HIGH",
        "diskPercentage":null
      }
    ],
    "scan":{
      "scanName":"odahaboxcl-scan",
      "ipAddresses":[
        "10.31.98.182",
        "10.31.98.183"
      ]
    },
    "vip":[
      {
        "nodeNumber":"0",
        "vipName":"odahaboxcln2-vip",
        "ipAddress":"10.31.98.159"
      },
      {
        "nodeNumber":"1",
        "vipName":"odahaboxcln1-vip",
        "ipAddress":"10.31.98.158"
      }
    ],
    "language":"en",
    "enableAFD":"TRUE"
  },
  "database":{
    "dbName":"myTestDb",
    "databaseUniqueName":"myTestDb_sealkj",
    "dbVersion":"12.2.0.1",
    "dbHomeId":null,
    "instanceOnly":false,
    "isCdb":true,
    "pdbName":"pdb1",
    "pdbAdminuserName":"pdbuser",
    "enableTDE":true,
    "adminPassword":"password",
    "dbType":"RAC",
    "dbTargetNodeNumber":null,

```

```
    "dbClass": "OLTP",
    "dbShape": "odbl",
    "dbStorage": "ACFS",
    "dbCharacterSet": {
      "characterSet": "AL32UTF8",
      "nlsCharacterSet": "AL16UTF16",
      "dbTerritory": "AMERICA",
      "dbLanguage": "AMERICAN"
    },
    "dbConsoleEnable": false,
    "backupConfigId": null
  },
  "asr": null
}
```

# E

## Database Templates for Oracle Database Appliance

Use the information in this appendix to select database templates for your planned databases.

Topics:

- [Types of Database Templates for Oracle Database Appliance](#)  
Choose a database template that best meets your database workload and hardware.

### Types of Database Templates for Oracle Database Appliance

Choose a database template that best meets your database workload and hardware.

#### About Database Templates for Oracle Database Appliance

Oracle Database Appliance enables you to consolidate many databases into a single system. Consolidation can minimize idle resources, maximize efficiency, and lower costs. By using instance caging in conjunction with Oracle Database Resource Manager (the Resource Manager), you can provide desired levels of service across multiple instances on a single Oracle Database Appliance.

Oracle Database Appliance templates are already tuned for the size of each database instance workload. They are designed to run on a specific number of cores. Caging ensures that each database workload is restricted to the set of cores allocated by the template, enabling multiple databases to run concurrently with no performance degradation, up to the capacity of Oracle Database Appliance. You can select database template sizes larger than your current needs to provide for planned growth, which you accommodate later by adjusting System Global Area (SGA) and Program Global Area (PGA) sizes as well as the number of cores.

The Oracle Appliance Manager Configurator refers to the database sizing templates as *classes* of databases.

#### Note:

Oracle strongly recommends that you use the Oracle Database Appliance templates, because they implement best practices and are configured specifically for Oracle Database Appliance.

Use the following tables to help select the best templates for your databases. When using these tables remember that:



- The information in the tables assumes that you are creating disk backups. The information in the tables assume that you are creating local disk backups. Consider the space requirements for your database and the policy for local disk backups versus external backups. Typically, external backups have more space available for the database than local backups.
- Container databases are created on Oracle ACFS.
- I/O per second (I/Ops) values are derived from an 8-kilobyte random read-write response time of 10 to 12 milliseconds for Hard Disk Drives (HDDs), and less than 1 millisecond for Flash, for Oracle Database Appliance X5-2; 5 to 7 milliseconds for Oracle Database Appliance X4-2 and X3-2; and 5 milliseconds for Oracle Database Appliance Version 1 to service an online transaction processing (OLTP) I/O request. The rates are not based on the number of CPUs and assume that the system is running at capacity.
- Throughput, in megabytes per second (MBps) is based on a 1 MB sequential read/write for a data warehousing system. As with I/Ops, the MBps is a measure of throughput when the system is at capacity. With just a single small database running, the MBps would be the maximum available on the system for a large database.
- The log file size assumes four redo log groups for each instance with a log switch every 15 minutes when the system is running at full capacity.
- Storage is shared between the servers on Oracle Database Appliance.

### About Improved Oracle Database Appliance Template Options

Oracle Appliance Manager provides improved database templates that are configured specifically for the type of database workload that you want to carry out on your databases on Oracle Database Appliance. Choose the template that best matches the common workload your databases perform (OLTP, DSS, In-Memory).

The improved Oracle Database templates replace the generic database templates from previous releases that only provided sizing parameters for OLTP workloads. The database sizing tables provide updated template names and sizing based on the number of CPUs and memory attributes for each type of database workload. The table "Oracle Database Appliance Database Template Name Conversions" provides a reference between the generic database template names and the database template names based on CPU cores.

Identify the template type that is appropriate to your database workload and hardware:

- Use Oracle Database Appliance OLTP Database Templates if your database workload is primarily online transaction processing (OLTP).
- Use Oracle Database Appliance DSS database templates if your database workload is primarily decision support services (DSS) or data warehousing.
- Use Oracle Database Appliance In-Memory (IMDB) database templates if your database workload can fit in memory, and can benefit from in-memory performance capabilities.
- Use Oracle Database Appliance X5-2 generic database templates if your database is on Oracle Database Appliance X5-2.
- Use Oracle Database Appliance X4-2 generic database templates if your database is on Oracle Database Appliance X4-2.

- Use Oracle Database Appliance X3-2 generic database templates if your database is on Oracle Database Appliance X3-2.
- Use Oracle Database Appliance Version 1 generic database templates if your appliance is the original model of Oracle Database Appliance.

The templates provide general guidelines about the maximum number of databases on a fully deployed Oracle Database Appliance. Base the memory and CPU sizing on the number of instances per server, not the number of databases. Memory and CPUs are shared by all databases and the number of databases impacts performance. For example, when you have one database, the database receives full I/O throughput. If you have 9 databases, then each database has only 1/9th of the available I/O throughput for all disks.

When you have multiple databases, they share and compete over available CPU resources. When choosing a template, do not have more CPU\_COUNTs distributed than available threads in the system. Oracle recommends partitioning, where every database has exclusive CPUs. If you choose to exceed the recommended maximum number of databases on Oracle Database Appliance (over-provision), be aware of your I/O results and performance degradation. With the over-provisioned approach, the sum of the CPU\_COUNT across all instances can exceed the number of CPUs. Better resource utilization is provided with over-provisioning; however, it is possible for contention to occur when multiple databases are heavily loaded at the same time. Over-provisioning is best used for systems running non-critical applications. Avoid using over-provisioning for databases with high I/O requirements or those with high transaction rates. If you choose to over-provision, then do not exceed twice the number of total CPUs. Twice the allocation of total CPUs is based on hyper-threading of 2 CPU threads per core.

**Table E-1 Oracle Database Appliance Database Generic Template Name Conversions**

CPU Core-Based Database Template Names	odb-01s	odb-01	odb-02	odb-04	odb-06	odb-12	odb-16	odb-24
Generic Database Template Names	Very, very small	Very Small	Small	Medium	Large	Extra Large	Extra Extra Large	Extra Extra Extra Large

 **Note:**

Extra Extra Large is applicable to Oracle Database Appliance X3-2 and Oracle Database Appliance X4-2. Extra Extra Extra Large is applicable to Oracle Database Appliance X4-2 only.

**Table E-2 Oracle Database Appliance OLTP Database Template Sizes**

Template	CPU Cores	SGA	PGA	Flash	Processes	LOG buffer, Redo Log
odb-01s (X5-2, X4-2, X3-2, and V1)	1	2 GB	1 GB	6 GB	200	16 MB, 1 GB
odb-01 (X5-2, X4-2, X3-2, and V1)	1	4 GB	2 GB	12 GB	200	16 MB, 1 GB

**Table E-2 (Cont.) Oracle Database Appliance OLTP Database Template Sizes**

Template	CPU Cores	SGA	PGA	Flash	Processes	LOG buffer, Redo Log
odb-02 (X5-2, X4-2, X3-2, and V1)	2	8 GB	4 GB	24 GB	400	16 MB, 1 GB
odb-04 (X5-2, X4-2, X3-2, and V1)	4	16 GB	8 GB	48 GB	800	32 MB, 1 GB
odb-06 (X5-2, X4-2, X3-2, and V1)	6	24 GB	12 GB	72 GB	1200	64 MB, 2 GB
odb-12 (X5-2, X4-2, X3-2, and V1)	12	48 GB	24 GB	144 GB	2400	64 MB, 4 GB
odb-16 (X5-2, X4-2, X3-2 Only)	16	64 GB	32 GB	192 GB	3200	64 MB, 4 GB
odb-24 (X5-2, X4-2 Only)	24	96 GB	48 GB	192 GB	4800	64 MB, 4 GB
odb-32 (X5-2 Only)	32	128 GB	64 GB	256 GB	6400	64 MB, 4 GB
odb-36 (X5-2 Only)	36	128 GB	64 GB	256 GB	7200	64 MB, 4 GB



**Note:**

Flash is applicable to Oracle Database Appliance X5-2 only.

**Table E-3 Oracle Database Appliance DSS Database Template Sizes**

Template	CPU Cores	SGA (GB)	PGA (GB)	Processes	Redo log file size (GB)	Log buffer (MB)
odb-01s (X5-2, X4-2, X3-2, and V1)	1	1	2	200	1	16
odb-01 (X5-2, X4-2, X3-2, and V1)	1	2	4	200	1	16
odb-02 (X5-2, X4-2, X3-2, and V1)	2	4	8	400	1	16
odb-04 (X5-2, X4-2, X3-2, and V1)	4	8	16	800	1	32
odb-06 (X5-2, X4-2, X3-2, and V1)	6	12	24	1200	2	64
odb-12 (X5-2, X4-2, X3-2, and V1)	12	24	48	2400	4	64
odb-16 (X5-2, X4-2, X3-2 Only)	16	32	64	3200	4	64
odb-24 (X5-2, X4-2 Only)	24	48	96	4800	4	64
odb-32 (X5-2 Only)	32	64	128	6400	4	64
odb-36 (X5-2 Only)	36	64	128	7200	4	64

**Table E-4 Oracle Database Appliance In-Memory Database Template Size**

Template	CPU Cores	SGA (GB)	PGA (GB)	In-Memory (GB)	Processes	Redo log file size (GB)	Log buffer (MB)
odb-01s (X5-2, X4-2, X3-2, and V1)	1	2	1	1	200	1	16
odb-01 (X5-2, X4-2, X3-2, and V1)	1	4	2	2	200	1	16
odb-02 (X5-2, X4-2, X3-2, and V1)	2	8	4	4	400	1	16
odb-04 (X5-2, X4-2, X3-2, and V1)	4	16	8	8	800	1	32
odb-06 (X5-2, X4-2, X3-2, and V1)	6	24	12	12	1200	2	64
odb-12 (X5-2, X4-2, X3-2, and V1)	12	48	24	24	2400	4	64
odb-16 (X5-2, X4-2, X3-2 Only)	16	64	32	32	3200	4	64
odb-24 (X5-2, X4-2 Only)	24	96	48	48	4800	4	64
odb-32 (X5-2 Only)	32	128	64	64	6400	4	64
odb-36 (X5-2 Only)	36	128	64	64	7200	4	64

**Table E-5 Oracle Database Appliance X5-2 Database Template Size Storage Performance**

Template	Number of databases that you can deploy using this template	Container Database ACFS Size on DATA Disk Group (GB)	I/Ops with single storage shelf (HDD/FLASH)	Throughput (MBps) with single storage shelf (HDD/FLASH)	I/Ops with storage shelf plus storage expansion shelf (HDD/FLASH)	Throughput (MBps) with storage shelf plus storage expansion shelf (HDD/FLASH)	Log generation (MBps)
odb-01s	36	100	42/4167	83/83	83/8333	167/167	6.83
odb-01	36	100	42/4167	83/83	83/8333	167/167	6.83
odb-02	18	200	83/8.3K	167/167	167/16.7K	333/333	6.83
odb-04	9	400	167/16.7K	333/333	333/33.3K	667/667	13.65
odb-06	6	800	250/25K	500/500	500/50K	1000/1000	27.3
odb-12	3	1600	500/50K	1000/1000	1000/100K	2000/2000	27.3
odb-16	2	1600	750/75K	1500/1500	1500/150K	3000/3000	27.3
odb-24	1	1600	1500/150K	3000/3000	3000/300K	6000/6000	27.3
odb-32	1	1600	1500/150K	3000/3000	3000/300K	6000/6000	27.3
odb-36	1	1600	1500/150K	3000/3000	3000/300K	6000/6000	27.3

 **Note:**

The number of databases that you can deploy using this template is for the entire Oracle Database Appliance.

Actual I/O per second (I/Ops) and throughput for a database depends on the percentage of I/O operations that are serviced through the FLASH, compared with the operations serviced through the hard disk drives (HDDs). The I/Ops weighting in these tables assumes an OLTP workload calculated as a mixed workload (80 percent reads, serviced through the FLASH cache, and 20 percent writes serviced through the HDDs).

**Table E-6 Oracle Database Appliance X4-2 Database Template Size Storage Performance**

Template	Number of databases that you can deploy using this template	Container Database ACFS Size on DATA Disk Group (GB)	I/Ops with single storage shelf	Throughput (MBps) with single storage shelf	I/Ops with storage shelf plus storage expansion shelf	Throughput (MBps) with storage shelf plus storage expansion shelf	Log generation (MBps)
odb-01s	24	100	138	146	275	229	6.83
odb-01	24	100	138	146	275	230	6.83
odb-02	12	200	275	292	550	458	6.83
odb-04	6	400	550	583	1100	917	13.65
odb-06	4	800	825	875	1650	1375	27.3
odb-12	2	1600	1650	1750	3300	2750	27.3
odb-16	1	1600	3300	3500	6600	5500	27.3
odb-24	1	1600	3300	3500	6600	5500	27.3

**Table E-7 Oracle Database Appliance X3-2 Database Template Size Storage Performance**

Template	Number of databases that you can deploy using this template	Container Database ACFS Size on DATA Disk Group (GB)	I/Ops with single storage shelf	Throughput (MBps) with single storage shelf	I/Ops with storage shelf plus storage expansion shelf	Throughput (MBps) with storage shelf plus storage expansion shelf	Log generation (MBps)
odb-01s	16	100	206	219	413	344	6.83
odb-01	16	100	206	219	413	344	6.83
odb-02	8	200	413	438	825	688	6.83
odb-04	4	400	825	875	1650	1375	13.65
odb-06	2	800	1650	1750	3300	2750	27.3
odb-12	1	1600	3300	3500	6600	5500	27.3
odb-16	1	1600	3300	3500	6600	5500	27.3

**Table E-8 Oracle Database Appliance Version 1 Database Template Size Storage Performance**

Template	Number of databases that you can deploy using this template	Container Database ACFS Size on DATA Disk Group (GB)	I/Ops	Throughput (MBps)	Log generation (Mps)
odb-01s	12	100	333	250	6.83
odb-01	12	100	333	250	6.83
odb-02	6	200	667	500	6.83
odb-04	3	400	1333	1000	13.65
odb-06	2	800	2000	1500	27.3
odb-12	1	1600	4000	3000	27.3

 **Note:**

For a single database, select a template that best fits your expected workload (the CPU and I/Ops capabilities you require) on the hardware that you are using. When creating multiple databases, calculate the overall workload; available system resources for any new database are affected by the CPU and I/Ops consumed by the existing databases that are already on the system.

# Index

## Numerics

---

25-GbE network interface, [12-7](#)

## A

---

ACFS, [7-9](#)

ACFS mount points, [8](#)

add repositories, [20](#)

administrative account users, [9-1](#)

administrative accounts, [9-1](#)

agent

    update, [13-36-13-38](#)

agent proxy setting, [11-9](#)

ASM, [7](#)

ASM Cluster File System

    See Oracle ACFS

ASR, [14-54](#)

    configure, [13-113](#)

    delete, [13-118](#)

    details, [13-116](#)

    test, [13-117](#)

    update, [13-115](#)

        See also Oracle ASR (Auto Service Request)

Automatic Storage Management

    See Oracle ASM

## B

---

back up database, [11-13](#)

backup and recovery

    CLI commands, [13-52](#)

    RMAN, [9-2](#)

backup databases, [11-1](#)

backup file location

    configurator, [2-10](#)

backup policy, [11-15](#), [11-16](#)

    update, [11-12](#)

backup to external FRA, [11-11](#)

backup to internal FRA, [11-11](#)

backup to NFS location, [11-11](#)

backup to Object Store, [11-11](#)

bare metal patching, [8](#), [13](#)

bill of materials, [15-2](#)

bond

    network interface, [12-7](#)

bridge

    network interface, [12-7](#)

## C

---

cabling, [3-2](#)

    Oracle Database Appliance model X4-2 and X3-2, [3-3](#)

    Oracle Database Appliance model X5-2, [3-2](#)  
    validate, [13-135](#)

checklist

    for system requirements, [2-6](#)

    tasks to complete before deployment, [2-1](#)

cleanup utility, [8-1](#)

cleanup.pl, [8-1](#), [15-5](#)

CLI commands

    configure, [13-8](#)

cloning database, [9-9](#), [9-10](#)

cloudfs

    display file systems, [14-45](#)

Cluster Health Monitor

    collect diagnostic data, [14-28](#), [14-29](#)

Cluster Time Synchronization Service

    See CTSS

component version

    display, [14-55](#)

configuration

    type, [13](#)

Configuration Audit Tool (ORAchk), [15-6](#)

configuration file, [23](#)

configure CLI commands

    configure-firstnet, [13-8](#)

configure virtual machine, [12-43](#)

configure-firstnet, [4-1](#)

container database, [24](#)

controllers

    display details, [14-48](#)

cooling

    show status, [14-37](#)

cores

    display how allocated to virtual machines, [14-38](#)

- CPU
    - caging, [12-44](#)
    - commands, [13-71](#)
    - display details, [14-38](#)
    - display processor details, [14-46](#)
  - CPU core
    - current configuration, [13-72](#)
    - enable, [13-72](#)
    - update, [14-57](#)
  - CPU cores
    - configuration history, [13-71](#)
    - list, [13-71](#)
  - CPU pool, [12-44](#)
    - default-unpinned-pool, [12-44](#)
    - over-subscribed, [12-45](#)
  - create additional networks, [12-9](#)
  - create appliance, [4-7](#)
  - CTSS (Cluster Time Synchronization Service), [2-7](#)
- ## D
- 
- database, [2-10](#), [9-12](#), [E-1](#)
    - backup policy, [11-12](#)
    - block size
      - configurator, [2-10](#)
    - clone from backup, [9-8](#)
    - consolidate multiple, [E-1](#)
    - create, [9-4](#)
    - delete, [9-11](#), [9-13](#)
    - details, [9-4](#)
    - display file systems, [14-45](#)
    - home, [9-12](#)
      - create multiple, [9-12](#)
      - multiple, [9-12](#)
    - language
      - configurator, [2-10](#)
    - list, [9-4](#)
    - register, [13-82](#)
    - shape
      - See shape, database
    - template
      - See shape, database
    - territory
      - configurator, [2-10](#)
    - upgrade, [9-11](#)
  - database backup
    - delete, [11-14](#)
  - database class, [24](#)
  - database configuration
    - display parameters, [14-39](#)
  - database configuration file
    - create, [14-19](#)
    - delete, [14-23](#)
  - database home
    - create, [9-13](#)
    - details, [9-13](#)
    - display details, [13-90](#)
    - list, [9-13](#)
  - database homes
    - display details, [14-40](#)
  - database language, [24](#)
  - database snapshot
    - create, [14-21](#)
  - database storage, [4](#), [7](#)
    - commands, [13-91](#)
    - create, [13-94](#)
    - display details, [13-92](#), [13-95](#)
    - list, [13-92](#)
  - database template
    - See template, database
  - database templates, [E-1](#)
  - database type, [24](#)
  - database, register, [9-17](#)
  - dbhome
    - delete, [14-23](#)
  - default groups and users, [B-3](#)
  - deleting backups, [11-23](#)
  - deploying, [14](#)
  - deployment plan, [23](#)
  - DHCP (Dynamic Host Configuration Protocol)
    - connect to Oracle ILOM, [3-14](#)
    - initial network, [14-10](#)
    - Oracle ILOM configuration, [3-14](#)
  - directory paths, [B-1](#)
  - disk
    - display details, [14-42](#)
  - disk controllers
    - display details, [14-38](#)
  - disk group sizes, [B-3](#)
  - disk group storage
    - describe, [13-96](#)
    - list, [13-98](#)
  - disk storage
    - display details, [14-48](#)
  - DNS
    - See domain name system
  - domain
    - definition, [12-4](#)
  - Domain 0 (Dom0)
    - definition, [12-3](#)
  - domain name system, [2-7](#)
  - Domain U
    - definition, [12-3](#)
  - downloading software, [4-6](#)
  - driver domain virtual machine
    - about, [12-31](#)
  - Dynamic Host Configuration Protocol
    - See DHCP



---

## E

electrical power cords  
   connecting, [3-11](#)

EM Express, [9-20](#)

environment  
   display, [14-43](#)

errors  
   display validation, [14-49](#)

expander  
   display information, [14-44](#)  
   error detection, [14-44](#)

expanders  
   display details, [14-48](#)

external FRA, [11-1](#)

---

## F

failures  
   display validation, [14-49](#)

fiber connections, [3-5](#)

firmware  
   display version, [14-50](#)  
   invalid version failure, [14-49](#)  
   patching, [14-55](#)

flex diskgroup, [9-4](#)

---

## G

Grid user, [9-1](#)

group user  
   change name or ID, [14-25](#)

groups, [2-4](#)

groups and users defaults, [B-3](#)

Guest Domains (Domain U)  
   definition, [12-3](#)

guest virtual machine  
   definition, [12-4](#)

---

## H

hardware  
   display version, [14-43](#)

high availability, [12-43](#)

Host Public Addresses  
   IP address, [2-11](#)

---

## I

InfiniBand, [3-5](#)  
   replacing cards, [3-13](#)

InfiniBand interconnect cabling, [3-2](#)

install software, [4-7](#)

installed version  
   display, [13-19](#), [13-25](#), [13-26](#), [13-29](#), [13-32](#)

instance caging, [9-19](#)  
   enable, [9-19](#)  
   template, [E-1](#)

Integrated Lights Out Manager  
   See Oracle ILOM

interconnect cables  
   attach, [3-2](#)  
   storage expansion shelf, [3-7](#)

internal FRA, [11-1](#)

ISO image  
   virtualized, [13](#), [14](#)

---

## J

JSON file, [D-2](#), [D-7](#)

---

## K

kernel parameters  
   adjust after memory upgrade, [14-32](#)

keyboard  
   adding, [3-10](#)

---

## L

LED  
   physical disk identifier, [14-27](#)  
   status when blinking, [3-11](#)  
   status when steady, [3-11](#)  
   status when steady on, [3-11](#)

Linux  
   and virtualization, [12-2](#)

listener.ora, configure, [9-15](#)

load configuration, [D-1](#)

local repository, [12-16](#)

log files, [B-1](#)  
   sending to Oracle Support Services, [15-19](#)

log switch  
   select template, [E-1](#)

logs  
   storage diagnostic, [13-43](#), [13-105](#)

---

## M

master node  
   command, [14-44](#)

memory module  
   display details, [14-45](#)

migration  
   from an existing database, [9-2](#)

monitor  
   adding, [3-10](#)

mouse  
 adding, [3-10](#)  
 multiple database instances  
 instance caging, [9-19](#)  
 multiple Oracle homes, [9-12](#)  
 create, [9-12](#)  
 My Oracle Support, [15-19](#)  
 hardware SI, [2-1](#)  
 send log files for troubleshooting, [15-19](#)

## N

---

network  
 configure, [13-8](#)  
 display details, [14-45](#)  
 network infrastructure, [12-7](#)  
 network interface  
 default values, [12-7](#)  
 network planning, [2-7](#)  
 network time protocol service (NTP service)  
 configurator, [2-10](#)  
 network validation, [24](#)  
 NFS backup, [11-8](#)  
 NTP service  
 See network time protocol service

## O

---

oakcli  
 show cooling, [14-37](#)  
 oakcli commands  
 -repo parameter, [12-22](#)  
 -snap, [12-23](#)  
 -vm, [12-23](#)  
 -vmtemplate, [12-23](#)  
 add disk -local, [14-7](#)  
 clone vdisk, [12-14](#), [14-64](#)  
 clone vm, [12-22](#), [12-23](#), [14-66](#)  
 clones and snap clones, [12-21](#)  
 configure, [14-7](#)  
 configure additionalnet, [12-9](#), [14-8](#)  
 configure ASR, [14-9](#)  
 configure cpupool, [12-46](#), [14-10](#)  
 configure firstnet, [14-10](#)  
 configure network, [14-11](#)  
 configure networks, [14-8](#)  
 configure oda\_base, [14-11](#)  
 configure repo, [12-13](#), [14-13](#)  
 configure vm, [12-7](#), [12-19](#), [12-20](#), [12-43](#),  
[12-46](#), [14-68](#)  
 configure vmtemplate, [12-19](#), [12-20](#), [14-75](#)  
 copy, [14-13](#)  
 create, [14-14](#)  
 db\_config\_params, [14-19](#)  
 create cpupool, [12-45](#), [14-14](#)

oakcli commands (*continued*)  
 create database, [14-15](#)  
 create dbhome, [14-17](#)  
 create dbstorage, [14-18](#)  
 create repo, [12-10](#), [14-20](#)  
 create vdisk, [12-13](#)  
 create vlan, [14-81](#)  
 delete, [14-21](#)  
 delete cpupool, [14-22](#)  
 delete database, [14-22](#)  
 delete db\_config\_params, [14-23](#)  
 delete dbhome, [14-23](#)  
 delete dbstorage, [14-24](#)  
 delete repo, [12-12](#), [14-24](#)  
 delete vdisk, [12-15](#)  
 delete vlan, [14-82](#)  
 delete vm, [14-71](#)  
 delete vmtemplate, [12-21](#), [14-77](#)  
 deploy  
 change group name and ID, [14-25](#)  
 log file, [14-25](#)  
 describe-system, [14-29](#)  
 diskwritecache, [14-27](#)  
 expand storage, [14-26](#)  
 import vmtemplate, [12-18](#), [14-78](#)  
 locate, [14-27](#)  
 manage diagcollect, [14-28](#)  
 migrate vm, [14-71](#)  
 modify database, [14-30](#)  
 modify vm, [12-15](#), [14-71](#)  
 modify vmtemplate, [14-80](#)  
 oakcli create db\_config\_params, [14-19](#)  
 oakcli create snapshotdb, [14-21](#)  
 oakcli create vdisk, [14-63](#)  
 oakcli delete vdisk, [14-64](#)  
 oakcli show dbstorage, [14-41](#)  
 oakcli show fs, [14-45](#)  
 oakcli show vmconsole, [14-74](#)  
 orachk, [14-31](#)  
 reconfigure kernel parameters, [14-32](#)  
 reconfigure memlock, [14-32](#)  
 reconfigure osparams, [14-32](#)  
 reconfigure vm.nearhugepage, [14-32](#)  
 resize dbstorage, [14-33](#)  
 restart oda\_base, [14-34](#)  
 show, [14-34](#)  
 show asr, [14-37](#)  
 show controller, [14-38](#)  
 show cpupool, [12-46](#), [14-38](#)  
 show databases, [14-39](#)  
 show db\_config\_params, [14-39](#)  
 show dbhomes, [14-40](#)  
 show disk, [14-42](#)  
 show diskgroup, [14-43](#)  
 show enclosure, [14-43](#)

oakcli commands (*continued*)

- show env\_hw, [14-43](#)
- show expander, [14-44](#)
- show ismaster, [14-44](#)
- show memory, [14-45](#)
- show network, [14-45](#)
- show power, [14-45](#)
  - example, [15-12](#)
- show processor, [14-46](#)
- show raidsyncstatus, [14-47](#)
- show repo, [12-11](#), [14-47](#)
- show server, [14-48](#)
- show storage, [14-48](#)
- show validation storage, [14-49](#)
- show validation storage errors, [14-49](#)
- show validation storage failures, [14-49](#)
- show vdisk, [12-14](#), [14-65](#)
- show version, [14-50](#)
- show vlan, [14-83](#)
- show vm, [14-72](#)
- show vmtemplate, [12-17](#), [12-20](#), [14-80](#)
- start, [14-51](#)
- start oda\_base, [14-51](#)
- start repo, [12-11](#), [14-52](#)
- start vm, [12-28](#), [14-74](#)
- stop, [14-52](#)
- stop repo, [12-12](#)
- stop vm, [12-28](#)
- stordiag, [14-53](#)
- test asr, [14-54](#)
- unpack, [14-55](#)
- update, [14-55](#)
- update-cpucore, [14-57](#)
- upgrade, [14-59](#)
- validate, [14-60](#)
- vdisk, [14-63](#)
- virtual machine, [14-66](#)
- vm template, [14-75](#)

oakcli deploy, [14-25](#)

## oakcli virtualization commands

- VLAN, [14-81](#)

Object Store, [11-9](#)

- credentials, [13-56](#), [13-59](#), [13-64](#), [13-69](#)

## ODA\_BASE

- caging, [12-44](#)
- definition, [12-3](#)
- domain, [12-44](#)

## odaadmcli commands

- expand storage, [13-127](#)
- hardware configuration, [13-121](#)
- hardware monitoring, [13-121](#)
- manage diagcollect, [13-105](#), [15-19](#)
- orachk, [13-43](#)
- power disk, [13-134](#)
- show controller, [13-131](#)

odaadmcli commands (*continued*)

- show cooling, [13-121](#)
- show disk, [13-128](#)
- show diskgroup, [13-130](#)
- show env\_hw, [13-122](#)
- show fs, [13-122](#)
- show memory, [13-123](#)
- show network, [13-124](#)
- show power, [13-125](#)
- show processor, [13-125](#)
- show raidsyncstatus, [13-132](#)
- show server, [13-126](#)
- show storage, [13-132](#)
- storage, [13-127](#)
- stordiag, [13-133](#)

## odacli commands

- appliance, [13-44](#)
- apply patch, [13-17](#)
- backup, [13-52](#)
- cleanup-patchrepo, [13-30](#)
- clone-database, [13-79](#)
- configure-asr, [13-113](#)
- configure-network, [13-12](#)
- CPU core, [13-71](#)
- create database, [9-12](#)
- create-appliance, [13-45](#)
- create-auto-logclean-policy, [13-111](#)
- create-backup, [13-54](#)
- create-backupconfig, [13-55](#)
- create-database, [13-75](#)
- create-dbhome, [13-89](#)
- create-dbstorage, [13-94](#)
- create-logcleanjob, [13-108](#)
- create-network, [13-11](#)
- create-objectstoreswift, [13-56](#)
- create-prepatchreport, [13-25](#)
- database, [13-73](#)
- database storage, [13-91](#)
- DBHome, [13-87](#)
- delete-asr, [13-118](#)
- delete-backup, [13-57](#)
- delete-backupconfig, [13-58](#)
- delete-database, [13-86](#)
- delete-dbhome, [13-90](#)
- delete-dbstorage, [13-95](#)
- delete-network, [13-14](#)
- delete-objectstoreswift, [13-59](#)
- delete-prepatchreport, [13-32](#)
- describe-appliance, [13-45](#)
- describe-asr, [13-116](#)
- describe-backupreport, [13-59](#)
- describe-component, [13-19](#)
- describe-cpucore, [13-72](#)
- describe-database, [13-74](#)
- describe-dbhome, [13-89](#)

- odacli commands (*continued*)
- describe-dbstorage, [13-92](#)
  - describe-dgstorage, [13-96](#)
  - describe-job, [13-103](#)
  - describe-latestpatch, [13-23](#)
  - describe-logcleanjob, [13-110](#)
  - describe-network, [13-10](#)
  - describe-networkinterface, [13-15](#)
  - describe-prepatchreport, [13-26](#)
  - describe-schedule, [13-61](#)
  - describe-system, [13-46](#)
  - irestore-database, [13-61](#)
  - jobs, [13-99](#)
  - list scheduler jobs, [13-103](#)
  - list-auto-logclean-policy, [13-112](#)
  - list-backupconfig, [13-64](#)
  - list-backupreports, [13-63](#)
  - list-cpucores, [13-71](#)
  - list-databases, [13-74](#)
  - list-dbhomes, [13-88](#)
  - list-dbstorages, [13-92](#)
  - list-featuretracking, [13-49](#)
  - list-jobs, [13-99](#)
  - list-logcleanjobs, [13-109](#)
  - list-logspaceusage, [13-107](#)
  - list-networkinterfaces, [13-16](#)
  - list-networks, [13-9](#)
  - list-osconfigurations, [13-119](#)
  - list-prepatchreports, [13-29](#)
  - list-scheduled-executions, [13-103](#)
  - list-schedules, [13-65](#)
  - modify-database, [13-80](#)
  - network, [13-7](#)
  - odacli create-appliance, [D-2](#), [D-7](#)
  - odacli list-agentconfig-parameters, [13-32](#)
  - odacli list-availablepatches, [13-31](#)
  - odacli list-dgstorages, [13-98](#)
  - odacli list-objectstoreswifts, [13-64](#)
  - odacli update-agentconfig-parameters, [13-34](#)
  - Oracle ASR, [13-113](#)
  - OS, [13-118](#)
  - recover-database, [13-65](#)
  - recovery, [13-52](#)
  - register-database, [13-82](#)
  - show -h
    - with Oracle Database Appliance Hardware Monitoring Tool, [15-12](#)
  - storage, [13-127](#)
  - test-asr, [13-117](#)
  - update, [13-17](#)
  - update database home, [13-35](#)
  - update repository, [13-40](#)
  - update-asr, [13-115](#)
  - update-backupconfig, [13-67](#)
  - update-cpucores, [13-72](#)
- odacli commands (*continued*)
- update-database, [13-68](#)
  - update-dcsadmin, [13-36](#)
  - update-dcsagent, [13-37](#)
  - update-dcscomponents, [13-37](#)
  - update-network, [13-13](#)
  - update-objectstoreswift, [13-69](#)
  - update-osconfigurations, [13-119](#)
  - update-registry, [13-38](#)
  - update-schedule, [13-70](#)
  - update-server, [13-41](#)
  - update-storage, [13-43](#)
  - upgrade-database, [13-84](#)
  - validate storage topology, [13-135](#)
  - validate-storagetopology, [13-135](#)
- odacli create-appliance
- example JSON files, [D-2](#), [D-7](#)
  - readme, [D-2](#)
- odacli-adm commands
- set-credential, [13-52](#)
- odaeraser.py, [8-5](#)
- odarepo1
- local repository, [12-16](#)
- odarepo2
- local repository, [12-16](#)
- OINSTALL group, [9-1](#)
- operating system users, [2-4](#)
- Optimal Flexible Architecture
- and Oracle homes, [B-1](#)
- Oracle ACFS, [12-4](#)
- display database storage information, [14-41](#)
- Oracle ACFS (Oracle Automatic Storage Management Cluster File System)
- shared repository, [12-4](#)
- Oracle Appliance Manager command-line interface
- alphabetical list of commands, [14-1](#)
  - help for, [14-3](#)
  - location of, [14-3](#)
  - uses for, [14-3](#)
- Oracle Appliance Manager command-line-interface
- operational notes, [14-3](#)
- Oracle Appliance Manager Configurator
- about, [23](#)
  - network validation errors, [23](#)
  - using, [23](#)
- Oracle ASM (Oracle Automatic Storage Management)
- add storage expansion shelf, [3-6](#)
  - data migration, [9-2](#)
  - physical disk identifier, [14-27](#)
  - trace file analyzer diagnostics, [15-8](#)
  - user group, [B-3](#)

Oracle ASM disk group  
 display details, [14-43](#)

Oracle ASR  
 commands, [13-113](#)  
 configure, [13-113](#)

Oracle ASR (Auto Service Request), [14-54](#)  
 configure, [14-9](#)  
 display configuration details, [14-37](#)  
 test asr, [14-54](#)

Oracle ASR (Oracle Auto Service Request)  
 configurator, [2-10](#)

Oracle Automatic Storage Management  
 See Oracle ASM

Oracle Cloud File System  
 configurator, [2-10](#)

Oracle Database  
 See database

Oracle Database Appliance Hardware Monitoring  
 Tool, [15-12](#)

Oracle Database Appliance Manager  
 software inventory, [1-3](#)

Oracle Database Appliance Virtualized Platform  
 and oakcli, [14-3](#)

Oracle Database Enterprise Edition  
 overview, [2-2](#)

Oracle Database Resource Manager  
 instance caging, [9-19](#)

Oracle Enterprise Manager Database Express,  
[9-20](#)

Oracle home  
 multiple, [9-12](#)

Oracle ILOM (Oracle Integrated Lights Out  
 Manager)  
 configurator, [2-10](#)  
 configure, [3-14](#)

Oracle Integrated Lights Out Manager  
 See Oracle ILOM

Oracle Ksplice, [19](#)

Oracle ORAchk Health Check Tool, [15-6](#)

Oracle RAC (Oracle Real Application Clusters),  
[2-2](#)  
 deployment option, [2-2](#)  
 trace file analyzer, [15-8](#)  
 See also Oracle RAC One Node

Oracle RAC One Node, [2-2](#), [24](#)  
 deployment option, [2-2](#)

Oracle Real Application Clusters  
 See Oracle RAC

Oracle Support Services  
 See My Oracle Support

Oracle user, [9-1](#)

Oracle VM, [12-2](#)

OS configuration  
 current, [13-119](#)  
 suggested, [13-119](#)

OSASM group, [9-1](#)

OSDBA, [9-1](#)  
 OSDBA for ASM group, [9-1](#)  
 OSDBA group, [9-1](#)  
 OSOPER groups, [9-1](#)  
 over-subscribed CPU pool, [12-45](#)

## P

---

patches  
 software inventory, [1-3](#)

patching, [20](#)  
 appliance, [5](#)  
 using web console, [11](#), [14](#)

patching Oracle Database Appliance, [8](#), [13](#), [15](#)

patching Virtualized Platform, [15](#)

performance tuning, [12-45](#), [12-46](#)

physical disk  
 LED identifier, [14-27](#)

plumb network, [4-1](#)

power cords  
 connecting, [3-11](#)

power supply  
 display details, [14-45](#)

proxy setting, [11-9](#)

public network interface, defining, [3-13](#)

## R

---

raidsyncstatus  
 display, [14-47](#)

readme, [D-2](#)

recover database, [11-19](#)

recovering database, [11-13](#)

redundancy level  
 disk group  
 configurator, [2-10](#)

reimage appliance, [8-3](#)

reimaging, [14](#)  
 virtualized platform, [14](#)

resource management  
 CPU pools, [12-45](#)  
 Oracle VM, [12-2](#)  
 supported virtual operating systems, [12-2](#)

restore baremetal system, [8-3](#)

restore database, [11-21](#)

RMAN (Recovery Manager utility)  
 database management, [9-2](#)

RPM drift, [15-2](#)

## S

---

SAP Application, [24](#)

SAP user and group configuration, [2-4](#)

SAS expander  
 display details, [14-44](#)

save configuration, [D-1](#)

SCAN (single client access name), [2-7](#)  
 no NIS support, [2-7](#)

scheduler  
 jobs, [13-103](#)

Scheduling Database Backups, [11-18](#)

secure erase tool, [8-5](#)  
 odaeraser.py, [8-5](#)

sending log files to Oracle Support Services,  
[15-19](#)

server  
 display details, [14-48](#)

setupX4network.pl, [3-13](#)

shape  
 database  
 select, [2-3](#)

shared repositories  
 about, [12-4](#)  
 architecture, [12-4](#)

shared repository  
 creating and managing, [12-10](#)  
 delete, [14-24](#)  
 deleting, [12-12](#)  
 increasing the size, [12-13](#)  
 show status, [12-11](#)  
 starting, [12-11](#)  
 stopping, [12-12](#)

SI (Support Identifier)  
 add to profile, [2-1](#)  
 register, [2-1](#)

software  
 license registration, [2-1](#)

Solaris x86  
 and virtualization, [12-2](#)

space management, [8, 9](#)

SQL\*Loader, [9-2](#)

static listener, configure, [9-15](#)

storage, [10-1](#)  
 show enclosure subsystem, [14-43](#)

storage expansion  
 command, [14-26](#)

storage expansion shelf  
 adding, [3-6](#)

storage planning, [2-7](#)

support identifier  
 See SI

system requirements  
 checklist, [2-6](#)

## T

---

template  
 database  
 choosing, [E-1](#)  
 select, [2-3](#)  
 virtual machine  
 automatic unique naming, [12-16](#)  
 unique name for each node, [12-16](#)

templates, [E-1](#)

TFA command, [15-9](#)

TFA options, [15-9](#)

Trace File Analyzer (TFA) Collector, [15-9](#)

Trace File Analyzer utility, [15-8](#)

troubleshooting, [15-5](#)  
 expander, [14-44](#)  
 hrd disk diagnostic tool, [15-8](#)  
 log files for Oracle Support Services, [15-19](#)  
 network validation, [23](#)  
 trace file analyzer, [15-8](#)

turning on Oracle Database Appliance, [3-11](#)

## U

---

uninstall, [8-1](#)

update pre-checks, [8](#)

update rpms, [20](#)

upgrade  
 database, [24](#)

user role separation, [2-4](#)

## V

---

validation errors  
 display, [14-49](#)  
 names and addresses on the DNS, [23](#)

validation failures  
 display, [14-49](#)

vdisk  
 CLI commands, [14-63](#)

viewing backup reports, [11-13](#)

virtual disk  
 attaching to a virtual machine, [12-15](#)  
 cloning, [12-14](#)  
 create, [14-63](#)  
 creating, [12-13](#)  
 delete, [14-64](#)  
 deleting, [12-15](#)  
 display details, [14-65](#)  
 viewing information about, [12-14](#)

virtual disks, [12-4](#)

virtual IP address (virtual Internet Protocol  
 address)  
 subnet, [2-7](#)

virtual local area network, [12-7](#)

- virtual machine
  - about, [12-4](#), [12-31](#)
  - assemblies, [12-4](#)
  - caging, [12-44](#)
  - CLI commands, [14-66](#)
  - display repository details, [14-47](#)
  - high availability, [12-43](#)
  - ODA\_BASE caging, [12-44](#)
  - open console, [14-74](#)
  - pin, [12-44](#)
  - template, [12-16](#)
  - templates, [12-4](#), [12-31](#)
- virtual machine templates
  - importing, [12-18](#)
  - listing, [12-17](#)
- virtualization, [14](#), [12-2](#)
- VLAN
  - CLI commands, [14-81](#)

- VLAN (*continued*)
  - display details, [14-83](#)
- vm templates
  - CLI commands, [14-75](#)
  - display details, [14-80](#)

## W

---

- web console, [D-1](#)
- Web Console
  - about, [1-5](#)
  - actions, [1-5](#)
- web interface
  - Oracle Enterprise Manager Database Express, [9-20](#)
- Windows
  - and virtualization, [12-2](#)